

GROUPS GENERATED BY BOUNDED AUTOMATA
AND THEIR SCHREIER GRAPHS

A Dissertation

by

IEVGEN BONDARENKO

Submitted to the Office of Graduate Studies of
Texas A&M University
in partial fulfillment of the requirements for the degree of

DOCTOR OF PHILOSOPHY

December 2007

Major Subject: Mathematics

GROUPS GENERATED BY BOUNDED AUTOMATA
AND THEIR SCHREIER GRAPHS

A Dissertation

by

IEVGEN BONDARENKO

Submitted to the Office of Graduate Studies of
Texas A&M University
in partial fulfillment of the requirements for the degree of

DOCTOR OF PHILOSOPHY

Approved by:

Chair of Committee,	Rostislav Grigorchuk
Committee Members,	Sergiy Butenko
	Volodymyr Nekrashevyh
	Zoran Sunik
Head of Department,	Al Boggess

December 2007

Major Subject: Mathematics

ABSTRACT

Groups Generated by Bounded Automata
and Their Schreier Graphs. (December 2007)

Ievgen Bondarenko, B.S., National Taras Shevchenko University of Kyiv, Ukraine;

M.S., National Taras Shevchenko University of Kyiv, Ukraine

Chair of Advisory Committee: Dr. Rostislav Grigorchuk

This dissertation is devoted to groups generated by bounded automata and geometric objects related to these groups (limit spaces, Schreier graphs, etc.).

It is shown that groups generated by bounded automata are contracting. We introduce the notion of a post-critical set of a finite automaton and prove that the limit space of a contracting self-similar group generated by a finite automaton is post-critically finite (finitely-ramified) if and only if the automaton is bounded.

We show that the Schreier graphs on levels of automaton groups can be constructed by an iterative procedure of inflation of graphs. This was used to associate a piecewise linear map of the form $f_{\mathcal{K}}(v) = \min_{A \in \mathcal{K}} Av$, where \mathcal{K} is a finite set of nonnegative matrices, with every bounded automaton. We give an effective criterium for the existence of a strictly positive eigenvector of $f_{\mathcal{K}}$. The existence of nonnegative generalized eigenvectors of $f_{\mathcal{K}}$ is proved and used to give an algorithmic way for finding the exponents λ_{\max} and λ_{\min} of the maximal and minimal growth of the components of $f_{\mathcal{K}}^{(n)}(v)$. We prove that the growth exponent of diameters of the Schreier graphs is equal to λ_{\max} and the orbital contracting coefficient of the group is equal to $\frac{1}{\lambda_{\min}}$. We prove that the simple random walks on orbital Schreier graphs are recurrent.

A number of examples are presented to illustrate the developed methods with special attention to iterated monodromy groups of quadratic polynomials. We present the first example of a group whose coefficients λ_{\min} and λ_{\max} have different values.

To my dear wife for her love and support

ACKNOWLEDGMENTS

I would like to express my sincere gratitude to my advisor, Prof. Rostislav Grigorchuk, for his invaluable guidance, constant encouragement and support during my graduate studies. I am very honored and appreciate to have him as advisor.

I thank the other members of my advisory committee, Dr. Sergiy Butenko, Dr. Volodymyr Nekrashevych, Dr. Zoran Sunik and Dr. Yaroslav Vorobets, for their valuable suggestions and editorial advices. Especially I would like to thank Dr. Volodymyr Nekrashevych, who introduced me to the magnificent subject of automaton groups. His guidance, helpful suggestions and collaboration were extremely important for my research.

I also use this opportunity to thank my fellow graduate students and friends, Dmytro Savchuk, Yevgen Muntyan, Rostyslav Kravchenko, Svyatoslav Trukhanov. Living these years away from home would have been much harder without them.

Finally, I would like to thank my wife for her love, patience and support.

TABLE OF CONTENTS

CHAPTER		Page
I	INTRODUCTION	1
	1 The Perron-Frobenius theory for piecewise linear maps . .	3
	2 Automata and self-similar groups	6
	3 Post-critically finite self-similar sets	10
	4 Schreier graphs	12
II	AUTOMATA AND SELF-SIMILAR GROUPS	15
	1 Spaces of words	15
	2 Graphs and trees	16
	3 Automorphisms of rooted trees	20
	4 Automata	23
	5 Self-similar groups	26
	6 Schreier graphs	29
	7 Limit spaces of self-similar groups	36
III	DYNAMICS OF PIECEWISE LINEAR MAPS	41
	1 Nonnegative matrices	41
	1.1 Perron-Frobenius Theorem and its generalizations . .	42
	1.2 Block-triangular structure of nonnegative matrices . .	44
	1.3 Generalized eigenvectors and algebraic eigenspaces . .	49
	1.4 Iterations of nonnegative matrices	50
	2 Product property of a set of nonnegative matrices	54
	3 \succcurlyeq -minimal matrices and principal \succcurlyeq -minimal partition . .	56
	4 Existence of strictly positive eigenvector of $f_{\mathcal{K}}$	60
	5 Generalized Howard's policy iteration procedure	65
	6 Generalized eigenvectors of $f_{\mathcal{K}}$	69
	7 Asymptotic behavior of iterations of $f_{\mathcal{K}}$	72
IV	GROUPS GENERATED BY BOUNDED AUTOMATA	74
	1 Bounded and polynomial automata	74
	1.1 Definition and basic properties	74
	1.2 Structure of bounded and polynomial automata	77
	2 Contraction of groups generated by bounded automata . .	81

CHAPTER	Page
3	Post-critical sets 85
4	Limit spaces of groups generated by bounded automata . . 89
V	SCHREIER GRAPHS OF GROUPS GENERATED BY BOUNDED AUTOMATA 93
1	Inflation of graphs 93
1.1	Definition and basic properties 94
1.2	Inflation distance map 97
1.3	Diameters of inflated graphs 103
2	Structure of Schreier graphs and tile graphs 105
2.1	Connectedness of tile graphs 107
2.2	Tile graphs as inflated graphs 109
3	Growth of diameters of Schreier graphs Γ_n 111
4	Orbital contracting coefficient of bounded automaton groups 113
4.1	Decomposition of geodesics in tile graphs 114
4.2	Asymptotic behavior of distances 117
4.3	The proof of the main theorem 121
5	Metrics on post-critically finite limit spaces 125
6	Random walks on Schreier graphs 126
VI	EXAMPLES AND APPLICATIONS 129
1	Adding machine 129
2	Iterated monodromy groups of quadratic polynomials . . . 130
2.1	$\text{IMG}(z^2 + i)$ 130
2.2	Basilica group 132
2.3	Groups $\mathfrak{K}(\nu, \omega)$ 134
2.4	Group $\mathfrak{K}(101, 100)$ 137
3	Gupta-Sidki group 138
VII	CONCLUSIONS, PROBLEMS AND CONJECTURES 140
	REFERENCES 145
	VITA 154

LIST OF FIGURES

FIGURE	Page
1	Binary tree 19
2	The automata generating the Grigorchuk group (on the left) and the Gupta-Fabrikovsky group (on the right) 25
3	The Schreier graphs $\Gamma_1, \Gamma_2, \Gamma_3$ of the Grigorchuk group drawn on the tree 38
4	The limit space of the Gupta-Fabrikovsky group 39
5	General form of connected components of bounded automata 78
6	One of the smallest polynomial and not bounded automata 84
7	Dual Sierpinski graphs 96
8	A path in an inflated graph 98
9	Construction of inflation distance map for dual Sierpinski graphs . . . 102
10	The adding machine and the associated inflation data 130
11	The $\text{IMG}(z^2 + i)$ and the associated inflation data 131
12	The Schreier graph Γ_6 of $\text{IMG}(z^2 + i)$ and the Julia set of $z^2 + i$. . . 131
13	The Basilica group and the associated inflation data 133
14	The Schreier graph Γ_6 of the Basilica group and the Julia set of $z^2 - 1$ 134
15	The automaton generating the group $\mathfrak{R}(010, 011)$ 137
16	The Gupta-Sidki group and the associated inflation data 139

CHAPTER I

INTRODUCTION

Automata are basic abstract mathematical models of sequential machines, which naturally appear in solving various practical problems. Different types of automata (recognition automata, Turing, Moore, and Mealy machines, cellular and pushdown automata) were developed in connections to computability, computational complexity, formal languages, etc. This dissertation deals with Mealy automata, which are finite state transducers that generate an output based on their current state and an input.

Groups generated by automata (or just automaton groups — not to be confused with automatic groups) were introduced and studied by V.M. Glushkov and his students in the 1960s and now begin to play important role in different areas of mathematics (algebra, dynamical systems, conformal dynamics, fractal geometry, combinatorics, etc). Different languages (self-similar groups, groups of automorphisms of regular rooted trees, state-closed groups, tableau representations of L.A. Kaloujnine) dealing with these groups were developed.

The key feature of automaton groups is the self-similarity of their canonical action on the space of finite words over the alphabet. Since the self-similar objects in geometry (fractals) are too irregular to be described using the language of classical Euclidean geometry, it is not surprising that the automaton groups possess properties not typical for the traditional group theory. In particular, the class of automaton groups contains infinite periodic finitely generated groups, groups of intermediate growth, groups with non-uniform exponential growth, just-infinite groups, groups of finite width, essentially new amenable groups.

The journal model is *Groups, Geometry, and Dynamics*.

The fundamental problem of the theory of automaton groups is the connection between the structure of an automaton and the properties of the group it generates. Considering the cyclic structure of automata, Said Sidki [Sid00] introduced various classes of finite automata and, in particular, bounded automata. Their structure can be described explicitly, which allows one to deal fairly easily with all bounded automata. At the same time, the class of groups generated by these automata is sufficiently large and moreover contains most of the studied automaton groups.

Groups generated by automata are connected with classical self-similar sets via the notion of a limit space and with dynamical systems via iterated monodromy groups developed by V.V. Nekrashevych [Nek05]. The Schreier coset graphs of an automaton group with respect to the stabilizers of finite words (graphs of group actions) converge in some natural way to the limit space. This makes it possible to use Schreier graphs in the study of topology and geometry of limit spaces, and hence Julia sets of sub-hyperbolic rational functions in case of iterated monodromy groups. At the same time, many interesting constructions of graphs (substitutional, vertex-substitutional, self-similar) that converge to self-similar sets were developed in fractal geometry. Asymptotic properties of these graphs (volume growth, growth dimension, transition probabilities of random walks, etc.) are extensively studied and it is interesting to understand their relations to Schreier graphs of automaton groups.

Another important topic which is related to this dissertation is the analysis on fractals. Motivated by physics literature, different methods were developed in construction of harmonic analysis and Brownian motion on fractals. Unfortunately, the construction of a “Laplacian” was possible mainly on the fractals which can be made disconnected by removing finitely many points (finitely-ramified fractals, nested fractals, post-critically finite self-similar sets). A natural question is to describe automaton groups whose limit spaces satisfy this property.

1 The Perron-Frobenius theory for piecewise linear maps

In Chapter III we study spectral properties and iterations of piecewise linear maps of the form

$$f_{\mathcal{K}}(v) = \min_{A \in \mathcal{K}} Av, \quad v \in \mathbb{R}^N, \quad (1.1)$$

where \mathcal{K} is a finite set of nonnegative square matrices of fixed dimension and by “min” we mean component-wise minimum. The study of such maps stands separately from the rest of the contents (the chapter is self-contained) and may look unrelated to the primary topics of the dissertation. However, it is essential in the study of asymptotic properties of the Schreier graphs of groups generated by bounded automata and namely the connection with automata theory established in Chapter V is our motivation for the study of these maps.

At the same time, the maps $f_{\mathcal{K}}$ appear in many different contexts and the study of such maps can be viewed as a generalization of the Perron-Frobenius theory of nonnegative matrices. In the last hundred years this theory has been very well developed and now plays an important role in different areas of mathematics, including numerous applications to dynamic programming, probability theory, numerical analysis, mathematical economics, etc. (see monographs [Bel57a, BR97, BP94, Gan59, How60, ST02, Sen73, Var00] and their references).

The classical Perron-Frobenius theorem shows that a nonnegative matrix has a nonnegative eigenvector associated with its spectral radius, and if the matrix is irreducible then the corresponding eigenvector is strictly positive. One important generalization of this result was obtained by U.G. Rothblum [Rot75], who studied the structure of the algebraic eigenspaces of nonnegative matrices and described the combinatorics that stands behind the index of the spectral radius and dimensions of the algebraic eigenspaces. Moreover, it was shown that a nonnegative matrix has

some nonnegative generalized eigenvectors with certain strictly positive entries. One of our main tasks in Chapter III is to extend this result to maps $f_{\mathcal{K}}$ and then use it in the study of iterations $f_{\mathcal{K}}^n(v)$ for a strictly positive vector v .

Also consider the map $g_{\mathcal{K}}$, which is similar to $f_{\mathcal{K}}$, but with “maximum” instead of “minimum”

$$g_{\mathcal{K}}(v) = \max_{A \in \mathcal{K}} Av, \quad v \in \mathbb{R}^N. \quad (1.2)$$

The maps of the form (1.1) and (1.2) appear naturally in the probability theory and economics with connections to Markov decision processes (with additive cost and reward structures) and branching Markov decision processes (see [How60, RW82, Pli77, SF79, Bel57b]), dynamical programming (see [Bel57a, Bel55b, MS69]), etc. Let us consider one such example.

Markov decision processes. Consider a system \mathcal{S} with a finite set of states $\{1, 2, \dots, N\}$. At each discrete time $n = 1, 2, \dots$ the system is in one of its states and for each state i we have a finite set \mathcal{K}_i of possible actions over the system \mathcal{S} (or we just have a finite set of actions over the system independently of the state). Assume that if the system is in state i and we apply an action $a \in \mathcal{K}_i$ then the system changes its state and the probability that this new state is j is equal to a_{ij} independently of the history (independently of time n). The process of this type is called a *Markov decision process*. Let $v_i(n)$ be the probability that the system is in state i at time n . Now at each stage of the process we may ask the problem of finding the actions that minimize (or maximize) the probability of finding the system in some state. This leads to the following recurrence

$$v_i(n+1) = \min_{a \in \mathcal{K}_i} \sum_{j=1}^N a_{ij} v_j(n),$$

which is the particular case of the iterations of a map $f_{\mathcal{K}}$, where \mathcal{K} is a finite set of

stochastic matrices. If we additionally consider the situation when we need to pay price $p_i(a)$ for every chosen action $a \in \mathcal{K}_i$ (Markov decision process with additive cost structure), then to minimize the cost of the process we need to consider recurrence

$$v_i(n+1) = \min_{a \in \mathcal{K}_i} \left\{ p_i(a) + \sum_{j=1}^N a_{ij} v_j(n) \right\},$$

which can be reduced to the iterations of a map $f_{\mathcal{K}}$ by introducing a new variable.

A continuous analogue of equations (1.1) and (1.2) can be written in the form

$$\frac{dv(t)}{dt} = \min_{A \in \mathcal{K}} Av(t), \quad \frac{dv(t)}{dt} = \max_{A \in \mathcal{K}} Av(t),$$

and constitute a natural generalization of linear differential systems. Hence they play important role in different areas of mathematics, apart from their probabilistic applications. For example, the Riccati equation can be written in this form [Bel55a].

The theory of maps $f_{\mathcal{K}}$ and $g_{\mathcal{K}}$ can be considered as a part of a more general theory of homogeneous monotone functions, which classically arise in game theory, nonlinear potential theory, optimal control, etc. The fundamental problem in this theory is the existence and uniqueness (up to a scalar multiple) of a strictly positive eigenvector. There are many sufficient conditions (see [GG04] for one strong result in this direction), which pretend on the notion “irreducibility” of such maps, however an effective criterium is unknown.

The study of maps $g_{\mathcal{K}}$ was initiated by Richard Bellman. Using the Brouwer fixed point theorem he proved the existence of a strictly positive eigenvector for the map $g_{\mathcal{K}}$ in the case when each matrix in \mathcal{K} is positive and studied the asymptotic behavior of iterations $g_{\mathcal{K}}^n(v)$ for a nonnegative vector v (see [Bel56] and [Bel57a, Chapter XI]). He also studied the asymptotic behavior of $g_{\mathcal{K}}^n(v)$ and $f_{\mathcal{K}}^n(v)$ in the special case when \mathcal{K} contains only (transposed) positive Markov matrices [Bel57b].

These results were generalized to a (possibly infinite) set of irreducible matrices by P. Mandl and E. Seneta [MS69].

The most important results for our investigation were obtained by W.H.M. Zijm in [Zij84]. He considered the maps $g_{\mathcal{K}}$ and showed that there is a simultaneous block-triangular decomposition of the set of matrices \mathcal{K} , which was used to give the necessary and sufficient condition for the existence of a strictly positive eigenvector of $g_{\mathcal{K}}$ and extend the above mentioned result of U.G. Rothblum on nonnegative generalized eigenvectors to $g_{\mathcal{K}}$. Independently, Karel Sladký [Sla80, Sla81] obtained the same block-triangular decomposition and used it to get bounds on the asymptotic behavior of iterations $g_{\mathcal{K}}^n(v)$ for a nonnegative vector v . Stronger results about asymptotic behavior of iterations $g_{\mathcal{K}}^n(v)$ were obtained in [Sla81, Sla86, Zij87] for the case when some special matrices in \mathcal{K} are aperiodic.

Considering maps $f_{\mathcal{K}}$ we follow as close as possible to the ideas of W.H.M. Zijm and use his paper [Zij84] as a model. Notice that we cannot use Zijm's results for $-f_{\mathcal{K}}$, which can be expressed using maximum, because matrices should be nonnegative and the dynamics is considered in the nonnegative cone. The problem in transferring the results obtained for $g_{\mathcal{K}}$ to $f_{\mathcal{K}}$ lies in the convexity property which $f_{\mathcal{K}}$ lacks. In particular, there is no simultaneous block-triangular decomposition, which was extremely important in [Zij84, Sla80, Sla81].

Finally, the appearance of maps $f_{\mathcal{K}}$ in automata theory established in Chapter V is closely related to the results of J. Kigami [Kig95], where maps $f_{\mathcal{K}}$ appear during the construction of metrics on some post-critically finite self-similar sets.

2 Automata and self-similar groups

Consider Mealy automata with the same input and output alphabet X . Each state q of such an automaton \mathcal{A} defines a natural transformation \mathcal{A}_q of the set X^* of finite

words over the alphabet X . In general, the transformations defined by all the states of the automaton generate a semigroup, but if they are invertible, we can talk about the automaton group. In this way the automaton semigroups and groups were defined on the seminar organized by V.M. Glushkov at National Taras Shevchenko University of Kyiv [Glu61].

Another approach is to consider the set X^* as a regular rooted tree and invertible transformations \mathcal{A}_q as automorphisms of this tree. The full group of automorphisms of a rooted tree can be described in terms of iterated wreath products developed by L. Kaloujnin and P. Hall. This led to a special “tableau” representation of automorphisms, which was successfully applied by V.I. Sushchansky and his students in the study of algebraic properties of different groups of automorphisms of a regular rooted tree.

In his original paper, V.M. Glushkov conjectured that automaton groups may have relation to the Burnside Problems [Glu61, page 46]. This was confirmed by S.V. Aleshin [Ale72], who constructed automata which generate infinite periodic finitely generated groups providing counter-examples to the General Burnside Problem, originally solved by Golod and Shafarevich in 1964. Later V.I. Sushchansky [Sus79] constructed infinite two-generated p -groups for every prime $p > 2$ using the language of tableaux. Other constructions were produced by R.I. Grigorchuk [Gri80] considering measure-preserving transformations of a unit interval and by N.D. Gupta and S. Sidki [GS83b, GS83a] considering automorphisms of a regular rooted tree. Although these constructions do not provide the first counter-examples, they are perhaps the simplest ones.

The full strength of automaton groups was evinced when R.I. Grigorchuk proved that his group has intermediate growth between polynomial and exponential [Gri83], providing the answer to the Milnor Problem on growth. At the same time, it solves

the Day Problem on amenability providing an example of an amenable group that is not elementary amenable. The appearance of automaton groups in the study of growth and amenability was not accidental, and it was shown later that the Aleshyn and Sushchansky groups also have intermediate growth [Mer83, Gri85, BS06].

The study of the lattice of subnormal subgroups of automaton groups lead to the notion of branch groups introduced by R.I. Grigorchuk. The branch groups constitute one of the three important classes of groups on which splits the study of finitely generated just-infinite groups [Gri00].

A fundamental connection between automaton groups and classical dynamical systems was established by V.V. Nekrashevych [Nek05]. With (branched) self-coverings of topological spaces are naturally associated their iterated monodromy groups, which are generated by automata and retain the most essential information about the dynamical systems. The methods of automaton groups were used to solve well-known in conformal dynamics Hubbard Problem [BN06a].

Consider the following important property of automaton groups which reflects the self-similarity of the tree X^* . For every automorphism g of the tree X^* and a word $v \in X^*$ define the transformation $g|_v$, called the restriction of g , by the rule

$$g|_v(x) = y \quad \text{if and only if} \quad g(vx) = g(v)y$$

for all $x, y \in X^*$ of equal length $|x| = |y|$. Then a restriction of the transformation given by an automaton is again given by some state of this automaton. This property lies in the foundation of the notion of self-similar group action.

One important class of automaton groups is the class of contracting self-similar groups, which have nice algorithmic and geometric properties. Contraction of a group means that the lengths of its elements become shorter when we take restrictions. Namely the strong contracting properties of the Grigorchuk group were used to prove

that it has intermediate growth and as for today it is essentially the only known method to get upper estimates on the growth function of a group. A large class of contracting self-similar groups is represented by iterated monodromy groups of expanding dynamical systems. The contracting properties of a self-similar group are characterized by the contracting coefficient, which is important when we deal with different algorithmic problems around these groups.

The main topic of this dissertation is the class of groups generated by bounded automata. Recall the original definition of S. Sidki [Sid00]. An automorphism g of the tree X^* given by a finite automaton is called bounded, if the sequence

$$\theta_k(g) = \left| \{v \in X^k \mid \text{the restriction } g|_v \text{ acts non-trivially on } X\} \right|$$

is bounded. A finite automaton is called bounded if all its states define bounded automorphisms. The set of all bounded automorphisms forms a group called the group of bounded automata. When the sequence $\theta_k(g)$ is bounded by a polynomial we get polynomial automorphisms and polynomial automata. These notions can be characterized in terms of the cardinality of (right- or left-) infinite paths in the Moore diagram of automata without the trivial state.

It is interesting that most of the studied automaton groups (in particular, all the above mentioned examples) are subgroups of the group of bounded automata. Also every finitely automatic GGS-group [BGŠ03], AT-group [Mer83] or spinal group [BŠ01] is generated by bounded automorphisms. All known examples of groups of intermediate growth are either generated by bounded automata or are constructed from such groups. Also the iterated monodromy groups of polynomials are subgroups of the group of bounded automata [Nek05, Theorem 6.10.8].

The first important result about polynomial automaton groups was obtained by S. Sidki, who proved that they do not contain free non-abelian subgroups [Sid04].

Studying the random walks on groups generated by bounded automata L. Bartholdi, V. Kaimanovich, V.V. Nekrashevych and B. Virag [BKNV06] proved that these groups are amenable. The last result led to the first example [BV05] of an amenable group, which is not sub-exponentially amenable [Gri98, GHC99].

In Chapter IV we show that groups generated by bounded automata are contracting, which allows us to consider different geometric objects and contracting coefficients associated with these groups.

3 Post-critically finite self-similar sets

The first examples of fractals were constructed at the beginning of the twentieth century as interesting counter-examples in topology and measure theory. For example, the middle third Cantor set provides an example of an uncountable perfect set with zero Lebesgue measure, the Koch curve is an example of a compact curve of infinite length. However, the first notion of a fractal was introduced only in the 70s by B. Mandelbrot. After that the theory of fractals begin to develop rapidly.

Although fractals were constructed as pure mathematical objects, they have found their places in different practical applications. It was discovered that some natural phenomena (like coastlines, clouds, mountains, etc.) should be simulated by objects having fractal appearance rather than smooth. The natural question arises to describe the physical processes (like heat diffusion, vibration, etc.) on fractals like the classical analysis does it for the smooth objects. Since fractals do not possess any smooth structure, it is not possible to define differential operators from the classical point of view. That is the goal of a rather new branch of fractal geometry — analysis on fractals.

The first step in this development was construction of Brownian motion on the Sierpinski gasket. It was noticed that an important role is played by the property

that a fractal can be made disconnected by removing finitely many points. Then T. Lindstrøm [Lin90] extended the construction of Brownian motion to nested fractals, which are finitely ramified fractals with strong symmetry. Using a different approach J. Kigami [Kig89] introduced a construction of the Laplacian and described the structure of harmonic functions, Green's functions, Dirichlet forms on the Sierpinski gasket. These constructions were extended to post-critically finite self-similar sets [Kig01], which are almost the only fractals on which the analysis is developed.

Self-similar sets are usually defined as attractors of iterated functional systems. If $\{f_x, x \in X\}$ is such a system, then the corresponding self-similar set K is defined as the compact set satisfying the equation

$$K = \bigcup_{x \in X} f_x(K).$$

The self-similar set K defined in this way admits a canonical self-similar structure defined as follows [Kig01, Section 1.3]. There exists a continuous surjective map $\pi : X^\omega \rightarrow K$, which makes the following diagram commutative:

$$\begin{array}{ccc} X^\omega & \xrightarrow{\sigma_x} & X^\omega \\ \downarrow \pi & & \downarrow \pi \\ K & \xrightarrow{f_x} & K \end{array}$$

for every $x \in X$, where $\sigma_x : X^\omega \rightarrow X^\omega$ is defined by $\sigma_x(x_1x_2\dots) = xx_1x_2\dots$. The critical set \mathcal{C} of K is defined as the pre-image of the set $\bigcup_{x,y \in X, x \neq y} (f_x(K) \cap f_y(K))$ under the map π and the post-critical set is $\mathcal{P} = \bigcup_{n \geq 1} \sigma^n(\mathcal{C})$, where σ is the shift on the space of sequences X^ω . A self-similar set is called post-critically finite if its post-critical set \mathcal{P} is finite.

Contracting automaton groups are connected with fractal geometry through their limit spaces [Nek05, Chapter 3]. Limit space is defined as a quotient of the space $X^{-\omega}$ of left-infinite sequences over the alphabet X by an equivalence relation that can be

described using the Moore diagram of the generating automaton. In Chapter IV we define the post-critical set of a finite automaton as the set of all left-infinite sequences over the alphabet X , which are read along left-infinite paths in the Moore diagram of the automaton ending in a non-trivial state. We prove that the post-critical set of a finite automaton is finite if and only if the automaton is bounded. We adopt the notions of post-critically finite self-similar set and finitely ramified self-similar set to limit spaces of automaton groups. The main result proves that the limit space of a contracting group generated by a finite automaton is post-critically finite (finitely ramified) if and only if this automaton is bounded.

4 Schreier graphs

Let G be a group generated by a finite system of generators S . The Schreier graph of the action of the group G on a set M is the directed graph with the set of vertices M and the set of edges $M \times S$, where for every $m \in M$ and $s \in S$ there is an edge from m to $s(m)$. Schreier graphs are generalization of Cayley graphs, which correspond to the action of the group on itself by left (or right) multiplication.

The action of a finitely generated group G on a rooted tree X^* naturally defines the sequence of finite Schreier graphs Γ_n of the action (G, X^n) and uncountable family of orbital Schreier graphs Γ_ω of the action of G on the G -orbit of the point ω on the boundary of X^* . The study of the Schreier graphs Γ_n and Γ_ω was initiated by L. Bartholdi and R.I. Grigorchuk [BG00a], who computed the spectra and growth of these graphs for a few interesting examples of automaton groups. It happened that these Schreier graphs have interesting spectral properties. In particular, the first examples of regular graphs for which spectrum is a Cantor set were constructed as Schreier graphs of automaton groups. The realization of the lamplighter group as automaton group allowed to prove that it has a pure point spectrum [GŻ01] and

this discovery led to the construction of a 7-dimensional closed manifold with non-integer third L^2 -Betti number, which was the first counter-example to the Strong Atiyah Conjecture. Also the orbital Schreier graphs were used by V.V. Nekrashevych and R.I. Grigorchuk [GN05] to construct amenable actions of non-amenable groups. Correlation between growth, growth of diameters, and the rate of vanishing of the spectral gap in Schreier graphs was studied by R.I. Grigorchuk and Z. Sunik [GŠ06], who constructed automaton groups whose Schreier graphs model the well-known Hanoi Towers game.

The Schreier graphs Γ_n can be used to approximate the limit spaces of contracting self-similar groups. The most natural way to see this was introduced by V.V. Nekrashevych [Nek03]. Take the tree X^* and draw the Schreier graphs Γ_n on the levels of this tree. If the group is contracting then the obtained graph is Gromov-hyperbolic and its boundary is homeomorphic to the limit space of the group. It is well-known that geodesics in a hyperbolic space diverge exponentially. The lowest possible exponent of divergence is characterized by the orbital contracting coefficient of the group. We show how this coefficient can be effectively computed for the case of bounded automata, partially answering to the questions of V.V. Nekrashevych.

It was noticed in [BG00a] that the Schreier graphs Γ_n of some automaton groups can be constructed iteratively by graph substitution. Substitutional graphs were introduced in the 70s to model the growth of plants and multicellular organisms. Using simple rules of replacement of certain subgraphs by bigger graphs, one simple graph can be transformed into graph with very complex structure and non-trivial growth. In [Gro84] M. Gromov noted that substitutional graphs are similar to L -systems introduced by A. Lindenmayer in 1968. These systems have important applications to data and image compression.

In [Pre98] J.P. Previte considered a different notion of graph substitution. In

his construction the vertices of a graph are replaced by some finite graphs. By iterating this vertex-substitution procedure we get a sequence of graphs. If they are normalized to have diameter one, the sequence can converge in the Gromov-Hausdorff metric. J.P. Preville gives necessary and sufficient conditions for this convergence and determines the Hausdorff dimension of the limit space. M. Preville, S.H. Yang, and M. Vanderschoot [PV03, PY06] show that limit spaces obtained in this way have topological dimension one, which makes them similar to the limit spaces of bounded automaton groups.

The picture will not be complete if we forget to mention self-similar graphs introduced by B. Krön. These infinite graphs can be considered as discrete analogs of self-similar sets. The random walks on self-similar graphs and, in particular, their Green functions and spectra of Markov operators are studied in [Krö02, KT04]. The homogeneous self-similar graphs with bounded geometry have polynomial growth. The degree of this growth was calculated in [Krö04].

However, usually the Schreier graphs of automaton groups are neither self-similar nor substitutional in the above senses. We develop a construction of inflation of graphs, which is a graph-theoretical analog of tile diagrams introduced by V.V. Nekrashevych [Nek05, Section 3.10]. This construction is in some sense dual to graph substitution. The new graph is constructed from the copies of the previous graph using some finite data, which we call inflation data. We show how the Schreier graphs Γ_n of bounded automaton groups can be constructed using such inflations and describe the associated inflation data. The piecewise linear map of the form $f_{\mathcal{K}}$ can be naturally associated with every inflation data. Using iterations of maps $f_{\mathcal{K}}$, we show an effective way to find the asymptotic behavior of the diameters of the Schreier graphs Γ_n and the orbital contracting coefficient of the group, answering to the questions of R.I. Grigorchuk and V.V. Nekrashevych in case of bounded automaton groups.

CHAPTER II

AUTOMATA AND SELF-SIMILAR GROUPS

The goal of this chapter is to introduce general notations, terminology, and results that will be used throughout the dissertation (see [Nek05, GNS00, BGN03]).

1 Spaces of words

Let X be a finite set, which will be called *alphabet* with elements called *letters*. We always suppose $|X| > 1$.

Let X^* be the free monoid generated by X . The elements of this monoid are finite words $x_1x_2 \dots x_n$, $x_i \in X$, including the empty word \emptyset . Then X^* can be decomposed in the disjoint union $\coprod_{n \geq 0} X^n$, where $X^0 = \{\emptyset\}$ and X^n are Cartesian products for $n \geq 1$. The set X^n is called *n-th level*. The length of a word $v = x_1x_2 \dots x_n$ (the number of letters in it) is denoted by $|v| = n$. The length of the empty word is zero.

Let X^ω be the set of all right-infinite sequences (words) $x_1x_2 \dots$, $x_i \in X$. Let $X^{-\omega}$ be the set of all left-infinite sequences (words) $\dots x_2x_1$, $x_i \in X$. The sets X^ω and $X^{-\omega}$ are naturally identified with Cartesian products $X^{\mathbb{N}}$ and $X^{-\mathbb{N}}$, which allows us to consider them as topological spaces with the topology of the direct (Tikhonov) product of discrete sets X . The collections $\{vX^\omega, v \in X^*\}$ and $\{X^{-\omega}v, v \in X^*\}$ of all cylindrical sets form the bases of open sets in these topologies. The cylindrical sets are open and closed, hence the spaces X^ω and $X^{-\omega}$ are totally disconnected. They are also compact and without isolated points, thus homeomorphic to the Cantor set.

The *restriction on the n-th level* of a right-infinite sequence $a = x_1x_2 \dots \in X^\omega$ is the word $a_n = x_1x_2 \dots x_n$. The *restriction on the n-th level* of a left-infinite sequence $a = \dots x_2x_1 \in X^{-\omega}$ is the word $a_n = x_n \dots x_2x_1$.

Two right-infinite sequences $x_1x_2\dots, y_1y_2\dots \in X^\omega$ are called *confinal* if they differ only in finitely many letters. The confinality relation is an equivalence relation. The respective equivalence classes are called the *confinality classes*. The confinal class of a sequence $\omega \in X^\omega$ is denoted by $E_c(\omega)$.

The *shift* on the space X^ω is the map $\sigma : X^\omega \rightarrow X^\omega$, which deletes the first letter of the word: $\sigma(x_1x_2x_3\dots) = x_2x_3\dots$. The *shift* on the space $X^{-\omega}$ is the map $\tau : X^{-\omega} \rightarrow X^{-\omega}$, which deletes the last letter of the word: $\tau(\dots x_3x_2x_1) = \dots x_3x_2$. By our notations $\sigma^k(a_n) = a_{n-k}$ for any $a \in X^\omega$ and $\tau^k(a_n) = a_{n-k}$ for any $a \in X^{-\omega}$.

2 Graphs and trees

A (*directed*) *graph* (with multiple edges and loops) Γ is defined by a set of vertices $V(\Gamma)$, a set of edges (arrows) $E(\Gamma)$, and maps $s, r : E(\Gamma) \rightarrow V(\Gamma)$, where $s(e)$ is the beginning of the edge e and $r(e)$ is its end.

Two vertices v_1, v_2 are *adjacent* if there exists an edge e such that $v_1 = s(e)$ and $v_2 = r(e)$ or $v_2 = s(e)$ and $v_1 = r(e)$. In this case, we say that the edge e connects the vertices v_1 and v_2 . A *loop* is an edge e such that $s(e) = r(e)$.

An *undirected graph* (with multiple edges and loops) Γ is a directed graph together with a map $e \mapsto \bar{e}$ on the set of edges such that $s(\bar{e}) = r(e)$ and $r(\bar{e}) = s(e)$. This map turns over the directions of arrows-edges and we can assume that together with every edge we have and an edge in opposite direction.

A *simplicial graph* Γ is defined by a set of vertices $V(\Gamma)$ and a set of edges $E(\Gamma)$, where every edge e is a set $\{v_1, v_2\}$ of two different vertices $v_1, v_2 \in V$. The vertices v_1, v_2 of the simplicial graph are *adjacent* if the set $\{v_1, v_2\}$ is an edge of this graph.

The *edge-labeled graph* with label set S is a graph together with a map $m : E(\Gamma) \rightarrow S$, which assigns a label $m(e) \in S$ to every edge of the graph.

A *morphism* of graphs $f : \Gamma_1 \rightarrow \Gamma_2$ is a pair of maps

$$f_v : V(\Gamma_1) \rightarrow V(\Gamma_2) \quad f_e : E(\Gamma_1) \rightarrow E(\Gamma_2)$$

such that

$$s(f_e(e)) = f_v(s(e)) \quad r(f_e(e)) = f_v(r(e))$$

for all $e \in E(\Gamma_1)$. A *morphism of labeled graphs* is a morphism of graphs that preserves the labels of the edges. A *morphism of simplicial graphs* $f : \Gamma_1 \rightarrow \Gamma_2$ is a map of the sets of vertices $f_v : V(\Gamma_1) \rightarrow V(\Gamma_2)$ such that for every edge $\{v_1, v_2\} \in E(\Gamma_1)$ the set $\{f_v(v_1), f_v(v_2)\}$ is an edge of the graph Γ_2 . The corresponding map $f_e : E(\Gamma_1) \rightarrow E(\Gamma_2)$ is defined by $f_e(\{v_1, v_2\}) = \{f_v(v_1), f_v(v_2)\}$.

A bijective morphism $f : \Gamma \rightarrow \Gamma$ is called an *automorphism* of the graph Γ .

If Γ is a graph, then its *associated simplicial graph* is the simplicial graph with the same set of vertices, which contains an edge $\{v_1, v_2\}$ if and only if the vertices v_1 and v_2 are adjacent in the original graph and $v_1 \neq v_2$.

A sequence of edges $e_1 e_2 \dots e_n$ of a graph Γ is called a *path* if $r(e_i) = s(e_{i+1})$ for all $1 \leq i \leq n - 1$. The vertex $s(e_1)$ is called the *beginning* of the path and the vertex $r(e_n)$ is its *end*. The number n is called the *length* of the path. Similarly we define left-infinite paths $\dots e_2 e_1$ and right-infinite paths $e_1 e_2 \dots$. A path is called *simple* if all its edges are different. A *cycle* is a path such that the beginning vertex and the end vertex are the same. A graph is called *connected* if for every its vertices v_1, v_2 there exists a path, which begins at v_1 and ends at v_2 .

In simplicial graph a path $e_1 e_2 \dots e_n$ is uniquely defined by the sequence of vertices $v_0 v_1 \dots v_n$, where $e_i = \{v_{i-1}, v_i\}$ for all $i = 1, 2, \dots, n$. Hence the sequence of vertices $v_0 v_1 \dots v_n$ such that $\{v_{i-1}, v_i\} \in E$ for all i is also called a path.

A *geodesic path* (or just *geodesic*) connecting the vertices v_1 and v_2 is a path of

minimal length, whose beginning and end are v_1 and v_2 respectively. The length of a geodesic path connecting v_1 and v_2 is called the *distance* between them and is denoted by $d(v_1, v_2)$. We define $d(v, v) = 0$. The distance $d(\cdot, \cdot)$ is called the *combinatorial (geodesic, natural) metric* on the graph. The *diameter* of a graph Γ is the length of its longest geodesic and is denoted by $\text{Diam } \Gamma$.

A *subgraph* of a graph Γ *induced or spanned by a set of vertices* $U \subset V(\Gamma)$ is a graph with the set of vertices U together with all edges of the graph Γ between vertices in U . The *ball* $B(v, r)$ of radius r with center at the vertex v is the set of vertices $\{u \in V : d(v, u) \leq r\}$.

The *degree* of a vertex v is the number of edges whose beginning or end is v (note that a loop counts twice). A graph Γ is *locally finite* if every its vertex has finite degree. If the graph is locally finite then every ball $B(v, r)$ is finite.

The *growth function* of a locally-finite connected graph Γ with respect to a vertex v_0 is the function $\gamma : \mathbb{N} \rightarrow \mathbb{N}$, where $\gamma(r)$ is equal to the number of vertices in the ball $B(v_0, r)$. A graph has *polynomial growth* if its growth function is bounded by a polynomial. A graph has polynomial growth if the number

$$\alpha = \limsup_{r \rightarrow \infty} \frac{\log \gamma(r)}{\log r}$$

is finite. In this case, the number α is called the *degree of growth* of the graph. The degree of the growth does not depend on a choice of the base point v_0 .

A *tree* T is a connected simplicial graph without cycles. A *rooted tree* is a tree with a fixed vertex called its *root*. A *morphism of rooted trees* is a morphism of corresponding graphs, which maps the root of one tree to the root of the other one.

For two vertices v, u of a rooted tree we say that the vertex u *lies below* the vertex v if the path, which connects u with the root of the tree, passes through the vertex v . The subgraph of a rooted tree induced by the set of vertices that lie below

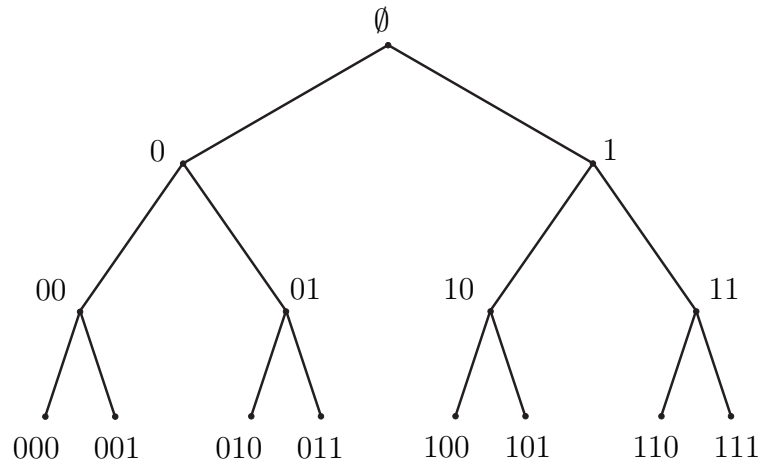

Fig. 1. Binary tree

the vertex v is a subtree, which is denoted by T_v and is called the *subtree with rooted vertex* v . If T is a rooted tree, then the set T_n of all vertices on distance n from the root is called the n -th level of the tree T .

A rooted tree T is called d -regular if the degree of the root is d and the degree of all the other vertices is $d + 1$. A rooted tree is called *binary* if it is 2-regular (see Figure 1). The n -th level of a d -regular tree contains d^n vertices.

The set of all finite words X^* over the alphabet X has a natural structure of a rooted tree in which two words are connected by an edge if and only if they are of the form v and vx , where $v \in X^*$ and $x \in X$. The empty word \emptyset is the root of the tree X^* . The tree X^* is d -regular for $d = |X|$ and every d -regular tree is isomorphic to X^* . The subtree T_v of the tree X^* coincides with the tree vX^* rooted at v . The map $u \mapsto vu$ defines the canonical isomorphism of the rooted trees X^* and vX^* . The set X^ω is naturally identified with the *boundary of the tree* X^* , which is the set of all infinite simple paths starting at the root.

3 Automorphisms of rooted trees

Denote by $\text{Aut } X^*$ the group of all automorphisms of the rooted tree X^* .

An automorphism of the rooted tree X^* preserves the root, and hence all distances between vertices and the levels X^n . Since an automorphism is a bijective map on the vertices, it induces a permutation on every level of the tree.

Take arbitrary $g \in \text{Aut } X^*$. For every word $v \in X^*$ define the map $g|_v : X^* \rightarrow X^*$ by the rule

$$g|_v(x) = y \quad \text{if and only if} \quad g(vx) = g(v)y$$

for all $x, y \in X^*$ of equal length $|x| = |y|$. The map $g|_v$ is an automorphism of the tree X^* and is called the *restriction of g on the word v* or the *state of g in the word v* .

The action of g on the tree X^* can be written in the form

$$g(vw) = g(v)g|_v(w)$$

for all $v, w \in X^*$. Restrictions have the following properties:

$$g|_{v_1v_2} = g|_{v_1}|_{v_2} \quad (g \cdot h)|_v = g|_{h(v)} \cdot h|_v$$

for arbitrary automorphisms $g, h \in \text{Aut } X^*$ and words $v, v_1, v_2 \in X^*$.

An automorphism g is called *finite-state*, if the set of its states $\{g|_v : v \in X^*\}$ is finite. An automorphism g is called *finitary* if there exists $n \geq 1$ such that $g|_v = 1$ for all words $v \in X^n$. The set of all finitary automorphisms form a group, called the *finitary group*. A finitary automorphism g is called *rooted* if $g|_x = 1$ for every letter $x \in X$ (g may act non-trivially only near the root of the tree).

Every automorphism $g \in \text{Aut } X^*$ induces a permutation π_n on the n -th level X^n and restrictions $g|_v$ on words $v \in X^n$. Different automorphisms have different tuples $\{\text{permutation } \pi_n, \text{restrictions } g|_v, v \in X^n\}$.

Theorem II.1 ([GNS00, Proposition 3.8]). *The group $\text{Aut } X^*$ is isomorphic to the wreath product $\text{Sym}(X) \wr \text{Aut } X^*$, where $\text{Sym}(X)$ is the complete symmetric group on the set X . The group $\text{Aut } X^*$ is isomorphic to the infinite wreath product $\wr_{i=1}^{\infty} \text{Sym}(X)$.*

Let $X = \{x_1, x_2, \dots, x_d\}$. The canonical representation of the elements of the wreath product $\text{Sym}(X) \wr \text{Aut } X^*$ allows us to represent the elements $g \in \text{Aut } X^*$ in the form

$$g = (g|_{x_1}, g|_{x_2}, \dots, g|_{x_d})\pi_g, \quad (2.1)$$

where π_g is the permutation induced by g on the first level X . The multiplication of automorphisms g and h represented in the form (2.1) can be done by the rule

$$g \cdot h = (g|_{x_1} h|_{\pi_g(x_1)}, g|_{x_2} h|_{\pi_g(x_2)}, \dots, g|_{x_d} h|_{\pi_g(x_d)})\pi_g \pi_h.$$

The notation (2.1) is convenient to use for recurrent definition of automorphisms in the following way. Suppose that elements g_1, g_2, \dots, g_m satisfy the following wreath recursions:

$$\begin{aligned} g_1 &= (g_{11}, g_{12}, \dots, g_{1d})\pi_1 \\ g_2 &= (g_{21}, g_{22}, \dots, g_{2d})\pi_2 \\ &\vdots \\ g_m &= (g_{m1}, g_{m2}, \dots, g_{md})\pi_m, \end{aligned} \quad (2.2)$$

where $\pi_i \in \text{Sym}(X)$ and every g_{ij} is a word over the alphabet $\{g_1^{\pm 1}, g_2^{\pm 1}, \dots, g_m^{\pm 1}\}$. Then the system (2.2) completely determines the action of the automorphisms g_i on the rooted tree X^* . The action of g_i on the first level is defined by the permutation π_i and the action of the restriction $g_i|_{x_j}$ is uniquely defined by the word g_{ij} .

Every group of automorphisms has a series of natural subgroups.

Definition 1. Let G be a subgroup of $\text{Aut } X^*$.

1. The group G is called *level-transitive* if it acts transitively on all levels X^n .
2. For every vertex $v \in X^*$ the subgroup $St_G(v) = \{g \in G : g(v) = v\}$ is called the *vertex stabilizer*.
3. For every $n \geq 1$ the intersection of all stabilizers of vertices on n -th level

$$St_G(n) = \bigcap_{v \in X^n} St_G(v)$$

is called the *level stabilizer*.

4. For every sequence $w = x_1x_2 \dots \in X^\omega$ the subgroup

$$P_w = \bigcap_{n \geq 1} St_G(x_1x_2 \dots x_n)$$

is called the *parabolic subgroup* or the *stabilizer of the end w* of the tree.

For every vertex $v \in X^*$ and number $n \geq 1$ the maps

$$\phi : St_{\text{Aut } X^*}(v) \rightarrow \text{Aut } X^*, \quad \psi : St_{\text{Aut } X^*}(n) \rightarrow \prod_{i=1}^{|X|^n} \text{Aut } X^*$$

defined by the rules:

$$\phi(g) = g|_v, \quad \psi(g) = (g|_v)_{v \in X^n}$$

are homomorphisms.

Proposition II.2 ([GNS00, Proposition 6.1]). *Let G be a subgroup of $\text{Aut } X^*$. The level stabilizers form a chain*

$$G > St_G(1) > St_G(2) > St_G(3) > \dots$$

of normal subgroups of finite index in the group G . Moreover, the intersection $\bigcap_{n \geq 1} St_G(n)$ is trivial.

Hence the group $\text{Aut } X^*$ is profinite and all its subgroups are residually finite.

4 Automata

Definition 2. An automaton \mathcal{A} is a quadruple (X, Q, π, λ) , where

1. X is an alphabet;
2. Q is a set of states of the automaton;
3. $\pi : Q \times X \rightarrow Q$ is a map, called the *transition function* of the automaton;
4. $\lambda : Q \times X \rightarrow X$ is a map, called the *output function* of the automaton.

An automaton is *finite* if it has a finite number of states.

The set of states Q is usually denoted by \mathcal{A} as well.

A subset $P \subset Q$ is a *sub-automaton* of \mathcal{A} if for every state $p \in P$ and every letter $x \in X$ the state $\pi(p, x)$ belongs to P . The corresponding maps π_P and λ_P are the restrictions of the maps π and λ on the set $P \times X$.

The maps π, λ can be extended on $Q \times X^*$ by the following recurrent formulas

$$\begin{aligned} \pi(q, \emptyset) &= q & \pi(q, xw) &= \pi(\pi(q, x), w), \\ \lambda(q, \emptyset) &= \emptyset & \lambda(q, xw) &= \lambda(q, x)\lambda(\pi(q, x), w), \end{aligned}$$

where $x \in X, q \in Q$, and $w \in X^*$ are arbitrary elements. Similarly, the maps π, λ are extended on $Q \times X^\omega$.

An automaton \mathcal{A} with a fixed state q is called *initial* and is denoted by \mathcal{A}_q . Every initial automaton defines a transformation $\lambda(q, \cdot)$ on the sets of finite and infinite words X^* and X^ω , which we also denote by $\mathcal{A}_q(w) = \lambda(q, w)$. The action of an initial automaton \mathcal{A}_q can be interpreted as the work of a machine, which being in the state q and reading on the input tape a letter x , goes to the state $\pi(q, x)$, types on the output tape the letter $\lambda(q, x)$, then moves both tapes to the next position and proceeds further.

The *nucleus* \mathcal{N} of an automaton \mathcal{A} is its minimal finite sub-automaton such that for every state $q \in \mathcal{A}$ there exists a level $k \in \mathbb{N}$ such that the state $\pi(q, v)$ belongs to \mathcal{N} for every word $v \in X^*$ of length $\geq k$. If the automaton \mathcal{A} is infinite the nucleus may not exist. A finite automaton coincides with its nucleus if and only if every its state has an incoming arrow.

An automaton \mathcal{A} can be represented (and defined) by a labeled directed graph, called the *Moore diagram*, in which the vertices are the states of the automaton and for every pair $(q, x) \in Q \times X$ there is an edge from q to $\lambda(q, x)$ labeled by $x|\pi(q, x)$. Using the Moore diagram of the automaton one can easily find the image of a word $x_1x_2\dots$ under the transformation \mathcal{A}_q . We just start at the state q and go along the arrows labeled by $x_1|y_1, x_2|y_2, \dots$. Then the word $y_1y_2\dots$ which appears on the right labels is the image $\mathcal{A}_q(x_1x_2\dots)$.

We say that a left-infinite path $\dots e_2e_1$ in the Moore diagram of an automaton is *labeled* by a pair of left-infinite sequences $\dots x_2x_1|\dots y_2y_1$ if each edge e_i is labeled by $x_i|y_i$. We say that a left-infinite sequence $\dots x_2x_1$ is *read on* a left-infinite path $\dots e_2e_1$, if each edge e_i is labeled by $x_i|y_i$ for some letter y_i .

An automaton is called *invertible* if each of its states defines an invertible transformation of the set X^* (or equivalently of the set X^ω). If \mathcal{A} is an invertible automaton, then its *inverse* is the automaton $\mathcal{A}^{-1} = (X, Q, \pi', \lambda')$, where

$$\pi(q, x) = \pi'(q, \lambda(q, x)) \quad \lambda(\lambda'(q, x)) = x,$$

for all $q \in Q$ and $x \in X$. By changing every label $x|y$ to $y|x$ in the Moore diagram of the automaton \mathcal{A} we get the Moore diagram of the automaton \mathcal{A}^{-1} . An initial automaton \mathcal{A}_q^{-1} defines a transformation, which is inverse to the transformation defined by \mathcal{A}_q .

Invertible transformations defined by initial automata are automorphisms of

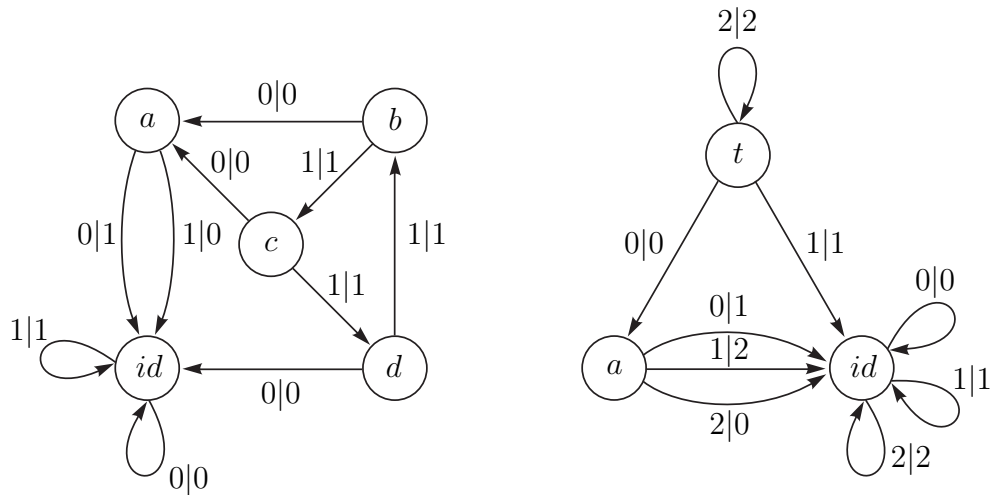

Fig. 2. The automata generating the Grigorchuk group (on the left) and the Gupta-Fabrikovsky group (on the right)

the tree X^* and every automorphism can be given by some initial automaton. If the transformation \mathcal{A}_q is invertible, then the automorphism $\mathcal{A}_{\pi(q,v)}$ defined by the state $\pi(q,v)$ is precisely the restriction of the automorphism \mathcal{A}_q on the word v . An automorphism is finite-state if and only if it can be given by a finite initial automaton.

Definition 3. Let \mathcal{A} be an invertible automaton. The group generated by all the transformations $\mathcal{A}_q, q \in Q$, is denoted by $G_{\mathcal{A}}$ and is called the *group generated by the automaton \mathcal{A}* or the *automaton group* defined by \mathcal{A} .

Example 1 (Grigorchuk group). Let $X = \{0, 1\}$. Define the automorphisms of the binary tree X^* by the wreath recursions:

$$a = (1, 1)\sigma, \quad b = (a, c), \quad c = (a, d), \quad d = (1, b),$$

where σ is the transposition $(0, 1) \in \text{Sym}(X)$. The *Grigorchuk group* is generated by a, b, c, d . So, it is generated by the automaton shown in Figure 2. This group was

constructed as an example of infinite periodic finitely generated group (see [Gri80]). Also it is the first example of a group of intermediate growth (see [Gri83]), i.e. its growth function has intermediate growth between polynomial and exponential. The Grigorchuk group has many other interesting properties like just-infiniteness, finite width, etc. (see [BGŠ03, H00, BG02, BG00a, BG00b]).

Example 2 (Gupta-Fabrikovsky group). This group is defined over the alphabet $X = \{0, 1, 2\}$ and is generated by elements a, t , which are defined by the wreath recursions:

$$a = (1, 1, 1)\sigma, \quad t = (a, 1, t),$$

where σ is the permutation $(0, 1, 2) \in \text{Sym}(X)$. The automaton generating the Gupta-Fabrikovsky group is shown in Figure 2. This group is studied in [FG85].

5 Self-similar groups

Definition 4. A faithful action of a group G on X^* (or on X^ω) is called *self-similar* if for every $g \in G$ and every $x \in X$ there exist $h \in G$ and $y \in X$ such that

$$g(xw) = yh(w) \tag{2.3}$$

for every $w \in X^*$ (respectively $w \in X^\omega$).

Applying Equation (2.3) several times we get that for every $g \in G$ and every $v \in X^*$ there exist $h \in G$ and $u \in X^*$, $|u| = |v|$, such that

$$g(vw) = uh(w)$$

for all $w \in X^*$ ($w \in X^\omega$). The automorphism h is precisely the restriction $g|_v$. An automorphism group G of the tree X^* is self-similar if $g|_v \in G$ for all words $v \in X^*$

and every $g \in G$. A self-similar group is called *finite-state* if the set of restrictions $\{g|_v | v \in X^*\}$ is finite for every element g of the group.

Groups generated by automata are self-similar and every self-similar group G can be given by the *complete automaton* \mathcal{A} of its action. The set of states of this automaton is G and the maps π, λ are defined by the rules

$$\pi(g, x) = h = g|_x \quad \lambda(g, x) = y = g(x),$$

where $x \in X, g \in G$. It follows that $\mathcal{A}_g(w) = g(w)$ for all $w \in X^*$ and every $g \in G$.

Proposition II.3 ([Nek05, Section 1.5.4]). *A finitely generated self-similar group is finite-state if and only if it can be generated by a finite invertible automaton.*

A set S of automorphisms of the tree X^* is called *self-similar*, if the restriction $s|_v$ belongs to S for every $s \in S$ and $v \in X^*$. That is S is a sub-automaton of the complete automaton of $\text{Aut } X^*$.

Definition 5. A self-similar group G is called *self-replicating (recurrent)* if it acts transitively on the first level X of the tree X^* , and for a letter $x \in X$ the map $\phi_x : St_G(x) \rightarrow G$ given by the rule $g \mapsto g|_x$ is surjective (it does not depend on a letter x).

Proposition II.4 ([Nek05, Corollary 2.8.5]). *A self-replicating self-similar group is level-transitive.*

An important class of self-similar groups is the class of contracting groups.

Definition 6. A self-similar group G is called *contracting* if there exists a finite set $\mathcal{N} \subset G$ such that for every $g \in G$ there exists a level $k \in \mathbb{N}$ such that $g|_v \in \mathcal{N}$ for all words $v \in X^*$ of length $\geq k$. The minimal set with this property is called the *nucleus* of the self-similar action.

It follows from the definition that every contracting action is finite-state.

The nucleus of a contracting self-similar group is a self-similar set and is precisely the nucleus of the complete automaton of the action. If \mathcal{N} is the nucleus of some contracting group, then the self-similar group $\langle \mathcal{N} \rangle$ is contracting with nucleus \mathcal{N} .

Proposition II.5 ([Nek05, Proposition 2.11.3]). *A finitely generated self-replicating contracting self-similar group is generated by its nucleus.*

Proposition II.6. *Let G be a contracting self-similar group. The G -orbit of every point $\omega \in X^\omega$ is contained in a union of finitely many cofinality classes.*

Proof. The G -orbit of a point $\omega \in X^\omega$ is contained in the union $\cup_{g \in \mathcal{N}} E_c(g(\omega))$. \square

For a finitely generated self-similar group the contracting property means that the length of the group elements contracts under taking restrictions. Let G be a group generated by a finite set S . We can consider *the word length* $l(g) = l_S(g)$ with respect to S of the group element $g \in G$ defined by

$$l(g) = \min\{n \mid g = s_1 s_2 \dots s_n, s_i \in S \cup S^{-1}\}.$$

Observe, that if the group G is self-similar with a self-similar generating set S then $l(g|_v) \leq l(g)$ for all $v \in X^*$ and $g \in G$.

Definition 7. Let G be a finitely generated self-similar group. The number

$$\rho = \lim_{n \rightarrow \infty} \max_{v \in X^n} \sqrt[n]{\limsup_{l(g) \rightarrow \infty} \frac{l(g|_v)}{l(g)}}. \quad (2.4)$$

is called *the contracting coefficient* of the action.

The contracting coefficient is finite and does not depend on a particular choice of a generating set (see [Nek05, Lemma 2.11.10]).

Theorem II.7 ([Nek05, Proposition 2.11.11]). *A finitely generated self-similar group is contracting if and only if its contracting coefficient ρ is less than 1.*

Contracting groups have nice algorithmic properties.

Theorem II.8 ([Nek05, Proposition 2.13.10]). *A finitely generated contracting self-similar group has solvable word problem. Moreover, for any $\epsilon > 0$ there exists an algorithm of polynomial complexity of degree not greater than $\frac{\log |X|}{-\log \rho} + \epsilon$ solving the word problem in the group, where ρ is its contracting coefficient.*

The Grigorchuk group and the Gupta-Fabrikovsky group are contracting.

6 Schreier graphs

Let G be a group generated by a finite set S . Let H be a subgroup of G . The *Schreier graph* $\Gamma(G, S, H)$ of the group G with respect to its subgroup H and the generating set S is the labeled directed graph whose vertices are the right cosets $G/H = \{Hg : g \in G\}$, the set of edges $G/H \times S$, and the label set S . The edge (Hg, h) is labeled by h and the maps s, r are defined by the rules

$$s((Hg, h)) = Hg \quad r((Hg, h)) = Hgh$$

for all $Hg \in G/H$ and $h \in S$.

If the group G acts on a set M , then the corresponding *Schreier graph* $\Gamma(G, S, M)$ is the labeled directed graph with the set of vertices M , the set of edges $M \times S$, and the label set S . In this graph the edge (x, g) starts in x , ends in $g(x)$, and is labeled by g . That is the maps s, r are given by the rules

$$s((x, g)) = x \quad r((x, g)) = g(x).$$

Suppose that the group G acts transitively on M . For every point $m \in M$ define

a subgroup $St_G(m) = \{g \in G : g(m) = m\}$, which is called the *stabilizer of the point* m . Then the Schreier graph $\Gamma(G, S, M)$ is isomorphic to the Schreier graph $\Gamma(G, S, St_G(m))$ for every $m \in M$.

The *Cayley graph* of the group G is the Schreier graph of the action of G on itself by multiplication from the right, or (what is the same) the Schreier graph $\Gamma(G, S, \{1\})$.

If the set S is symmetric, that is $S = S^{-1}$, then we can suppose that the graph $\Gamma(G, S, M)$ is undirected with the map $\overline{(x, g)} = (g(x), g^{-1})$.

The Schreier graph $\Gamma(G, S, M)$ is locally finite, since the set S is finite. If the group G acts transitively on M then the graph $\Gamma(G, S, M)$ is connected.

The Schreier graph $\Gamma(G, S, M)$ uniquely defines the action of the group G on the set M and if the action is faithful uniquely defines the group G . The sets of vertices in the connected components of the graph $\Gamma(G, S, M)$ coincide with the orbits of the action (G, M) . For every $m \in M$ the Schreier graph $\Gamma(G, S, m)$ of the action of G on the G -orbit of the point m is called the *orbital Schreier graph*. For arbitrary points from the same orbit the corresponding orbital Schreier graphs are isomorphic.

Let G be a group of automorphisms of the rooted tree X^* generated by a finite set S . The levels X^n of the tree are invariant under the action of the group G . Denote by $\Gamma_n(G, S)$ the Schreier graph of the action of G on X^n . For a point $w \in X^\omega$ denote by $\Gamma_w(G, S)$ the orbital Schreier graph of the action of G on the G -orbit of the point w . The Schreier graph $\Gamma(G, S, X^*)$ is a disjoint union of the Schreier graphs $\Gamma_n(G, S)$.

For a finite invertible automaton S , the Schreier graph $\Gamma_n(\langle S \rangle, S)$ is denoted by $\Gamma_n(S)$ and is called the *Schreier graph of n -th level of the automaton S* .

The shift map $\tau_n : X^{n+1} \rightarrow X^n$, which deletes the last letter of a word $\tau_n(x_1x_2 \dots x_nx_{n+1}) = x_1x_2 \dots x_n$, induces the surjective morphism of labeled graphs $\tau_n : \Gamma_{n+1}(G, S) \rightarrow \Gamma_n(G, S)$. Hence we have the inverse spectrum of finite labeled

graphs

$$\Gamma_0(G, S) \leftarrow \Gamma_1(G, S) \leftarrow \Gamma_2(G, S) \leftarrow \dots \quad (2.5)$$

Proposition II.9 ([BGN03, Proposition 7.1]). *The Schreier graph $\Gamma(G, S, X^\omega)$ is the inverse limit of the sequence (2.5).*

Proposition II.10 ([BGN03, Proposition 7.2], [GŻ99]). *Take an infinite word $w = x_1x_2\dots \in X^\omega$. The sequence of the pointed Schreier graphs $(\Gamma_n(G, S), x_1x_2\dots x_n)$ converges in the local topology on pointed graphs to the pointed Schreier graph $(\Gamma_w(G, S), w)$.*

In [Gri84] (see also [GŻ99]) the local topology is introduced on the space of Cayley graphs of finitely generated groups. This topology can be considered on the space of all locally-finite connected graphs (Γ, v) with a fixed vertex v . The *distance between graphs* (Γ_1, v_1) and (Γ_2, v_2) is the number 2^{-R} , where R is the maximal radius such that there exists an isomorphism $f : B_{\Gamma_1}(v_1, R) \rightarrow B_{\Gamma_2}(v_2, R)$, which moves v_1 to v_2 . The distance is defined to be zero if there exists an isomorphism $f : \Gamma_1 \rightarrow \Gamma_2$ such that $f(v_1) = v_2$. The defined metric gives a natural topology on the set of pointed graphs, called *local topology*. It was used, for example, in the study of random walks on Schreier graphs of actions of groups on rooted trees in [GŻ99]. The space of all graphs with this topology is a totally disconnected space.

We say that a graph Γ_1 is *locally contained* in a graph Γ_2 (denoted $\Gamma_1 \sqsubseteq \Gamma_2$) if for every vertex v_1 of Γ_1 and every $R \in \mathbb{N}$ there exist a vertex v_2 of Γ_2 such that the distance between the pointed graphs (Γ_1, v_1) and (Γ_2, v_2) is less than 2^{-R} . Two graphs Γ_1 and Γ_2 are *locally isomorphic* if $\Gamma_1 \sqsubseteq \Gamma_2$ and $\Gamma_2 \sqsubseteq \Gamma_1$. Thus two graphs are locally isomorphic if and only if for every finite subgraph of the first one, the second graph contains its isomorphic copy.

Let G be a group of automorphisms of the tree X^* . A sequence $w = x_1x_2\dots \in$

X^ω is called *G-generic* or *generic with respect to the action of the group G* if for every $g \in G$ either $g(w) \neq w$ or there exists $n \in \mathbb{N}$ such that $g(v) = v$ for all $v \in x_1 x_2 \dots x_n X^\omega$.

Suppose that the group G acts transitively on all levels of the tree X^* . Then the set of all G -generic points is a union of a countable number of nowhere dense sets. Hence, almost all points of the space X^ω are G -generic in the Baire category.

Theorem II.11 ([GNS00, Proposition 6.21]). *Let G be a finitely generated level-transitive group of automorphisms of X^* . The orbital Schreier graph $\Gamma_w(G, S)$ for a G -generic point $w \in X^\omega$ is locally contained in every orbital Schreier graph $\Gamma_{w'}(G, S)$, $w' \in X^\omega$. In particular, the orbital Schreier graphs for G -generic points are locally isomorphic.*

Thus almost all (in the Baire category) orbital Schreier graphs of a level-transitive action are locally isomorphic.

Let G be a finitely generated level-transitive contracting self-similar group. For every finite generating set S of the group G define

$$\nu_n = \limsup_{d(\omega_1, \omega_2) \rightarrow \infty} \frac{d(\sigma^n(\omega_1), \sigma^n(\omega_2))}{d(\omega_1, \omega_2)}$$

for all $n \geq 1$, where $d(\cdot, \cdot)$ is the combinatorial (geodesic) metric on the connected components of the Schreier graph $\Gamma(G, S, X^\omega)$ and the points $\omega_1, \omega_2 \in X^\omega$ lie in the same orbit of the action (G, X^ω) . The number

$$\rho_o = \lim_{n \rightarrow \infty} \sqrt[n]{\nu_n}$$

is called the *orbital contracting coefficient* of the group G . This coefficient was introduced by V. Nekrashevych (private communication) to give an upper bound on the growth of the orbital Schreier graphs Γ_ω . In Chapter V we will see a natural

interpretation of the coefficient ρ_o in terms of hyperbolic geometry.

Proposition II.12. *The orbital contracting coefficient ρ_o does not depend on the choice of a finite generating set S and is not greater than the contracting coefficient ρ of the group G .*

Proof. (V. Nekrashevych) The independence of the choice of a generating set is proved by the standard arguments (see the proof of the corresponding fact for the usual contracting coefficient).

If the points ω_1 and ω_2 belong to a common G -orbit, then there exists an element $g \in G$ such that $g(\omega_1) = \omega_2$ and $d(\omega_1, \omega_2) = l(g)$. Then the points $\sigma^n(\omega_1)$ and $\sigma^n(\omega_2)$ also belong to a common G -orbit. Moreover, $g|_v(\sigma^n(\omega_1)) = \sigma^n(\omega_2)$, where the word v is the beginning of length n of the word ω_1 . In particular, $l(g|_v) \geq d(\sigma^n(\omega_1), \sigma^n(\omega_2))$ and so

$$\frac{d(\sigma^n(\omega_1), \sigma^n(\omega_2))}{d(\omega_1, \omega_2)} \leq \frac{l(g|_v)}{l(g)}.$$

Thus $\rho_o \leq \rho$. □

In particular $\rho_o < 1$ by Theorem II.7.

Theorem II.13. *Let G be a level-transitive contracting self-similar group with finite generating set S . The growth of every orbital Schreier graph $\Gamma_w(G, S)$, $w \in X^\omega$, is polynomial of degree not greater than $-\frac{\log |X|}{\log \rho_o}$.*

Proof. See the proofs of the similar results [BGN03, Proposition 8.11] and [Nek02, Proposition 5.10]. □

As a corollary, the contracting coefficient of the action (G, X^*) is not less than $\frac{1}{|X|}$.

Another important coefficient characterizes the growth of diameters of finite

Schreier graphs $\Gamma_n(G, S)$. Define the number

$$\rho_d = \liminf_{n \rightarrow \infty} \sqrt[n]{\frac{1}{\text{Diam } \Gamma_n(G, S)}},$$

where $\text{Diam } \Gamma$ is the diameter of the graph Γ .

Proposition II.14. *The coefficient ρ_d does not depend on the choice of a finite generating set S and lies between $\frac{1}{|X|}$ and 1.*

Proof. The independence of the choice of a generating set is proved by the standard arguments. The bounds follow from the inequalities $1 \leq \text{Diam } \Gamma_n(G, S) \leq |X|^n$. \square

Theorem II.15. *Let G be a level-transitive contracting self-similar group with finite generating set S . The growth degree of every orbital Schreier graph $\Gamma_w(G, S)$, $w \in X^\omega$, is not less than $-\frac{\log |X|}{\log \rho_d}$.*

Proof. Denote $D_n = \text{Diam } \Gamma_n(G, S)$. Let $\rho_1 \in (0, \rho_d)$ be an arbitrary number. Choose a sufficiently large number $N \in \mathbb{N}$ so that $D_n \leq 1/\rho_1^n$ for all $n \geq N$.

Since the action is level-transitive, the growth function γ of every orbital Schreier graph satisfies $\gamma(D_n) \geq |X|^n$. Put $k = \left\lceil -\frac{\log n}{\log \rho_1} \right\rceil$. Then we have the inequalities

$$\gamma(n) \geq \gamma\left(\frac{1}{\rho_1^k}\right) \geq \gamma(D_n) \geq |X|^k \geq |X|^{-\frac{\log n}{\log \rho_1} - 1} = \frac{1}{|X|} \cdot n^{-\frac{\log |X|}{\log \rho_1}},$$

for all $n \geq \frac{1}{\rho_1^N}$. Hence, the degree of growth of every orbital Schreier graph is not less than $-\frac{\log |X|}{\log \rho_1}$ for any $\rho_1 \in (0, \rho_d)$. Theorem II.13 implies that the coefficient ρ_d is less than 1 and we obtain that the degree of growth of every orbital Schreier graph is not less than $-\frac{\log |X|}{\log \rho_d}$. \square

Corollary II.16. *The degrees of growth of the orbital Schreier graphs $\Gamma_w(G, S)$, $w \in X^\omega$, lie between $-\frac{\log |X|}{\log \rho_d}$ and $-\frac{\log |X|}{\log \rho_o}$.*

The diameters of the Schreier graphs $\Gamma_n(G, S)$ of a level-transitive contracting self-similar group have exponential growth of exponent $\frac{1}{\rho_d} > 1$. In Chapter V we will deal with the problem of finding this coefficient ρ_d and the asymptotic behavior of the sequence $\text{Diam } \Gamma_n(G, S)$. The asymptotic behavior is considered with respect to the following equivalence. Let $a_n, b_n, n \geq 1$, be sequences of nonnegative numbers or vectors of the same dimension. We say that $a_n \succcurlyeq b_n$ if there exists a constant $q > 0$ such that $q \cdot a_n \geq b_n$ for all n large enough. If $a_n \succcurlyeq b_n$ and $b_n \succcurlyeq a_n$ then we say that $a_n \sim b_n$ and that a_n and b_n have *the same growth*. The diameters of the Schreier graphs associated with two finite generating systems have the same growth.

For a finite invertible automaton S we denote by $\rho_o(S)$ and $\rho_d(S)$ the coefficients ρ_o and ρ_d of the group generated by S . To find the coefficients ρ_o and ρ_d it is sufficient to consider the Schreier graphs associated with the nucleus of the group (even if it is not a generating set).

Proposition II.17. *Let G be a level-transitive contracting self-similar group with a finite generating set S . Let \mathcal{N} be the nucleus of the group G . Then $\rho_o(S) = \rho_o(\mathcal{N})$ and $\rho_d(S) = \rho_d(\mathcal{N})$.*

Proof. If the group G is level-transitive then the group $\langle \mathcal{N} \rangle$ is level-transitive. Really, choose a level $k \in \mathbb{N}$ such that $s|_v \in \mathcal{N}$ for every $s \in S$ and all words $v \in X^*$ of length $\geq k$. Let $w \in X^k$ be any word. For a given $v, u \in X^n$ there exists $g \in G$ such that $g(wv) = wu$, then $g|_w(v) = u$ with $g|_w \in \langle \mathcal{N} \rangle$. So, the Schreier graphs $\Gamma_n(\mathcal{N})$ are connected.

The statement of the proposition follows from the fact that $G|_{X^k} = \{g|_v | g \in G, v \in X^k\}$ is a subset of $\langle \mathcal{N} \rangle$. Moreover, $\text{Diam } \Gamma_n(\mathcal{N}) \sim \text{Diam } \Gamma_n(S)$. \square

7 Limit spaces of self-similar groups

Let us fix a contracting self-similar group G .

Definition 8. Two left-infinite sequences $\dots x_2x_1, \dots y_2y_1 \in X^{-\omega}$ are said to be *asymptotically equivalent* with respect to the group G if there exists a finite set $K \subset G$ and a sequence $g_n \in K$, $n \geq 1$, such that

$$g_n(x_nx_{n-1} \dots x_2x_1) = y_ny_{n-1} \dots y_2y_1$$

for all $n \geq 1$. The asymptotic equivalence is an equivalence relation. The quotient of the topological space $X^{-\omega}$ by the asymptotic equivalence relation is called the *limit space* of the self-similar group G and is denoted by \mathcal{J}_G .

The asymptotic equivalence relation can be uniquely defined by the nucleus of the group. In particular, contracting self-similar groups with the same nuclei have homeomorphic limit spaces.

Theorem II.18 ([Nek05, Theorem 3.6.3]). *Let G be a contracting self-similar group with nucleus \mathcal{N} . Two sequences $\dots x_2x_1, \dots y_2y_1 \in X^{-\omega}$ are asymptotically equivalent if and only if there exists a left-infinite path $\dots e_2e_1$ in the Moore diagram of the nucleus \mathcal{N} such that every edge e_i is labeled by $x_i|y_i$.*

The asymptotic equivalence is closed and every point is equivalent to at most $|\mathcal{N}|$ points. The limit space \mathcal{J}_G is compact, metrizable, and has topological dimension $\leq |\mathcal{N}| - 1$. If the group G is finitely generated and level-transitive then the limit space \mathcal{J}_G is connected.

It is not difficult to see, that two sequences $\dots x_2x_1, \dots y_2y_1$ are asymptotically equivalent if and only if the sequence of distances $d_n(x_n \dots x_2x_1, y_n \dots y_2y_1)$ in the Schreier graph $\Gamma_n(G, S)$ is bounded. In particular, if the simplicial Schreier graphs

on levels of two contracting self-similar groups coincide, then their limit spaces are homeomorphic.

The asymptotic equivalence relation is invariant under the shift $\tau : X^{-\omega} \rightarrow X^{-\omega}$, which induces a surjective continuous map s on the limit space \mathcal{J}_G and every point $x \in \mathcal{J}_G$ has not more than $|X|$ pre-images under the map s .

Definition 9. For every finite word $v \in X^*$ the *tile* \mathcal{T}_v of the limit space \mathcal{J}_G is the image of the cylindrical set $X^{-\omega}v$ under the canonical projection $X^{-\omega} \rightarrow \mathcal{J}_G$.

The *tile* \mathcal{T} of the group G is the quotient of the topological space $X^{-\omega}$ by the equivalence relation in which two left-infinite sequences $\dots x_2x_1, \dots y_2y_1 \in X^{-\omega}$ are equivalent if and only if there is a left-infinite path in the Moore diagram of the nucleus, which ends in the trivial state and is labeled by $\dots x_2x_1 | \dots y_2y_1$.

The tile \mathcal{T}_v is called the tile of $|v|$ -th level. There is precisely one tile of the zero level $\mathcal{T}_\emptyset = \mathcal{J}_G$. Tiles have the following properties:

1. Every tile \mathcal{T}_v is a compact subset of the space \mathcal{J}_G .
2. $s(\mathcal{T}_{vx}) = \mathcal{T}_v$ for every letter $x \in X$.
3. $\mathcal{T}_v = \bigcup_{x \in X} \mathcal{T}_{xv}$ for all $v \in X^*$.

In particular, the image of a tile of the n -th level under the map s is the union of $|X|$ tiles of the n -th level. The limit space \mathcal{J}_G is the union of all tiles of n -th level for every $n \geq 1$.

Proposition II.19 ([Nek05, Proposition 3.6.8]). *Let \mathcal{N} be the nucleus of the group G . Two tiles \mathcal{T}_v and \mathcal{T}_u of the same level $|v| = |u|$ have a non-empty intersection if and only if there exists $h \in \mathcal{N}$ such that $h(v) = u$.*

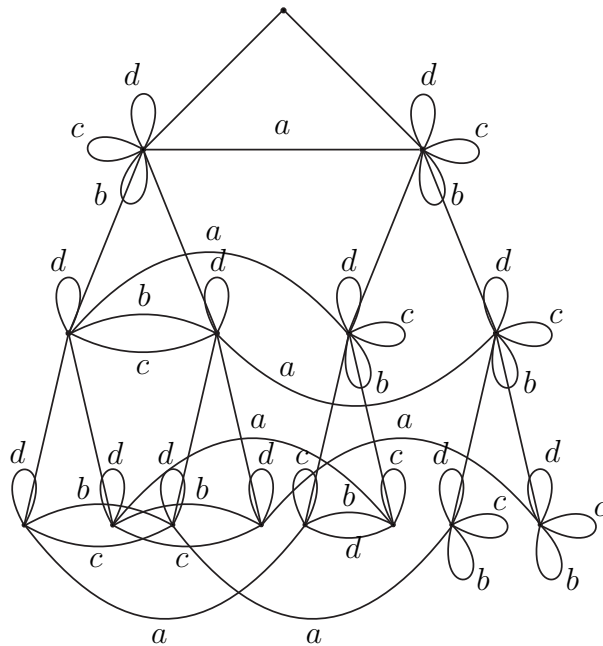

Fig. 3. The Schreier graphs $\Gamma_1, \Gamma_2, \Gamma_3$ of the Grigorchuk group drawn on the tree

The last proposition shows that two tiles \mathcal{T}_v and \mathcal{T}_u for $v, u \in X^n$ intersect if and only if the vertices v and u are adjacent in the Schreier graph $\Gamma_n(\mathcal{N})$.

It is said that a contracting self-similar group satisfies *the open set condition* if for every element g of the nucleus there exists a finite word $v \in X^*$ such that $g|_v = 1$.

Theorem II.20 ([Nek05, Proposition 3.6.5]). *If a contracting group satisfies the open set condition then every tile is the closure of its interior, any two distinct tiles of the same level have disjoint interiors, and the boundary of the tile \mathcal{T}_v is equal to the set*

$$\partial\mathcal{T}_v = \mathcal{T}_v \cap \bigcup_{u \in X^{|v|}, u \neq v} \mathcal{T}_u$$

for every $v \in X^*$.

If the group does not satisfy the open set condition, then every tile is covered by the other tiles of the same level.

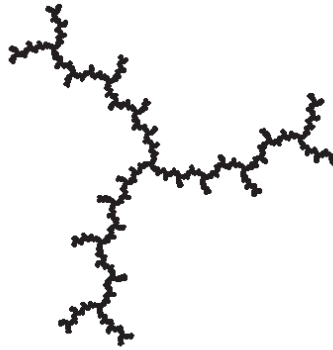

Fig. 4. The limit space of the Gupta-Fabrikovsky group

Corollary II.21. *If a contracting group satisfies the open set condition, then a sequence $\dots x_2 x_1 v \in X^{-\omega} v$ represents a point of the boundary of the tile \mathcal{T}_v if and only if the sequence $\dots x_2 x_1$ is read on a left-infinite path in the Moore diagram of the nucleus, which ends in the state $h \in \mathcal{N}$ with $h(v) \neq v$.*

The limit space \mathcal{J}_G can be viewed as a hyperbolic boundary in the following way. Let G be a finitely generated self-similar group. For any given finite generating set S of G define the self-similarity graph $\Sigma(G, S)$ as the graph with set of vertices X^* in which two vertices $v_1, v_2 \in X^*$ are connected by an edge if and only if either $v_i = x v_j$ for some $x \in X$ (vertical edges), or $s(v_i) = v_j$ for some $s \in S$ (horizontal edges). See the beginning of the self-similarity graph of the Grigorchuk group in Figure 3.

Theorem II.22 ([Nek03], see also [Nek05, Theorem 3.8.8]). *The self-similarity graphs $\Sigma(G, S)$ and $\Sigma(G, S')$, where S and S' are finite generating sets of the group G , are quasi-isometric. If the group G is contracting then the self-similarity graph $\Sigma(G, S)$ is a Gromov-hyperbolic space and its hyperbolic boundary is homeomorphic to the limit space \mathcal{J}_G .*

The previous theorem shows that the Schreier graphs $\Gamma_n(G, S)$ can be used to

approximate and identify the limit space \mathcal{J}_G . Another way to see this is given in [Nek05, Section 3.6.3].

Example 3. The Schreier graphs of the Grigorchuk group are described in [BG00a]. From this description follows that the limit space \mathcal{J}_G of the Grigorchuk group is homeomorphic to the closed interval $[0, 1]$ (see also [Nek05, BGN03]).

The limit space of the Gupta-Fabrikovsky group is shown in Figure 4.

Many other examples of limit spaces are considered in [Nek05, BGN03].

CHAPTER III

DYNAMICS OF PIECEWISE LINEAR MAPS

In this chapter, following the ideas of W.H.M. Zijm from [Zij84], we consider piecewise linear maps of the form $f_{\mathcal{K}}(v) = \min_{A \in \mathcal{K}} Av$, where \mathcal{K} is a finite set of nonnegative matrices and by “min” we mean component-wise minimum. We study spectral properties and iterations of the maps $f_{\mathcal{K}}$. We introduce the notions of \succcurlyeq -minimal matrix for a set \mathcal{K} and principal \succcurlyeq -minimal partition of the set of indices $\{1, 2, \dots, N\}$. We give algorithmic criterium for the existence of a strictly positive eigenvector of $f_{\mathcal{K}}$. The main result proves the existence of nonnegative generalized eigenvectors of $f_{\mathcal{K}}$, whose special components are strictly positive. This allows us to show that for a \succcurlyeq -minimal matrix A the asymptotic relation $f_{\mathcal{K}}^n(v) \sim A^n v$ holds for any strictly positive vector v . As an intermediate result we get a generalization of the Howard’s policy iteration method.

1 Nonnegative matrices

In this section we introduce all necessary definitions, notations, and results used in the chapter. For the references, see [Gan59, BP94, Sen73, BR97].

All matrices, unless otherwise stated, will be squared of a fixed dimension $N \geq 1$. The set $\{1, 2, \dots, N\}$ is called the *state space* and denoted by S . The elements of S (indices of matrices) are called *states*.

Denote by A_i the i -th row of a matrix A and by v_i the i -th component of a vector v . The transpose matrix of A is denoted by A^t . If $S_1, S_2 \subset S$ then we denote by $A|_{(S_1, S_2)}$ the matrix obtained by restricting the matrix A to $S_1 \times S_2$ and by $v|_{S_1}$ the restriction of the vector v to S_1 .

A matrix $A = (a_{ij})$ is *nonnegative* ($A \geq 0$) if $a_{ij} \geq 0$ for all i, j . A matrix $A = (a_{ij})$ is *positive* ($A > 0$) if $a_{ij} > 0$ for all i, j . A vector v is *nonnegative* ($v \geq 0$) if $v_i \geq 0$ for all i . A vector v is *strictly positive* ($v > 0$) if $v_i > 0$ for all i . We write

$$\begin{aligned} A \geq B & \quad \text{if} \quad A - B \geq 0 \quad (a_{ij} \geq b_{ij} \text{ for all } i, j), \\ v \geq u & \quad \text{if} \quad v - u \geq 0 \quad (v_i \geq u_i \text{ for all } i), \end{aligned}$$

where matrices A, B and vectors v, u are of compatible dimensions.

A *permutation matrix* is a matrix obtained by permuting the rows of the identity matrix (denoted by I). Every row and every column of a permutation matrix contains exactly one non-zero entry equal to one.

The spectral radius of a matrix A is denoted by $\text{spr}(A)$.

The n -th iteration of a map $f : \mathbb{R}^N \rightarrow \mathbb{R}^N$ is denoted by $f^n(v) = f(f(\dots f(v)\dots))$.

1.1 Perron-Frobenius Theorem and its generalizations

In 1912 Ferdinand Georg Frobenius (1849 – 1917) introduced the following notion.

Definition 10. A nonnegative matrix A is called *reducible* if there exists a partition of the state space $S = S_1 \cup S_2$, $S_1 \cap S_2 = \emptyset$, such that $A|_{(S_1, S_2)} = 0$, or if $N = 1$ and $A = 0$. Otherwise the matrix A is called *irreducible*.

In other words, a nonnegative matrix A is reducible if there exists a permutation matrix P such that

$$PAP^t = \begin{pmatrix} B & C \\ 0 & D \end{pmatrix},$$

where B and D are (non-empty) square matrices, i.e. there is a nontrivial A -invariant subspace, whose base is the subset of the standard base of \mathbb{R}^N .

Irreducibility has the following combinatorial characterization. We say that a state i has access to a state j (in matrix A) if there exists a nonnegative integer n such that the ij -th entry of A^n is positive. This notion can be interpreted in graph-theoretical terms. Every nonnegative matrix A has an *associated directed graph* $\Gamma(A)$ with the set of vertices S , which has an edge from i to j if and only if $a_{ij} > 0$. In this situation the matrix A is called the *incidence matrix* of the graph $\Gamma(A)$. Then a state i has access to a state j under A if and only if there exists a directed path in $\Gamma(A)$ from i to j . A directed graph Γ is called *strongly connected* if for every ordered pair (v, u) of its vertices there exists a directed path which starts at v and ends at u .

Proposition III.1. *A nonnegative matrix A is irreducible if and only if the graph $\Gamma(A)$ is strongly connected.*

In his original paper F. G. Frobenius proved the following theorem, which was a nontrivial generalization of the famous theorem on the leading eigenvalue of a positive matrix by Oskar Perron (1880 – 1975). This theorem is central in the theory of nonnegative matrices, which is also called the Perron-Frobenius theory.

Theorem III.2 (Perron-Frobenius). *Let A be a nonnegative irreducible matrix with spectral radius λ . Then*

1. $\lambda > 0$ is an eigenvalue of A . Moreover, λ is a simple root of the characteristic polynomial.
2. There exists a strictly positive eigenvector v associated with λ . Moreover, the only nonnegative eigenvectors of A are scalar multiples of v .

The number λ and vector v from the theorem are usually called *the Perron eigenvalue* and *the Perron eigenvector*.

We also need the following properties of irreducible matrices.

Theorem III.3. *Let A be an irreducible matrix with spectral radius λ . Then*

1. $(\sigma I - A)^{-1}$ is a positive matrix for any $\sigma > \lambda$.
2. $(I + A)^{N-1}$ is a positive matrix.
3. If $Au \geq \lambda u$ or $Au \leq \lambda u$ for some vector $u \geq 0$ then $Au = \lambda u$.
4. The spectral radius of $A|_{(\mathcal{C}, \mathcal{C})}$ is less than λ for any subset $\mathcal{C} \subsetneq S$.

Some of the results about irreducible matrices can be easily generalized to all nonnegative matrices by considering a nonnegative matrix as a limit of positive (and thus irreducible) matrices. Since strict inequalities are not preserved by a limiting process, the results for nonnegative matrices are weaker. We summarize some needed properties of nonnegative matrices in

Theorem III.4. *Let A be a nonnegative matrix with spectral radius λ . Then*

1. $\lambda \geq 0$ is an eigenvalue of A .
2. There exists a nonnegative eigenvector v associated with λ .
3. The spectral radius of $A|_{(\mathcal{C}, \mathcal{C})}$ is not greater than λ for any subset $\mathcal{C} \subsetneq S$ and is equal to λ for some subset $\mathcal{C} \subsetneq S$.
4. If $Au \geq \sigma u$ for some real number σ and a real vector u with at least one positive component, then $\lambda \geq \sigma$.

Proof. The items 1, 2, 3 are well-known. For the item 4 see [Zij84, Lemma 2.5]. \square

1.2 Block-triangular structure of nonnegative matrices

If a nonnegative matrix is reducible then it admits a special block-triangular structure, which plays an important role in description of algebraic eigenspaces of the matrix and its iterations. We describe this following [BP94, Zij84].

A *class* of a nonnegative matrix A is a subset \mathcal{C} of the state space S such that $A|_{(\mathcal{C},\mathcal{C})}$ is irreducible and such that \mathcal{C} cannot be enlarged without destroying the irreducibility. A class \mathcal{C} is called *basic* if $\text{spr}(A|_{(\mathcal{C},\mathcal{C})}) = \text{spr}(A)$, otherwise *non-basic* (then $\text{spr}(A|_{(\mathcal{C},\mathcal{C})}) < \text{spr}(A)$ by Theorem III.3 item 4). It follows that for any matrix A we have a partition of the state space S into classes, say $\mathcal{C}_1, \mathcal{C}_2, \dots, \mathcal{C}_n$. Then, after possibly permuting the states and renumbering the classes, A can be written in the form, sometimes called *the Frobenius Normal Form*,

$$A = \begin{pmatrix} A_{(1,1)} & A_{(1,2)} & \dots & A_{(1,n)} \\ 0 & A_{(2,2)} & \dots & A_{(2,n)} \\ 0 & 0 & \ddots & \vdots \\ 0 & 0 & 0 & A_{(n,n)} \end{pmatrix},$$

where $A_{(i,j)}$ denotes the matrix $A|_{(\mathcal{C}_i, \mathcal{C}_j)}$.

Now we can partially order classes by accessibility relation. We say that a class \mathcal{C} has *access to (from)* a class \mathcal{C}' if there is an access to (from) some (or equivalently any) state in \mathcal{C} to some (or equivalently any) state in \mathcal{C}' . A class \mathcal{C} is called *final* if it has no access to any other class.

The spectral radius of $A|_{(\mathcal{C},\mathcal{C})}$ is called *the spectral radius of the class \mathcal{C}* .

The Frobenius Normal Form shows that the spectrum of the matrix A is the union of the spectra of matrices $A|_{(\mathcal{C},\mathcal{C})}$ over all the classes \mathcal{C} of A . In particular, the spectral radius of A is the maximal spectral radius of its classes.

Theorem III.5 ([BP94], Theorem 3.10). *A nonnegative matrix A possesses a strictly positive eigenvector if and only if the basic classes of A are precisely its final classes.*

Notice, that even if a nonnegative matrix has a strictly positive eigenvector, the last part of the Perron-Frobenius Theorem does not hold — it may not be unique up to a scalar multiple. Similarly to the previous theorem one gets the following result.

Proposition III.6. *A nonnegative matrix A possesses a unique, up to a scalar multiple, strictly positive eigenvector if and only if A has only one basic class, which is the only final class.*

Already these results indicate importance of the position of basic and non-basic classes of a nonnegative matrix A . These positions can be defined precisely using the concept of a chain. A *chain of classes* of A is an ordered collection of classes $\{\mathcal{C}_1, \mathcal{C}_2, \dots, \mathcal{C}_n\}$ such that \mathcal{C}_i has access to \mathcal{C}_{i+1} , $i = 1, 2, \dots, n - 1$. The *length of a chain* is the number of basic classes it contains. The *depth of a class \mathcal{C}* is the length of the longest chain that starts with \mathcal{C} . The *degree $\nu(A)$* of the matrix A is the length of its longest chain.

Definition 11. The partition $\{S_0, S_1, \dots, S_\nu\}$ of the state space S , where S_i is the union of all classes of depth i , is called the *principal partition* of S with respect to A .

Principal partitions play a fundamental role in this chapter.

The next proposition follows directly from the definition of a principal partition.

Proposition III.7. *Let $\{S_0, S_1, \dots, S_\nu\}$ be the principal partition of S with respect to A . Then, after possibly permuting the states, A can be written in the form*

$$A = \begin{pmatrix} A_{(\nu,\nu)} & A_{(\nu,\nu-1)} & \dots & A_{(\nu,0)} \\ 0 & A_{(\nu-1,\nu-1)} & \dots & A_{(\nu-1,0)} \\ 0 & 0 & \ddots & \vdots \\ 0 & 0 & 0 & A_{(0,0)} \end{pmatrix},$$

where $A_{(i,j)}$ denotes $A|_{(S_i, S_j)}$. We have $\text{spr}(A_{(i,i)}) = \text{spr}(A)$ for $i = 1, 2, \dots, \nu$, and $\text{spr}(A_{(0,0)}) < \text{spr}(A)$ if S_0 is not empty. Each state in S_{i+1} has access to some state in S_i for $i = 1, 2, \dots, \nu - 1$.

Remark III.8. Notice that for $i = 1, 2, \dots, \nu$ the basic classes of the matrix $A|_{(S_i, S_i)}$ are precisely its final classes. Hence, $A|_{(S_i, S_i)}$ possesses a strictly positive eigenvector by Theorem III.5.

We need the following useful lemma.

Lemma III.9 ([Zij84, Lemma 2.5]). *Let A be a nonnegative matrix with spectral radius λ . If $Av \geq \lambda v$ with $v > 0$, then every final class of A is basic and $(Av)_i = \lambda v_i$ for every i in a final class of A .*

Matrices which possess strictly positive eigenvectors have the following additional properties.

Lemma III.10. *Let A be a nonnegative matrix which has a strictly positive eigenvector. Let $S_1 \subset S$ be the union of all final classes of A . If $Au = \lambda u$ for some vector u with $u|_{S_1} > 0$ then u is strictly positive.*

Proof. Let $\{\mathcal{C}_1, \mathcal{C}_2, \dots, \mathcal{C}_m\}$ be the partition of $S \setminus S_1$ on classes. Then $\{S_1, \mathcal{C}_1, \dots, \mathcal{C}_m\}$ is the partition of S and, after possibly permuting the states and renumbering the classes, A can be written in the form:

$$A = \begin{pmatrix} A_{(\mathcal{C}_1, \mathcal{C}_1)} & A_{(\mathcal{C}_1, \mathcal{C}_2)} & \dots & A_{(\mathcal{C}_1, S_1)} \\ 0 & A_{(\mathcal{C}_2, \mathcal{C}_2)} & \dots & A_{(\mathcal{C}_2, S_1)} \\ 0 & 0 & \ddots & \vdots \\ 0 & 0 & 0 & A_{(S_1, S_1)} \end{pmatrix}.$$

Each class \mathcal{C}_i has access to some state in S_1 , which is equivalent to the condition that $A|_{(\mathcal{C}_i, S \setminus \mathcal{C}_i)} \neq 0$ for all $i = 1, 2, \dots, m$.

The set S_1 contains all basic classes of A by Theorem III.5, so $\text{spr}(A|_{(\mathcal{C}_i, \mathcal{C}_i)}) < \lambda$. We know that $u|_{S_1} > 0$. Assume by induction that we have proved that $u|_{S \setminus \mathcal{C}_1} > 0$.

Then

$$(Au)|_{\mathcal{C}_1} = A|_{(\mathcal{C}_1, \mathcal{C}_1)}u|_{\mathcal{C}_1} + A|_{(\mathcal{C}_1, S \setminus \mathcal{C}_1)}u|_{S \setminus \mathcal{C}_1} = \lambda u|_{\mathcal{C}_1}.$$

The matrix $(\lambda I - A|_{(\mathcal{C}_1, \mathcal{C}_1)})^{-1}$ is positive by Theorem III.3 item 1. Hence

$$u|_{\mathcal{C}_1} = (\lambda I - A|_{(\mathcal{C}_1, \mathcal{C}_1)})^{-1}A|_{(\mathcal{C}_1, S \setminus \mathcal{C}_1)}u|_{S \setminus \mathcal{C}_1} > 0.$$

□

Lemma III.11 ([Zij84, Lemma 2.3]). *Let A be a nonnegative matrix with spectral radius λ which possesses a strictly positive eigenvector. Then:*

1. *There exists a nonnegative matrix A^* defined by:*

$$A^* = \lim_{n \rightarrow \infty} \frac{1}{n+1} \sum_{i=0}^n \lambda^{-i} A^i.$$

We have $AA^ = A^*A = \lambda A^*$ and $(A^*)^2 = A^*$. Moreover, $a_{ij}^* > 0$ if and only if j belongs to a final (basic) class of A and i has access to j under A .*

2. *The matrix $\lambda I - A + A^*$ is non-singular.*
3. *If $A^*v = 0$ for some vector $v \geq 0$ (or $v \leq 0$), then $v_i = 0$ for every state i belonging to a final (basic) class of A .*
4. *If $Av \geq \lambda v$ for some vector v then $A^*v \geq v$.*
*If $Av \leq \lambda v$ for some vector v then $A^*v \leq v$.*

Notice that if A is a (reducible) stochastic matrix then A^* is a limiting transition probability matrix and the inverse of $(I - A + A^*)$ is the so-called fundamental matrix of the respective Markov chain.

1.3 Generalized eigenvectors and algebraic eigenspaces

Let A be a nonnegative matrix with spectral radius λ . The smallest nonnegative integer n such that the sequence of null spaces stabilizes

$$\text{Null}(A - \lambda I) \subsetneq \text{Null}(A - \lambda I)^2 \subsetneq \cdots \subsetneq \text{Null}(A - \lambda I)^n = \text{Null}(A - \lambda I)^{n+1},$$

is called the *index* $\eta(A)$ of A with respect to the eigenvalue λ . The index of an irreducible matrix is one. The null space $\text{Null}(A - \lambda I)^{\eta(A)}$ is called the *algebraic eigenspace* of A and its elements are called *generalized eigenvectors* of A . The algebraic eigenspace of an irreducible matrix is one dimensional (it consists of zero and the eigenvectors corresponding to λ). A generalized eigenvector has order i if it belongs to $\text{Null}(A - \lambda I)^{i+1} \setminus \text{Null}(A - \lambda I)^i$. Generalized eigenvectors of order 0 are precisely the eigenvectors associated with λ .

Uriel G. Rothblum gave a combinatorial characterization of the index corresponding to the spectral radius.

Theorem III.12 ([Rot75], see also [BP94]). *Let A be a nonnegative matrix with spectral radius λ . The index of A with respect to λ is equal to the degree of A , i.e. $\eta(A) = \nu(A)$.*

Moreover, it was shown that the algebraic eigenspace corresponding to the spectral radius contains a nonnegative vector with the largest number of positive coordinates among all vectors in this subspace.

Theorem III.13 ([Rot75], see also [BP94]). *Let A be a nonnegative matrix with spectral radius λ . Let $\{S_0, S_1, \dots, S_\nu\}$ be the principal partition of S with respect to A . Then there exists a set of nonnegative generalized eigenvectors $v^{(1)}, v^{(2)}, \dots, v^{(\nu)}$*

such that

$$\begin{aligned} Av^{(\nu)} &= \lambda v^{(\nu)}, \\ Av^{(i)} &= \lambda v^{(i)} + v^{(i+1)}, \quad i = \nu - 1, \dots, 2, 1. \end{aligned}$$

Moreover

$$v_j^{(i)} > 0, \quad j \in \bigcup_{k=i}^{\nu} S_k \quad \text{and} \quad v_j^{(i)} = 0, \quad j \in \bigcup_{k=0}^{i-1} S_k,$$

for $i = 1, 2, \dots, \nu$.

One of our main goals in this chapter is to generalize the previous theorem to the maps $f_{\mathcal{X}}$, as it was done in [Zij84] for the maps $g_{\mathcal{X}}$.

1.4 Iterations of nonnegative matrices

Iterations of a square matrix, in particular the asymptotic behavior of their coordinates, can be easily described using the Jordan normal form of the matrix. If the matrix is nonnegative then the iterations mainly depend on the position of positive entries in the matrix and there is a combinatorial description using notions of classes and chains of classes. This description will be used to prove similar results about the iterations of the maps $f_{\mathcal{X}}$.

We study the asymptotic behavior of iterations $A^n v$ and $f_{\mathcal{X}}^n(v)$ with respect to the equivalence relation defined at the end of Section 6 of Chapter II. Notice that if h is a homogeneous monotone map (in particular a nonnegative matrix) then $h^n(v) \sim h^n(u)$ for any strictly positive vectors $v, u > 0$ (and in general for any nonnegative vectors with the same sets of positive states). Really, choose real numbers $a, b > 0$ such that $av \leq u \leq bv$. Then

$$ah^n(v) \leq h^n(u) \leq bh^n(v),$$

for all $n \geq 1$. Hence we can and will change one strictly positive vector to another

one considering asymptotic behavior of such maps if it is necessary.

The following lemma is useful.

Lemma III.14. *For any integer $k \geq 0$ and real $\lambda, \beta > 0$ we have asymptotic relation*

$$\sum_{i=0}^n \beta^{n-i} i^k \lambda^i \sim \begin{cases} n^k \lambda^n, & \text{if } \lambda > \beta; \\ n^{k+1} \lambda^n, & \text{if } \beta = \lambda. \end{cases}$$

Proof. The asymptotic relation $\sum_{i=0}^n i^k \sim n^{k+1}$ is well known. Then in case $\lambda = \beta$:

$$\sum_{i=0}^n \beta^{n-i} i^k \lambda^i = \lambda^n \sum_{i=0}^n i^k \sim n^{k+1} \lambda^n;$$

and in case $\lambda > \beta$ we have inequalities

$$\begin{aligned} n^k \lambda^n &\leq \sum_{i=0}^n \beta^{n-i} i^k \lambda^i = \beta^n \sum_{i=0}^n i^k \left(\frac{\lambda}{\beta}\right)^i \leq \beta^n n^k \sum_{i=0}^n \left(\frac{\lambda}{\beta}\right)^i = \\ &= \beta^n n^k \frac{\left(\frac{\lambda}{\beta}\right)^{n+1} - 1}{\frac{\lambda}{\beta} - 1} \leq n^k \frac{\lambda^{n+1}}{\lambda - \beta}, \end{aligned}$$

which prove the needed asymptotic relation. \square

Theorem III.15. *Let A be a nonnegative matrix with spectral radius λ . Let $\{S_0, S_1, \dots, S_\nu\}$ be the principal partition of S with respect to A . Then*

$$(A^n v)_i \sim n^{k-1} \lambda^n, \quad \text{for } i \in S_k \text{ and } k = 1, 2, \dots, \nu,$$

for any strictly positive vector v (even for a nonnegative vector with $v|_{S \setminus S_0} > 0$).

Proof. Let $v^{(1)}, v^{(2)}, \dots, v^{(\nu)}$ be the nonnegative generalized eigenvectors that satisfy Theorem III.13. Let us show by induction from $i = \nu$ to $i = 1$ that

$$A^n v^{(i)} \sim \lambda^n \sum_{j=0}^{\nu-i} n^j v^{(i+j)} \quad \text{for all } i = 1, 2, \dots, \nu.$$

The basis of induction $i = \nu$ follows from $A^n v^{(\nu)} = \lambda^n v^{(\nu)}$. Suppose that the relation

holds for $i + 1$ and we want to prove it for i . Then

$$\begin{aligned}
A^n v^{(i)} &= \lambda A^{n-1} v^{(i)} + A^{n-1} v^{(i+1)} \sim \\
&\sim \lambda A^{n-1} v^{(i)} + \lambda^{n-1} \sum_{j=0}^{\nu-i-1} (n-1)^j v^{(i+1+j)} \sim \\
&\sim \lambda^n v^{(i)} + \lambda^{n-1} \sum_{l=1}^{n-1} \sum_{j=0}^{\nu-i-1} l^j v^{(i+1+j)} = \\
&= \lambda^n v^{(i)} + \lambda^{n-1} \sum_{j=0}^{\nu-i-1} \left(\sum_{l=1}^{n-1} l^j \right) v^{(i+1+j)} \sim (\text{by Lemma III.14}) \\
&\sim \lambda^n v^{(i)} + \lambda^n \sum_{j=0}^{\nu-i-1} n^{j+1} v^{(i+1+j)} = \lambda^n \sum_{j=0}^{\nu-i} n^j v^{(i+j)}.
\end{aligned}$$

Then for any nonnegative vector v such that $v|_{S \setminus S_0} > 0$ and $v|_{S_0} = 0$ the relations

$$(A^n v)_i \sim (A^n v^{(1)})_i \sim \lambda^n \sum_{j=0}^{\nu-1} n^j v_i^{(1+j)} = \lambda^n \sum_{j=0}^{k-1} n^j v_i^{(1+j)} \sim n^{k-1} \lambda^n$$

hold for $i \in S_k$ and $k = 1, 2, \dots, \nu$.

If S_0 is empty then we are done, otherwise notice that $\lambda > 0$ and denote $D = A|_{(S_0, S_0)}$, $C = A|_{(S \setminus S_0, S_0)}$, and $B = A|_{(S \setminus S_0, S \setminus S_0)}$. Notice that $D^n v \preceq \beta^n v$ for some $0 < \beta < \lambda$ and for any vector $v > 0$, because $\text{spr}(D) < \lambda$ by Proposition III.7.

For a strictly positive vector v define decomposition $v = u + w$, where nonnegative vectors u and w are defined by

$$\begin{aligned}
u|_{S \setminus S_0} &= v|_{S \setminus S_0} & \text{and} & & u|_{S_0} &= 0, \\
w|_{S \setminus S_0} &= 0 & \text{and} & & w|_{S_0} &= v|_{S_0}.
\end{aligned}$$

Then we have asymptotic relations

$$(A^n v)_i = (A^n u)_i + (A^n w)_i \sim (A^n v^{(1)})_i + (A^n w)_i \sim n^{k-1} \lambda^n + (A^n w)_i \sim n^{k-1} \lambda^n,$$

because

$$\begin{aligned}
(A^n w)_i &= \left(\sum_{j=0}^{n-1} B^j C D^{n-1-j} v|_{S_0} \right)_i \preceq \left(\sum_{j=0}^{n-1} B^j C \beta^{n-1-j} v|_{S_0} \right)_i \preceq \\
&\preceq \left(\sum_{j=0}^{n-1} B^j \beta^{n-1-j} v^{(1)}|_{S \setminus S_0} \right)_i \sim \sum_{j=0}^{n-1} \beta^{n-1-j} (A^j v^{(1)})_i \sim \\
&\sim \sum_{j=0}^{n-1} \beta^{n-1-j} j^{k-1} \lambda^j \sim (\text{ by Lemma III.14 }) \sim n^{k-1} \lambda^n,
\end{aligned}$$

for $i \in S_k$ and $k = 1, 2, \dots, \nu$. □

Theorem III.15 gives us combinatorial algorithm for finding the growth of each component of $A^n v$ for a strictly positive vector v . For states in S_k , $k = 1, 2, \dots, \nu$, it follows directly from the theorem. For the states $i \in S_0$ we apply the theorem to the matrix $A|_{(S_0, S_0)}$ with its spectral radius and principal partition, and so on.

This algorithm can be also described using chains of classes as follows. Take a state i and the corresponding class \mathcal{D} which contains i . Let β be the maximum of spectral radii of the classes \mathcal{C} , where \mathcal{C} runs through all the classes such that \mathcal{D} has access to \mathcal{C} . Consider all possible chains that start at \mathcal{D} and for each chain count the number of classes \mathcal{C} in this chain with spectral radius β . Let k be the maximum among such numbers. Then $(A^n v)_i \sim n^{k-1} \beta^n$ for any strictly positive vector v . In particular, if i belongs to a final class of A then $(A^n v)_i \sim \beta^n$, where β is the spectral radius of the final class.

Remark III.16. The \succsim -minimal behavior of $(A^n v)_i$ over all states i is $\sim \beta^n$, where β is the spectral radius of some final class. If a state i has access to a state j then $(A^n v)_j \preceq (A^n v)_i$. So, $(A^n v)_i \sim (A^n v)_j$ for any two states i and j in the same class.

As a corollary of the previous theorem, one gets an extension of Theorem III.5 in terms of asymptotic behavior of matrix iterations.

Theorem III.17. *Let A be a nonnegative matrix with spectral radius λ . The following conditions are equivalent:*

1. *The matrix A possesses a strictly positive eigenvector.*
2. *Basic classes of A are precisely its final classes.*
3. *$(A^n v)_i \sim \lambda^n$ for all i and for some (every) vector $v > 0$.*
4. *$(A^n v)_i \sim (A^n v)_j$ for all i, j and for some (every) vector $v > 0$.*

2 Product property of a set of nonnegative matrices

Fix an integer $N \geq 1$. Let \mathcal{K} be a finite set of nonnegative square matrices of dimension N . Consider

$$f(v) = f_{\mathcal{K}}(v) = \min_{A \in \mathcal{K}} Av, \quad g(v) = g_{\mathcal{K}}(v) = \max_{A \in \mathcal{K}} Av,$$

for $v \in \mathbb{R}^N$, where by “min” and “max” we mean component-wise minimum and maximum correspondingly.

Note that in general we do not have the property that for every $v \in \mathbb{R}^N$ there exists a matrix $A \in \mathcal{K}$ such that $f_{\mathcal{K}}(v) = Av$. The following concept eliminates this difficulty (compare with [Sen73, Section 3.1, page 59]).

Definition 12. Let \mathcal{K} be a set of nonnegative square matrices of dimension N . We say that \mathcal{K} satisfies the *product property* if for each subset $V \subseteq S = \{1, 2, \dots, N\}$ and for each pair of matrices $A, B \in \mathcal{K}$ the matrix C defined by

$$C_i := \begin{cases} A_i, & \text{if } i \in V; \\ B_i, & \text{if } i \in S \setminus V, \end{cases}$$

belongs to \mathcal{K} .

Every set \mathcal{K} that satisfies the product property can be given by a collection of admissible rows. Suppose we have any collection $\{\mathcal{R}_i, i \in S\}$, where \mathcal{R}_i is a set of nonnegative vectors (rows) of length N for each $i \in S$. Then the set \mathcal{K} of all matrices, whose i -th row is an element of \mathcal{R}_i for each $i \in S$, satisfies the product property. And vice versa, every set \mathcal{K} that satisfies the product property is given by a collection $\{\mathcal{R}_i, i \in S\}$, where $\mathcal{R}_i = \{A_i | A \in \mathcal{K}\}$ for every $i \in S$.

If we have any finite set \mathcal{K}_0 of nonnegative matrices then we can close it with respect to the product property and obtain another finite set $\mathcal{K} \supset \mathcal{K}_0$ which satisfies the product property. We just construct the set \mathcal{K} using the collection $\{\mathcal{R}_i, i \in S\}$, where $\mathcal{R}_i = \{A_i | A \in \mathcal{K}_0\}$ for $i \in S$. In other words, the set \mathcal{K} is the set of all matrices, whose i -th row is equal to the i -th row of some matrix in \mathcal{K}_0 for every $i \in S$.

Proposition III.18. *Let \mathcal{K}_0 be a finite set of nonnegative square matrices and let \mathcal{K} be the closure of the set \mathcal{K}_0 with respect to the product property. Then*

$$f_{\mathcal{K}_0}(v) = \min_{A \in \mathcal{K}_0} Av = \min_{A \in \mathcal{K}} Av = f_{\mathcal{K}}(v)$$

for any vector $v \in \mathbb{R}^N$.

Proof. Since $\mathcal{K}_0 \subset \mathcal{K}$, $f_{\mathcal{K}_0}(v) \geq f_{\mathcal{K}}(v)$. Suppose there exist $v \in \mathbb{R}^N$ and $i \in S$ such that $u_i > w_i$, where $u = f_{\mathcal{K}_0}(v)$ and $w = f_{\mathcal{K}}(v)$. Since the set \mathcal{K} is finite there exists a matrix $A \in \mathcal{K}$ such that $w_i = A_i v$. By the construction of the set \mathcal{K} there exists a matrix $B \in \mathcal{K}_0$ such that $B_i = A_i$. Then $u_i \leq B_i v = A_i v = w_i$ and we get a contradiction. \square

So we can extend our given set of matrices to a bigger one, which satisfies the product property, without changing the function f . Hence, in consideration of the map $f_{\mathcal{K}}$ we can (and will) always assume that \mathcal{K} possesses the product property.

Moreover, if \mathcal{K} satisfies the product property, then for every $v \in \mathbb{R}^N$ there exists

$A = A_v \in \mathcal{K}$ such that $f_{\mathcal{K}}(v) = Av$. In the theory of Markov decision processes this property is usually called the optimal choice property (see [How60, Bel57a]).

3 \succcurlyeq -minimal matrices and principal \succcurlyeq -minimal partition

Lemma III.19. *Let \mathcal{K} be a finite set of nonnegative matrices with the product property. Then there exist matrices $B \in \mathcal{K}$ and $C \in \mathcal{K}$ such that $B^n v \preceq A^n v \preceq C^n v$ for every matrix $A \in \mathcal{K}$ and all strictly positive vectors v .*

Proof. We will prove the existence of the matrix B . The proof of the existence of the corresponding matrix C goes similarly.

We use induction on dimension N . For $N = 1$ the statement is obvious. Suppose the lemma is correct for any set of nonnegative square matrices of dimension $< N$ with the product property. Let us fix a strictly positive vector $v > 0$.

For each $A \in \mathcal{K}$ and $i \in S$ we can find the asymptotic behavior of $(A^n v)_i$ using Theorem III.15. Define the set $\mathcal{K}' \subset \mathcal{K}$ of all matrices B in \mathcal{K} for which there exists $i \in S$ such that the growth of $(B^n v)_i$ is \succcurlyeq -minimal over all possible such sequences, i.e. $(B^n v)_i \preceq (A^n v)_j$ for all matrices $A \in \mathcal{K}$ and all $j \in S$. By Remark III.16 there exists some real number $\lambda \geq 0$ such that $(B^n v)_i \sim \lambda^n$. For each matrix $B \in \mathcal{K}'$ define

$$S_0(B) = \{j \in S \mid (B^n v)_j \sim \lambda^n\}$$

and $S_1(B) = S \setminus S_0(B)$. Suppose that some state i in $S_0(B)$ has access to some state j in $S_1(B)$. Then $(B^n v)_j \preceq (B^n v)_i$. Since the asymptotic behavior of $(B^n v)_i$ is \succcurlyeq -minimal, we have $(B^n v)_i \sim (B^n v)_j$. Hence $j \in S_0(B)$ and we have a contradiction. Thus no state in $S_0(B)$ has access to a state in $S_1(B)$, which means that $B|_{(S_0(B), S_1(B))} = 0$.

Observe that the spectral radius of every class of B from $S_0(B)$ is not greater

than λ . If a class \mathcal{C} from $S_0(B)$ is final then it has spectral radius λ . The converse is also true: a class \mathcal{C} from $S_0(B)$ with spectral radius λ is final. Really, suppose it is not final. Then it has access to a final class from $S_0(B)$. Thus there exists a chain which starts at \mathcal{C} and contains at least two classes with spectral radius λ . So, $(B^n v)_i \succcurlyeq n\lambda^n$ for all i in \mathcal{C} and we get a contradiction.

Let us show that \mathcal{K}' contains a matrix B with the biggest set $S_0(B)$, i.e. such that $S_0(B) \supset S_0(A)$ for any $A \in \mathcal{K}'$. It is sufficient to prove that for any two matrices $B, D \in \mathcal{K}'$ there exists $E \in \mathcal{K}'$ such that $S_0(E) \supset S_0(B) \cup S_0(D)$. Define E as follows: $E_i = B_i$ for $i \in S_0(B)$ and $E_i = D_i$ for $i \notin S_0(B)$. Then

$$E = \begin{pmatrix} D|_{(S_1(B), S_1(B))} & * \\ 0 & B|_{(S_0(B), S_0(B))} \end{pmatrix},$$

$E \in \mathcal{K}'$, and $S_0(E) \supset S_0(B)$, because $(E^n v)_i = (B^n v)_i$ for all $i \in S_0(B)$. In order to prove that $S_0(E)$ contains $S_0(D)$, it is sufficient to prove that each class \mathcal{C} of E , which belongs to $S_0(D) \setminus S_0(B)$ and has spectral radius λ , is final (if there is no such a class we are done). By construction, $E|_{(\mathcal{C}, \mathcal{C})} = D|_{(\mathcal{C}, \mathcal{C})}$ and \mathcal{C} belongs to some class \mathcal{C}' of D from $S_0(D)$. If $\mathcal{C} \neq \mathcal{C}'$ then $\text{spr}(D|_{(\mathcal{C}', \mathcal{C}')} > \text{spr}(D|_{(\mathcal{C}, \mathcal{C})}) = \text{spr}(E|_{(\mathcal{C}, \mathcal{C})}) = \lambda$ by Theorem III.3 item 4 and we have a contradiction with $\mathcal{C}' \subset S_0(D)$. Thus $\mathcal{C} = \mathcal{C}'$ and so $E|_{(\mathcal{C}, S \setminus \mathcal{C})} = D|_{(\mathcal{C}', S \setminus \mathcal{C}')} = 0$. Hence, the class \mathcal{C} is final and our claim is proved.

Choose $B \in \mathcal{K}'$ to be a matrix with the biggest set $S_0(B)$. Denote $S_0 = S_0(B)$ and $S_1 = S_1(B)$.

If $S_0 = S$ then the matrix B satisfies the condition of the lemma and we are done. Suppose that $S_1 \neq \emptyset$. The set $\mathcal{K}|_{(S_1, S_1)}$ satisfies the product property and we can apply induction to it. So there exists $D \in \mathcal{K}$ such that $(D|_{(S_1, S_1)})^n v|_{S_1} \preccurlyeq (A|_{(S_1, S_1)})^n v|_{S_1}$ for all $A \in \mathcal{K}$. Define a matrix E in the same way as above: $E_i = B_i$ for $i \in S_0$ and $E_i = D_i$ for $i \notin S_0$. We want to show that it satisfies the condition of the lemma.

As above $(E^n v)_i = (B^n v)_i$ for all $i \in S_0$. So $(E^n v)_i \preceq (A^n v)_i$ for every matrix $A \in \mathcal{K}$ and for all $i \in S_0$. We need to prove this relation for $i \in S_1$.

$$\begin{aligned} (E^n v)|_{S_1} &\leq (D|_{(S_1, S_1)})^n v|_{S_1} + \sum_{l=1}^{n-1} (D|_{(S_1, S_1)})^{n-l} D|_{(S_1, S_0)} (B|_{(S_0, S_0)})^l v|_{S_0} \preceq \\ &\preceq (D|_{(S_1, S_1)})^n v|_{S_1} + \sum_{l=1}^{n-1} (D|_{(S_1, S_1)})^{n-l} \lambda^l v|_{S_1} = \sum_{l=0}^{n-1} (D|_{(S_1, S_1)})^{n-l} \lambda^l v|_{S_1}. \end{aligned}$$

Fix a state $i \in S_1$ and let $((D|_{(S_1, S_1)})^n v|_{S_1})_i \sim n^k \beta^n$. Suppose $\beta < \lambda$. Then there exists $j \in S_1$ such that $((D|_{(S_1, S_1)})^n v|_{S_1})_j \sim \beta^n$. Then

$$(E^n v)_j \preceq \left(\sum_{l=0}^{n-1} (D|_{(S_1, S_1)})^{n-l} \lambda^l v|_{S_1} \right)_j \sim \sum_{l=0}^{n-1} \lambda^l \beta^{n-l} \sim \lambda^n$$

and therefore j must be in S_0 . We get a contradiction, hence $\beta \geq \lambda$. If $\beta > \lambda$ then

$$\begin{aligned} (E^n v)_i &\preceq \left(\sum_{l=0}^{n-1} (D|_{(S_1, S_1)})^{n-l} \lambda^l v|_{S_1} \right)_i \sim \sum_{l=0}^{n-1} \lambda^l (n-l)^k \beta^{n-l} \sim n^k \beta^n \sim \\ &\sim ((D|_{(S_1, S_1)})^n v|_{S_1})_i \preceq ((A|_{(S_1, S_1)})^n v|_{S_1})_i \preceq (A^n v)_i \end{aligned}$$

for every $A \in \mathcal{K}$.

Now suppose that $\beta = \lambda$. Let \mathcal{C}_i be the class of $D|_{(S_1, S_1)}$ that contains i . Then λ is the maximum of the spectral radii of $D|_{(S_1, S_1)|_{(\mathcal{C}, \mathcal{C})}}$, where \mathcal{C} runs through all the classes of $D|_{(S_1, S_1)}$ such that \mathcal{C}_i has access to \mathcal{C} . Also the maximal number of classes \mathcal{C} with $\text{spr}(D|_{(S_1, S_1)|_{(\mathcal{C}, \mathcal{C})}}) = \lambda$ in chains that start at \mathcal{C}_i is k . If the maximum of spectral radii of $D|_{(\mathcal{C}, \mathcal{C})}$, where \mathcal{C}_i has access to \mathcal{C} , is greater than λ , then $(D^n v)_i \succ n^{k+1} \lambda^n$. If not then the maximal number of classes \mathcal{C} of B with $\text{spr}(D|_{(\mathcal{C}, \mathcal{C})}) = \lambda$ in a chain that starts at \mathcal{C}_i is at least $k + 1$, otherwise there exists a state j in S_1 with $(E^n v)_j \sim \lambda^n$. Thus, $(D^n v)_i \succ n^{k+1} \lambda^n$. Notice that the above statement is true for any matrix

$A \in \mathcal{K}$, i.e. if $((A|_{(S_1, S_1)})^n v|_{S_1})_i \sim n^k \lambda^n$ then $(A^n v)_i \succcurlyeq n^{k+1} \lambda^n$. Then

$$(E^n v)_i \preccurlyeq \sum_{l=0}^{n-1} (D|_{(S_1, S_1)})^{n-l} \lambda^l v|_{S_1} \sim \sum_{l=0}^{n-1} \lambda^l (n-l)^k \lambda^{n-l} \sim n^{k+1} \lambda^n \preccurlyeq (A^n v)_i$$

for any $A \in \mathcal{K}$. So $(E^n v)_i \preccurlyeq (A^n v)_i$ for all $i \in S$ and $A \in \mathcal{K}$. \square

Definition 13. Every matrix $B \in \mathcal{K}$ ($C \in \mathcal{K}$) which satisfies Lemma III.19 will be called \succcurlyeq -minimal (correspondingly \succcurlyeq -maximal) for the set \mathcal{K} .

If the set \mathcal{K} does not satisfy the product property, then a matrix is called \succcurlyeq -minimal (\succcurlyeq -maximal) for \mathcal{K} if it is \succcurlyeq -minimal (\succcurlyeq -maximal) for the closure of \mathcal{K} with respect to the product property. In this case these matrices may not belong to \mathcal{K} .

Notice, that $f_{\mathcal{K}}^n(v) \preccurlyeq A^n v$ for every matrix $A \in \mathcal{K}$ and every strictly positive vector v . In particular it is true for a \succcurlyeq -minimal matrix and it does not follow from the previous lemma that iterations of the map $f_{\mathcal{K}}$ and of a \succcurlyeq -minimal matrix have the same asymptotic behavior. It will be proved later (see Theorem III.28) and will follow from the existence of nonnegative generalized eigenvectors of $f_{\mathcal{K}}$ (see Theorem III.27).

There is a simple (but not effective) algorithm to find all \succcurlyeq -minimal (\succcurlyeq -maximal) matrices for a given set \mathcal{K} . We find the asymptotic behavior of $(A^n v)_i$ for every matrix $A \in \mathcal{K}$ using Theorem III.15 and take matrices with \succcurlyeq -minimal (respectively \succcurlyeq -maximal) growth.

Notice that the principal partitions, spectral radii, and degrees of every two \succcurlyeq -minimal (\succcurlyeq -maximal) matrices coincide, which follows from Theorem III.15 and from the fact that $A^n v \sim B^n v$ for all \succcurlyeq -minimal (\succcurlyeq -maximal) matrices $A, B \in \mathcal{K}$ and $v > 0$. Also note that by Theorem III.5 if one \succcurlyeq -minimal (\succcurlyeq -maximal) matrix possesses a strictly positive eigenvector then all \succcurlyeq -minimal (\succcurlyeq -maximal) matrices do.

Definition 14. The principal partition $\{S_0, S_1, \dots, S_\nu\}$ of a \succcurlyeq -minimal (\succcurlyeq -maximal) matrix is called the *principal \succcurlyeq -minimal partition* (correspondingly the *principal \succcurlyeq -*

maximal partition) of S with respect to \mathcal{K} .

Proposition III.20. *Suppose the set \mathcal{K} satisfies the product property. Let matrices B and C be respectively \succsim -minimal and \succsim -maximal for \mathcal{K} . Then*

$$\begin{aligned} \text{spr}(B) &= \min_{A \in \mathcal{K}} \text{spr}(A), & \nu(B) &= \min\{\nu(A) \mid A \in \mathcal{K} : \text{spr}(A) = \text{spr}(B)\}, \\ \text{spr}(C) &= \max_{A \in \mathcal{K}} \text{spr}(A), & \nu(C) &= \max\{\nu(A) \mid A \in \mathcal{K} : \text{spr}(A) = \text{spr}(C)\}. \end{aligned}$$

Proof. Let $\lambda = \text{spr}(B)$ and $\mu = \min_{A \in \mathcal{K}} \text{spr}(A)$. Since \mathcal{K} is finite, $\mu = \text{spr}(D)$ for some $D \in \mathcal{K}$. Since $B \in \mathcal{K}$, $\lambda \geq \mu$. Suppose $\lambda > \mu$. By Theorem III.15 there exists $i \in S$ such that $(B^n v)_i \sim \lambda^n$ for every vector $v > 0$. But

$$(D^n v)_i \preccurlyeq \text{Poly}(n)\mu^n \prec \lambda^n \sim (B^n v)_i$$

for every vector $v > 0$ and we get a contradiction with the \succsim -minimality of B .

Now let $e = \nu(B)$ and $r = \min\{\nu(A) \mid A \in \mathcal{K} : \text{spr}(A) = \lambda\}$. Since \mathcal{K} is finite, $r = \nu(D)$ for some $D \in \mathcal{K}$ with $\text{spr}(D) = \lambda$. Suppose $e > r$. By Theorem III.15 there exists $i \in S$ such that $(B^n v)_i \sim n^{e-1} \lambda^n$ for every vector $v > 0$. But

$$(D^n v)_i \preccurlyeq n^{r-1} \lambda^n \prec n^{e-1} \lambda^n \sim (B^n v)_i$$

for every vector $v > 0$ and we get a contradiction with the \succsim -minimality of B .

Similarly for the \succsim -maximal matrix C . □

Denote $\lambda_{\mathcal{K}} = \text{spr}(B)$ and $\nu_{\mathcal{K}} = \nu(B)$ for the matrix B , which is \succsim -minimal for \mathcal{K} .

4 Existence of strictly positive eigenvector of $f_{\mathcal{K}}$

The first result about existence of a strictly positive eigenvector for the maps $g_{\mathcal{K}}$ belongs to Richard Bellman. Using the Brouwer fixed point theorem he proved the existence of a strictly positive eigenvector for the map $g_{\mathcal{K}}$ in the case when each matrix

in \mathcal{K} is strictly positive (see [Bel56] and [Bel57a, chapter XI, sections 10 – 11]) and in this case he studied the asymptotic behavior of iterations of $g_{\mathcal{K}}$. He also studied the asymptotic behavior of $g_{\mathcal{K}}^n$ in the special case when \mathcal{K} contains only strictly positive Markoff matrices (see [Bel57b]). These results were generalized to the set of irreducible matrices by P. Mandl and E. Seneta [MS69]. A simple proof of this result was obtained by W.H.M. Zijm [Zij84]. His proof also works for the maps $f_{\mathcal{K}}$.

Proposition III.21. *Let \mathcal{K} be a set of irreducible matrices with the product property. Then the map $f_{\mathcal{K}}$ possesses a strictly positive eigenvector associated with $\lambda_{\mathcal{K}} = \min_{A \in \mathcal{K}} \text{spr}(A)$. Moreover, it is unique up to a scalar multiple.*

Proof. Take any $B \in \mathcal{K}$. Let λ_B be the spectral radius of B and let v be the corresponding strictly positive eigenvector. Find $D \in \mathcal{K}$ such that

$$Dv = \min_{A \in \mathcal{K}} Av$$

and we choose D_i to be equal to B_i if the row B_i also minimizes the i -th coordinate, i.e. if $(Bv)_i \leq (Av)_i$ for all $A \in \mathcal{K}$.

If $D = B$ then $f_{\mathcal{K}}(v) = Bv = \lambda_B v$ and we are done.

If $D \neq B$ then $Dv \prec Bv = \lambda_B v$ and $\lambda_D = \text{spr}(D) < \lambda_B$ by Theorem III.3 item 3. Apply the same procedure for the matrix D with its strictly positive eigenvector u associated with λ_D . Since \mathcal{K} is finite, after a finite number of steps we will reach a matrix D with spectral radius λ and eigenvector w such that

$$Dw = \min_{A \in \mathcal{K}} Aw = \lambda w.$$

Since we could start with an arbitrary matrix in \mathcal{K} , in particular with a matrix with the spectral radius $\min_{A \in \mathcal{K}} \text{spr}(A)$, the number λ above is equal to $\lambda_{\mathcal{K}}$.

Now suppose that the eigenvector is not unique up to a scalar multiple. Then

$f(v) = \lambda v$ and $f(u) = \lambda u$ for linear independent and strictly positive vectors v and u . Then f has an infinite number of linearly independent strictly positive eigenvectors. Since the set \mathcal{K} is finite, there exists an irreducible matrix $A \in \mathcal{K}$ with two strictly positive eigenvectors, which are linearly independent. We have a contradiction with Theorem III.2 item 2. \square

The maps $f_{\mathcal{K}}$ and $g_{\mathcal{K}}$ are homogeneous and monotone, hence we can and will change one strictly positive vector to another one considering asymptotic behavior of their iterations.

The following corollary gives the necessary condition for the existence of a strictly positive eigenvector of the map $f_{\mathcal{K}}$. Moreover, it will follow from Corollary III.29 that this condition is also sufficient.

Corollary III.22. *If $f_{\mathcal{K}}$ possesses a strictly positive eigenvector, then the following asymptotic relation holds*

$$(f_{\mathcal{K}}^n(v))_i \sim \lambda_{\mathcal{K}}^n$$

for some (every) strictly positive vector v and every state $i \in S$.

The next proposition gives a sufficient condition for the existence of a strictly positive eigenvector for the map $f_{\mathcal{K}}$. Moreover, it will follow from Corollary III.29 that this condition is also necessary.

Proposition III.23. *Suppose that some (every) \succcurlyeq -minimal matrix possesses a strictly positive eigenvector. Then the map $f_{\mathcal{K}}$ possesses a strictly positive eigenvector associated with $\lambda = \lambda_{\mathcal{K}}$. Moreover, if it is unique up to a scalar multiple for a \succcurlyeq -minimal matrix, then it is unique up to a scalar multiple for $f_{\mathcal{K}}$.*

Proof. Let B be a \succcurlyeq -minimal matrix with strictly positive eigenvector v . Apply the

same procedure as in the proof of Proposition III.21. Find $D \in \mathcal{K}$ such that

$$Dv = \min_{A \in \mathcal{K}} Av$$

with $D_i = B_i$ if $(Bv)_i \leq (Av)_i$ for all $A \in \mathcal{K}$. Then $Dv \leq Bv = \lambda v$ and $D^n v \leq \lambda^n v = B^n v$. Thus D is \succcurlyeq -minimal, has strictly positive eigenvector, and $\text{spr}(D) = \lambda$. Since each final class of D is basic, $(Dv)_i = (\lambda v)_i$ for all i in the final classes of D by Theorem III.3 item 3. Hence $D_i = B_i$ for all i in the final classes of D and the set of final classes of B contains the set of final classes of D .

By Theorem III.5 each non-final class of D is non-basic. Let $S_1 \subset S$ be the union of all final classes and let $S_2 = S \setminus S_1$. Then, after possibly permuting the states,

$$D = \begin{pmatrix} D|_{(S_2, S_2)} & E \\ 0 & B|_{(S_1, S_1)} \end{pmatrix}$$

with $\text{spr}(D|_{(S_1, S_1)}) = \lambda$ and $\text{spr}(D|_{(S_2, S_2)}) < \lambda$. Define

$$u|_{S_1} = v|_{S_1} \quad \text{and} \quad u|_{S_2} = (\lambda I - D|_{(S_2, S_2)})^{-1} E v|_{S_2}. \quad (3.1)$$

Then $Du = \lambda u$ and thus $u > 0$ by Lemma III.10. Suppose $u_i > v_i$ for some $i \in S$.

Then it follows from $Du = \lambda u$ and $Dv \leq \lambda v$ that

$$D|_{(S_2, S_2)} [u|_{S_2} - v|_{S_2}] \geq \lambda [u|_{S_2} - v|_{S_2}].$$

This contradicts $\text{spr}(D|_{(S_2, S_2)}) < \lambda$ by Theorem III.4 item 4. Hence $v \geq u > 0$.

By construction, $u = v$ if and only if $D = B$. We can apply the same procedure to D and u . On each step the set of final classes of the new matrix is contained in the set of final classes of the previous matrix and the next eigenvector coincides with the previous one on the states from the final classes of the new matrix. Since \mathcal{K} is finite, after a finite number of steps all received matrices will have the same set

of final classes and all received eigenvectors are the same on this set. Now suppose this process will never stabilize. It means that all received eigenvectors are different. Since \mathcal{K} is finite, some matrix appears in this process at least two times with different strictly positive eigenvectors that coincide on the final classes of this matrix. But by (3.1) eigenvector of a matrix is uniquely defined by its coordinates from the final classes of this matrix. We get a contradiction. Thus, after a finite number of steps we will reach a \succcurlyeq -minimal matrix $M \in \mathcal{K}$ with strictly positive eigenvector w such that

$$Mw = \min_{A \in \mathcal{K}} Aw = \lambda w.$$

The proof of the last part about the uniqueness of a strictly positive eigenvector up to a scalar multiple is the same as the proof of the last part of Proposition III.21, using the observation that if a matrix from \mathcal{K} has a strictly positive eigenvector associated with $\lambda_{\mathcal{K}}$ then it is \succcurlyeq -minimal. \square

So, if there exists a \succcurlyeq -minimal matrix with strictly positive eigenvector, then the growth exponent of each component of $f_{\mathcal{K}}^n(v)$ is equal to the spectral radius of this \succcurlyeq -minimal matrix.

The next proposition deals with the case when \succcurlyeq -minimal matrices do not possess a strictly positive eigenvector, and shows the existence of a nonnegative eigenvector for $f_{\mathcal{K}}$, whose special entries are positive. Later this proposition with $\nu = 1$ will be used as the basis of induction for Lemma III.26.

Proposition III.24. *Let $\{S_0, S_1, \dots, S_\nu\}$ be the principal \succcurlyeq -minimal partition of the state space S with respect to \mathcal{K} . Then there exists a nonnegative vector v such that:*

$$f_{\mathcal{K}}(v) = \min_{A \in \mathcal{K}} Av = \lambda_{\mathcal{K}} v \quad \text{and} \quad v|_{S_\nu} > 0, \quad v|_{S \setminus S_\nu} = 0.$$

Proof. Let B be a \succcurlyeq -minimal matrix for \mathcal{K} . Since $\{S_0, S_1, \dots, S_\nu\}$ is the principal

partition of B , the matrix $B|_{(S_\nu, S_\nu)}$ possesses a strictly positive eigenvector associated with $\lambda_{\mathcal{K}} = \text{spr}(B|_{(S_\nu, S_\nu)})$ by Remark III.8. The set $\mathcal{K}|_{S_\nu} = \{A|_{(S_\nu, S_\nu)} | A \in \mathcal{K}\}$ also satisfies the product property and $B|_{S_\nu}$ is \succcurlyeq -minimal for it. We can apply Proposition III.23 for $\mathcal{K}|_{S_\nu}$. There exists a strictly positive vector w defined on S_ν such that

$$\min_{A \in \mathcal{K}} A|_{(S_\nu, S_\nu)} w = \lambda_{\mathcal{K}} w.$$

Take the vector v with $v|_{S_\nu} = w$ and $v|_{S \setminus S_\nu} = 0$. Then v satisfies the conditions of the proposition. \square

It was shown by W.H.M. Zijm [Zij84] and independently by K. Sladký [Sla81] that a more strong result holds for $g_{\mathcal{K}}$, which proves existence of a simultaneous (uniform) block-triangular representation of the matrices in \mathcal{K} and allows one to define the “principal partition” (in our terms — the principal \succcurlyeq -maximal partition) of S with respect to \mathcal{K} . This partition plays a fundamental role in those papers. This result does not hold for $f_{\mathcal{K}}$.

5 Generalized Howard’s policy iteration procedure

There are several algorithms used for determining the optimal policy for decision problems: Bellman’s value iteration procedure [Bel57a], Howard’s policy iteration procedure [How60], and many modifications of the previous one’s.

We prove in this section one lemma, which shows existence of a solution of a set of “nested” functional equations that we will use in the next section. As it was noticed in [Zij84] for the case of the maps $g_{\mathcal{K}}$, it can be viewed as a generalization of the Howard’s policy iteration procedure.

We write just λ and ν instead of $\lambda_{\mathcal{K}}$ and $\nu_{\mathcal{K}}$ if there is no ambiguity.

Let t be an integer greater than 1. Suppose that for each $A \in \mathcal{K}$ we have a

sequence of (column) vectors $r_i(A)$, $i = 1, 2, \dots, t - 1$.

Lemma III.25. *Assume that the set of rectangular matrices*

$$\left\{ (A, r_1(A), r_2(A), \dots, r_{t-1}(A)) \mid A \in \mathcal{K} \right\}$$

satisfies the product property. Suppose that some (every) \succcurlyeq -minimal matrix $B \in \mathcal{K}$ possesses a strictly positive eigenvector. Suppose furthermore $B^ r_{t-1}(B) > 0$ for every \succcurlyeq -minimal matrix B , where B^* is defined by Lemma III.11. Then there exists a solution $\{v^{(1)}, v^{(2)}, \dots, v^{(t)}\}$ of the set of functional equations:*

$$\begin{aligned} \min_{A \in \mathcal{K}} Av^{(t)} &= \lambda v^{(t)}, \\ \min_{A \in \mathcal{K}_{i+1}} \{Av^{(i)} + r_i(A)\} &= \lambda v^{(i)} + v^{(i+1)}, \quad i = 1, 2, \dots, t - 1, \end{aligned}$$

where \mathcal{K}_i is defined recursively by

$$\begin{aligned} \mathcal{K}_t &:= \{A \mid A \in \mathcal{K}, Av^{(t)} = \lambda v^{(t)}\}, \\ \mathcal{K}_i &:= \{A \mid A \in \mathcal{K}_{i+1}, Av^{(i)} + r_i(A) = \lambda v^{(i)} + v^{(i+1)}\}, \quad i = 2, 3, \dots, t - 1. \end{aligned}$$

Furthermore $v^{(t)} > 0$.

Proof. The set of equations

$$\begin{aligned} Bv^{(t)} &= \lambda v^{(t)}, \\ Bv^{(i)} + r_i(B) &= \lambda v^{(i)} + v^{(i+1)}, \quad i = 1, 2, \dots, t - 1, \\ B^*v^{(1)} &= 0 \end{aligned} \tag{3.2}$$

has a unique solution

$$\begin{aligned} v^{(t)} &= B^* r_{t-1}(B), \\ v^{(i)} &= (\lambda I - B + B^*)^{-1} [r_i(B) + B^* r_{i-1}(B) - v^{(i+1)}], \quad i = 2, 3, \dots, t-1, \\ v^{(1)} &= (\lambda I - B + B^*)^{-1} [r_1(B) - v^{(2)}]. \end{aligned}$$

Moreover $v^{(t)} > 0$. Since we have the “extended” product property, there exists a matrix $D \in \mathcal{K}$ such that

$$\begin{aligned} Dv^{(t)} &= \min_{A \in \mathcal{K}} Av^{(t)}, \\ Dv^{(i)} + r_i(D) &= \min_{A \in \mathcal{H}_{i+1}} \{Av^{(i)} + r_i(A)\}, \quad i = 1, 2, \dots, t-1, \end{aligned}$$

where $\mathcal{H}_i \subset \mathcal{K}$ are defined recursively as the subset of matrices from \mathcal{H}_{i+1} which minimize the right hand side of i -th equation above. We choose $D = B$ if B satisfies the above equations, i.e. if $B \in \mathcal{H}_1$.

Then $Dv^{(t)} \leq \lambda v^{(t)}$ and thus D is \succcurlyeq -minimal and possesses a strictly positive eigenvector. As above, the set of equations (3.2) with the matrix D instead of B has a unique solution $\{u^{(1)}, u^{(2)}, \dots, u^{(t)}\}$ with $u^{(t)} > 0$ and so on. We want to show that this process will eventually stop. It is easy to see that if $\{v^{(i)}\}$ and $\{u^{(i)}\}$ satisfy the following properties

- (a) $u^{(t)} \leq v^{(t)}$;
- (b) if $u^{(i)} = v^{(i)}$ for $i = k+1, k+2, \dots, t$ then $u^{(k)} \leq v^{(k)}$;
- (c) if $u^{(i)} = v^{(i)}$ for all $i = 1, 2, \dots, t$ then $D = B$,

then, since \mathcal{K} is finite, after a finite number of steps we will reach a matrix which stays intact under application of this process. The corresponding solution of (3.2) will satisfy the conditions of the lemma.

Let us prove (a), (b), and (c). Let $\mathcal{C} \subset S$ be the union of all final classes of D .

(a) Using Lemma III.11 and construction of $u^{(i)}$ and $v^{(i)}$ we get

$$u^{(t)} = D^*r_{t-1}(D) \leq D^*[\lambda v^{(t-1)} + v^{(t)} - Dv^{(t-1)}] = D^*v^{(t)} \leq v^{(t)}.$$

(b) Now suppose $u^{(i)} \leq v^{(i)}$ for $i = k+1, k+2, \dots, t$. Define vectors $\psi^{(i)}$, $i = 1, 2, \dots, t$, such that:

$$\begin{aligned} Dv^{(t)} &= \lambda v^{(t)} + \psi^{(t)}, \\ Dv^{(i)} + r_i(D) &= \lambda v^{(i)} + v^{(i+1)} + \psi^{(i)}. \end{aligned}$$

From (3.2) for the matrix D and the previous equations we get:

$$D[v^{(i)} - u^{(i)}] = \lambda[v^{(i)} - u^{(i)}] + [v^{(i+1)} - u^{(i+1)}] + \psi^{(i)}. \quad (3.3)$$

Thus, $\psi^{(i)} = 0$ and $Dv^{(i)} + r_i(D) = Bv^{(i)} + r_i(B)$ for $i = k+1, \dots, t$. Hence $B \in \mathcal{H}_{k+1}$.

It follows that $\psi^{(k)} \leq 0$ and

$$\begin{aligned} D[v^{(k)} - u^{(k)}] &= \lambda[v^{(k)} - u^{(k)}] + \psi^{(k)} \quad \Rightarrow \quad (\text{applying } D^*) \quad (3.4) \\ D^*\psi^{(k)} &= 0. \end{aligned}$$

Hence $\psi_i^{(k)} = 0$ for all $i \in \mathcal{C}$ by Lemma III.11 item 3.

Consider the case $k \geq 2$. Then $\psi_i^{(k-1)} \leq 0$ for $i \in \mathcal{C}$ and hence $D^*\psi^{(k-1)} \leq 0$ by Lemma III.11 item 1. Applying D^* to $(k-1)$ -st equation of (3.3) we obtain:

$$0 = D^*[v^{(k)} - u^{(k)}] + D^*\psi^{(k-1)}, \quad \text{but} \quad D[v^{(k)} - u^{(k)}] \leq \lambda[v^{(k)} - u^{(k)}].$$

Hence $[v^{(k)} - u^{(k)}] \geq D^*[v^{(k)} - u^{(k)}] = -D^*\psi^{(k-1)} \geq 0$, because $\psi_i^{(k-1)} \leq 0$ for $i \in \mathcal{C}$.

For $k = 1$ we have $B \in \mathcal{H}_2$ and since $\psi_i^{(1)} = 0$ for $i \in \mathcal{C}$ we may choose $D_i = B_i$ for $i \in \mathcal{C}$. In this case $D_i^* = B_i^*$ and $u_i^{(1)} = v_i^{(1)} = 0$ for $i \in \mathcal{C}$. Thus $D^*v^{(1)} = 0$. It

follows from (3.4) that

$$[v^{(1)} - u^{(1)}] \geq D^*[v^{(1)} - u^{(1)}] = 0.$$

(c) As above, $\psi^{(i)} = 0$ for all i and hence $B \in \mathcal{H}_1$. Thus $D = B$ by construction. \square

6 Generalized eigenvectors of $f_{\mathcal{K}}$

Lemma III.26. *Let $\{S_0, S_1, \dots, S_\nu\}$ be the principal \succ -minimal partition with respect to \mathcal{K} . There exists a set of nonnegative vectors $v^{(1)}, v^{(2)}, \dots, v^{(\nu)}$ such that*

$$\begin{aligned} \min_{A \in \mathcal{K}} Av^{(\nu)} &= \lambda v^{(\nu)}, \\ \min_{A \in \mathcal{K}_{i+1}} Av^{(i)} &= \lambda v^{(i)} + v^{(i+1)}, \quad i = 1, 2, \dots, \nu - 1; \end{aligned} \tag{3.5}$$

where

$$\begin{aligned} \mathcal{K}_\nu &:= \{A \mid A \in \mathcal{K}, Av^{(\nu)} = \lambda v^{(\nu)}\}, \\ \mathcal{K}_i &:= \{A \mid A \in \mathcal{K}_{i+1}, Av^{(i)} = \lambda v^{(i)} + v^{(i+1)}\}, \quad i = 2, 3, \dots, \nu - 1. \end{aligned}$$

Moreover

$$v_j^{(i)} > 0, \quad j \in \bigcup_{k=i}^{\nu} S_k \quad \text{and} \quad v_j^{(i)} = 0, \quad j \in \bigcup_{k=0}^{i-1} S_k. \tag{3.6}$$

Proof. By induction on ν . For $\nu = 1$ the result follows from Proposition III.24.

Suppose that the theorem holds for $\nu < t$ and let now $\nu = t$.

Notice that

$$\mathcal{K}_t = \{A \mid A \in \mathcal{K}, Av^{(t)} = \lambda v^{(t)}, \text{ and } A|_{(S \setminus S_t, S_t)} = 0\}$$

for any given $v^{(t)}$ with $v^{(t)}|_{S_t} > 0$ and $v^{(t)}|_{S \setminus S_t} = 0$. Define the set of matrices

$$\mathcal{H} = \{A|_{(S \setminus S_t, S \setminus S_t)}, A \in \mathcal{K}_t\}.$$

Clearly \mathcal{H} also satisfies the product property and $B|_{(S \setminus S_\nu, S \setminus S_\nu)}$ is a \succsim -minimal matrix for \mathcal{H} for any \succsim -minimal matrix B for \mathcal{K} . Thus $S_0, S_1, \dots, S_{\nu-1}$ is the principal \succsim -minimal partition of \mathcal{H} . By the induction hypothesis there exist nonnegative vectors $u^{(1)}, u^{(2)}, \dots, u^{(t-1)}$ defined on $S \setminus S_\nu$ such that $u^{(t-1)}|_{S_{t-1}} > 0$ and

$$\begin{aligned} \min_{A \in \mathcal{H}} Au^{(t-1)} &= \lambda u^{(t-1)}, \\ \min_{A \in \mathcal{H}_{i+1}} Au^{(i)} &= \lambda u^{(i)} + u^{(i+1)}, \quad i = 1, 2, \dots, t-2. \end{aligned}$$

Now we need to find vectors $v^{(1)}, v^{(2)}, \dots, v^{(t)}$ such that (3.5) holds. Let us put

$$v_j^{(i)} = u_j^{(i)} \quad \text{and} \quad v_j^{(t)} = 0 \quad \text{for } j \in S \setminus S_t.$$

Then clearly $\mathcal{K}_i \subset \{A \mid A \in \mathcal{K}_t, A|_{(S \setminus S_t, S \setminus S_t)} \in \mathcal{H}_i\}$ for $i = 1, 2, \dots, t-1$, and the vectors $v^{(i)}$, independent of their coordinates on S_t , satisfy (3.5) for the states in $S \setminus S_t$. It remains to determine $v_j^{(i)}$ for $j \in S_t, i = 1, 2, \dots, t$. The conditions on $v^{(i)}|_{S_t}$ are the following:

$$\begin{aligned} \min_{A \in \mathcal{K}} A|_{(S_t, S_t)} v^{(t)}|_{S_t} &= \lambda v^{(t)}|_{S_t}, \\ \min_{A \in \mathcal{K}_{i+1}} \left\{ A|_{(S_t, S_t)} v^{(i)}|_{S_t} + \sum_{j=i}^{t-1} A|_{(S_t, S_j)} v^{(i)}|_{S_j} \right\} &= \lambda v^{(i)}|_{S_t} + v^{(i+1)}|_{S_t} \end{aligned}$$

for $i = 1, 2, \dots, t-1$. Since $\{S_0, S_1, \dots, S_t\}$ is the principal partition of any \succsim -minimal matrix $B \in \mathcal{K}$, the matrix $B|_{(S_t, S_t)}$ possesses a strictly positive eigenvector associated with λ . Moreover $u^{(t-1)}|_{S_{t-1}} > 0$. Each final class of $B|_{(S_t, S_t)}$ has access to some state in $B|_{(S_{t-1}, S_{t-1})}$. Thus

$$(B|_{(S_t, S_{t-1})} u^{(t-1)}|_{S_{t-1}})_i > 0$$

for some i in every final class of $B|_{(S_t, S_t)}$. Then $B|_{(S_t, S_t)}^* B|_{(S_t, S_{t-1})} u^{(t-1)}|_{S_{t-1}} > 0$ for every \succsim -minimal matrix B by Lemma III.11 item 1. We can now apply Lemma III.25 and find $v^{(i)}|_{S_t}$.

It may happen that $v^{(i)}$ does not satisfy the nonnegativity constraints (3.6) on S_t (they satisfy it on $S \setminus S_t$ by induction). In this case consider

$$\begin{aligned} w^{(t)} &= v^{(t)}, \\ w^{(i)} &= v^{(i)} + \alpha v^{(i+1)}, \quad i = 1, 2, \dots, t-1, \end{aligned} \tag{3.7}$$

for a real number α . They also satisfy (3.5) and we can choose α large enough so that $w_j^{(i)} > 0$ for all $j \in S_t$, $i = 1, 2, \dots, t$. \square

Now we are ready to prove the main result.

Theorem III.27. *Let $\{S_0, S_1, \dots, S_\nu\}$ be the principal \succsim -minimal partition with respect to \mathcal{K} . Then there exists a set of nonnegative vectors $v^{(1)}, v^{(2)}, \dots, v^{(\nu)}$ such that*

$$\begin{aligned} \min_{A \in \mathcal{K}} Av^{(\nu)} &= \lambda v^{(\nu)}, \\ \min_{A \in \mathcal{K}} Av^{(i)} &= \lambda v^{(i)} + v^{(i+1)}, \quad i = 1, 2, \dots, \nu-1. \end{aligned}$$

Moreover

$$v_j^{(i)} > 0, \quad j \in \bigcup_{k=i}^{\nu} S_k \quad \text{and} \quad v_j^{(i)} = 0, \quad j \in \bigcup_{k=0}^{i-1} S_k.$$

Proof. Use Lemma III.26 to find solutions $v^{(1)}, v^{(2)}, \dots, v^{(\nu)}$ of the corresponding system (3.5). Now consider the vectors $w^{(1)}, w^{(2)}, \dots, w^{(\nu)}$ from (3.7). It is easy to see that for α large enough

$$\min_{A \in \mathcal{K}_{i+1}} Aw^{(i)} = \min_{A \in \mathcal{K}_{i+2}} Aw^{(i)} = \dots = \min_{A \in \mathcal{K}} Aw^{(i)}, \quad i = 1, 2, \dots, \nu,$$

and the vectors $w^{(1)}, w^{(2)}, \dots, w^{(\nu)}$ satisfy the conditions of the theorem. \square

7 Asymptotic behavior of iterations of $f_{\mathcal{K}}$

Theorem III.28. *Let $\{S_0, S_1, \dots, S_\nu\}$ be the principal \succcurlyeq -minimal partition with respect to \mathcal{K} . Then*

$$(f_{\mathcal{K}}^n(v))_i \sim n^{k-1} \lambda_{\mathcal{K}}^n, \quad \text{for } i \in S_k \text{ and } k = 1, 2, \dots, \nu,$$

for every strictly positive vector v . For every \succcurlyeq -minimal matrix $B \in \mathcal{K}$ the asymptotic relation

$$f_{\mathcal{K}}^n(v) \sim B^n v$$

holds for every strictly positive vector v .

Proof. The proof of the first part is the same as for a single matrix (see Theorem III.15). Thus $(f_{\mathcal{K}}^n(v))_i \sim (B^n v)_i$ for $i \notin S_0$. We need to prove the previous asymptotic relation for $i \in S_0$.

The upper bound $f_{\mathcal{K}}^n(v) \preccurlyeq B^n v$ is obvious. Define

$$\mathcal{H} = \{A \in \mathcal{K} \mid A|_{(S_0, S \setminus S_0)} = 0\} \quad \text{and} \quad f_{\mathcal{K}}|_{S_0} = \min_{A \in \mathcal{H}} A|_{(S_0, S_0)}.$$

Then $B|_{(S_0, S_0)}$ is a \succcurlyeq -minimal matrix for $\mathcal{H}|_{S_0}$ for any matrix B which is \succcurlyeq -minimal for \mathcal{K} . Let $\beta = \text{spr}(B|_{(S_0, S_0)})$ (notice that $\beta < \lambda$) and let $\{S'_0, S'_1, \dots, S'_{\nu'}\}$ be the principal \succcurlyeq -minimal partition of S_0 with respect to $\mathcal{H}|_{S_0}$. By Theorem III.27 there exist nonnegative vectors $w^{(1)}, w^{(2)}, \dots, w^{(\nu')}$ defined on S_0 such that

$$\begin{aligned} f_{\mathcal{K}}|_{S_0}(w^{(\nu')}) &= \beta w^{(\nu')} \\ f_{\mathcal{K}}|_{S_0}(w^{(i)}) &= \beta w^{(i)} + w^{(i+1)}, \quad i = 1, 2, \dots, \nu' - 1, \end{aligned}$$

and with specified nonnegative constrains. Notice that then $(B^n v)_i \sim n^{k-1} \beta^n$ for $i \in S'_k$ and $k = 1, 2, \dots, \nu'$.

Let v be a strictly positive vector defined on $S \setminus S_0$ such that $A|_{(S \setminus S_0, S \setminus S_0)} v \geq \lambda v$

for all $A \in \mathcal{K}$ (take for example $v^{(1)}|_{S \setminus S_0}$, where $v^{(1)}$ is from Theorem III.27). Define vectors $u_{\alpha_i}^{(i)}, i = 1, 2, \dots, \nu'$, such that $u_{\alpha_i}^{(i)}|_{S \setminus S_0} = \alpha_i v$ and $u_{\alpha_i}^{(i)}|_{S_0} = w^{(i)}$ (here α_i are some real numbers). Then

$$f_{\mathcal{X}}(u_{\alpha_i}^{(i)}) = \min_{A \in \mathcal{K}} \begin{pmatrix} \alpha_i A|_{(S \setminus S_0, S \setminus S_0)} v + A|_{(S \setminus S_0, S_0)} w^{(i)} \\ \alpha_i A|_{(S_0, S \setminus S_0)} v + A|_{(S_0, S_0)} w^{(i)} \end{pmatrix} = \min_{A \in \mathcal{K}} A u_{\alpha_i}^{(i)}, \quad i = 1, 2, \dots, \nu',$$

for α_i large enough. Moreover, we can additionally choose α_i such that $\alpha_i \lambda v \geq \alpha_i \beta v + \alpha_{i+1} v$ for $i = 1, 2, \dots, \nu' - 1$. Then

$$\begin{aligned} f_{\mathcal{X}}(u_{\alpha_{\nu'}}^{(\nu')}) &\geq \begin{pmatrix} \alpha_{\nu'} \lambda v \\ f|_{S_0} w^{(\nu')} \end{pmatrix} = \begin{pmatrix} \alpha_{\nu'} \lambda v \\ \beta w^{(\nu')} \end{pmatrix} \geq \begin{pmatrix} \alpha_{\nu'} \beta v \\ \beta w^{(\nu')} \end{pmatrix} = \beta u_{\alpha_{\nu'}}^{(\nu')}, \\ f_{\mathcal{X}}(u_{\alpha_i}^{(i)}) &\geq \begin{pmatrix} \alpha_i \lambda v \\ f|_{S_0} w^{(i)} \end{pmatrix} = \begin{pmatrix} \alpha_i \lambda v \\ \beta w^{(i)} + w^{(i+1)} \end{pmatrix} \geq \begin{pmatrix} \alpha_i \beta v + \alpha_{i+1} v \\ \beta w^{(i)} + w^{(i+1)} \end{pmatrix} = \beta u_{\alpha_i}^{(i)} + u_{\alpha_{i+1}}^{(i+1)}, \end{aligned}$$

for $i = 1, 2, \dots, \nu' - 1$. It follows that $(f_{\mathcal{X}}^n(u_{\alpha_1}^{(1)}))_i \succ n^{k-1} \beta^n$ for $i \in S'_k, k = 1, 2, \dots, \nu'$, and the lower bound is proved for $i \in S \setminus S'_0$.

We can now do the same for the states in S'_0 and so on. \square

Corollary III.29. *The following conditions are equivalent:*

1. *The map $f_{\mathcal{X}}$ has a strictly positive eigenvector.*
2. *Some (every) \succ -minimal matrix has a strictly positive eigenvector.*
3. *$(f_{\mathcal{X}}^n(v))_i \sim \lambda^n$ for all i and for some (every) vector $v > 0$.*
4. *$(f_{\mathcal{X}}^n(v))_i \sim (f_{\mathcal{X}}^n(v))_j$ for all i, j and for some (every) vector $v > 0$.*

CHAPTER IV

GROUPS GENERATED BY BOUNDED AUTOMATA

The structure of bounded and polynomial automata can be described explicitly, which makes it possible to deal with all bounded (polynomial) automata and allows us to understand easily whether a given automaton is bounded, polynomial, or neither just by looking at its Moore diagram. We will prove that a group generated by a bounded automaton is contracting. This allows us to consider the limit spaces \mathcal{J}_G of these groups, which happened to be related to the class of post-critically finite self-similar sets. We introduce the notions of post-critical sets of a finite automaton and of the limit space of a contracting self-similar group, adapted from the fractal geometry. Then we show that the limit space of a contracting self-similar group generated by a finite automaton is post-critically finite if and only if the automaton is bounded.

1 Bounded and polynomial automata

1.1 Definition and basic properties

Recall the original definitions by Said Sidki [Sid00].

Let g be an automorphism of the tree X^* . Define the numeric sequence $\theta_k(g)$ as the number of words $v \in X^k$ such that the restriction $g|_v$ is *active*, i.e. $g|_v$ acts non-trivially on the first level X of the tree X^* . Looking at the asymptotic behavior of the sequence $\theta_k(\cdot)$ we can define different classes of automorphisms of the tree X^* . For example, the automorphisms whose sequence θ_k is eventually 0 are precisely finitary automorphisms.

If an automorphism g is finite-state then there are only two essentially different possibilities for the asymptotic behavior of the sequence $\theta_k(g)$.

Proposition IV.1 ([Sid00]). *Let g be an automorphism given by a finite initial automaton with m states. Then the sequence $\theta_k(g)$ either grows exponentially or polynomially of degree at most $m - 1$.*

Another approach, which is in most cases equivalent to the S. Sidki's method, is to consider the numeric sequence $\alpha_k(g)$, which is the number of words $v \in X^k$ such that the restriction $g|_v$ is non-trivial (but may act trivially on X). It follows that $\theta_k(g) \leq \alpha_k(g)$ for all $k \geq 1$.

Proposition IV.2. *Let g be an automorphism given by a finite initial automaton with m states. Then*

$$\alpha_k(g) \leq \theta_k(g) + \theta_{k+1}(g) + \cdots + \theta_{k+m-1}(g)$$

for all $k \geq 1$.

Proof. Take a word $v \in X^k$ such that the restriction $g|_v$ is non-trivial. Since the automaton has m states, there exists a word $u \in X^*$, $|u| \leq m - 1$, such that the restriction $g|_{v|u}$ acts non-trivially on X . The word vu is counted in $\theta_{k+|u|}(g)$. \square

In particular, for a finite-state automorphism g the sequence $\theta_k(g)$ is bounded by a polynomial of degree n if and only if the sequence $\alpha_k(g)$ is bounded by a polynomial of degree n .

Definition 15. A finite-state automorphism $g \in \text{Aut } X^*$ is called *bounded* if the sequence $\theta_k(g)$ (equivalently $\alpha_k(g)$) is bounded. A finite-state automorphism $g \in \text{Aut } X^*$ is called *polynomial (of degree n)* if the sequence $\theta_k(g)$ (equivalently $\alpha_k(g)$) is bounded by a polynomial (of the smallest degree n).

It is easy to see that the sequences $\theta_k(\cdot)$ and $\alpha_k(\cdot)$ have the following properties

$$\begin{aligned} \theta_k(gh) &\leq \theta_k(g) + \theta_k(h) & \theta_k(g^{-1}) &= \theta_k(g) \\ \alpha_k(gh) &\leq \alpha_k(g) + \alpha_k(h) & \alpha_k(g^{-1}) &= \alpha_k(g) \end{aligned} \tag{4.1}$$

for all automorphisms g and h .

Define the set $\mathcal{B}_n = \mathcal{B}_n(X)$, $n \geq 0$, of all finite-state automorphisms g of the tree X^* , whose sequence $\theta_k(g)$ (equivalently $\alpha_k(g)$) is bounded by a polynomial of degree n . The properties (4.1) imply that the set \mathcal{B}_n forms a group. It is proved in [Sid00] that all groups \mathcal{B}_n are different for all $n \geq 0$ and so we have a chain of groups

$$\mathcal{B}_0 < \mathcal{B}_1 < \dots < \mathcal{B}_n < \dots$$

Definition 16. The group \mathcal{B}_0 is called *the group of bounded automata*. The group \mathcal{B}_n is called *the group of polynomial automata of degree n* . The group $\cup_{n \geq 1} \mathcal{B}_n$ is called *the group of polynomial automata*.

The group \mathcal{B}_0 consists of all bounded automorphisms.

Definition 17. A finite invertible automaton \mathcal{A} is called *bounded* if all its states define bounded automorphisms.

A finite invertible automaton \mathcal{A} is called *polynomial* if all its states define polynomial automorphisms. A finite invertible automaton \mathcal{A} is called *polynomial of degree n* if the automorphism $\mathcal{A}_q \in \mathcal{B}_n$ for every state q of \mathcal{A} and $\mathcal{A}_p \notin \mathcal{B}_{n-1}$ for some state p .

A group generated by a bounded automaton is a subgroup of \mathcal{B}_0 . A group generated by a polynomial automaton of degree n is a subgroup of \mathcal{B}_n . It is easy to see that a finite-state automorphism of the tree X^* is bounded if and only if it can be given by an initial automaton, which is bounded.

When we talk about the activity of an automorphism g , we consider the properties of the sequences $\theta_k(g)$, $\alpha_k(g)$, and the words $v \in X^*$ for which $g|_v$ is active or just non-trivial.

The first important result about algebraic properties of the group of polynomial automata is

Theorem IV.3 ([Sid04]). *The group $\mathcal{B}_n(X)$ does not contain free non-abelian subgroups for every $n \geq 0$ and for any finite alphabet X .*

In case of the group of bounded automata the previous theorem is a particular case of the next important result.

Theorem IV.4 ([BKNV06]). *The group \mathcal{B}_0 is amenable.*

In particular, every bounded automaton generates amenable group. The amenability of groups generated by polynomial automata and contracting self-similar groups is an open question.

1.2 Structure of bounded and polynomial automata

Let g be the automorphism given by a finite initial automaton \mathcal{A}_g . Let Γ be the subgraph of the Moore diagram of \mathcal{A} induced by the set of non-trivial states. Let A be the incidence matrix of the graph Γ . The (g, h) -entry of the matrix A^k counts the number of paths in Γ of length k that start at the state g and end at the state h (see, for example, [ST02, Proposition 4.1.2]). Every such a path corresponds to a unique word in X^k . Hence

$$\alpha_k(g) = \sum_{h \in \mathcal{A}, h \neq 1} A^k|_{(g,h)}$$

for all $k \geq 1$ and now Proposition IV.1 follows from Theorem III.15.

Analyzing the iterations of nonnegative integer matrices one gets the following propositions. They describe the Moore diagrams of the bounded and polynomial

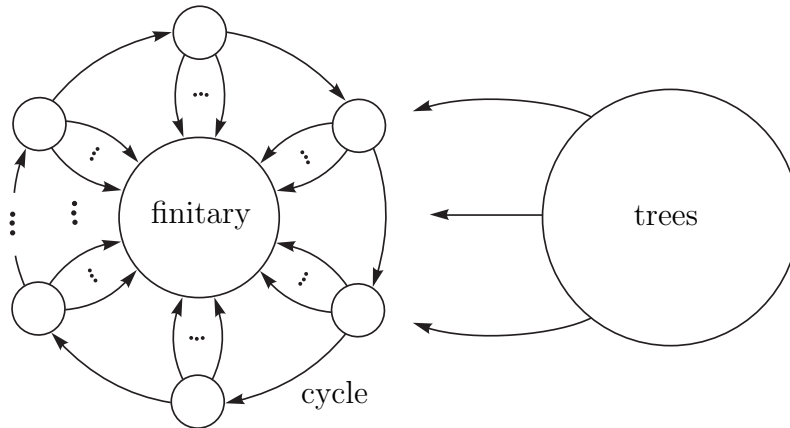

Fig. 5. General form of connected components of bounded automata

automata and, in particular, show a connection between the cyclic structure of the automata and their activity growth. A cycle in the Moore diagram of an automaton is called *trivial*, if it contains only one vertex that corresponds to the trivial automorphism of the tree X^* .

Proposition IV.5 ([Sid00]). *A finite invertible automaton is polynomial if and only if every two non-trivial cycles in the Moore diagram of the automaton are disjoint.*

Proposition IV.6 ([Sid00]). *A finite invertible automaton is bounded if and only if every two non-trivial cycles in the Moore diagram of the automaton are disjoint and not connected by a directed path.*

It follows that a bounded automaton is a disjoint union of the automata schematically described in Figure 5. Notice that a (bounded) polynomial automaton contains a state that corresponds to the trivial automorphism, and, moreover, there is a path from every state to the trivial state (the automaton satisfies the open set condition).

Also the spectral properties of the matrix A can be used to check whether the

automaton \mathcal{A} is polynomial or not.

Proposition IV.7 ([Nek05, Proposition 3.9.4]). *The automaton \mathcal{A} is polynomial of degree n if and only if the spectral radius of A is 1 and has multiplicity $n + 1$.*

The bounded automorphisms are in some sense generalization of the directed automorphisms, which appear in [BGŠ03] (see also [Roz96]) in connections to the constructions of groups of intermediate growth and infinite periodic finitely generated groups.

Definition 18. An automorphism g of the tree X^* is called *directed along the sequence* $w \in X^\omega$ if the restriction $g|_v$ is trivial for every word $v \in X^*$ whose distance on the tree X^* to the sequence w is at least 2.

Notice that the previous definition is slightly more general than the one given in [BGŠ03], where it is also supposed that $g|_v$ acts trivially on X for every beginning word v of the sequence w .

Every directed finite-state automorphism is bounded. The activity of a directed automorphism is concentrated along one ray in the tree X^* , while the activity of the automorphism given by a bounded (polynomial) initial automaton is concentrated along a finite (respectively countable) number of rays.

Proposition IV.8 ([Nek05, Proposition 3.9.11]). *A finite-state automorphism g is bounded if and only if there exists a level n such that the automorphism $g|_v$ is either directed or rooted for every word $v \in X^n$.*

Moreover, we may assume that for every directed automorphism $g|_v$ there exists (precisely one) word $u \in X^n$ such that $g|_{v|u} = g|_v$.

So, after passing to a power X^n of the alphabet, we may assume that every restriction $g|_v$ is either rooted or directed along a sequence y^ω for some letter y of the new alphabet.

Theorem IV.9. *Let \mathcal{A} be a finite invertible automaton and let Γ be the subgraph of the Moore diagram of \mathcal{A} spanned by the set of non-trivial states. The following conditions are equivalent:*

1. *The automaton \mathcal{A} is bounded (polynomial).*
2. *There exist only a finite (countable) number of left-infinite paths in Γ .*
3. *There exist only a finite (countable) number of right-infinite paths in Γ .*

Proof. Let \mathcal{A} be a bounded automaton. By Proposition IV.6 for every state g in a cycle of the graph Γ there exist precisely one left-infinite path ending in g and one right-infinite path beginning in g . Then there exist a finite number of left-infinite paths ending in a non-trivial finitary state, there are no left-infinite paths ending in a non-finitary state which does not lie on a cycle, and the item 2 follows. Similarly, there exist a finite number of right-infinite paths beginning in a non-finitary state which does not lie on a cycle, there are no right-infinite paths beginning in a non-trivial finitary state, and the item 3 follows.

On the other hand, suppose the automaton \mathcal{A} is not bounded. Then by Proposition IV.6 there exist two different simple cycles \mathcal{C}_1 and \mathcal{C}_2 in the graph Γ such that either these cycles begin and end at the same vertex g , or there exists a non-empty path γ from the beginning of \mathcal{C}_1 to the beginning of \mathcal{C}_2 . In the first case, we have uncountable families of different left-infinite and right-infinite paths in Γ of the form $\dots p_3 p_2 p_1$ and $p_1 p_2 p_3 \dots$ respectively, where p_i is either \mathcal{C}_1 or \mathcal{C}_2 . In the second case, there are infinite (countable) families $\{\mathcal{C}_1^{-\omega} \gamma \mathcal{C}_2^n\}_{n \in \mathbb{N}}$ and $\{\mathcal{C}_1^n \gamma \mathcal{C}_2^\omega\}_{n \in \mathbb{N}}$ of different left-infinite and right-infinite paths.

The statement for the polynomial automata can be proved by induction on the maximal number of cycles in the graph Γ connected by a directed path. If this number is equal to m then the automaton is polynomial of degree $m - 1$. Here the

only left-infinite paths in Γ are the paths of the form

$$\mathcal{C}_k^{-\omega} \gamma_{k-1} \dots \gamma_2 \mathcal{C}_2^{n_2} \gamma_1 \mathcal{C}_1^{n_1} \gamma_0, \quad n_i \in \mathbb{N},$$

and the only right-infinite paths are the paths of the form

$$\gamma_k \mathcal{C}_k^{n_k} \gamma_{k-1} \dots \gamma_2 \mathcal{C}_2^{n_2} \gamma_1 \mathcal{C}_1^\omega, \quad n_i \in \mathbb{N},$$

where \mathcal{C}_i is a simple cycle of Γ and γ_i is a finite path.

□

2 Contraction of groups generated by bounded automata

Proposition IV.10. *Let G be a contracting self-similar group with nucleus \mathcal{N} . If \mathcal{N} is a polynomial automaton of degree n , then G is a subgroup of \mathcal{B}_n .*

Proof. Take arbitrary element $g \in G$. There exists a level n such that $g|_v \in \mathcal{N}$ for all words v of length $\geq n$. Then

$$\theta_k(g) = \sum_{h \in \mathcal{N}} a_h \cdot \theta_{k-n}(h), \quad (4.2)$$

for all $k > n$, where a_h is the number of restrictions $g|_v$ on words $v \in X^n$ which are equal to h . Hence, if $h \in \mathcal{B}_n$ for all $h \in \mathcal{N}$ then $g \in \mathcal{B}_n$. □

The following is a joint result with V. Nekrashevych.

Theorem IV.11. *The group generated by a bounded automaton is contracting.*

Proof. Let G be the group generated by the states S of a bounded automaton \mathcal{A} . Let S_f be the set of all finitary automorphisms of \mathcal{A} and let $S_{nf} = S \setminus S_f$. Then all the states in the non-trivial cycles of \mathcal{A} belong to S_{nf} . Let S_c be the union of all the states in these cycles.

Since there are no directed paths between cycles, there exists a number n_1 such that $s|_v \in S_c \cup S_f$ for every $s \in S$ and every word $v \in X^{n_1}$. The group G_1 generated by $S_f \cup S_c$ is self-similar and contains the group $G|_{X^{n_1}} = \langle g|_v : g \in G, v \in X^{n_1} \rangle$. Thus G_1 is contracting if and only if the group G is contracting. Moreover, in this case their nuclei coincide. So, we can suppose that all non-finitary elements lie on cycles, which means $S_{nf} = S_c$.

Let k_1 be the least common multiple of the lengths of cycles in S_c . We can find a number k_2 such that the restriction $h|_v$ is trivial for every $h \in \langle S_f \rangle$ and every word $v \in X^{k_1 k_2}$ (note that the group $\langle S_f \rangle$ is finite). Let $n_1 = k_1 k_2$. Then for every $s \in S$ and every $v \in X^{n_1}$ either $s|_v \in S_f$ or $s|_v \in S_c$. Moreover, the restriction $s|_v$ belongs to S_c for a unique word $v \in X^{n_1}$, since the cycles are disjoint and not connected by a directed path.

Let \mathcal{N}_1 be the set of all non-trivial elements $h \in G$ such that there exists a unique word $v_h \in X^{n_1}$ such that $h|_{v_h} = h$ and for all words $v \in X^{n_1}$ not equal to v_h the restriction $h|_v$ belongs to $\langle S_f \rangle$. In particular, \mathcal{N}_1 contains S_c . The set \mathcal{N}_1 is finite, because every element h in \mathcal{N}_1 is uniquely defined by the permutation it induces on X^{n_1} and by the restrictions $h|_v$ on words $v \in X^{n_1}$.

Let us denote by $l_1(g)$ the minimal number of elements of $S_c \cup S_c^{-1}$ in a decomposition of g into a product of elements $S \cup S^{-1}$. Let us prove that for every $g \in G$ there exists a number k such that for every $v \in X^{n_1 k}$ the restriction $g|_v$ belongs to $\mathcal{N}_1 \cup \langle S_f \rangle$. We prove this induction on $l_1(g)$.

If $l_1(g) = 1$ then $g = f_1 s f_2$ for $f_1, f_2 \in \langle S_f \rangle$ and $s \in S_c \cup S_c^{-1}$. Then for every $v \in X^{n_1}$ we have $g|_v = f_1 s f_2|_v = s|_{f_2(v)}$ and so $g|_v$ is either equal to $s \in \mathcal{N}_1$ or belongs to $S_f \cup S_f^{-1}$. Thus the basis of induction is proved.

Suppose that the claim is proved for all elements $g \in G$ such that $l_1(g) < m$. Let $g = f_1 s_1 f_2 s_2 f_3 \dots f_m s_m f_{m+1}$ for $f_i \in \langle S_f \rangle$ and $s_i \in S_c \cup S_c^{-1}$. For every $u \in X^{n_1}$

the restriction $f_i|_u$ is trivial and the restriction $s_i|_u$ is either equal to s_i or belongs to $S_f \cup S_f^{-1}$. Consequently we have only two possibilities:

1. either $l_1(g|_u) < m$ for all $u \in X^{n_1}$;
2. or $g|_u = s_1 s_2 \dots s_m$ for a unique $u \in X^{n_1}$ and $g|_v \in \langle S_f \rangle$ for all $v \in X^{n_1} \setminus \{u\}$.

In the first case we can apply the induction hypothesis. In the second case the decomposition of $g|_u$ does not contain finitary elements. So, by the same reasons as above, either $l_1(g|_u|_v) < m$ for every word $v \in X^{n_1}$ and we can apply the induction hypothesis; or $g|_u|_w = g|_u$ for a unique word $w \in X^{n_1}$ and $g|_u|_v \in \langle S_f \rangle$ for every word $v \in X^{n_1}$ not equal to w . In the last case $g|_u$ belongs to \mathcal{N}_1 and the claim is proved.

Consequently, the group G is contracting. □

Corollary IV.12. *Let \mathcal{N} be the nucleus of the group generated by a bounded automaton. Then the subgraph of the Moore diagram of \mathcal{N} spanned by the set of all non-finitary elements is a disjoint union of simple cycles.*

In particular, for every non-finitary element g of the nucleus of the group there exists precisely one letter $x \in X$ such that the restriction $g|_x$ is non-finitary.

Corollary IV.13. *Every finitely generated self-similar subgroup of \mathcal{B}_0 is contracting and satisfies the open set condition.*

Corollary IV.14. *The word problem is solvable in polynomial time in every group generated by a bounded automaton.*

Proof. Follows from Theorem II.8. □

Corollary IV.15. *All orbital Schreier graphs of the group generated by a bounded automaton have polynomial growth.*

Proof. Follows from Theorem II.13. □

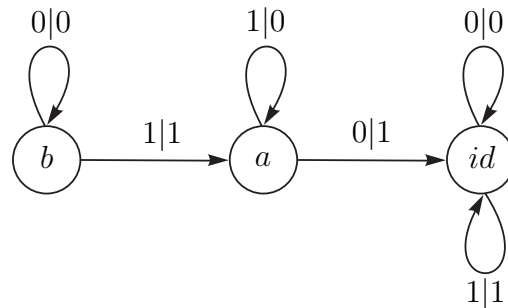

Fig. 6. One of the smallest polynomial and not bounded automata

In Chapter V we will deal with the problem of finding the degree of this growth, which is usually not integer.

The above theorem cannot be generalized to the groups generated by polynomial automata. For example, consider the group G generated by the automaton in Figure 6. By Proposition IV.6 this automaton is polynomial, moreover, it has linear activity growth, so the group G is a subgroup of \mathcal{B}_1 . The automorphism a is the adding machine (see Section 1 of Chapter VI) and has infinite order. Thus the elements $b^n = (b^n, a^n)$, $n \geq 1$, are all different, but they should belong to the nucleus. So, the group G is not contracting. Moreover, the orbital Schreier graphs Γ_ω of this group have intermediate growth (see [BH05]).

The group G has the following property. The groups generated by all minimal (i.e. with the minimal number $|Q| + |X|$) polynomial and not bounded automata (these automata have three states over the alphabet with two letters) are isomorphic to G . Really, up to passing to inverses of all generators, permuting the states of the automaton, permuting the letters of the alphabet, there are only three such automata

\mathcal{A} , \mathcal{A}_1 , \mathcal{A}_2 , which are given by the following wreath recursions:

$$\begin{aligned} a &= (1, a)\sigma & a_1 &= (1, a_1)\sigma & a_2 &= (1, a_2)\sigma \\ b &= (b, a) & b_1 &= (b_1, a_1)\sigma & b_2 &= (a_2, b_2)\sigma \end{aligned}$$

Then $a = a_1 = a_2$, $b_1a = (b_1a, a)$, $a^{-1}b_2 = (a^{-1}b_2, a)$. The automorphisms b , b_1a , and $a^{-1}b_2$ satisfy the same wreath recursion and thus are equal. Hence, the groups generated by these automata are the same.

3 Post-critical sets

Let G be a contracting self-similar group and let $\mathcal{T}_v, v \in X^*$, be the tiles of the group.

Define the set

$$\mathcal{B} = \bigcup_{x \neq y, x, y \in X} \mathcal{T}_x \cap \mathcal{T}_y.$$

Consider the canonical projection $\pi : X^{-\omega} \rightarrow \mathcal{J}_G$ and define two sets

$$\mathcal{C} = \pi^{-1}(\mathcal{B}), \quad \mathcal{P} = \bigcup_{n \geq 1} \tau^n(\mathcal{C}).$$

Definition 19. The set \mathcal{C} is called the *critical set* of the group G and of its limit space \mathcal{J}_G . The set \mathcal{P} is called the *post-critical set* of G and of \mathcal{J}_G .

The set $\pi(\mathcal{P})$ is thought of as a “boundary” of the limit space \mathcal{J}_G .

The critical and post-critical sets play an important role in determining the topological structure of the limit space \mathcal{J}_G . For example, if the critical set is empty (hence the post-critical set is empty) then the limit space is homeomorphic to the Cantor set X^ω .

Definition 20. Let \mathcal{A} be a finite automaton. The set

$$\mathcal{P}_{\mathcal{A}} = \left\{ \dots x_2 x_1 \in X^{-\omega} \left| \begin{array}{l} \text{there exists a path } \dots e_2 e_1 \text{ in the Moore diagram} \\ \text{of } \mathcal{A}, \text{ which ends in a non-trivial state and} \\ \text{is labeled by } \dots x_2 x_1 | * \text{ or } * | \dots x_2 x_1. \end{array} \right. \right\}$$

is called the *post-critical set of the automaton* \mathcal{A} .

Notice that if the automaton \mathcal{A} is invertible and coincides with its inverse (for example it is a nucleus), then it is sufficient to read only the left labels of the left-infinite paths, i.e. the post-critical set of \mathcal{A} is equal to the set of sequences $\dots x_2 x_1 \in X^{-\omega}$ which are read on the left-infinite paths in the Moore diagram of \mathcal{A} ending in a non-trivial state.

The following proposition explains why we use the term “post-critical set” in the definition 20 and gives an effective way to find the post-critical set of the group.

Proposition IV.16. *The post-critical set of a contracting self-similar group with nucleus \mathcal{N} is equal to the post-critical set of the automaton \mathcal{N} .*

Proof. Let \mathcal{P} and $\mathcal{P}_{\mathcal{N}}$ be the post-critical sets of the group G and of its nucleus \mathcal{N} respectively. Let Γ be the Moore diagram of \mathcal{N} .

Take an arbitrary sequence $\dots x_2 x_1 \in \mathcal{P}_{\mathcal{N}}$ and let $\dots e_2 e_1$ be the corresponding left-infinite path in Γ . Let the state g_i be the end of the edge e_i . Then $g_{n+1}|_{x_n} = g_n$ and the state g_1 is non-trivial. There exists a word $v \in X^*$ such that the restriction $g_1|_v$ acts non-trivially on the first level X of the tree X^* . Let $x, y \in X$ be different letters such that $g_1|_v(x) = y$. Then by Proposition II.19 the tiles \mathcal{T}_x and \mathcal{T}_y have non-empty intersection and the sequence $\dots x_2 x_1 v x$ represents a point in this intersection. Hence the sequence $\dots x_2 x_1 v x$ belongs to the critical set of the group G and the sequence $\dots x_2 x_1$ belongs to the post-critical set \mathcal{P} .

Now let us take a sequence $\dots x_2 x_1 \in \mathcal{P}$. There exists a word $v \in X^*$ and a letter $x \in X$ such that the sequence $\dots x_2 x_1 v x$ belongs to the critical set. Then $\dots x_2 x_1 v x$ represents a point in the intersection $\mathcal{T}_x \cap \mathcal{T}_y$ for a letter y different from x . By Proposition II.19 there exist an element $g \in \mathcal{N}$ such that $g(x) = y$ and a left-infinite path $\dots e_2 e_1$ in Γ , which ends in g and is labeled by $\dots x_2 x_1 v |*$. Then the path $\dots e_{k+2} e_{k+1}$, where $k = |v|$, ends in a non-trivial state of the nucleus and is labeled by $\dots x_2 x_1 |*$. So, $\dots x_2 x_1 \in \mathcal{P}_{\mathcal{N}}$. \square

Corollary IV.17. *The (post) critical set of a contracting self-similar group is empty if and only if it is a subgroup of the finitary group.*

If a contracting self-similar group is generated by a finite automaton then one does not need to know the nucleus in order to find the post-critical set of the group, as the next proposition shows.

Proposition IV.18. *Let G be a contracting self-similar group generated by a finite automaton \mathcal{A} . The post-critical set of G is equal to the post-critical set of \mathcal{A} .*

Proof. The proof is similar to the proof of Proposition 3.2.7 in [Nek05], which shows that the asymptotic equivalence relation can be described only by the Moore diagram of the generating automaton.

Let \mathcal{P} and $\mathcal{P}_{\mathcal{A}}$ be the post-critical sets of the group G and the automaton \mathcal{A} respectively. Let $\Gamma_{\mathcal{A}}$ be the Moore diagram of \mathcal{A} .

Take an element $\dots x_2 x_1 \in \mathcal{P}_{\mathcal{A}}$. There exists a left-infinite path $\dots e_2 e_1$ in the graph $\Gamma_{\mathcal{A}}$ such that every edge e_i is labeled by $x_i |*$ or every edge e_i is labeled by $*|x_i$. Let the state s_n be the end of the edge e_n (then s_{n+1} is the beginning of e_n). Then the state s_1 is non-trivial and $s_{n+1}|_{x_n} = s_n$ for all $n \geq 1$ or $s_{n+1}^{-1}|_{x_n} = s_n^{-1}$ for all $n \geq 1$. Since the group is contracting and the automaton \mathcal{A} is finite, there exists a

level k such that the restrictions $s|_v$ and $s^{-1}|_v$ belong to the nucleus \mathcal{N} of the group for every $s \in \mathcal{A}$ and every $v \in X^*$ of length $\geq k$. Then

$$\begin{aligned} \text{either} \quad & s_{n+k}|_{x_{n+k-1}x_{n+k-2}\dots x_{n+1}x_n} = s_n \in \mathcal{N} && \text{for all } n \geq 1 \\ \text{or} \quad & s_{n+k}^{-1}|_{x_{n+k-1}x_{n+k-2}\dots x_{n+1}x_n} = s_n^{-1} \in \mathcal{N} && \text{for all } n \geq 1. \end{aligned}$$

Hence the path $\dots e_2e_1$ is in fact the path in the nucleus, and so $\dots x_2x_1$ belongs to \mathcal{P} by Proposition IV.16.

Now let us take an arbitrary element $\dots x_2x_1 \in \mathcal{P}$ and let $\dots e_2e_1$ be the corresponding left-infinite path in the Moore diagram Γ of the nucleus \mathcal{N} . Let g_n be the end of the edge e_n . Then g_1 is non-trivial and $g_{n+1}|_{x_n} = g_n$ for all $n \geq 1$. There exists a representation $g_n = s_k \dots s_2s_1$ of g_n as a product of the elements of \mathcal{A} and their inverses, where the states $s_i = s_{n,i}$ and the number k depend on n . Such a representation of g_{n+1} defines the representation of g_n in the following way:

$$g_n = g_{n+1}|_{x_n} = s_k|_{s_{k-1}\dots s_2s_1(x_n)} \dots s_2|_{s_1(x_n)}s_1|_{x_n}. \quad (4.3)$$

Since the sequence g_n assumes only a finite number of different values, we can assume that the number k is the same for all n . If needed, the trivial s_i will be written additionally to g_n from the left. Also, we can assume that the restriction of g_{n+1} given by the formula (4.3) is precisely the representation of g_n . Then $s_{n+1,1}|_{x_n} = s_{n,1}$ for all $n \geq 1$. We can assume that $s_{n,1} \in \mathcal{A}$ for all $n \geq 1$ or $s_{n,1} \in \mathcal{A}^{-1}$ for all $n \geq 1$. The sequence of states $s_{n,1}$ defines the left-infinite path in $\Gamma_{\mathcal{A}}$, which is labeled by $\dots x_2x_1|*$ in the first case and by $*|\dots x_2x_1$ in the second case. Since g_1 is non-trivial, $s_{1,1}$ is also non-trivial. So, the sequence $\dots x_2x_1$ belongs to $\mathcal{P}_{\mathcal{A}}$. \square

4 Limit spaces of groups generated by bounded automata

Definition 21. The limit space \mathcal{J}_G of a contracting self-similar group is called *post-critically finite* (p.c.f. for short) if its post-critical set \mathcal{P} is finite.

The following is a joint result with V. Nekrashevych.

Theorem IV.19. *A contracting self-similar group has a post-critically finite limit space if and only if its nucleus is a bounded automaton.*

Proof. Let \mathcal{N} be the nucleus of the group with the Moore diagram Γ .

Suppose that \mathcal{N} is a bounded automaton. By Theorem IV.9 there are only finitely many left-infinite paths in Γ , which end in a non-trivial state. Then there are finitely many left-infinite sequences which are read on these paths. Hence the post-critical set of \mathcal{N} is finite and the limit space is post-critically finite by Proposition IV.16.

In the other direction, let a sequence $\dots x_2x_1 \in X^{-\omega}$ be read on a left-infinite path $\dots e_2e_1$ in Γ , i.e. the edge e_i is labeled by $x_i|*$. If the path $\dots e_2e_1$ in the graph Γ passes through the states $\dots g_2g_1$ (here g_{i+1} is the beginning and g_i is the end of the edge e_i), then the state g_n is uniquely defined by the state g_{n+1} and the letter x_n by $g_n = g_{n+1}|_{x_n}$. It follows, that any given sequence $\dots x_2x_1$ is read on not more than $|\mathcal{N}|$ left-infinite paths in Γ . Consequently, if the post-critical set is finite, then the number of left-infinite paths in Γ , which end in a non-trivial state, is finite and the nucleus \mathcal{N} is a bounded automaton by Theorem IV.9. \square

Corollary IV.20. *A contracting self-similar group has a post-critically finite limit space if and only if it is a subgroup of the group of bounded automata.*

In particular, the group generated by a bounded automaton has a post-critically finite limit space, because the group is contracting by Theorem IV.11.

In the same way one can see that a contracting self-similar group is a subgroup of the group of polynomial automata if and only if the post-critical set of the group is countable.

Proposition IV.21. *Let G be a contracting self-similar group with post-critically finite limit space. Then every element of the post-critical set of the group is a pre-periodic sequence.*

Proof. The nucleus \mathcal{N} of the group G is a bounded automaton. Then the subgraph Γ_{nf} of the Moore diagram of \mathcal{N} spanned by the set of all non-finitary states of \mathcal{N} is a disjoint union of simple cycles by Corollary IV.12. In particular, for every non-finitary state $g \in \mathcal{N}$ there exists precisely one left-infinite path γ_- , which ends in g , and it is of the form $\mathcal{C}^{-\omega}$ for a simple cycle \mathcal{C} . Then the sequence $\dots x_2 x_1$ which is read on this path is periodic. Hence, the corresponding left-infinite sequences for finitary non-trivial states of \mathcal{N} will be pre-periodic. The statement follows from Proposition IV.16. \square

Moreover, the post-critical set of a finite invertible automaton contains only pre-periodic sequences if and only if the automaton is polynomial (see Theorem IV.9).

Post-critically finite self-similar sets are closely related to finitely ramified self-similar sets.

Definition 22. The limit space \mathcal{J}_G of a contracting self-similar group is called *finitely ramified* if every two different tiles of the same level have finite intersection.

Every post-critically finite self-similar set is finitely ramified, but the converse is not true (see [Kig01, Section 1.3]). The situation is different for the limit spaces of groups.

Theorem IV.22. *Let G be a contracting self-similar group. The limit space \mathcal{J}_G is post-critically finite if and only if it is finitely ramified.*

Proof. Suppose that the post-critical set of the group is infinite. For every non-trivial element g of the nucleus \mathcal{N} denote by B_g the set of all sequences $\dots x_2 x_1 \in X^{-\omega}$, which are read on the left-infinite paths in the Moore diagram of \mathcal{N} , which end in g . The union of these sets B_g is the post-critical set of the nucleus and is infinite by Proposition IV.16 and our assumption. Since the nucleus is a finite automaton, there exists an elements $g \in \mathcal{N} \setminus \{1\}$ for which the set B_g is infinite. Since the state g is non-trivial, there exists a word $v \in X^*$ such that $g(v) \neq v$. Then for every sequence $\dots x_2 x_1 \in B_g$ there exists a sequence $\dots y_2 y_1 \in X^{-\omega}$ such that $\dots x_2 x_1 v$ is asymptotically equivalent to $\dots y_2 y_1 g(v)$. Hence, every point of the limit space \mathcal{J}_G represented by a sequence from $B_g v$ belongs to both \mathcal{T}_v and $\mathcal{T}_{g(v)}$. It follows that the intersection $\mathcal{T}_v \cap \mathcal{T}_{g(v)}$ is infinite, since the asymptotic equivalence classes are finite.

On the other hand, suppose that there are two different tiles \mathcal{T}_u and \mathcal{T}_v , $u \neq v$, of the same level $|u| = |v|$, which have an infinite intersection. Then by Corollary II.21 there exists an infinite number of left-infinite paths in the Moore diagram of \mathcal{N} , which end in a non-trivial state. By Theorem IV.9 the automaton \mathcal{N} is not bounded and the limit space of the group G is not post-critically finite. \square

Corollary IV.23. *A contracting self-similar group generated by a finite automaton has post-critically finite (or finitely ramified) limit space if and only if this automaton is bounded.*

Corollary IV.24. *A contracting self-similar group G satisfies the open set condition and the boundary of every tile \mathcal{T}_v , $v \in X^*$, is finite if and only if G is a subgroup of the bounded automata group.*

Proof. If a contracting self-similar group G is a subgroup of the bounded automata

group, then the nucleus of G is a bounded automaton and the group G satisfies the open set condition. If the group satisfies the open set condition, then the finiteness of the boundary of every tile \mathcal{T}_v is equivalent to the finiteness of the post-critical set of the group by Theorem II.20. \square

Corollary IV.25. *A post-critically finite limit space has topological dimension ≤ 1 .*

Proof. A contracting self-similar group with post-critically finite limit space is a subgroup of the bounded automata group. By the previous corollary the tiles \mathcal{T}_v have finite (hence, 0-dimensional) boundary. At the same time, for every point ζ of the limit space \mathcal{J}_G represented by the sequence $\dots x_2x_1$ the collection

$$\left\{ \bigcup_{x \in X} \mathcal{T}_x, \bigcup_{x \in X} \mathcal{T}_{xx_1}, \bigcup_{x \in X} \mathcal{T}_{xx_2x_1}, \dots \right\}$$

forms a basis of neighborhoods of ζ . \square

Also notice, that the limit space \mathcal{J}_G of a contracting self-similar group G satisfying the open set condition has topological dimension 0 if and only if G is a subgroup of the finitary group (in this case \mathcal{J}_G is homeomorphic to the Cantor set X^ω).

CHAPTER V

SCHREIER GRAPHS OF GROUPS GENERATED BY BOUNDED AUTOMATA

In this chapter we study the structure and asymptotic properties of the Schreier graphs of a group generated by a bounded automaton.

In the first section we introduce a construction of inflated graphs, which are iteratively produced from an initial graph using some fixed data, called inflation data. With every inflation data we associate a piecewise linear map of the form $f_{\mathcal{X}} = \min_{A \in \mathcal{X}} A$ and show that the growth of diameters of inflated graphs can be found by iterating this map.

In Section 2 we introduce tile graphs T_n of the group G generated by a bounded automaton, which differ from the Schreier graphs Γ_n by a uniformly bounded number of edges, and in some sense converge to the tile \mathcal{T} of the group. These tile graphs can be constructed using the method of the first section, and in this way we associate a piecewise linear map of the form $f_{\mathcal{X}}$ with every bounded automaton. Now we can effectively find the growth of diameters of the Schreier graphs Γ_n . Using the coefficients associated with the map $f_{\mathcal{X}}$ we can effectively find the orbital contracting coefficient of the group G . If the associated map $f_{\mathcal{X}}$ possesses a strictly positive eigenvector, then we can introduce a nice metric on the limit space \mathcal{J}_G .

Finally, in the last section we consider the orbital Schreier graphs Γ_ω , $\omega \in X^\omega$, and prove that the simple random walk on these graphs is recurrent.

1 Inflation of graphs

In this section all considered graphs are simplicial.

1.1 Definition and basic properties

Definition 23. An *inflation data* $\mathcal{I} = (X, P, E, \psi)$ is given by

1. A finite set X and an arbitrary set P .
2. A set E of unordered pairs of elements of $P \times X$.
3. An injective map $\psi : P \rightarrow P \times X$.

An inflation data is called *finite* if the set P is finite (then also E is finite).

We refer to the set E as to a set of (non-oriented) edges between vertices $P \times X$.

Let Γ be a graph with a map $\varphi : P \rightarrow V(\Gamma)$ which marks some vertices of Γ by elements of P . Using the inflation data \mathcal{I} we can produce a new graph \mathcal{G} with a map $\zeta : P \rightarrow V(\mathcal{G})$ in the following way.

Inflation. Take the disjoint union of $|X|$ copies of the graph Γ , identify its set of vertices with $V(\Gamma) \times X$, and connect vertices (v, x) and (u, y) (here $v, u \in V(\Gamma)$ and $x, y \in X$) by an edge if and only if the vertices v and u are marked correspondingly by p and q , i.e. $\varphi(p) = v$ and $\varphi(q) = u$, and the pair $\{(p, x); (q, y)\}$ belongs to the set E . In this new graph we mark a vertex (w, x) by $p \in P$ if $\psi(p) = (q, x)$ and the vertex w of Γ is marked by q , i.e. we define $\zeta(p) = (\varphi(q), x)$ when $\psi(p) = (q, x)$.

Given an initial graph Γ_0 with $\varphi_0 : P \rightarrow V(\Gamma_0)$ we can construct a sequence of graphs Γ_n with maps $\varphi_n : P \rightarrow V(\Gamma_n)$ applying consequently the inflation rule. The set $\varphi_n(P)$ of marked vertices is thought as a “*boundary*” of the graph Γ_n . To simplify notations for every $p \in P$ the vertex $\varphi_n(p)$ of the graph Γ_n will be denoted just by p . The vertices of the set $\varphi_n(P)$, or by the above agreement the vertices of the set P , are called the *boundary vertices* of the graphs Γ_n .

Definition 24. The graphs $\Gamma_n = \Gamma_n(\mathcal{I})$ are called the *inflated graphs* of the graph Γ_0 using (or by) the inflation data \mathcal{I} .

The vertices of the graph Γ_n are naturally identified with the set $V(\Gamma_0) \times X^n$. In particular, if the graph Γ_0 is finite then all the graphs Γ_n are finite.

In the definition of an inflation data \mathcal{I} we may suppose that the map ψ is not injective, but then we can construct an inflation data \mathcal{J} with a smaller set P which produces graphs $\Gamma_n(\mathcal{J})$ (starting from the graph $\Gamma_1(\mathcal{I})$) isomorphic to $\Gamma_n(\mathcal{I})$ for all $n \geq 2$. The injectivity of the map ψ guarantees that if we start with an injective map $\varphi_0 : P \rightarrow V(\Gamma_0)$ then all the maps $\varphi_n : P \rightarrow V(\Gamma_n)$ will be injective and the boundary vertices are in one to one correspondence with the points of P .

If for a given initial pair (Γ_0, φ_0) all the maps φ_n , $n \geq 0$, of the inflated graphs Γ_n are not injective, then we can construct an inflation data \mathcal{J} with a smaller set P which produces the same graphs Γ_n but the respective maps $\varphi_n(\mathcal{J})$ are injective for all sufficiently large n . So, considering asymptotic properties of the sequence of inflated graphs, we can always suppose that the maps φ_n are injective.

Example 4 (Dual Sierpinski graphs). Consider the inflation data $\mathcal{I}_S = (X, P, E, \psi)$:

1. $X = \{0, 1, 2\}$ and $P = \{a, b, c\}$.
2. $E = \left\{ \{(b, 0); (a, 1)\}, \{(c, 0); (a, 2)\}, \{(c, 1); (b, 2)\} \right\}$.
3. $\psi(a) = (a, 0)$, $\psi(b) = (b, 1)$, $\psi(c) = (c, 2)$.

Let Γ_0 be the graph with one vertex which is labeled by a, b, c . Then the inflated graphs $\Gamma_n(\mathcal{I}_S)$ are the dual Sierpinski graphs (see Figure 7). As was noticed in [GŠ06] these graphs are the simplicial Schreier graphs on levels of the automaton group generated by:

$$a = (a, 1, 1)(1, 2), \quad b = (1, b, 1)(0, 2), \quad c = (1, 1, c)(0, 1).$$

The limit space of this group is homeomorphic to the Sierpinski gasket (see [Nek05, page 112]).

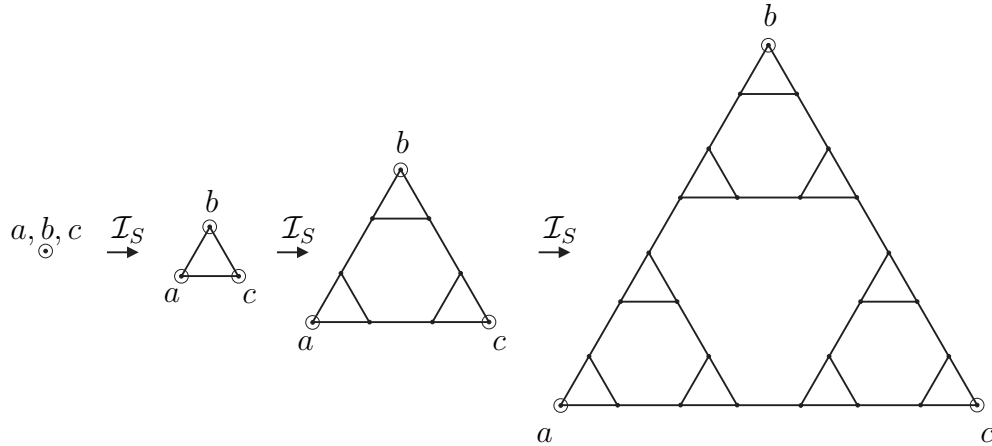

Fig. 7. Dual Sierpinski graphs

Let $\mathcal{I} = (X, P, E, \psi)$ be an inflation data. We can pass to the n -th power of the set X and construct a new inflation data $\mathcal{I}^{(n)} = (X^n, P, E^{(n)}, \psi^{(n)})$, called the n -th iteration of the inflation data \mathcal{I} , with the same set P , where the map $\psi^{(n)} : P \rightarrow P \times X^n$ is defined by n times consequential application of the map ψ on the first coordinate of the image, i.e. defined recursively by the rules:

$$\psi^{(1)} = \psi, \quad \psi^{(n)}(p) = (\psi^{(n-1)}(q), x), \text{ where } \psi(p) = (q, x);$$

the set $E^{(n)}$ of pairs of elements of $P \times X^n$ is defined recursively by the rules: $E^{(1)} = E$; a pair $\{(p, vx), (q, uy)\}$ belongs to $E^{(n)}$ if either $x = y$ and the pair $\{(p, v); (q, u)\}$ belongs to $E^{(n-1)}$, or the pair $\{(p', x); (q', y)\}$ belongs to E with $\psi^{n-1}(p') = (p, v)$ and $\psi^{n-1}(q') = (q, u)$.

By the above construction we get that applying an inflation data n times is the same as applying one time the n -th iteration of the inflation data. More precisely, the following proposition holds.

Proposition V.1. *Let \mathcal{I} be an inflation data and Γ_0 be a graph with a map $\varphi_0 : P \rightarrow$*

$V(\Gamma_0)$, and let $\Gamma_n = \Gamma_n(\mathcal{I})$ and $\Gamma_1^{(n)} = \Gamma_1(\mathcal{I}^{(n)})$ be the corresponding inflated graphs with maps φ_n and $\varphi_1^{(n)}$. Then for every $n \geq 1$ there exists an isomorphism $\zeta : \Gamma_n \rightarrow \Gamma_1^{(n)}$ which preserves marked vertices, i.e. $\varphi_n(p) = v$ if and only if $\varphi_1^{(n)}(p) = \zeta(v)$.

It is easy to check the connectedness of inflated graphs Γ_n .

Proposition V.2. *Let \mathcal{I} be an inflation data. Let T be the graph with the set of vertices X in which two vertices x, y are connected by an edge if and only if there exists a pair $\{(p, x); (q, y)\} \in E$ for some $p, q \in P$. The following conditions are equivalent:*

1. *The graphs Γ_n are connected for all $n \geq 0$.*
2. *The graphs Γ_0 and T are connected.*

Proof. The connectedness of Γ_1 implies the connectedness of T and implication $1 \Rightarrow 2$ is obvious. For the converse we use induction on n . Suppose T and Γ_{n-1} are connected. The components $\Gamma_{n-1}x$ and $\Gamma_{n-1}y$ of the graph Γ_n are connected by an edge if and only if the pair $\{x, y\}$ is an edge of T . The connectedness of Γ_n follows. \square

In particular, if the graph Γ_0 is connected then all graphs Γ_n , $n \geq 1$, are either connected or disconnected. If the graph Γ_0 is not connected, but the graph Γ_1 is, then it is easy to see that the graphs Γ_n are connected for all $n \geq 1$.

1.2 Inflation distance map

Let us understand how the distances between the boundary vertices change when we apply inflation.

Let $\mathcal{I} = (X, P, E, \psi)$ be an inflation data. Let Γ be a graph with an injective map $\varphi : P \rightarrow V(\Gamma)$ and let Γ_1 be the inflated graph with the map $\zeta : P \rightarrow V(\Gamma_1)$ produced from (Γ, φ) by applying \mathcal{I} . Since we want to talk about distances in these graphs, let

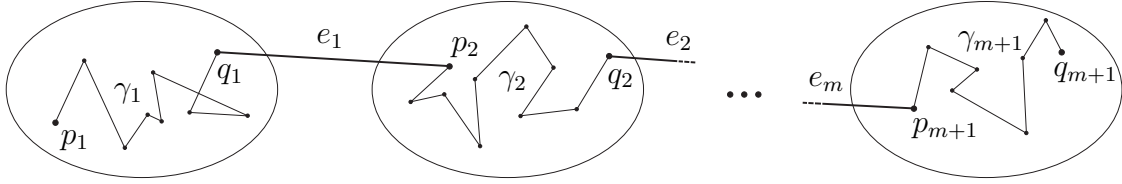

Fig. 8. A path in an inflated graph

us assume that the graphs Γ and Γ_1 are connected (but this is not necessary). Then by the remark after Proposition V.2 all inflated graphs produced from (Γ, φ) using the inflation data \mathcal{I} are connected.

Let γ be a simple path in the graph Γ_1 between boundary vertices p and q (here $p, q \in P$). The path γ can be represented in the form $[\gamma_1]e_1\gamma_2e_2 \dots e_m[\gamma_{m+1}]$, where each γ_i is a path inside some copy of the graph Γ and e_i is an edge of E (it is uniquely defined by the ending of γ_i and the beginning of γ_{i+1} , see Figure 8). Some of the paths γ_i could be trivial and we may have several edges e_i one after another. If we want the path γ to be a geodesic in the graph Γ_1 then all the paths γ_i should be geodesics in the respective copies of the graph Γ . In this case the length of γ is uniquely determined by the sequence of the end vertices of γ_i , which are some boundary vertices p_i, q_i of the respective copy of Γ (here $p_i, q_i \in P$). Thus

$$d_{\Gamma_1}(p, q) = \min_{\gamma} \left(\sum_{\gamma_i} d_{\Gamma}(p_i, q_i) + m^{\gamma} \right), \quad (5.1)$$

where the minimum is taken over all simple paths in Γ_1 between p and q such that all γ_i are geodesics in Γ ; the nonnegative number m^{γ} counts the number of edges e_i in the path γ (notice $m^{\gamma} \leq |E|$).

Let $S = \left\{ \{p, q\} \mid p, q \in P, p \neq q \right\}$ be the state space. Consider the set of distances $d_{\Gamma}(p, q)$ between boundary vertices $p, q \in P$ in the graph Γ as a nonnegative integer

vector \vec{d}_Γ of dimension $|S| = |P|(|P| - 1)/2$ (here the $\{p, q\}$ -th entry of the vector \vec{d}_Γ is equal to $d_\Gamma(p, q)$). Using (5.1) we can define a set \mathcal{K} of nonnegative integer matrices of dimension $|S| \times |S|$ and nonnegative integer vectors m_A of dimension $|S|$ for each $A \in \mathcal{K}$, such that

$$\vec{d}_{\Gamma_1} = \min_{A \in \mathcal{K}} \left(A \vec{d}_\Gamma + m_A \right). \quad (5.2)$$

Notice that the set $\mathcal{K} = \mathcal{K}(\mathcal{I})$ and the vectors $m_A(\mathcal{I})$, $A \in \mathcal{K}$, in the above expression do not depend on initial graph Γ and actually are associated only with the inflation data \mathcal{I} . To see this let us consider another construction, which involves only \mathcal{I} .

Let Γ be the complete graph on the set P (as the set of vertices) and φ be the identity map. Let Γ_1 be the graph obtained from (Γ, φ) using the inflation data \mathcal{I} . For each pair $\{p, q\} \in S$ we define the set $\mathcal{R}_{\{p, q\}}$ of admissible rows and the set $m_{\{p, q\}}$ of admissible numbers as follows. Let γ be a simple path in Γ_1 between the boundary vertices p and q such that every its restriction on a copy of the graph Γ is a geodesic. As before, γ has decomposition $[\gamma_1]e_1\gamma_2e_2 \dots e_m[\gamma_{m+1}]$, where γ_i is an edge (not a path) in some copy of the graph Γ and e_i is an edge of E . For each such a path γ we put $m^\gamma := m$ and define the row \mathcal{R}^γ by the rule

$$\mathcal{R}_{\{p', q'\}}^\gamma = \left| \{ \gamma_i \mid \gamma_i \text{ connects vertices } p' \text{ and } q' \} \right|, \quad \{p', q'\} \in S.$$

Put $\mathcal{R}_{\{p, q\}} = \{ \mathcal{R}^\gamma \}$ and $m_{\{p, q\}} = \{ m^\gamma \}$. Then the set $\mathcal{K}(\mathcal{I})$ and vectors m_A , $A \in \mathcal{K}(\mathcal{I})$, are constructed from $\mathcal{R}_{\{p, q\}}$ and $m_{\{p, q\}}$ as in Section 2 of Chapter III.

Definition 25. The map $f_{\mathcal{I}}(x) = \min_{A \in \mathcal{K}(\mathcal{I})} (Ax + m_A)$ is called *the inflation distance map* associated with the inflation data \mathcal{I} .

Under a few adjustments the above construction of $f_{\mathcal{I}}$ is also valid in the case when the graphs Γ_n produced using \mathcal{I} are not connected (the graph T from

Proposition V.2 is not connected). It is easy to see that if p and q are not connected by a path in Γ_N for some $N \geq 1$ then they will not be connected in Γ_n for all $n \geq N$. Now, if for a pair $\{p, q\}$ there is no path γ in Γ_1 , we remove this pair from the state space S and remove the edge $\{p, q\}$ from the graph Γ and apply the above construction again with the updated Γ . It may happen that we need to delete all the pairs and the state space S will be empty. This just means that for arbitrary initial graph Γ_0 all the boundary vertices will lie in different connected components of Γ_n for all sufficiently large n and the diameters of all connected components of Γ_n are uniformly bounded.

The n -th iteration $f_{\mathcal{I}}^{(n)}$ of the inflation distance map $f_{\mathcal{I}}$ is the inflation distance map associated with the n -th iteration $\mathcal{I}^{(n)}$ of the inflation data \mathcal{I} .

Using the inflation distance map we can find the distances between boundary vertices in all the inflated graphs. We just need to iterate the inflation distance map:

$$\vec{d}_{\Gamma_n} = f_{\mathcal{I}}(\vec{d}_{\Gamma_{n-1}}) = f_{\mathcal{I}}^{(n)}(\vec{d}_{\Gamma_0}), \quad (5.3)$$

for all $n \geq 1$. The initial vector \vec{d}_{Γ_0} (actually every vector \vec{d}_{Γ_n}) in the above recurrence is strictly positive if we assume that the map $\varphi_0 : P \rightarrow V(\Gamma_0)$ is injective and the graph Γ_0 is connected. If the graph Γ_0 is not connected and this leads to the situation when some boundary vertices p, q for $\{p, q\} \in S$ are not connected by a path in Γ_1 , then we can delete the respective component from the recurrence (5.3) and from the state space S accordingly adjusting the map $f_{\mathcal{I}}$ (but only for the specific graph Γ_0).

If an inflation data \mathcal{I} is finite (the set P is finite) then the set $\mathcal{K}(\mathcal{I})$ is finite and the inflation distance map $f_{\mathcal{I}}$ is finite dimensional. In this case, if we are interested only in the asymptotic behavior of the distances \vec{d}_{Γ_n} , we can omit the constant vectors

m_A , consider only the set $\mathcal{K}(\mathcal{I})$ and the corresponding map $f_{\mathcal{K}(\mathcal{I})}(x) = \min_{A \in \mathcal{K}(\mathcal{I})} Ax$. Really, choose a nonnegative vector v such that $m_A \leq v$ for all $A \in \mathcal{K}(\mathcal{I})$. Then $f_{\mathcal{K}(\mathcal{I})}(\cdot) \leq f_{\mathcal{I}}(\cdot) \leq f_{\mathcal{K}(\mathcal{I})}(\cdot) + v$ and iterating we get

$$f_{\mathcal{K}(\mathcal{I})}^{(n)}(\vec{d}_{\Gamma_0}) \leq f_{\mathcal{I}}^{(n)}(\vec{d}_{\Gamma_0}) = \vec{d}_{\Gamma_n} \leq f_{\mathcal{K}(\mathcal{I})}^{(n)}(\vec{d}_{\Gamma_0}) + \sum_{i=0}^{n-1} f_{\mathcal{K}(\mathcal{I})}^{(i)}(v), \quad (5.4)$$

for all $n \geq 1$. From the theory of maps $f_{\mathcal{K}}$ developed in Chapter III we can conclude (see Theorem III.28) that either $d_{\Gamma_n}(p, q) \sim n^k$ or $d_{\Gamma_n}(p, q) \sim n^k \lambda^n$, where the nonnegative integer number k and the real λ depend on p and q . Moreover, there is an effective (algorithmic) method of finding the numbers k and λ . The number λ is no less than 1, since the nonnegative matrices of $\mathcal{K}(\mathcal{I})$ have integer coefficients. For a finite inflation data the associated map $f_{\mathcal{K}(\mathcal{I})}$ is also called *the inflation distance map* and denoted by $f_{\mathcal{I}}$ with a slight ambiguity.

A finite inflation data is called *expanding* if the iterations $f_{\mathcal{I}}^{(n)}(v)$ of its inflation distance map have a component with exponential growth, where v is a strictly positive vector (it is also natural to assume that there are no unbounded components with polynomial growth, but it is not necessary for the next discussion). A sequence of inflated graphs Γ_n is called *expanding* if there is a component of \vec{d}_{Γ_n} which has an exponential growth. It is easy to see (but requires some proof) that then the corresponding inflation data is expanding.

Let Γ_0 be a connected graph with an injective map $\varphi_0 : P \rightarrow V(\Gamma_0)$. The estimates (5.4) together with Lemma III.14 imply that for a component $d_{\Gamma_n}(p, q)$ of \vec{d}_{Γ_n} with exponential growth the asymptotic relation

$$d_{\Gamma_n}(p, q) \sim f_{\mathcal{K}(\mathcal{I})}^{(n)}(\vec{d}_{\Gamma_0})|_{(p,q)} \quad (5.5)$$

holds. In particular, if the inflation data \mathcal{I} is expanding then the sequences of graphs Γ_n is expanding. If the graph Γ_0 is not connected or the map φ_0 is not injective, then

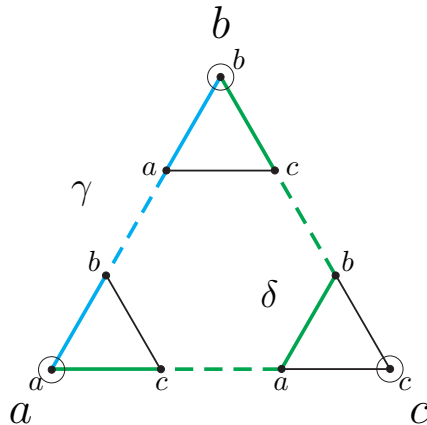

Fig. 9. Construction of inflation distance map for dual Sierpinski graphs

the map $f_{\mathcal{K}(\mathcal{I})}$ will be adjusted and it may happen that the sequence of graphs Γ_n is not expanding. Then, dealing with this particular pair (Γ_0, φ_0) , we use the standard inflation distance map $f_{\mathcal{I}}$ and assume that the inflation data \mathcal{I} is not expanding for this pair. If the sequence $\{\Gamma_n\}$ is expanding, then the asymptotic relation (5.5) is correct for the adjusted map $f_{\mathcal{K}(\mathcal{I})}$.

Define the coefficients $\lambda_{\min}(\mathcal{I})$ and $\lambda_{\max}(\mathcal{I})$ as the minimal and the maximal exponents respectively of the exponential growth (so $\lambda_{\max} \geq \lambda_{\min} > 1$) of components of \vec{d}_{Γ_n} . These coefficients do not depend on (Γ_0, φ_0) , if Γ_n is connected and φ_n is injective for all sufficiently large n . Notice that the \succcurlyeq -minimal exponential component of \vec{d}_{Γ_n} has growth λ_{\min}^n , but the \succcurlyeq -maximal one besides λ_{\max}^n may also have a polynomial part.

Example 5. Let \mathcal{I}_S be the inflation data of the dual Sierpinski graphs defined in Example 4. Let us construct the associated map $f = f_{\mathcal{I}_S}$. Take the complete graph Γ on $\{a, b, c\}$ and construct the graph Γ_1 (shown in Figure 9). For the boundary vertices a and b of Γ_1 there are precisely two simple paths γ and δ (shown as blue

and green), whose restrictions on Γ are geodesics. Then

$$\begin{aligned} \mathcal{R}_{ab}^\gamma &= 2, \mathcal{R}_{bc}^\gamma = 0, \mathcal{R}_{ac}^\gamma = 0, \quad \text{and} \quad m^\gamma = 1; \\ \mathcal{R}_{ab}^\delta &= 1, \mathcal{R}_{bc}^\delta = 1, \mathcal{R}_{ac}^\delta = 1, \quad \text{and} \quad m^\delta = 2. \end{aligned}$$

Similarly for the pairs $\{b, c\}$ and $\{a, c\}$. Then the components of f are defined by

$$\begin{aligned} f(v)_{ab} &= \min\{2v_{ab} + 1, v_{ab} + v_{bc} + v_{ac} + 2\} \\ f(v)_{bc} &= \min\{2v_{bc} + 1, v_{ab} + v_{bc} + v_{ac} + 2\} \\ f(v)_{ac} &= \min\{2v_{ac} + 1, v_{ab} + v_{bc} + v_{ac} + 2\} \end{aligned}$$

for arbitrary vector v . Since each component of $f^{(n)}(v)$ for $v > 0$ has growth 2^n , the inflation data \mathcal{I}_S is expanding.

1.3 Diameters of inflated graphs

Theorem V.3. *Let Γ_n be the inflated graphs produced from a graph Γ_0 using a finite inflation data \mathcal{I} . If the sequence of graphs $\{\Gamma_n\}$ is expanding, then*

$$\text{Diam } \Gamma_n \sim \max_{(p,q)} \left(f_{\mathcal{I}}^{(n)}(v) \right)_{(p,q)},$$

for any strictly positive vector v , where $f_{\mathcal{I}}$ is the inflation distance map of \mathcal{I} (maybe adjusted for the pair (Γ_0, φ_0)). The growth exponent of $\text{Diam } \Gamma_n$ is equal to $\lambda_{\max}(\mathcal{I})$.

Proof. Let the points $p_0, q_0 \in P$ represent the above maximum, i.e.

$$\max_{(p,q)} \left(f_{\mathcal{I}}^{(n)}(\vec{d}_{\Gamma_0}) \right)_{(p,q)} \sim d_{\Gamma_n}(p_0, q_0) \sim n^k \lambda^n$$

for some numbers k and λ . The condition of the theorem implies that $\lambda > 1$.

The diameter of the graph Γ_n is not smaller than $d_{\Gamma_n}(p_0, q_0)$ and we have the estimate from below $\text{Diam } \Gamma_n \gtrsim n^k \lambda^n$. Let us do the estimate from above.

Let γ be a geodesic in the graph Γ_n which represents the diameter. Let v and u be the end vertices of γ . The vertices v and u may not be boundary vertices of Γ_n and may not be boundary vertices of the copies of Γ_{n-1} in which they lie. The path γ can be represented in the form $[\gamma_1]e_1\gamma_2e_2\dots e_m[\gamma_{m+1}]$, where γ_i is a path in some copy of the graph Γ_{n-1} and e_i is an edge of E . The ending of γ_1 , the beginning of γ_{m+1} , and both ends of γ_i for $2 \leq i \leq m$ are boundary vertices (of the respective copies) of the graph Γ_{n-1} . Let us denote them by q_1 , p_{m+1} , and p_i, q_i respectively. Denote the beginning of γ_1 by v_1 and the ending of γ_{m+1} by u_1 . The vertices v_1 and u_1 represent the vertices v and u in the respective copies of the graph Γ_{n-1} . Then

$$d_{\Gamma_n}(v, u) = d_{\Gamma_{n-1}}(v_1, q_1) + \sum_{i=2}^m d_{\Gamma_{n-1}}(p_i, q_i) + d_{\Gamma_{n-1}}(p_{m+1}, u_1) + m. \quad (5.6)$$

Choose a constant C such that $m \leq |E| \leq C$ and $d_{\Gamma_n}(p, q) \leq Cn^k\lambda^n$ for all $p, q \in P$ and all $n \geq 1$. This constant does not depend on n and on a particular choice of a geodesic γ . Then

$$d_{\Gamma_n}(v, u) \leq d_{\Gamma_{n-1}}(v_1, q_1) + d_{\Gamma_{n-1}}(p_{m+1}, u_1) + C^2(n-1)^k\lambda^{n-1}. \quad (5.7)$$

We can do the same calculations for the distances $d_{\Gamma_{n-1}}(v_1, q_1)$ and $d_{\Gamma_{n-1}}(p_{m+1}, u_1)$. Notice that in this case one of the end vertices belongs to P (here $q_1, p_{m+1} \in P$) and thus in the corresponding formula (5.6) we will have only one component $d(\cdot, \cdot)$ not in the summation over i . Then

$$\begin{aligned} d_{\Gamma_{n-1}}(v_1, q_1) &\leq d_{\Gamma_{n-2}}(v_2, q_2) + C^2(n-2)^k\lambda^{n-2}; \\ d_{\Gamma_{n-1}}(p_{m+1}, u_1) &\leq d_{\Gamma_{n-2}}(p_2, u_2) + C^2(n-2)^k\lambda^{n-2}, \end{aligned}$$

for some boundary vertices p_2, q_2 of the graph Γ_{n-2} , where the vertices v_2 and u_2 represent the vertices v_1 and u_1 in the respective copies of the graph Γ_{n-2} . We

continue this process and eventually get

$$d_{\Gamma_{n-1}}(v_1, q_1) \leq d_{\Gamma_0}(v_{n+1}, q_{n+1}) + C^2 \sum_{i=1}^{n-2} i^k \lambda^i \leq C' n^k \lambda^n;$$

$$d_{\Gamma_{n-1}}(p_{m+1}, u_1) \leq d_{\Gamma_0}(p_{n+1}, u_{n+1}) + C^2 \sum_{i=1}^{n-2} i^k \lambda^i \leq C' n^k \lambda^n,$$

for some constant C' which depends only on the numbers C , k , λ , and the diameter of the graph Γ_0 (see Lemma III.14).

Plugging the obtained estimates in (5.7) we get $\text{Diam } \Gamma_n = d_{\Gamma_n}(u, v) \leq n^k \lambda^n$. \square

If the sequences $d_{\Gamma_n}(p, q)$ have polynomial growth for all $p, q \in P$, then let k be such that $\max_{(p,q)} \left(f_{\mathcal{I}}^{(n)}(\vec{d}_{\Gamma_0}) \right)_{(p,q)} \sim n^k$. Then by the same arguments as in the proof of the theorem one can show that either $\text{Diam } \Gamma_n \sim n^k$ or $\text{Diam } \Gamma_n \sim n^{k+1}$. It follows that the exponent of growth of $\text{Diam } \Gamma_n$ is always equal to the exponent of growth of the \succsim -maximal component of $f_{\mathcal{I}}^{(n)}(v)$.

The coefficient $\lambda_{\min}(\mathcal{I})$ will also play an important role in Section 4.

Example 6 (Diameters of the dual Sierpinski graphs). By Example 5 the inflation data \mathcal{I}_S is expanding, we can apply Theorem V.3 and get $\text{Diam } \Gamma_n \sim 2^n$.

2 Structure of Schreier graphs and tile graphs

Let S be a finite invertible automaton. Let $\Gamma_n(S)$ be the corresponding Schreier graphs on levels. Sometimes, instead of considering Schreier graphs $\Gamma_n(S)$, it is better to consider their special subgraphs defined as follows. Let $T_n(S)$ be the graph with the set of vertices X^n in which two vertices v, u are connected if and only if there exists $g \in S$ such that $g(v) = u$ (Schreier graph condition) and $g|_v = 1$. Basically

$$T_n(S) = \Gamma_n(S) \setminus \{ g\text{-edge between } v \text{ and } u, \text{ if } g|_v \neq 1 \}$$

for all $n \geq 1$. We will just write Γ_n and T_n instead of $\Gamma_n(S)$ and $T_n(S)$.

Definition 26. The graphs $T_n(S)$ are called the *tile graphs* of the automaton S .

If the automaton S does not have the identity state, then the tile graphs are totally disconnected.

Suppose S coincides with its nucleus and let \mathcal{P} be the post-critical set of S . Let us describe how to construct the graph Γ_n from the graph T_n . Notice, that if an edge of Γ_n between vertices v and u is absent in T_n , then the words v and u are the restrictions of some post-critical sequences. Define the set of pairs (edges)

$$E(\Gamma \setminus T) = \left\{ \{p, q\} \left| \begin{array}{l} \text{there is a path } \dots e_2 e_1 \text{ in the Moore diagram of } S \\ \text{labeled by } p|q \text{ and ending in a non-trivial state } (p, q \in \mathcal{P}), \\ \text{and there is no such a path ending in the trivial state} \end{array} \right. \right\}.$$

Then, to construct the simplicial graph Γ_n we take the simplicial graph T_n and for each pair $\{p, q\} \in E(\Gamma \setminus T)$ we connect the vertices p_n and q_n by an edge. Notice that if the automaton S is bounded, then the graphs Γ_n and T_n differ by a uniformly bounded number of edges (precisely by $|E(\Gamma \setminus T)|$ edges for all sufficiently large n).

Let G be a contracting self-similar group generated by a finite self-similar set S . While the Schreier graphs $\Gamma_n(S)$ are used to approximate the limit space \mathcal{J}_G , the graphs $T_n(S)$ can be used to approximate the tile \mathcal{T} of the group G . This can be seen similarly to what was done in Section 7 of Chapter II. Define the self-similarity graph $\Omega(G, S)$ as the graph with the set of vertices X^* and two vertices $v, u \in X^*$ belong to a common edge if and only if either $v = xu$ for some $x \in X$ (the vertical edges) or $g(v) = u$ and $g|_v = 1$ for some $g \in S$ (the horizontal edges). The subgraph of $\Omega(G, S)$ spanned by the set of vertices X^n coincides with the graph $T_n(S)$.

Theorem V.4. *The self-similarity graphs $\Omega(G, S)$ and $\Omega(G, S')$, where S and S' are finite generating sets of G , are quasi-isometric. If the group G is contracting then the*

self-similarity graph $\Omega(G, S)$ is a Gromov-hyperbolic space and its hyperbolic boundary is homeomorphic to the tile \mathcal{T} .

Proof. Similar to the proof of Theorem II.22. □

Any sequence $A \in X^{-\omega}$ defines a geodesic $\{A_n | n \geq 1\}$ in the self-similarity graph $\Omega(G, S)$. By the divergence of geodesics in a Gromov-hyperbolic space we get that the sequence $d'_n(A_n, B_n)$, $n \geq 1$, for $A, B \in X^{-\omega}$ is either bounded or has exponential growth, where $d'_n(\cdot, \cdot)$ denotes the distance in the tile graph T_n of a contracting group.

2.1 Connectedness of tile graphs

Since we will deal with distances in the tile graphs T_n , it is better if these graphs are connected (as simplicial graphs) and this can be easily checked.

Proposition V.5. *Let S be a finite invertible automaton, which coincides with its nucleus. If the graph $T_1(S)$ is connected, then all the graphs $T_n(S)$ are connected.*

Proof. Induction on n . Suppose that T_1 and T_{n-1} are connected. If $\{v, u\}$ is an edge of T_{n-1} than for every letter $x \in X$ the pair $\{vx, ux\}$ is an edge of T_n . Hence, $T_{n-1}x$ is a connected subgraph of T_n . Let $\{x, y\}$ be an arbitrary edge of the graph T_1 . There exists an element $g \in S$ such that $g(x) = y$ and $g|_x = 1$. It follows from the definition of a nucleus that there exists a word $v \in X^{n-1}$ and an element $h \in S$ such that $h|_v = g$. Then we get an edge $\{vx, h(v)y\}$ of the graph T_n and thus the components $T_{n-1}x$ and $T_{n-1}y$ are connected by an edge in T_n , if x, y are connected by an edge in T_1 . Hence, the connectedness of T_1 and T_{n-1} implies the connectedness of T_n . □

The graphs $T_n(\mathcal{N})$ can be used to check the connectedness of the tile \mathcal{T} . The following is a joint result with V. Nekrashevych.

Proposition V.6. *Let G be a contracting self-similar group with nucleus \mathcal{N} . The tile \mathcal{T} is connected if and only if the graph $T_1(\mathcal{N})$ is connected.*

Proof. See also Proposition 3.3.4 in [Nek05].

If the tile \mathcal{T} is connected then Proposition II.19 implies that all the graphs $T_n(\mathcal{N})$ are connected. For the proof of the converse, suppose the graph $T_1(\mathcal{N})$ is connected but the tile \mathcal{T} is not. Then the graphs $T_n(\mathcal{N})$ are connected by Proposition V.5. Then there exists a closed non-empty set $\mathcal{A} \subset \mathcal{T}$ with non-empty closed complement $\mathcal{T} \setminus \mathcal{A}$. Let $\mathcal{A}_\omega \subset X^{-\omega}$ be the preimage of \mathcal{A} under the canonical projection $X^{-\omega} \rightarrow \mathcal{T}$. Then the set \mathcal{A}_ω is also closed and has a non-empty closed complement.

For every $n \geq 1$ let $\mathcal{A}_n \subset X^n$ be the set of all possible endings of length n of the infinite words belonging to \mathcal{A}_ω . Since the set \mathcal{A}_ω is closed, a sequence $\dots x_2 x_1$ represents an element of \mathcal{A} if and only if $x_n x_{n-1} \dots x_1 \in \mathcal{A}_n$ for all $n \geq 1$.

There exists n_0 such that for every $n \geq n_0$ the set \mathcal{A}_n is not equal to X^n . Since the graph $T_n(\mathcal{N})$ is connected, there exists a word $v_n \in \mathcal{A}_n$ and an element $g_n \in \mathcal{N}$ such that $g_n(v_n) \in X^n \setminus \mathcal{A}_n$ and $g_n|_{v_n} = 1$. By compactness arguments there exists an increasing sequence n_k such that both sequences v_{n_k} and $g_{n_k}(v_{n_k})$ converge to certain elements $\xi = \dots x_2 x_1$ and $\zeta = \dots y_2 y_1$ of $X^{-\omega}$ respectively. Then $\xi \in \mathcal{A}_\omega$ and $\zeta \in X^{-\omega} \setminus \mathcal{A}_\omega$, since both sets \mathcal{A}_ω and $X^{-\omega} \setminus \mathcal{A}_\omega$ are closed. The word $x_n x_{n-1} \dots x_1$ is an ending of v_{n_k} and $y_n y_{n-1} \dots y_1$ is an ending of $g_{n_k}(v_{n_k})$ for every $n \geq 1$ and all sufficiently large n_k . Let $s_n = g_{n_k}|_u$, where $v_{n_k} = u x_n x_{n-1} \dots x_1$. Then $s_n \in \mathcal{N}$ satisfies $s_n(x_n x_{n-1} \dots x_1) = y_n y_{n-1} \dots y_1$ and $s_n|_{x_n x_{n-1} \dots x_1} = 1$. Therefore, ξ and ζ are asymptotically equivalent and represent equal points of the tile \mathcal{T} , which contradicts the choice of the set \mathcal{A} . \square

The following observation is due to L. Bartholdi and V. Nekrashevych.

Proposition V.7. *Let G be a level-transitive self-similar group generated by a*

bounded automaton S , which coincides with its nucleus and without non-trivial finitary elements. Then the graphs $T_n(S)$ are connected.

Proof. The graphs $\Gamma_n(S)$ are connected. Let $g(v) = u$ for $v \in X^*$ and $g|_v \neq 1$. The conditions on the automaton S imply that for every $g \in S$ and for every level n such a word $v \in X^n$ exists only one. Thus in the graph $T_n(S)$ we have the following path

$$u, g(u), g^2(u), \dots, g^k(u) = v$$

which connects v and u . □

2.2 Tile graphs as inflated graphs

Let us show that the tile graphs $T_n(S)$ can be produced by the method described in Section 1 of this chapter. It can be done in a natural way if we restrict ourself to the case when the automaton S coincides with its nucleus. It covers the case of a self-replicating contracting self-similar group, and also we can always make this restriction when we deal with the asymptotic behavior of diameters of Schreier graphs and the orbital contracting coefficient of a contracting group by Proposition II.17.

With every finite invertible automaton S , which coincides with its nucleus, we associate the *inflation data* $\mathcal{I}_S = (X, \mathcal{P}, E, \psi)$, where

1. The set X is the alphabet and the set \mathcal{P} is the post-critical set of S .
2. The set E is the set of all pairs $\{(p, x); (q, y)\}$ such that there exists a path $\dots e_2 e_1$ in the Moore diagram of S which ends in the trivial state and is labeled by the pair $px|qy$ (here $p, q \in \mathcal{P}$ and $x, y \in X$).
3. The map $\psi : \mathcal{P} \rightarrow \mathcal{P} \times X$ is defined by the rule $\psi(p) = (\tau(p), x_p)$, where x_p is the last letter of the left-infinite sequence p .

Clearly the map ψ is injective, because p and $\tau(p)x_p$ are equal as infinite words.

Theorem V.8. *Let S be a finite invertible automaton, which coincides with its nucleus, with inflation data $\mathcal{I}_S = (X, \mathcal{P}, E, \psi)$. Let \mathcal{G}_0 be the graph with a single vertex marked by the elements of \mathcal{P} . The inflated graphs \mathcal{G}_n produced from \mathcal{G}_0 using \mathcal{I}_S are the simplicial tile graphs $T_n(S)$.*

Proof. We will use the same notation for the simplicial graph as for the graph itself.

The set of vertices of \mathcal{G}_n is naturally identified with the set X^n and we suppose that the graphs T_n and \mathcal{G}_n have the same set of vertices X^n . The graphs \mathcal{G}_n also come together with the maps $\zeta_n : \mathcal{P} \rightarrow V(\mathcal{G}_n) = X^n$. Define the map $\varphi_n : \mathcal{P} \rightarrow V(T_n) = X^n$ by the rule $\varphi_n(p) = v$ if the word v is the restriction of p on the n -th level.

By induction on n . We have $T_0 = \mathcal{G}_0$. Suppose that $T_n = \mathcal{G}_n$ and the marked vertices in one graph correspond to the marked vertices in another one, i.e. $\varphi_n(p) = \zeta_n(p)$ for all $p \in \mathcal{P}$.

For every letter $x \in X$ consider the subgraph T_{n+1}^x of T_{n+1} spanned by the set $X^n x$. Two vertices vx and ux are connected by an edge in T_{n+1}^x if there exists $g \in S$ such that $g(vx) = ux$ and $g|_{vx} = 1$. In particular T_n is the subgraph of T_{n+1}^x (with a natural identification between X^n and $X^n x$) for every $x \in X$.

Let us understand what are the edges of T_{n+1} that may not be in the disjoint union $\cup_{x \in X} T_n x$ of $|X|$ copies of the graph T_n . Let $\{vy, uz\}$ be such an edge. Then there is an element $g \in S$ such that $g(vy) = uz$ and $g|_{vy} = 1$. Notice that $g|_v \neq 1$. Let $e_n e_{n-1} \dots e_1 e_0$ be the corresponding path in the Moore diagram of S labeled by $vy|uz$ (here the edge e_0 ends in 1). Since the automaton S coincides with its nucleus, the finite path $e_n e_{n-1} \dots e_1 e_0$ can be continued to the left-infinite one labeled by the pair $py|qz$, where p and q are some post-critical sequences. The vertices v and u are marked by p and q respectively, and the edge $\{(p, y); (q, z)\}$ belongs to the set E . It

means that to construct the graph T_{n+1} we need to take a copy of the graph T_n for each $x \in X$ and connect marked vertices according to the rule E . This is precisely the inflation rule for construction of \mathcal{G}_{n+1} .

If the vertex v of T_n is labeled by q and $p = qx \in \mathcal{P}$ then the vertex vx of T_{n+1} is labeled by p . This is precisely the rule for marking vertices of \mathcal{G}_{n+1} . \square

Let G be the group generated by a bounded automaton S . The inflation data $\mathcal{I}_{\mathcal{N}}$ associated with the nucleus \mathcal{N} of the group G is called the *inflation data associated with G* and is denoted by \mathcal{I}_G . The corresponding inflation distance map $f_{\mathcal{I}_{\mathcal{N}}}$ and the coefficients $\lambda_{\min}(\mathcal{I}_{\mathcal{N}})$, $\lambda_{\max}(\mathcal{I}_{\mathcal{N}})$ are denoted by f_G and $\lambda_{\min}(G)$, $\lambda_{\max}(G)$ correspondingly. Notice that Proposition IV.18 implies that the inflation data $\mathcal{I}_{\mathcal{N}(S)}$ associated with the nucleus $\mathcal{N}(S)$ of the automaton S and the inflation data $\mathcal{I}_{\mathcal{N}}$ coincide for any generating automaton S of the group G .

If a bounded automaton S does not coincide with its nucleus then the simplicial tile graphs $T_n(S)$ may not coincide with the inflated graphs produced using \mathcal{I}_G . However the asymptotic properties of these graphs, which we will discuss, remain the same (see Proposition II.17 and Proposition V.9 below). Nevertheless observe that even if $S \neq \mathcal{N}(S)$ we can pass to some power X^n of the alphabet and define the inflation data \mathcal{I}_S such that Theorem V.8 holds (but starting from the graph Γ_1 instead of \mathcal{G}_0). This construction is somewhat artificial and not important for the rest of the context. In the sequel, when we talk about the inflation data \mathcal{I}_S one can suppose that we consider the inflation data $\mathcal{I}_{\mathcal{N}(S)} = \mathcal{I}_G$.

3 Growth of diameters of Schreier graphs Γ_n

Denote by $d_n(\cdot, \cdot)$ and $d'_n(\cdot, \cdot)$ the distances in the Schreier graphs Γ_n and the tile graphs T_n respectively.

Proposition V.9. *The asymptotic relation $\text{Diam } \Gamma_n(S) \sim \text{Diam } T_n(S)$ holds for any bounded automaton S .*

Proof. Notice that for any (not necessarily connected) graph Γ and any bundle e_1, e_2, \dots, e_k of its edges the diameter of the graph $\Gamma' = \Gamma \setminus \{e_1, e_2, \dots, e_k\}$ satisfies inequalities:

$$\frac{1}{2^k} \text{Diam } \Gamma \leq \text{Diam } \Gamma' \leq 2^k \text{Diam } \Gamma.$$

By construction, the graph T_n is missing not more than $|E(\Gamma \setminus T)| \leq |\mathcal{P}|(|\mathcal{P}| - 1)/2$ edges of the graph Γ_n , where \mathcal{P} is the finite post-critical set of the bounded automaton S . Hence, $\text{Diam } \Gamma_n \sim \text{Diam } T_n$. \square

Theorem V.10. *Let G be the group generated by a bounded automaton S . The asymptotic relation*

$$\text{Diam } \Gamma_n(G, S) \sim \max_i \left(f_G^{(n)}(v) \right)_i$$

holds for any strictly positive vector v .

Proof. Let \mathcal{N} be the nucleus of the group G and \mathcal{P} be its post-critical set. Since the automaton S is bounded, the post-critical set \mathcal{P} is finite and the inflation data \mathcal{I}_G is finite. The group G_1 generated by \mathcal{N} is contracting and hence the self-similarity graph $\Omega(G_1, \mathcal{N})$ is a Gromov-hyperbolic space by Theorem V.4. Then for any two points $A, B \in X^{-\omega}$ on the boundary of $\Omega(G_1, \mathcal{N})$ the sequence of distances $d'_n(A_n, B_n)$, $n \geq 1$, in the tile graphs $T_n(\mathcal{N})$ is either bounded or has exponential growth. In particular, it is true for the post-critical points in \mathcal{P} .

If the diameters of the Schreier graphs $\Gamma_n(G, S)$ are uniformly bounded (the group G is finite) then the sequence $d'_n(p_n, q_n)$ is bounded for all $p, q \in \mathcal{P}$ and the statement follows.

If the diameters of the Schreier graphs $\Gamma_n(G, S)$ are not uniformly bounded (the group G is infinite) then the diameters of the tile graphs $T_n(S)$ and $T_n(\mathcal{N})$ are

not uniformly bounded. The remark after Theorem V.3 implies that some sequence $d'_n(p_n, q_n)$ for $p, q \in \mathcal{P}$ is unbounded and thus has exponential growth. Hence, the inflation data \mathcal{I}_G is expanding (the sequence of inflated graphs $T_n(\mathcal{N})$ is expanding) and we can apply Theorem V.3:

$$\text{Diam } \Gamma_n(G, S) \sim \text{Diam } \Gamma_n(\mathcal{N}) \sim \text{Diam } T_n(\mathcal{N}) \sim \max_i \left(f_G^{(n)}(v) \right)_i,$$

where v is an arbitrary strictly positive vector. □

Corollary V.11. *The growth exponent of diameters of the Schreier graphs Γ_n is equal to $\lambda_{\max}(G)$ and the coefficient $\rho_d(G)$ is equal to $1/\lambda_{\max}(G)$.*

If the group G is level-transitive, then the inflation data is expanding and some sequence $d'_n(p_n, q_n)$ for $p, q \in \mathcal{P}$ has exponential growth. At the same time, it may be not true for the sequences $d_n(p_n, q_n)$ in the Schreier graphs. It is possible that all of them are bounded (see Example 1 in Chapter VI).

4 Orbital contracting coefficient of bounded automaton groups

Let G be a level-transitive self-similar group generated by a bounded automaton S and let \mathcal{N} be the nucleus of G . Let $\mathcal{I}_G = (X, \mathcal{P}, E, \psi)$ be the inflation data associated with the group G (the inflation data $\mathcal{I}_{\mathcal{N}}$). We will prove that the orbital contracting coefficient $\rho_o(G)$ is equal to $1/\lambda_{\min}$, here $\lambda_{\min} = \lambda_{\min}(G)$.

Without loss of generality we always suppose that the automaton S coincides with its nucleus and hence the simplicial tile graphs $T_n(S)$ are the inflated graphs produced by the inflation data \mathcal{I}_G (actually we can suppose that $S = \mathcal{N}$).

In the next two sections we establish some properties of geodesics and distances in the Schreier graphs and tile graphs, which will be used to get estimates on the orbital contracting coefficient.

4.1 Decomposition of geodesics in tile graphs

Let Γ_n and T_n be the Schreier graphs and the tile graphs of the group G associated with the automaton S .

The iterations of the inflation distance map f_G allow us to compute the asymptotic behavior of the sequences $d'_n(p_n, q_n)$ for all $p, q \in \mathcal{P}$. So, for every pair $p, q \in \mathcal{P}$ we can find two numbers $k \in \mathbb{N}$ and $\lambda \in \mathbb{R}$ such that $d'_n(p_n, q_n) \sim n^k \lambda^n$. If the sequence $d'_n(p_n, q_n)$ is bounded we call the post-critical points p and q *asymptotically equal* (they are asymptotically equivalent and represent the same point in the limit space \mathcal{J}_G). The vertices p_n, q_n are connected by an edge in the tile graph $T_n(\mathcal{N})$ for every asymptotically equal $p, q \in \mathcal{P}$. In particular, the pre-periods of these sequences have the same length. By the remark after Theorem V.4, if p and q are not asymptotically equal, then the corresponding exponent λ is greater than 1.

Let us understand how to find the asymptotic behavior of the sequence of distances $d_n(p_n, q_n)$, $n \geq 1$, for $p, q \in \mathcal{P}$ in the Schreier graphs Γ_n . The graph Γ_n can be constructed from the copies of the graph T_{n-1} in the same way as T_n except that we can use not only the edges from E but also the edges from $E(\Gamma \setminus T)$. Since both of these sets are finite, we have

$$d_n(p_n, q_n) = \min_{\gamma} \left(\sum_{\gamma_i} d'_{n-1}(r_{n-1}, t_{n-1}) + m^\gamma \right),$$

where the minimum is taken over the finite number of paths γ between p_n and q_n . Each γ_i is the piece of γ in a copy of T_{n-1} and the boundary vertices r_{n-1}, t_{n-1} are the ends of γ_i . Since we know the asymptotic behavior of each $d'_{n-1}(r_{n-1}, t_{n-1})$ we can find the asymptotic behavior of $d_n(p_n, q_n)$.

Let us consider the decomposition of geodesics in the tile graph T_n induced by the inflation production of T_n from T_{n-1} , similarly to what was done in Section 1.2

when the inflation distance map was constructed. Let γ be a geodesic in the graph T_n between two vertices v and u . We want to write the distance between v and u as the sum of distances between boundary vertices (in different graphs T_i). The path γ can be represented in the form $[\gamma_1]e_1\gamma_2e_2\dots e_m[\gamma_{m+1}]$, where γ_i is a geodesic in some copy of the graph T_{n-1} in the graph T_n and e_i is an edge of E (it is uniquely defined by the ending of γ_i and the beginning of γ_{i+1}). Some of the paths γ_i can be trivial (empty). The number m is not greater than $|E|$. Sometimes we will write $\gamma(n)$ instead of γ and $\gamma_i(n-1)$ instead of γ_i referring to the level on which geodesics lie. The edges $e_i = e_i(n-1)$ will be called the edges of level $n-1$ referring to the fact they connect copies of the graph T_{n-1} in the graph T_n .

The path γ_1 (or the edge e_1 if γ_1 is empty) begins in the vertex $\tau(v)$, and the path γ_{m+1} (or the edge e_m if γ_{m+1} is empty) ends in the vertex $\tau(u)$. All the other ends of the paths γ_i are the boundary vertices of the respective copies of the graph T_{n-1} . Then the length of the geodesic γ is equal to

$$\begin{aligned} d'_n(u, v) &= |\gamma| = \sum_{\gamma_i} |\gamma_i| + m = \\ &= d'_{n-1}(\tau(v), p_{n-1}) + \sum_{\gamma_i} d'_{n-1}(r_{n-1}, t_{n-1}) + d'_{n-1}(q_{n-1}, \tau(u)) + m, \end{aligned} \tag{5.8}$$

where the vertices r_{n-1}, t_{n-1} are the ends of the path γ_i , and the last sum is taken over all γ_i except γ_1 and γ_{m+1} . All r, t and p, q are the post-critical sequences ($r, t, p, q \in \mathcal{P}$).

If $\tau(v)$ and $\tau(u)$ are the boundary vertices of T_{n-1} , then we can approximate the length of γ knowing the asymptotic behaviour of $d'_n(p_n, q_n)$ for $p, q \in \mathcal{P}$.

If $\tau(v)$ is not a boundary vertex of T_{n-1} , then we consider the geodesic γ_1 in T_{n-1} and find the corresponding representation $[\gamma'_1]e'_1\gamma'_2e'_2\dots e'_{m'}[\gamma'_{m'+1}]$ of γ_1 using the inflation production of T_{n-1} from T_{n-2} . Here $\gamma'_i = \gamma'_i(n-2)$ and $e'_i = e'_i(n-2)$. All the ends of the paths γ'_i are the boundary vertices of the copies of T_{n-2} , maybe

except the beginning vertex $\tau^2(v)$ of the geodesic γ'_1 . We can continue with the path γ'_1 in the graph T_{n-2} and so on until all the ends of the paths γ_i are either the boundary vertices in the respective tile graphs or they belong to the graph T_1 .

By the same arguments we can get a representation of the path γ_{m+1} if the end vertex $\tau(u)$ is not a boundary vertex of T_{n-1} . Putting the obtained representations of γ_1 and γ_{m+1} in the representation of γ we get

$$[\eta_1]e_1\eta_2e_2\dots e_l[\eta_l], \quad (5.9)$$

where $\eta_i = \eta_i(n_i)$ is a geodesic in a copy of the graph T_{n_i} and $e_i = e_i(m_i)$ is an edge of E of the level m_i . The number l is not greater than $2(n-2)|E| + |E|$. The ends of η_i are the boundary vertices of T_{n_i} or some vertices of T_1 . Let us show that the representation of γ cannot consist mainly of the edges e_i .

Lemma V.12. *There exists a number $K \geq 1$, which depends only on the automaton S , such that the representation of γ cannot contain a sequence $e_{i+1}, \gamma_{i+2}, e_{i+2}, \gamma_{i+3}, \dots, \gamma_{i+K}, e_{i+K}$, where the ends of each $\gamma_{i+2}, \dots, \gamma_{i+K}$ are represented by asymptotically equal post-critical sequences.*

Proof. Notice, that the pre-periods of two post-critical sequences, which are asymptotically equal or represent the ends of an edge $e \in E$, have the same length.

The ends of the edge $e_i = e(n_i)$ can be parameterized by the same post-critical sequences (for example, $e = \{(p, x); (p, y)\}$) only if this edge connects different copies of the graph T_{n_i} (here $x \neq y$). The ends of a non-trivial path γ_i are always parameterized by different post-critical sequences.

For $K > |E|$ the representation of γ cannot contain a subsequence $e_{i+1}, \gamma_{i+2}, e_{i+2}, \gamma_{i+3}, \dots, \gamma_{i+K}, e_{i+K}$, where each e_j and γ_j are of the same level.

Let the edge $e_i = e_i(n_i)$ be followed by the non-trivial path $\gamma_{i+1} = \gamma_{i+1}(n_{i+1})$ of

a different level $n_i \neq n_{i+1}$. Let $e_i = \{p_{n_i}x, q_{n_i}y\}$ and the ends of γ_{i+1} are $p'_{n_{i+1}}y$ and $q'_{n_{i+1}}y$ for $p, q, p', q' \in \mathcal{P}$. If $n_i > n_{i+1}$ then the pre-periods of p' and q' are strictly less than the pre-periods of p and q ; and p, q cannot be periodic, because otherwise there exists a left-infinite path in the Moore diagram of the nucleus ending in the trivial state and labeled by a periodic sequence $p'|q'$, which is possible only when $p' = q'$. If $n_i < n_{i+1}$ then the pre-periods of p and q are strictly less than the pre-periods of p' and q' .

These observations imply the existence of a constant K that satisfies the lemma. For example, we can choose $K = 2(|E| + 1)(l + 1)$, where l is the length of the longest pre-period of the sequences from \mathcal{P} . \square

In particular, the representation of γ cannot contain a sequence of edges $e_{i+1}, e_{i+2}, \dots, e_{i+K}$ one after another (the paths $\gamma_{i+2}, \gamma_{i+3}, \dots, \gamma_{i+K}$ are trivial).

Also Lemma V.12 implies that if the length of the geodesic γ is sufficiently large, than the decomposition of γ contains a geodesic γ_i , whose ends are the boundary vertices, and whose length is comparable with the length of γ .

Let γ be a geodesic in the Schreier graph Γ_n . We can express γ as a finite sequence of geodesics in T_n and edges of $E(\Gamma \setminus T)$. Finding the representation of each such sub-geodesic, we get a decomposition of γ similar to (5.9).

4.2 Asymptotic behavior of distances

Lemma V.13. *There exists a constant C , which depends only on the automaton S , such that for arbitrary $A, B \in X^{-\omega}$ the following properties hold:*

- (i) *if the sequence $d_n(A_n, B_n)$ is bounded, then $d_n(A_n, B_n) \leq C$ for all n ;*
- (ii) *if the sequence $d'_n(A_n, B_n)$ is bounded, then $d'_n(A_n, B_n) \leq C$ for all n .*

Proof. Since $d_n(A_n, B_n)$, $n \geq 1$, is bounded there exists a bounded sequence $g_n \in G$ such that $g_n(A_n) = B_n$ for all $n \geq 1$. Find k such that the restrictions of all g_n on any word of length $\geq k$ belong to \mathcal{N} . Let $A = \dots x_2 x_1$ then

$$h(A_n) = B_n, \quad \text{for } h = g_{n+k}|_{x_{n+k}x_{n+k-1}\dots x_{n+1}} \in \mathcal{N}.$$

So, $d_n(A_n, B_n) \leq C$ for all n , where $C = \max_{h \in \mathcal{N}} l_S(h)$.

The proof of (ii) goes similarly. □

If the graphs Γ_n and T_n are associated with the nucleus \mathcal{N} of the group G , then we can choose $C = 1$. In particular, if two finite words $v, u \in X^k$, $k \geq 1$, are not connected by an edge in $\Gamma_k(\mathcal{N})$ then we cannot find letters $x_i, y_i \in X$, $i \geq 1$, to make the sequence of distances

$$d_n(x_{n-k} \dots x_2 x_1 u, y_{n-k} \dots y_2 y_1 v), \quad n \geq 1$$

bounded. The same observation holds for the tile graphs $T_n(\mathcal{N})$.

Lemma V.14. *Take arbitrary $p, q \in \mathcal{P}$ and $v, u \in X^k$, $k \geq 1$. Then*

(i) $d'_{n+k}(p_n v, q_n u)$, $n \geq 1$, is either bounded or $\sim d'_n(p'_n, q'_n)$ for some $p', q' \in \mathcal{P}$;

(ii) $d_{n+k}(p_n v, q_n u)$, $n \geq 1$, is either bounded or $\sim d'_n(p'_n, q'_n)$ for some $p', q' \in \mathcal{P}$.

Proof. For every n the graph T_{n+k} is the inflated graph produced from T_n using the finite inflation data $\mathcal{I}_G^{(k)} = (X^k, \mathcal{P}, E^{(k)}, \psi^{(k)})$. Let $\gamma = \gamma(n)$ be a geodesic in T_{n+k} connecting the vertices $p_n v$ and $q_n u$. Then γ can be represented in the form $[\gamma_1]e_1\gamma_2e_2\dots e_m[\gamma_{m+1}]$, where γ_i is a geodesic in some copy of the graph T_n in the graph T_{n+k} and e_i is an edge of $E^{(k)}$ (the number $m = m(n)$ is not greater than $|E^{(k)}|$). If the distance $d'_{n+k}(p_n v, q_n u)$ is not bounded, then at least one of the paths γ_i is not trivial for all sufficiently large n . The ends of each path γ_i are the boundary

vertices (of the respective copy) of the graph T_n . In particular, $|\gamma_i| = d'_n(p'_n, q'_n)$ for some $p', q' \in \mathcal{P}$. Denote by $\gamma_{\max} = \gamma_{\max}(n)$ the longest path γ_i in the representation of γ . Since the set \mathcal{P} is finite, without loss of generality we may assume that the ends of the path $\gamma_{\max}(n)$ are represented by the same $p', q' \in \mathcal{P}$ for all sufficiently large n . Then, $d'_{n+k}(p_nv, q_nu) \sim |\gamma_{\max}(n)| \sim d'_n(p'_n, q'_n)$.

The proof of (ii) goes similarly. □

Let us be more precise and explain “without loss of generality” at the ends of the previous proof. We can chose $p', q' \in \mathcal{P}$, which represent the ends of the path $\gamma_{\max}(n)$ for infinitely many n . Let us show that $d'_{n+k}(p_nv, q_nu) \sim d'_n(p'_n, q'_n)$. Clearly $d'_{n+k}(p_nv, q_nu) \sim |\gamma_{\max}(n)|$. So, it is enough to show that if $p'', q'' \in \mathcal{P}$ also represent the ends of the path $\gamma_{\max}(n)$ for infinitely many n , then $d'_n(p'_n, q'_n) \sim d'_n(p''_n, q''_n)$. Let n_1, n_2 be such that the pairs $\{p', q'\}$ and $\{p'', q''\}$ represent the ends of the paths $\gamma_{\max}(n_1)$ and $\gamma_{\max}(n_2)$ respectively. Suppose $n_2 > n_1$. By applying the power $\sigma^{n_2-n_1}$ of the shift map to the geodesic $\gamma(n_2)$ (to every vertex of the path $\gamma(n_2)$) we get a path η between $p_{n_1}v$ and $q_{n_1}u$ in the graph T_{n_1+k} . Then

$$\begin{aligned} d'_{n_1}(p'_{n_1}, q'_{n_1}) &= |\gamma_{\max}(n_1)| \leq |\gamma(n_1)| = d'_{n_1+k}(p_{n_1}v, q_{n_1}u) \leq |\eta| \leq \\ &\leq \sum_{i=1}^{m+1} |\sigma^{n_2-n_1}(\gamma_i(n_2))| + m \leq (m+1)Cd'_{n_1}(p''_{n_1}, q''_{n_1}) + m, \end{aligned}$$

where the constant $C > 0$ depends only on the inflation data \mathcal{I}_S and we assume n_1 is large enough. By choosing $n_2 > n_1$ we get the same inequalities with interchanged $\{p', q'\}$ and $\{p'', q''\}$. Hence $d'_n(p', q') \sim d'_n(p''_n, q''_n)$ and we are done. To be more precise in the choice of the constant C , we assume that the level n is large enough so that for all $P, Q, P', Q' \in \mathcal{P}$ the inequality $d'_n(P_n, Q_n) \leq d'_n(P'_n, Q'_n)$ implies the asymptotic relation $d'_n(P_n, Q_n) \preceq d'_n(P'_n, Q'_n)$. In particular, if $P, Q \in \mathcal{P}$ represent the ends of the path $\gamma_{\max}(n_1)$, then $d'_n(P_n, Q_n) \succeq d'_n(P'_n, Q'_n)$ for all the other $P', Q' \in \mathcal{P}$ which

represent the ends of $\gamma_i(n_1)$, $i = 1, 2, \dots, m + 1$. Then we choose a constant $C > 0$ such that for all $P, Q, P', Q' \in \mathcal{P}$ the asymptotic relation $d'_n(P_n, Q_n) \preceq d'_n(P'_n, Q'_n)$ implies $d'_n(P_n, Q_n) \leq C d'_n(P'_n, Q'_n)$ for all sufficiently large n .

The \succ -smallest asymptotic behavior among the unbounded sequences of distances $d'_n(p_n, q_n)$ for $p, q \in \mathcal{P}$ is equivalent to λ_{\min}^n . Hence, Lemma V.14 shows that the unboundedness of the sequence $d'_{n+k}(p_n v, q_n u)$ ($d_{n+k}(p_n v, q_n u)$) implies the asymptotic relation $d'_{n+k}(p_n v, q_n u) \succeq \lambda_{\min}^n$ ($d_{n+k}(p_n v, q_n u) \succeq \lambda_{\min}^n$). Let us show that this is true for all left-infinite sequences over the alphabet X .

Lemma V.15. *Take arbitrary $A, B \in X^{-\omega}$. Then the sequence $d_n(A_n, B_n)$ is either bounded or the asymptotic relation $d_n(A_n, B_n) \succeq \lambda_{\min}^n$ holds.*

Proof. It is easy to see that for every $A, B \in X^{-\omega}$ there exist $A', B' \in X^{-\omega}$ such that $d_n(A_n, B_n) \sim d'_n(A'_n, B'_n)$ (just use the decomposition of geodesics in Γ_n). So, it is sufficient to prove the lemma for the tile graphs and its distance $d'_n(\cdot, \cdot)$.

Suppose that the sequence $d'_n(A_n, B_n)$ is unbounded. For each level n fix a geodesic $\gamma = \gamma(n)$ between A_n and B_n in the graph T_n . Let us prove that there exists $m \geq 1$ such that the decomposition (5.9) of the geodesic $\gamma(n + m)$ for all sufficiently large n contains a non-trivial geodesic γ_i of level $\geq n$, whose ends p, q are the boundary vertices with unbounded sequence $d'_n(p_n, q_n)$. Then the statement of the lemma follows.

Notice that if we choose m such that the words A_m and B_m differ in at least one letter, then the decomposition of $\gamma(n)$ for all $n > m$ should contain some edge $e \in E$ of the level $\geq n - m$. Since the set E is finite, without loss of generality, we may suppose that the edge e is the same for all n . Choosing one end of e instead of A or B we can assume that one of them is a post-critical sequence. So, let $B \in \mathcal{P}$.

If the sequence A and some post-critical sequence differ in finitely many places,

then $A = pu$ for some $p \in \mathcal{P}$ and $u \in X^*$, and we can apply Lemma V.14. Otherwise, choose numbers $m_1 = 0, m_2, \dots, m_K$ such that the words $\tau^{m_1+\dots+m_{i-1}}(A_{m_1+\dots+m_i})$ and p_{m_i} for $i = 2, 3, \dots, K$ differ in at least one letter for all $p \in \mathcal{P}$, where the constant K is from Lemma V.12. Put $m = m_1 + m_2 + \dots + m_K$. In particular, A_m and B_m differ in at least K letters. Then the decomposition of $\gamma(n)$ for all $n > m$ contains at least K edges e_i (even of different levels). At least one path γ_i between these edges should be non-trivial and such that $d'_n(p_n, q_n)$ is unbounded, where $p, q \in \mathcal{P}$ represent the ends on γ_i . Our statement is proven. \square

4.3 The proof of the main theorem

Without loss of generality and using Proposition II.17 we can suppose that the group G is generated by its nucleus \mathcal{N} . Let $\Gamma_n = \Gamma_n(\mathcal{N})$ and $T_n = T_n(\mathcal{N})$ be the corresponding Schreier graphs and tile graphs. We will use Lemma V.13 with the constant $C = 1$ (see remark after the lemma).

Lemma V.16. *There exist $A, B \in X^{-\omega}$ such that $d_n(A_n, B_n) \sim d'_n(A_n, B_n) \sim \lambda_{\min}^n$.*

Proof. There exist $p, q \in \mathcal{P}$ such that $d'_n(p_n, q_n) \sim \lambda_{\min}^n$. Since the asymptotic behavior λ_{\min}^n is the smallest one over $d'_n(p'_n, q'_n)$ for not asymptotically equal $p', q' \in \mathcal{P}$, there is always a periodic left-infinite sequence $p \in \mathcal{P}$ such that $d'_n(p_n, q_n) \sim \lambda_{\min}^n$ for some $q \in \mathcal{P}$ (just use the decomposition of geodesics and notice that from one pair $\{p, q\}$ we can construct another pair $\{p', q'\}$, where the pre-period of p' is smaller than the pre-period of p and $d'_n(p'_n, q'_n) \preceq d'_n(p_n, q_n)$). So, let the left-infinite sequence p be periodic with period $u \in X^*$ (here $p = pu$). Choose a power $v = u^m$ of the word u such that the sequence qv is not post-critical, $qv \notin \mathcal{P}$. Such a word v always exists, because otherwise the sequence q is periodic with period u , and hence $p = q$, which contradicts $d'_n(p_n, q_n) \sim \lambda_{\min}^n$. We will prove that the left-infinite sequences $p = pv$

and qv satisfy the conditions of the lemma.

Suppose that $d_{n+k}(p_nv, q_nv) \leq 1$ for all $n \geq 1$ (here $k = |v|$). Then there exists a left-infinite path in the Moore diagram of the nucleus labeled by the pair $pv|qv$. This path cannot end in the trivial state, because pv is periodic and $pv \neq qv$. If this path ends in a non-trivial state then the sequence qv is post-critical and we get a contradiction. Hence, $d_{n+k}(p_nv, q_nv) > 1$ for some n . By Lemma V.13 the sequence $d_{n+k}(p_nv, q_nv)$ is unbounded and the asymptotic relation $d_{n+k}(p_nv, q_nv) \succeq \lambda_{\min}^n$ holds. At the same time,

$$d_{n+k}(p_nv, q_nv) \leq d'_{n+k}(p_nv, q_nv) \leq d'_n(p_n, q_n) \sim \lambda_{\min}^n.$$

Hence, the left-infinite sequences pv, qv satisfy the conditions of the lemma. \square

Lemma V.17. *There exists a constant $C > 0$ such that*

$$\limsup_{d_n(v_n, u_n) \rightarrow \infty} \frac{d_{n-k}(\sigma^k(v_n), \sigma^k(u_n))}{d_n(v_n, u_n)} \leq \frac{C}{\lambda_{\min}^k}$$

for all $k \geq 1$.

Proof. Let K be as in Lemma V.12. Choose constants $c, d > 0$ such that for all $p, q \in \mathcal{P}$ with unbounded $d'_n(p_n, q_n)$ the following estimates hold:

$$cn^l \lambda^n \leq d'_n(p_n, q_n) < d'_n(p_n, q_n) + K \leq dn^l \lambda^n,$$

for all sufficiently large n , where the coefficients l and λ depend on p, q . Without loss of generality we suppose that the above inequalities hold for all $n \geq 1$.

Define $C = d/c > 0$. Then for all $n > k$ the following estimates hold

$$\frac{d'_{n-k}(\sigma^k(p_n), \sigma^k(q_n))}{d'_n(p_n, q_n)} = \frac{d'_{n-k}(p_{n-k}, q_{n-k})}{d'_n(p_n, q_n)} \leq \frac{d(n-k)^l \lambda^{n-k}}{cn^l \lambda^n} \leq \frac{C}{\lambda_{\min}^k}, \quad (5.10)$$

because λ_{\min} is the minimal possible λ above.

So, for boundary vertices of the tile graphs T_n the inequality of the lemma holds. To prove it for arbitrary sequences of vertices v_n, u_n of the Schreier graphs Γ_n we use the decomposition of geodesics and expand $d_n(v_n, u_n)$ as a sum of $d'_i(p_i, q_i)$, and show that $d_{n-k}(\sigma^k(v_n), \sigma^k(u_n))$ is bounded by the respective sum of $d'_{i-k}(p_{i-k}, q_{i-k})$. Dividing we will get the same estimate as in (5.10).

Let γ be a geodesic connecting the vertices v_n and u_n in the Schreier graph Γ_n . The path γ can be represented in the form $[\eta_1]e_1\eta_2e_2\dots e_l[\eta_{l+1}]$ as in Section 4.1, where η_i is a geodesic between two boundary vertices in the graph T_{n_i} or some geodesic in the graph T_1 . Then

$$d_n(v_n, u_n) \geq \sum_{\eta_i} |\eta_i| = \sum_{\eta_i} d'_{n_i}(r_{n_i}, t_{n_i}),$$

where n_i is a level such that η_i is a geodesic in T_{n_i} , and the vertices r_{n_i}, t_{n_i} are the ends of η_i (here $r, t \in \mathcal{P}$). The sum is taken over paths η_i of level $n_i > 1$. Since $d_n(v_n, u_n)$ goes to infinity, the sum over η_i is non-empty.

By applying the power σ^k of the shift map to the path γ (to every vertex of γ) we get a path γ' between $\sigma^k(v_n)$ and $\sigma^k(u_n)$. The path γ' is represented in the form $[\eta'_1]e'_1\eta'_2e'_2\dots e'_l[\eta'_{l+1}]$, where $\eta'_i = \sigma^k(\eta_i)$ and $e'_i = \sigma^k(e_i)$ and some of them could be trivial (in particular η'_i is trivial for η_i of level $\leq k$). Let $l' \leq l$ be the number of non-trivial (non-empty) edges e'_i in the path γ' . The number l' is not greater than (the number of non-empty paths γ'_i) $\times K$ by the construction of K . Then

$$\begin{aligned} d_{n-k}(\sigma^k(v_n), \sigma^k(u_n)) &\leq |\gamma'| = \sum_{\eta'_i} |\eta'_i| + l' = \sum_{\eta_i} d'_{n_i-k}(r_{n_i-k}, t_{n_i-k}) + l' \leq \\ &\leq \sum_{\eta_i} (d'_{n_i-k}(r_{n_i-k}, t_{n_i-k}) + K). \end{aligned}$$

Then

$$\frac{d_{n-k}(\sigma^k(v_n), \sigma^k(u_n))}{d_n(v_n, u_n)} \leq \frac{\sum_{\eta_i} (d'_{n_i-k}(r_{n_i-k}, t_{n_i-k}) + K)}{\sum_{\eta_i} d'_{n_i}(r_{n_i}, t_{n_i})} \leq \frac{C}{\lambda_{\min}^k}.$$

□

We are ready to prove the main result of this section.

Theorem V.18. *The orbital contraction coefficient $\rho_o(G)$ is equal to $1/\lambda_{\min}$.*

Proof. Let us prove that $\rho_o \geq \lambda_{\min}^{-1}$.

Using Lemma V.16 find $A, B \in X^{-\omega}$ such that $d'_n(A_n, B_n) \sim d_n(A_n, B_n) \sim \lambda_{\min}^n$. Take any $w \in X^\omega$ and consider infinite words $C_n = A_n w$ and $D_n = B_n w$, which belong to the common G -orbit for all n , because A_n and B_n are connected by a path in the graph T_n . Then:

$$d_n(A_n, B_n) \leq d(C_n, D_n) \leq d'_n(A_n, B_n)$$

for all n and thus $d(C_n, D_n) \sim \lambda_{\min}^n$. Choose constants $c, d > 0$ such that $c\lambda_{\min}^n \leq d(C_n, D_n) \leq d\lambda_{\min}^n$ for all sufficiently large n . Then

$$\begin{aligned} \nu_k &= \limsup_{d(v_n, w_n) \rightarrow \infty} \frac{d(\sigma^k(v_n), \sigma^k(w_n))}{d(v_n, w_n)} \geq \limsup_{n \rightarrow \infty} \frac{d(\sigma^k(C_n), \sigma^k(D_n))}{d(C_n, D_n)} = \\ &= \limsup_{n \rightarrow \infty} \frac{d(C_{n-k}, D_{n-k})}{d(C_n, D_n)} \geq \frac{c}{d\lambda_{\min}^k}, \\ \rho_o &= \lim_{k \rightarrow \infty} \sqrt[k]{\nu_k} \geq \sqrt[k]{\frac{c}{d\lambda_{\min}^k}} = \frac{1}{\lambda_{\min}}. \end{aligned}$$

Let us do the estimate from above. Fix $k \geq 1$. Let $w, w' \in X^\omega$ be any two points from the same G -orbit. The distance between w and w' on the corresponding orbital Schreier graph is equal to the distance between their sufficient beginnings on the corresponding Schreier graph Γ_n . We could find n such that $d(w, w') = d_n(w_n, w'_n)$

and $d(\sigma^k(w), \sigma^k(w')) = d_{n-k}(\sigma^k(w_n), \sigma^k(w'_n))$. Then by Lemma V.17

$$\begin{aligned} \nu_k &= \limsup_{d(w, w') \rightarrow \infty} \frac{d(\sigma^k(w), \sigma^k(w'))}{d(w, w')} = \\ &= \limsup_{d_n(v_n, u_n) \rightarrow \infty} \frac{d_{n-k}(\sigma^k(v_n), \sigma^k(u_n))}{d_n(v_n, u_n)} \leq \frac{C}{\lambda_{\min}^k}, \\ \rho_o &= \lim_{k \rightarrow \infty} \sqrt[k]{\nu_k} \leq \sqrt[k]{\frac{C}{\lambda_{\min}^k}} = \frac{1}{\lambda_{\min}}. \end{aligned}$$

□

Corollary V.19. *The growth degree of every orbital Schreier graph $\Gamma_\omega(G, S)$, $\omega \in X^\omega$, lies between $\frac{\log |X|}{\log \lambda_{\max}}$ and $\frac{\log |X|}{\log \lambda_{\min}}$.*

Corollary V.20. *If the inflation distance map f_G possesses a strictly positive eigenvector with eigenvalue λ then $\text{Diam } \Gamma_n \sim \text{Diam } T_n \sim \lambda^n$, $\rho_o = \rho_d = \lambda^{-1}$, and the growth degree of every orbital Schreier graph $\Gamma_\omega(G, S)$, $\omega \in X^\omega$, is equal to $\frac{\log |X|}{\log \lambda}$.*

5 Metrics on post-critically finite limit spaces

Let G be a contracting self-similar group generated by a bounded automaton. Suppose that the inflation distance map f_G possesses a strictly positive eigenvector with eigenvalue λ . Then we can construct a metric on the limit space \mathcal{J}_G .

Fix a finite generating set S of the group G and let $\Gamma_n = \Gamma_n(G, S)$ be the corresponding Schreier graphs with distance denoted by $d_n(\cdot, \cdot)$. Define a pseudo-metric $d(\cdot, \cdot)$ on the space $X^{-\omega}$ by equality:

$$d(\xi, \zeta) = \limsup_{n \rightarrow \infty} \frac{d_n(\xi_n, \zeta_n)}{\lambda^n}, \quad \text{for } \xi, \zeta \in X^{-\omega}. \quad (5.11)$$

Theorem V.21. *The space $X^{-\omega}$ factorized by $d(\cdot, \cdot) = 0$ is homeomorphic to \mathcal{J}_G .*

Proof. Since the asymptotic behavior of the diameters of Γ_n is equivalent to λ^n , the distance $d(\xi, \zeta)$ between arbitrary two points is finite and the diameter of the

space $(X^{-\omega}, d(\cdot, \cdot))$ is finite. If the sequences ξ and ζ are asymptotically equivalent, then the sequence $d_n(\xi_n, \zeta_n)$ is bounded, and $d(\xi, \zeta) = 0$. If the sequences ξ and ζ are not asymptotically equivalent, then the sequence $d_n(\xi_n, \zeta_n)$ is not bounded, and $d_n(\xi_n, \zeta_n) \sim \lambda^n$ by Lemma V.15 and Theorem V.10. Hence, $d(\xi, \zeta) > 0$. \square

Proposition V.22. *The box-counting dimension of the limit space \mathcal{J}_G with respect to the metric $d(\cdot, \cdot)$ is equal to $\frac{\log |X|}{\log \lambda}$.*

Proof. Follows from the fact that

$$\min_{u \in X^k} \{\text{Diam } \mathcal{T}_u\} \sim \max_{u \in X^k} \{\text{Diam } \mathcal{T}_u\} \sim \frac{1}{\lambda^k}.$$

\square

6 Random walks on Schreier graphs

The fundamental question in the study of random walks on graphs is whether a random walk is recurrent or transient. A random walk is called *recurrent* if it returns to the initial point with probability one; otherwise *transient*. A random walk on a locally finite graph is called *simple* if from each vertex it goes with equal probability to one of its neighbors.

Let Γ be a strongly connected infinite locally finite graph. A *constriction of the graph* Γ is an infinite sequence V_0, V_1, V_2, \dots of disjoint non-empty finite subsets of $V(\Gamma)$ such that $V(\Gamma) = \bigcup_{i \geq 0} V_i$ and there are no edges between vertices in V_i and V_j for $|i - j| \geq 2$. A constriction V_0, V_1, V_2, \dots of Γ is called *slowly-widening* if

$$\sum_{i=1}^{\infty} \frac{1}{|E_i|} \text{ is divergent,}$$

where E_i is the set of edges between vertices in V_{i-1} and V_i .

A *refinement of a graph* Γ is a graph obtained from Γ by inserting a finite number

of new vertices in the interior of each edge.

Theorem V.23 ([NW59]). *The simple random walk on a strongly connected infinite locally finite graph Γ is recurrent if and only if Γ has a slowly-widening refinement.*

We can use the previous theorem to get the following result.

Theorem V.24. *Let G be a self-similar group generated by a bounded automaton S . The simple random walk on every orbital Schreier graph $\Gamma_w(G, S)$, $w \in X^\omega$, is recurrent.*

Proof. Since the automaton S is bounded, the sequence

$$a_n = \left| \{v \in X^n \mid \text{there exists } s \in S \text{ such that } s|_v \neq 1\} \right|,$$

is bounded, say by a constant $b > 0$.

Let us fix $w \in X^\omega$ and consider the orbital Schreier graph $\Gamma_w(G, S)$. If the graph $\Gamma_w(G, S)$ is finite then there is nothing to prove. So we suppose that the graph $\Gamma_w(G, S)$ is infinite. Since the group G is contracting, Proposition II.6 implies that the orbit $Orb_G(w) = V(\Gamma_w(G, S))$ is contained in a union of finitely many confinality classes, say $E_c(w_1), E_c(w_2), \dots, E_c(w_m)$ with non-confinal $w_i \in X^\omega$ for different i .

Let us construct a slowly-widening constriction of $\Gamma_w(G, S)$. Define

$$V_0 = \bigcup_{i=1}^m X\sigma(w_i) \cap Orb_G(w).$$

Suppose now that we have constructed finite sets of vertices V_0, V_1, \dots, V_{n-1} . For every vertex $v \in \bigcup_{i=0}^{n-1} V_i$ and for every generator $s \in S$ consider the confinality class of $s(v)$ and let $s(v) \in E_c(w_k)$, where $k = k(s, v)$ depends on s and v . Let $l(s, v)$ be an integer number such that the infinite words $s(v)$ and w_k may differ only in the first

$l(s, v)$ -st letters. Define $l_n = \max\{l(s, v) \mid s \in S \text{ and } v \in \bigcup_{i=0}^{n-1} V_i\}$ and notice that

$$s(v) \in \widehat{V}_n = \bigcup_{i=1}^m X^{l_n} \sigma^{l_n}(w_i)$$

for every $s \in S$ and $v \in \bigcup_{i=0}^{n-1} V_i$. Define

$$V_{n+1} = \left(\widehat{V}_n \cap \text{Orb}_G(w) \right) \setminus \bigcup_{i=0}^{n-1} V_i.$$

By construction, the set V_n has the following properties: it contains every vertex u , which is not in V_{n-1} but is connected with some vertex in V_{n-1} ; every vertex u in the complement of V_n differs from every vertex in V_n by a letter on position $> l_n$.

Now let V_n be the sets constructed by the procedure above starting from V_0 . The first property above implies that there are no edges between V_i and V_j for $|i - j| \geq 2$. The second property implies that if there is an edge $s(u) = v$ for $s \in S$ and vertices $u \in V_n$ and v in the complement of V_n , then the restriction $s|_{u_1 u_2 \dots u_n}$ (here $u = u_1 u_2 \dots \in X^\omega$) is non-trivial. Hence the number of such edges is bounded by $m \cdot b$ for all $n \geq 1$, because each vertex of V_n is of the form $u_1 u_2 \dots u_{l_n} \sigma^{l_n}(w_i)$ for some $i \in \{1, 2, \dots, m\}$. In particular, the set E_n of edges between vertices in V_{n-1} and V_n is bounded by $m \cdot b$ for all n . The series

$$\sum_{i=1}^{\infty} \frac{1}{m \cdot b}$$

is divergent. Hence the constructed construction V_0, V_1, V_2, \dots is slowly-widening and we can apply Theorem V.23. \square

The theorem does not hold for the whole class of contracting self-similar groups. For example, there are contracting self-similar actions of \mathbb{Z}^n for every $n \geq 1$, whose Schreier graphs Γ_ω are just the Cayley graphs of the group, and the simple random walk on \mathbb{Z}^n for $n \geq 3$ is transient by the classical Polya's theorem.

CHAPTER VI

EXAMPLES AND APPLICATIONS

In this chapter we consider some well-known examples of automata groups to illustrate methods developed in Chapter V. We show that the orbital Schreier graphs of iterated monodromy groups of quadratic polynomials have arbitrary large degrees of growth. We present the first example of a group with different coefficients λ_{\min} and λ_{\max} .

1 Adding machine

One of the simplest automata over the alphabet $X = \{0, 1\}$ is shown in Figure 10 and is called *the adding machine*. This automaton is bounded and its post-critical set consists of two elements $a = 0^{-\omega}$ and $b = 1^{-\omega}$. The set of edges E and the map ψ of the associated inflation data are given by

$$E = \left\{ \{(a, 1); (b, 0)\} \right\}, \quad \psi(a) = (a, 0), \quad \psi(b) = (b, 1).$$

The inflation distance map $f(x) = 2x+1$ is one-dimensional and is given by one matrix $A = (2)$ (we omit the additive constant 1). It possesses a strictly positive eigenvector with eigenvalue $\lambda = 2$. So, the diameters of the Schreier graphs Γ_n have growth 2^n , the orbital Schreier graphs Γ_ω have linear growth, and the orbital contracting coefficient ρ_o is equal to $\frac{1}{2}$. The sequence of metric spaces $(\Gamma_n, \frac{d_n(\cdot, \cdot)}{2^n})$ converges in the Gromov-Hausdorff metric to the unit circle, while the sequence $(T_n, \frac{d'_n(\cdot, \cdot)}{2^n})$ converges to the interval $[0, 1]$.

The simplicial Schreier graph Γ_n differs from the simplicial tile graph T_n by one edge between words a_n and b_n . The sequences a, b represent the same point of the limit space \mathcal{J}_G , and represent the boundary points of the tile $\mathcal{T} = [0, 1]$.

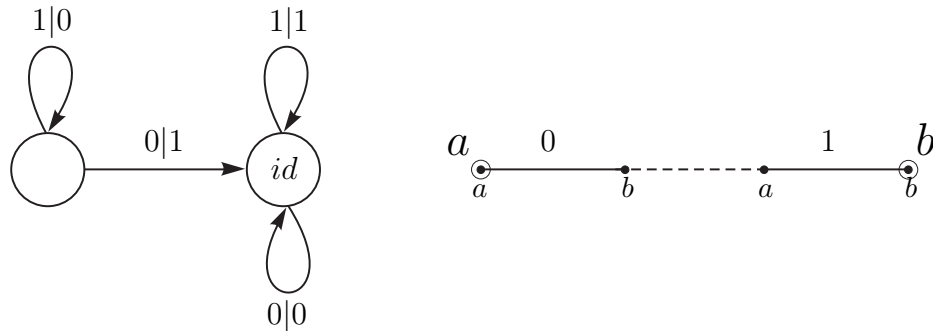

Fig. 10. The adding machine and the associated inflation data

2 Iterated monodromy groups of quadratic polynomials

An important class of examples of contracting self-similar groups is the class of iterated monodromy groups of post-critically finite rational functions, which build a connection between classical dynamical systems and automaton groups. The limit space of an iterated monodromy group is homeomorphic to the Julia set of the corresponding function (see [Nek05, Theorem 6.4.4]). Iterated monodromy groups of post-critically finite polynomials are generated by bounded automata (see [Nek05, Theorem 6.10.8]) and we can apply the results of the dissertation.

2.1 $\text{IMG}(z^2 + i)$

The iterated monodromy group of the polynomial $z^2 + i$ is generated by the automaton shown in Figure 11. The $\text{IMG}(z^2 + i)$ is one more example of a group of intermediate growth (see [BP06]). The alphabet is $X = \{0, 1\}$ and the post-critical set consists of three elements $a = (10)^{-\omega}0$, $b = (10)^{-\omega}$, $c = (01)^{-\omega}$. The set of edges E and the map ψ of the associated inflation data are given by

$$E = \left\{ \{(a, 0); (a, 1)\} \right\}, \quad \psi(a) = (b, 0), \quad \psi(b) = (c, 0), \quad \psi(c) = (b, 1).$$

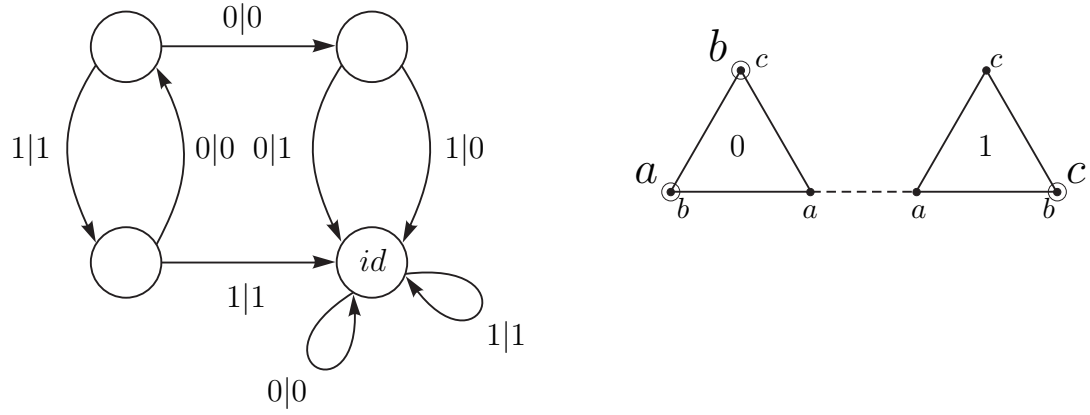

Fig. 11. The $\text{IMG}(z^2 + i)$ and the associated inflation data

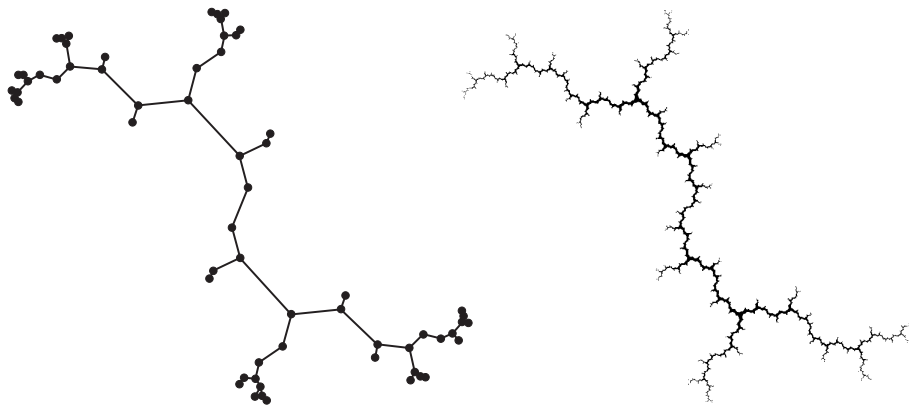

Fig. 12. The Schreier graph Γ_6 of $\text{IMG}(z^2 + i)$ and the Julia set of $z^2 + i$

The components of the inflation distance map f are given by

$$\begin{aligned} f_{ab}(v) &= v_{bc}, \\ f_{ac}(v) &= 2v_{ab} + 1, \\ f_{bc}(v) &= v_{ab} + v_{ac} + 1, \end{aligned} \quad f_{\mathcal{X}} = \begin{pmatrix} 0 & 0 & 1 \\ 2 & 0 & 0 \\ 1 & 1 & 0 \end{pmatrix},$$

or just one matrix on the right when we omit additive constants. This matrix possesses a strictly positive eigenvector with eigenvalue $\lambda \approx 1.5213\dots$, which is the real root of the polynomial $x^3 - x - 2$. So, the diameters of the Schreier graphs Γ_n have growth λ^n , the orbital Schreier graphs Γ_ω have growth degree $\frac{\log 2}{\log \lambda} \approx 1.6518\dots$, and the orbital contracting coefficient ρ_o is equal to $\frac{1}{\lambda} \approx 0.6572\dots$.

The simplicial Schreier graphs are trees (and thus planar) and coincide with the simplicial tile graphs. These graphs can be drawn in \mathbb{C} in such a way that they converge in the Hausdorff metric to the Julia set of $z^2 + i$ (see Figure 12), which is homeomorphic to the limit space of the group. However, the sequence of metric spaces $(\Gamma_n, \frac{d_n(\cdot, \cdot)}{\lambda^n})$ does not converge in the Gromov-Hausdorff metric to the Julia set of $z^2 + i$.

2.2 Basilica group

Basilica group is the iterated monodromy group of $z^2 - 1$ and is generated by the automaton shown in Figure 13. This group is torsion-free, has exponential growth, and is the first example of amenable but not subexponentially amenable group (see [GŻ02]). The alphabet is $X = \{0, 1\}$ and the post-critical set consists of three elements $a = 1^{-\omega}$, $b = (01)^{-\omega}$, $c = (10)^{-\omega}$. The set of edges E and the map ψ of the associated inflation data are given by

$$E = \left\{ \{(a, 0); (b, 1)\}, \{(a, 0); (c, 0)\} \right\}, \quad \psi(a) = (a, 1), \quad \psi(b) = (c, 1), \quad \psi(c) = (b, 0).$$

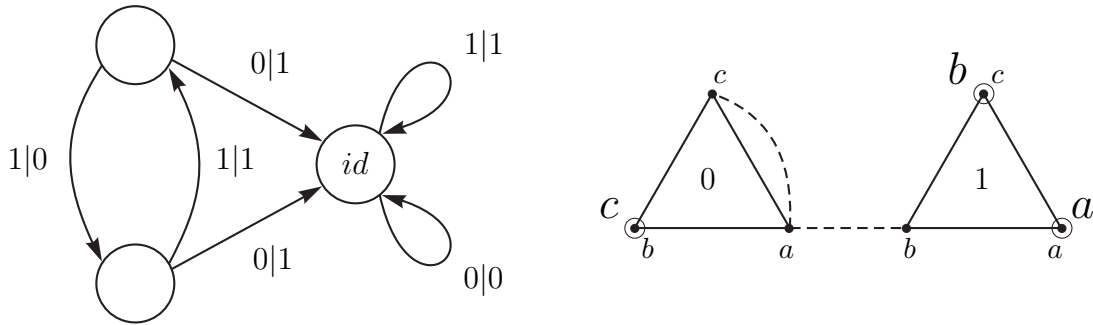

Fig. 13. The Basilica group and the associated inflation data

The components of the inflation distance map f are

$$\begin{aligned} f_{ab}(v) &= v_{ac}, \\ f_{ac}(v) &= \min\{2v_{ab} + 1, v_{ab} + v_{bc} + 2\}, \\ f_{bc}(v) &= \min\{v_{ab} + v_{bc} + 1, 2v_{bc} + 2\}, \end{aligned}$$

and $f_{\mathcal{K}}$ is given by the set of matrices

$$\mathcal{K} = \left\{ \begin{pmatrix} 0 & 1 & 0 \\ 2 & 0 & 0 \\ 1 & 0 & 1 \end{pmatrix}, \begin{pmatrix} 0 & 1 & 0 \\ 2 & 0 & 0 \\ 0 & 0 & 2 \end{pmatrix}, \begin{pmatrix} 0 & 1 & 0 \\ 1 & 0 & 1 \\ 1 & 0 & 1 \end{pmatrix}, \begin{pmatrix} 0 & 1 & 0 \\ 1 & 0 & 1 \\ 0 & 0 & 2 \end{pmatrix} \right\},$$

(actually, we can remove the 2-nd and 3-rd matrices without changing the map $f_{\mathcal{K}}$, but then \mathcal{K} will not satisfy the product property). The map $f_{\mathcal{K}}$ possesses a strictly positive eigenvector with eigenvalue $\sqrt{2}$. So, the diameters of the Schreier graphs Γ_n have growth $(\sqrt{2})^n$, the orbital Schreier graphs Γ_{ω} have quadratic growth, and the orbital contracting coefficient ρ_o is equal to $\frac{1}{\sqrt{2}}$.

The simplicial Schreier graph Γ_n differs from the simplicial tile graph T_n by two edges $\{a_n, b_n\}$ and $\{a_n, c_n\}$. See the graph Γ_6 and the Julia set of $z^2 - 1$ in Figure 14.

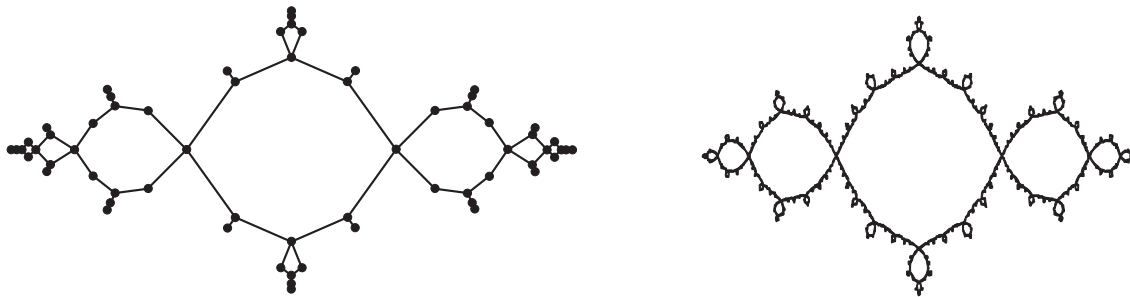

Fig. 14. The Schreier graph Γ_6 of the Basilica group and the Julia set of $z^2 - 1$

2.3 Groups $\mathfrak{K}(\nu, \omega)$

Let $X = \{0, 1\}$. Let $\nu = \nu_1\nu_2\dots\nu_s \in X^*$ and $\omega = \omega_1\omega_2\dots\omega_t \in X^*$ be non-empty words with $\nu_s \neq \omega_t$. Denote by $\mathfrak{K}(\nu, \omega)$ the group generated by the automorphisms b_1, b_2, \dots, b_s and a_1, a_2, \dots, a_t , which are defined by the wreath recursions

$$b_1 = (1, 1)\sigma, \quad b_{i+1} = \begin{cases} (b_i, 1), & \text{if } \nu_i = 0, \\ (1, b_i), & \text{if } \nu_i = 1, \end{cases}$$

for $i = 1, 2, \dots, s - 1$;

$$a_1 = \begin{cases} (b_s, a_t), & \text{if } \nu_s = 0 \text{ and } \omega_t = 1, \\ (a_t, b_s), & \text{if } \nu_s = 1 \text{ and } \omega_t = 0, \end{cases} \quad a_{i+1} = \begin{cases} (a_i, 1), & \text{if } \omega_i = 0, \\ (1, a_i), & \text{if } \omega_i = 1, \end{cases}$$

for $i = 1, 2, \dots, t - 1$.

The dynamics of a quadratic polynomial is encoded by an infinite sequence over the alphabet $\{0, 1, *\}$, called the kneading sequence. If the orbit of the critical point of a quadratic polynomial is strictly pre-periodic and its kneading sequence is $\nu(\omega)^\omega$, then its iterated monodromy group coincides with the group $\mathfrak{K}(\nu, \omega)$. However, not every sequence of the form $\nu(\omega)^\omega$ is a kneading sequence and not all groups $\mathfrak{K}(\nu, \omega)$ are iterated monodromy groups of quadratic polynomials. Nevertheless, if the word ω

is not periodic then the group $\mathfrak{K}(\nu, \omega)$ is an iterated monodromy group of some post-critically finite polynomials of degree 2^n . See [BN06b] for more details and algebraic properties of these groups.

It is easy to see (and also follows from the description of the inflation data), that if the word ω is periodic with period ϑ then the simplicial Schreier graphs $\Gamma_n(\mathfrak{K}(\nu, \omega))$ and $\Gamma_n(\mathfrak{K}(\nu, \vartheta))$ coincide. So, we suppose that the word ω is not periodic.

The critical set of every group $\mathfrak{K}(\nu, \omega)$ consists of one left-infinite sequence

$$a^{(1)} = (\omega_t \dots \omega_2 \omega_1)^{-\omega} \nu_s \dots \nu_2 \nu_1.$$

Since the word ω is not periodic and $\omega_t \neq \nu_s$, the post-critical set consists of $s + t$ elements $a^{(1)}$, $a^{(2)} = \tau(a^{(1)})$, \dots , $a^{(s+t)} = \tau^{s+t-1}(a^{(1)})$ (here $\tau(a^{(s+t)}) = a^{(s+1)}$). The set of edges E and the map ψ of the associated inflation data are given by

$$E = \left\{ \{(a^{(1)}, 0); (a^{(1)}, 1)\} \right\}, \quad \psi(a^{(i)}) = \begin{cases} (a^{(i+1)}, \nu_i), & \text{if } 1 \leq i \leq s; \\ (a^{(i+1)}, \omega_{i-s}), & \text{if } s < i < s + t, \\ (a^{(s+1)}, \omega_t), & \text{if } i = s + t. \end{cases}$$

In particular, the simplicial Schreier graphs Γ_n are trees and coincide with the simplicial tile graphs. The inflation distance map f is a square matrix of dimension $(s + t)(s + t - 1)/2$, whose columns and rows are parameterized by the pairs (i, j) , $i < j$, $i, j \in \{1, 2, \dots, s + t\}$. To describe this matrix notice the following:

$$\begin{aligned} d_{n+1}(u, v) &= d_n(\tau(u), \tau(v)), \text{ if the last letters of } u \text{ and } v \text{ coincide,} \\ d_{n+1}(u, v) &= d_n(a_n^{(1)}, \tau(u)) + d_n(a_n^{(1)}, \tau(v)) + 1, \text{ if the last letters are different,} \end{aligned}$$

for arbitrary $u, v \in X^{n+1}$, $n \geq 1$. Then the entries of the matrix $f = (f_{(i,j), (i',j')})$ can

be defined explicitly as follows:

$$\begin{aligned}
 f_{(i,j),(i',j')} &= 2, \text{ if } (i,j) = (s, s+t) \text{ and } (i',j') = (1, s+1); \\
 f_{(i,j),(i',j')} &= 1, \text{ if } (i',j') = (i+1, j+1) \text{ and the last letters of } a^{(i)} \text{ and } a^{(j)} \text{ coincide,} \\
 &\quad \text{or if } (i',j') = (1, i+1) \text{ and the last letters of } a^{(i)} \text{ and } a^{(j)} \text{ are different,} \\
 &\quad \text{or if } (i',j') = (1, j+1) \text{ and the last letters of } a^{(i)} \text{ and } a^{(j)} \text{ are different;} \\
 f_{(i,j),(i',j')} &= 0, \text{ in all other cases.}
 \end{aligned}$$

For example, $\text{IMG}(z^2 + i) = \mathfrak{K}(0, 01)$ and the above matrix f coincides with the one obtained in Example 2.1. The group $\text{IMG}(z^2 + i)$ is a particular example of the next more general case.

Groups $\mathfrak{K}(0, 0\dots 01)$. For every $k \geq 3$ consider the group $\mathfrak{K}(0, 0^{k-2}1)$. The post-critical set of this group contains k elements $a^{(1)}, a^{(2)}, \dots, a^{(k)}$ and notice that the last letter of $a^{(k)}$ is 1, and the last letter of all other sequences is 0. Then

$$\begin{aligned}
 d_{n+1}(a_{n+1}^{(i)}, a_{n+1}^{(j)}) &= d_n(a_n^{(i+1)}, a_n^{(j+1)}), & \text{if } i < j \neq k, \\
 d_{n+1}(a_{n+1}^{(i)}, a_{n+1}^{(k)}) &= d_n(a_n^{(1)}, a_n^{(2)}) + d_n(a_n^{(1)}, a_n^{(i+1)}) + 1, & \text{if } i < k,
 \end{aligned}$$

for all $n \geq 1$. Now, the matrix f has one final class $\{(1, 2), (2, 3), \dots, (k-1, k), (1, k)\}$ with the irreducible matrix of dimension k shown on the left, and all the other states lie in non-final classes with irreducible components of the form shown on the right:

$$\begin{pmatrix} 0 & 1 & 0 & \dots & 0 \\ 0 & 0 & 1 & \dots & 0 \\ \vdots & \vdots & \ddots & \ddots & \vdots \\ 1 & 0 & \dots & 0 & 1 \\ 2 & 0 & \dots & 0 & 0 \end{pmatrix}, \quad \begin{pmatrix} 0 & 1 & 0 & \dots & 0 \\ 0 & 0 & 1 & \dots & 0 \\ \vdots & \vdots & \ddots & \ddots & \vdots \\ 0 & 0 & \dots & 0 & 1 \\ * & * & \dots & * & 0 \end{pmatrix},$$

where the last row of the right matrix may have one entry with 1 and all the other entries are zeros. The spectral radius of the matrix on the right is one. The

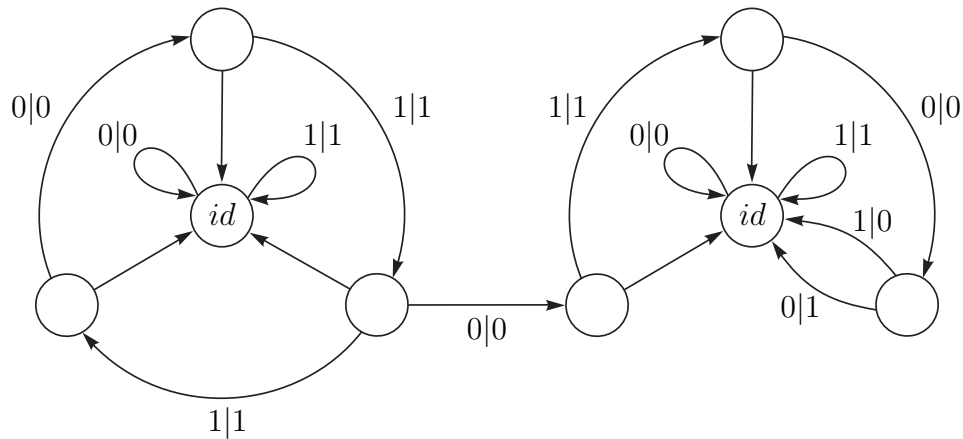

Fig. 15. The automaton generating the group $\mathfrak{K}(010, 011)$

characteristic polynomial of the matrix on the left is $x^k - x - 2$. Then the matrix f has a strictly positive eigenvector and we get the following result.

Theorem VI.1. *For the group $\mathfrak{K}(0, 0^{k-2}1)$, $k \geq 3$, the diameters of the Schreier graphs Γ_n have growth λ^n , the growth degree of every orbital Schreier graphs Γ_ω is equal to $\frac{\log 2}{\log \lambda}$, and the orbital contracting coefficient ρ_o is equal to $\frac{1}{\lambda}$, where λ is the unique positive root of the polynomial $x^k - x - 2$.*

In particular, the orbital Schreier graphs of the iterated monodromy groups of quadratic polynomials can have arbitrary large degree of growth.

2.4 Group $\mathfrak{K}(101, 100)$

The sequence $101(100)^\omega$ is the simplest and best known example of a non-kneading sequence (it is not given by an external angle) and the group $\mathfrak{K}(101, 100)$ is not the iterated monodromy group of a quadratic polynomial (see [BS02] for more details). It is interesting that this group is the first example of an automaton group with different coefficients λ_{\min} and λ_{\max} . I do not know whether it is just a coincidence or

the evidence of a deep correlation (see Problem 4 in Chapter VII).

The group $\mathfrak{R}(101, 100)$ is generated by the automaton shown in Figure 15. The inflation distance matrix f has one final class $\{(1, 4), (2, 5), (3, 6)\}$ with the irreducible matrix shown on the left and spectral radius $\sqrt[3]{2}$, one basic class $\{(1, 2), (1, 3), (2, 4), (1, 5), (1, 6)\}$ with the irreducible matrix shown on the right and spectral radius $\frac{1+\sqrt{5}}{2}$, and all the other classes are not basic but have access to the basic class:

$$\begin{pmatrix} 0 & 1 & 0 \\ 0 & 0 & 1 \\ 2 & 0 & 0 \end{pmatrix}, \quad \begin{pmatrix} 1 & 1 & 0 & 0 & 0 \\ 0 & 0 & 1 & 0 & 0 \\ 0 & 1 & 0 & 1 & 0 \\ 1 & 0 & 0 & 0 & 1 \\ 1 & 0 & 0 & 0 & 0 \end{pmatrix}.$$

It follows that the matrix f does not possess a strictly positive eigenvector. So, the diameters of the Schreier graphs Γ_n have growth $(\frac{1+\sqrt{5}}{2})^n$, the orbital contracting coefficient ρ_o is equal to $\frac{1}{\sqrt[3]{2}}$, and the growth degrees of orbital Schreier graphs Γ_ω lie between $\frac{\log 2}{\log(1+\sqrt{5})-\log 2} \approx 1.4404\dots$ and 3.

3 Gupta-Sidki group

This group is generated by the automaton shown in Figure 16.

The alphabet is $X = \{1, 2, 3\}$ and the post-critical set consists of three elements $a = 3^{-\omega}$, $b = 3^{-\omega}1$, $c = 3^{-\omega}2$. The set of edges E and the map ψ of the associated inflation data are given by

$$E = \left\{ \begin{array}{l} \{(b, 1); (b, 2)\}, \{(c, 1); (c, 2)\}, \\ \{(b, 2); (b, 3)\}, \{(c, 2); (c, 3)\}, \\ \{(b, 1); (b, 3)\}, \{(c, 1); (c, 3)\} \end{array} \right\}, \quad \begin{array}{l} \psi(a) = (a, 3), \\ \psi(b) = (a, 1), \\ \psi(c) = (a, 2). \end{array}$$

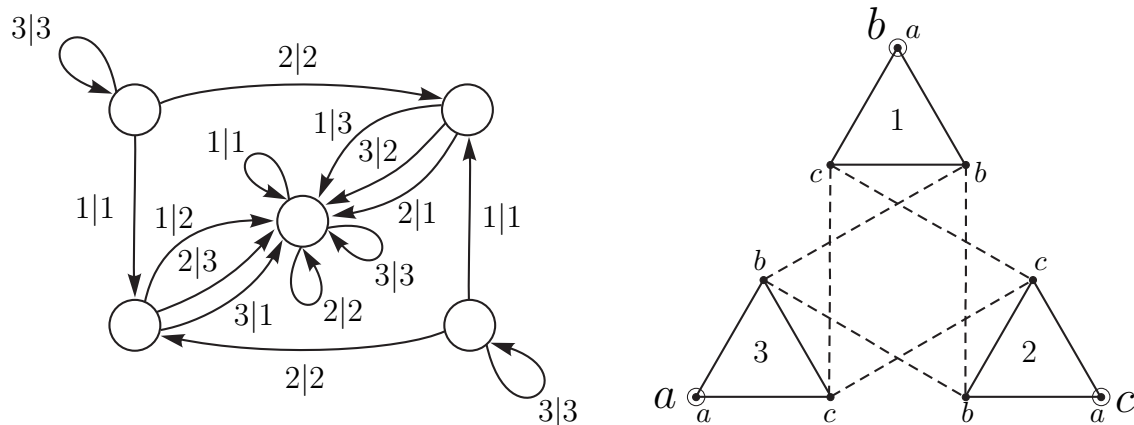

Fig. 16. The Gupta-Sidki group and the associated inflation data

The components of the inflation distance map f are

$$f_{ab}(v) = \min\{2v_{ab} + 1, 2v_{ac} + 1, 2v_{bc} + 1\},$$

$$f_{ac}(v) = \min\{2v_{ab} + 1, 2v_{ac} + 1, 2v_{bc} + 1\},$$

$$f_{bc}(v) = \min\{2v_{ab} + 1, 2v_{ac} + 1, 2v_{bc} + 1\},$$

and hence $f_{\mathcal{X}}$ possesses a strictly positive eigenvector with eigenvalue 2. So, the diameters of the Schreier graphs Γ_n have growth 2^n , the orbital Schreier graphs Γ_{ω} have growth degree $\frac{\log 3}{\log 2}$, and the orbital contracting coefficient ρ_o is equal to $\frac{1}{2}$.

The simplicial Schreier graphs coincide with the simplicial tile graphs.

CHAPTER VII

CONCLUSIONS, PROBLEMS AND CONJECTURES

In this dissertation, we studied groups generated by bounded automata, geometric objects related to these groups — limit spaces, tiles, Schreier graphs, etc., and the associated piecewise linear maps.

We showed that bounded automata appear naturally in connection to analysis on fractals. We introduced the notion of a post-critical set of a finite automaton, which is finite if and only if the automaton is bounded. At the same time, this post-critical set coincides with the post-critical set of the corresponding limit space, since bounded automaton groups are contracting. We showed that the limit space of a contracting group generated by a finite automaton is post-critically finite (finitely-ramified) if and only if this automaton is bounded.

The Schreier graphs Γ_n of bounded automaton groups can be constructed using a simple inflation rule. The description of this procedure allowed us to associate a piecewise linear map $f_{\mathcal{K}}$ to every bounded automaton. The extension of the Perron-Frobenius theory to these maps obtained in the dissertation made it possible to give an algorithmic method for finding the growth of diameters of the Schreier graphs Γ_n and the contracting coefficients associated with bounded automata.

Although this dissertation is contribution to the field of geometric group theory, we have not discussed at all algebraic properties of bounded automaton groups. It should be the subject of further research.

Problem 1. Describe bounded automata which generate finite groups.

Problem 2. Describe bounded automata which generate infinite periodic groups.

The first step in solving the previous problems is to consider bounded automata

without non-trivial finitary elements (notice that the group generated by such an automaton does not contain non-trivial finitary elements).

Conjecture 1. The group generated by a bounded automaton without non-trivial finitary elements is either finite or contains an element of infinite order.

Moreover, it is sufficient to check only the orders of elements in the nucleus, which is an algorithmic problem (see remark after Problem 9).

Most of the known groups of intermediate growth are generated by bounded automata and it is natural to ask the following question, which seems to be very difficult.

Problem 3. Describe bounded automata which generate groups of intermediate growth.

A large class of groups of intermediate growth is represented by G groups introduced in [BGŠ03], which are also usually infinite periodic groups. Here the essential role is played by finitary elements in these groups.

Conjecture 2. The group generated by a bounded automaton without non-trivial finitary elements has either polynomial or exponential growth.

Even if the previous statement is not true, it is interesting to study the corresponding counter-examples and conditions which make these groups grow intermediately. The second part about exponential growth, probably, can be improved. The only known method to prove that an automaton group has exponential growth is to indicate a free semigroup inside this group (see examples in [BGK⁺06]).

Conjecture 3. The group generated by a bounded automaton without non-trivial finitary elements has exponential growth if and only if it contains a free semigroup.

As we know, the conjecture is open even for the whole class of automaton groups.

In Chapter V we gave an algorithmic way (using results of Chapter III) to compute the orbital contracting coefficient ρ_o of a bounded automaton group and the coefficient ρ_d , which characterizes the growth exponent of diameters of the Schreier graphs Γ_n . In particular, we have the lower bound $-\frac{\log |X|}{\log \rho_d}$ and the upper bound $-\frac{\log |X|}{\log \rho_o}$ on the degrees of growth of orbital Schreier graphs. However, the question how to find the precise value of the growth degree of an orbital Schreier graph is still open. For bounded automata it should be not difficult to show that all these degrees have the same value equal to $-\frac{\log |X|}{\log \rho_d}$. But it seems to be more natural to prove this statement at once for the whole class of contracting self-similar groups.

Conjecture 4. All orbital Schreier graphs of a level-transitive contracting self-similar finitely generated group have the same degree of growth, which is equal to $-\frac{\log |X|}{\log \rho_d}$.

We would get the previous statement automatically if it were always true that $\rho_o = \rho_d$, what is correct for many well-know groups. However, considering the class of groups $\mathfrak{K}(\nu, \omega)$, which appears naturally as a class of groups containing the iterated monodromy groups of quadratic polynomials with pre-periodic critical point, we found the first example of a group with $\rho_o \neq \rho_d$, namely the group $\mathfrak{K}(101, 100)$ (see Section 2.4 of Chapter VI). At the same time, the sequence $101(100)^\omega$ is the simplest and best known example of a non-kneading sequence (it is not given by an external angle, see [BS02] for more information) and the group $\mathfrak{K}(101, 100)$ is not an iterated monodromy group of a quadratic polynomial. This coincidence looks interesting and we can ask the following

Problem 4. Is it true that for iterated monodromy groups of post-critically finite quadratic polynomials the coefficients ρ_d and ρ_o coincide?

The next question is more general and important.

Problem 5. Describe bounded automata whose inflation distance map possesses a strictly positive eigenvector.

In general, we proved that the asymptotic behavior of diameters of the Schreier graphs Γ_n of a bounded automaton group is equivalent to $n^k \lambda^n$ for an integer $k \geq 0$. However, we do not know an example of a group with $k \geq 1$.

Problem 6. Can the growth of diameters of the Schreier graphs Γ_n have non-trivial polynomial part?

The contracting property of a self-similar group guarantees that the orbital Schreier graphs have polynomial growth. The converse may also be true.

Conjecture 5. A self-replicating (level-transitive) group generated by a finite automaton is contracting if and only if all orbital Schreier graphs have polynomial growth of uniformly bounded degree.

Even though the previous statement does not give an algorithmic criterium of contraction, it looks somewhat similar to the well-known Gromov's theorem on groups of polynomial growth. Maybe we also need to restrict ourself to branch groups. Combining Conjectures 4 and 5 we have that a self-replicating automaton group is contracting if and only if there exists an orbital Schreier graph of polynomial growth. Orbital Schreier graphs of self-similar actions of (virtually) nilpotent groups have polynomial growth and we come to the following

Conjecture 6. A self-replicating self-similar action of a nilpotent group is finite-state if and only if it is contracting.

The conjecture is proved for abelian groups in [NS04]. In case of self-similar actions of nilpotent groups on the trees X^* , where $|X|$ is a prime, it follows from the result of A. Berlatto and S. Sidki (see [Nek05, Theorem 6.1.11]).

The study of bounded automata is the first step in considering polynomial automata and it is natural to ask the question about generalization of the results obtained in the dissertation to all polynomial automata.

Problem 7. Describe polynomial automata which generate contracting groups.

Problem 8. How to find the growth of orbital Schreier graphs of polynomial automaton groups? Is it true that it is always sub-exponential?

It is known that the orbital Schreier graphs of polynomial automaton groups are amenable (see [GN05]), which was proved without discussing the growth of these graphs. Already the simplest polynomial automaton (discussed in Section 2 of Chapter IV) generates a non-contracting group, whose orbital Schreier graphs have intermediate growth.

Problem 9. Describe an algorithm for finding the order of an automorphism given by a polynomial initial automaton.

In case of bounded automata the previous problem was solved by S. Sidki (see [Sid00]). Actually, the standard algorithm used to find the order of an element of a contracting self-similar group, realized in the program package `AutomGrp` developed by Y. Muntyan and D. Savchuk (see <http://sourceforge.net/projects/finautom/>), works for bounded automaton groups (it may not stop in general).

The introduced notion of the post-critical set of a finite automaton allows us to use it in the classification of automaton groups. If the post-critical set is empty, the group is the subgroup of the finitary group. It is not difficult to describe automaton groups with the post-critical set of size one and two.

Problem 10. Characterize groups generated by bounded automata using the size of its post-critical set.

REFERENCES

- [Ale72] S. V. Alešin. Finite automata and the Burnside problem for periodic groups. *Mat. Zametki*, 11:319–328, 1972.
- [Bel55a] R. Bellman. Functional equations in the theory of dynamic programming. II. Nonlinear differential equations. *Proc. Nat. Acad. Sci. U.S.A.*, 41:482–485, 1955.
- [Bel55b] R. Bellman. Functional equations in the theory of dynamic programming. V. Positivity and quasi-linearity. *Proc. Nat. Acad. Sci. U. S. A.*, 41:743–746, 1955.
- [Bel56] R. Bellman. On a quasi-linear equation. *Canad. J. Math.*, 8:198–202, 1956.
- [Bel57a] R. Bellman. *Dynamic programming*. Princeton Univeristy Press, Princeton, N. J., 1957.
- [Bel57b] R. Bellman. A Markovian decision process. *J. Math. Mech.*, 6:679–684, 1957.
- [BG00a] L. Bartholdi and R. I. Grigorchuk. On the spectrum of Hecke type operators related to some fractal groups. *Tr. Mat. Inst. Steklova*, 231(Din. Sist., Avtom. i Beskon. Gruppy):5–45, 2000.
- [BG00b] L. Bartholdi and R. I. Grigorchuk. Spectra of non-commutative dynamical systems and graphs related to fractal groups. *C. R. Acad. Sci. Paris Sér. I Math.*, 331(6):429–434, 2000.

- [BG02] L. Bartholdi and R. I. Grigorchuk. On parabolic subgroups and Hecke algebras of some fractal groups. *Serdica Math. J.*, 28(1):47–90, 2002.
- [BGK⁺06] I. Bondarenko, R. Grigorchuk, R. Kravchenko, Y. Muntyan, V. Nekrashevych, D. Savchuk, and Z. Šunić. Groups generated by 3-state automata over 2-letter alphabet, I. (available at <http://arxiv.org/abs/math.GR/0612178>), 2006.
- [BGN03] L. Bartholdi, R. Grigorchuk, and V. Nekrashevych. From fractal groups to fractal sets. In *Fractals in Graz 2001*, Trends Math., pages 25–118. Birkhäuser, Basel, 2003.
- [BGŠ03] L. Bartholdi, R. Grigorchuk, and Z. Šunić. Branch groups. In *Handbook of algebra, Vol. 3*, pages 989–1112. North-Holland, Amsterdam, 2003.
- [BH05] I. Benjamini and C. Hoffman. ω -periodic graphs. *Electron. J. Combin.*, 12:Research Paper 46, 12 pp. (electronic), 2005.
- [BKNV06] L. Bartholdi, V. Kaimanovich, V. Nekrashevych, and B. Virag. Amenability of automata groups. Preprint, 2006.
- [BN06a] L. Bartholdi and V. Nekrashevych. Thurston equivalence of topological polynomials. *Acta Math.*, 197(1):1–51, 2006.
- [BN06b] L. Bartholdi and V. Nekrashevych. Iterated monodromy groups of quadratic polynomials, I. Preprint, 2006.
- [BP94] A. Berman and R. J. Plemmons. *Nonnegative matrices in the mathematical sciences*, volume 9 of *Classics in Applied Mathematics*. Society for Industrial and Applied Mathematics (SIAM), Philadelphia, PA, 1994. Revised reprint of the 1979 original.

- [BP06] K. Bux and R. Pérez. On the growth of iterated monodromy groups. In *Topological and asymptotic aspects of group theory*, volume 394 of *Contemp. Math.*, pages 61–76. Amer. Math. Soc., Providence, RI, 2006.
- [BR97] R. B. Bapat and T. E. S. Raghavan. *Nonnegative matrices and applications*, volume 64 of *Encyclopedia of Mathematics and its Applications*. Cambridge University Press, Cambridge, 1997.
- [BŠ01] L. Bartholdi and Z. Šuník. On the word and period growth of some groups of tree automorphisms. *Comm. Algebra*, 29(11):4923–4964, 2001.
- [BS02] H. Bruin and D. Schleicher. Symbolic dynamics of quadratic polynomials. Institute Mittag-Leffler, Report No. 7, 2001/2002.
- [BS06] I. Bondarenko and D. Savchuk. On Sushchansky p -groups. Submitted to *Algebra and Discrete Mathematics*, 2006.
- [BV05] L. Bartholdi and B. Virág. Amenability via random walks. *Duke Math. J.*, 130(1):39–56, 2005.
- [FG85] J. Fabrykowski and N. Gupta. On groups with sub-exponential growth functions. *J. Indian Math. Soc. (N.S.)*, 49(3-4):249–256 (1987), 1985.
- [Gan59] F. R. Gantmacher. *The theory of matrices. Vols. 1, 2*. Translated by K. A. Hirsch. Chelsea Publishing Co., New York, 1959.
- [GG04] S. Gaubert and J. Gunawardena. The Perron-Frobenius theorem for homogeneous, monotone functions. *Trans. Amer. Math. Soc.*, 356(12):4931–4950 (electronic), 2004.
- [GHC99] R. Grigorchuk, P. de la Harpe, and T. Chekerini-Sil’berstain. Amenability and paradoxical decompositions for pseudogroups and

- discrete metric spaces. *Tr. Mat. Inst. Steklova*, 224(Algebra. Topol. Differ. Uravn. i ikh Prilozh.):68–111, 1999.
- [Glu61] V. M. Gluškov. Abstract theory of automata. *Uspehi Mat. Nauk*, 16(5 (101)):3–62, 1961.
- [GN05] R. Grigorchuk and V. Nekrashevych. Amenable actions of nonamenable groups. *Zap. Nauchn. Sem. S.-Peterburg. Otdel. Mat. Inst. Steklov. (POMI)*, 326(Teor. Predst. Din. Sist. Komb. i Algoritm. Metody. 13):85–96, 281, 2005.
- [GNS00] R. I. Grigorchuk, V. V. Nekrashevich, and V. I. Sushchanskiĭ. Automata, dynamical systems, and groups. *Tr. Mat. Inst. Steklova*, 231(Din. Sist., Avtom. i Beskon. Gruppy):134–214, 2000.
- [Gri80] R. I. Grigorchuk. On Burnside’s problem on periodic groups. *Funktsional. Anal. i Prilozhen.*, 14(1):53–54, 1980.
- [Gri83] R. I. Grigorchuk. On the Milnor problem of group growth. *Dokl. Akad. Nauk SSSR*, 271(1):30–33, 1983.
- [Gri84] R. I. Grigorchuk. Degrees of growth of finitely generated groups and the theory of invariant means. *Izv. Akad. Nauk SSSR Ser. Mat.*, 48(5):939–985, 1984.
- [Gri85] R. I. Grigorchuk. Degrees of growth of p -groups and torsion-free groups. *Mat. Sb. (N.S.)*, 126(168)(2):194–214, 286, 1985.
- [Gri98] R. I. Grigorchuk. An example of a finitely presented amenable group that does not belong to the class EG. *Mat. Sb.*, 189(1):79–100, 1998.

- [Gri00] R. I. Grigorchuk. Just infinite branch groups. In *New horizons in pro- p groups*, volume 184 of *Progr. Math.*, pages 121–179. Birkhäuser Boston, Boston, MA, 2000.
- [Gro84] M. Gromov. Infinite groups as geometric objects. In *Proceedings of the International Congress of Mathematicians, Vol. 1, 2 (Warsaw, 1983)*, pages 385–392, Warsaw, 1984. PWN.
- [GS83a] N. Gupta and S. Sidki. Some infinite p -groups. *Algebra i Logika*, 22(5):584–589, 1983.
- [GS83b] N. Gupta and S. Sidki. On the Burnside problem for periodic groups. *Math. Z.*, 182(3):385–388, 1983.
- [GŠ06] R. Grigorchuk and Z. Šuník. Asymptotic aspects of Schreier graphs and Hanoi Towers groups. *C. R. Math. Acad. Sci. Paris*, 342(8):545–550, 2006.
- [GŽ99] R. I. Grigorchuk and A. Žuk. On the asymptotic spectrum of random walks on infinite families of graphs. In *Random walks and discrete potential theory (Cortona, 1997)*, *Sympos. Math.*, XXXIX, pages 188–204. Cambridge Univ. Press, Cambridge, 1999.
- [GŽ01] R. I. Grigorchuk and A. Žuk. The lamplighter group as a group generated by a 2-state automaton, and its spectrum. *Geom. Dedicata*, 87(1-3):209–244, 2001.
- [GŽ02] R. I. Grigorchuk and A. Žuk. Spectral properties of a torsion-free weakly branch group defined by a three state automaton. In *Computational and statistical group theory (Las Vegas, NV/Hoboken, NJ, 2001)*, volume 298

- of *Contemp. Math.*, pages 57–82. Amer. Math. Soc., Providence, RI, 2002.
- [H00] P. de la Harpe. *Topics in geometric group theory*. Chicago Lectures in Mathematics. University of Chicago Press, Chicago, IL, 2000.
- [How60] R. A. Howard. *Dynamic programming and Markov processes*. The Technology Press of M.I.T., Cambridge, Mass., 1960.
- [Kig89] J. Kigami. A harmonic calculus on the Sierpiński spaces. *Japan J. Appl. Math.*, 6(2):259–290, 1989.
- [Kig95] J. Kigami. Hausdorff dimensions of self-similar sets and shortest path metrics. *J. Math. Soc. Japan*, 47(3):381–404, 1995.
- [Kig01] J. Kigami. *Analysis on fractals*, volume 143 of *Cambridge Tracts in Mathematics*. Cambridge University Press, Cambridge, 2001.
- [Krö02] B. Krön. Green functions on self-similar graphs and bounds for the spectrum of the Laplacian. *Ann. Inst. Fourier (Grenoble)*, 52(6):1875–1900, 2002.
- [Krö04] B. Krön. Growth of self-similar graphs. *J. Graph Theory*, 45(3):224–239, 2004.
- [KT04] B. Krön and E. Teufl. Asymptotics of the transition probabilities of the simple random walk on self-similar graphs. *Trans. Amer. Math. Soc.*, 356(1):393–414 (electronic), 2004.
- [Lin90] T. Lindstrøm. Brownian motion on nested fractals. *Mem. Amer. Math. Soc.*, 83(420):iv+128, 1990.

- [Mer83] Yu. I. Merzlyakov. Infinite finitely generated periodic groups. *Dokl. Akad. Nauk SSSR*, 268(4):803–805, 1983.
- [MS69] P. Mandl and E. Seneta. The theory of non-negative matrices in a dynamic programming problem. *Austral. J. Statist.*, 11:85–96, 1969.
- [Nek02] V. Nekrashevych. Virtual endomorphisms of groups. *Algebra Discrete Math.*, (1):88–128, 2002.
- [Nek03] V. Nekrashevych. Hyperbolic spaces from self-similar group actions. *Algebra Discrete Math.*, (1):77–86, 2003.
- [Nek05] V. Nekrashevych. *Self-similar groups*, volume 117 of *Mathematical Surveys and Monographs*. American Mathematical Society, Providence, RI, 2005.
- [NS04] V. Nekrashevych and S. Sidki. Automorphisms of the binary tree: state-closed subgroups and dynamics of $1/2$ -endomorphisms. In *Groups: topological, combinatorial and arithmetic aspects*, volume 311 of *London Math. Soc. Lecture Note Ser.*, pages 375–404. Cambridge Univ. Press, Cambridge, 2004.
- [NW59] C. St. J. A. Nash-Williams. Random walk and electric currents in networks. *Proc. Cambridge Philos. Soc.*, 55:181–194, 1959.
- [Pli77] S. R. Pliska. Optimization of multitype branching processes. *Management Sci.*, 23(2):117–124, 1976/77.
- [Pre98] J. P. Preville. Graph substitutions. *Ergodic Theory Dynam. Systems*, 18(3):661–685, 1998.

- [PV03] M. Previte and M. Vanderschoot. The topological dimension of limits of graph substitutions. *Forum Math.*, 15(3):477–487, 2003.
- [PY06] M. Previte and S. Yang. The topological dimension of limits of vertex replacements. *Topology Appl.*, 153(12):2013–2025, 2006.
- [Rot75] U. G. Rothblum. Algebraic eigenspaces of nonnegative matrices. *Linear Algebra and Appl.*, 12(3):281–292, 1975.
- [Roz96] A. V. Rozhkov. *Finiteness conditions in automorphism groups of trees*. PhD thesis, Cheliabinsk, 1996.
- [RW82] U. G. Rothblum and P. Whittle. Growth optimality for branching markov decision chains. *Mathematics of Operations Research*, 7(4):582–601, 1982.
- [Sen73] E. Seneta. *Non-negative matrices*. George Allen and Unwin, 1973.
- [SF79] P. J. Schweitzer and A. Federgruen. Geometric convergence of value-iteration in multichain Markov decision problems. *Adv. in Appl. Probab.*, 11(1):188–217, 1979.
- [Sid00] S. Sidki. Automorphisms of one-rooted trees: growth, circuit structure, and acyclicity. *J. Math. Sci. (New York)*, 100(1):1925–1943, 2000. Algebra, 12.
- [Sid04] S. Sidki. Finite automata of polynomial growth do not generate a free group. *Geom. Dedicata*, 108:193–204, 2004.
- [Sla80] K. Sladký. Bounds on discrete dynamic programming recursions. I. Models with nonnegative matrices. *Kybernetika (Prague)*, 16(6):526–547, 1980.

- [Sla81] K. Sladký. Bounds on discrete dynamic programming recursions. II. Polynomial bounds on problems with block-triangular structure. *Kybernetika (Prague)*, 17(4):310–328, 1981.
- [Sla86] K. Sladký. On functional equations of discrete dynamic programming. In *Stochastic optimization (Kiev, 1984)*, volume 81 of *Lecture Notes in Control and Inform. Sci.*, pages 201–212. Springer, Berlin, 1986.
- [ST02] V. N. Sachkov and V. E. Tarakanov. *Combinatorics of nonnegative matrices*, volume 213 of *Translations of Mathematical Monographs*. American Mathematical Society, Providence, RI, 2002. Translated from the 2000 Russian original by Valentin F. Kolchin.
- [Sus79] V. I. Sushchansky. Periodic p -groups of permutations and the unrestricted Burnside problem. *Dokl. Akad. Nauk SSSR*, 247(3):557–561, 1979.
- [Var00] R. S. Varga. *Matrix iterative analysis*, volume 27 of *Springer Series in Computational Mathematics*. Springer-Verlag, Berlin, expanded edition, 2000.
- [Zij84] W. H. M. Zijm. Generalized eigenvectors and sets of nonnegative matrices. *Linear algebra and its applications*, 59:91–113, 1984.
- [Zij87] W. H. M. Zijm. Asymptotic expansions for dynamic programming recursions with general nonnegative matrices. *J. Optim. Theory Appl.*, 54(1):157–191, 1987.

VITA

Ievgen Bondarenko was born in Kyiv, Ukraine. He received his B.S. degree and M.S. degree in Mathematics in June 2002 and June 2003, respectively, from National Taras Shevchenko University of Kyiv. He received his Ph.D. degree in mathematics from Texas A&M University in December 2007. His current research interests include automata and self-similar groups, Schreier graphs, self-affine tiles, dynamics of piecewise linear maps. His permanent address is: Department of Mechanics and Mathematics, National Taras Shevchenko University of Kyiv, building 7, Academician Glushkov prospectus 2, Kyiv, 03127, Ukraine.

The typist for this dissertation was Ievgen Bondarenko.