

# THE HEALING CRYSTAL

A naturopathy center

SAKINA RANGWALA

2020

SAKINA RANGWALA

THE HEALING CRYSTAL

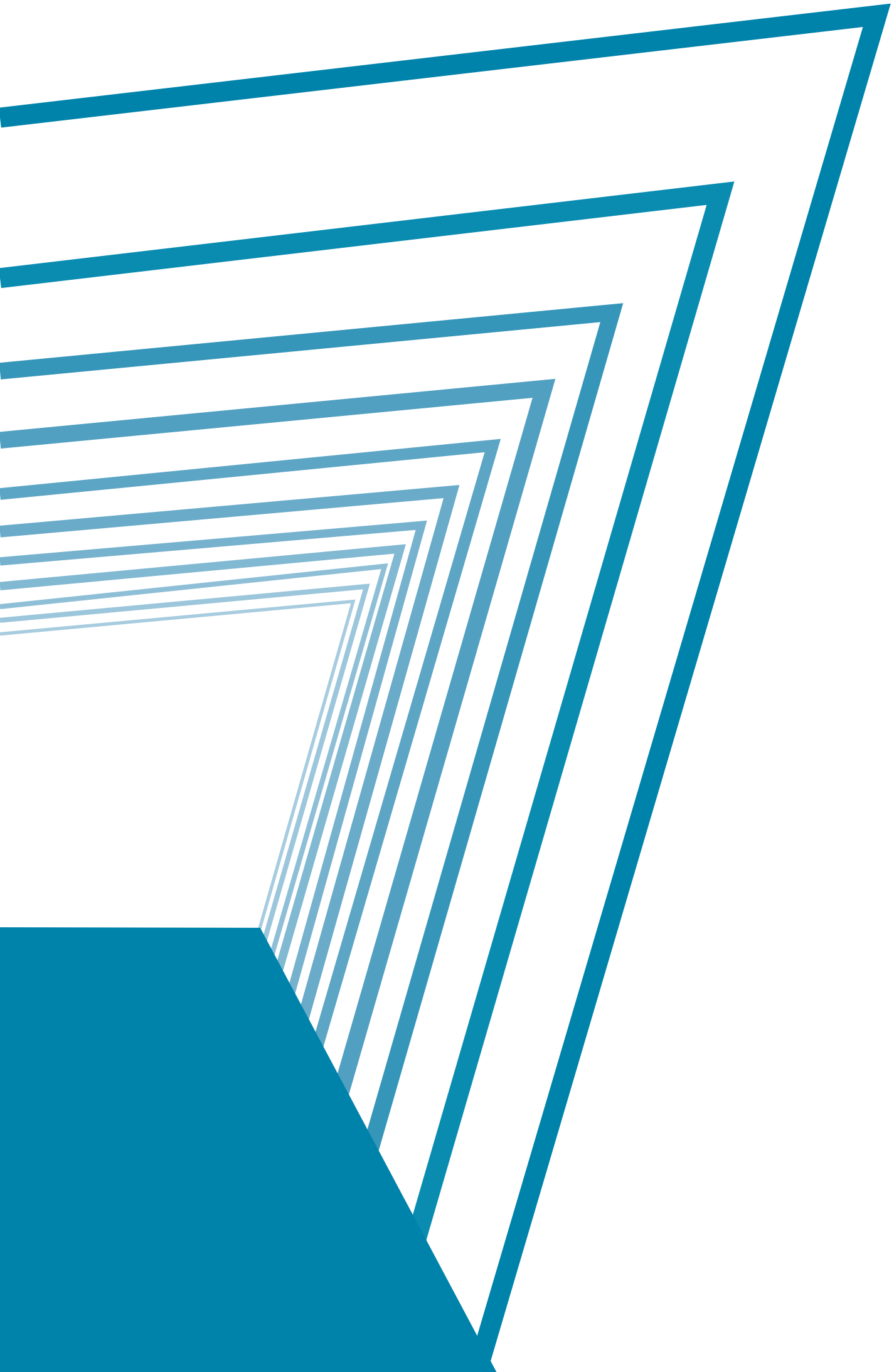

## NATUROPATHY

(Latin - Greek hybrid word)

**Naturopathy means close to or benefiting from nature**

*Naturopathic medicine* is a science-based method that promotes an individual's self-healing process. The system of natural medicine focuses primarily on *protection* and *development* of health as well as constitutes procedures that *restore* health. It is based on the use of therapeutic methods and substances that encourage healing without the use of drugs.

In present time, restoration of health concentrates on healing symptoms alone, while the human body requires a holistic approach. It needs healing at the root level of illness, not just the suppression of symptoms, i.e., allowing natural lifestyle approaches to facilitate the body's own healing and health building potential. The project aims to provide a *nurturing environment*, demonstrating *healthy living practices*, by providing a retreat to people seeking a healthy body, mind, and spirit while experiencing a state of greater awareness through wellbeing, creativity, and joy.

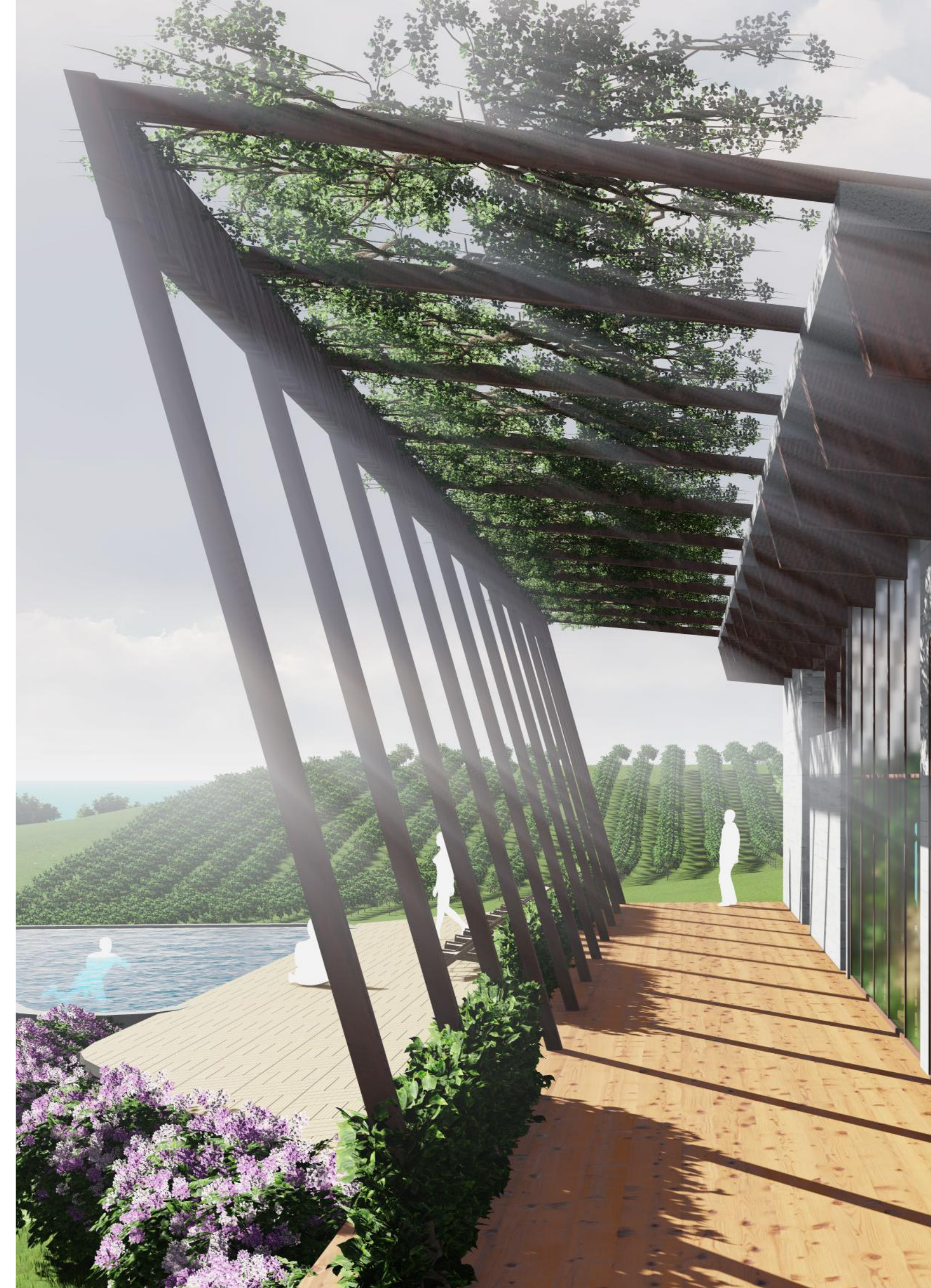

To my committee and professor, who have helped me, encouraged me, and pushed me to strive for the best,

---

**Ray Holliday**

Studio professor

---

**Ray Pentecost**

Committee chair

---

**Kirk Hamilton**

Committee member

---

**Geoffrey Booth**

Committee member

Thank you.

I would also like to extend my sincere thanks to my parents, brother, and friends for their love and continued support.

# *Contents*

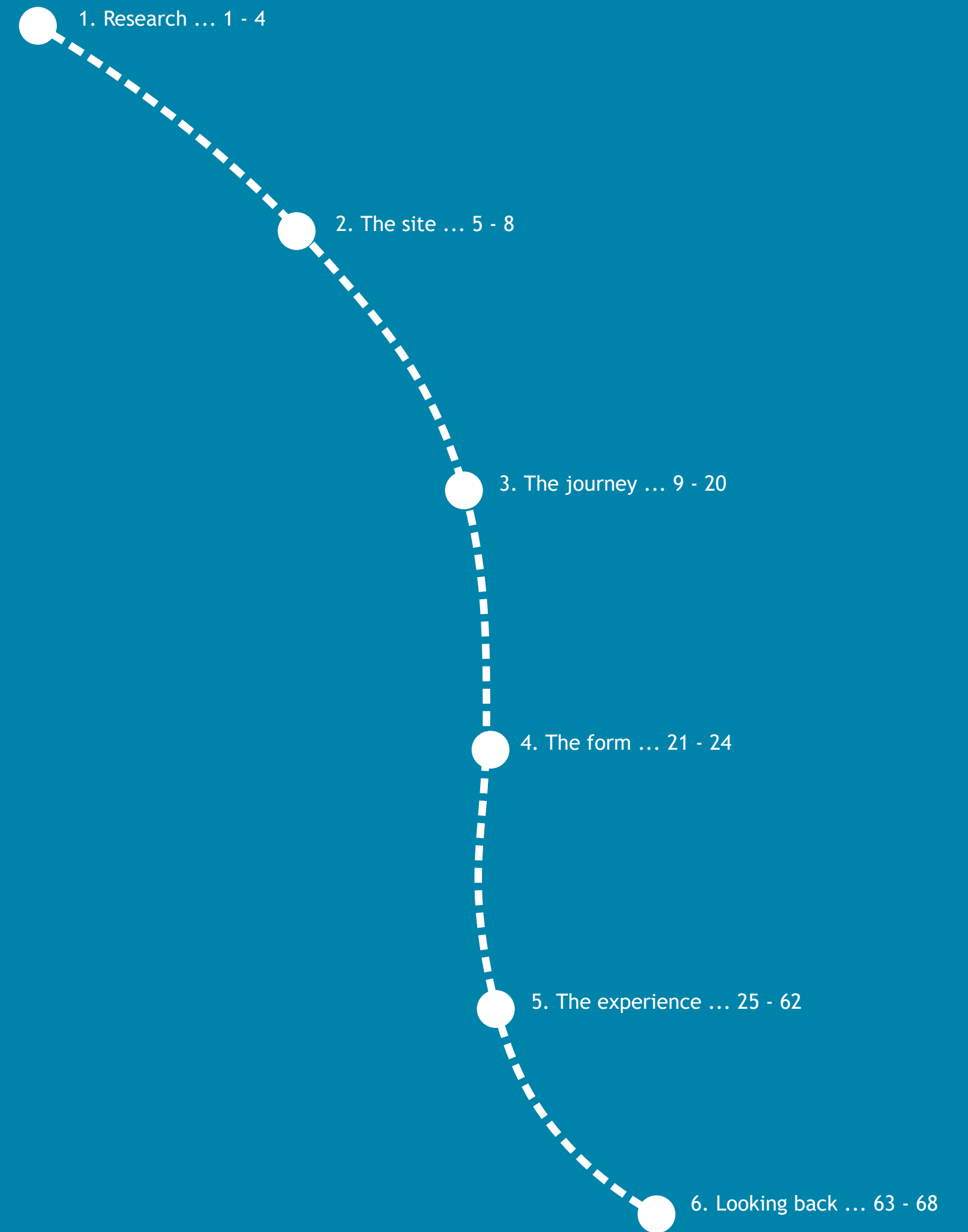

# *Research*

Capitalizing on the *restorative impact of nature* on health



**Biophilic Design**

Restoring contact with nature

**Biophilia**

The love of life or life systems

Humans have evolved with nature. It gives a sense of calm while amidst it. We try to integrate nature in our lives in many small ways, like having plants on work desks, hanging nature related artwork in lobbies, rooms, and corridors, or using ornamentation that is inspired by nature in tracery, column capitals, etc.

**Benefits:**

Stress



Cognitive function  
&  
Creativity



Well-being  
& Healing



**Strategies:**

Natural materials



Direct nature



Evoking nature

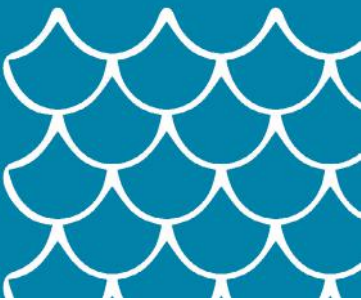

Spirit of place



Views of vegetation  
& water







*The site*



The *design intention* for this project is the inclusion of nature within the built environment for the mental and physical wellbeing of users. This is done by integrating the outside with the inside, nature with therapy, private indoors with open natural surroundings, and the built space with the landscape.

With the above considerations in mind, a site had to be chosen which would be in a natural setting and have good climate year-round for the comfortable use of outdoor spaces. Also, it needed to be in a state that allows naturopathy licensing and a location that is easy to access but secluded enough to give the feel of a “retreat”. These conditions lead to a site in **San Francisco, California** which is currently a golf course on the shoreline of the Pacific Ocean. The project develops on this 17.5-acre land in partnership with the Olympic Country Club across the highway bordering the site. The site is surrounded by a plant nursery and historic park (Fort Funston) on the north, California state route 35 and the Olympic Country Club golf course on the east, open space on the south, and the Pacific Ocean on the west. Due to its proximity to the shoreline, the site has a level difference of approximately 80’ sloping down from east (236’ above MSL) to west (156’ above MSL). It enjoys a *Mediterranean climate* with moist mild winters, dry summers and sea breezes from west to east.



*The journey*



The site is planned as a campus with small connected buildings surrounded by vast open spaces allowing the built environment to co-exist with nature. The organizational strategy takes shape from an *axis* that follows the boundary of the site that faces the ocean, *enhancing views*, and is intercepted by different materials and functions along the way. The axis starts with a view deck, moves forward as a walking/ cycling track encompassing green space, continues through and in between buildings and terminates as a parking lot following the curve. The public - private as well as vehicular and pedestrian circulation is strictly segregated. The highway forms the primary public vehicular circulation leading visitor vehicles into the site. This is offset by semi-private vehicular circulation inside the site going from a central entry/exit point to a service area at the north-east corner of the site to the parking lot at the south-east corner. A linear arrangement of buildings then forms an enclosure shutting off site activities from the outside world helping visitors completely immerse themselves in the *experience* that they came here to achieve. On the west side of the linear arrangement of buildings lies a sidewalk for private pedestrian circulation connecting all buildings together and with outdoor treatment elements.

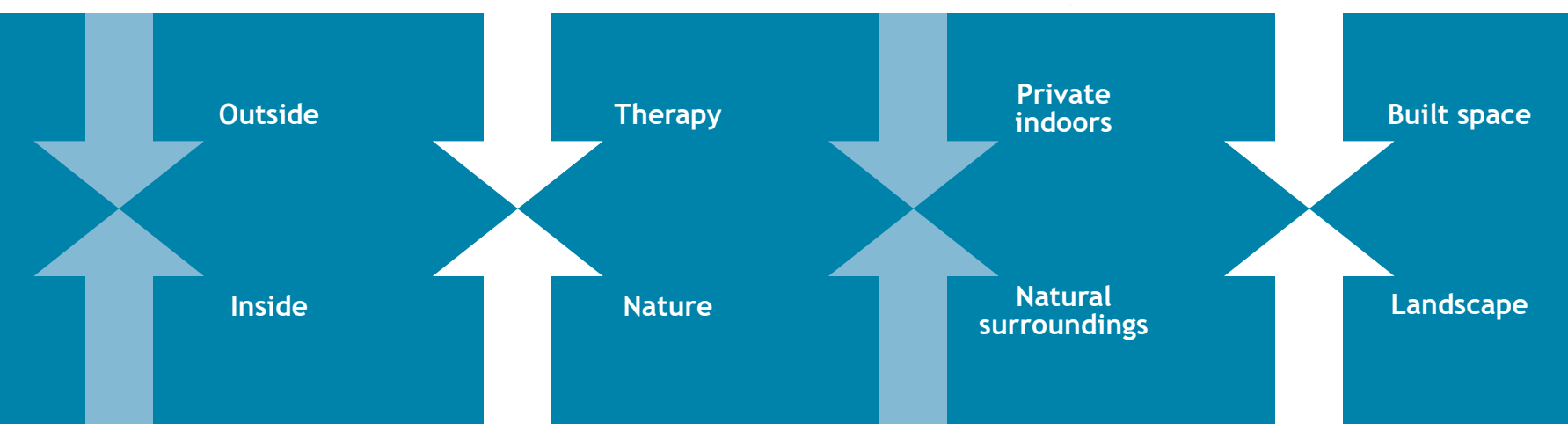
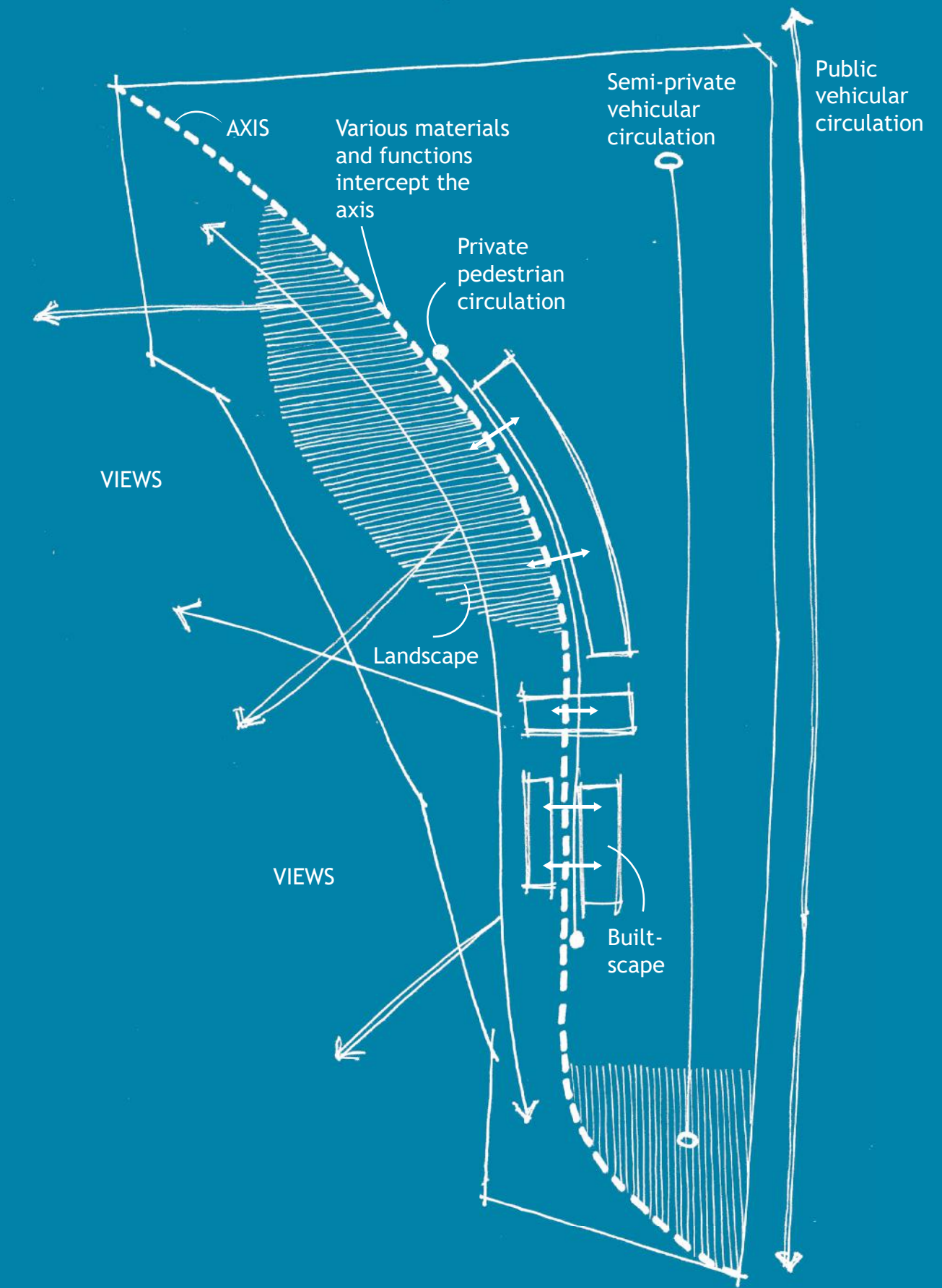

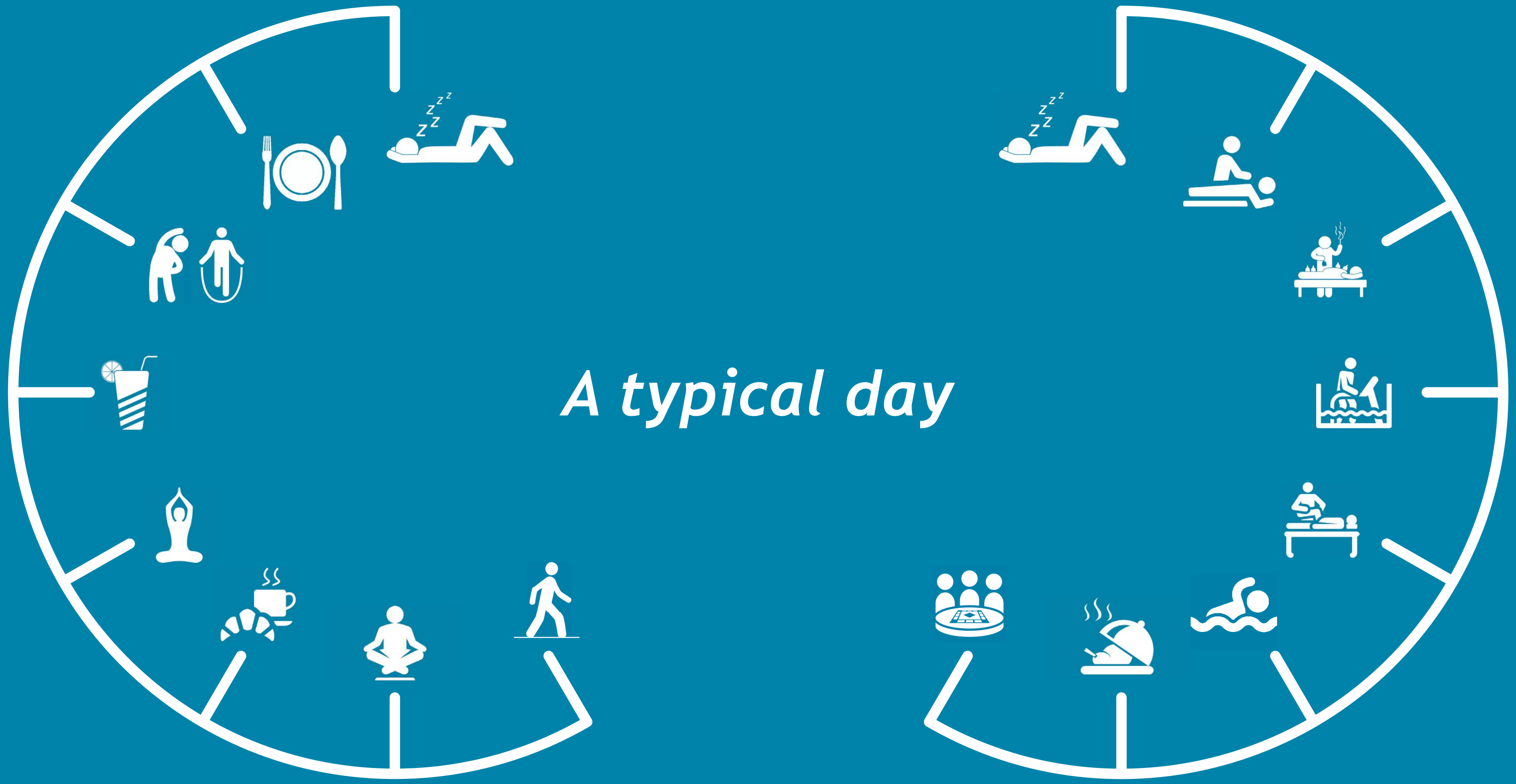

*A typical day*

The campus is planned in accordance to the *views of the ocean* to the west and hence all buildings are in a linear arrangement looking out to the ocean without disrupting views of each other. These *buildings interact with the curvature of the axis* through the outdoor treatment and recreational elements. The central portion of the axis encompasses a garden which has a stepped seating area (for group activities like yoga, meditation, and performances), gazebos (to serve as shaded rest areas, and juice and herbal drink serving stalls), a water feature creating soothing sounds of water crashing against stepping stones, and an outdoor exercise area with gym equipment. This garden and its components are at a lower level than the buildings due to the natural slope of the site, allowing each space to have premium and expansive views. Other pockets of the site are used for growing produce for use in-site and to promote healthy living practices. The landscape comprises of fruit trees (pear, apple, lemon, plum, avocado) forming an orchard; crops (mushroom, bell peppers, spinach, tomato, lettuce corn, chinese vegetables) that can be harvested and used for dining on site; and grape vines with activities like grape-stomping for recreational purposes.





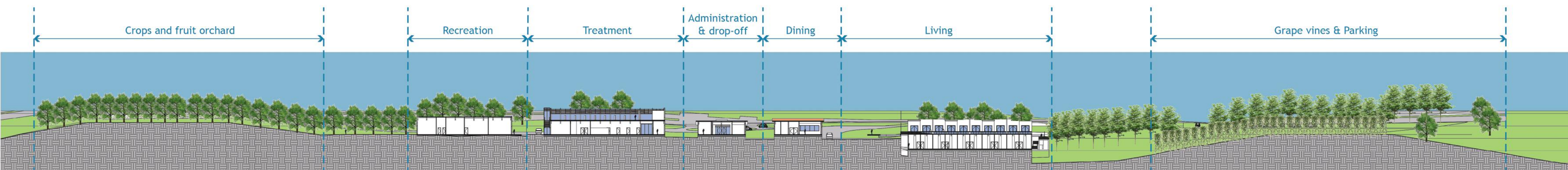

Site section ( North - South)





*The form*



The form of individual buildings is in accordance with the views and context of the site. The dynamic site with its topography and surroundings, leads to a dynamic form for the buildings. The site, being located on the shoreline of the Pacific Ocean, contributes to the “*floating feel*” of buildings designed on site that are raised on stilts with their ocean facing facades pushed up, tilted, and stretched forward to direct views to the garden in front and the ocean beyond. The pointed and tilted facades along with transparent surfaces allowing expansive views give the name to the project, *The Healing Crystal*.

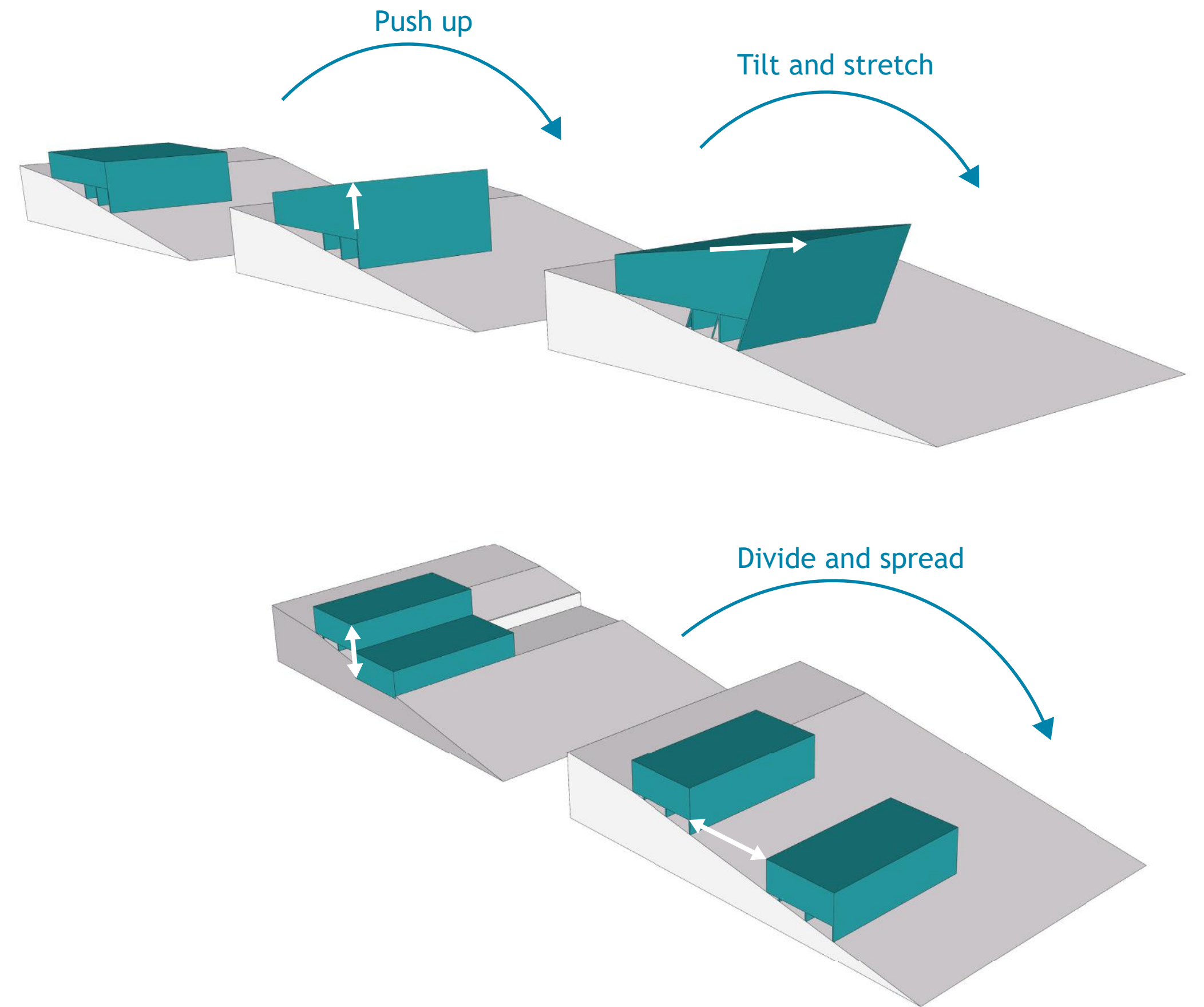

*The experience*



The *administration* building, centrally located, forms the first impression of the project upon entry. A walkway covered by downward sloping roof welcomes the visitor into a lobby where the receptionist directs them towards their rooms. An *expanding axis* and upward sloping roof lead the eye towards a curtain wall tilted outwards *directing views to the garden and ocean outside*. The visitor accessible and staff areas are separated by the axis with offices and staff break areas on one side and reception, gift shop and conference room on the other. The sloping roof is supported by exposed wooden glulam beams and columns while the walls are clad with grayish-white stone establishing a contrast in color.

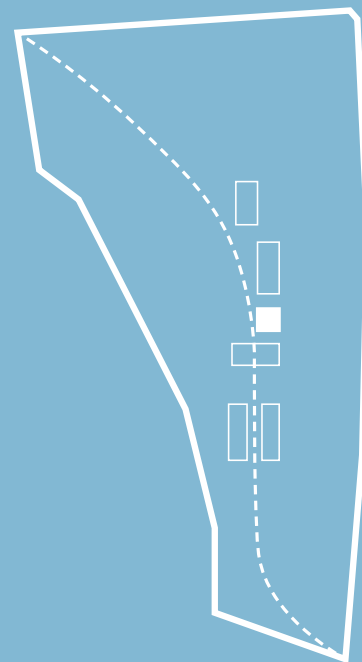

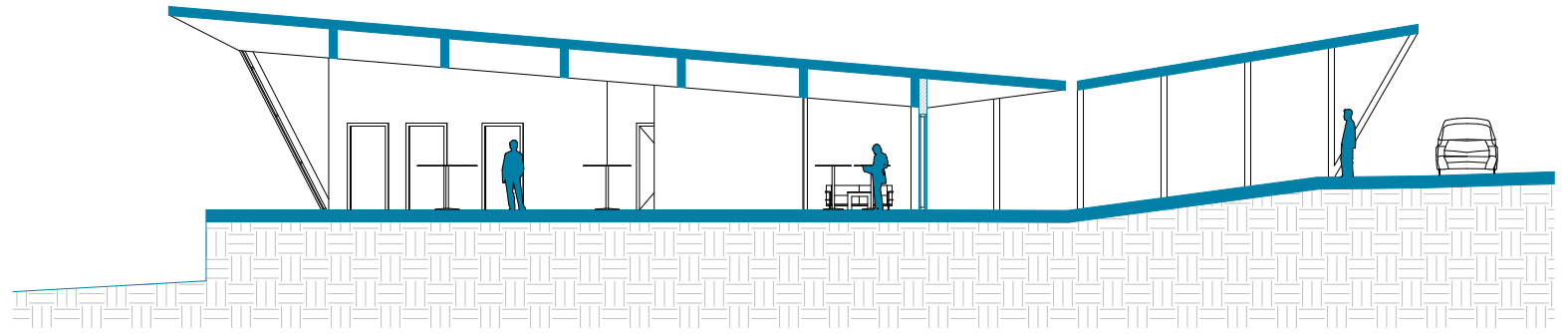
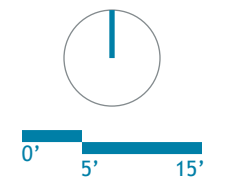
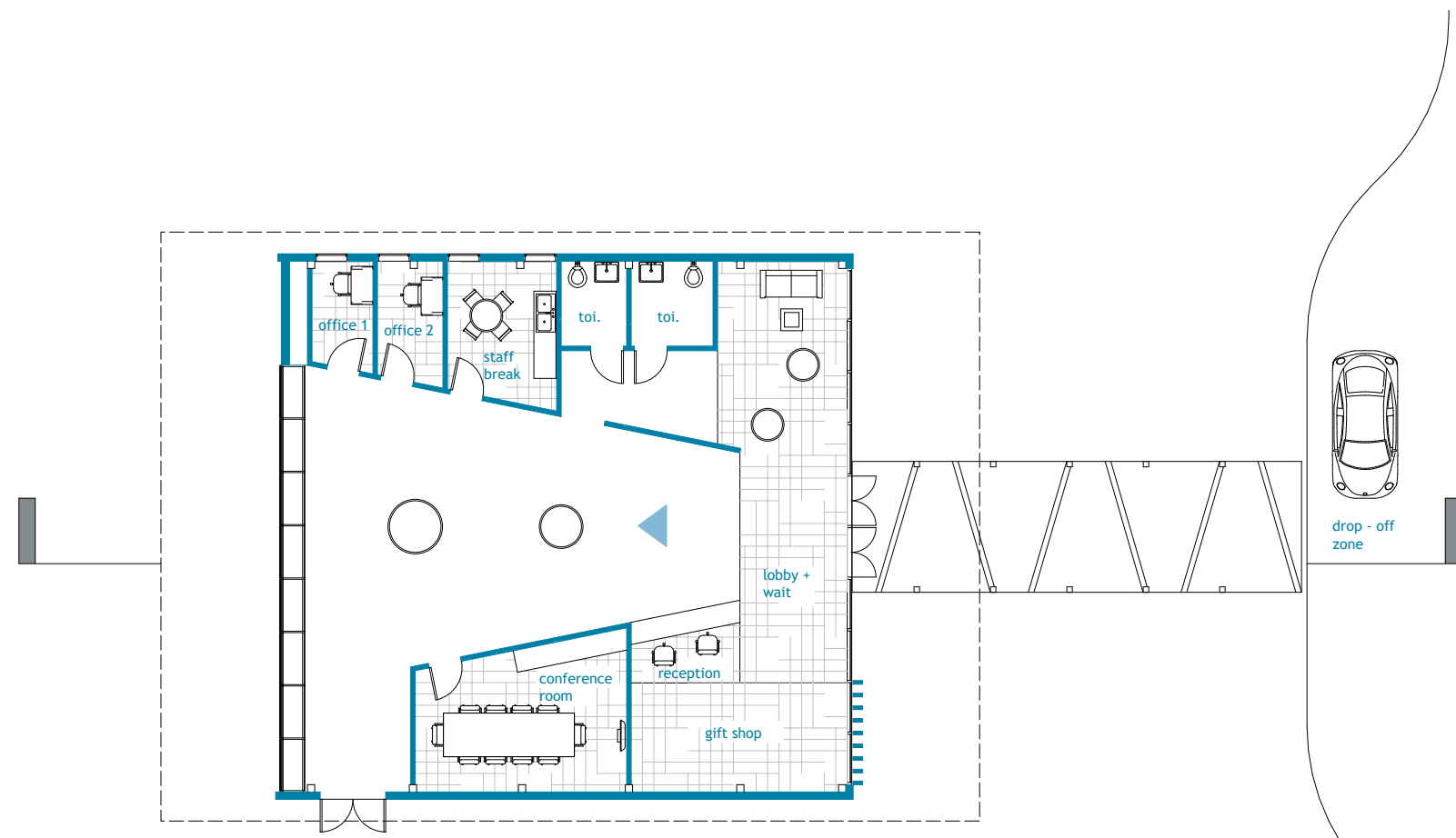

Administration building



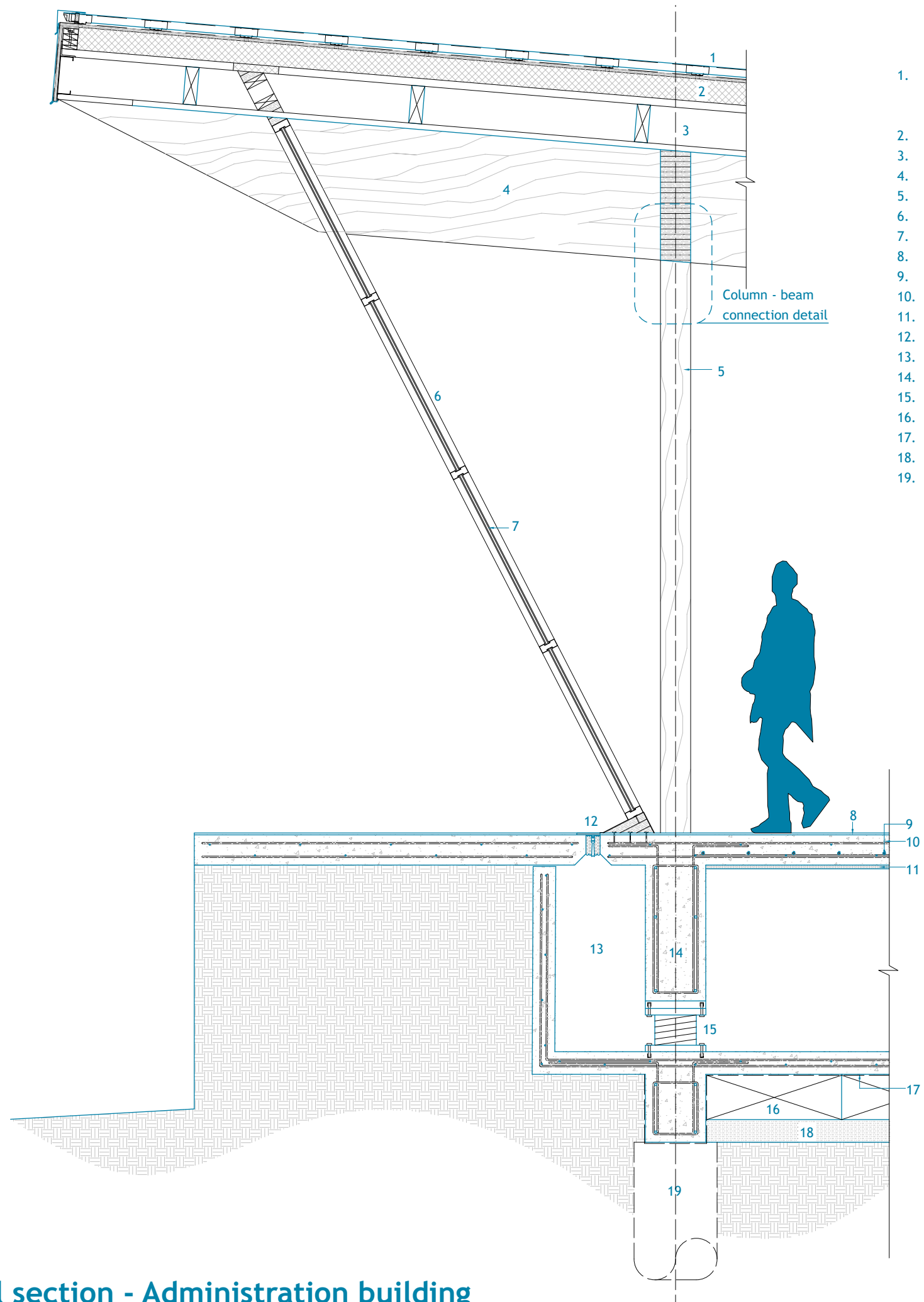

1. Pre-finished metal standing seam roof system over sheet membrane waterproofing over 3/4" sheathing
2. 6" spray-in foam insulation
3. Wood joists
4. Glu-laminated beam beyond
5. 8"x8" glu-lam timber column
6. Custom aluminum curtain wall system
7. 1" thk. seismic glass
8. 1/2" natural stone flooring
9. PEX tube tied to wire mesh by metal wire
10. Radiant heating concrete slab
11. 1" thk extruded polystyrene insulation
12. Expansion joint
13. 2' wide moat
14. 36" deep concrete grade beam
15. Base isolator
16. 6" cavity with carton forms
17. Vapor barrier lapped 12" along all edges
18. Compacted soil
19. 22" dia. drilled pier

Column - beam connection detail

Wall section - Administration building

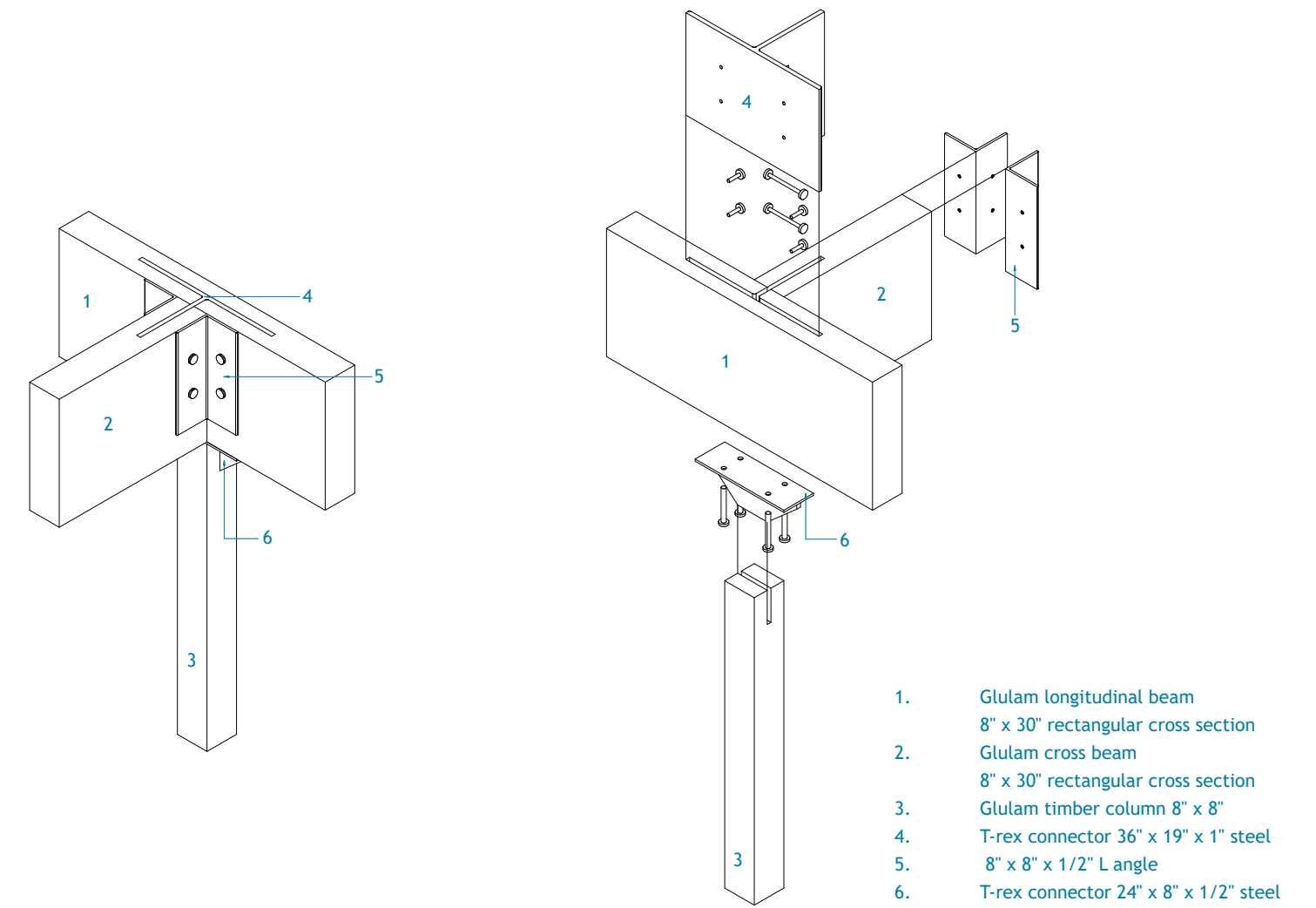

1. Glulam longitudinal beam  
8" x 30" rectangular cross section
2. Glulam cross beam  
8" x 30" rectangular cross section
3. Glulam timber column 8" x 8"
4. T-rax connector 36" x 19" x 1" steel
5. 8" x 8" x 1/2" L angle
6. T-rax connector 24" x 8" x 1/2" steel

Column - beam connection detail

The *dining building* is located adjacent to the administration building to the south, connected by a walkway. The walkway leads into the dining building, becoming a glass bridge, with the walking and cycling track passing underneath it. As one approaches the dining building, an herb planter box beside the glass bridge denotes the function of the building. The *dining deck* on the west side, with a sloping roof and outward tilting wall *directs views outside*. The kitchen and storage areas are on the eastern side of the building, with the roof sloping upward to the east allowing *natural ventilation* of the space using the winds that blow from west to east. A skylight and cutout in the center of the layout allows natural light to penetrate into the building and the walking and cycling track below. The topography of the site helps create open space below the dining deck which is used as a lounge area where visitors can bring their plates of food or drinks downstairs and enjoy their meal in the open. The lounge area spills out from the shade of the dining deck with shaded picnic tables and a sunken fire pit looking out into the expanse of the ocean.

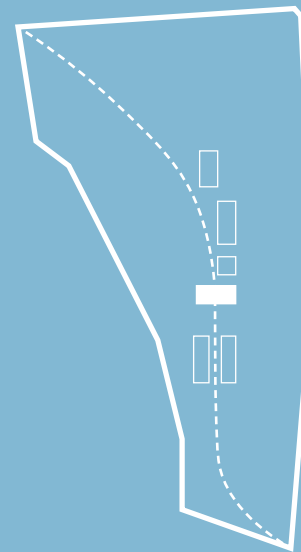

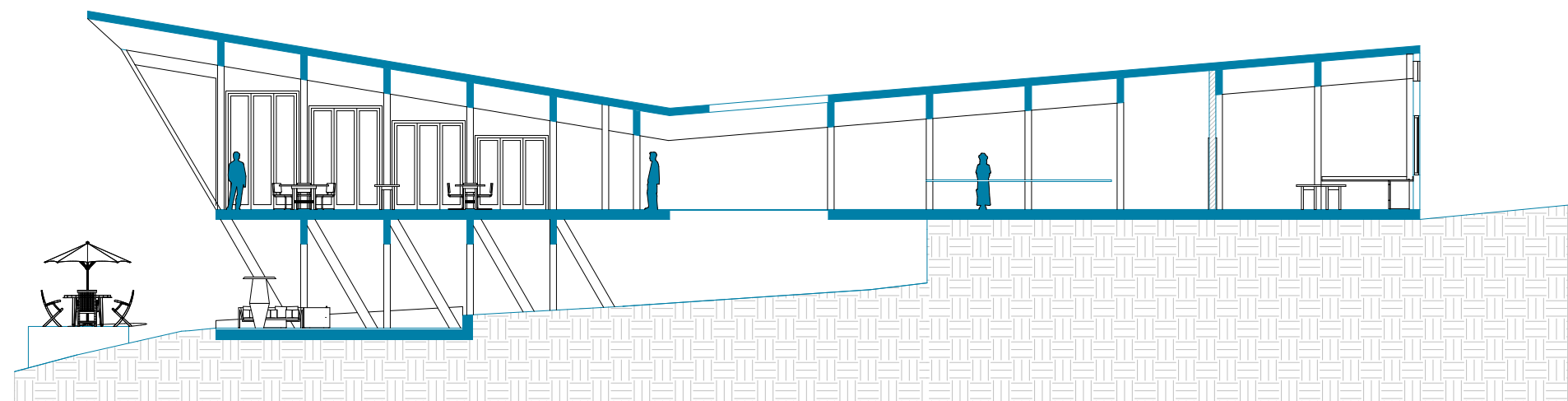
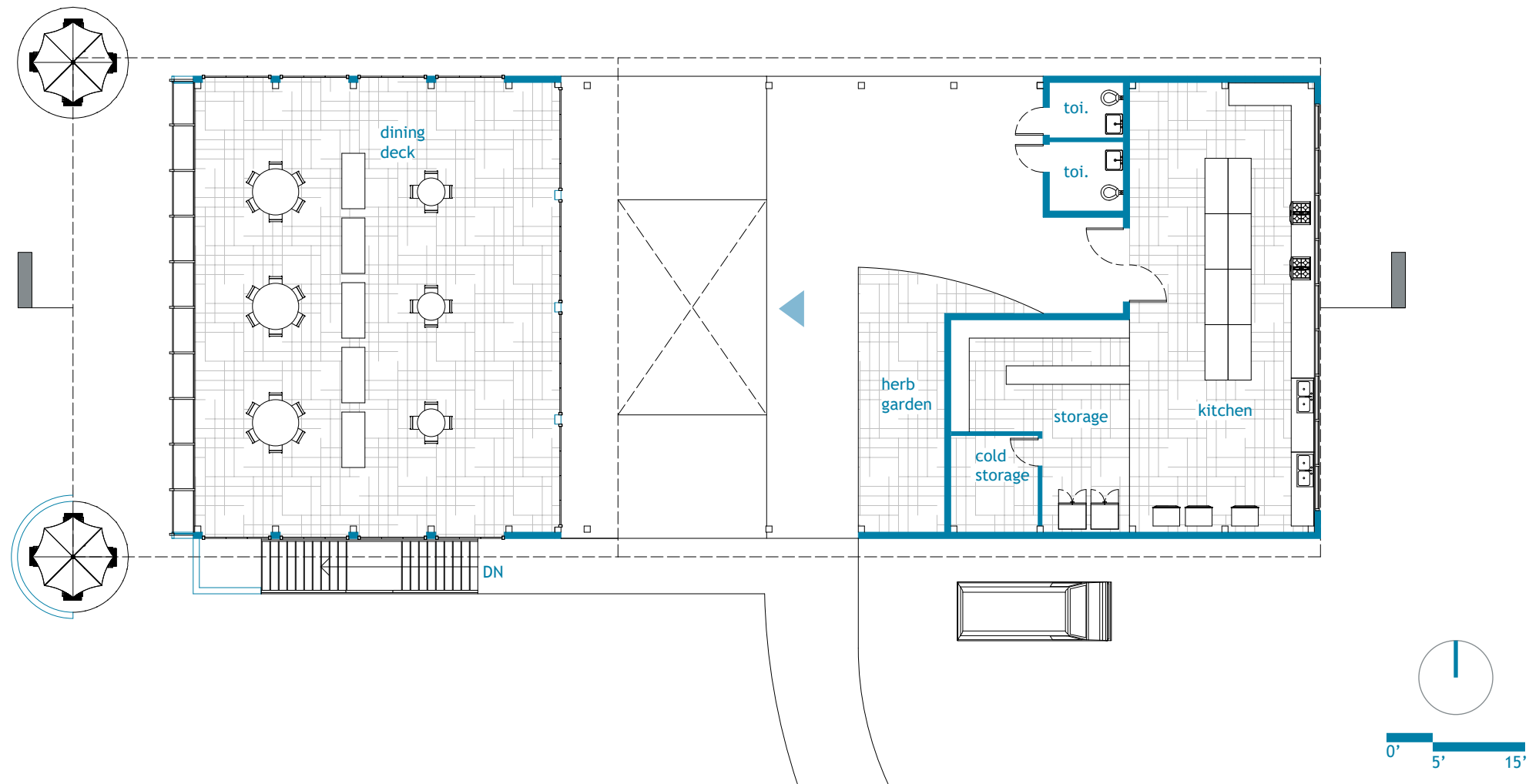





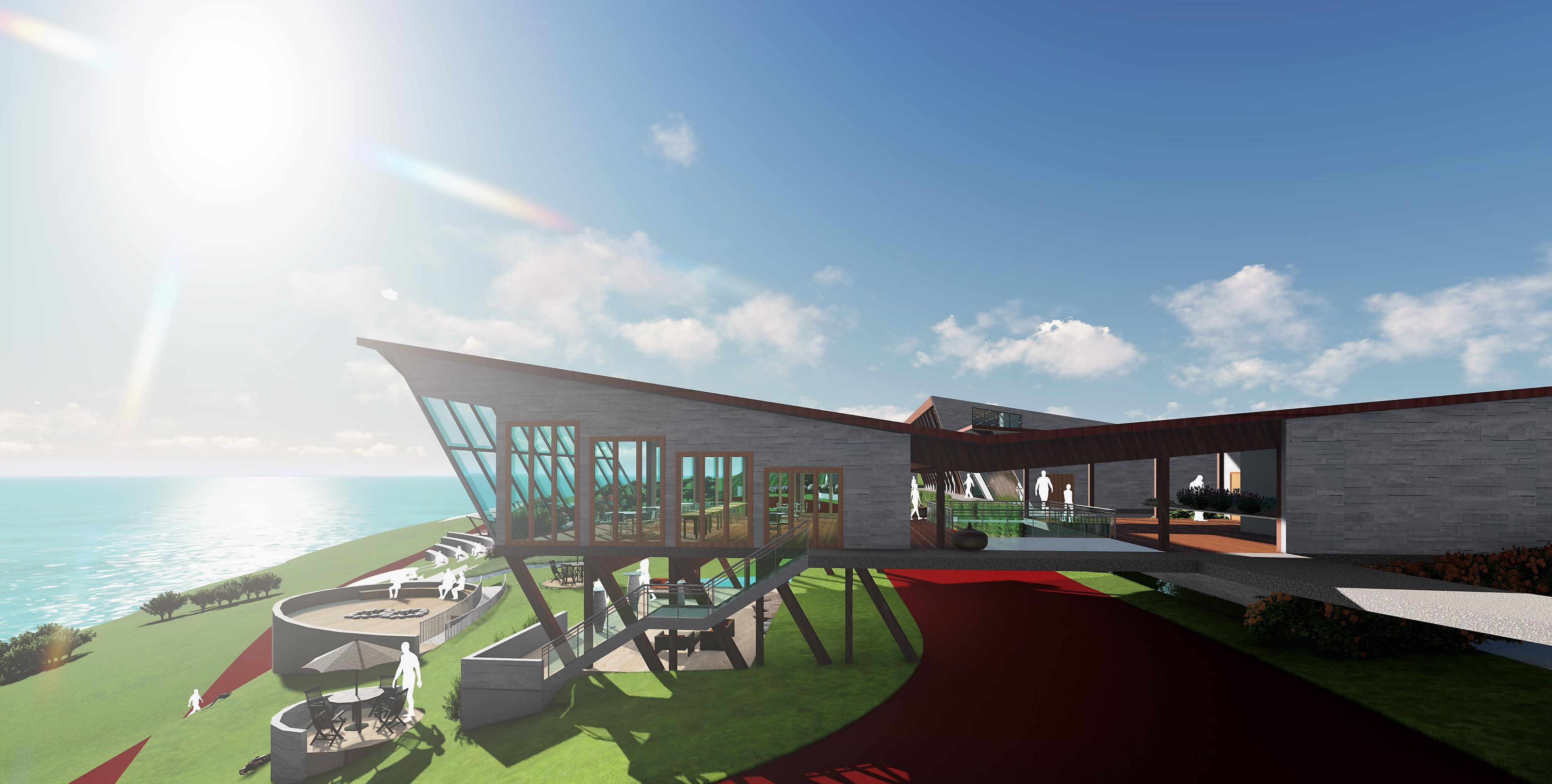

The *residential buildings* lie south of the dining building and are split in two due to the natural terrain of the site to allow ample open space surrounding each building. The eastward building has a corridor leading into *10 single-bed rooms* that open out into balconies looking out to the grape vines and the ocean. The westward building consists of *5 double-bed rooms* and *5 suite rooms* following the same layout as the former building. It has a *green roof* at the floor level of the east building so that views from those balconies are not interrupted by a building, but a green space is seen. The area between the two buildings creates an enclosed relaxing space in the form of a landing accessed from the east building by a ramp and the west building corridor using stairs. This space can be used when visitors want to be in the open but protected from the winds. Half height walls with vertical slits line the corridor allowing *natural light in, views outside*, and preventing them from feeling dull.

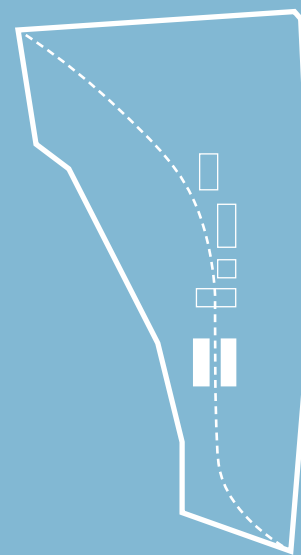

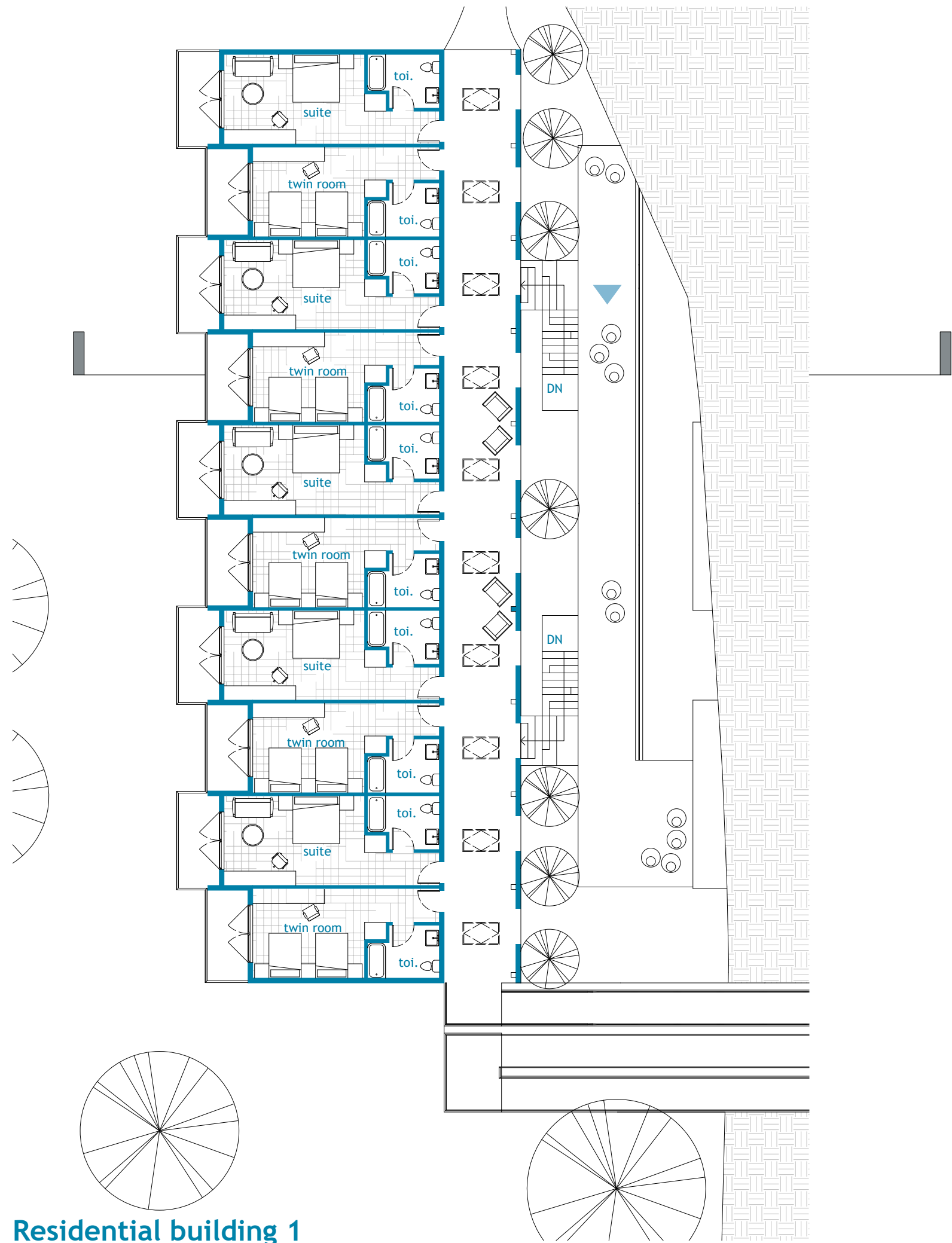

Residential building 1

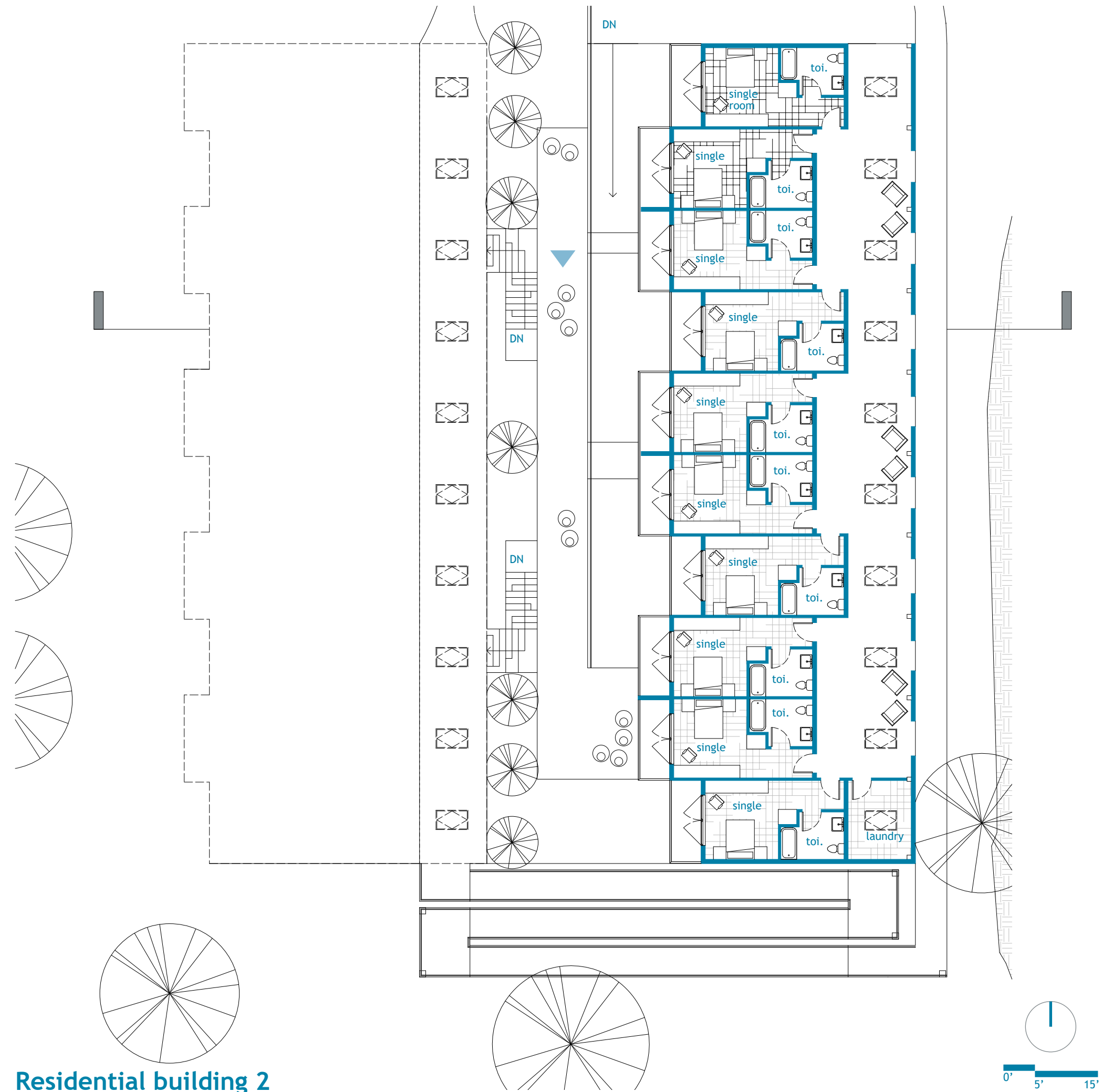
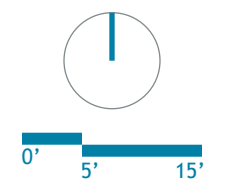

Residential building 2

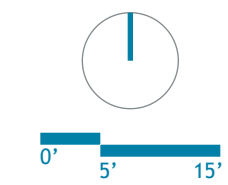

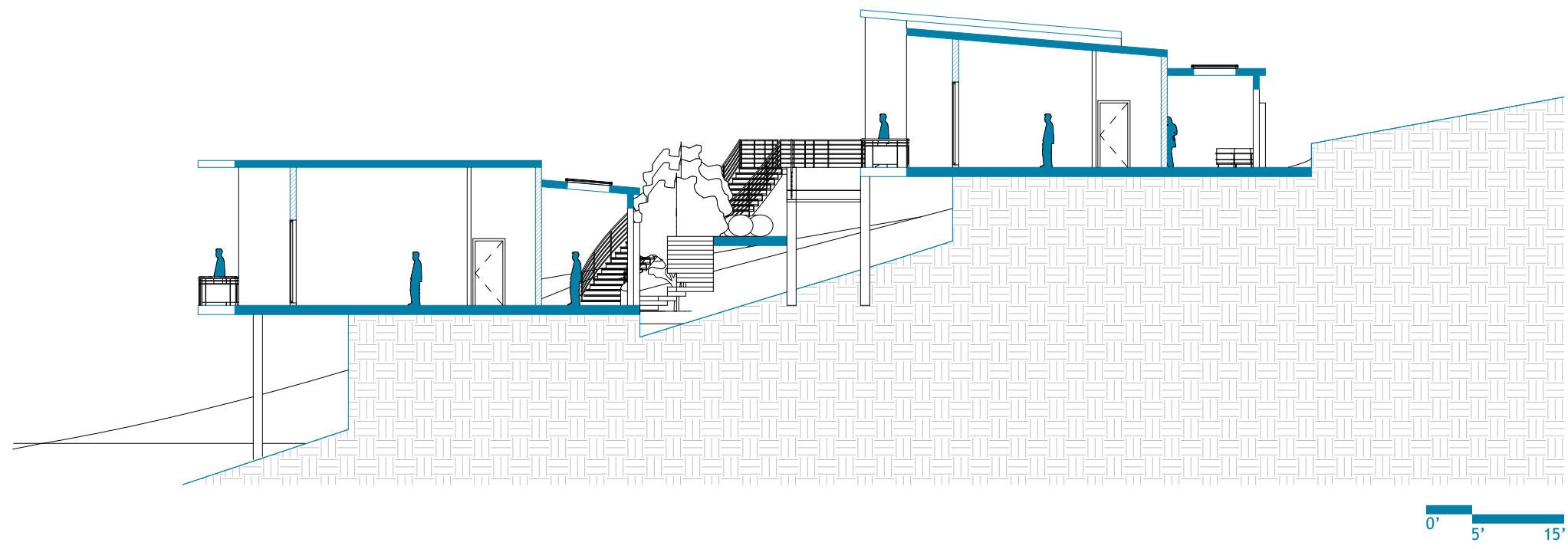

Residential building



The *treatment building* is located north of the administration building. The entrance lobby leads to the consultation rooms where visitors first go and get their plan for the day. This leads into a central common area consisting of the waiting space and pharmacy radiating out into various treatment rooms (massage, acupuncture, detox, chiropractic room, aroma therapy, sound therapy, physiotherapy and naturopathy). Small windows in these rooms open up the room to the outside while maintaining *privacy*. A staircase from the entrance lobby leads to level 2 reserved entirely for sunbathing. Complete privacy for this activity is ensured by partition walls between each bed and the requirement for ample sunlight while being protected from the weather is met by using curtain walls and a glazed roof. An outward tilting west wall on level 2 directs views to the ocean and also forms a shaded pathway for pedestrians below. A deck outside the treatment building leads to a foot reflexology track that follows the curve of the walking and cycling track, *connecting the built space with the landscape and forming a wholesome composition*.

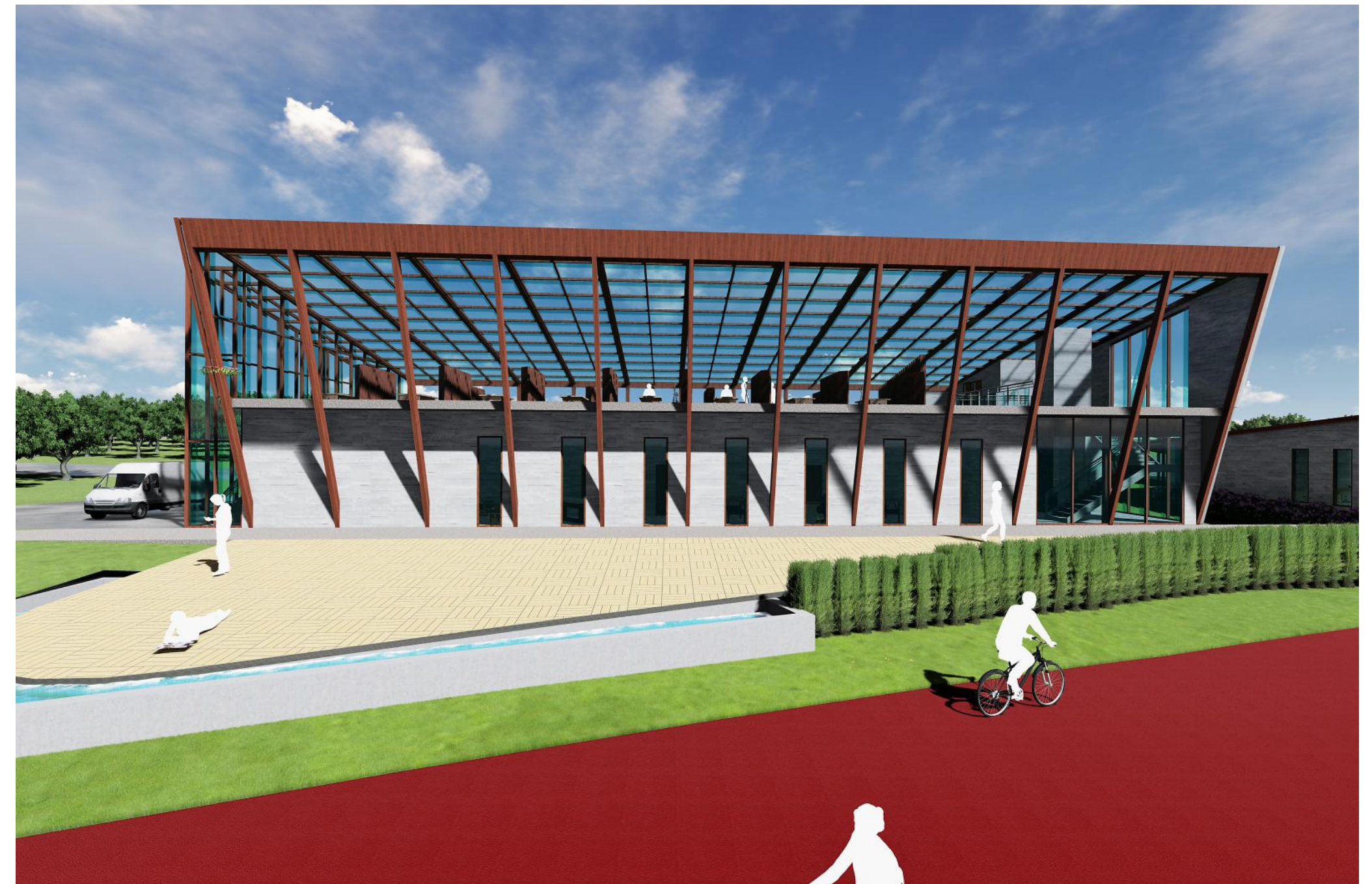
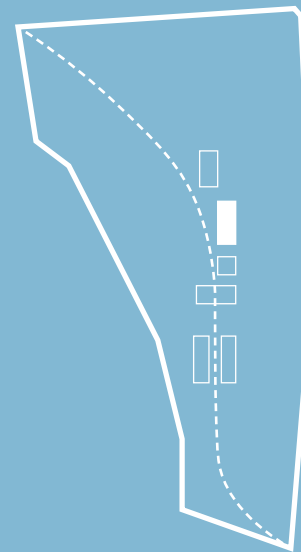

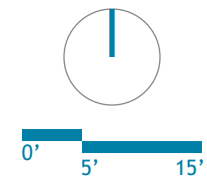

Treatment building - Level 1

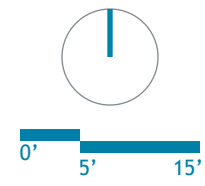
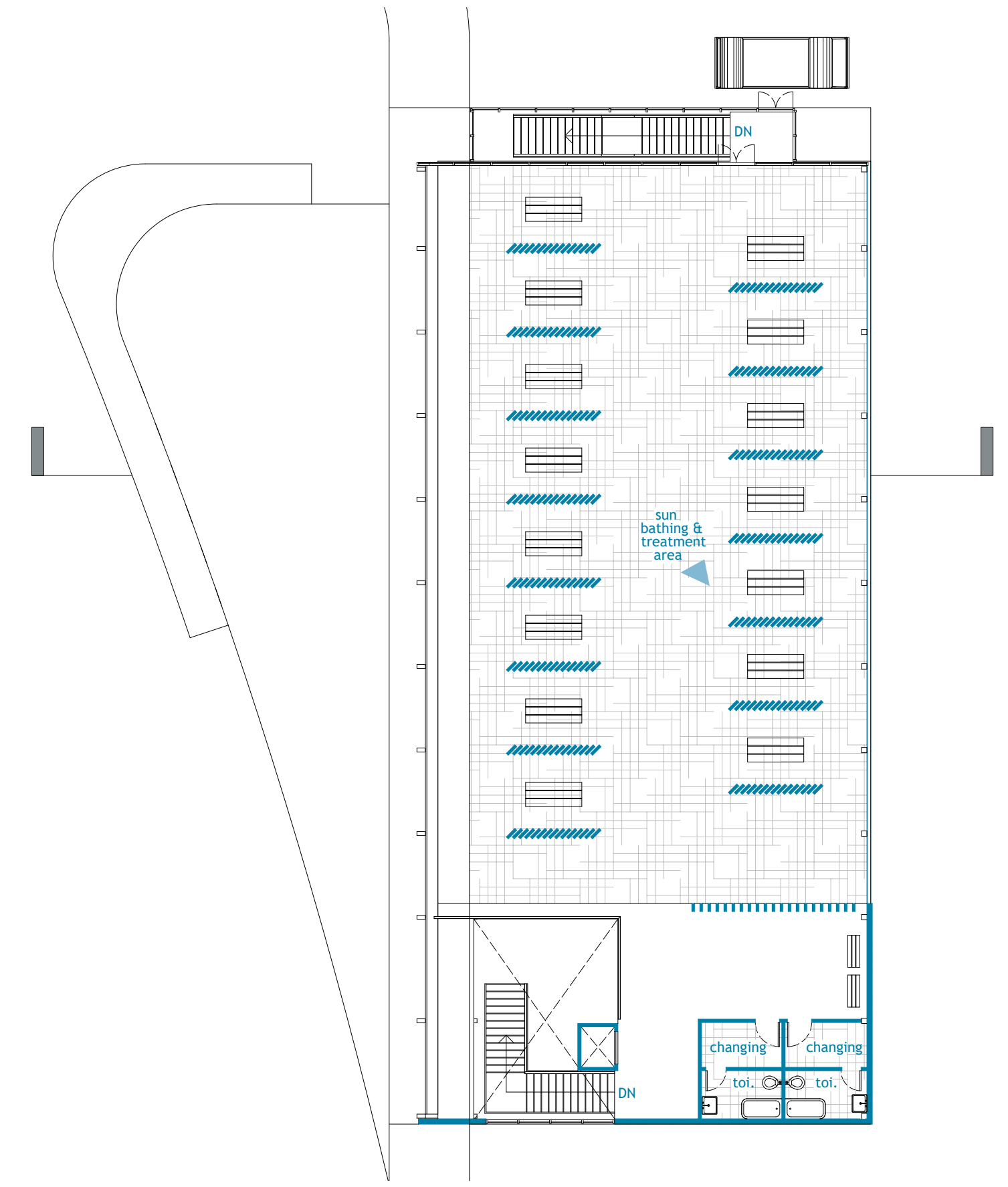

Treatment building - Level 2

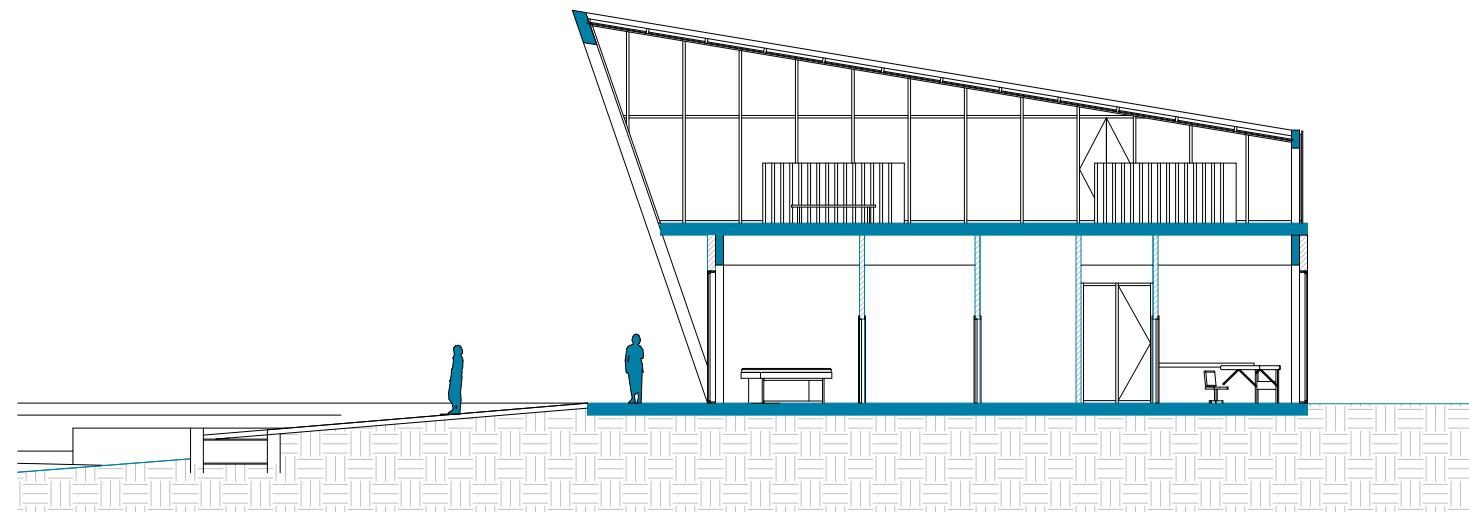



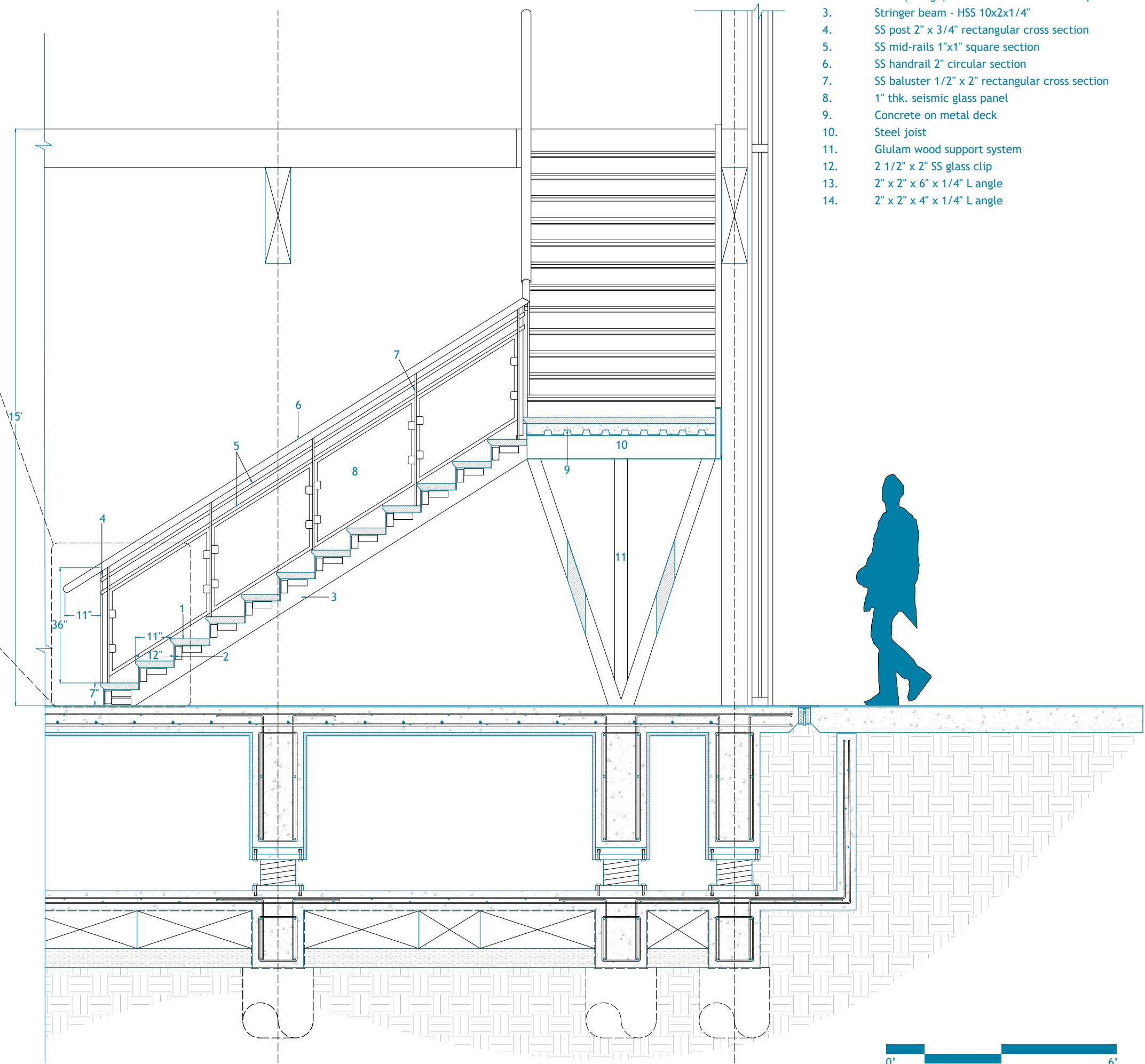
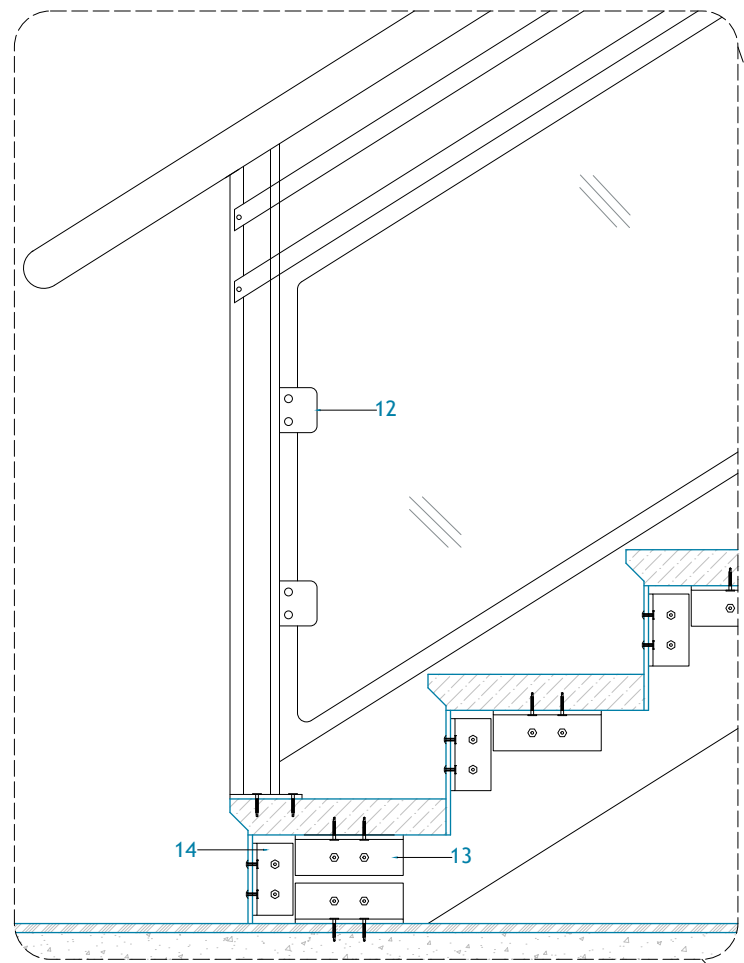
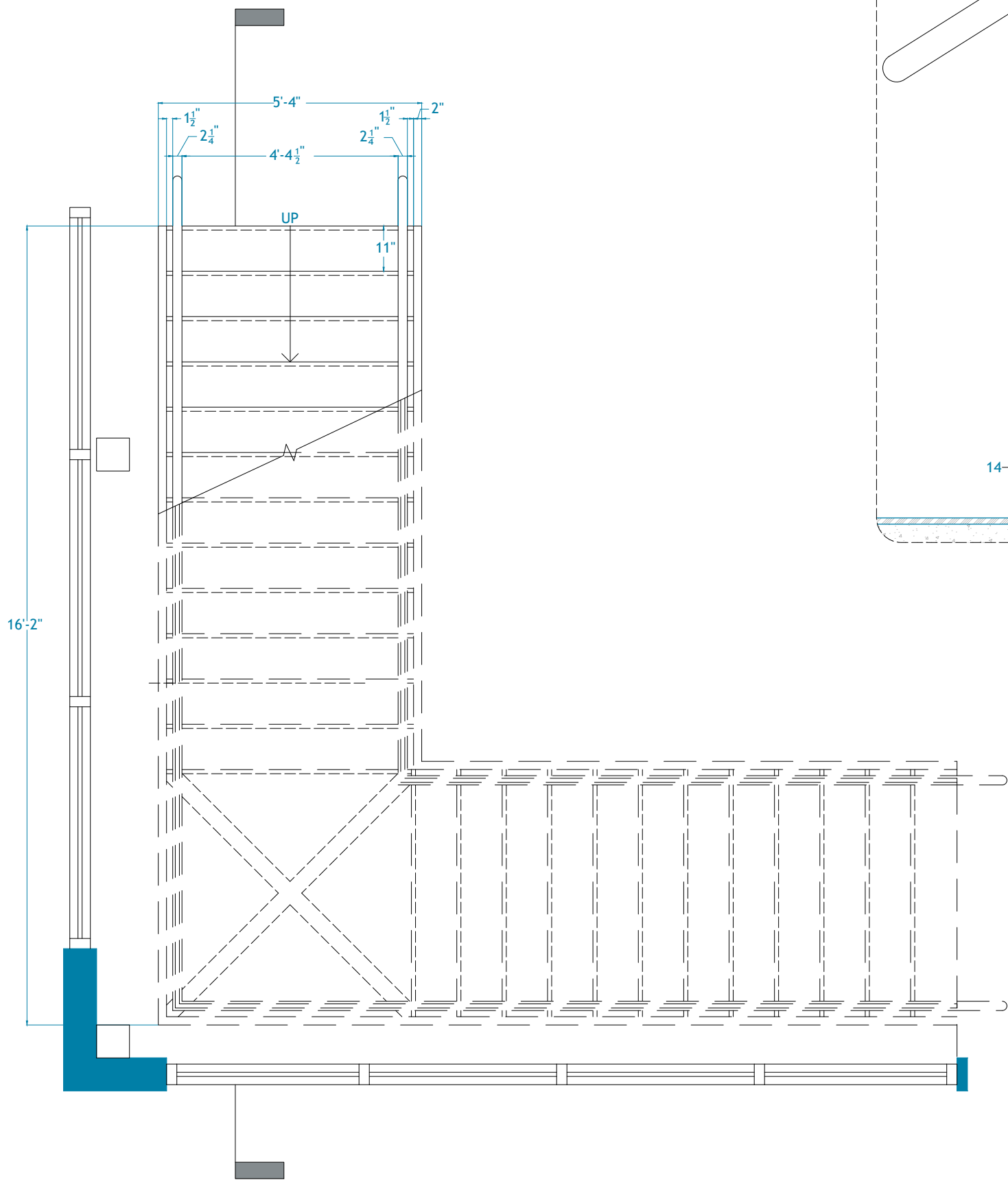

1. Tread (12" wide) made of 2" thk. wood
2. Riser (7" high) made of 1/4" thk. wooden panel
3. Stringer beam - HSS 10x2x1/4"
4. SS post 2" x 3/4" rectangular cross section
5. SS mid-rails 1"x1" square section
6. SS handrail 2" circular section
7. SS baluster 1/2" x 2" rectangular cross section
8. 1" thk. seismic glass panel
9. Concrete on metal deck
10. Steel joist
11. Glulam wood support system
12. 2 1/2" x 2" SS glass clip
13. 2" x 2" x 6" x 1/4" L angle
14. 2" x 2" x 4" x 1/4" L angle

Staircase details - Treatment building



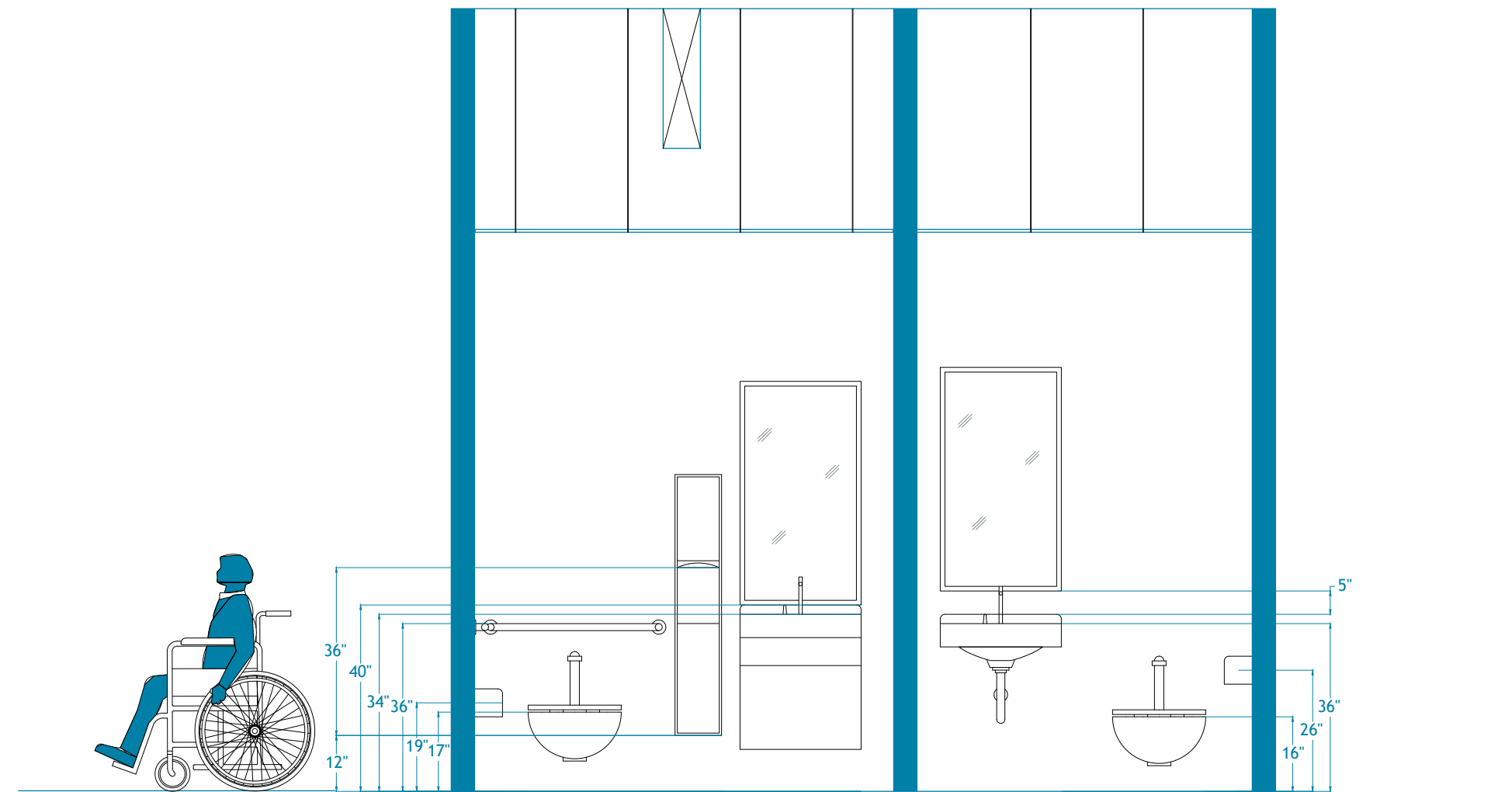
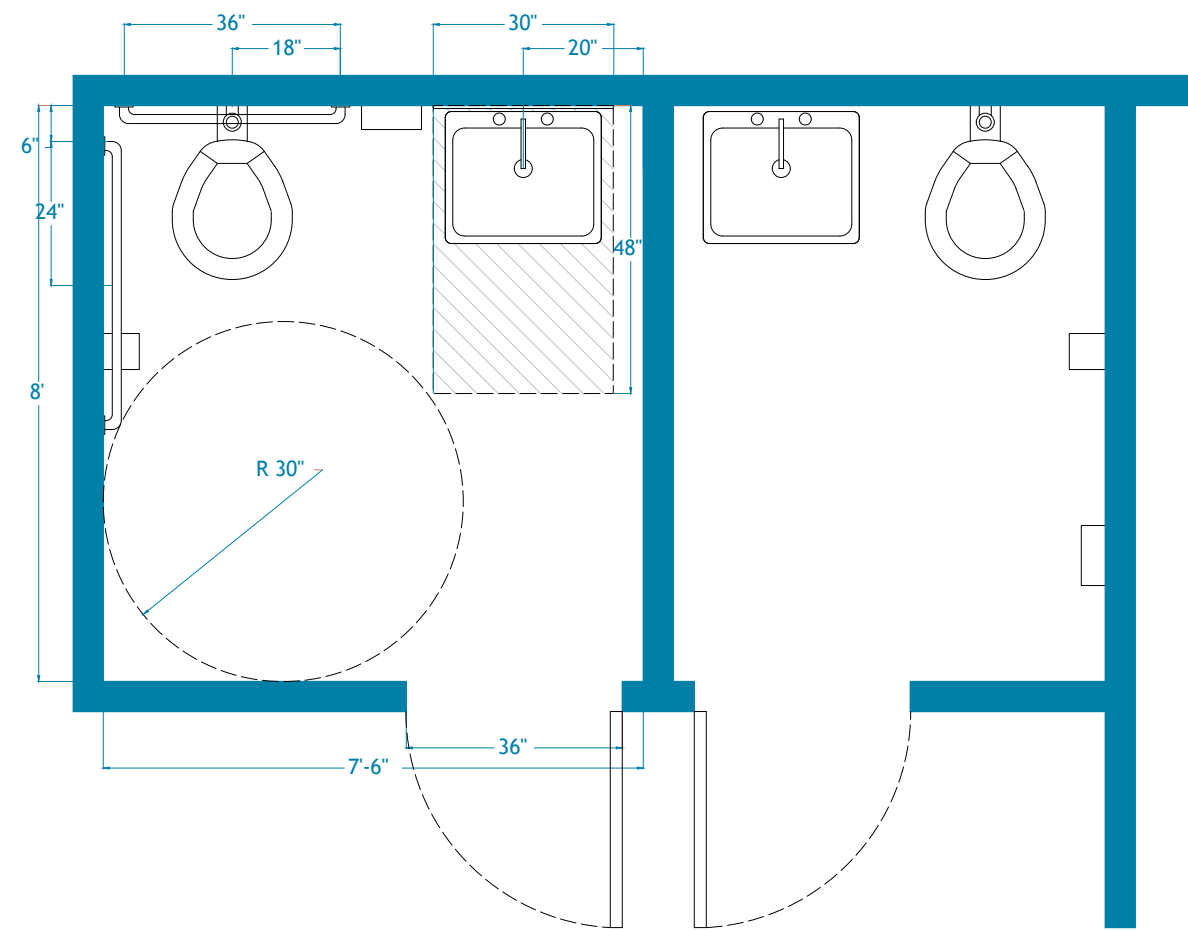

The *recreation building*, north of the treatment building, terminates the linear arrangement of buildings. A walkway shaded by plants (pergola) leads into the lobby which separates the dry and wet areas of this building. The lobby leads into an auditorium for educational and recreational videos, a multi-purpose room for use when the stepped area in the garden cannot be used due to bad weather, and a game room with a pool table and board games to the right. To the left are the wet areas including a teaching kitchen looking out into the fruit orchard and crops, and steam and sauna rooms with locker rooms which lead outside to a deck and a saltwater infinity pool. The infinity pool becomes a *termination point*, having *360° views to all the buildings to the left, the garden and ocean in front, the crops and view deck to the right, and the plant-covered pergola behind, bouncing one's view back to the garden and ocean due to its outward-sloping columns.*

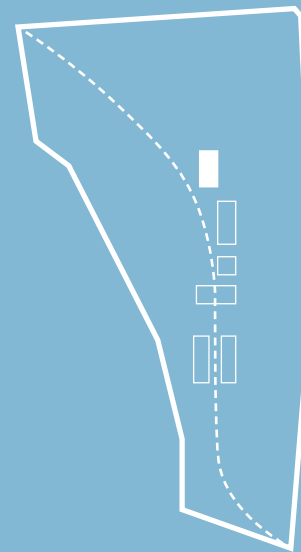



Recreation building



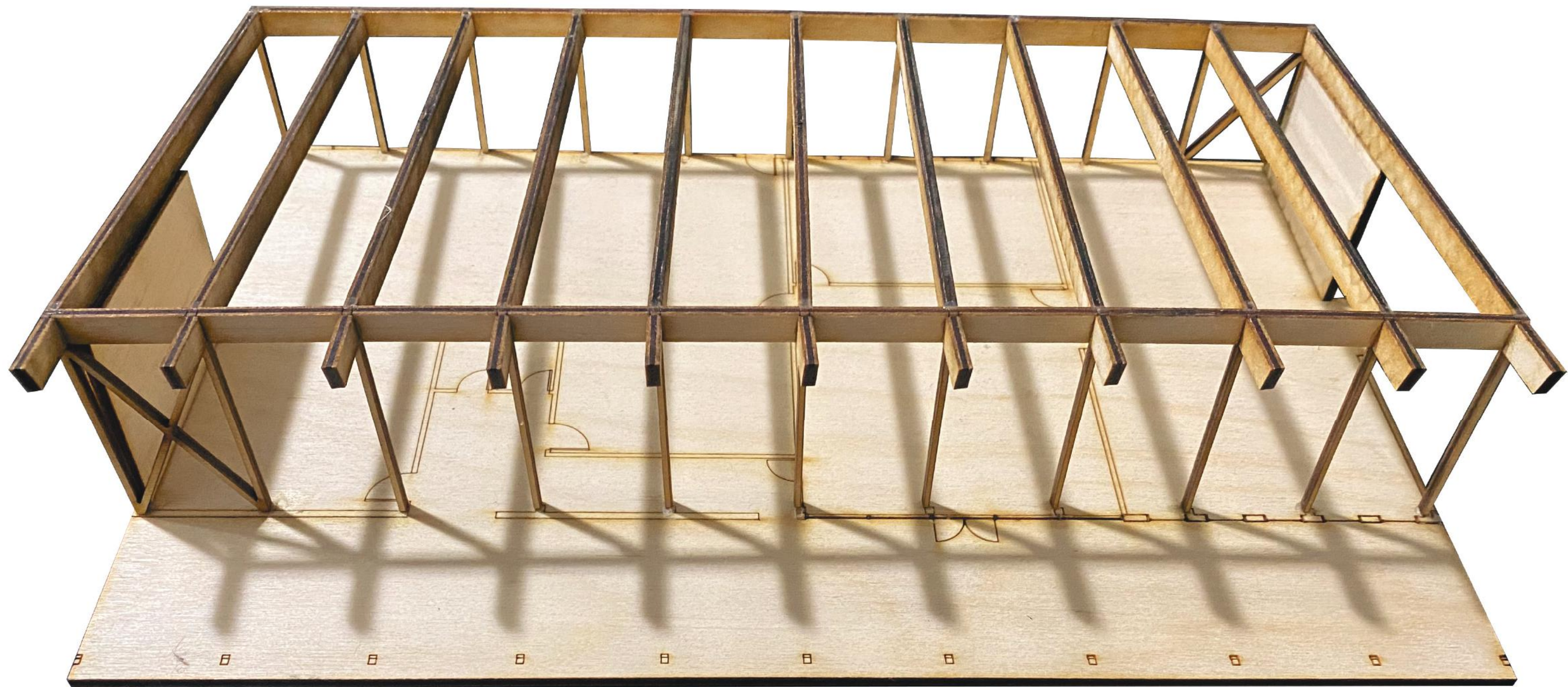

*Looking back*





The architecture of The Healing Crystal is *therapeutic* in itself by utilizing and activating the *senses of smell, touch, sound, taste, and sight*. It uplifts people's spirits and *creates a journey*. The architecture is *empathetic to the therapy*.

### References:

- Kellert, S. R., Heerwagen, J., & Mador, M. (2011). Biophilic design: the theory, science and practice of bringing buildings to life. John Wiley & Sons.
- Clayton, M. J., Booth, G. J., Kim, J. B., & Zarrinmehr, S. (2013, August). Quadruple Net Value Analysis using Building Information Modeling and Immersive Visualization. In The Proceedings of ENHSA 2013 Conference, Naples, Italy.



