

ARCHITECTURAL INFORMATION MODELING (AIM):  
TEACHING FORMAL CONCEPTS OF DESIGN USING BUILDING INFORMATION  
MODELING (BIM)

A Dissertation

by

NANCY SALMAN MOHAMMAD ALASSAF

Submitted to the Office of Graduate and Professional Studies of  
Texas A&M University  
in partial fulfillment of the requirements for the degree of

DOCTOR OF PHILOSOPHY

Chair of Committee,	Mark J. Clayton
Co-Chair of Committee,	Gabriel Esquivel
Committee Members,	Wei Yan
	Tracy Hammond
Head of Department,	Robert Warden

December 2019

Major Subject: Architecture

Copyright 2019 Nancy Alassaf

## ABSTRACT

This research focuses on overcoming the difficulties of using BIM in conceptual design. It suggests that incorporating formal knowledge with computational concepts within BIM enables the tool to support the conceptual design process. This research used a *mixed-methods* approach that comprised of historical-interpretive research, model-based inquiry, and quasi-experimental research. First, a computational framework called Architectural Information modeling (AIM) was developed. AIM is a computational design framework that uses BIM to represent a formal language explicitly and provide a generative description of an architectural style. It employs various strategies to define conceptual design vocabularies and syntactical rules. In AIM, a direct connection between the abstract diagram and the actual built form is established. Second, the formal language of Richard Meier was selected as a test case. AIM was used to code the language of the Douglas house and generate the Smith house from the same model. Moreover, various other options that have the same formal language were created using the same model. The notion of stylistic change was explored too. Second, architectural design pedagogy was selected as an area of exploration to validate AIM. A pedagogical framework to teach AIM was developed to conduct a quasi-experimental study in the form of a longitudinal study. At the College of Architecture at Texas A&M University, three second-year design studios (38 students) participated in this intervention study. Data were collected through observations, student survey, student writing assignments, and student projects. Descriptive and inferential statistical methods, content analysis, and a panel of experts were used to analyze the data. The findings of the study illustrate that AIM can provide a shift from BIM as a construction-oriented modeling environment to a design environment where the architect can think, design, and



generate multiple design options that incorporate explicit aesthetic and intellectual values. This research has produced significant original contributions in four areas: Building Information Modeling (BIM), the theory of formal language and formal studies in architecture, architectural design education and the role of BIM in design studios, and conducting research through design.

## DEDICATION

This dissertation is dedicated to my parents, Salman and Eman, and my husband, Mohammad Alsmadi, for their unyielding love, support, and encouragement.

## ACKNOWLEDGEMENTS

Throughout this research, I have received a great deal of support and assistance. I want to express my deepest gratitude and appreciation to all of my committee members. Dr. Mark J. Clayton, my committee chair, gave me scholarly guidance, rigor, support, and enthusiastic encouragement. Prof. Gabriel Esquivel, the Co-Chair of the committee, helped me increase my understanding of architectural design and theory, and provided tremendous support. I would like to express my sincere gratitude to my committee members, Dr. Wei Yan and Dr. Tracy Hammond, for their feedback back and support.

Thanks also go to Dr. Hyoungsub Kim for his support to implement the research in his two design studios. I am also grateful to Vincent Canizaro, Awilda Rodriguez, and Ward Wells for their invaluable contribution to the expert panel and their insightful suggestions. Thanks to my friends, colleagues, and faculty members in the department of architecture at Texas A&M University. I am very thankful to my fellow Ph.D. students in the BIM-SIM lab. Thanks to Prof. Geoffrey Booth, Dr. Valerian Miranda, Dr. Stephan Caffey, Dr. Ahmed K. Ali, for your encouragement and support.

Above all, I wish to express my sincerest thanks and appreciation to my father and mother for their unconditional love, patience, and consistent support of my academic endeavors over the years. Finally, I am deeply indebted to my husband for his warm love, continued patience, and endless support.

## CONTRIBUTORS AND FUNDING SOURCES

This work was supervised by a dissertation committee consisting of Mark J. Clayton (chair), Gabriel Esquivel (co-chair) and Wei Yan of the Department of Architecture and Tracy Hammond of the Department of Computer Science and Engineering

All work for the dissertation was completed independently by the student.

The student was financially sponsored by the University of Jordan from Fall 2015 to Spring 2019. This project is partially supported by a fund from the CRS center at Texas A&M University.

## NOMENCLATURE

ASHA	American Speech-Language-Hearing Association
API	Application program interface
BIM	Building Information Modeling
AIM	Architecture Information Modeling
CAD	Computer-aided design
TAMU	Texas A&M University
FERPA	Family Educational Rights Act
IRB	Institutional Review Board
A-S-G	Analysis, synthesis, and options generation
FE	Family Editor
CDE	Conceptual Design Environment
PE	Project Environment
NURBS	A non-uniform rational B-spline
NY5	New York Five
B.E.D	Bachelor of Environmental Design

## TABLE OF CONTENTS

	Page
ABSTRACT .....	ii
DEDICATION .....	iv
ACKNOWLEDGEMENTS .....	v
CONTRIBUTORS AND FUNDING SOURCES .....	vi
NOMENCLATURE .....	vii
TABLE OF CONTENTS .....	viii
LIST OF FIGURES .....	xi
LIST OF TABLES .....	xvi
1. INTRODUCTION .....	1
1.1. Background .....	2
1.2. Research Problem .....	5
1.3. Research Objectives and Hypotheses .....	9
1.4. Limits to Research Scope .....	12
1.5. Research Method .....	12
1.6. The Significance of The Study .....	14
1.7. Overview of Chapters .....	14
2. LITERATURE REVIEW .....	17
2.1. Theory of Architecture .....	17
2.2. The Computability of Architectural Design Knowledge .....	26
2.3. Building Information Modeling BIM .....	38
2.4. Architectural Design Education .....	45
2.5. Summary .....	53
3. RESEARCH METHOD .....	57
3.1. Phase I: Development Phase of The Study .....	57
3.2. Phase Ii: Validation Phase of The Study .....	66
3.3. Reliability and Validity .....	75
3.4. Limitations .....	77

3.5.	Summary .....	78
4.	THE COMPUTATIONAL FRAMEWORK (AIM) AND THE TEST CASE .....	80
4.1.	AIM Framework .....	81
4.2.	Richard Meier's Formal Language as A Test Case .....	94
4.3.	AIM as A High-Level Design System .....	118
4.4.	Summary .....	120
5.	THE PEDAGOGICAL FRAMEWORK DEVELOPMENT AND VALIDATION ..	123
5.1.	Developing the Pedagogical Framework .....	123
5.2.	The Intervention Study .....	135
5.3.	The Expert Panel (Focus Group) .....	144
5.4.	Summary .....	156
6.	THE FINDINGS OF THE VALIDATION PHASE OF THE STUDY .....	158
6.1.	The Results of The Intervention Study .....	158
6.2.	The Results of The Expert Panel .....	190
7.	ANALYSIS AND SYNTHESIS .....	211
7.1.	BIM And Conceptual Design .....	212
7.2.	BIM And Architectural Design Pedagogy .....	219
7.3.	Research in Design Studio .....	221
7.4.	Summary .....	222
8.	CONCLUSIONS AND FUTURE RESEARCH .....	225
8.1.	Significance of The Research and Contributions .....	226
8.2.	Limitations .....	228
8.3.	Implications of The Research .....	230
8.4.	Future Research .....	231
REFERENCES	.....	234
APPENDIX I	.....	253
APPENDIX II	.....	256
APPENDIX III	.....	262
APPENDIX IV	.....	264

APPENDIX V .....	268
APPENDIX VI .....	269
APPENDIX VII .....	272
APPENDIX VIII .....	274
APPENDIX IX .....	279
APPENDIX X .....	281
APPENDIX XI .....	285
APPENDIX XII .....	291



## LIST OF FIGURES

	Page
Figure 1 The three components of computational design research in architecture as outlined by Mitchell (1986) .....	11
Figure 2 Using BIM to reallocate the effort and time spent in the construction documentation phase to place more emphasis on the conceptual design phase, adopted from (Eastman et al., 2008). .....	41
Figure 3 Architectural Information Model shows the spatial structure and the conceptual elements at the Casino, at Ghent, Belgium. Adopted from (Pauwels et al., 2008).....	45
Figure 4 The structure of the research method .....	58
Figure 5 Learning spaces. A: Design studio, B: Lecture space, C: Computer lab, D: Exhibition, and review space.....	63
Figure 6 The problem space of ‘ <i>educational design</i> ,’ adopted from (Goodyear, 1999).....	65
Figure 7 The activity of analysis in AIM .....	84
Figure 8 The logic of divide and conquer strategy in formal systems.....	84
Figure 9 Three different ways to construct a rectangular plane: In A: length and height parameters, B: upper length, lower length, and height parameters, C: X, Y parameters for the points at the Spline curve, D: is the same case of C but with different values for the X, Y parameters .....	87
Figure 10 Four different ways to construct a rectangular prism. They all share the same initial state, but each one behaves differently when we change its parameters. ....	88
Figure 11 Use material parameters to color code the conceptual diagram distinguish between circulation (orange), main living mass (white), minor additions (dark gray), and void masses or subtractions (transparent gray).....	89
Figure 12 A simple conceptual vocabulary that has two types: Solid and Void. ....	89
Figure 13 The use of divide and conquer strategy to construct the conceptual diagram of Guardiola house by Peter Eisenman. A: a simple vocabulary; B: a combined L-Form vocabulary. C: a nested syntactic unit. D: the final conceptual diagram .....	91
Figure 14 The activity of synthesis in AIM .....	92

Figure 15 The activity of options generation in AIM .....	93
Figure 16 The Douglas House in Harbor Springs, Michigan (Al-Assaf & Clayton, 2017) .....	96
Figure 17 The elements of construction in Meier’s language used in modeling the Douglas house in PE. 1: curtain wall, 2: mullions, 3: windows, 4: beams, 5: doors, 6: railings, 7: slabs, 8: walls, 9: flat roof, 10: circular column (Al-Assaf & Clayton, 2017) .....	99
Figure 18 A syntactic unit that has an A-B-A layering system in CDE .....	102
Figure 19 The public unit (transparent) and the private unit (opaque) in CDE .....	102
Figure 20 Define the transverse axis (entry axis) through reference planes in CDE.....	103
Figure 21 Employing a series of formal additions and subtractions from the conceptual vocabularies library to animate the main mass in CDE.....	103
Figure 22 Two different behaviors of a rectangle prism. A: Width, Length, and Height parameters with equality constraint, B: Width, Length, and Height parameters without equality constraint.....	105
Figure 23 Modeling the conceptual diagram of the Douglass House using CDE and Dynamo. ....	106
Figure 24 The actualization of the conceptual diagram of the Douglass House to a constructible building in PE (Al-Assaf & Clayton, 2017) .....	108
Figure 25 The process of modeling the Douglass House in AIM.....	109
Figure 26 The process of modeling the Smith House in AIM .....	111
Figure 27 Other houses in Meier’s language: Option 1 .....	112
Figure 28 Other houses in Meier’s language: Option 2 .....	113
Figure 29 Other houses in Meier’s language: Option 3 .....	113
Figure 30 Other houses in Meier’s language: Option 4 .....	114
Figure 31 Other houses in Meier’s language: Option 5 .....	114
Figure 32 Other houses in Meier’s language: Option 6 .....	115
Figure 33 A new design option with a new formal language – conceptual diagram in CDE .....	116
Figure 34 The actualization of the conceptual diagram in the Project environment (PE).....	117
Figure 35 Hanselmann House by Michael Graves in AIM. A: the conceptual mass in CDE in Revit, B: The Built form in PE in Revit, C: Virtual reality experience of the house in Enscape .....	137

Figure 36 Update AIM to include spatial planning families. A: spatial planning families with color, name, height, width, area, and level parameters. [ red: vertical circulation, green: kitchen, yellow: bathroom, blue: master bedroom, cyan: bedroom]. B: the main mass. C: a conceptual design that uses the main mass in addition to the spatial planning families .....	141
Figure 37 A: Feedback in the studio as a dialogue between tutor (in orange) and student (in gray). B: Informal Pin-ups .....	144
Figure 38 The expert panel. A: The review process of projects. B: The discussion sessions (experts in gray, the moderator in orange, recorder in red). .....	146
Figure 39 The expert panel. (from left to right): Vincent Canizaro, Awilda Rodriguez, and Ward Wells .....	147
Figure 40 The template of project 1 .....	150
Figure 41 The template of project 2 .....	151
Figure 42 The template of project 3 .....	152
Figure 43 The evaluation sheet of project 1 .....	153
Figure 44 The evaluation sheet of project 2 .....	154
Figure 45 The evaluation sheet of project 3 .....	155
Figure 46 Q1: On a scale of 1 to 5 with 5 being the most positive, I think design can be approached as a systematic process that has an underlying logic. ....	160
Figure 47 Q2: On a scale of 1 to 5 with 5 being the most positive, I can describe the main elements/ vocabulary that I used in my project. ....	160
Figure 48 Q3: On a scale of 1 to 5 with 5 being the most positive, I can describe the main rules/ syntax that I used in my project. ....	161
Figure 49 Q4: On a scale of 1 to 5 with 5 being the strongest, rate the influence of real-life constraints on your design. These constraints include using elements of construction and being aware of their details. ....	161
Figure 50 Q5: On a scale of 1 to 5 with 5 being the strongest, diagrams played an analytical role in my design. It helped me to communicate my ideas and explain form development. ....	162
Figure 51 Q6: On a scale of 1 to 5 with 5 being the strongest, diagrams played a generative role in my design. It helped me in developing my form, thinking about my design, and laying out my design elements according to some predefined rules. ....	163
Figure 52 On a scale of 1-5 with 5 being the strongest influence, rate the following aspects of the digital tools (Revit) that you used as to their likelihood of contributing to your design:	

model your design, visualize your design, create architectural forms, theoretical knowledge, construction knowledge, and select design elements.....	165
Figure 53 On a scale of 1-5 with 5 being the strongest influence, rate the following aspects of the digital tools (Revit) that you used as to their likelihood of contributing to your design: determine design rules, judge the aesthetics of design, and develop formal ideas.....	166
Figure 54 A: On a scale of 1 - 5 with 5 being the most positive, generating multiple design options is a process that consumes a lot of time (e.g. 3-7 days per option). B: On a scale of 1 -5 with 5 being the most positive, I can maintain a consistent style or formal expression (in terms of organizational rules and architectural elements) while generating multiple design options.....	167
Figure 55 The results of the questions about students' level of self-efficacy, part 1 .....	170
Figure 56 The results of the questions about students' level of self-efficacy, part 2 .....	171
Figure 57 The results of the questions about students' level of self-efficacy, part 3 .....	171
Figure 58 A comparison between the result of One-Way Repeated Measures ANOVA analysis	173
Figure 59 Content analysis of the first writing assignment, the results of the single word analysis of the five themes.....	176
Figure 60 Content analysis of the first writing assignment, the theme of function .....	177
Figure 61 Content analysis of the first writing assignment, the theme of building elements.....	177
Figure 62 Content analysis of the first writing assignment, theme of conceptual elements.....	178
Figure 63 Content analysis of the first writing assignment, the theme of design rules and organizational principles.....	178
Figure 64 Content analysis of the first writing assignment, the theme of design.....	178
Figure 65 Content analysis of the first writing assignment, 2-word phrases analysis.....	179
Figure 66 Content analysis of the second writing assignment, the results of the single word analysis of the five themes.....	180
Figure 67 Content analysis of the second writing assignment, the theme of design .....	180
Figure 68 Content analysis of the second writing assignment, the theme of design rules and organizational principles.....	181
Figure 69 Content analysis of the second writing assignment, the theme of conceptual elements .....	182
Figure 70 Content analysis of the second writing assignment, the theme of building elements	182

Figure 71 Content analysis of the second writing assignment, the theme of function ..... 183

Figure 72 Content analysis of the second writing assignment, 2-word phrases analysis. From top:  
the first group is design, the second group is design rules, the third group is conceptual  
elements, the fourth group is building elements, and the fifth group is function ..... 184

Figure 73 Q1: On a scale of 1-5 with 5 being the most positive, rate the design of these houses in  
terms of formal qualities ..... 191

Figure 74 Q2: On a scale of 1-5 with 5 being the most positive, these houses share a common  
formal language ..... 192

Figure 75 Q3: On a scale of 1-5 with 5 being the most positive, these houses have Meier’s formal  
language ..... 193

## LIST OF TABLES

	Page
Table 1 Bloom's revised taxonomy of cognitive skills .....	52
Table 2 An analysis of the formal language of Richard Meier (Al-Assaf & Clayton, 2017) .....	97
Table 3 The conceptual design elements of Richard Meier's formal language.....	99
Table 4 List of parameters to flex the model of the Douglass House in CDE (Al-Assaf & Clayton, 2017) .....	104
Table 5 List of parameters to flex the model of the Douglass House in CDE and Dynamo (Al-Assaf & Clayton, 2017) .....	107
Table 6 The transformation matrix of Meier's formal language.....	117
Table 7 Bloom's revised taxonomy of cognitive skills and AIM.....	131
Table 8 Studio timeline – An eleven-week intervention study .....	142
Table 9 The timeline of the expert panel.....	146
Table 10 The result of One-Way Repeated Measures ANOVA analysis ranked from the lowest significant effect (F=1.508) to the highest significant effect (F=23.134).....	174

## 1. INTRODUCTION

Architectural design has long been understood, compositionally, as a set of vocabulary elements governed by grammatical spatial relations (i.e., syntax). The vocabulary and the syntax constitute the formal language of architectural design. Computer methods have profoundly affected the perception and realization of architectural form. Computer methods allow the design to be a form of *computation* that selects design elements from a vocabulary explicitly and arranges them according to a well-defined set of rules or syntax. In that sense, a student of design may learn to express formal knowledge with computational concepts to use effectively computer-aided architectural design tools to aid design thinking.

Building information modeling (BIM) is considered today one of the major computer-based tools to aid the design and production of architecture in both practice and academia. BIM is defined as an object-based parametric modeling system that represents objects by rules and parameters to govern the geometry as well as non-geometric properties. However, BIM tools today are used primarily for expressing technical aspects and matters of building and construction science. Common practice and provision of software features limit the use of BIM to aid design thinking.

This research suggests that BIM can be used to aid design thinking when it is provided with syntactical tools and supported with a theoretical foundation to guide workflows. Taking architectural design pedagogy as an area of exploration, the research explored and constructed a computational design framework that integrates design fundamentals and computational concepts using BIM. This computational framework is entitled *Architectural Information Modeling* (AIM). AIM is a computational design framework that uses BIM to represent a formal

language explicitly and provide a generative description of an architectural style. The intention is to shift from BIM as a construction-oriented modeling environment to become a design environment where the architect can think, design, and generate multiple design options that incorporate explicit aesthetic and intellectual values.

This research addresses the following primary question: Can we use BIM to aid design thinking? This primary question relies upon several secondary questions: (1) Can one incorporate the architectural design theories with BIM tool in order to establish a formalized theoretical foundation to aid conceptual design? (2) Can one utilize modeling methods and software development methods within BIM to offer *syntactical tools*, as well as a design vocabulary, to support conceptual design? (3) Can one teach AIM to integrate design fundamentals and computational concepts effectively?

To answer these questions, this research developed a *computational framework* (AIM) to aid conceptual design and a *pedagogical* one to test the former. Conceptual design involves several aspects. This research focuses on developing architectural forms, defining the aesthetics of the design with respect to syntax and vocabulary, refining building program (i.e., spatial functions), and identifying building elements. Other aspects of conceptual design, such as economic, environmental, and cultural aspects were not investigated.

## **1.1. Background**

This research relies on the interrelated relationship between architectural design theories, BIM, and design education. Henceforth, the study focuses on the following domains:



### ***1.1.1. Theory of architecture***

This domain addresses architecture as a discipline. First, it differentiates between architecture and building. Building is a translation of practical, functional activity, and socioeconomic conditions into physical constructions that is typically based on the idea of usefulness (Hendrix, 2012). Architecture exceeds the practical dimensions of a building to add *aesthetic* and *intellectual* values (Bachman, 2003; Geoffrey Broadbent, 1973; Rush, 1986). In this research, aesthetics is concerned with formal systems as a mean to systematically describe, interpret, and evaluate existing works of architecture as well as generate new ones (Stiny & Gips, 1978). Second, this domain discusses the notion of design as a conceptual activity to form ideas that can be expressed in a visible form. Third, the theory of formal language, in which architectural design can be understood as a complex of vocabularies governed by grammatical rules (Knight, 1981), is discussed. Fourth, this domain discusses the phase of conceptual design, which typically provides abstract and incomplete solutions that aim to explore the best alternatives (Horváth, 2000). The conceptual design phase is the main focus of this research. It is considered the most difficult, yet critical phase of design because it requires high cognitive skills such as abstraction, analysis, synthesis and creativity (Clayton, Ozener, Haliburton, & Farias, 2010; Mathew & Barrow, 2004). Lastly, this domain discusses diagrammatic thought and its role to support conceptual design.

### ***1.1.2. The computability of architectural design knowledge***

This domain addresses how architectural knowledge can be computed. First, it outlines the three distinct yet related design knowledge that can be computed: descriptive knowledge, normative knowledge, and operational knowledge. Then, it identifies the three substantial

elements that need to be defined: a design theory that shares certain commonalities with computation theories (Kalay, 1990), a digital tool that shares similar logic or underlying structure with the design theory (Akin, 1990), and the role of the designer. Second, this domain discusses computational design systems and distinguishes between *basic design system* and *high-level design system* (Mitchell, 1986). Moreover, the approach to compute architectural design knowledge through *object-oriented representation method* in systems such as KAAD (Knowledge-based Assistant for Architectural Design) is also discussed (Carrara, Kalay, & Novembri, 1994). This domain addresses the process of computing the three main exercises in formal composition: the *analysis* of existing formal system or language, *synthesis*, and the *generation* of multiple design options. Lastly, this domain discusses the computational *representation* of design knowledge in terms of three main characteristics: the representation of the *semantics of design* (Clayton, 2014; Kalay, Swerdloff, & Majkowski, 1990; Leeuwen, 1999), the representation of design at *multiple levels of abstraction* (Cigolle & Coleman, 1990; Do & Gross, 2001; Johnson & Vermillion, 2016; Logan, 1989), and the *dynamism* and the flexibility of representation (Do & Gross, 2001; Parthenios, 2005).

### ***1.1.3. Building Information Modeling (BIM)***

This domain focuses on Building Information Modeling (BIM). First, it discusses the definition of BIM as an *object-based* parametric modeling system that represents objects by rules and parameters. Second, the benefits of using BIM in the three phases of design: pre-construction stage, construction stage, and post-construction stage are discussed. Third, this domain discusses the stage of conceptual design in BIM as the basic framework of design that involves massing, structure, and general spatial layout (Eastman, Teicholz, & Sacks, 2008, p. 203). However, the

conceptual design is considered the most challenging phase in design to integrate BIM (Ambrose, 2009; Holzer, 2011; Michalatos, 2016; Parthenios, 2005). Thus, the recommendations to overcome the ambiguity and complexity of conceptual design in BIM tools are discussed too. Lastly, this domain discusses the shift from BIM as a tool to express the language of building construction to *Architectural Information Modeling* AIM as a way to express the language of architecture and aid design thinking (Briscoe, 2015; Pauwels, Verstraeten, De Meyer, & Van Campenhout, 2008; Pauwels, Verstraeten, De Meyer, & Van Campenhout, 2009a, 2009b).

#### ***1.1.4. Architectural design education***

This domain addresses the related approaches to teach architectural design. First, this domain discusses the development of design pedagogy and the studio culture in architecture. Second, three pedagogical practices of teaching formal language are discussed. These practices focus on teaching formalism through *design fundamentals*, *morphological analysis* and *typological studies*, and *computational design*. Lastly, this domain addresses BIM in design education. Very limited researches addressed the relationship between BIM and design thinking. Most researches in this field focused on the collaborative and multidisciplinary properties of BIM, or the technological aspect of production, evoking students to ask questions about structures, energy consumption, detailing, and material assemblies.

### **1.2. Research Problem**

Digital technology has profoundly transformed the design studio in our time and reshaped academia. Today, *new ways of thinking*, *processes*, *design media* and *knowledge* are emerging, which creates a need to formulate a rationale for digital design pedagogy that can encompass

these changes and support digital thinking (Oxman, 2006). Although computational design is an example of digital thinking that aims to close the gap between architectural design and digital tools (Garber, 2009; Mitchell, 1986), many of computational methods are still viewed as technical skilling that addresses either the conceptual design of architecture (e.g. Rhino and Grasshopper) or the technical aspects of building (e.g. BIM). For BIM, many scholars such as Cheng (2006) started to ask “*what role should BIM have in architectural education and where is its appropriate place in the curriculum?*” and “*how education can establish trajectories for BIM.*” Nevertheless, today, it is still not clear how BIM should be taught to support design thinking (Barison & Santos, 2010; Deamer & Bernstein, 2011; Mandhar & Mandhar, 2013; Marcos, 2017). This ambiguity of teaching BIM particularly in design studios has emerged as a result of: misunderstanding BIM content, separating creativity and BIM, separating BIM and theoretical foundation of design, the level of sophistication of BIM as software, in addition to other reasons that are related to educators and students themselves in digital design pedagogy in general.

First, BIM-related contents in education are limited to three trajectories since it is commonly viewed as a multidisciplinary topic. The first trajectory is *technology-related content*, such as tool capabilities. The second trajectory is *application related content*; this includes visualization, modeling, building performance analysis, and other applications in building systems such as mechanical, and constructions. The last trajectory is collaboration related content such as teamwork skills, communication protocols, and project management (Gu & de Vries, 2012; Kensek, 2012; Marcos, 2017). However, the trajectory of conceptual design and design thinking can be found in BIM (Eastman et al., 2008); nevertheless it is not considered as BIM-related content in education.

Second, neglecting the fourth trajectory of design thinking related content has led many to focus on BIM as an instrument that is separated from design thinking and creativity (Cheng, 2006; Marcos, 2017). Additionally, the techno-centric view on BIM makes many designers believe that implementing BIM is about implementing new software which will lead to a fundamental problem in understanding BIM as software instead of design culture (Holzer, 2011). By extending Josef Albers's distinction between "*factual facts*" and "*actual facts*" into BIM, Cheng (2006) argued that BIM is treated as a factual instrument because it is limited to "*the data that architects incorporate into their digital models—material properties, costs, details, construction techniques.*" However, our goal should be incorporating actual facts in terms of "*the ways to think about that data.*" Using Bloom's revised taxonomy of cognitive skills by Anderson and Krathwohl, Marcos (2017) elaborated more on this argument and expanded it to discuss the relationship between creativity and BIM. Creativity is the highest cognitive skill that should be part of BIM education. Nevertheless, currently, it is quite evident that the first four cognitive skills (remember, understand, apply, and analyze) could be achieved through the use of BIM while "*creativity is probably the only skill which may be neglected by a BIM approach*" (Marcos, 2017).

Third, because of the sophistication of BIM as a software it has been argued that BIM is a professionally-oriented tool, and it is less suitable for the early stages of design (Michalatos, 2016). This assumption is based on the premise that when a software is highly elaborated and specialized, it becomes less suitable for conceptual design. Although the tool can be customized and the level of complexity can be reduced, Michalatos (2016) emphasized that "*(BIM) software enforces the use of a supposedly architectural ontology, based on walls, floors, roofs and windows, and in general categories that seem to ignore the developments in architectural*

*thinking*. Similarly, following Serraino's (2003) argument of 'form follows software,' Parthenios (2005) argues that designs created using BIM tools are usually an assemblage of what is in BIM library. Accordingly, Coates et al. (2010) argue that BIM direct design thoughts towards objects; however, architecture aims also to create spaces determined by objects and design rules. Henceforth, BIM exemplifies the language of building construction while the language of architecture which include forms, concepts, relationships, functions, meanings, and aesthetics is not there yet (Coates et al., 2010). As a result, these assumptions have led some educators to avoid using BIM tools at the stage of conceptual design. For example, M. Ibrahim (2014) focused on teaching the concepts behind the data structure of BIM software and develop a conceptual design without using BIM at that stage.

Fourth, limiting BIM-related content to three trajectories and positioning BIM as professional-oriented created two tracks for design curricula that are nearly parted. These are *form-centric curricula* and *BIM-centric construction and practice curricula* (Cheng, 2006). Accordingly, this has further distanced BIM from the theoretical foundation of designs (Cheng, 2006; Deamer & Bernstein, 2011; Schnabel, 2007). Deamer and Bernstein (2011) argued that the logical place of BIM is in the advanced studios because students are already sophisticated with design fundamentals. However, the fact that the topic of these studios is often determined by the instructor does not guarantee that a BIM studio will be offered or even taken by students (Deamer & Bernstein, 2011). Therefore, they (2011) suggested that placing BIM in the early, core studios makes more sense. However, the fact that "*many pre-BIM design fundamentals that need to be covered — form, composition, spatial hierarchy, etc.*" is still an obstacle. The question remains: is there a room for new trajectory beyond the division of form-centric and BIM-centric construction agendas (Cheng, 2006; Deamer & Bernstein, 2011)?

Finally, some obstacles are related to digital design pedagogy in general. These obstacles include the lack of availability of educators who can teach digital tools such as BIM (Mandhar & Mandhar, 2013). Besides, today, much of architectural education can be seen as “*folk pedagogy*” that is guided by implicit assumptions and not structured according to educational theory beyond one’s experience (Doyle & Senske, 2016). Moreover, the myth of “*digital native*” has created unfounded assumptions in design education. “Digital native” is a term derived from the writings of Prensky (2001) which assumes that the generation of people born since the 1980s has innate confidence in using new digital technologies. However, Dans (2014) argues that: “*being born into the internet age does not endow one with special powers. Learning how to use technology properly requires learning and training, regardless of one’s age.*” Accordingly, beyond the myth of “*digital native*,” architectural educators are positioned to establish pedagogical foundations that take into consideration the needs of students today (Campbell, 2006; Doyle & Senske, 2016).

### **1.3. Research Objectives and Hypotheses**

#### ***1.3.1. Research Objectives***

This research focuses on overcoming the difficulties of using BIM in conceptual design. Taking architectural design pedagogy as the area of exploration, this research explores and constructs a computational design framework that integrates design fundamentals and computational concepts using BIM. To achieve this, the research aims to:

Explore the opportunities latent in digitally-driven design using BIM and how we can embrace it as a way of thinking architecturally rather than merely modeling.

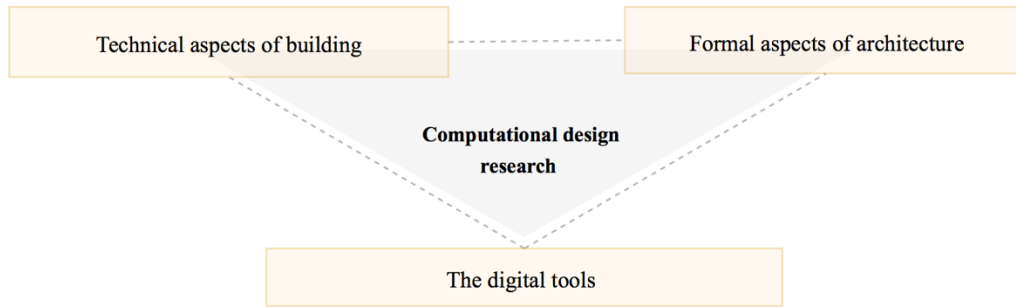
- (i) Develop a new computational framework that uses BIM to aid design thinking. This computational framework offers a formalized theoretical foundation to integrate BIM technology and the design theory of formal language. Additionally, it explores multiple computational methods to offer syntactical tools to support conceptual design in BIM. By doing so, BIM can shift from a library of building vocabulary into an architectural design environment.
- (ii) Develop a pedagogical framework that incorporates the computational framework. Accordingly, the pedagogical framework offers a new agenda that integrates form-centric and BIM-centric agendas.

In this research, the computational design framework that uses BIM to exemplify architectural formal language in terms of building vocabulary and syntactical rules is defined as *Architectural Information Modeling (AIM)* (Al-Assaf & Clayton, 2017).

### ***1.3.2. Hypotheses***

The primary hypothesis of this research is that BIM can be a tool to establish an integrated approach to design education that incorporates the three fields that Mitchell (1986) outlined for computational design: formal aspects of architecture, technical aspects of building, and tools (Figure 1). For this research, BIM would prove to be a valid instrument of investigation because BIM is recognized as an exceptionally strong environment to address the technical aspects of building. Currently, the formal aspects of architecture are not considered BIM related content. However, this research proposes that incorporating *formal knowledge* with *computational concepts* within BIM enables the tool to support the *conceptual design* process. By doing so, the cognitive skills of the designer can be extended to the highest cognitive skill i.e., *creativity*.





**Figure 1 The three components of computational design research in architecture as outlined by Mitchell (1986)**

This research addresses the following primary question: Can BIM aid conceptual design and support the formal aspects of architecture? In other words, can we design using BIM? To answer this primary question, this research relies upon the following secondary questions:

- (i) Can one incorporate the theory of formal language with BIM tool in order to establish a *formalized theoretical foundation* to aid conceptual design?
- (ii) Can one utilize the different computational methods to offer *syntactical tools*, as well as a design vocabulary, to support conceptual design in BIM?
- (iii) Can one establish a digital design pedagogy that uses the formulated computational design framework to integrate design fundamentals and computational concepts into courses on BIM?
- (iv) What learning objectives define the knowledge needed to accomplish the goal for architectural understanding suggested by Mitchell and can be structured by the AIM-based pedagogy?
- (v) Can one measure/evaluate students' understanding of digital tools to aid design thinking?

To answer these questions, this research will develop a *computational framework* that uses BIM to aid conceptual design and a *pedagogical* one to implement and validate the former.

#### **1.4 Limits to Research Scope**

As discussed earlier, this research develops a *computational framework* that uses BIM to support a pedagogical approach to conceptual design education. Conceptual design involves several aspects. The focus here is on developing architectural forms, defining the aesthetics of design, refining building program (i.e., functions), and identifying types of construction. Other aspects, such as economic, environmental, and cultural aspects will not be addressed. Additionally, the formalized theoretical foundation of the computational framework relies on incorporating the theory of formal language. This design theory exemplifies only *one* way of design thinking while other design theories might still be incorporated with BIM tools.

#### **1.5. Research Method**

This research uses a *mixed-methods* approach. Mixed-methods research combines qualitative and quantitative research approaches. The mixed-methods approach in this research is comprised of historical-interpretive research, model-based inquiry, and quasi-experimental research.

Accordingly, multiple sources, type of data, and analysis methods are used.

This research aims to develop and validate a computational framework that uses BIM to aid design thinking and a pedagogical one to implement and validate the former and explore reliability. In that sense, it was conducted in two phases: phase I is the development phase of the study, and phase II is the validation phase of the study.

**Phase I** encompasses developing the *computational design* framework AIM and the *pedagogical framework* to teach it in a design studio. The computational framework utilizes Autodesk Revit Architecture<sup>®</sup> as BIM tool. Using Autodesk Revit as representative of BIM, the families of architectural elements correspond directly to the vocabulary of a language, while the constraints, reference lines, parametric relations, and conceptual masses may be used to define and apply syntactical rules (Clayton, 2014). Autodesk Revit is thus a justifiable and convenient choice for modeling an architectural language. To test the completeness of the computational design framework, the work of Richard Meier was chosen as a *test case*. Richard Meier's work was selected because his architecture has a consistent formal language and a clear set of vocabulary and syntactical principles that can be systematically mapped and explicitly defined (Dahabreh, 2013; Frampton, 1975; Rykwert, 1999).

**Phase II** validates the computational framework (AIM) through a *quasi-experimental* study. This experiment was conducted as a '*longitudinal study*.' In mixed methods research, a longitudinal study is a research design that involves collecting data at multiple time points such as pretest and posttest. It is useful to investigate phenomena that change over time, such as response to multiple interventions, and developmental processes (Plano Clark et al., 2015). Three sophomore design studios (38 students) were selected to conduct the experiment. The experiment has *three* different interventions. After each intervention, students took a survey to detect their progress by identifying variance during the experiment. Lastly, an expert panel was conducted to evaluate the outcomes of the experiment.

## 1.6. The Significance of the Study

This research contributes to computational design research in architecture, building information modeling BIM, and architectural design education. Unlike other computational design methods in architecture, the developed approach does not only address abstract conceptual forms, but it also integrates these forms with the constraints of building construction. Accordingly, designers can generate and qualitatively evaluate a wide variety of forms without neglecting the expressions that a type of construction casts on the geometrical and spatial forms. This integration would also allow streamlining of the information flow in the design process and potential reuse of the information during the lifecycle of the building and across projects. Consequently, AIM can be a catalyst for generating parameterized forms that can be integrated with optimization frameworks such as BPOpt (Asl, Zarrinmehr, Bergin, & Yan, 2015). In that sense, BIM can aid design thinking instead of being merely a professional-oriented tool that facilitates collaboration and building production. In design education, this research offers a third trajectory beyond the separated form-centric and BIM-centric construction agendas. Thus, conceptual design can be a new BIM-related content that integrates design theories and BIM tools in the design studio.

## 1.7. Overview of Chapters

The dissertation is organized into eight chapters that are described below:

- Chapter 1- Introduction: This chapter provides an outline of the study. The research *background*, the research *problem*, the *objectives and hypotheses*, the *limits to research scope*, the research *method*, and the *significance of the study* are discussed.

- Chapter 2- Literature Review: This chapter provides the literature review for the theory of *architectural design*, *the computability of architectural design knowledge*, *Building Information Modeling (BIM)*, and *architectural design education*.
- Chapter 3- Research Method: This chapter provides a rigorous description of the methods used to conduct this research. The employed research techniques and instrument in the development phase of the study and the validation phase of the study are discussed.
- Chapter 4- The Development of The Computational Framework (AIM): This chapter provides a detailed description of the formulated framework AIM and the test case.
- Chapter 5- The Development of The Pedagogical Framework and The Intervention Study: This chapter discusses the development of the *pedagogical framework* of this research in an educational setting, *the intervention study*, and *the expert panel*.
- Chapter 6- Findings: This chapter provides the findings of the data collected during *the intervention study* and *the expert panel*. The findings from the intervention study include the data from the *observation*, the *student survey*, and *the content analysis of the writing assignments*. The findings from the expert panel include the data from *the project assessment survey* and *the discussion sessions*.

- Chapter 7- Analysis and Synthesis: This chapter provides a synthesis of the major findings as related to the literature, the formulated computational framework (AIM), and the pedagogical framework of this study.
- Chapter 8- Conclusions and Future Work: This chapter concludes the research by providing a summary of the significance and main contributions of the research, the limitations, the implications, and recommendations for future research.

## 2. LITERATURE REVIEW

This chapter establishes the theoretical basis of the research. It provides the established body of knowledge on the theory of architecture and design, the computability of architectural design knowledge, Building Information Modeling (BIM), and architectural design education. Concepts and research variables to develop the computational framework (AIM) of this research were obtained from the literature review. The chapter concludes with theoretical and feature specifications for developing AIM.

### 2.1. Theory of Architecture

*‘Nearly everything that encloses space on a scale sufficient for a human being to move in, is a building; the term architecture applies only to buildings designed with a view to aesthetic appeal.’* (Pevsner, 1972, p. xix)

Architecture has always been differentiated from building. In the writings of Leon Battista Alberti (1443-1452), Immanuel Kant (1781), Francesco Algarotti (1784), Friedrich Schelling (1859), Johan Winckelmann (1801), Rudolf Arnheim (1977) and others, architecture is not restricted to practical constraints or the physical and material presence of a structure. Contrary to architecture, building is a mere conversion of practical, functional activity and socioeconomic conditions into physical constructions and is generally based on the idea of usefulness, or the function of the structure (Hendrix, 2012). According to Pevsner (1972, p. 15), “the term architecture applies only to buildings designed with a view to aesthetic appeal.” Architecture adds an artistic value while respecting the building’s functional and practical aspects. Thus, architecture is the *aesthetics* or the *art* of building. In addition to aesthetics,

architecture addresses an intellectual dimension. Therefore, any architectural solution has to be integrated with the *knowledge* that provides a framework for organizing its pragmatic, semantic, formal, and technical aspects (Norberg-Schulz, 1965; Schön, 1985). Equally, Hillier (2007) states that architecture involves theoretical knowledge to support its systematic intent, i.e., *design*; otherwise, it will continue to depend on social knowledge and cultural practices. Therefore, when a building is *designed*, it becomes architecture.

### ***2.1.1. Architectural design***

The word design emerged from the Italian word ‘*disegno*’ which means drawing (Hill, 2005). Etymologically, design as a verb that is derived from the prefix *de-* and the Latin verb *signare*, which means to mark out or sign (Terzidis, 2006). It implies the translation of an idea from the mind into a physical reality such as drawings (Hill, 2005). This activity includes some of the highest cognitive abilities of the human mind, incorporating problem-solving, synthesis, and creativity. It is a complex *nonlinear* process in which one can keep refining a design solution and discovering new ones (Parthenios, 2005). In other words, a designer transforms an ill-structured problem to a well-structured problem by reducing its complexity into sub-problem and adding constraints and goals. The dynamic nature of design, thus, can be understood as a problem-solving task that is in a state of change as the process continues (Leeuwen, 1999). Equally, Terzidis (2006) argues that since the Greek root of design (*σχεδόν*) means nearly or almost, then this activity is about expectations, incompleteness; it is a search for processes and *forms*. According to Terzidis (2006, p. 1), “*design is a conceptual activity of formulating an idea intended to be expressed in a visible form or carried into action.*”



Architectural design is concerned with the *intellectual* process to create an *aesthetically* distinctive architectural *form* or composition. According to Bell (1914), a work of art should possess a “*significant form*” that directs attention to its internal organization as the source of meaning and aesthetic pleasure. This concept was discussed by Langer (1967) as “*logical form*,” or the way thing *structured*. Logical form involves *knowledge about* things, such as the constituted parts as well as the order, or internal connections, between them. In that sense, *form* in architecture is the result of the creative process of design that extends beyond the physical representation of a building.

Moreover, form becomes the primary concept connecting architecture to art and aesthetics. In the Ten Books on Architecture, Alberti discusses that pleasure in architecture originates from its formal organization or *design*, which he describes as a “firm and graceful preordering of lines and angles conceived in the Mind”(Lefaivre & Tzonis, 1984). Alberti also identifies several intangible features that make a building a formal structure, including its “Order, Number, Size, Situation and Form” (Lefaivre & Tzonis, 1984). According to Eisenman (2006), within the design process, any ordering or organization of architectural form can be named a *formal system*. Formal systems offer order to the vocabulary of form.

### ***2.1.2. Formal language***

*“architectural composition may be thought of as a process of forming relations between instances of vocabulary elements. Composition within a particular style involves use not only of a restricted vocabulary, but also of a restricted variety of relations.”* (Mitchell, 1986, p. 150)

The need for a scientific and systematic approach to architectural form has led many theorists and architects to compare architecture to language. Language is a formal system of signs governed by grammatical rules of combination or syntax to communicate meaning. This description was first given by Ferdinand de Saussure between the years 1906 and 1911 in *Course in General Linguistics*. The American Speech-Language-Hearing Association (ASHA) (2013) states that language is composed of rules that include the following: what words mean, how to make new words, how to put words together, and what word combinations are best in what situations. Architecturally speaking, since the process of constructing forms is governed by rules that convey meaning, architecture can function *like* a language. In that sense, formal systems in architectural design can be understood through the notion of *formal language*. Norberg-Schulz (1965, p. 184) defines the formal language of architecture as “*all the elements, relations and structures which form a meaningful system*” employed in such a way that “*forms are given with meanings*.” Knight (1981) has offered a related definition, in which architectural design can be comprehended, compositionally, as a complex of vocabularies led by grammatical spatial relations. According to Barthes (1972), a language can be analyzed or constructed through two operations: dissection and articulation.

First, to **dissect** an object is to find in its vocabularies or elements that form a specific class or *family* with a particular relation of dissimilarity and affinity (Barthes, 1972). In architecture, walls, floors, ceiling, as well as other elements like windows and stairs represent the vocabulary of a building. Moreover, each design vocabulary is considered as a *generic* element that has

specific transformational rules<sup>1</sup>. These transformational rules allow each generic element to produce a virtual *group* of identical yet diverse elements.

Second, the activity of **articulation**, whereby the designer establishes certain rules of combination or *association* for the discrete elements of the composition (Barthes, 1972). There are two types of these rules: *syntax* and *configuration*. Syntax associates the design elements together; therefore, it expresses a relationship *between* elements. For example, the use of a modular system and axes to locate design elements to each other are considered syntactical rules. On the other side, configuration refers to the overall pattern of relations, not just single connections or pairwise, but also with respect to the entire form (Peponis, Zimring, & Choi, 1990). In that sense, syntactical rules are understood as “*subsets or aspects of a configuration*” (Peponis, Karadima, & Bafna, 2003). Accordingly, the activity of *articulation* begins with syntactical rules that create subordinate sets of *syntactical units* that are then configured into an architectural form.

A defined formal language is considered a formal equivalent to the traditional notion of **architectural style** (Knight, 1986, 1995). A formal language or a style is not always fixed. **Stylistic change** has been investigated in design as well as architecture. A style or a formal language can be transformed by changing the vocabulary and *changing design rules* (Ahmad & Chase, 2012; Knight, 1986, 1995). The book *Renaissance and Baroque* (Wölfflin, Ballangé, &

---

<sup>1</sup> Transformational rules are operations that convert one state of an element into another (Mitchell, 1994). According to Mitchell (1994, pp. 109-129), transformational rules can be found geometrically in various forms. First, a *proper isometric transformation*, may involve an element’s change in position (*translation*) and orientation (*rotation*). Second, proper isometric and *reflection* transformations constitute an *isometric* transformation. Third, isometric and *scaling* transformations, as changes in size with preserved proportions, constitute a *similarity* transformation. Fourth, alongside *similarity* transformations, *shear* and *stretch* transformations can be applied, where a shape is distorted but the geometric property of parallelism is preserved, constituting an *affine* transformation. Fifth, *affine* and *perspective* transformations occur where a cross-ratio is preserved, constituting a *linear* transformation. Finally, *stretching* and *twisting* transformations, where the previously discussed transformations preserve the geometric property of connectedness, all one piece, are known as *continuous* transformation.

Teyssèdre, 1967) by the historian Wölfflin is considered one of the earliest examples to discuss the stylistic change in art and architecture. Wölfflin discussed several principles of stylistic change to understand the transformation of Renaissance architecture into Baroque (Mannerist) architecture (Knight, 1995). In *Principles of Architectural History: The Four Phases of Architectural Style* (Frankl, 1968), Wölfflin's ideas of stylistic change were elaborated further by Paul Frankl. Frankl identified four categories of the architectural form: spatial form (composition), corporeal form (mass and surface articulation), visible form (optical appearance), and purposive intention (function). According to Frankl, spatial form or composition usually obtains the most extensive treatment in changing styles or design language. Although the discussion of stylistic change is not new, the research in this area is still limited.

### ***2.1.3. Conceptual design in architecture***

The design process in architecture is complex and many times, ambiguous. Several models were developed to study the stages of design. Geoffrey Broadbent (1969), in his model, states that the creative design process involves the following steps:

- *Briefing*: programming and data collection.
- *Analysis*: breaking the problem into sub-problems, formulation of performance specification (performance can be formal, functional, structural, environmental, etc.), and identification of constraints.
- *Synthesis I*: idea generation and evaluation
- *Synthesis II*: development of complete building
- *Appraisal*: check against performance specification and constraints, then *recycle* as necessary.

- *Communication*: Production of drawings, schedules, specifications, models, etc.

Even though these stages were listed linearly, the design process requires loops and shuttle actions (Geoffrey Broadbent, 1969). The phase of the design process where the designer spends most of his time postulating solutions and reasoning about possible design is called conceptual design. **Conceptual design**, from a methodological point of view, refers to the very early phase of a product development that includes investigation, product idea generation, and some requirement consideration (Horváth, 2000). The term ‘conception’ in epistemology refers to the beginning of a process of existence or forming an idea of something. As a problem-solving methodology, Horváth (2000, p. 4) states that “*conceptual design is exclusively that based on the inherent human capabilities such as intuition, creativity, analysis and synthesis.*” In that sense, according to the design stages of Geoffrey Broadbent (1969), conceptual design phase involves briefing, analysis, synthesis I, synthesis, II, and incomplete appraisal or evaluation since the design is still emerging.

The conceptual design stage provides abstract and incomplete solutions that aim to explore the *best alternatives* (Horváth, 2000). According to Eastman et al. (2008, p. 203), the phase of conceptual design in architecture determines “*the basic framework of the design to be developed in later stages, in terms of its massing, structure, general spatial layout, approach to environmental conditioning, and response to site and other local conditions.*” In that sense, the conceptual design phase is a systemized exploration of applicable concepts that leads to the development of the aesthetics of design, i.e., *form* and other essential functions (Mathew & Barrow, 2004). Therefore, the conceptual design phase is the most challenging yet critical phase of design because it requires high cognitive skills such as abstraction, analysis, synthesis, and

creativity. In this phase, the designer relies heavily on sketches and *diagrams* to simplify the design problem into high levels of abstraction (Clayton et al., 2010; Mathew & Barrow, 2004).

#### **2.1.4. Diagrammatic thought**

Architectural design is an intellectual activity where the architect moves from the abstract/conceptual to the specific/perceptual (Cigolle & Coleman, 1990). In this process, the abstract represents cognitive thinking and logical reasoning of *how* architectural form is structured while the specific refers to the final physical form. To mediate between these two realms and have access to the abstract, the diagram becomes an integral part of the design process (Eisenman, 1999).

The word diagram is derived from the Latin *diagramma* and Greek *diagramma*; it means what is figured, marked, traced symbolized, written or drawn out. It comes from the Greek *dia-* meaning ‘across, out or between-two’ and *gramma* meaning ‘figure, mark or line that is made’ (Gracia, 2010, p. 22). In architecture, the notion of the diagram is historically understood in two ways: as a generative device and as an explanatory or analytical device. Anthony Vidler, in his essay ‘What is a diagram anyway,’ provides an academic analysis to this question that was derived from Peirce’s and Deleuze’s notion of the diagram as an ‘icon of relationships’ that represents the abstract ‘symbolically’ (Gracia, 2010). Baker (1996) states that diagrams are central to the act of design because they enable the designer to understand the essence of a concept and develop design ideas thoroughly. Accordingly, diagrams have the following features that allow them to support conceptual design in architecture.

1. Diagrams “*are selective*” (Baker, 1996, p. 66). They support multiple interpretations (Dulić & Aladžić, 2016).

2. Diagrams are about “*clarity and communication*” (Baker, 1996, p. 66). In collaborative problem solving and design education, conceptual diagrams are a valuable and powerful instrument that communicates central ideas clearly (Dogan & Nersessian, 2002).
3. Diagrams “*reveal the essence,*” therefore, they “*are often simple*”(Baker, 1996, p. 66).
4. Diagrams “*separate out issues so as to comprehend the complex*” (Baker, 1996, p. 66). They allow the designer to identify and concentrate on a distinct characteristic of the design while retaining an overview of the whole. It can provide a connection between the part and the whole in design (Dulić & Aladžić, 2016).
5. Diagrams “*make geometric articulation explicit*” (Baker, 1996, p. 66). They help the architect to think about the relationship between abstract formal concepts and actual architectural space (Do & Gross, 2001). They represent the core of conceptual design and highlight the logic of form through its spatial configuration (Dogan & Nersessian, 2002). Therefore diagrams are central mean for the production of new knowledge through drawing in architecture (Dulić & Aladžić, 2016).
6. Diagrams “*can explain form and space better than words of photograph*” (Baker, 1996, p. 66). Unlike diagrams in other domains, the elements and spatial relationships in architectural diagrams correspond to real physical elements in the building. Their sizes, shapes, and locations are not arbitrary; in contrast, they are drive directly from the physical element or building component they represent (Do & Gross, 2001).
7. Diagrams “*allow a degree of artistic license*” (Baker, 1996, p. 66). They can communicate various ‘*aesthetic issues*’ that are related to the logic of form or the artistic style of the architect (Clayton, 2012).

Although diagrams are fundamental to works of architecture, they often remain hidden, implicit, and even disguised (Eisenman, 1999; Gracia, 2010). Moreover, the existing writings about architectural diagrams do not specifically address the impact of digital technologies on the role of diagrams in architectural design (Gracia, 2010). Accordingly, more research is needed to investigate the interaction between digital tools and conceptual diagrams as a way to express design knowledge in both practice and education (Clayton, 2012, 2014).

## **2.2. The computability of architectural design knowledge**

Design knowledge guides designers in their search for design solutions that will achieve the intended objectives. In manual design processes, the generation of these solutions is guided by *implicit*, complex, and unpredictable knowledge structure by the designer. In contrast, in computational design processes, the generation of potential design solutions is controlled through an *explicit* sequence of logical operations to be executed upon the data structure (Mitchell, 1975). Architectural design, thus, can be viewed as a form of computation that is expressed as an explicit sequence of operations performed on the object being designed (Flemming, 1990). In that sense, the explicit representation of design knowledge has become essential in developing any computational design aid (Carrara et al., 1994). Carrara et al. (1994) suggested that design knowledge can be understood through three distinct, yet related types or modalities:

- **Descriptive knowledge:** It represents the objects and concepts that comprise a particular design as well as their function and how do they perform or behave. It is the knowledge of *what* is being designs.
- **Normative Knowledge:** It represents the goals or intentions that a particular design aims to achieve. It is the knowledge of *why* is it being designed.



- **Operational knowledge:** It represents the methods or strategies to select objects, assign appropriate values to them, and establish relationships that connect all design objects, so they meet the specified goals or design intentions. It is the knowledge of *how* is it being designed.

The explicit definition of design knowledge in any computational aid is very critical because it changes the way that knowledge is captured and disseminated (Mitchell, 1986). Therefore, any attempt to compute design knowledge must be supported with a rigorous theoretical foundation (Kalay, 1990; Oxman & Oxman, 1990). Mitchell (1986, p. 133) asserts that: “*we must establish a demonstrably sound, comprehensive, rigorously formalized theoretical foundation upon which to base practical computer-aided architectural design software-development efforts.*” In that sense, to compute design knowledge, three substantial elements need to be defined first: the design theory, the digital tool, and the role of the designer.

First, a design theory should share certain commonalities with computation theories. Thus, not all design theories can be computed (Kalay, 1990). For instance, some design theories consider designing a vague practice that cannot be rationalized because it depends on ill-defined practices such as intuition, judgment, and creativity. On the other hand, theories such as formal language share many commonalities with computation theories such as defining elements, transformations, and rules or relationship. For instance, *A Pattern Language* (Alexander, 1977) adapts the theory of formal language and demonstrates how design solutions can be created from a series of patterns. Today, this work is credited with inspiring the development of the object-oriented programming languages that are used in most of the current software (Dawes & Ostwald, 2017). Thus, the computability of any design theory should be investigated in terms of

*“which characteristics of computational methods are suitable for design” and “which classes of design process can be computationally aided”* (Kalay, 1990, p. 372).

Second, design theory and a digital tool or software should share similar logic or underlying structure (Akin, 1990). Computer and computer programs are structured according to logic or set of rules that defines how operations may be performed. As a digital tool is used in a design, awareness of its underlying structure or syntax is necessary (Cigolle & Coleman, 1990), because every software system has an ‘ontology’ that connects abstract computational data structures to tangible domain knowledge of a practical task (Clayton, 2014). Computer medium, therefore, is not a simple passive environment. According to Cigolle and Coleman (1990, p. 344), *“the medium of the computer enables a change in process and perception which has the potential to alter spatial or formal understanding of the making of architecture.”* Some scholars go beyond this argument to emphasize that all designs created in a particular software share formal commonalities and they can hardly be separated from the software that created them (Parthenios, 2005; Serriano, 2003). For instance, Serriano (2003, p. 185), in ‘Forms Follows Software,’ states that: *“computer applications externalize in their graphical interface and in their internal logic a set of assumptions about how objects are constructed and space is represented.”* However, this argument depends on the designer’s proficiency with specific software. The less knowledgeable someone is, the more likely he depends on a few favorites or apparent commands (Parthenios, 2005). When a designer is knowledgeable in software, new ways of understanding architecture through the digital tools will emerge (Kvan, Mark, Oxman, & Martens, 2004). According to Michalatos (2016), a better understanding of how digital ontologies are inscribed in architectural software allows us to understand how this software may affect architectural discourse and practice. Moreover, an isomorphism between architectural

design theory and the ontology of a digital design tool can reinforce computing architectural design knowledge (Akin, 1990).

Third, declaring the role of the designer is essential to develop a framework that integrates design knowledge and computational methods. Many early CAD researchers during the sixties and early seventies tried to formulate various computational frameworks that support generative design, such as shape grammar (Oxman & Oxman, 1990). Shape grammar is a recursive method that generates shapes using a set of rules and an initial or primitive shape (Stiny & Gips, 1978). However, according to Kalay (1990), there is a need for computational design research that can create a symbiosis between computers and human designers to enhance the capabilities of each partner. According to Carrara et al. (1994, p. 35), developing an integrative design system that aid computational design but does not fully automate it is based upon:

*“the observation that designers are able to cope with and manage complex design processes, and have for centuries achieved outstanding results doing so without the aid of computers. [Because] it is not necessary to fully automate each and every one of the design process activities in order to significantly improve design productivity and quality. Rather, it is more prudent to develop a practical symbiosis between the capabilities of designers and machines.”*

### ***2.2.1. Computational design systems***

Various computational frameworks and models have been developed to support computing architectural formal knowledge (Carrara et al., 1994; Flemming, 1990; Knight, 1981,

1999; Mitchell, 1986, 1990). Although these frameworks share a set of commonalities, one can distinguish two research approaches.

In the **first** approach, computational framework and models were developed based on heightening the resemblance between computation and architectural formal language (Flemming, 1990; Knight, 1981, 1999; Mitchell, 1986, 1990). The theory of *formal language* was used to establish a theoretical foundation to support computational design. In these frameworks, architectural formal language is exemplified by a set of rules or compositional principles that underlie an architectural form and make it recognizable with a distinct character or style. These rules are defined explicitly and form the grammar or the *syntax* of the language. Additionally, they can control many properties of one element or set of elements which constitute the *vocabulary* of the language (Flemming, 1990). In an important contribution to computing the formal knowledge of architecture, Mitchell (1986) distinguishes two types of computational design systems: '*basic design system*' and "*high-level design system.*"

According to Mitchell (1986), in **basic design system**, the formalization of architectural knowledge starts with defining a rigorous *formal foundation* upon which to base software usage and development efforts. Similar to many other scholars in that era, Mitchell (1986) believes that the theory of formal language can provide a formal foundation to compute design Knowledge. In that sense, a basic design system that relies on formal language as a theoretical foundation comprises of a set *primitives* or vocabulary elements that are structured according to various types of rules or relationships. First, we have rules, such as adjacency, that describe the relationship between the primitives. Second, we need rules that control *parametric variations* and *transformations*. A primitive or design vocabulary can be defined parametrically through one or more variables. The value of each variable can be defined as numeric values, or as a function

of one or more variables. Parametric variations in a structure allow the designer to create several instances from one generic primitive or vocabulary. Third, in addition to parametric variations and transformations, we need *Boolean operations* such as union, intersection, and subtraction. These operations, for instance, would allow the designer to *combine* primitives or structures (i.e., group of primitives) to create new ones. During the eighties and nineties, most of the computational frameworks (Flemming, 1990; Knight, 1981, 1999; Mitchell, 1986, 1990) that were developed to compute design knowledge are examples of basic design systems. These frameworks were developed using CAD systems. According to Mitchell (1986, p. 154), the use of conventional CAD systems to support design in a particular style or formal language is “*vague and ill defined, and may not suffice in the future.*” Therefore, in addition to the features of basic design systems, Mitchell (1986, pp. 158-159) identifies another four characteristics that are needed to develop a **high-level design system**.

- First, “*a high-level system must efficiently store and support fast and convenient editing of designs within some particular formally specified architectural language. The formal specification encodes detailed knowledge of how to put a building together in that particular style.*” According to Mitchell (1986), relying on abstract primitives such as rectangles to define a formal language is not enough. The architectonic elements of architecture or building elements, such as walls, floors, columns, and their relationships need to be defined in the design system.
- Second, “*the system must support decomposition of designs in appropriate ways.*” At the most fundamental level, decomposition refers to break down design or system into fundamental sub-systems. It is about the relationship between part and whole. However, designers have various ways to interpret this relationship. A high-level system, thus, should

allow architects “*to think about designs as hierarchies of elements and subsystems*” (Mitchell, 1986, p. 157).

- Third, “*the system must incorporate a rich variety of interpretation algorithms.*” These algorithms can encode various types of knowledge, such as structural, environmental, construction, cost, materials, as well as the symbolism of architectural forms. It is a way to formalize the semantics of architectural languages and how they can be interpreted.
- Fourth, “*the system must have at its disposal search procedures that can be used to generate designs or partial designs that have specified interpretations.*” These procedures encode knowledge of how to achieve and discover design solutions within a language or a particular architectural style.

The **second** approach, to compute architectural design knowledge, focuses on defining building objects through *object-oriented representation method* (Carrara et al., 1994; Eastman, 1994; Watanabe, 1994). While the first approach considers design as a matter of searching for architectural forms within an appropriate formal language (Mitchell, 1986), this approach considers design as a ‘*goal-directed search process*’ (Carrara et al., 1994, p. 2). It focuses on defining an object or environment that can achieve some “desired behavioral and spatial characteristic” or goals (Carrara et al., 1994, p. 2). In that sense, architectural design is understood as a *hierarchical structure* of sub-structures or design solutions. These design solutions are *semantically rich parametric objects* that have specific behavioral and, physical and non-physical characteristic, such as geometry, function, material, color. These objects range from furniture and building components to entire buildings. Instances can be generated from a generic object through assigning particular values as dimensions. In this framework, architects can create a *hierarchical structure* that is composed of the best solutions or objects to achieve the desired

goals. The designer can form design solutions or objects according to various types of structures. For instance, in the KAAD system (Knowledge-based Assistant for Architectural Design), Carrara et al. (1994) identify three types of structures: *topological*, *geometrical*, and *functional* structures. Topological structures help establish spatial and technological relationships between objects. Geometrical structures not only help to represent objects properties such as dimensions but also they help to relate these properties together. Functional structures help establish *performances* that represent design goals. In that sense, systems like KAAD perceive design as a ‘*physical form*’ that is composed of semantically rich *building* objects arranged in *hierarchical structures* (Carrara et al., 1994, p. 17).

In comparison to Mitchell’s (1986) high-level design system, the second approach of *object-oriented* systems addresses many features that are needed to create high-level design systems. These features include *hierarchical structures* and *semantically rich objects* that encode various types of knowledge. However, *object-oriented* systems like KAAD fails to provide a rationale to integrate *formal structures* which are essential not only in high-level design systems but also in basic design systems. Those object-oriented systems focus on coding the functional knowledge of buildings and does not address the formal knowledge of architecture.

Both approaches can be integrated to guide new developments in computing design knowledge and developing high-level design systems. At this point, we may argue that encoding *design knowledge* in *object-oriented systems* can potentially support efficient high-level design systems. However, there is a need to establish rigorously formalized theoretical foundation to support such systems. This formalized theoretical foundation should provide a rationale to code formal structures that are composed of semantically rich *physical* objects and *abstract* objects. Furthermore, to explicitly represent design knowledge in any high-level design system, the three

modalities of design knowledge: *descriptive knowledge*, *normative knowledge*, and *operational knowledge* need to be addressed too.

### **2.2.2. Analysis, Synthesis, and options Generation (A-S-G)**

Any attempt to compute design knowledge and formal systems in architecture typically involve three main exercises in formal composition: the *analysis* of existing formal system or language, *synthesis*, and the *generation* of multiple design options.

First, *analysis* aims to discover the primary organizational factors that operate in a building to reveal its underlying logic (Baker, 1996). Formal analysis uncovers fundamental aspects of form such as the *generic* design element or vocabulary, mass systems, geometrical systems, proportional relationship, circulation pattern, and location of main axes (Eisenman, 2006). This process aims to look at the generic form that is composed of the grammars, the vocabulary, and the rules governing the distortion of vocabulary, i.e., transformational rules (Eisenman, 2006). The analysis of existing formal systems is considered essential to compute design knowledge (Oxman & Oxman, 1990). This approach to knowledge is called Case-Based Reasoning CBR. It is based upon modeling experiential knowledge and inferring from previous solutions that can be adapted to current situations (Oxman & Oxman, 1994). The analytical study of the Palladian grammar by Stiny and Mitchell (1978) is considered one earliest study in shape grammars to analyze and compute formal languages.

Second, *synthesis* focuses on the *operational knowledge* of design. It aims to computationally describe a formal system or language. In that sense, synthesis refers to the strategies to explicitly define vocabulary, assign appropriate values to them, and establish relationships or grammars between them to form a connected whole that efficiently exhibits the



required behavior (Cagan, Campbell, Finger, & Tomiyama, 2005). This process also involves declaring constraints and defining design goals (Cagan et al., 2005). According to Gross (1985), constraints are the rules, requirements, conventions, relations, and principles that define the context of designing. A constraint can be a variable, a fixed value, or even a formula. Constraints delineate a region of alternative solutions or variants. The boundaries of this region fluctuate as the designer adds, changes, or remove constraints (Gross, 1985).

Third, *options generation* aims to create a set of design alternatives that satisfy certain design goals. This stage explores the range of possibilities in the space of alternative solutions. Thus, a candidate option is generated using what has been defined in the stage of synthesis (Cagan et al., 2005). The generation process may explore creating design options that have one formal language or several languages. For instance, the three-dimensional shape grammars for Frank Lloyd Wright architecture by Koning and Eizenberg (1981) investigates computing an existing formal language and generating new designs that have the same language. Generating design options through transforming design languages or *stylistic change* was investigated in fields such as architecture (Ahmad & Chase, 2012; Colakoglu, 2005; Flemming, 1990; Knight, 1986, 1995) and industrial and engineering design (Chase & Liew, 2001; Li, Schmidt, He, Li, & Qian, 2004). Knight (1986), in '*Transformations of languages of design*', formulated a formal model for defining transformations of languages of designs. According to Knight (1995, p.xv), "*transformations are formally defined operations that specify how the components of grammars are modified to form new grammars, and from them, new styles – or languages – of designs.*" In that sense, the proposed formal model focused heavily on transforming design rules through three operations: *rule deletion*, *rule addition*, and *rule change*. Rule deletion removes rules from a grammar, rule addition adds rules to a grammar, and rule change changes the rules of grammar

by changing the constructive mechanisms underlying rules. Knight (1986, 1995) used her formal model to analyze the relationship between two architectural styles of Frank Lloyd Wright. First, the shape grammar for Wright's Prairie houses was established, then grammatical transformations were applied to systematically transform the Prairie grammar into a grammar for Wright's Usonian houses. In addition to changing design rules, changing design vocabularies can also produce stylistic change. For instance, replacing mass by planes can transform a mass architectural style into a panel or layered architectural style (Flemming, 1990). However, this change occurs only on the level of *surface structure* or the perceptual form, and it has less effect in comparison to the change that affects syntax or design rules.

Using computer to generate design options allows the architect to advance his design ability by offering the opportunity to explore more sophisticated options. Moreover, the fact that generating design options can be done so fast allows the designer to decode quantity or speed into quality. Furthermore, comparing various design options provides a clear picture of the real nature of the design problem because each option generates more data that can be used to explore the design problem further (Parthenios, 2005).

### ***2.2.3. Representation***

Knowledge used in the conceptual design stage can take diverse forms, such as descriptive knowledge, normative knowledge, and operational knowledge. The computational *representation* of design knowledge has been a challenging question facing researchers and designers (Clayton, 2014; Kalay et al., 1990; Oxman & Oxman, 1990). At a most basic level, computing design systems can support conceptual design when they have a *representational system* that illustrates knowledge about design elements, and knowledge about the relationships

between them (Kalay et al., 1990). To aid conceptual design, further characteristics of representational systems have been discussed as follows:

- The representation of the *semantics of design* is essential to model the rationale of design (Clayton, 2014; Kalay et al., 1990; Leeuwen, 1999). This involves representing content in terms of function, properties, the behavior of elements of design as well as other aspects of form (Leeuwen, 1999).
- Moreover, the representation of design at *multiple levels of abstraction* allows designers to compute design knowledge at various design stages (Cigolle & Coleman, 1990; Do & Gross, 2001; Johnson & Vermillion, 2016; Logan, 1989). Because of the richness and complexity of the design process, the designer should be able to control the level of abstractions that is needed at each design stage (Logan, 1989). Besides, the more a design problem can be stated in abstract terms, the more readily it can be manipulated within the computer. Therefore, a representational system that can support multiple levels of abstraction of form can also support *diagrammatic thinking* (Cigolle & Coleman, 1990; Do & Gross, 2001; Ulusoy, 1999). In that sense, in the early conceptual design stage, digital diagrams allow the designer to explore formal ideas, develop design solutions, and express related design knowledge. For instance, in Autodesk Revit, digital diagrams can express geometry, design rules such as proportions, and other associative semantics of the design (Clayton, 2014).
- Lastly, representational systems should be dynamic systems that allow freedom and flexibility while maintaining precision and advancements. Because any digital tool for conceptual design needs to have the right balance between productivity

and freedom that will allow diversity and promote creativity (Parthenios, 2005). Thus, a designer needs to control the level of complexity and freedom of a digital tool. At the early stages of design, the tool needs to be loose enough to allow ease of expression and flexibility of attempts. However, as the designer gradually develop a design idea, the tool needs to be still precise and specific to allow refinement of design (Parthenios, 2005), and maintain relationships among elements as the design is developed or transformed (Do & Gross, 2001).

### **2.3. Building Information Modeling BIM**

Building Information Modeling BIM is an example of an *object-based* parametric modeling system that is commonly used today in architectural design and construction industries. According to the U.S. National BIM Standard (2007), BIM is “*a digital representation of physical and functional characteristics of a facility and a shared knowledge resource for information about a facility forming a reliable basis for decisions during its life-cycle*” (p.149). On the other hand, the term ‘BIM’ describes the activity of connecting the building’s elements as objects embedded with information (Smith & Tardif, 2009). According to Eastman et al. (2008), BIM can be defined as the activity of modeling building information. It is an innovative way to design, fabricate, analyze, construct, and manage (Eastman et al., 2008).

BIM, as an *object-based* parametric modeling system, represents objects by rules and parameters to govern the geometry as well as some nongeometric properties. The way an object updates its geometry and materials as its parameters or its context change is called *behavior*. BIM systems provide a predefined set of object classes or families such as wall, column, slab, stair, beam and roof systems, and each has possibly different behaviors that are programmed

within. They are available as *generic* objects and as *specific* companies' products. Besides the parametric rules that control how objects behave, BIM also provides a set of *relations* that control how elements are related to each other. These relations may reference what can be connected or the parts of aggregation as well as other parameters, including distance, angles, and rules such as *attached to*, *parallel to* and *offset from* (Eastman et al., 2008).

### ***2.3.1. Benefits of BIM***

The benefits of using BIM span all phases of design: pre-construction stage, construction stage, and post-construction stage:

In the pre-construction stage, BIM can be used to develop designs, assist with feasibility studies, conduct early performance analysis, and create a time-based simulation of construction activities. Moreover, BIM can facilitate the early collaboration of multiple design disciplines and visualize designs. In terms of precision, BIM can tremendously reduce errors in construction drawings, provide early insight to design errors, and improve information delivery (Mandhar & Mandhar, 2013).

In the *construction stage*, BIM can be used to synchronize design and construction to reveal potential problems, detect clashes, reduce errors in construction drawings, facilitate collaboration between contractors and designers. Furthermore, BIM can be used to manufacture building components and assembly building components and systems such as structural systems. In site, BIM can save cost, time, and waste and enhance productivity (Mandhar & Mandhar, 2013).

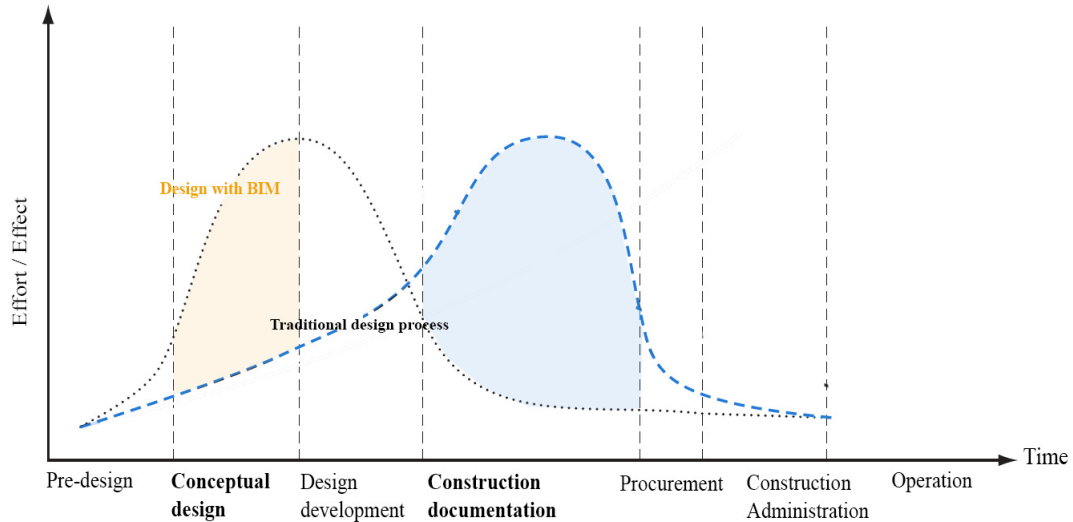
In the post-construction stage, BIM can be used to manage and operate facilities after completion. Moreover, BIM provides a streamlined approach where data is shared in a

collaborative approach. Therefore, BIM is efficient in information management and exchange and can tremendously reduce information loss when handing over a project from the design team to the construction team to the owner. Besides, BIM can control whole-life costs and environment data of a facility (Mandhar & Mandhar, 2013).

### ***2.3.2. BIM and conceptual design***

Today, BIM is considered an epochal shift in design practice. By automating construction drawings and partially automate construction detailing, BIM can reallocate the effort and time to place more emphasis on conceptual design (Eastman et al., 2008) (Figure 2).

Design in BIM, according to Eastman et al. (2008), is considered from three viewpoints. The first viewpoint is the common use of BIM in developing construction-level information. This viewpoint includes integrating construction modeling and detailing in design early design stages, creating standardized construction documentation, and speeding up the whole process while maintaining quality. The second viewpoint addresses BIM for analysis which covers many functional aspects of a building's performance such as structural performance, lighting, temperature control, ventilation, acoustics, pedestrian circulation, and energy distribution and consumption. The third viewpoint is *conceptual design* which determines “*the basic framework of the design to be developed in later stages, in terms of its massing, structure, general spatial layout, approach to environmental conditioning, and response to site and other local conditions*” (Eastman et al., 2008, p. 203). This phase typically involves the development of the aesthetics of the design by using sketches and diagrams (Mathew & Barrow, 2004). It is considered the most creative part of the design activity.



**Figure 2 Using BIM to reallocate the effort and time spent in the construction documentation phase to place more emphasis on the conceptual design phase, adopted from (Eastman et al., 2008).**

Today, the role of BIM in design is mostly limited to the first two viewpoints, which represents the technical aspects of building. Although it has been argued that BIM can be used to aid conceptual design (Ambrose, 2009; Clayton, 2014; Eastman et al., 2008; Marcos, 2017), many researchers and designers disagree with this argument. For instance, in a survey about the benefits of BIM to around 100 AEC researchers and professionals, reducing time came as the highest benefit of BIM while creativity came last (Yan & Demian, 2008). In another survey about the role of digital tools to support conceptual design to 241 senior architects who use computers, using Autodesk Revit (BIM tool) in early design stages came with 0% preference (Parthenios, 2005). Several barriers exist to make designers and researchers believe that BIM cannot aid design thinking and support conceptual design.

First, the phase of conceptual design is the most difficult to integrate digital design tools (Mathew & Barrow, 2004). Hand methods of sketching and physical modeling remain attractive

at this stage, while unstructured computer graphics tools are a medium that accommodates implicit knowledge and implied design decisions. Second, many researchers and designers still view computational methods as technical skilling that addresses either the conceptual design of architecture or the technical aspects of building, such as BIM (Ambrose, 2009). According to Holzer (2011), the techno-centric view of BIM leads many designers to believe that implementing BIM is about implementing new software. Therefore, BIM is understood as software instead of design culture. Third, because of the sophistication of BIM as software, it has been argued that BIM is a professionally-oriented tool, and it is less suitable for the early stages of design (Michalatos, 2016). This assumption depends on the premise that when the software is highly elaborated and specialized, it becomes less suitable for conceptual design. Fourth, in terms of creativity and form diversity, it has been argued that BIM hinders design creativity because it superimposes a supposedly architectural ontology based on a predefined library of building components such as walls, roofs, floors, and windows (Michalatos, 2016). Following Serraino's (2003) argument of 'form follows software,' Parthenios (2005) argues that designs created using BIM tools are usually an assemblage of what is in the BIM library. Fifth, BIM directs design thoughts towards objects; however, architecture also aims to create spaces determined by objects and design rules (Coates et al., 2010). In that sense, Coates et al. (2010) argue that BIM exemplifies the language of building construction while the language of architecture which include forms, concepts, relationships, functions, meanings, and aesthetics is not there yet.

Several recommendations have been made to overcome the previously mentioned barriers and to accommodate the ambiguity and complexity of conceptual design in BIM tools. These recommendations include:



1. Integrate *design rules*, *constraint modeling* and *diagrammatic thought* in BIM (Clayton, 2012, 2014), and provide broader range models and *abstractions* to aid the creative process (Coates et al., 2010).
2. Overcome the sophistication of BIM tools through using *divide and conquer strategy*. Accordingly, design solutions can be decomposed into parts or individual partial solutions that can be assembled to create a design alternative (Akin, 2015).
3. Align BIM tools with the architectural thought process (Coates et al., 2010) and architectural *theory* (Clayton, 2014).
4. Understand the *ontology* and the data structures of BIM tools as a knowledge system and align it with similar architectural treatises (Apollonio, Gaiani, & Sun, 2012; Clayton, 2014).
5. Encode design *semantics* to express more intangible, abstract, implicit, and theoretical design information (Apollonio et al., 2012; Clayton, 2014; Pauwels et al., 2009a, 2009b).

### **2.3.3. BIM to AIM**

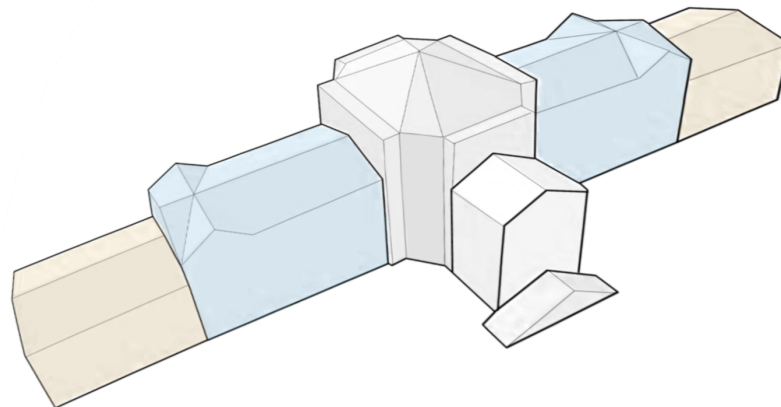
BIM has been perceived as a tool to express the language of building construction. However, using BIM to express the language of architecture and aid design thinking is one of the most challenging tasks. According to Akin (2015), although BIM appears to be the appropriate choice for addressing all the issues of design delivery process (i.e., design, construction, and facility management), we cannot deal with BIM tools with our tacit and intuitive cognitive skills alone because “there is nothing intuitive about these tools and their interface functions that are supposed to connect our mental models to the internal functions of the computer code by which they are governed” (Akin, 2015, p. 17). In that sense, research into *cognitive modeling* and developing systems to intermarry digital models of BIM with cognitive models of designers is

one of the most challenging and rarely addressed topics (Akin, 2015). Several researchers have recommended that the concept of *Architectural Information Modeling* (AIM) should be developed to express the language of architecture and aid design thinking (Briscoe, 2015; Pauwels et al., 2008; Pauwels et al., 2009a, 2009b).

In BIM<sup>2</sup>, the concept of *Architectural Information Modeling* (AIM) was first introduced by Pauwels et al. (2008). Pauwels et al. (2008) proposed a framework called AIM that can encode abstract and conceptual architectural information such as typology, taxonomy, and theory. This framework is used to describe the theoretical and historical knowledge of architecture. The Casino, at Ghent, Belgium, is a historical building that was modeled using this framework (Pauwels et al., 2008). Figure 3 illustrates the abstract spatial structure of the building, which represents the core structure of the AIM model. Moreover, other historical and functional information was embedded in the model. This framework was only used to model, document, and archive the international cultural heritage (Pauwels et al., 2008; Pauwels et al., 2009a, 2009b). According to Pauwels et al. (2008), this research needs to be explored further. It can be extended to investigate different architects and other architectural information (Pauwels et al., 2008). In that sense, the concept of *Architectural Information Modeling* AIM should be explored as a framework that supports conceptual design and aids design thinking (Briscoe, 2015). As a result, BIM can serve as a primary tool for design innovation in which professional architects, designers, researchers, as well as students and faculties of architecture schools engage in information related formal design processes (Briscoe, 2015).

---

<sup>2</sup> The term of Architectural Information Modeling (AIM) was first introduced by Leeuwen (1999) in his research in the field of information systems. This term was not developed in relation to BIM tools and it does not address the activity of design. According to Leeuwen (1999), his framework utilized Feature Based Modeling (FBM) to model architectural design information. It encodes a collection of information with semantic meaning to the designer at any level of abstraction, either physical or non-physical.



**Figure 3 Architectural Information Model shows the spatial structure and the conceptual elements at the Casino, at Ghent, Belgium. Adopted from (Pauwels et al., 2008).**

## **2.4. Architectural design education**

### ***2.4.1. Architectural education***

Design education or pedagogy is about the engagement in the “*creative synthesis of ideas*” that provides entry to professional practice and is different from commercial courses or self-training design programs (Tovey, 2015). A unique aspect of architecture education is the “studio culture” of architecture (Ockman, 2012). Much of the instruction is conducted using project-based learning with close, individualized supervision of student work by the instructor. Typically, the architectural curriculum is centered on design studio with more than fifty percent of the course load (Salama, 1995).

The earliest formal architecture education started in École des Beaux Arts of the late-nineteenth century. The studio model of Beaux Arts was founded with a design master or tutor, often an accomplished architect, and the design learner or student. In this model, students gained knowledge of historical styles and drawing that prepared them for sketch problems known as

'*Esquisse*' (McPeck, 2009; Salama, 2005; Simon, 2012). In the 1920s, the Bauhaus educational model emerged in Germany, by Walter Gropius, as a reaction to Beaux Arts and its imitation of the works of the past. One of the main impacts of the Bauhaus to North American design pedagogy was the course in basic design called *Design Fundamentals* by Gropius in 1950. The course consisted of a series of two and three-dimensional exercises to investigate form, space, and perception (Ockman, 2012). In the 1960s, architectural design was significantly studied in a scholarly way as a result of *Formalism* and *Design Method Movement* (Celani, 2012). Influenced by the works of formalists, such as Roger Fry, Clive Bell, and Clement Greenberg, a group known as "Texas Rangers" at the University of Texas in Austin included Colin Rowe, John Hejduk, Bernhard Hoesli, and Robert Slutzky, and formulated a pedagogy that focuses on questioning the formal nature of architectural design. Later, their formal ideas disseminated to other schools such as Cornell, Syracuse, Cooper Union, and, indirectly, Princeton (Ockman, 2012). The *Whites*, a group consisting of Peter Eisenman, Michael Graves, Charles Gwathmey, John Hejduk, and Richard Meier, were part of this formalist movement in architectural design education (Anay, 2012). Their works exemplified a theory where architecture and *language* are seen as following shared rules that govern the relations between formal elements to construct meaning (Deamer, 2001). In addition to the linguistic analogy, the development of formalism in architectural education was also influenced by developments in the fields of computer technology, operational research, and artificial intelligence (Celani, 2012). This influence has produced pedagogies that aim to understand the process of design and externalize that process (Celani, 2012).

#### ***2.4.2. Formalism in architectural education***

Teaching formal language in architecture is concerned with how architectural design can be understood, compositionally, as a complex of vocabularies governed by grammatical spatial relations or rules (Knight, 1981). In the literature review, besides formal language, several terms were used to convey this approach, such as *formal studies*, *formalism*, *composition*, *basic design* or *design fundamentals*, *rule-based design*, *type* and typological studies, *pattern language*, and *morphology* (Oxman & Oxman, 1989). The various pedagogical practices of teaching formal language may relate to one or more of these areas: *design fundamental*, *morphological analysis and typology* and *computational studies*.

##### ***2.4.2.1. Teaching formalism through Design Fundamentals***

Formalist pedagogy is an extension of the course in basic design that was first established at the Bauhaus. It focuses on teaching composition in architectural design through defining the elements of architecture and the principles of ordering. The elements of architecture include point, line, plane, mass, etc. The principles of ordering include axis, symmetry, hierarchy, rhythm/repetition, datum, transformation, etc. Publications like *Architecture, Form, Space & Order* by Francis Ching (1996) are still frequently used as a reference (Deamer, 2005). The exercise of ‘nine-square grid’ that was given out by Cooper Union in the 1960s, which asks students to locate predetermined elements on a grid, is still used today in design education (Deamer, 2005). From the 1960s until now, the attempts to teach formal language remain the same: students learn about design elements and rules through reading first, then they design. The description of the formal language and the process of creating forms in those designs are not

explicitly defined because they rely upon verbal explanations rather than parameters, rules, or equations of a computational system.

#### 2.4.2.2. *Teaching formalism through morphological analysis and typological studies*

Morphological analysis is defined as the study of the principles and structures that govern architectural form. Both *relational* and *constructive morphology* can be used to reveal the underlying logic of form. Relational morphology focuses on the organizational principles that govern the overall form, while constructive morphology places emphasis on the form-making process: an exploration of how a building is diachronically created (Steadman, 2008). *Type* refers to the “process of reducing a complex formal variant to a common root form” (Argan, 1963, p. 243). Steadman and March’s (1971) study of Frank Lloyd Wright’s houses represents an example of investigating the notion of type in architecture.

Today, in design education, *morphological* studies are taught as advanced seminar courses (usually for graduate students). Peter Eisenman is considered a pioneer in teaching design morphology in architecture. Currently, he teaches a course called “Diagrammatic analysis” at Yale University. In this course, students use “formal analysis as a method to understand architectural form. In addition, students were asked to articulate the Russian Formalist Viktor Shkolovsky’s idea of estrangement in order to expand their vocabulary. In design education, today, there are several practices that use ‘A Pattern Language’ and typological studies to teach architectural design. For instance, ‘A Pattern Language’ was used to teach beginning design studios at Kabul University by generating a single-family house from a list of patterns (Azizi, 2011).

#### *2.4.2.3. Teaching formalism through computational design*

Architectural design can be viewed as a form of computation that is expressed as an explicit sequence of operations performed on the object being designed. *Shape grammar* has been used to teach formal language in architecture (Knight, 1999). In shape grammar, a formal language can be generated through a predefined *sequence* of operations that are executed to modify an initial shape. Various studies have been conducted in design education to teach formal language through shape grammar (Chase & Koh, 2000; Economou, 2000; M. S. Ibrahim, Bridges, Chase, Bayoumi, & Taha; Knight, 1999; Pupo, Pinheiro, Mendes, Kowaltowski, & Celani, 2007). However, for architects, and especially for students, it is difficult to use shape grammar to conceptualize a design because design is a complex process that cannot be a defined sequence of actions (Theodoropoulou, 2007), and there are too many conflicting acts occurring simultaneously, defying simple or linear description (Habraken, Gross, 1988). Therefore, in shape grammar, many of the generated forms are simple stacked rectangular prisms. Flemming (1990, p. 47) suggested that to achieve more freedom and variations in design, the software that can be used to capture a formal language (design rules and vocabulary) must be robust and easy to learn. It also should “*allow rules to be defined interactively and graphically.*” Moreover, the standard set of operations provided by the modeler should include higher-level operations (e. g. alignment), picking and pointing, as well as *parameters* to create dimensional variations.

#### ***2.4.3. BIM in design education***

Digital technology has profoundly transformed the design studio in our time and reshaped academia. *New ways of thinking, processes, design media and knowledge* are emerging, which creates a need to formulate a rationale for digital design pedagogy that can encompass these

changes and support digital thinking (Oxman, 2006). Equally, BIM has profoundly changed the nature of architectural design and the patterns of education (Ambrose, 2009; Clayton et al., 2010).

In architectural education, BIM teaching can be incorporated in the design studios as part of the studio projects and must be supported by a variety of knowledge resources (Ambrose, 2009; Christenson, 2008; Mandhar & Mandhar, 2013). Nevertheless, most researches in this field focus on the collaborative and multidisciplinary properties of BIM (A. A. Becerik-Gerber, Burcin, Ku, & Jazizadeh, 2012; Denzer & Hedges, 2008; Shafiq, Matthews, & Lockley, 2012), or on the technological aspect of production, evoking students to ask questions about structures, energy consumption, detailing and material assemblies (B. Becerik-Gerber, Gerber, & Ku, 2011; Harty & Laing, 2010). Nevertheless, today, it is still not clear how BIM should be taught to support design thinking (Barison & Santos, 2010; Deamer & Bernstein, 2011; Mandhar & Mandhar, 2013; Marcos, 2017). Many scholars such as Cheng (2006, p. 2) started to ask “*what role should BIM have in architectural education and where is its appropriate place in the curriculum?*” and “*how education can establish trajectories for BIM.*”

Today, there are three established trajectories to teach BIM-related content in education. The first trajectory is *technology-related content*, such as tool capabilities. The second trajectory is *application related content*; this includes visualization, modeling, building performance analysis, and other applications in building systems such as mechanical, constructions, etc. The third trajectory is collaboration related content such as teamwork skills, communication protocols, and project management (Gu & de Vries, 2012; Kensek, 2012; Marcos, 2017). Although Eastman et al. (2008) stated that BIM could also have a trajectory of conceptual design, this trajectory is not yet considered as BIM-related content in education.



Because teaching BIM-related content is limited to the three trajectories of *technology*, *application*, and *collaboration*, design curricula are established around two tracks that are nearly parted. These are *form-centric curricula* and *BIM-centric construction and practice curricula* (Cheng, 2006). Accordingly, this has further distanced BIM from the theoretical foundation of designs (Cheng, 2006; Deamer & Bernstein, 2011; Schnabel, 2007). Moreover, it has led many to focus on BIM as an instrument that is separated from design thinking and *creativity* (Cheng, 2006; Marcos, 2017). As a result, BIM has become an instrument that is limited to the data that is incorporated into the digital models— construction techniques, material properties, details, cost (Cheng, 2006).

Henceforth, incorporating BIM in design studio has become a problematic issue because BIM is viewed as a professionally-oriented tool that it is separated from design thinking and *creativity*, and less suitable for early design stages (Michalatos, 2016). For instance, M. Ibrahim (2014) focused on teaching the concepts behind the data structure of BIM software and develop a conceptual design without using BIM at that stage. On the other hand, Deamer and Bernstein (2011) argued that the logical place of BIM is in the advanced studios because students are already sophisticated with design fundamentals. However, the fact that the topic of these studios is often determined by the instructor does not guarantee that a BIM studio will be offered or even taken by students (Deamer & Bernstein, 2011). Therefore, Deamer and Bernstein (2011, p. 2) suggested that placing BIM in the early, core studios makes more sense. However, the fact that “*many pre-BIM design fundamentals that need to be covered — form, composition, spatial hierarchy, etc.*” is still an obstacle. According to Marcos (2017), further research is needed today to incorporate BIM in the design studio and address conceptual design as a BIM-related content. Any attempt in this area should address the relationship between BIM and *creativity* (Marcos,

2017). According to Marcos (2017), this relationship can be understood through Bloom’s revised taxonomy of cognitive skills by Anderson and Krathwohl. Bloom’s revised taxonomy has two axes: the cognitive process dimension and the knowledge dimension (Table 1). Creativity is recognized as the highest cognitive skill. It should be taken into account in BIM education. Nevertheless, currently, it is quite evident that the first four cognitive skills (remember, understand, apply, and analyze) could be achieved through the use of BIM while “*creativity is probably the only skill which may be neglected by a BIM approach*” (Marcos, 2017).

**Table 1 Bloom's revised taxonomy of cognitive skills**

	concrete thinking			abstract thinking
	<b>factual</b> what you need to know to do the task	<b>conceptual</b> ideas, theories principles	<b>procedural</b> the skills and techniques of doing things	<b>metacognitive</b> self-awareness, using experiences, cognition
<b>remember</b> (recognize, remember, recall)	list	recognize	recall	identify
<b>understand</b> (illustrate, explain, compare)	summarize	classify	clarify	predict
<b>apply</b> (carry out, use, implement)	respond	provide	carry out	use
<b>analyze</b> (select, discover, deconstruct)	select	differentiate	integrate	deconstruct
<b>evaluate</b> (check, decide, test)	check	determine	judge	reflect
<b>create</b> (design, construct, generate)	generate	assemble	design	<b>create</b>

## 2.5. Summary

The literature review presented in this chapter illustrates the theoretical basis of this research. In brief, the literature focuses upon four areas that are critical to support this research intent and develop the computational framework.

The first area focuses on **architectural theory and design**. A building becomes an *architecture* when it is designed. The notion of *design* refers to the conceptual activity to form ideas that can be expressed in a visible form. This activity can be understood as the process of establishing a *formal language*. The discovery or definition of a language involves two operations: *dissection* and *articulation*. A style or a formal language is not always fixed. A *stylistic change* can be achieved by changing the vocabulary and changing design rules. The early design stages that provide abstract and incomplete design solutions to explore the best alternatives are usually called the *conceptual design* phase. This phase represents the main focus of this research. This phase is considered the most difficult, yet critical phase of design because it requires *high cognitive skills* such as *abstraction*, *analysis*, *synthesis*, and *creativity*. Because design is an activity whereby the designer begins with the abstract and moves to the concrete, *diagrams* that focus on the abstract play an integral part in the design process. Diagrams are usually selective, clear, simple, and reveal the essence of design. Additionally, diagrams make the underlying logic of design explicit, communicate aesthetic issues, and allow a degree of artistic license.

The second area of the literature focuses upon the **computability of architectural knowledge**. There are three distinct yet related design knowledge that can be computed: descriptive knowledge, normative knowledge, and operational knowledge. However, to compute architectural knowledge, there are three substantial elements need to be defined: a design theory

that shares certain commonalities with computation theories, a digital tool that shares similar logic or underlying structure with the design theory, and the role of the designer. There are various models of computational design systems. The literature shows that an effective computational design system needs to have the following:

- A rigorous *formal foundation* upon which to base software usage and development efforts (e.g., formal language).
- *Semantically rich parametric objects*: This includes two sets. The first set is *primitives* or vocabulary elements that can be structured according to various types of rules or relationships. The second set is architectonic elements of architecture or building elements, such as walls, floors, columns, and their relationships need to be defined in the design system.
- Rules that can control *parametric variations* and *transformations*.
- *Boolean operations* that allow the designer to *combine* primitives to create new ones.
- A system that supports *decomposition* in which architectural design is understood as a *hierarchical structure* of sub-structures or design solutions.
- A system that incorporates a rich variety of interpretation algorithms.

The process of computing architectural design knowledge typically involves the three main exercises in formal composition: the *analysis* of existing formal system or language, *synthesis*, and the *generation* of multiple design options. Lastly, the computational *representation* of design knowledge should represent the *semantics of design*, represent the design at *multiple levels of abstraction*, and have a *dynamic* representational system that allows freedom and flexibility while maintaining precision and advancements.

The third area of the literature focuses on **Building Information Modeling (BIM)**. The benefits of using BIM covers the three phases of design: pre-construction stage, construction stage, and post-construction stage. However, utilizing BIM tools during the conceptual design process is not an easy task. Several researchers suggest that the ambiguity and complexity of conceptual design in BIM tools can be overcome through:

- Integrate *design rules*, *constraint modeling*, and *diagrammatic thought* in BIM.
- Overcome the sophistication of BIM tools through using *divide and conquer strategy*.
- Align BIM tools with the architectural thought process and theory.
- Understand the *ontology* and the data structures of BIM tools as a knowledge system and align it with similar architectural treatises.
- Encode design *semantics* to express more intangible, abstract, implicit, and theoretical design information.

In that sense, there is a need for a shift from BIM as a tool to express the language of building construction to *Architectural Information Modeling AIM* as a way to express the language of architecture and aid design thinking.

The fourth area of the literature focuses on **architectural design education**. Formalism or formal language in architecture has been taught through *design fundamentals*, *morphological analysis* and *typological studies*, and *computational design* using shape grammar. Using BIM to teach formal knowledge in architectural design is very limited because the focus has been on the collaborative and multidisciplinary properties of BIM, or on the technological aspect of production. Nevertheless, devising means to employ BIM in the early stages of architectural education to teach formal knowledge of architecture is likely to have value by providing greater

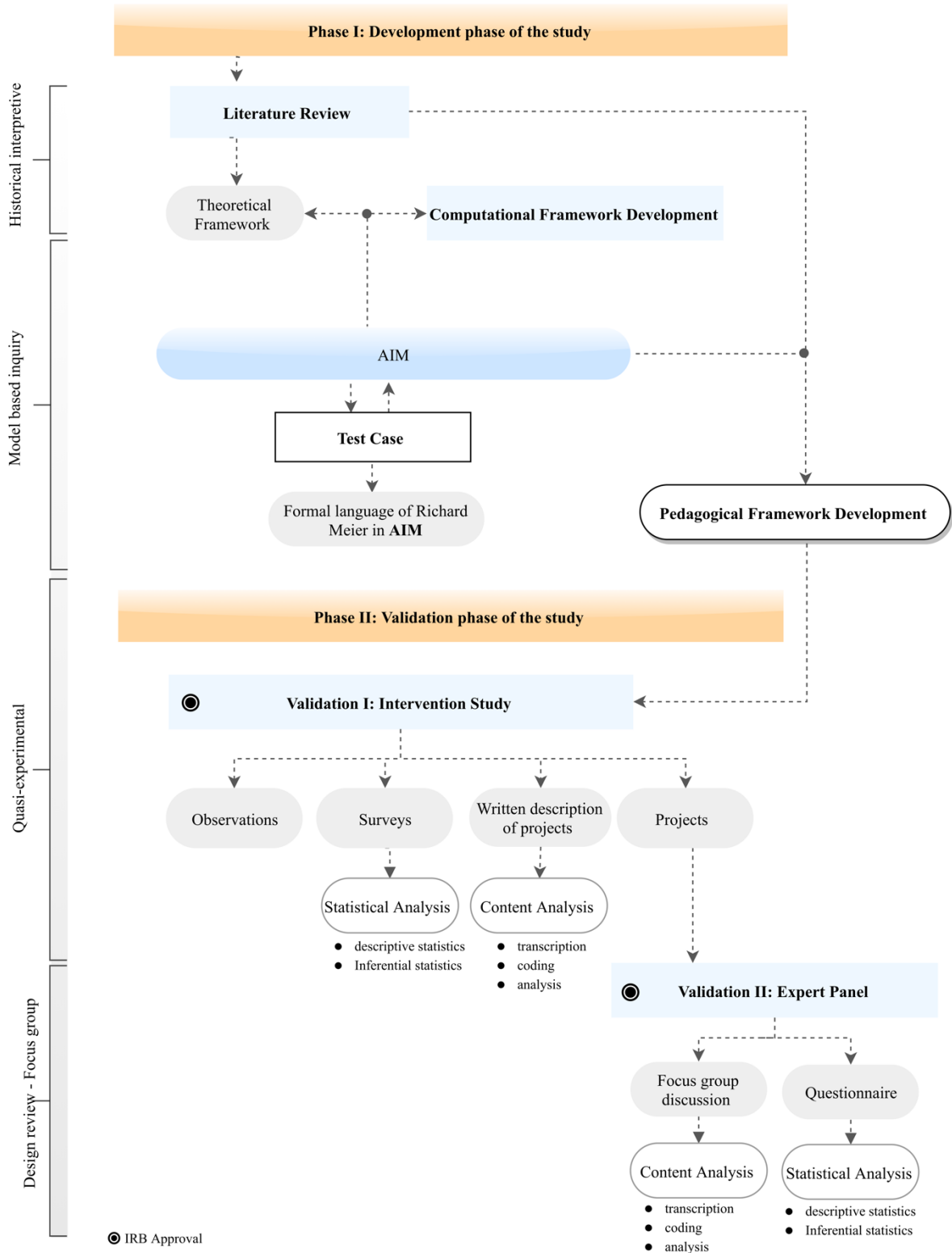
continuity and leveraging learning from early stages of education to later stages, and more comprehensive content by the end of the educational program.

### 3. RESEARCH METHOD

This chapter demonstrates the methodological approaches and considerations that were employed to test the hypotheses of this research. The research utilized a mixed-methods approach that is comprised of *historical-interpretive research*, *model-based inquiry*, and *quasi-experimental research*. This research developed and validated a computational framework, called AIM, that facilitates the use of BIM to support conceptual design. Moreover, this research formulated a pedagogical framework to implement and validate the AIM system. To address these two major themes, the research depended on two main phases: *phase I* is the development phase of the study, and *phase II* is the validation phase of the study. Phase I involved the development of the theoretical framework, the computational framework, as well as the pedagogical framework. Phase II utilized a quasi-experimental research method to conduct an intervention study that implements the AIM system in second-year design studios at Texas A&M University. The projects created in these studios were evaluated and discussed by an expert panel. Figure 4 shows the structure of the two main phases of the research method. The discussion of these two phases is followed by a discussion of the validity and reliability of the research results, and the limitations of the research.

#### **3.1. Phase I: Development phase of the study**

The development phase of the study consists of three parts. The first part is the development of the theoretical framework through a literature review. The second part is the development of the AIM computational framework using BIM. The third part is the development of the pedagogical framework to teach AIM at the design studio.



**Figure 4 The structure of the research method**



### ***3.1.1. Literature review***

Critical literature review, in this research, is used to develop the theoretical framework. This stage utilizes *historical-interpretive research* methods. According to Groat and Wang (2013), historical-interpretive research aims to access evidence from the past because the influence of the past realities on present conditions is difficult to isolate. It involves epistemological points of view that are used to interpret the past. Tactically, it entails data identification, data organization, and data analysis. In that sense, the resources for the literature review were books, key journals, and conferences on architecture, design computing, design education, and BIM. All references were organized, managed, and cited using Endnote. The literature review is organized by topic into the following sections:

1. **Architecture and building:** This section provides a general outline of *architectural design* and other fundamental concepts in design: *formal language*, *conceptual design*, and *diagrammatic thought*.

2. **Computability of architectural knowledge:** This section narrows down the discussion to architectural design and computation. It discusses *computational design systems*, and common characteristics such as *analysis*, *synthesis*, and options *generation* framework as well as systems of *representation*.

3. **Building Information Modeling BIM:** This section addresses the *benefits of BIM*, *BIM*, and *conceptual design*, and *BIM to AIM*.

4. **Architectural design education:** This section by providing an overview of *teaching design*, *teaching formalism*, then *teaching BIM*. Finally, the discussion highlights the limitations of using BIM to support conceptual design in design education.

These four sections are critically organized to contextualize the research hypotheses. The literature was analyzed according to the following criteria: What is architectural design? How can we compute design knowledge? What are the characteristics of design systems? Also, how can BIM be a design system that can compute design knowledge? These criteria provided the theoretical framework of this research and helped to formulate the AIM system.

### ***3.1.2. Computational framework development***

This stage involves developing a computational design framework that uses BIM to support conceptual design. To develop the computational design framework, there are three integrated stages.

**Select a design theory:** First stage is developing a *formalized theoretical foundation* that facilitates the use of BIM in the conceptual design stage. In the literature review, the established theoretical framework represents the base of the theoretical foundation of this research.

**Select a BIM tool:** The computational framework uses *Autodesk Revit Architecture*<sup>®</sup> as BIM tool. The selection of Autodesk Revit relies on several criteria. First, there is a similarity between the ontology and data structure of Autodesk Revit and the theory of formal language, and this research highlights that similarity. Second, for this research, the selected tool should support computational design. Autodesk Revit can support computational design by using parameters, enforcing constraints, and employing programming methods, such as text-based programming (API) and visual programming (Dynamo). Revit can also boost robust conceptual design through expressing ideas in architectural ontology, regulating lines, diagrammatic reasoning, and architectural typology (Clayton, 2012, 2014). Third, Autodesk Revit, today, is a powerful 4D building information modeling tool that can address all aspects of a project from

design to construction and beyond. Furthermore, it has a robust development platform and massive demand in the market, which will increase the impact of this research. Autodesk Revit, also, is widely supported by tutorials and courses that provide a proper resource for this research. Finally, the use of multiple software platforms may have its advantages such as overcoming the shortcomings of a single software. However, a single software platform can save the user many hassles such as cost, incompatibility between multiple platforms, data loss for data-type conversion, and learning multiple software and programming methods. In that sense, this research uses a single software platform: Autodesk Revit.

**Select a test case:** To integrate the first and second stages together and test the completeness of the computational design framework, this research takes the work of *Richard Meier* as a test case. Meier's work was selected for three reasons. First, his architecture has a consistent formal language and a clear set of vocabulary and syntactical principles that can be systematically mapped and explicitly defined (Frampton, 1975; Rykwert, 1999). Second, revealing an existing language or generating new languages from the original one is typically achieved by analyzing one or more expressions of that language (Flemming, 1990; Knight, 1981, 1999). In that sense, the *generative* power of BIM is explored using *analytical* knowledge. Third, Revit contains a predefined set of abstract or generic elements and syntactical rules such as alignment and modularity that also exist in Meier's formal language. Accordingly, selecting Richard Meier's architecture as a test case means selecting a case that is more accessible to students because it will not require them to acquire advanced knowledge in Autodesk Revit from the early beginning.

**Develop computational framework:** The integrated outcome of the previous three stages exemplifies a computational design framework that allows designers to use BIM to

support conceptual design. In this research, this framework is called *Architectural Information Modeling* (AIM).

### ***3.1.3. Pedagogical framework development***

This stage involves formulating a pedagogical framework that fielded AIM in the architectural design studio and validates its effectiveness to support conceptual design. A pedagogical framework is a loose structure consisting of: *pedagogical philosophy* (how we think students learn, what knowledge consists of, etc.), *high level pedagogy* (general approaches such as problem-based learning, collaborative knowledge building, etc.), *pedagogical strategy*, and *pedagogical tactics* (the detailed methods used to set educational tasks for students) (Goodyear, 1999). Any pedagogical framework needs to be understood in connection to an educational setting or a *learning environment* in the real world. In that sense, various types of data of *learning tasks* and *activity* need to be collected to provide feedback for future developments. Moreover, flexibility and looseness are crucial in the early stages of framework development (Goodyear, 1999, 2005). Therefore, developing *assessment* strategies to collect data from students and assess their progress is vital to overcome any deficiency in the framework and deal with unexpected circumstances (Garrison, Chandler, & Ehringhaus, 2009).

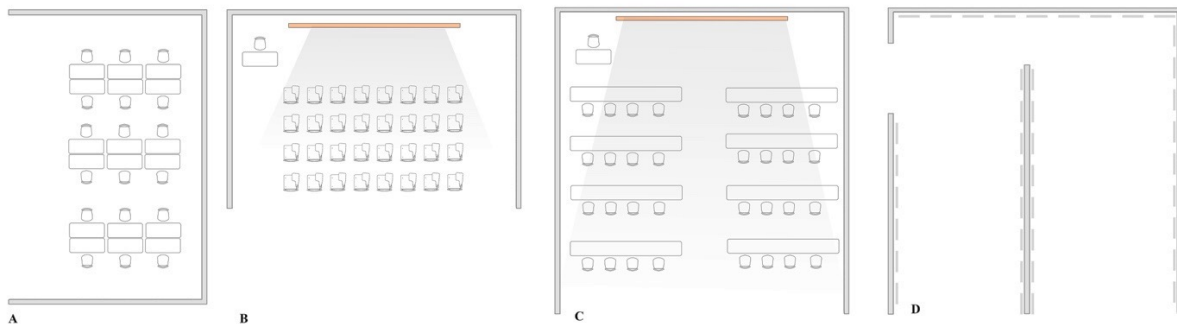
#### ***3.1.3.1. Learning environment***

A learning environment includes all the *tools* and *resources* that are needed to reach the goals of a particular pedagogical framework. It can be a physical or digital environment (Goodyear, 2005). The following are the tools and resources used to implement AIM in a design studio and collect data from that studio:

**Digital tools and software:** Autodesk Revit Architecture<sup>®</sup>, Enscape<sup>®</sup> (real-time rendering and virtual reality for Revit), Qualtrics<sup>®</sup> (online survey platform), Google Drive<sup>®</sup> (online file storage service for communication and collaboration), YouTube<sup>®</sup> (video sharing website) and personal laptop computers for each student.

**Learning spaces:** Figure 5 illustrates the four types of learning spaces that this research employed: design studio, lecture space, computer lab, and exhibition and review space.

**Library and digital database access:** Online tutorials by Autodesk<sup>®</sup>, Revit tutorial from YouTube<sup>®</sup>, new tutorials for AIM shared with students through YouTube<sup>®</sup>, and support reading materials from TAMU library.



**Figure 5 Learning spaces. A: Design studio, B: Lecture space, C: Computer lab, D: Exhibition, and review space**

### *3.1.3.2. Learning tasks and learning activity.*

Learning tasks and learning activities are documented by collecting the following data of the *learning outcomes* to provide insight to assess the performance of the pedagogical framework of this research:

**Learning tasks:** a learning task is a specific learning outcome, such as essays and artifacts (Goodyear, 2005). In this study, the learning tasks are the *projects* created by students as well as the *written criticism* of each project.

**Learning activity:** a learning activity refers to how people respond to a learning task when typically constrained by other tasks, their knowledge, as well as the other calls on their time (Goodyear, 2005). In that sense, this research uses *observations* and *surveys* to collect data about students learning activity.

#### 3.1.3.3. Assessments

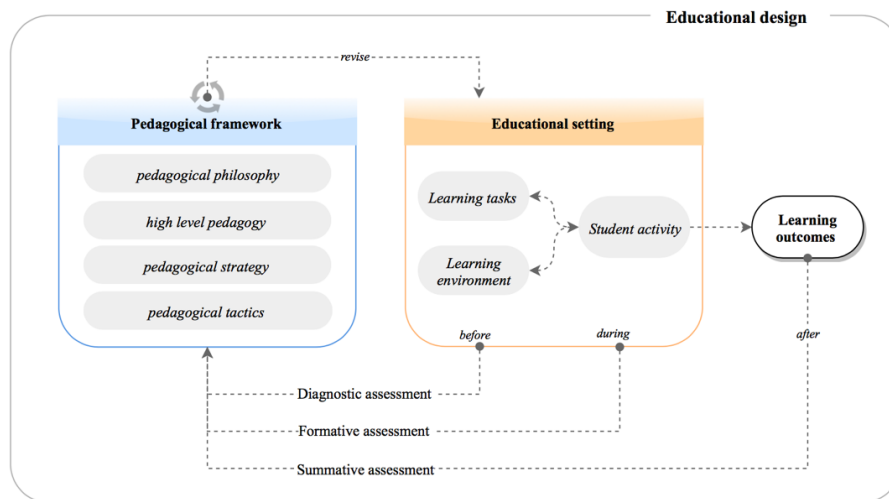
Assessment is the process in which instructors gather data about students' learning through various techniques such as pre-tests, observations, and examinations (Hanna & Dettmer, 2004). The three types of assessments that this research employed are:

**Diagnostic assessment:** This type of assessment takes place *before* teaching starts. It aims to identify students' current knowledge of a subject as well as their skills and capabilities (Hanna & Dettmer, 2004). This research conducted a diagnostic assessment through a *discussion* with students on their first day to identify their current knowledge of computation and digital design tools.

**Formative assessment:** This type of assessment takes place *during* the teaching process. It provides feedback on students' progress and instructor progress to identify areas that need improvements. These assessments usually are informal (Hanna & Dettmer, 2004). This research conducted a formative assessment through *observations* during in-studio activities, a *one-on-one discussion* between instructor and student, and *informal pin-up reviews*. As a result, in the second half of the semester, some changes were made to accommodate students' progress.

**Summative assessment:** This type of assessment takes place *after* the teaching process has been completed. It is more product-oriented and focuses on the completion of projects and assignments (Hanna & Dettmer, 2004). This research conducted a summative assessment through evaluating the learning outcomes: students’ projects and written description of each project. Students’ projects were evaluated by a panel of experts, and the written descriptions were evaluated through content analysis. Grades are usually used as summative assessment; however, in this research, grades were not used as summative assessment because this information is protected by the Family Educational Rights Act (FERPA).

Lastly, a real pedagogical framework cannot be developed in isolation from educational settings. The process of developing a pedagogical framework through applying it to an educational setting and collecting data to assess that pedagogical framework is called ‘*educational design*’ (Goodyear, 1999, 2005). Figure 6 illustrates the problem space of educational design research. According to Goodyear (2005), educational design differentiates design for specific educational application from the general consideration of learning.



**Figure 6** The problem space of ‘*educational design,*’ adopted from (Goodyear, 1999).

### **3.2. Phase II: Validation phase of the study**

Phase II is a *quasi-experimental* study that implements and validates the computational framework (AIM) using the pedagogical one.

#### ***3.2.1. Validation I: An intervention study***

In education research, a quasi-experiment is an *intervention study* used to study the impact of an educational intervention. Researchers in education frequently utilize this type of research for three reasons: it is a practical method that meets the requirements of funding and school administrators, it evaluates the effectiveness of educational interventions, and it allows researchers to construct validity (Cook, Campbell, & Shadish, 2002). This research conducts the intervention study as a '*longitudinal study*.' In mixed methods research, a longitudinal study is a research design that involves collecting data at multiple time points such as pretest and posttest. It is useful to investigate phenomena that change over time, such as response to multiple interventions and developmental processes (Plano Clark et al., 2015). A longitudinal study can combine quantitative and qualitative data, and it has the potential for collecting rich data that trace changes over time with accuracy (Cohen, Manion, & Morrison, 2002). In that sense, this intervention study investigates the impact of implementing AIM framework and validates its usefulness to support conceptual design.

##### ***3.2.1.1. Population and sampling***

The population for the study was second-year students enrolled in design studios at schools in the USA above the age of eighteen. In the intervention study, the research used a *convenience sampling* method. In convenience sampling methods, participants are selected for



the study if they meet specific practical criteria such as easy accessibility, availability at a certain time, or the willingness to participate (Farrokhi & Mahmoudi-Hamidabad, 2012). The sample was drawn from *ARCH 205 Architecture Design I* course at TAMU. ARCH 205 is a four-credit studio for second-year students (sophomore). In the course description of ARCH 205, this course emphasizes functional planning, spatial ordering, the logic of form generation, and modeling techniques. Therefore, it was selected because it focuses on teaching students how to develop conceptual designs through understanding the logic of form and using digital tools. Moreover, most students of ARCH 205 have no previous knowledge in digital tools and especially none in Revit. Therefore, they did not yet develop a preference for a digital tool or a preference for architectural style.

In the fall semester of 2018, second-year students were randomly assigned to six design studios. Each studio had about 16 students. Three design studios were selected to take part in this research. The three studios had 48 students in total. Two students did not agree to take part in the study, and six students withdrew from participation. In that sense, the sample size of this research is *forty* students. According to Cohen et al. (2002), in design education research, a sample size of thirty is held by many researchers to be the minimum number of participants to conduct statistical analysis.

In addition to students as participants, a *second instructor* participated in the study. The author of this dissertation, the *first instructor*, and the *second instructor* taught the three design studios of ARCH 205. The role of each instructor is explained in chapter five.

### 3.2.1.2. Subject recruitment

Recruitment of students involved visiting the design studios and presenting the research design. The recruitment presentations were followed by distribution of consent forms. Students had the choice whether or not to be in the study, and they could stop participating at any time. The script for recruitment can be found at appendix I.

The second researcher, as well as the other instructors of ARCH 205, were contacted by email and in-person with information about the study. Only the second researcher agreed to collaborate, and his name was added to the Institutional Review Board IRB protocol.

### 3.2.1.3. Data collection and analysis

**Projects:** Architectural design projects were the first learning outcome of this intervention study. There are three interventions in this study. In the *first intervention*, students designed a *house* by using Revit without the AIM framework. This task exemplifies the *pretest* of this study, which sets the baseline before conducting any intervention and helps to measure students' learning when it is compared to the final *posttest*. In the *second intervention*, students learned to work with the AIM framework. First, students used AIM to *analyze* and *model* the formal language of an existing house designed by Richard Meier. Then, students *generated* multiple design options using the same formal language of Richard Meier. In the *third intervention*, students *transformed* the formal language of Richard Meier to create multiple design options that have a new formal language. The data collected after the last two interventions represent the first and second posttests. Students uploaded their projects to a Google Team Drive. A panel of experts analyzed and assessed these projects.

**Written description of projects:** Each student submitted three essays that describe the design logic and the formal language of the projects they created at each intervention. Students uploaded these essays to the Google Team Drive. The essays were analyzed using *conceptual content analysis*. Content analysis is a research technique that makes replicable and valid inferences from written communicative materials (Cohen et al., 2002). Conceptual content analysis involves analyzing text quantitatively through establishing the existence and frequency of concepts (Carley, 1990). The process of analysis comprises of breaking down a text into *units of analysis*, undertaking statistical analysis of the units, and presenting the analysis results. The unit of analysis can be a single word or a phrase or it can be a concept where multiple words or phrases are nested within another (Cohen et al., 2002). Online textual analysis tools such as (<http://textalyser.net/> ) , (<https://www.online-utility.org/text/analyzer.jsp>), and Excel were used to conduct the conceptual content analysis.

**Survey:** After each intervention, students took a survey (appendix II). This survey was first tested through a pilot study before releasing it to students. The survey uses *5 point Likert Scale* to capture students' *perception* of their learning experiences. Qualtrics, an online survey software, was used to administrate the survey to students, and collect and store the data. All three surveys have the same format to identify variance in students' perception in five areas. The first area focuses on students' understanding of design and formal language. The second area addresses students' understanding of diagrammatic thinking. The third area focuses on the role of the BIM tool in design. The fourth area investigates students' ability to generate multiple design options that have a consistent formal expression. The last area examines students' level of *self-efficacy*. Self-efficacy is "defined as the belief in one's capabilities to carry out, organize and perform a task successfully" (Ersanlı, 2015, p. 472). Self-efficacy is selected as a fifth area to explore in the survey

because it is an effective method to assess student learning and academic achievement in architectural design studios (Luhan, 2016). The collected data were analyzed using descriptive analysis such as mean, median, mode, standard deviation, and frequency graphs. Moreover, *One-Way Repeated Measures ANOVA*, also known as within-subjects ANOVA, was used to conduct inferential statistical analysis. One-Way Repeated Measures ANOVA determines variance and compares the performance of the *same group* of participants under different conditions in an experiment. Missing data caused by non-response were handled using *Common-Point Imputation method*. This method replaces missing data with the most common value. It is more accurate and structured than Listwise Deletion, Educated Guessing, or Average Imputation methods (Schlomer, Bauman, & Card, 2010).

**Observations:** The *first researcher* used *semi-structured observation* to gather ‘live’ data from the studio during the intervention study. The semi-structured observation involves collecting data about the time of the day of the observation, the learning space, interaction between instructor and students, and learning activity (Cohen et al., 2002). In this study, the observation focused on the design process, the design quality of projects, the use of BIM tool, the use of AIM framework. The data were collected through ongoing notes in studio, notes made at the end of each intervention, and data from the debriefing session with the other researchers.

#### *3.2.1.4. Ethical consideration*

The intervention study was conducted in an established and commonly accepted educational setting. The IRB at TAMU approved this study on August 15, 2018 (TAMU IRB#2018-0557) (appendix III). It involved normal education practices that investigated new instructional strategies. In this study, there were no known risks or discomforts to participants

beyond those experienced in the normal setting of the course. In addition, there were no exclusion criteria based on gender, culture, language, economics, race, or ethnicity.

After the first researcher presented the study to students, each student completed a consent form (appendix IV). The consent forms were collected by a third party (a student worker). The forms were kept at a locked cabinet at the office of the Associate Department Head for Research. The researcher gained access to the consent forms and analyzed only the work products of students who had permitted use of their data in the study. Data was analyzed only after the class grades had been submitted. Moreover, the first researcher could access the results of the surveys of all three classes at the end of the semester, and only after they were *de-identified* by a student worker. In this process, students were assured that their participation, or lack thereof, had no impact on their grade or their relationship with the instructor.

### ***3.2.2. Validation II: Expert panel***

The expert panel is a type of focus group research method. A focus group aims to collect data through group interaction on a particular topic stated by the researcher (Lewthwaite & Nind, 2016) According to Chioncel, Veen, Wildemeersch, and Jarvis (2003), there are two types of focus groups: *lay groups* and *expert panels*. Lay groups are typically used as a data-gathering method. However, the participants of an expert panel are professionals in a specific field of study. An expert panel can be used not only to gather data but also to engage experts in scientific research. The collaborative nature of expert panels allows participants to contribute to the research by providing solutions, producing scientific knowledge, and developing policy action knowledge (Chioncel et al., 2003). In this research, the expert panel was used to analyze and

assess the projects created by students during the intervention study. The researcher conducted the expert panel on April 1<sup>st</sup> and 2<sup>nd</sup>, 2019 at Langford Architecture Building at TAMU.

### *3.2.2.1. Population and sampling*

The population for the panel was academics in the USA who have experience in teaching architectural design studio. In the expert panel, the research used a *purposive sampling* method. In purposive sampling method, participants are selected for the study if they have the information the researcher needs. This sampling method is also known as expert sampling because it is popular in expert panels (Lewthwaite & Nind, 2016). In this expert panel, the participant was required to be an expert in one or more of the following areas: BIM, design and digital tools, and design theory. Moreover, to avoid any bias, only participants who did not know the researcher were selected.

In the spring semester of 2019, three professors participated in the expert panel:

1- Awilda Rodriguez, associate professor at Oklahoma State University. Professor Rodriguez's areas of expertise that are related to this research include BIM, Computer-Aided Design, and Digital Technologies.

2- Vincent Canizaro, associate professor at the University of Texas at San Antonio. Professor Canizaro's areas of expertise that are related to this research include architectural design, design media and the generation of design knowledge, mixed-design media practices, and design theory.

3- Ward Wells, professor at Texas A&M University. Professor Wells' areas of expertise that are related to this research include architectural design and design theory.

Due to budget and time limitations, the expert panel was a small focus group that consisted of three participants. Small focus groups are easier to recruit, host, and moderate. Because each participant has more time to talk, small focus groups are more useful when the researcher needs more depth and complexity in responses (Morgan, 1996).

#### *3.2.2.2. Subject recruitment*

Recruitment of experts involved sending IRB approved recruitment material to participants by email. The invitation was sent to six potential participants. Four participants agreed to participate in the study. Participants had the choice whether or not to be in the study, and they could stop participating at any time. One participant had to withdraw from the study for personal reasons. The script of the recruitment material can be found at Appendix V.

#### *3.2.2.3. Data collection and analysis*

The data collected from this expert panel are quantitative and qualitative data. The quantitative data were collected from a survey. The experts used the survey to evaluate the projects created by students in the three interventions. The qualitative data were collected from two discussion sessions with the experts.

**Project Assessment Survey:** Students' projects were evaluated using a survey. The survey uses *5 point Likert Scale* to rate the projects according to three features. The first feature is formal qualities. The term formal qualities in this survey refers to the *aesthetics* of architectural form and the quality of spatial experience. The second feature is the consistency of the formal language. The third feature is the relevance to Meier's formal language. All projects were displayed in the review space (figure 5, D). The experts used the survey to review the

projects. The survey was administrated through printed booklets. Each project has a page with three questions and a space for taking notes. The review of projects was done as a *blind jury review* in which all projects were de-identified, and students' names were replaced by coded entry. Moreover, to focus on architectural quality in assessing designs and eliminate the differences among students in graphic ability, all projects had a *unified template* with the *same graphic styles and layout*.

**Expert panel discussion:** In this expert panel, there were two discussion sessions. The first session was after reviewing the projects created at the first two interventions. The second session was after reviewing the projects created at the third intervention. The discussion was carried out as semi-structured interviews. The questions and agenda for the discussion were developed according to the research questions and hypotheses. All discussion sessions were videotaped, transcribed, and coded for *thematic content analysis*. Thematic content analysis is used to analyze data qualitatively. It goes beyond merely counting words or phrases and moves on to examine themes and identify ideas within the data (Vaismoradi, Turunen, & Bondas, 2013).

#### 3.2.2.4. *Ethical consideration*

The participation in this panel was voluntary. During the panel discussion, no personal or private information was discussed or recorded. Only the discussion of students' projects and architectural design was documented. Therefore, the records of this study are not kept private. The experts' names are used in connection with tapes, transcripts, and publications resulting from this focus group. The IRB at TAMU approved this panel on August 15, 2018 (TAMU IRB#2018-0557) (appendix III). Each expert completed a consent form and gave their permission for videotaping and for using their names (Appendix VI). Risk level was assessed to



be no more than anyone would come across in everyday life. Moreover, the identity of students was concealed, and all projects were de-identified.

### 3.3. Reliability and Validity

Reliability refers to the stability and the consistency of results, while validity refers to the accuracy of results through eliminating extraneous factors (Golafshani, 2003). Establishing reliability and validity increases *credibility*, allows *replicability* over time, reduces opportunities to have a bias, and eliminates confounding variables. This research, thus, employed the following strategies to achieve adequate reliability and validity:

- **Thinking theoretically** can ensure both reliability and validity. It “requires macro-micro perspectives, inching forward without making cognitive leaps, constantly checking and rechecking, and building a solid foundation” (Morse, Barrett, Mayan, Olson, & Spiers, 2002, p. 18). In that sense, the literature review, as well as the theoretical framework in this research help establishing rigor and comprehensiveness.

- **Triangulation** refers to the process of combining several kinds of methods and data (Golafshani, 2003). This research utilized a mixed-methods approach that is comprised of historical-interpretive research, model-based inquiry, and quasi-experimental research. Besides, multiple types of qualitative and quantitative data were collected.

- **Sampling strategies** can enhance the validity and reliability of research by eliminating the influence of various confounding variables (Ewert & Sibthorp, 2009). In the intervention study, the sample was drawn from *ARCH 205 Architecture Design I* course at TAMU. First, all second-year students were *randomly* assigned to six design studios, and then three studios were selected to participate in the study. Also, there were no selection criteria based on gender, culture,

language, economics, race, or ethnicity. In that sense, all students in the study share the same circumstances in terms of *course specifics* (e.g., course length, course activities), and *situational impacts* (e.g., learning environment, educational program, curriculum). Accordingly, the *concomitant variables* that may arise during an experiential education experience were eliminated (Ewert & Sibthorp, 2009). Moreover, a sample size of *forty* students is considered a valid sample size to conduct statistical analysis (Cohen et al., 2002). In the expert panel, biased participants were avoided. Only participants who are *strangers* and have the required area of expertise were selected.

- **Voluntary participation** refers to participant's exercise of free will in deciding whether to participate in a research activity or not. The participation of both students and experts was voluntary in this research. Students were given the opportunities to refuse to participate without affecting their grades too. This tactic allows the researcher to ensure honesty because data can be collected only from participants who are genuinely willing to participate and willing to offer data freely, absent coercion or reward (Shenton, 2004).

- **Privacy and confidentiality** are essential to maintain the validity and reliability of research. In this research, no personal data were collected. Consent forms were collected by a third party. The researcher was able to access the consent forms and the results of the survey after they were *de-identified* only at the end of the study. This approach allows the researcher to ensure honesty and avoid *social desirability bias*. Social desirability is a confounding variable where participants tend to respond to a questionnaire acceptably or desirably regardless of their actual feelings. Because participants are often concerned with maintaining a positive image, they may attempt to answer questions correctly or in conformance with expectations (Ewert & Sibthorp, 2009).

- **Review projects objectively and focus only on architectural quality** can enhance the validity of this research. In reviewing architectural projects, a review method of employing a holistic attitude to the judgment of projects may misattribute student's design abilities because students skillful in graphic design can bias reviewers who may assign better grades while overlooking design and architectural skill (Utaberta & Hassanpour, 2012). Since this research aims to collect data about the architectural quality of students' projects, the assessment should eliminate any extraneous factor such as individual differences in graphics ability. To achieve this goal, all projects were depicted using a *unified template* with the *same graphic expressions* and *layout*.

- '**Investigator triangulation**' or collaboration with other researchers can improve the validity and reliability of research. It can reduce bias and ensure a broader and more balanced perspective (Cohen et al., 2002). Additionally, frequent debriefing sessions between the researcher and his or her supervisor or other researchers can increase *credibility* (Shenton, 2004). In the intervention study, the researcher collaborated with another researcher, and frequent debriefing sessions were held regularly to discuss the study and the data collected from students. Furthermore, before administrating the survey, three graduate students were asked to check the clarity of the questionnaire, identify misunderstood or uncompleted items, and give feedback on the format of questions.

### **3.4. Limitations**

There are two significant limitations to this research. First, the lack of a control group can be seen as a limitation of the intervention study. A control group was hard to achieve due to administrative, political, and social constraints. The second limitation concerns the expert panel.

Because of budget constraints, time constraints, and individual schedules, the panel had a small number of participants. Only a few people could come for two days to TAMU to participate in the panel. Despite these limitations, this research exceeds norms for research in this field for rigor affecting reliability and validity. Arguably, it sets a benchmark for investigating BIM and conceptual design, and for conducting design-based research in architectural education.

### **3.5. Summary**

This chapter outlined the research method used to answer the research questions. A discussion of the mixed methods approach of this research was explained. This discussion was divided into two phases: phase I is the *development phase* of the study, and phase II is the *validation phase* of the study. The development phase has three main sections. The first section discussed the development of the theoretical framework through conducting a literature review in three main areas: architecture and building, computability of architectural knowledge, and BIM. The second section outlined the development of the AIM computational framework. This development consists of selecting a design theory, a BIM tool, and a test case, and then developing software and use cases to represent the theory. The third section discussed the development of the pedagogical framework to teach AIM in the design studio. This development includes defining the learning environment, learning tasks, and activities, as well as assessment methods. The validation phase of the study is composed of two sections. The first section is an intervention study. The intervention study was conducted as a longitudinal study. Forty students from *ARCH 205 Architecture Design I* course at TAMU participated in this study. Data were gathered from collecting the learning outcomes (projects and written descriptions), three surveys, and observations. The second section of the validation phase was an expert panel. The expert

panel assessed and discussed the projects created by students during the intervention study. The development of the computational framework AIM is explained in the next chapter.

## 4. THE COMPUTATIONAL FRAMEWORK (AIM) AND THE TEST CASE

This chapter discusses the development of the computational framework of this research. This framework is called Architectural Information Modeling (AIM). It allows BIM to support conceptual design. The discussion in this chapter consists of three main sections. The first section addresses the development of AIM framework. This development includes the formalized theoretical foundation of AIM and its significant components. The second section investigates the work of Richard Meier as a test case for the theoretical foundation of AIM. AIM was used to encode the formal language of Richard Meier through a parametric model of the *Douglas House*. Afterward, this model was transformed to generate other design options. The last section outlines the main features of AIM as a *high-level design system*.

### 4.1. AIM framework

Most researches focus upon BIM as a tool for modeling technical aspects of building. This research posits that BIM need not be understood only as a tool; it is a design process and a way of thinking. AIM investigates the possibilities to extend BIM beyond the notion of modeling tool to an architectural thinking process. In other words, AIM represents a shift from BIM as a modeling environment that is composed of 3D-building vocabulary into a design environment that can code architectural languages through vocabulary and design rules. AIM provides an explicit representation of design knowledge in which the process of architectural design becomes a form of computation that follows a particular logic.

#### ***4.1.1. Formalized theoretical foundation***

Any attempt to compute design knowledge must be supported with a rigorous theoretical foundation (Mitchell, 1986). However, not all design theories can be computed because a design theory should share certain commonalities with computation theories (Kalay, 1990). Moreover, design theory and a digital tool or software should share similar ontology or underlying structure (Akin, 1990).

The AIM framework is aligned with the theory of *formal language*. Formal language shares many commonalities with computation theories, such as defining elements, transformations, and rules or relationships (Knight, 1999). Today the term “formal language” is widely used in describing and reasoning about computer languages and object-oriented software designs (Eden, 2001). In addition, BIM tools, such as Autodesk Revit, share similar logic or ontology with the theory of formal language. Revit is an object-based parametric modeling system that represents objects by rules and parameters to govern the geometry as well as some nongeometric properties. In that sense, Revit is based on the two main syntactical components of any formal language: *objects* and *rules*.

In the light of Durant’s (1821) distinction between building and architecture, two types of elements can be distinguished in Revit. First, Revit has a predefined set of object classes or categories, such as wall, column, slab, stair, beam and roof systems. According to Durant’s (1821), these *physical* elements represent the *elements of construction* (Madrazo, 1994). Second, Revit has a set of conceptual or generic objects that are more schematic. These *abstract* elements represent the *elements of composition* (Madrazo, 1994). Any object or family can be expressed through a set of parametric rules that defines how that object behaves. The parametric rules that define how a family behaves are called *transformational rules*. In any Revit family,

transformational rules are used to generate instances from that family that retain fundamental form and relationships yet vary in location, dimension, or other quality. Finally, Revit provides a set of *relations* that control how elements are related to each other. These relations may reference what can be connected or the parts of aggregation as well as other parameters, including distance, angles, and rules such as *equal to*, *attached to*, *parallel to* and *offset from*. In formal language, the rules between elements are called *syntax*, and the rules between parts of aggregation are called configuration.

The semantic dimension of formal language that addresses the meaning of architectural form is not part of the AIM framework. However, Revit allows the designer to define *semantically rich objects* by using nongeometric parameters. These parameters can be used to code functional knowledge, structural knowledge, as well as formal knowledge (e.g., name, and visual properties such as transparency, material, and color).

Lastly, in AIM, formal language is understood as a formal *system*. To design, means to create a system and not just a final product. That system is a *generative* system that can generate several design options. Therefore, in AIM, formal language can be best understood through the notion of *system thinking*. System thinking is a structured cognitive behavior that connects all the features of systems thoughts and studies the properties and principles that act together as an interactive whole and express the behavior of any system. Accordingly, the designer as a system thinker can “*draw distinctions between an identity and a non-identity; recognize the bi-directional properties (affect and effect) of relationships; organize parts and wholes into alternative nested systems; and take new perspectives by transforming one’s point-and-view*” (Cabrera, Colosi, & Lobdell, 2008, p. 307).



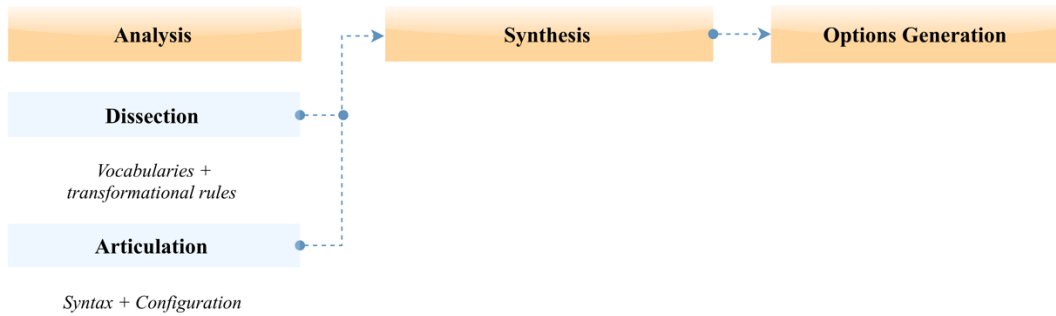
#### ***4.1.2. AIM components and workflow***

To compute formal knowledge in AIM, the three main exercises (A-S-G) of formal composition need to be incorporated. These exercises are *analysis*, *synthesis*, and *options generation*.

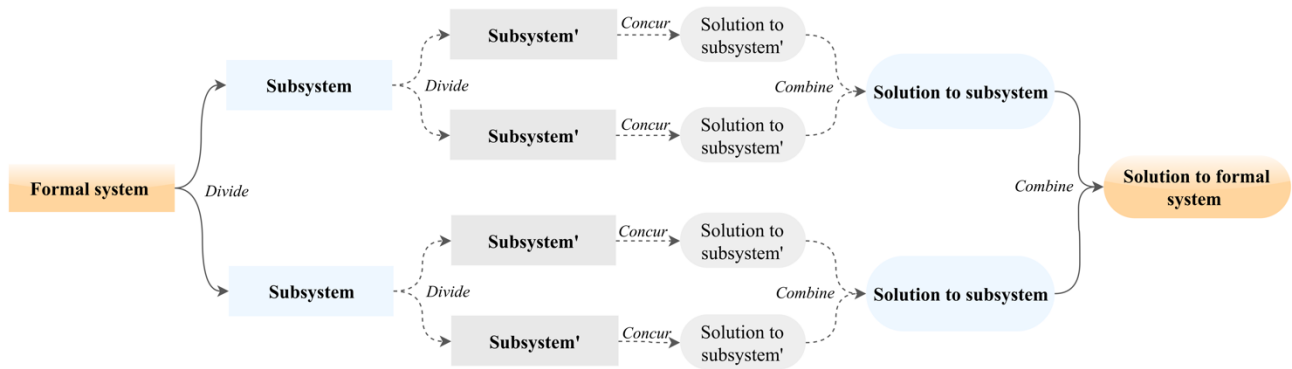
##### *4.1.2.1. Analysis*

The analysis or discovery of a formal language involves two operations: dissection and articulation (Barthes, 1972). First, in dissection, a designer should identify the main vocabularies or elements of a formal language. Moreover, a designer should distinguish between two types of elements: *elements of construction* and *elements of composition*. Elements of construction refer to building elements such as type of floors, walls, windows, mullions, ceiling, railings, and stairs. On the other hand, the elements of composition refer to the abstract generic elements of architectural form such as masses, planes, and lines. Elements of composition are generic *conceptual* elements subjected to transformational rules that can produce a virtual group of instances that are similar yet distinct. In that sense, defining a conceptual element involves outlining the *identity* of that element in terms of *the transformational rules* that can be applied to that element, the *behavior* of that element in response to transformations, and other characteristics as color or transparency to indicate certain aspects of form such as solid/void elements. Second, in articulation, a designer should identify the main rules of association or combination for the elements of the composition. These rules include syntax and configuration rules (Figure 7). Accordingly, a designer needs to decompose the overall configuration into nested systems that are composed of various elements associated through syntactical rules. In the current AIM framework, the activity of analysis is not automated yet. It profoundly depends on

the analytical skills of designers. Such skills incorporate the ability to apply logical thinking to gather information, analyze formal systems, and employ problem-solving strategies such as *divide and conquer strategy* (Figure 8).



**Figure 7** The activity of analysis in AIM



**Figure 8** The logic of divide and conquer strategy in formal systems

#### 4.1.2.2. Synthesis

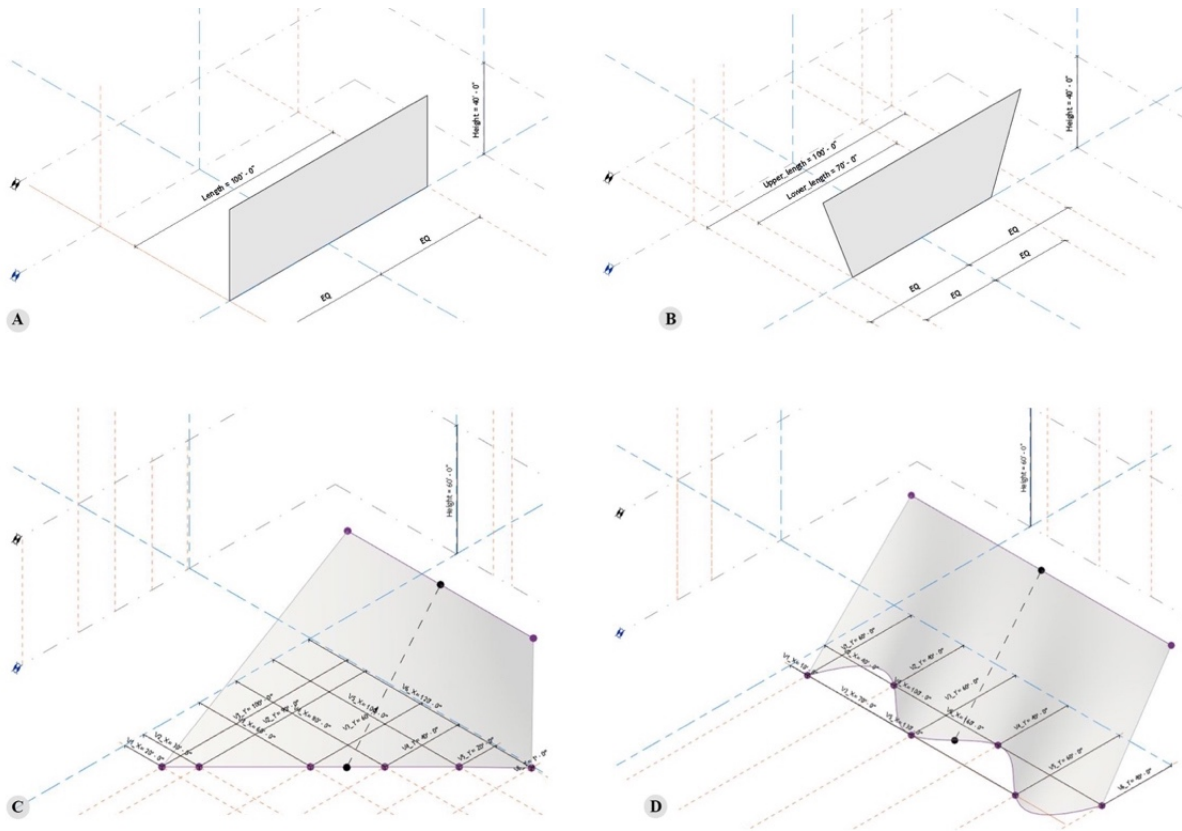
The synthesis stage in AIM focuses on how to describe a formal system using BIM and computational methods. AIM relies on establishing a system between three modeling

environments in Revit: *Family Editor* (FE), *Conceptual Design Environment* (CDE), and *Project Environment* (PE).

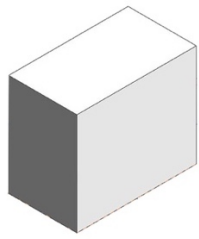
First, FE is used to create the elements of construction (e.g., walls, roofs, windows) and the conceptual design elements of a formal language. Each element created in FE is called a *family*. A family can generate different elements that share the same set of parameters and graphical presentation. Any element created from a family is called an *instance* that has the same parameters, but with different values. AIM uses FE to construct dynamic database *vocabularies* that are tied to geometry. To build any vocabulary in FE, the designer establishes a framework or structure of regulating geometry using *reference planes* and *reference lines* tools. Moreover, *parameters* (e.g., dimension parameters, formulas, and conditional statements), and *constraints* (e.g., alignment, equality constraint, locked dimension) are used to define relationships and dependencies. A design vocabulary can be established through various modeling strategies, frameworks, parameters, and constraints. The way vocabulary is established determines its *transformational behavior*. A simple rectangular plane, for example, can be defined through the extrusion of a simple line, the coordinate of the points or vertices, or the geometry of curves such as NURBS (a non-uniform rational B-spline). Each method has a different set of parameters and constraints that defines the behavior of that plane (Figure 9). Likewise, a rectangular prism may also be defined in various ways, and each way can have different parameters, constraints, behavior, and possible outcomes or instances (Figure 10). In that sense, the behavior of design elements needs to be *explicitly* defined in AIM. In addition to behavior, the *semantics* of design elements should be defined too. Text and material parameters can be used to add names and distinguish design elements. For instance, a material parameter can be used to color-code

elements and distinguish between a circulation mass and a living mass, main mass, and minor additions, or solid and void masses (Figure 11 and Figure 12).

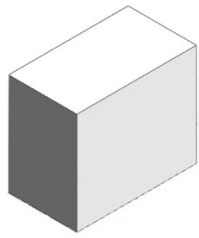
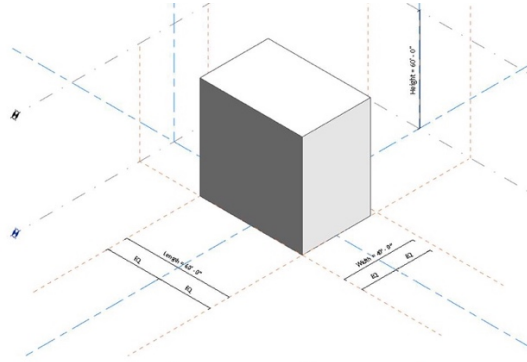
The conceptual design elements created in FE are simple and usually created through using a 2D profile and extrusion, blend, revolve, sweep, or swept blend command. However, the vocabulary set of formal language may include more *complex* or *combined conceptual elements* that cannot be created in that way. In AIM, a complex conceptual element can be created through using divide and conquer strategy to break down the sophisticated vocabulary into simpler sub-vocabularies. Each sub-vocabulary is parametrically defined in FE. Then, the sub-vocabularies are *nested* or combined through *Boolean operations* to create a more complex one that has the parameters of each sub-vocabulary and other parameters and constraints that represent the syntactical relationship between the sub-vocabularies (Figure 13 A & B). In addition to FE, CDE, a type of FE, can also be used to create complex vocabularies (Figure 9: B & C, Figure 10: B, C, & D).



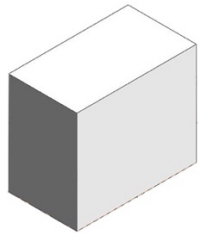
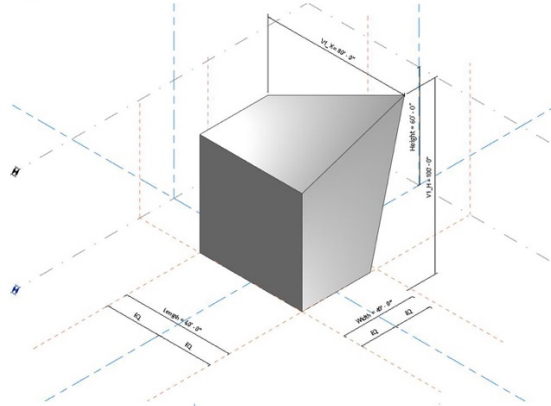
**Figure 9** Three different ways to construct a rectangular plane: In A: length and height parameters, B: upper length, lower length, and height parameters, C: X, Y parameters for the points at the Spline curve, D: is the same case of C but with different values for the X, Y parameters



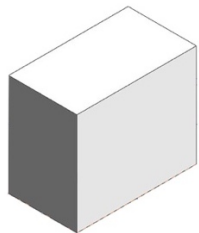
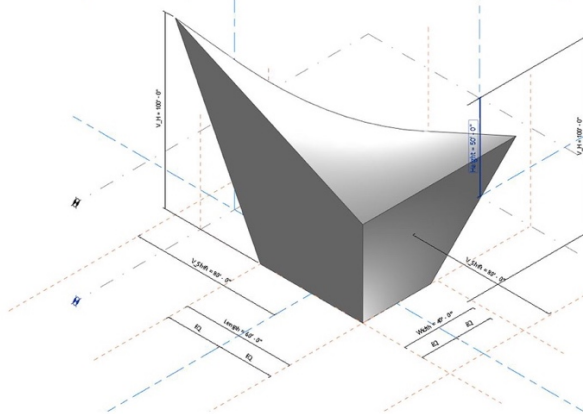
A



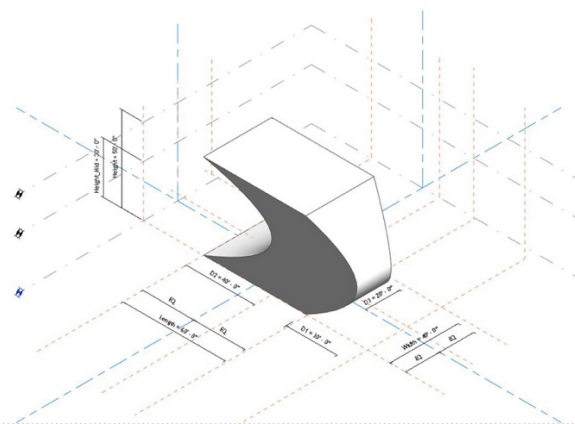
B



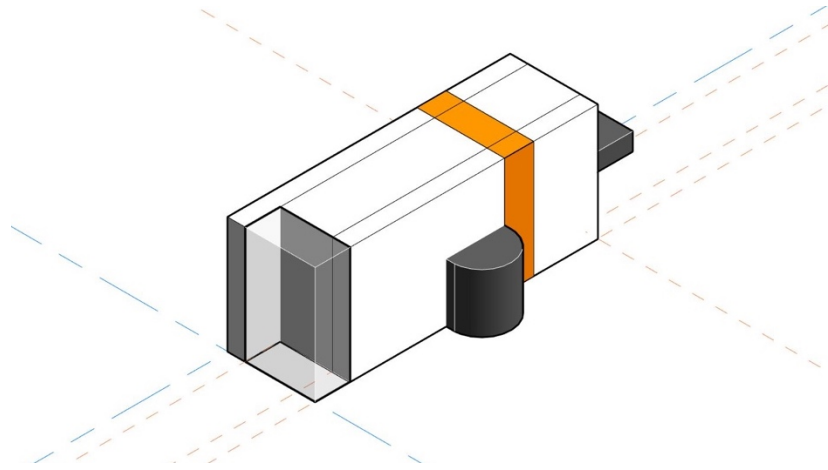
C



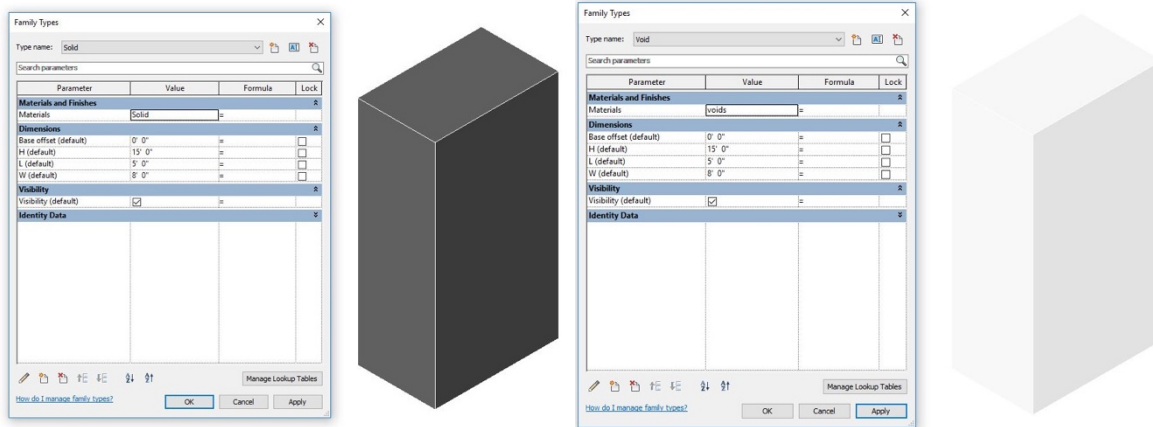
D



**Figure 10 Four different ways to construct a rectangular prism. They all share the same initial state, but each one behaves differently when we change its parameters.**



**Figure 11 Use material parameters to color code the conceptual diagram distinguish between circulation (orange), main living mass (white), minor additions (dark gray), and void masses or subtractions (transparent gray)**



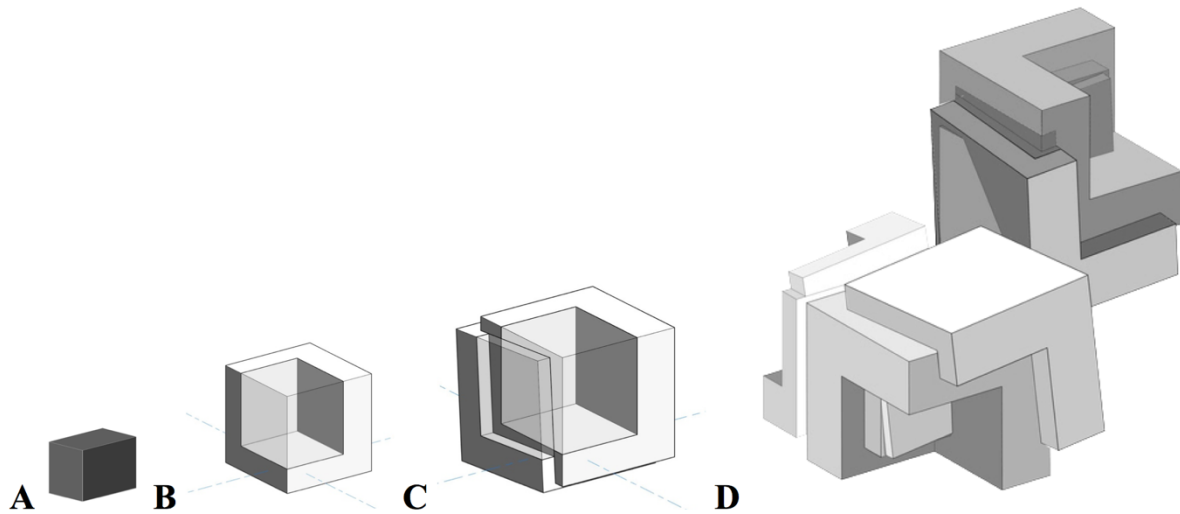
**Figure 12 A simple conceptual vocabulary that has two types: Solid and Void.**

Second, CDE is used to create parametric *conceptual masses* to explore design ideas at a conceptual level. CDE allows the designer to create conceptual massing families that can be integrated into the PE. Unlike FE, CDE has a variety of features such as flexible geometric form-making and manipulation tools, an enhanced drawing environment, and tools to divide surfaces

and apply patterns. In AIM, CDE is used to combine all the conceptual design elements that were created in FE or other CDE files, into a conceptual buildable form (Figure 11). This form is a *conceptual mass* that represents the *conceptual diagram* of the design. In AIM, the conceptual diagram is the base from which designer can create more detailed designs by applying the elements of construction such as walls, roofs, and floors. This diagram, thus, is modeled to scale, so the relative sizes of conceptual elements are correctly represented. The *syntactical* relationships and dependencies between conceptual vocabularies are defined through a framework of *reference planes* and *reference lines, parameters* (e.g., dimension parameters, formulas, and conditional statements), and *constraints* (e.g., alignment, equality constraint, locked dimension, and locked profiles). Furthermore, Dynamo, a visual programming software in Revit, can also be used to establish *syntactical* relationships and dependencies between the conceptual vocabularies.

In constructing the main conceptual diagram, the strategy of *divide and conquer* can be employed. The complex diagram can be divided into sub *syntactic units* created in CDE. Typically, a syntactic unit consists of several elements and syntactical relationships between them. Several syntactic units can be nested and assembled in another CDE file to compose the conceptual diagram. For instance, the conceptual diagram of Guardiola house by Peter Eisenman can be created through constructing a combined vocabulary L-Form. The L-Form vocabulary consists of two instances of a simple rectangular prism. The L-Form is nested with another L-Form to create a complex syntactic unit. Finally, three instances of the syntactic units are combined to create the conceptual diagram of Guardiola house (Figure 13).

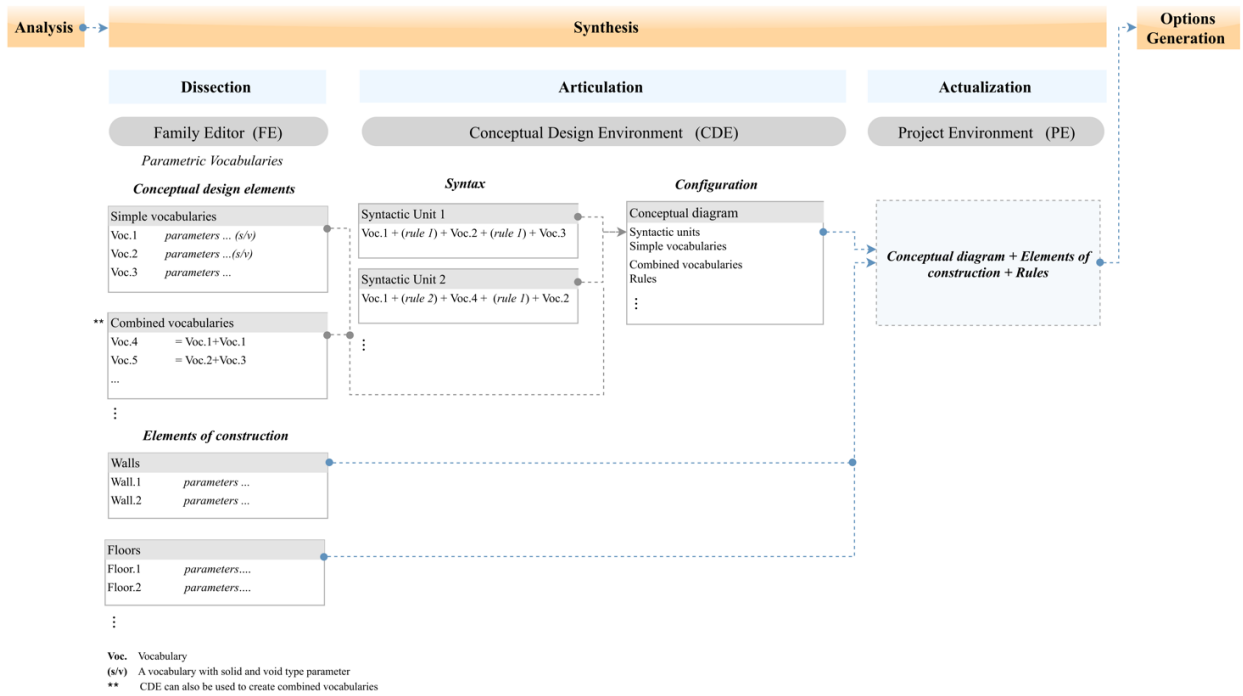




**Figure 13 The use of divide and conquer strategy to construct the conceptual diagram of Guardiola house by Peter Eisenman. A: a simple vocabulary; B: a combined L-Form vocabulary. C: a nested syntactic unit. D: the final conceptual diagram**

Lastly, PE is used to *actualize* the conceptual diagram into a built form. First, the conceptual diagram that was created in CDE is loaded into PE. Then, the elements of construction (walls, floors, roofs, and curtain systems) are automatically created from the faces of the conceptual diagram using Building Maker tools. Building Maker draws an association between conceptual masses and building elements. It maps the conceptual diagrams to real-world building elements. For instance, a mass surface can become a curtain wall. Accordingly, a dynamic relationship between CDE (i.e., conceptual elements) and PE (i.e., building elements) is established. This relationship allows the designer to access and change the parameters of the conceptual diagrams while he is working in PE or update the conceptual diagram in CDE then override the old one. Subsequently, the elements that were created from the conceptual diagrams can be updated to follow the changes in the conceptual diagram. Additional building elements can be added in the PE, such as stairs, railings, windows, and doors. Although these elements

were not generated from the conceptual diagram, the designer can establish *syntactical* relationships and dependencies through using *parameters* (e.g., global parameters), datum elements (e.g., grid, levels, work planes, reference planes), and *constraints* (e.g., alignment, equality constraint, locked dimension). Figure 14 shows the logic of synthesis in AIM.



**Figure 14** The activity of synthesis in AIM

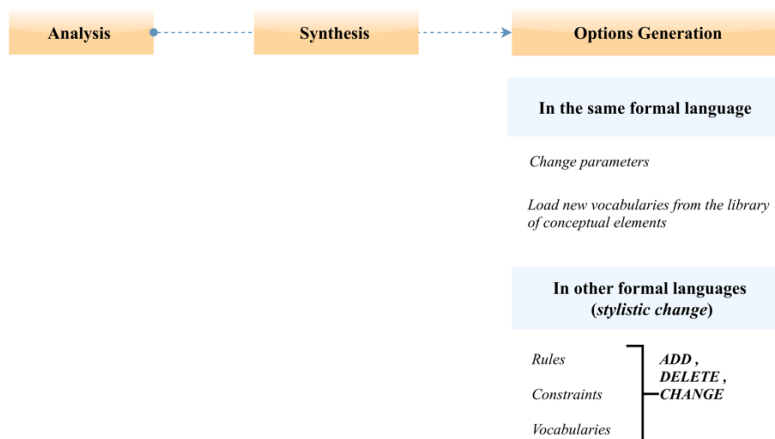
#### 4.1.2.3. Options Generation

This stage explores the range of design alternatives that can be generated to satisfy design goals. AIM enables the designer to create design options that have a consistent formal language or explore other languages i.e., *stylistic change*.

In CDE, in addition to parametric vocabularies, rules such as modularity, axiality, subtraction, additions, alignment are made explicit. Accordingly, design rules or the syntax of a

formal language can be transformed through several operations such as *rule addition*, *rule deletion*, *rule change*, *rule replacement*, *constraint addition*, *constraint relaxation*, and *constraint removal*. Moreover, to change design vocabulary in a formal language, the designer can add vocabulary, remove vocabulary, replace vocabulary, and adjust existing ones through changing ‘type parameters’ in FE. Both conceptual and building vocabularies can be changed or transformed. For instance, in PE, the designer can select an exterior and access all the parameters of that wall, and by changing certain ‘type parameters’ such as material and structures, the type of that wall and all its instances will be updated to follow that change.

In that sense, because AIM represents formal languages explicitly in terms of rules and vocabulary, it lays bare possibilities for transformation that are not accessible by just looking at individual designs or reading about them. Additionally, transformations can be quickly realized by making simple changes to rules. Therefore, transforming a formal language in this way can be used not only to create new design language but a range of design languages. In a few steps, a whole range of possibilities will be opened up when a formal language is defined explicitly, as the designer can access its logic. Figure 15 shows the logic of options generation in AIM.



**Figure 15 The activity of options generation in AIM**

## 4.2. Richard Meier's formal language as a test case <sup>3</sup>

The investigation of a formal language often starts with a precedent, because a language can be revealed by examining an expression that uses that language (Flemming, 1990; Knight, 1981, 1999). The choice of this test case is guided by the need to choose an architectural work within a family of similar work that can be dissected and articulated to document the language.

In the 1970s, the structuralist way thinking in architecture emerged in America as *Formalism*, an approach that explores an autonomous architectural system (Hays, 1998). Through a linguistic analogy with formal *logic*, American structuralists pursued a meta-language that could found an *epistemological structure* for designs (Deamer, 2001). This desire for architectural autonomy was represented in the works of New York Five (NY5), which included Peter Eisenman, Michael Graves, Charles Gwathmey, John Hejduk and Richard Meier (Deamer, 2001; Till, 2009). NY5 have shared clear formal strategies that mark their individual works. The final outcome is less the goal than is the process, with preexisting elements allocated according to formally logical rules (Deamer, 2001; Frampton, 1975). Among the five, Richard Meier has remained committed to formalism from the 1970s until now. Meier has consistently employed a clear set of organizational principles and vocabularies that can be traced throughout a wide range of building types.

In this research, the definition of Meier's formal language relied on two main foundations. First, Meier has provided a verbal explanation and a diagrammatic representation of his formal language in his books. Second, the general characteristics of Meier's work has been investigated by many researchers (Al-Assaf, 2014; Al-Assaf & Dahabreh, 2014; Allen, 1999;

---

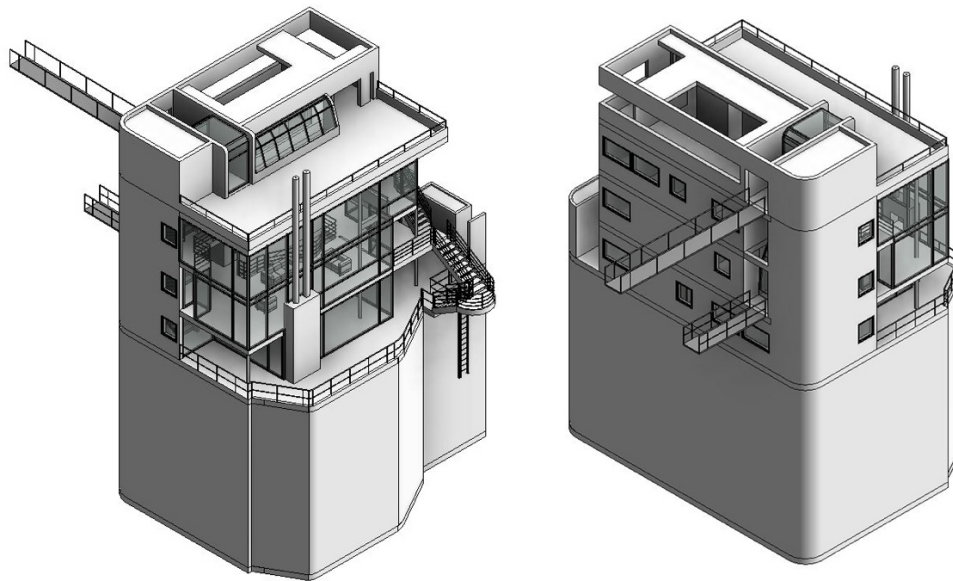
<sup>3</sup> The work presented in this section was published in the Proceedings of ACADIA 2017 conference, Massachusetts Institute of Technology (MIT), Cambridge, "Representing the Aesthetics of Richard Meier Using Building Information Modeling" by Al-Assaf and Clayton, 2017. This section includes updated figures and tables in addition to the published material.

Cassarà, 2005; Dahabreh, 2013; Dahabreh & Al-Assaf, 2013; Deamer, 2001; Frampton, 1975, 2003; Giovannini, 1996; Rykwert, 1999). Those general characteristics represent a set of design rules and elements that can be traced throughout most of Meier's work ranging from small scale houses to large scale public projects. From this perspective, this research investigates Meier's formal language by providing an explicit definition of the most common design rules and elements that Meier used in his projects. The investigation is led by the three main components of AIM: analysis, synthesis, and options generation. Moreover, the Douglas House was selected as a test case to represent Meier's architectural language in AIM. This house is considered a milestone in Meier's career, at which he formulated a constant and mature formal language that persists throughout his later works (Frampton, 1975).

#### ***4.2.1. Analysis***

Meier relies on the syntactic dimension of architectural form to formulate his language. The formal language of Meier employs abstract geometric vocabularies and syntactical rules such as modularity, proportion, axuality, frontality and spatial layering, and duality. *Frontality* is a formal operation to generate spatial stratification. The generated spatial layers are arranged perpendicular to the main entry axis (Flemming, 1989). Meier also uses syntactical centrality as a configurational rule. Syntactical centrality distinct from shape-geometric centrality, indicates a process of spatial configuration that constructs a distinctive architectural space. This space is typically a multi-volumetric space that hosts the main function of the building, such as a living room, with an open field of view that penetrates to the surrounding areas (Hillier, 2007; Kweon, 2002).

The **Douglas House** was designed and built between 1971 and 1973. It is located in Harbor Springs, Michigan. The four-story house is perched on a steep site of evergreen trees, appearing like a manmade or a machined object. The house can be reached via a flying bridge at roof level (Figure 16). On July 12, 2016, the historical significance of house received an acknowledgment by the National Park Service U.S. Department of the Interior and was included on the National Register of Historic Places.



**Figure 16 The Douglas House in Harbor Springs, Michigan (Al-Assaf & Clayton, 2017)**

Meier conceived the house as a white rectangular prism with a base of 51x30 ft. A *module* of 3x3 ft defined the overall composition of the house. A longitudinal axis divided the main rectangular prism into *two paradoxical prisms*: a solid one that exemplifies the private zones and a glass one that hosts the public zones. Each rectangular prism has an A-B-A *layering system* (Dahabreh, 2013). The spatial layers are perpendicular to the main entry axis or the

*transverse axis*. The private zone is located at the road-facing façade as closed cellular spaces while the public zone embraces waterfront views as rectangular platforms floating in a multi-volumetric glazed enclosure. The *longitudinal axis* was marked by a *corridor* that mediates these zones on each floor. The duality between the binary oppositions of public and private is reflected in the type of structure in each zone and the facades' treatment. The public zone is demonstrated by *glazed walls* and mullions aligned to the *free-standing columns*. In contrast, the private zone is manifested by *opaque walls* fenestrated by few windows and *load-bearing walls*. The two *paradoxical* prisms are further subdivided into several *spatial layers*. These spatial layers are parallel to the longitudinal axis. In this layered system, a *transverse axis* penetrates all the spatial layers, defines the entry, and locates the flying bridges as well as the chimney. At the intersection of the transverse and the longitudinal axes, a *syntactical center* is established as an expansive open zone. Lastly, the main rectangular mass is animated by a series of formal *additions* and *subtractions*. In comparison to the volume of the main living rectangular prism, these additions and subtractions are minor and not dominant. The words in italics emphasize syntactical concepts. Table 2 summarizes the formal language of Richard Meier in most of his projects.

**Table 2 An analysis of the formal language of Richard Meier (Al-Assaf & Clayton, 2017)**

<b>Vocabulary</b>	
<b>Conceptual elements</b>	<b>Elements of construction</b>
<b>Masses:</b> rectangular prisms, cylinder, curvilinear masses	cylindrical columns
<b>Planes:</b> horizontal and vertical planes	opaque walls, curtain walls, slabs, flat roof
<b>Lines</b>	mullions, handrails
A <b>combined element</b> (2 main rectangular prisms + 2 cylinders)	Stairs, bridges, chimney, balconies
<b>Syntax and Configuration</b>	
<b>Module:</b> 3x3 ft.	<b>2 axes:</b> Transverse and longitudinal
<b>Frontality</b> (L > W) and <b>Spatial layering</b> (A-B-A)	<b>Duality:</b> solid/void, public/private, subtraction/addition
<b>Syntactical centrality</b>	<b>Proportions:</b> 1:2, golden ratio, 1: $\sqrt{2}$

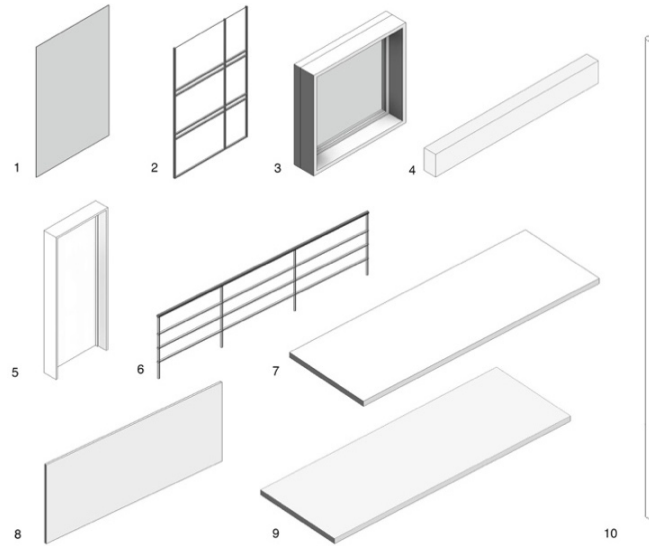
#### 4.2.2. *Synthesis*

This section illustrates using BIM to express the formal language of Richard Meier in the Douglas House. The two operations to define any formal language, *dissection* and *articulation*, were conducted using Autodesk Revit as a BIM tool.

The first operation in representing an architectural language is *dissection*. In AIM, dissection involves modeling the conceptual vocabularies as well as the elements of construction of Meier's formal language. Typically, Family Editor (FE) is used to model the elements of construction that foster the production of architectural expression in the Project Environment PE. However, the elements of construction in Meier's language are generic elements, such as plain planes, rectangular windows, pipe railing, and curtain system (Figure 17). These elements are already available in PE.

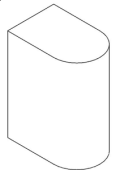
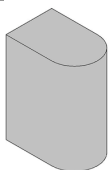

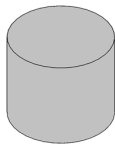
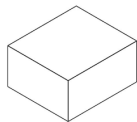
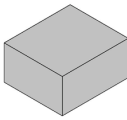
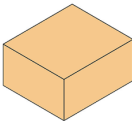
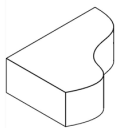
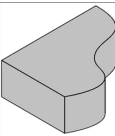
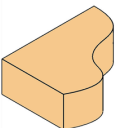
In Meier's architecture, there is a shared set of *conceptual design elements* that he uses as additions or subtractions to the main mass of the building. These elements were modeled as *parametric families* using FE in which some of them have a *type parameter* that is used to indicate either a *solid* element and or a *void* one. A complex or combined conceptual vocabulary was modeled through nesting more than one simple vocabulary in FE. Table 3 shows the *conceptual design elements* that Meier used in most of his projects.

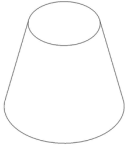
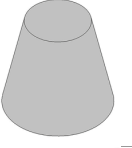
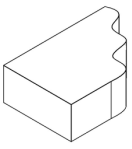
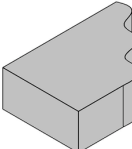
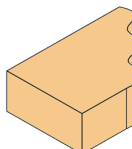
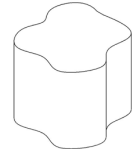
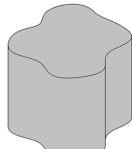
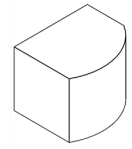
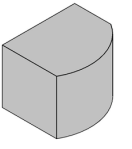
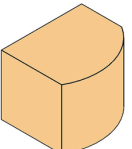
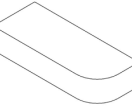
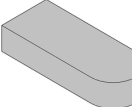
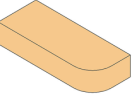
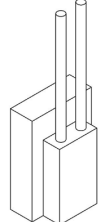
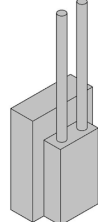




**Figure 17** The elements of construction in Meier’s language used in modeling the Douglas house in PE. 1: curtain wall, 2: mullions, 3: windows, 4: beams, 5: doors, 6: railings, 7: slabs, 8: walls, 9: flat roof, 10: circular column (Al-Assaf & Clayton, 2017)

**Table 3** The conceptual design elements of Richard Meier's formal language

Simple Conceptual Vocabularies			
Vocabulary	Solid = Addition	Void = Subtraction	Parameters
			Height, Length, Width Materials: Solid (Dark grey)
			Height, Radius Materials: Solid (Dark grey)
			Height, Length, Width Materials: Solid (Dark grey), Void (Orange)
			Height, Length_1, Length_2, Width Materials: Solid (Dark grey), Void (Orange)

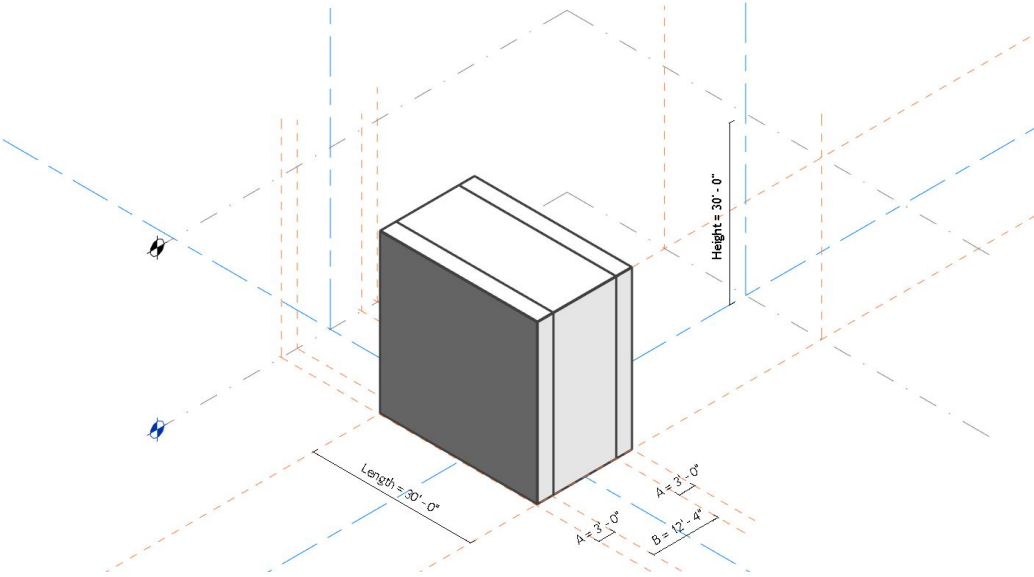
			Height, Upper_Radius, Lower_Radius Materials: Solid (Dark grey)
			Height, Length_1, Length_2, Width Materials: Solid (Dark grey), Void (Orange)
			Height, Scale Materials: Solid (Dark grey)
			Height, Length_1, Length_2, Width, Radius Materials: Solid (Dark grey), Void (Orange)
			Height, Length_1, Length_2, Width Materials: Solid (Dark grey), Void (Orange)
<b>Combined Conceptual Vocabularies</b>			
			Mass 1_Height, Mass 1_Length, Mass1_Width Mass 2_Height, Mass 2_Length, Mass2_Width Mass 3_Height, Mass 3_Radius, Mass3_Start  Mass 1_Visibility, Mass 3_Visibility, Materials: Solid (Dark grey)

The second operation to define a formal language is *articulation*. In AIM, articulation employs the Conceptual Design Environment (CDE) to create secondary syntactic units and the main conceptual diagram. Reference lines and planes, parameters, alignment constraints, and equality constraints were used to establish *rules* such as axuality, spatial layering, proportions, and modularity between the design elements in the conceptual diagram.

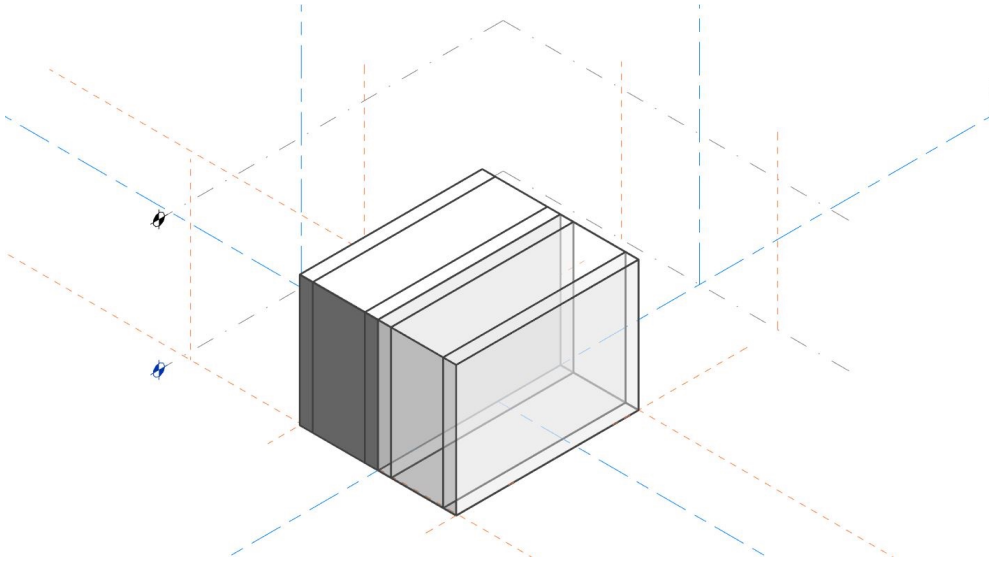
To model the architectural language behind the **Douglas House**, two methods were explored. The first method uses only CDE to create the conceptual diagram while the second method integrates CDE and visual programming (Dynamo).

In the **first method**, the main rectangular prism of the house was modeled as a syntactical unit with an A-B-A layering system in CDE. In CDE, the framework of the syntactical unit was first established. This framework is composed of reference planes that define the dimensions of the rectangular prism and the spatial layering system. Dimension parameters that define the length, height, and A-B-A layering system were assigned (Figure 18). Model Line command was used to create a rectangular prism. The boundaries of the prism were *aligned* and *locked* (alignment constraint) to five *reference planes*. Then, two rectangular planes were created using Model Line command. These planes were *aligned* and *locked* to the reference plane of each spatial layer. The boundaries of these planes were also *aligned* and *locked* to the faces of the rectangular prism. Accordingly, relationships and dependencies were established. For instance, the location of each plane is defined by the location of a reference plane. This reference plane is controlled through a dimension parameter. Moreover, the size of each 2D planes is controlled by the dimensions of the rectangular prism. Since the Douglas House has two similar syntactical units, but one is private and, one is public, a material parameter was added. This parameter allows us to distinguish between the public unit and the private one through the difference in transparency (Figure 19). In the CDE file of the *conceptual diagram*, the syntactical unit of A-B-A layering system was loaded twice. A framework of reference planes and dimension parameters were used to locate these two units. Additional reference planes were added in the transverse direction to define the entry axis (Figure 20). Two planes that exemplify the transverse axis were created, aligned, and locked to these reference planes. Subsequently, a series of formal additions

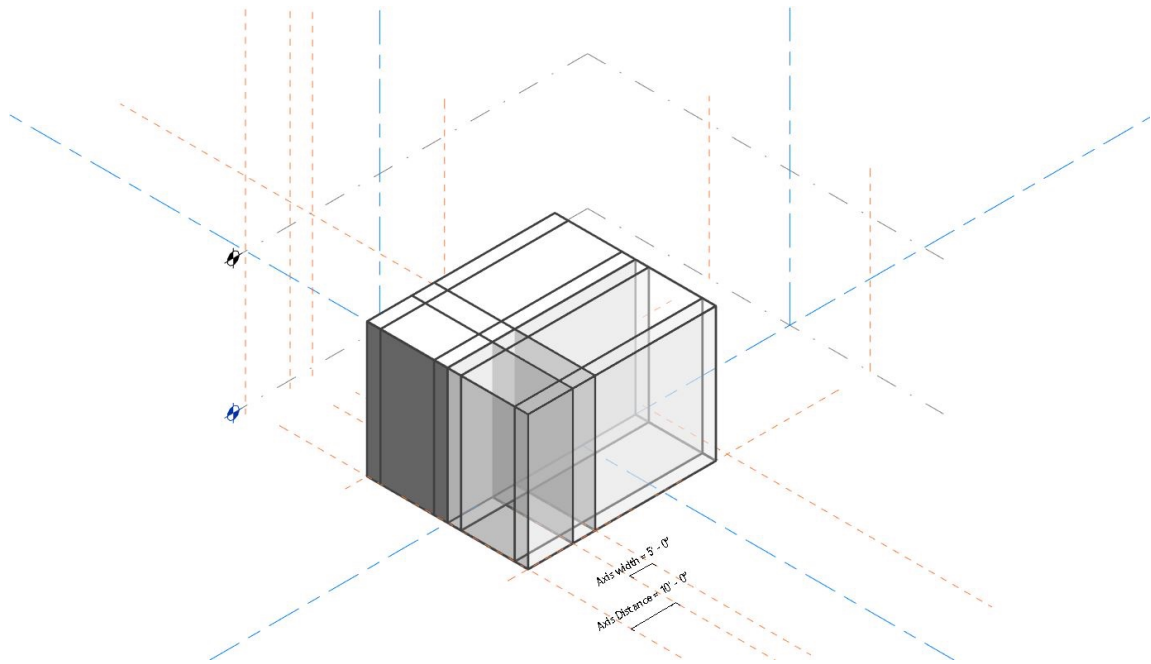
and subtractions were implemented to animate the main mass (Figure 21). These additions and subtractions are from the library of conceptual design elements that were created in FE (Table 3).



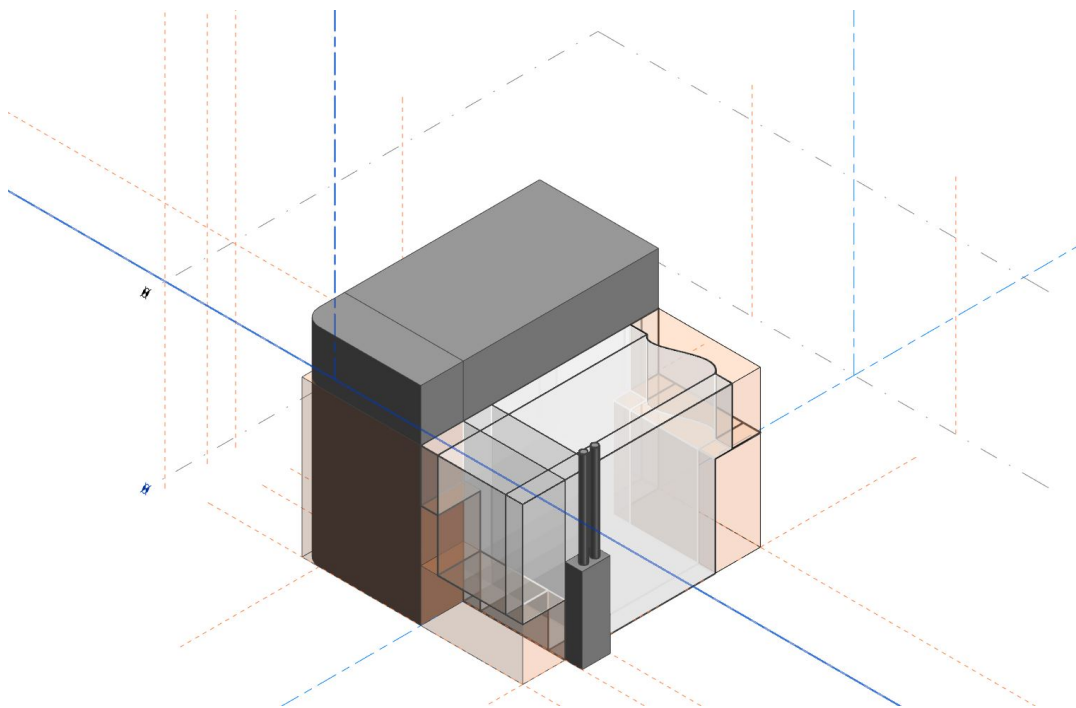
**Figure 18 A syntactic unit that has an A-B-A layering system in CDE**



**Figure 19 The public unit (transparent) and the private unit (opaque) in CDE**



**Figure 20 Define the transverse axis (entry axis) through reference planes in CDE**



**Figure 21 Employing a series of formal additions and subtractions from the conceptual vocabularies library to animate the main mass in CDE**

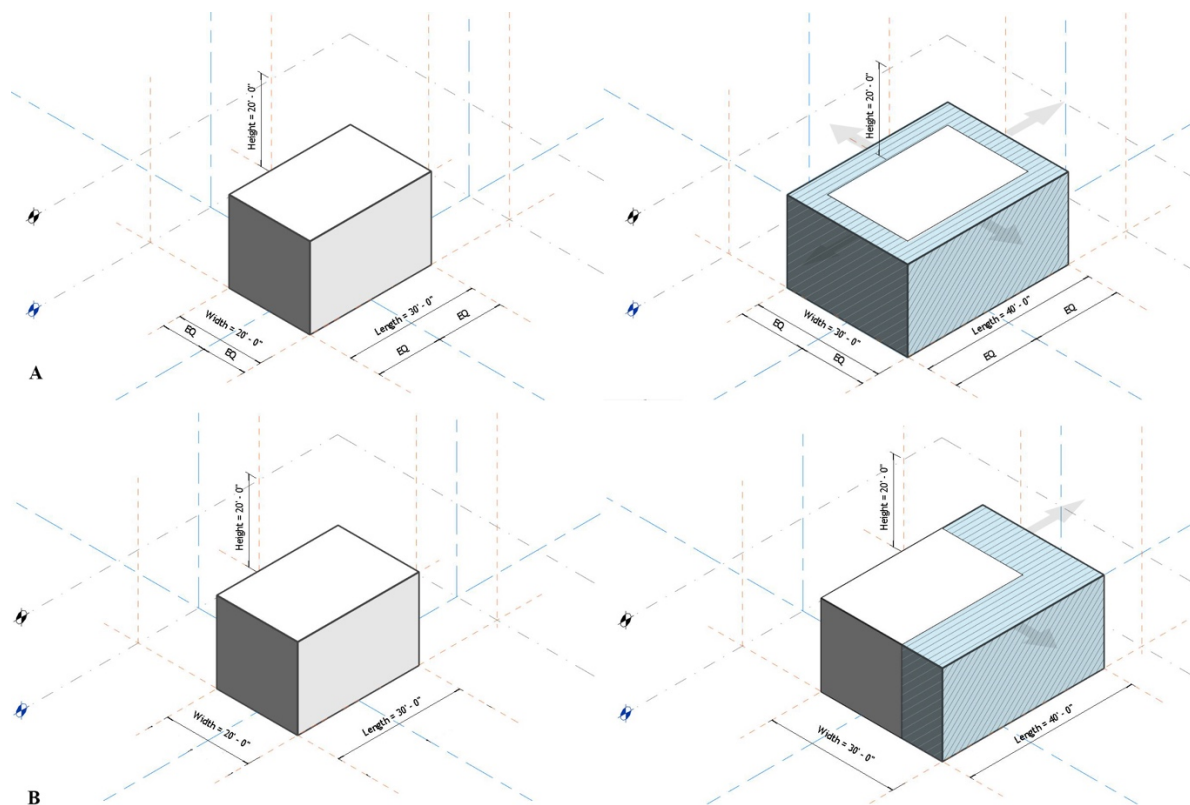
In this BIM model, the complexity of the formal system was addressed by employing divide and conquer strategy. The formal system was divided into subsystems of syntactical units and parametric vocabularies. The syntactical relationships were defined using reference lines and planes, alignment constraints, and equality constraints. The overall configuration in the conceptual diagram consists of syntactical units and solid and void objects that were related together through parameter values. The value of these parameters can be changed to create permutations of the Douglas house. Table 4 illustrates the list of parameters that elucidate how this model can be flexed. This BIM model is not only a single instance of a Meier house, but a formal language that allows for multiple expressive configurations.

**Table 4 List of parameters to flex the model of the Douglass House in CDE (Al-Assaf & Clayton, 2017)**

List of parameters	
Elements	Parameters
Levels	Level one, two, three, and four.
Public mass	Length parameter, width parameter, floor height parameter, floor number parameter.
Private mass	
The roof	
Entry axis	Width parameter, Location parameter
Spatial layers	Width parameter
Solid and Void objects	The parameters in table 3 + other location parameters

Using CDE alone makes controlling the behavior of design parameters problematic because BIM does not expose all constraints. There are implicit constraints that emerge from how that object was modeled. For instance, Figure 22 shows two different ways to model a rectangular prism in FE. However, because of equality constraint, each one of them behaves in a different way when we change the width and length parameters. When any of these objects are

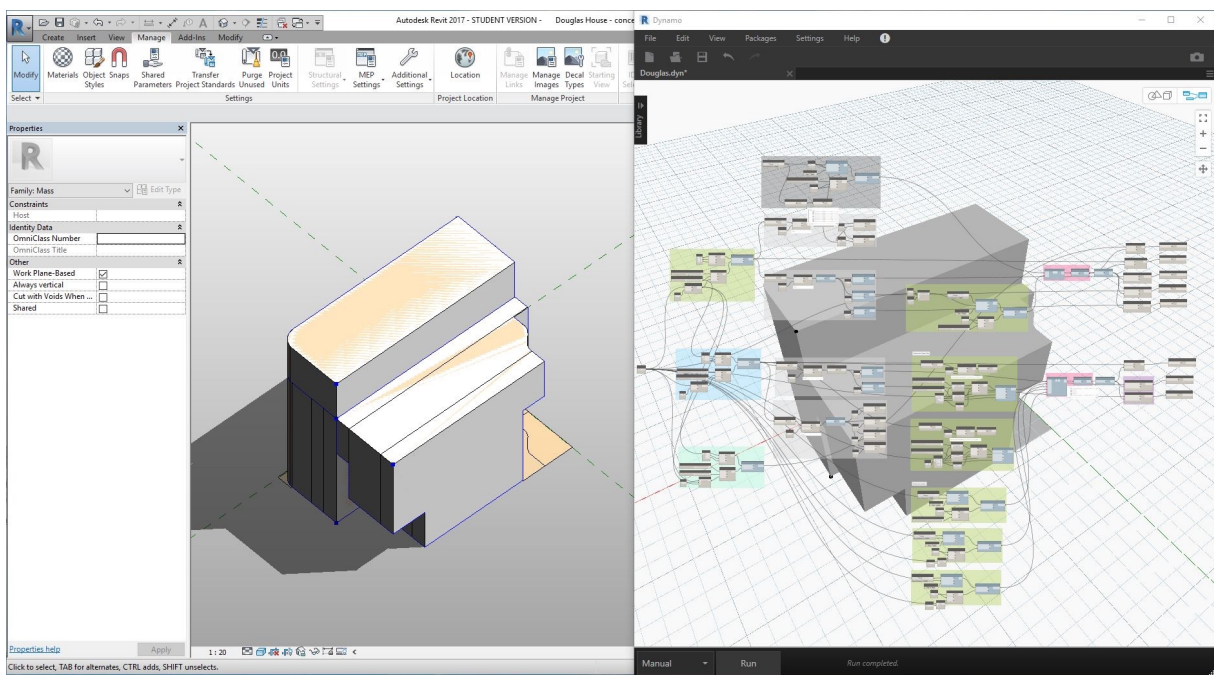
loaded to CDE and aligned in the conceptual diagram, the behavior of that object has a priority over the established alignment constraint in CDE. Thus, before an element is located and aligned in the conceptual diagram, the behavior of that element should be checked to avoid any conflict in constraint priorities.



**Figure 22 Two different behaviors of a rectangle prism. A: Width, Length, and Height parameters with equality constraint, B: Width, Length, and Height parameters without equality constraint.**

The **second method** relies on using Dynamo, a visual programming language (VPL), to create the conceptual diagram and explicitly define all parameters and constraints as a graph (Figure 23). In CDE, the two main rectangular masses of the conceptual diagram were created

using Dynamo. The dimensions and the location of each mass were controlled through a set of parameters. Then, an association between those parameters was established. For instance, when the width of one mass increases, the location of the adjacent mass will respond to that change automatically. The transverse and longitudinal axes as well as the spatial layers and were created by *deconstructing* the topology of each rectangular mass to produce *offsets* of the desired faces. Because the dimensions of each spatial layer are determined by the dimensions of its mass through the offset operation, only the offset distance is controlled by an additional parameter. A series of voids were loaded from the library of conceptual elements at Table 3. The location and the dimensions of these elements are also controlled by parameters. Table 5 illustrates the list of parameters that indicate how this model can be flexed using Dynamo and CDE.



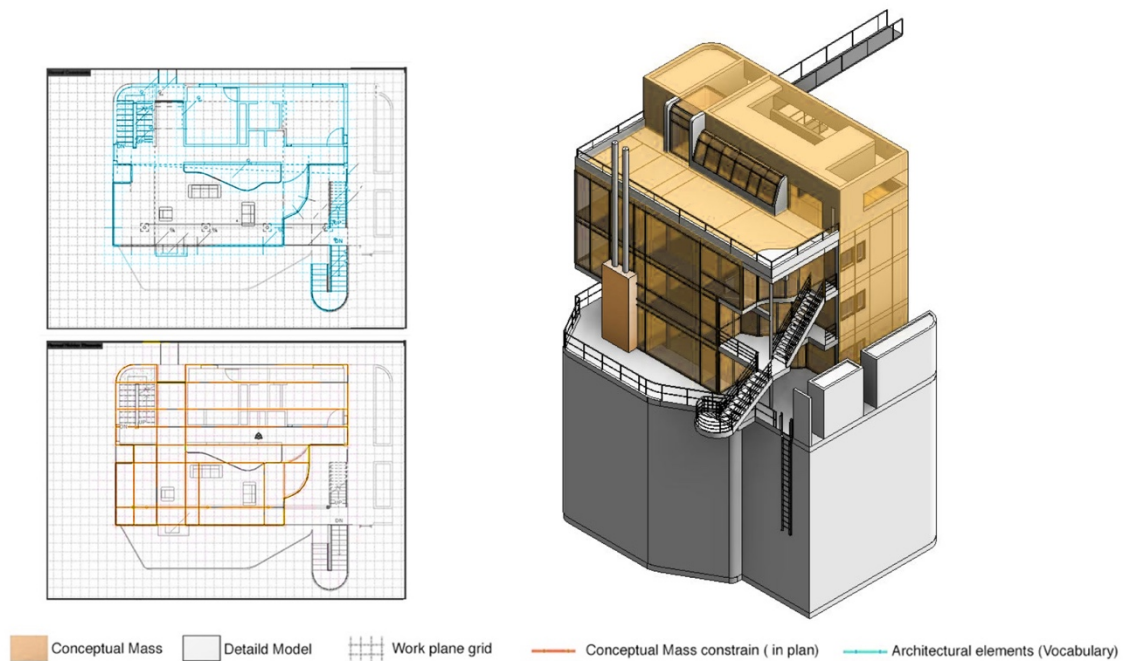
**Figure 23 Modeling the conceptual diagram of the Douglass House using CDE and Dynamo**



**Table 5 List of parameters to flex the model of the Douglass House in CDE and Dynamo (Al-Assaf & Clayton, 2017)**

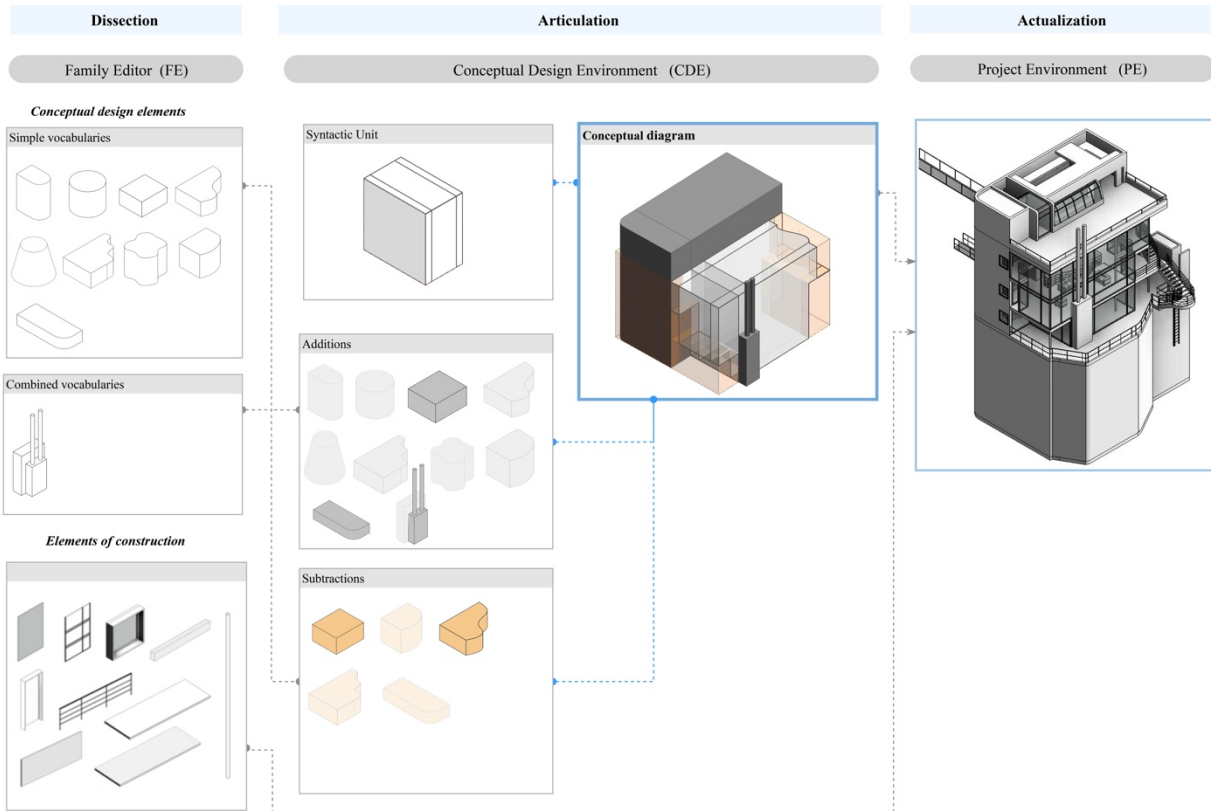
List of parameters	
Elements	Parameters
–	Floor height
Private mass	Length, width, number of floors, location (X, Y, Z coordinates)
Spatial layer (longitudinal dimension)	Offset distance
Entry transverse axis	Offset distance, width
Public mass	Length, width, number of floors, location (X, Y, Z coordinates)
Spatial layer (longitudinal dimension)	Offset distance
Entry transverse axis	Offset distance, width
Roof	Length, width, number of floors, location (X, Y, Z coordinates)
Voids	Length, width, number of floors, location (X, Y, Z coordinates)

For the **actualization** of the conceptual diagram to a constructible building, the main conceptual mass that was created in CDE was loaded into the Revit project environment (PE). This mass exemplifies the overall configuration of the house. The built-in generic families in PE represent the building vocabularies or the elements of construction. Each family has multiple parameters that control its properties according to the design requirements. After setting the level of each floor, Building Maker tools were used to mark the conceptual diagram into real-world building elements. The building vocabulary of wall, floor, beam, circular column, flat roof, stair, pipe railing, curtain system and mullion were used to produce a detailed architectural model by attaching and locking them to the conceptual mass (Figure 24). As a result, a cumulative understanding of the relationship between the abstract form and the corporeal form of the Douglas House was developed during the actualization process. Moreover, the relationship between the conceptual design elements and the elements of construction is preserved in which the elements of construction can be updated to follow any change in the conceptual diagram.



**Figure 24 The actualization of the conceptual diagram of the Douglass House to a constructible building in PE (Al-Assaf & Clayton, 2017)**

While **detailing** the model, BIM offers many features that help us to organize and control the syntactic relation between elements. The most important one is “*work plane grid*”; it is a modular system with user control of spacing that applies not only while working on plans, but also on elevations, sections and 3D. The second feature is *alignment*; an important example was using it to relate the mullions grid of the glazed façade with the internal organization of the house, such as the location of slabs and columns. Accordingly, any change with the location of these elements will be revealed on the mullions pattern. Other features may include “Datum” in the form of “grid” and “level” and grouping elements together. Figure 25 summarizes the process of modeling the Douglass House using AIM.



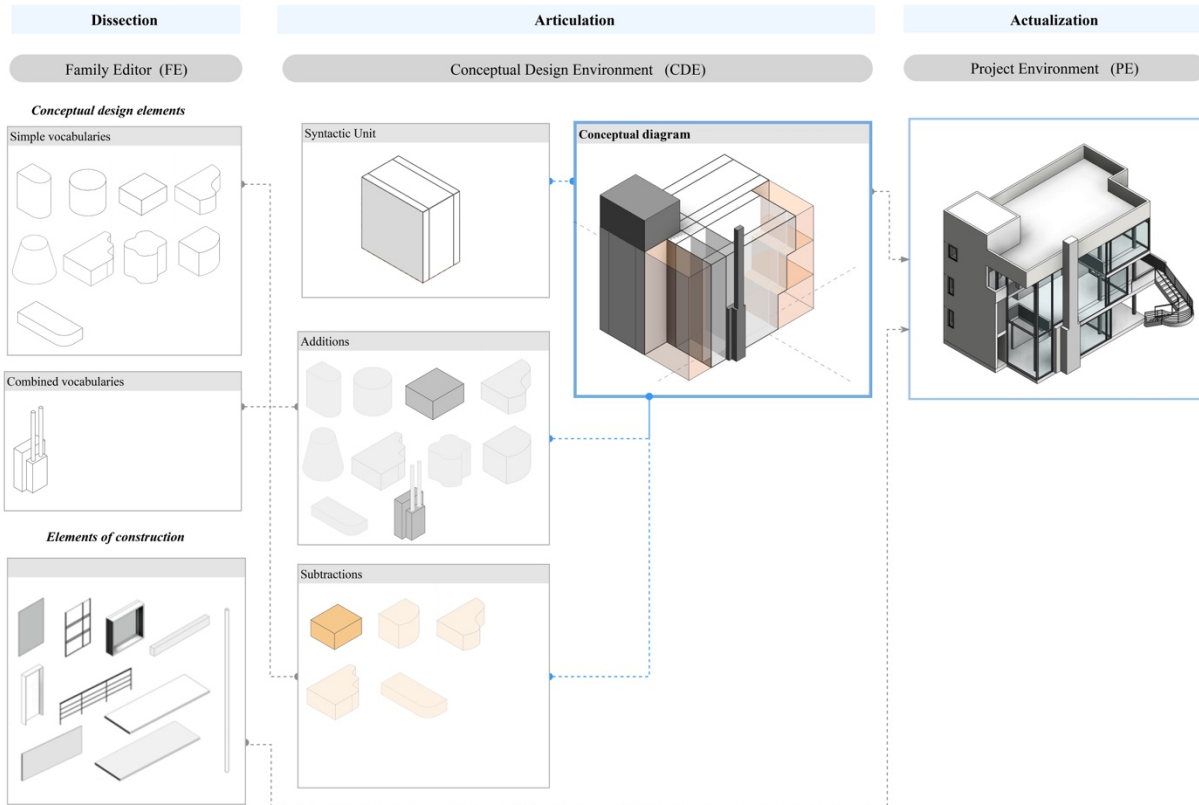
**Figure 25** The process of modeling the Douglass House in AIM

#### ***4.2.3. Options generation***

This stage explores the range of design alternatives that can be generated from the BIM model of the Douglas House. First, the exploration focuses on creating several options that have Meier’s formal language. These options include the Smith House, which was designed by Meier, as well as other houses that were not designed by Meier. Second, creating other formal languages or *stylistic change* was also explored through creating a design option that has a different formal language.

#### *4.2.3.1. Smith House by Meier*

Many of Meier's houses shared the same underlying formal logic: two paradoxical rectangular prisms, a spatial layering system and two perpendicular axes that are composed into one conceptual diagram and animated by additions and subtractions. This formal logic is present in the Smith House which constitutes a prior version of the Douglas House. The same BIM model of the Douglas House was used to create the Smith House. The width and length parameters of the public, private, and roof masses were changed. The width parameter of the spatial layers and axes was adjusted too. From Meir's library of conceptual design elements (Table 3), the curvilinear voids were replaced by rectangular ones. The parameters and the visibility of elements in the chimney family were altered. Then, the transformed conceptual diagram was reloaded to the same project file of the Douglas House to replace the old conceptual diagram and overwrite its parameters. The walls, floors, and roof were all updated to reflect the changes in the conceptual diagram. A few other modifications were performed in the PE to adjust windows, doors and other details in the model (Figure 26).



**Figure 26 The process of modeling the Smith House in AIM**

#### *4.2.3.2. Other Houses in Meier's Language*

In the same direction of the case of the Smith House, the generative potential of the model was explored further. To create new houses that have Meier's formal language, the parameters in Table 4 were altered, and accordingly, the conceptual diagram and its parameters were altered too. To animate the main conceptual mass, each architectural expression investigated a different way to exploit Meier's operations of subtraction and addition (Figures 27 - 32). Consequently, each of the generated architectural expression maintains a consistent formal language that emerged from having a predefined library and syntactic framework. In this

exploration, the explicit representation of an architectural language significantly aids and facilitates the creation of architectural expressions that are grammatically precise.

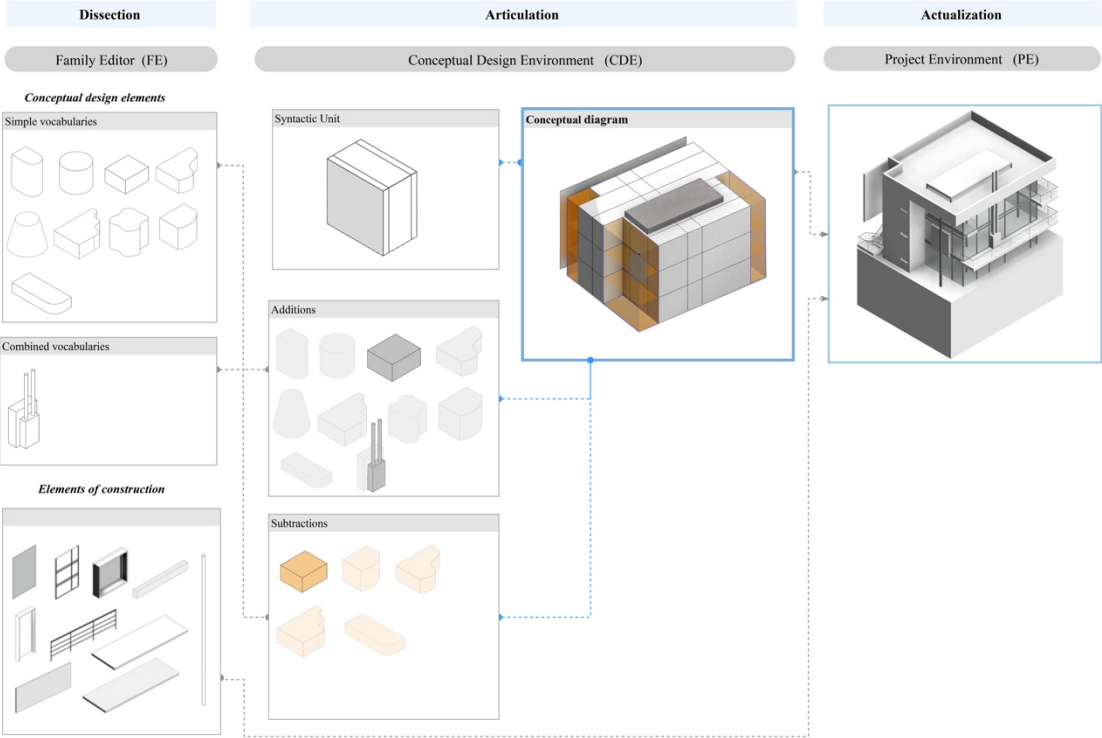
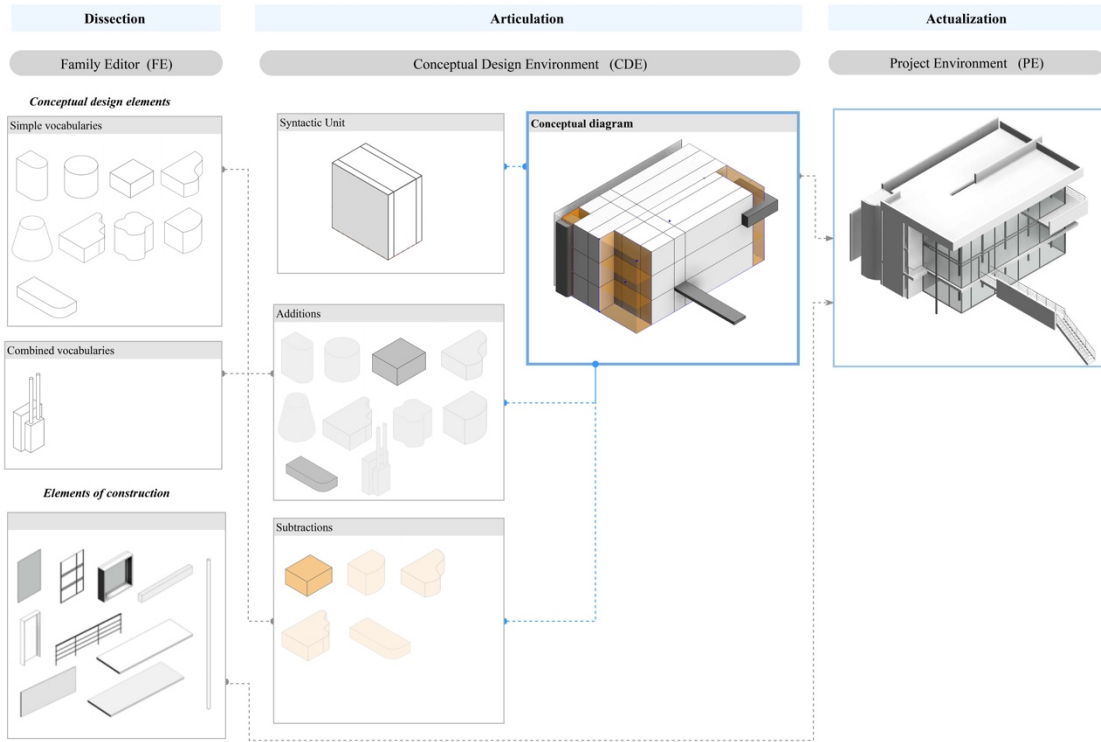
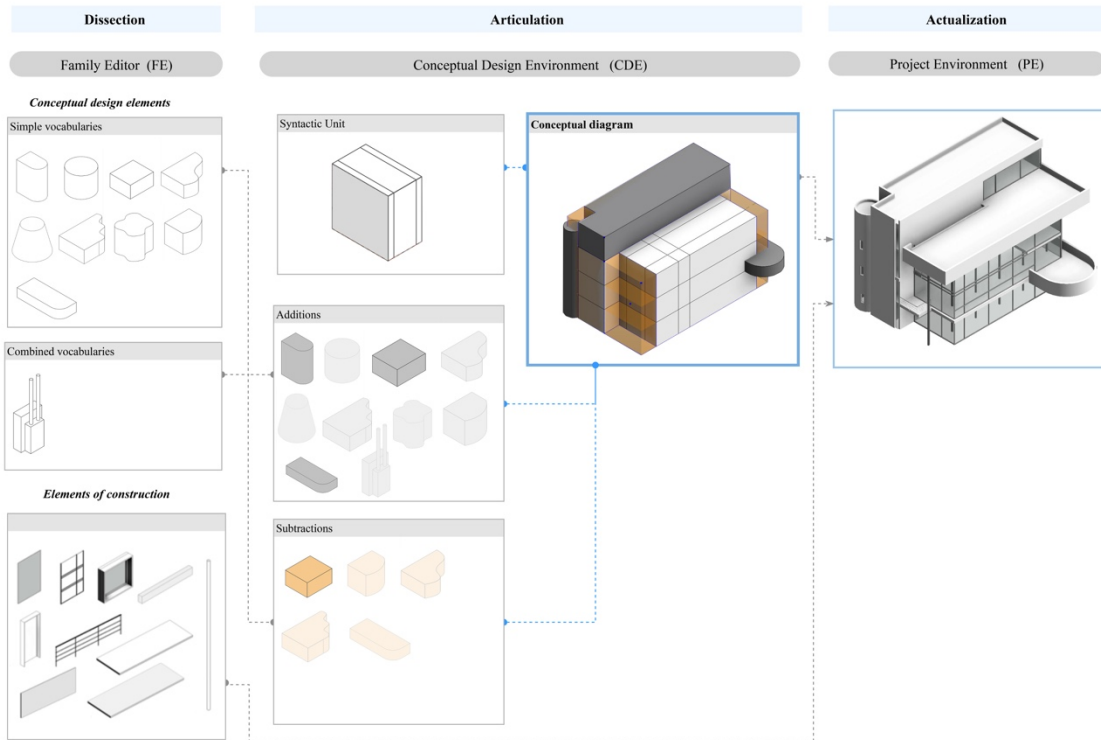


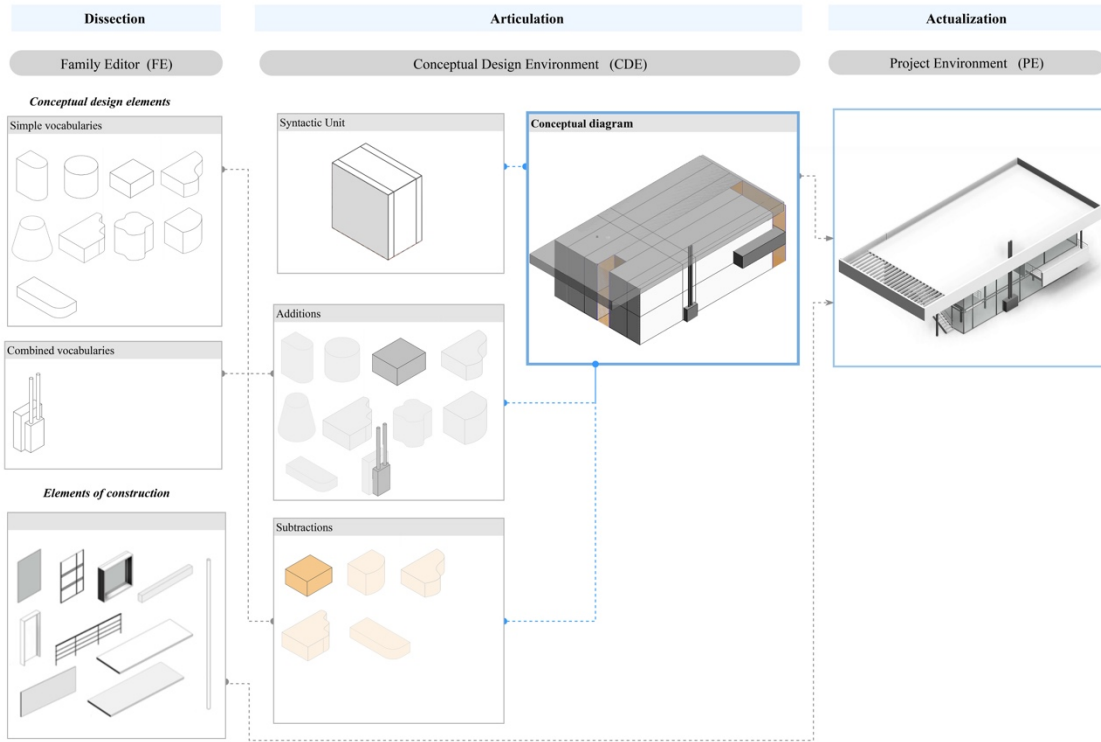
Figure 27 Other houses in Meier’s language: Option 1



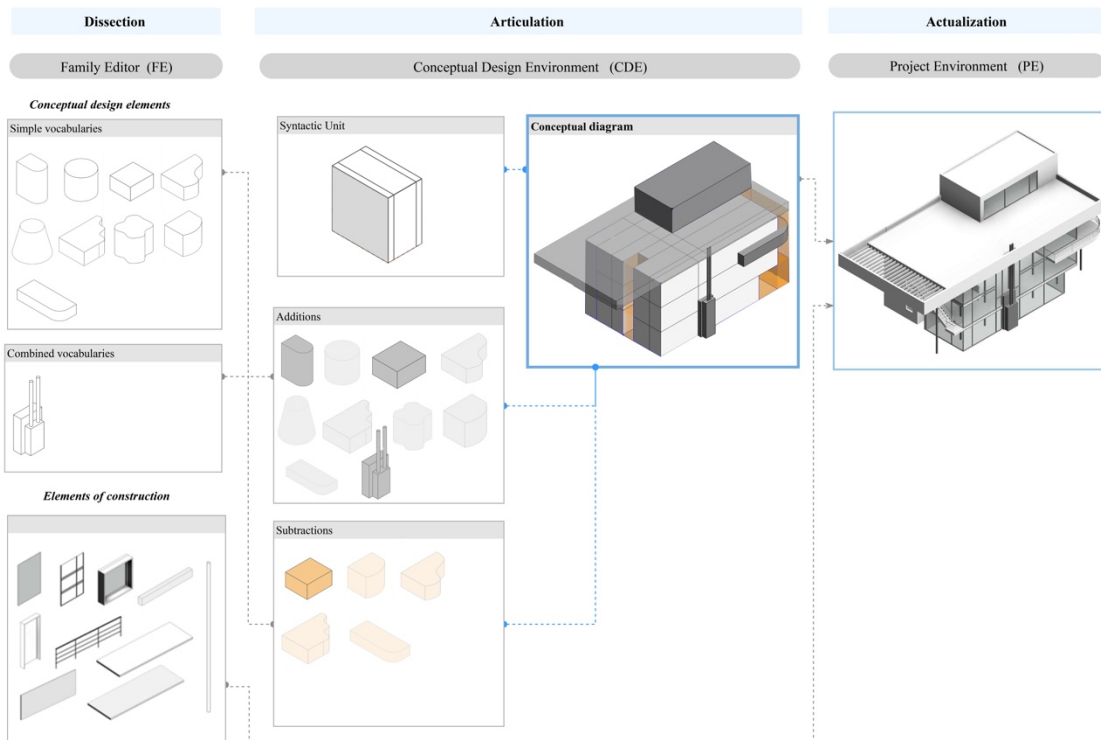
**Figure 28 Other houses in Meier's language: Option 2**



**Figure 29 Other houses in Meier's language: Option 3**

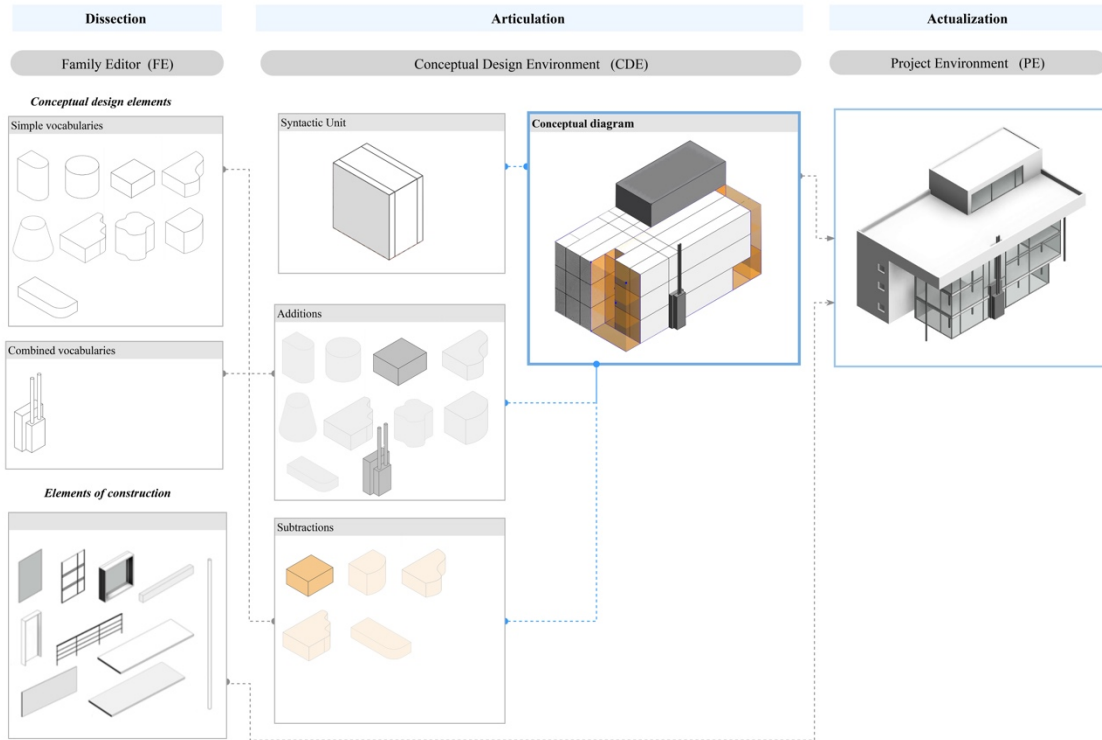


**Figure 30 Other houses in Meier's language: Option 4**



**Figure 31 Other houses in Meier's language: Option 5**





**Figure 32 Other houses in Meier’s language: Option 6**

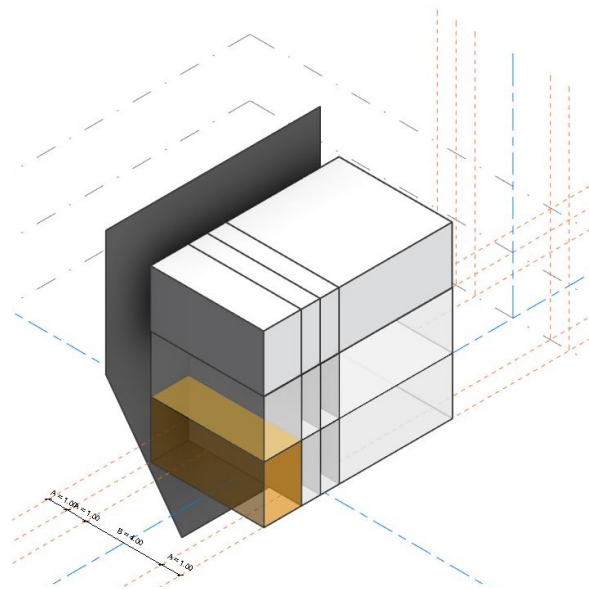
#### 4.2.3.3. Stylistic Change

Another way to explore the generative potentials of the Douglas House model is *stylistic change*. This involves creating new design options that have new formal languages. A new design option was created by changing the design rules and vocabularies as follows (Figure 33, Figure 34).

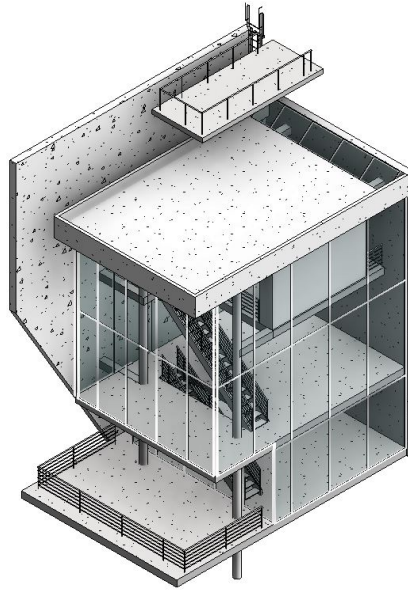
The relationship between the two adjacent masses (public and private) was changed. The private mass was placed on the top of the public mass, and the height constraint was removed. The duality between the opaque private façade and transparent public façade was changed into transparent front and right facades, and opaque back and left facades. The spatial layering in the transverse direction was changed from A-B-A system into A-B-B-C system. The rule of

frontality, in which the frontal façade is wider than side one, was removed. Furthermore, the rule of using additions to animate the main mass was deleted, and it was only animated using subtractions. The entry axis was placed outside the main mass. The longitudinal axis defines the vertical circulation instead of the horizontal circulation. In terms of elements of construction, there are no windows or fenestrations. Moreover, new types of roofs, walls, beams, and mullion pattern were introduced. Table 6 shows the transformation matrix of Meier's formal language in the Douglas House. This transformation matrix includes *change*, *deletion*, and *addition* in design *rules and constraints* as well as *vocabularies*.

Further options and languages can be generated because Meier's formal language was explicitly represented using AIM. The explicit representation of rules and vocabulary allows the designer to access the design's logic and exposes unforeseen possibilities for transformation.



**Figure 33 A new design option with a new formal language – conceptual diagram in CDE**



**Figure 34 The actualization of the conceptual diagram in the Project environment (PE)**

**Table 6 The transformation matrix of Meier's formal language**

<b>Stylistic Change Matrix</b>				
<b>Rules and Constraints</b>	<b>Change</b>	<b>Delete</b>	<b>Add</b>	<b>Description</b>
3ft module				No change
Duality of public and private masses				From horizontal duality <b>to</b> vertical duality
Duality of public and private façades				Front vs back <b>to</b> front + right vs left + back
Public mass height = Private mass height				The constraint was removed
Frontality				Length > width constraint was removed
Spatial layering				From A-B-A <b>to</b> A-B-C
Additions				The rule of formal additions was removed
Subtractions				No change
Longitudinal axis				Change in location and function
Transverse axis				Change in location
<b>Vocabularies</b>	<b>Change</b>	<b>Delete</b>	<b>Add</b>	<b>Description</b>
Conceptual elements: <i>curvilinear masses</i>				Removed from the library
Conceptual elements: <i>rectangular masses</i>				No change
Conceptual elements: <i>planes</i>				Angular plan was added to the library
Windows				No windows or fenestrations
Walls				Change in material
Roofs				Change in material
Mullion pattern				The pattern was changed into a new one
Pipe railings				No change
Curtain wall				No change
Beams				Change in material + Add new type of beams
Columns				Change in material

### 4.3. AIM as a high-level design system

Based on the previous discussion in this chapter, AIM can be considered a high-level design system. A high-level design system is built upon the foundations of basic design system, but it is more powerful and specialized. It supports design within a particular architectural style (Mitchell, 1986). The following features that were discussed by Mitchell (1986) and other scholars in the field of design computing make AIM a high-level design system.

- AIM computes the formal knowledge of architecture. The three main types of design knowledge are fundamental in AIM. First, *descriptive knowledge* in AIM refers to the explicit definition of design elements and rules. Second, *normative knowledge* in AIM outlines the rationale behind the design, i.e., create a design that has a consistent formal language. Finally, *operational knowledge* represents the whole framework of A-S-G in AIM as a distinct method to select objects, assign appropriate values to them, and establish relationships and constraints to meet the specified formal language.
- AIM makes use of the theory of formal language as a demonstrably sound, and rigorously formalized theoretical foundation.
- AIM employs various *generative procedures* to create parametric design vocabularies, *transformational procedures* to parametrically control variations among design elements, and *combination procedures* to combine elements to create new ones.
- AIM supports the decomposition of designs through employing divide and conquer strategy. Designers, thus, can think about designs as a hierarchy of elements and subsystems.

- Because it is based on a BIM system, AIM can encode various types of knowledge, such as structural, environmental, construction, cost, and materials. Moreover, AIM defines the semantic properties of a formal language systematically through using text parameters, labeling, and material parameters to name and color code design elements.
- AIM utilizes CDE to support diagrammatic thinking. It establishes a robust connection between the conceptual diagram in CDE and the concrete vocabularies in PE.
- AIM supports multiple graphical representations. In design computing, good graphical representations support design by presenting appropriate tools and abstraction for each design phase and communicating design clearly to others. In AIM, the use of Revit allows the designer to use Visibility /Graphic manager to control the visibility and graphical appearance of elements. The designer can hide elements and categories, and change their color, transparency, lightweight, and line-style. In AIM, a project *template* was devised to reduce the complexity of the BIM tool through hiding unnecessary categories such as mechanical elements. Moreover, the template allows the designer to customize the graphics of the design views and diagrams to be presented consistently.
- By using Revit, AIM uses Revit incorporates a dynamic editing environment that, unlike shape grammar systems, is flexible and non-sequential. This conforms to a generally accepted understanding that design is a complex process that cannot be defined as a sequence of actions. AIM supports design development and stylistic evolution. It allows the designer to add, change, and remove elements, rules, and

- constraints throughout the design process. AIM defines an *associative design process* in which changes can be transmitted throughout a dynamic structure of dependencies.
- AIM develops a pragmatic symbiosis between the capabilities of BIM tools and designers. It does not automate design completely. It gives the designer the freedom to control the design and develop the needed parameters and constraints throughout the design process. In this partnership, the role of BIM can be altered dynamically between a free design environment to develop design ideas and a generative design environment that can produce multiple design options within a consistent formal language. Such dynamics allows the designer and the tool to respond to unforeseen challenges and changing requirements that may emerge during the design process.

#### **4.4. Summary**

This chapter described AIM, the computational framework of this research. This framework allows BIM to support conceptual design by allowing the designer to devise and represent abstractions found in architectural theory. AIM represents a shift from BIM as a technical modeling tool that employs 3D-building vocabulary into a design environment that can code architectural languages. In this chapter, the development of AIM was discussed in three sections.

The first section discussed the AIM framework according to its theoretical foundation and main components. The theory of *formal language* was selected as a theoretical foundation to support AIM because it shares many commonalities with computation theories and with the ontology of BIM tools. The three main components of AIM include *analysis*, *synthesis*, and *options generation*. In AIM, *analysis* refers to applying logical thinking, analyzing formal

systems, and employing problem-solving strategies such as divide and conquer. *Synthesis* refers to the process of describing a formal system using BIM and computational methods. This stage involves three activities: dissection, articulation, and actualization. The activity of *dissection* refers to using Family Editor (FE) to create the conceptual elements and the elements of construction. The activity of articulation utilizes Conceptual Design Environment (CDE) to create a *conceptual diagram* and establish syntactical and configurational rules between the conceptual design elements. Lastly, the activity of actualization converts the conceptual diagram into a built form. The last component of AIM development is options generation. The stage of options generation aims to explore the range of design alternatives that can be generated from a single formal model. These alternatives can have one formal language or several languages.

In this chapter, the second section discussed the work of Richard Meier as a test case to prove the viability of using Autodesk Revit to represent a formal language of widespread recognition. The formal language of Richard Meier was explored through the three main components of AIM: analysis, synthesis, and options generation. In this exploration, the Douglas House was modeled in AIM and used to create various design options. These options are the Smith House by Richard Meier, other houses that have Meier's formal language but were not created by Meier, and a house that has a new formal language. In that sense, the explicit representation of rules and vocabulary allows the designer to expose unanticipated possibilities through accessing the underlying logic of design.

The third section of this chapter discussed the features that make AIM a high-level design system. These features include: computing formal knowledge, employing generative, transformational and combination procedures, supporting decomposition, supporting diagrammatic thinking and various graphical representations, providing dynamic editing

environment, and developing a pragmatic symbiosis between the capabilities of BIM tools and designers.

The next chapter discusses the development of the pedagogical framework to teach architectural theory using AIM and the intervention study that was conducted using that pedagogical framework.



## 5. THE PEDAGOGICAL FRAMEWORK DEVELOPMENT AND VALIDATION

This chapter discusses the development of the pedagogical framework of this research. The discussion in this chapter is divided into three main sections. The first section focusses on developing the *pedagogical framework* in an educational setting. This development includes identifying the four layers of the pedagogical framework, the components of the educational setting, and the assessment techniques. The layers of the pedagogical framework are pedagogical philosophy, high-level pedagogy, pedagogical strategy, and pedagogical tactics. The educational setting is defined by identifying students, learning environment, learning tasks, and learning activity. The second section in this chapter discusses the *intervention study* that was conducted using the pedagogical framework. The third section discusses the *expert panel*. This panel reviewed and evaluated the principal outcome (i.e., student projects) of the intervention study.

### 5.1. Developing the Pedagogical Framework

Pedagogy refers to the methods and activities of educating and teaching. It is about *what* we teach and *how* we teach which rest on different epistemological and historiographical assumptions as well as cultural beliefs (Oppenheimer, 2017). Any pedagogical framework needs to be understood in relation to particular educational activity in a real educational setting. In this research, the development of the pedagogical framework relies on Goodyear's (1999, 2005) approach of educational design (Figure 6). Goodyear's (1999, 2005) approach was adopted by many scholars (Carnell & Fung, 2017; Holmberg, 2019; Jenkins et al., 2017; Sinclair, 2009) to develop various pedagogical frameworks because it provides an instrument to identify pedagogy concerning learning experiences. In that sense, the pedagogical framework of this research is

discussed according to three sections: the *pedagogical framework layers*, the *educational setting*, and *assessment*.

### ***5.1.1. The pedagogical framework layers***

According to Goodyear (1999, 2005), a pedagogical framework can be broken into four layers: pedagogical philosophy, high-level pedagogy, pedagogical strategy, and pedagogical tactics. These layers provide a well-defined structure to situate the pedagogical framework of this research.

#### *5.1.1.1. Pedagogical philosophy*

Pedagogical philosophy illustrates beliefs about knowledge and learning. It describes how we think people learn and what knowledge consists of. Although pedagogical philosophy is the first layer of any pedagogical frame, most of the time, it is left implicit or rarely discussed (Goodyear, 1999, 2005). The pedagogical philosophy used in this research draws upon the principles of *cognitivism*.

Cognitive approaches to learning see people as actively making sense of the environment through developing *mental models* and acting upon them. Knowledge is seen as a symbolic mental construction or *schema*. Cognitivism, thus, focuses on opening the *black box* of the human mind in which mental processes such as thinking, knowing, memory, and problem-solving need to be investigated. Therefore, learners should develop deeper understandings, not just produce desirable behaviors (Wortham, 2003). From this perspective, learning is grounded upon an objective view of knowledge transfer. It is an *active* mental process that develops within a learner to increase mental capacity and skills (McLeod, 2003). In cognitivism, educators

challenge students to solve problems, integrate new experiences, and develop their mental models (Wortham, 2003). Some of the researchers who have contributed to the development of cognitivism are Piaget, Bloom, Burner, and Ausubel.

#### *5.1.1.2. High-level pedagogy*

High-level pedagogy is concerned with the instantiation of philosophical positions in an educational setting. A high-level pedagogy mediates between philosophy and action. It does not contain prescriptions for actions, but it provides overarching pedagogical goals. There is a numerous number of high-level pedagogies that vary in scale, scope, complexity, and coherence. For instance, ‘problem-based learning’, ‘collaborative learning’, and ‘programmed learning’ are considered high-level pedagogies (Goodyear, 1999, 2005). The pedagogical framework in this research is framed around two related high-level pedagogies: *system thinking* and *active learning*.

The first high-level pedagogy is **system thinking**. It is related to the nature of teaching *computational design* and *formal language*. System thinking is “the scientific exploration of *wholes* and *wholeness*” (von Bertalanffy, 1972, p. xviii). Generally, a system can be defined as “*an organized whole in which parts are related together, which generates emergent properties and has some purpose*” (Skyttner, 2005, p. 58). Today in education, many educators (Arnold & Wade, 2015; Banathy & Jenlink, 2003; Cabrera et al., 2008; Mathews, Jones, Szostak, & Repko, 2008; Montana-Hoyos & Lemaitre, 2011; Skyttner, 2005; Sterling, 2003) believe that systems thinking is a well-suited approach that facilitates interdisciplinary integration and promotes critical thinking. According to Mathews et al. (2008, p. 80), “*systems thinking is a student-centered, inquiry-based approach that includes perspective-taking, holistic thinking, and belief-testing.*” In art and design

education, systems thinking has also received increasing attention. Many researchers argue that systems thinking can enhance creativity in contemporary arts and design education (Montana-Hoyos & Lemaitre, 2011). This belief emerged from the fact that design as an area of knowledge is concerned with the creation of our artificial world in form of environments or whole complex systems such as architecture. Ahlquist and Menges (2011, p. 15) stated that introducing system thinking and system theory in architecture design creates a double shift. The first shift represents a dismissal of the view of architecture as a group of isolated entities for one in which architecture is understood as the culmination of *systems* that interact together. The second shift represents introducing *computational concepts*, such as complex behavior-based systems, as an integral part of architectural thinking. Accordingly, with the help of computer-aided models, the designer can design a system with concise parameters that specify and define the behavior of that system. Likewise, Wang (2010) emphasized that introducing system thinking in design studio education can create a shift from problem solving-project based approach to system approach. Accordingly, the studio projects should be constructed not as problems with rational solutions but as systems that are defined rationally and creatively. In that sense, the design process of a system becomes the exploration of possible relations and behaviors and their creatively emergent potentialities.

To educate systems thinkers, a student needs to understand and apply four conceptual patterns: “*draw distinctions between an identity and a non-identity; recognize the bi-directional properties (affect and effect) of relationships; organize parts and wholes into alternative nested systems; and take new perspectives by transforming one’s point-and-view*” (Cabrera et al., 2008, p. 307). These patterns need to be *explicitly* expressed to know how one thinks and how one might alter and develop this thinking and gain a better understanding of one’s thought (Cabrera et al., 2008). In that sense, students as a system thinker should be able to develop *analytical* skills,

employ *logical thinking, design* and *test* solutions to problems, *identify* elements and understand *behaviors* in systems, *predict* consequences, and *devise* modifications or adjustments (Arnold & Wade, 2015).

The second high-level pedagogy is **active learning**. It is related to the nature of architecture education and the design studio culture. The design studio is artistry and problem-setting education that has focused on *learning-by-doing* as well as *project-based learning* (Schön, 1985, p. 6). Similarly, active learning pedagogies focus on *learning-by-doing* and *project-based learning* as methods to increase retention and content knowledge. These methods also promote higher-order cognitive skills, including *analyze, define, evaluate, and create*. Accordingly, active learning shifts the focus from a teaching-centered paradigm to a learner-centered paradigm in which students are involved in *doing* things and *thinking* about what they are doing. Because of this, a pedagogical framework that adopts active learning should be designed to emphasize learning outcomes that necessitate higher-order cognitive skills and thoughtful participation on the part of the student (Anderson, Mitchell, & Osgood, 2005; Roehl, Reddy, & Shannon, 2013).

The two high-level pedagogies of system thinking and active learning encourage using computational methods to understand formal language as a *formal system* with *creative* potentials. Learning-by-doing and project-based learning methods will be employed in combination with applying *higher-order cognitive skills* and *system thinking patterns*. Accordingly, in the design studio, students will be able to develop *analytical* skills and *logical thinking* to create *designs* (i.e., projects). Each project is a *formal system* in which student can *identify* elements, understand *behaviors, predict* consequences, and *devise* modifications or adjustments. The design process of such a system becomes the exploration of possible relations and behaviors and their creatively emergent potentialities.

### 5.1.1.3. Pedagogical strategy

Unlike high-level pedagogy, pedagogical strategies are concerned with outlining *actions* and intentions to achieve the overall objectives. They are broad plans of *what* should be done in accordance with high-level pedagogy to achieve particular objectives (Goodyear, 1999, 2005; Holmberg, 2019). For instance, helping students to distinguish between different types of texts is considered a pedagogical strategy while the exact method or the actual means of *how* to execute that is a pedagogical tactic (Holmberg, 2019).

Through the lens of system thinking and active learning, the pedagogical strategies of this research aim to enable students to develop *higher-order cognitive skills* and *system thinking patterns*. The cognitive processes and the measurable verbs of each process in Bloom's revised taxonomy (Table 7) are used to lead formulating the pedagogical strategies. In that sense, the pedagogical framework of this research intends to help students to achieve the following learning objectives or outcomes:

1. **Remember:** Students should be able to *define* some main theoretical and formal terms in architectural design. These terms include architecture, building, form, formal language, syntax, semantic, autonomy, transformation, and vocabulary. Moreover, students should be able to *list* and *define* several formal concepts and rules such as modularity, axuality, duality, and abstractness. Also, students should be able to *name* several formalists and notable architects and *recognize* their works.
2. **Understand:** Students should be able to *distinguish* between architecture and building and *differentiate* between BIM and CAD modeling techniques. Also, they should be able to *understand* what is a formal language, distinguish between the

- components of formal language (e.g., elements of construction and elements of composition), and *discuss* the work of several architects in terms of formal language.
3. **Apply:** Students should be able to *use* BIM tools such as Autodesk Revit and have sufficient *technical skills* in PE and CDE. These skills include *modeling* a building in PE, *constructing* a series of conceptual vocabularies in CDE, and *employing* rules and parameters in their model.
  4. **Analyze:** Students should be able to develop *analytical* skills. These skills include *deconstructing* an existing formal language and *relating* its components to AIM (BIM environments of CDE and PE). Accordingly, students should be able to *identify* the design elements, *recognize* relationships and their bi-directional properties (affect and effect), *organize* parts and wholes into nested systems, employ strategies such as divide and conquer, and *identify* the behaviors in the formal system. Furthermore, students should be able to *deconstruct* their formal language into an explicit set of elements and rules using AIM.
  5. **Evaluate:** Students should be able to *test* several methods to model a formal language using AIM and *explore* the various creative potentials of their model. Moreover, students should be able to *explore* several methods to transform an existing formal language in AIM to a new one.
  6. **Create:** At the end, students should be able to *synthesize* what they have learned about formal language and BIM to use AIM to *create* designs that are parametrically controlled. This stage may include three *activities*. First, students should be able to *create* a design that has an explicitly defined formal language in BIM. Second, students should be able to *generate* several design options. Third, students should be

able to transform a formal language to create a new one. Although creation is considered the highest cognitive skill, this pedagogical framework distinguishes three *levels* of this skill. The first level represents creating a single design option that has a defined and consistent formal language. The second level represents generating several design options, but either each option has its formal language, or the formal language of each new option is an iteration of the previous one. The third and highest level represents generating design options that share the same formal language.

#### *5.1.1.4. Pedagogical tactics*

Pedagogical tactics are concerned with specific detailed methods or the actual means to execute pedagogical strategies and set educational tasks for students (Goodyear, 1999, 2005).

The pedagogical tactics in this framework include:


1. *Lectures* to provide students with the necessary theoretical knowledge and explain fundamental concepts such as formal language, architecture, building, BIM, and AIM.
2. *Interactive lectures* and *in-class discussion* to encourage students to participate in activities such as classifying examples as building or architecture, analyzing their formal languages, and discussing the possible transformation processes to transform one formal language to another.
3. *Computer-based tutorials*: This includes workshops to use AIM, Revit online-tutorials, handouts, and original tutorials created for the course and shared via video-sharing websites (e.g., YouTube).
4. *Group work* (team exercise) to conduct a precedent study and analysis.
5. *Encourage collaboration between students*.



6. Written and verbal *feedback* during the informal pin-ups and design reviews.
7. *Resource sharing*: use Google Drive to share resources such as readings, lectures, or Revit file. Google Drive should be organized by topic or weeks to keep a record of the course and help students to find and archive resources easily.
8. *Design problem to solve (projects)*.

Table 7 aligns the pedagogical strategies and tactics with Bloom’s revised taxonomy.

**Table 7 Bloom’s revised taxonomy of cognitive skills and AIM**

<i>higher cognitive skills</i> 	The cognitive process dimension	The Knowledge dimension	A measurable verb	Associated skills from the literature	In AIM framework	
					Strategies	Tactics
<b>Create</b>	Metacognitive	Create	Designing, Programming, Planning, Inventing, Mixing, <b>Synthesis, Generating, Transforming, Simulating, Optimizing</b>	6	Design problem to solve (project), Feedbacks, Open learning environment	
	Procedural	Design				
	Conceptual	Assemble				
	Factual	Generate				
<b>Evaluate</b>	Metacognitive	Reflect	Reviewing, Collaborating, Testing, Experimenting, Detecting, Critiquing, Rating, Exploring	5	Design problem to solve (project), Feedbacks	
	Procedural	Judge				
	Conceptual	Determine				
	Factual	Check				
<b>Analyze</b>	Metacognitive	Deconstruct	Categorizing, Reverse Engineering, Comparing, Organizing, Deconstructing, Outlining, Finding	4	Design problem to solve (project), Precedent analysis, Feedbacks	
	Procedural	Integrate				
	Conceptual	Differentiate				
	Factual	Select				
<b>Apply</b>	Metacognitive	Use	Implementing, Choosing, Executing, Using, Running, Loading, Operating, Editing, Applying, <b>Modeling, Drafting</b>	3	Computer-based tutorials: Online, Workshops, and Handouts, Modeling exercise, Encourage collaboration between students	
	Procedural	Carry Out				
	Conceptual	Provide				
	Factual	Respond				

<i>lower cognitive skills</i>	<b>Understand</b>	Metacognitive	Predict	Discussing, Identifying, Summarizing, Classifying, Comparing, Explaining, Categorizing, Describing	2	Lectures, Interactive lectures (discussion), Readings, Group work, Precedent study
		Procedural	Clarify			
		Conceptual	Classify			
		Factual	Summarize			
	<b>Remember</b>	Metacognitive	Identify	Defining, Listing, Searching, Describing, Naming, Retrieving, Locating, Finding	1	Lectures, Readings
		Procedural	Recall			
		Conceptual	Recognize			
		Factual	List			

### 5.1.2. Educational setting

#### 5.1.2.1. Students

This pedagogical framework can be taught to architecture students at any level. The level of complexity of this framework can be adjusted according to student level. For instance, graduate students can focus on developing formal languages in addition to incorporating other topics such as building performance, optimization, and collaboration. Moreover, second-year undergraduate students can focus on developing formal languages to understand fundamental formal concepts.

#### 5.1.2.2. Learning environment

A learning environment includes all the *tools* and *resources* to reach the goals of the pedagogical framework. It can be a physical or digital environment (Goodyear, 2005). The following are the needed tools and resources to implement AIM in a design studio:

1. *Digital tools and software*: Autodesk Revit Architecture<sup>®</sup>, Enscape<sup>®</sup> (real-time rendering and virtual reality for Revit), Google Drive<sup>®</sup> (online file storage service for communication and collaboration) and YouTube<sup>®</sup> (video sharing website) and personal laptop computers.
2. *Learning spaces*: design studio, lecture space, computer lab, and review space.
3. *Library and digital database access*: Online tutorials by Autodesk<sup>®</sup>, Revit tutorial from YouTube<sup>®</sup>, new tutorials for AIM shared with students through YouTube<sup>®</sup>, and support reading materials.

#### 5.1.2.3. *Learning tasks and learning activity*

Learning tasks refer to specific learning outcomes, such as essays and artifacts. A learning activity refers to students' response to a learning task which typically is constrained by other tasks, their knowledge, as well as the other calls on their time (Goodyear, 2005). The primary learning task of this pedagogical framework is a design problem to solve (i.e., design project). A design studio can be structured around one or more of the following design problems:

1. Model the formal language of a known architect using AIM and generate other projects that were created by the same architect.
2. Model the formal language of a known architect using AIM and generate *new* projects that have the same formal language of that architect.
3. *Transform* the formal language of an existing model that was created using AIM to create new projects that have *new* formal language.
4. Develop an entirely *new* formal language and explore the creative potentials of that language.

The previous design problems can be accompanied by several supportive exercises such as modeling exercise, precedent study exercise, and essays or *written criticism* of the design projects. The modeling exercise aims to help students to learn the basics of Revit. The precedent study exercise aims to help students to develop their analytical skills and introduce new formal languages to them. The essay exercise aims to utilize what students learned from readings and lectures to describe the design process and the formal concepts they employed in their projects. In terms of learning activity, student interpretations of learning tasks can be collected using various methods such as *observations* and *surveys*. Collecting this data helps the instructor to update the framework to accommodate any unforeseen circumstances such as students' lack of essential knowledge and skills.

### **5.1.3. Assessment**

Assessment is the process in which instructors gather data about students' learning through various techniques such as pre-tests, observations, and examinations (Hanna & Dettmer, 2004). This framework employs three types of assessments:

1. A *diagnostic assessment* that takes place *before* teaching starts to identify students' current knowledge and skills (Hanna & Dettmer, 2004). The diagnostic assessment of this framework can be conducted through various methods such as a *discussion* with students or an exam to identify their current knowledge of computation and digital design tools.
2. An informal *formative assessment* that takes place *during* the teaching process to provide feedback on students' progress and instructor progress (Hanna & Dettmer, 2004). The *formative assessment* of this framework can be conducted through

*observations* during in-studio activities, a *one-on-one discussion* between instructor and student, and *informal pin-up reviews*.

3. A *summative assessment* that takes place *after* the teaching process has been completed to focus on the completion of projects (Hanna & Dettmer, 2004). The *summative assessment* of this framework can be conducted by evaluating the learning outcomes.

## **5.2. The Intervention Study**

This intervention study is a quasi-experiment that aims to study the impact of implementing AIM in a design studio and validate its usefulness to support conceptual design. Also, it focuses on overcoming the difficulties of using BIM in early design stages through integrating design fundamentals and computational concepts. This study offers a new teaching agenda that integrates form-centric and BIM-centric agendas.

In the fall semester of 2018, the study took place in the second year of a four-year Bachelor of Environmental Design (B.E.D) at Texas A&M University. Three design studios from ARCH 205 Architecture Design I course participated in this study. ARCH 205 is a four credits studio for second-year students that emphasizes functional planning, spatial ordering, the logic of form generation, and modeling techniques. The duration of the study was eleven weeks.

### ***5.2.1. Students and staffing***

Three design studios participated in this study. The three studios had 48 students in total. Forty students agreed to join this study. Most students of ARCH 205 had no previous knowledge in computing and in digital tools and especially Revit. According to the curriculum of B.E.D

program, the students of ARCH 205 were introduced to visual and functional design principles, spatial understanding in proportion to the scale of a human body, and graphic communication methods in ARCH 205 prerequisites (ENDS 105, ENDS 108, ENDS 115).

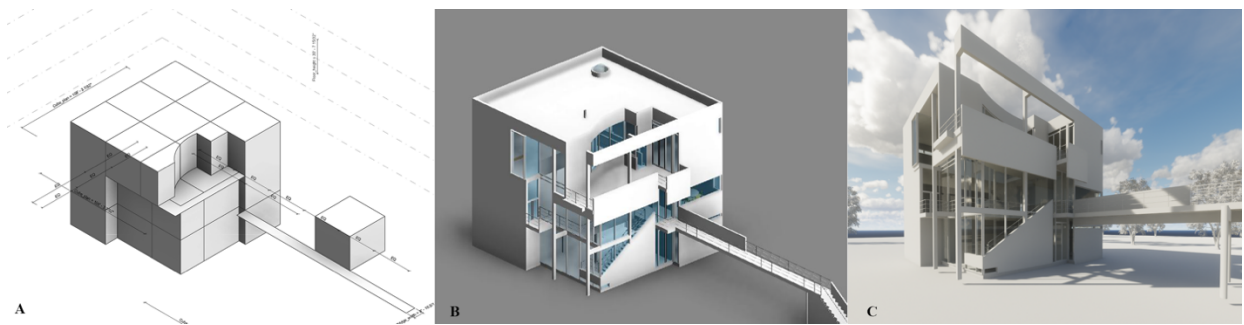
The studios were taught by two instructors: the author of this dissertation (i.e., first instructor) and the second instructor. In addition, as specified in the IRB application, the Principle Investigator of the study, Mark J. Clayton (William M. Peña Professor of Information Management, Department of Architecture), supervised the intervention study.

### ***5.2.2. Learning environment***

The following are the tools and resources that were used to implement AIM in this study:

1. Digital tools and software:
  - a. Autodesk Revit Architecture: The BIM tool used in this research
  - b. Enscape: A real-time rendering that offers virtual reality experience in Revit (Figure 35).
  - c. Qualtrics: An online survey platform to collect data from students and their feedback on the study.
  - d. Google Drive: An online file storage service for communication and collaboration. The Drive of the studio was organized according to the number of weeks.
  - e. YouTube: A video-sharing website to share online tutorials to use Revit and other tutorials created for this study.
  - f. Personal laptops.

2. Learning spaces: Figure 5 illustrates the four types of learning spaces that were used. These spaces are a design studio, lecture space, computer lab, and exhibition and review space.
3. Library and digital database access: Online tutorials by Autodesk, Revit tutorial from YouTube, new tutorials for AIM shared with students through YouTube®, and support reading materials from TAMU library.



**Figure 35 Hanselmann House by Michael Graves in AIM. A: the conceptual mass in CDE in Revit, B: The Built form in PE in Revit, C: Virtual reality experience of the house in Enscape**

### *5.2.3. Learning tasks and activities*

All three studios were structured around three main design problems. Other tasks, such as precedent study, modeling exercise, and writing essays, were also introduced. In addition to the design problems, several lectures, readings, and workshops were part of the studios (

Table 8). The studios were structured in three parts as follows:

In the first part, which lasted three weeks, students were asked first to conduct a **precedent study** (appendix VII). This task focused on the analysis and the interpretation of built form to help students to understand diverse ways that principle might be applied in their projects.

The analysis focused only on the formal aspects of architectural form. It aimed to introduce several architects and their formal languages, and, also, to allow students to develop their analytical skills. In this task, students were asked to form a small group of three to four students to work on the analysis. Each studio had four student groups. A list of houses, created by notable architects, were provided. Each group was assigned ten houses to analyze. Each student in the group had to select a house and conduct a comprehensive formal analysis of that house. As a group, all students were required to briefly study all the ten houses and discuss at least three formal issues in each house. Students also had a **modeling exercise**. This modeling task focused on using Revit Architecture to model an existing house. It aimed to equip students with the needed technical skills to use Revit. Each student modeled the house they analyzed in the previous task. Weekly **online tutorials** were shared with students. At the webpage of Autodesk Design Academy, students had to finish all the three training levels: beginner, intermediate, and advanced. Because these tutorials focus heavily on the project environment (PE), additional tutorials that address CDE and FE in Revit were provided. Moreover, during these three weeks, students took five 45-minute **lectures**. The lectures covered the following topics: The differences between building and architecture, what is architectural design, discussion of the different schools of thought in architecture, the relationship between architecture and language, what is a formal language, architectural form and autonomy in architecture, the elements of construction and the elements of composition in a formal language, design syntax and configuration, content of form, what is BIM, and the differences between BIM and other approaches such as CAD systems. At this stage, no connection was made between the theory and the tool. The lectures and tutorials were taught separately. In addition to lectures, students had a weekly **reading assignment**. The three reading assignments focus upon formal analysis (Simitch & Warke, 2014),



and the formal language of NY5 (Deamer, 2001; Gandelsonas & Morton, 1972). In the third week, students were asked to employ what they learned from the lectures and the tutorials to **design** a single-family house (project 1) using Revit. In this design problem (Appendix IX), students were provided with a design brief and constraints which include a maximum area of 2500 square feet, a maximum height of 30 feet, a program, and setbacks. Students were also asked to write an **essay** describing their design. Lastly, after submitting their designs, students took the first **survey** of this study (appendix II).

In the second part, which lasted four weeks, students worked on the second **design** problem (project 2). In this design problem, students were asked to use AIM to design a new house that has the formal language of Richard Meier. Then, students had to generate another three houses that also have Meier's formal language. Students were provided with six functional scenarios that can guide them to generate various design options and achieve diversity among these options (appendix X). In addition to this design task, students took four 45-minute **lectures**. The lectures focused upon the relationship between the theory of formal language and BIM using AIM. Moreover, the formal language of Richard Meier was discussed extensively in these lectures. The lectures were supported by two **reading** assignments. The reading assignments focus upon Meier's formal language (Dahabreh, 2013), and the use of AIM to represent that language (Al-Assaf & Clayton, 2017). Additionally, students had two **workshops** in which they learned using AIM to encode Meier's formal language as well as using a template in Revit to unify the graphics of their projects. Although the curriculum of Bachelor of Environmental Design (B.E.D) program stated that the students of ARCH 205 were introduced to functional design principles and spatial understanding of proportion to the scale of a human body in previous courses, most students did not show much knowledge retention of these topics. The

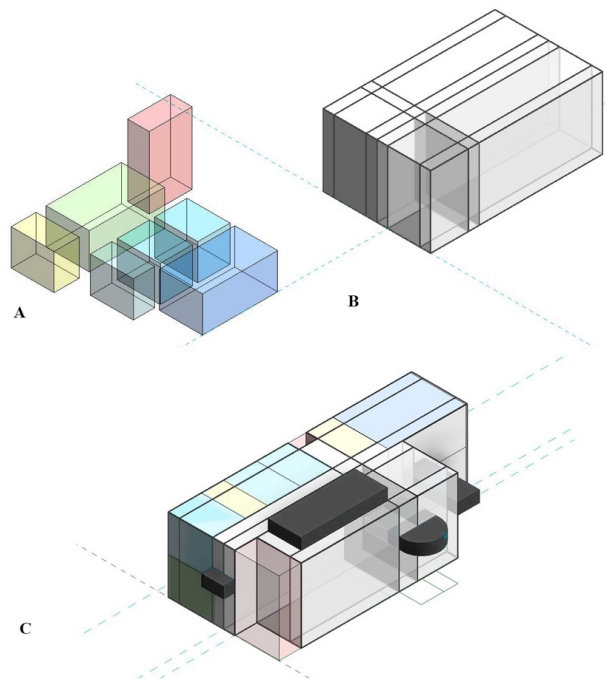
lack of basic knowledge in this area appeared clearly during this project. Therefore, in the second workshop, AIM was **updated** to include spatial planning families (Figure 36). In addition to the two workshops, students were provided with several **handouts** that address advanced modeling strategies (M. Kim, Kirby, & Krygiel, 2016) and other AIM modeling techniques. Although in this part most students used the first three weeks to learn AIM and design only one house, they designed the other three houses in the last week. Lastly, after students submitted their designs, they were asked to take the second **survey** of this study (appendix II).

In the third part, which lasted four weeks, students worked on the third **design** problem (project 3). In this design problem, students were asked to develop their own formal language and design another four houses. The new houses should be created by transforming the formal language of Richard Meier from project 2. Students were provided with two sites that have different topography. Additionally, the same six functional scenarios from project 2 were used to generate various design options. Each student thus was required to submit a **transformation matrix** that explicitly states the transformational process they took to transform Meier's formal language (appendix XI). Additionally, students took three 45-minute **lectures**. The lectures discussed various methods to transform an existing formal language, benefits of BIM, building performance, and dynamic facades. There were no reading assignments during these four weeks. However, students were encouraged to search and read about other architects that might influence the development of their formal language. Many students read about Frank Lloyd Wright, Louis Kahn, Richard Neutra, Charles Gwathmey, and Daniel Libeskind, to name a few. Furthermore, students had a **workshop** in which they learned additional modeling strategies. The workshop aimed to help students to expand their formal language and include additional elements of construction and elements of composition. Lastly, students were also asked to write

an **essay** describing their design and take the last **survey** of this study. Although the duration of this part was four weeks, most students had low productivity level in the first two weeks because they had conflicts with other courses. They were only productive in the last two weeks.

In this study, the first instructor coordinated the three studios. Also, the first instructor gave all the lectures and the workshops for the three studios. In terms of the time spent with students for discussion and feedback, the first instructor taught one studio while the second instructor taught the other two studios. Both instructors collaborated and had regular meetings to discuss students' learning progress in the three studios.

Table 8 shows the studio timeline and the required tasks and activities.



**Figure 36 Update AIM to include spatial planning families. A: spatial planning families with color, name, height, width, area, and level parameters. [ red: vertical circulation, green: kitchen, yellow: bathroom, blue: master bedroom, cyan: bedroom]. B: the main mass. C: a conceptual design that uses the main mass in addition to the spatial planning families**

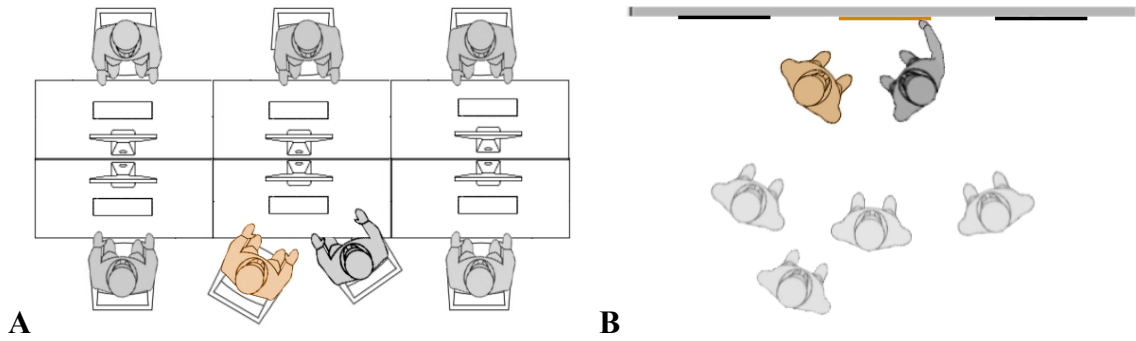
**Table 8 Studio timeline – An eleven-week intervention study**

Tasks and Activities	1	2	3	4	5	6	7	8	9	10	11
Lectures: Design theories and formal language	█	█	█	█							
Lectures: BIM			█					█	█		
Lectures: AIM				█	█						
Lectures: Formal language transformation								█			
Readings	█	█	█	█	█						
Precedent study	█	█									
Modeling exercise using Revit	█	█									
Project 1: Design a House		█	█								
Project 2: Four houses in Meier’s formal language				█	█	█	█				
Project 3: Four houses in a new formal language								█	█	█	█
Studio discussion and feedback	█	█	█	█	█	█	█	█	█	█	█
Formal reviews			●				●				●
Informal reviews (pin-ups)					●				●		
Survey 1			●								
Survey 2							●				
Survey 3											●
Update AIM to include spatial planning families						●					
Essay for project 1			●								
Essay for project 3											●
BIM online-tutorials	█	█	█								
Handouts				█	█						
Workshops				█		█			█		

#### **5.2.4. Assessment**

This intervention study employed three types of assessments:

1. **Diagnostic assessment:** It was conducted as a discussion with students on the first day of class. Students were informally asked about their current knowledge of computation and digital design tools. Most students stated that they do not know how to work with BIM (Revit). Furthermore, more than 85% of the students did not have knowledge of computation. Each studio had two or three students who learned Rhinoceros and Grasshopper (a visual programming language in Rhino) in a previous course.
2. **Formative assessment:** During the teaching process, formative assessments took place to improve student's learning progress, identify any misconception, and check areas for improvements. First, observation and feedback in the studio were used to trace students' learning progress (Figure 37-A). For instance, in project 2, the observation showed that most students were having a problem understanding scale and coordinating the conceptual diagram and spatial planning. Accordingly, AIM families were updated to include new spatial planning families. Second, the discussion with students during the formal reviews and the informal reviews (pin-ups) helped to reflect on student's learning progress and uncover their understanding and mastery of skills. It also provided feedback to improve AIM as well as the teaching practice (Figure 37-B).



**Figure 37 A: Feedback in the studio as a dialogue between tutor (in orange) and student (in gray). B: Informal Pin-ups**

3. Summative assessment: After completing the study, a summative assessment was conducted to focus on evaluating the outcome of this study. Students' projects were evaluated by an expert panel, and the written descriptions were evaluated through content analysis. The results of the expert panel and the content analysis are discussed in chapter 6. Although grades are usually used for summative assessment, in this research, grades were not used because they are protected by the Family Educational Rights Act (FERPA).

### **5.3. The Expert Panel (Focus Group)**

The expert panel was conducted with three design studio faculty from three different institutions: Awilda Rodriguez from Oklahoma State University, Vincent Canizaro from the University of Texas at San Antonio, and Ward Wells from Texas A&M University. The panel was charged with analyzing and assessing the projects created by students during the intervention study. Moreover, the panel was intended to engage the experts in the research through discussing

AIM after reviewing all projects and suggesting possible improvements for AIM as well as its pedagogical framework.

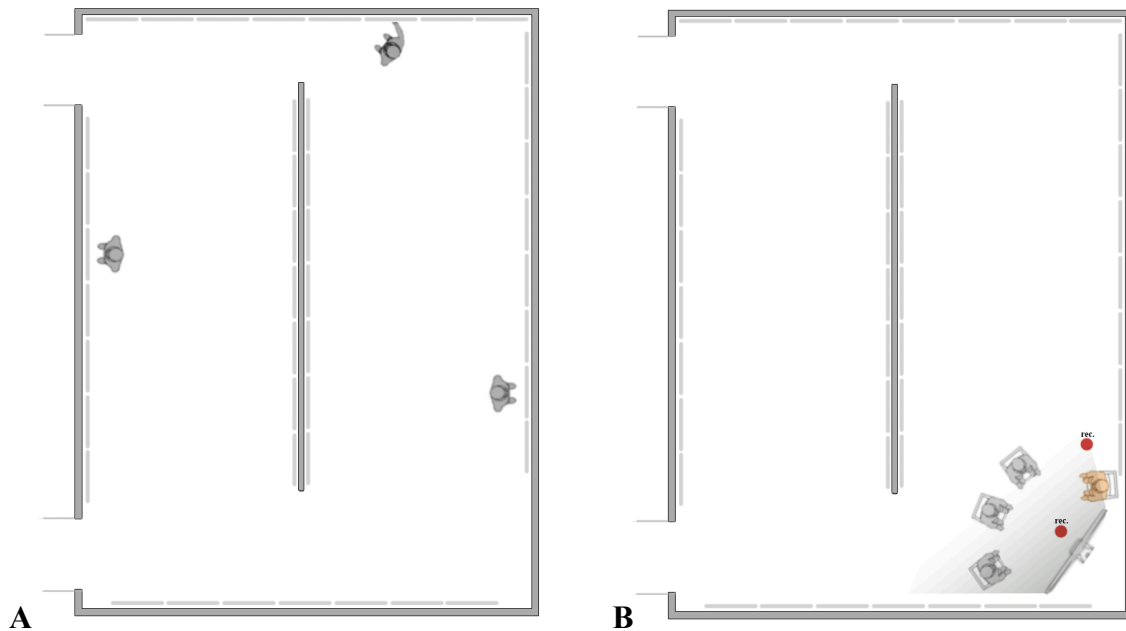
The expert panel lasted for two days (Table 9). First, the moderator (the author) started by introducing herself and then explained project 1 and the *blind jury* review process. Then, each expert was provided a project assessment survey that contained an evaluation sheet for each project. Experts were asked to review all projects in terms of design qualities and formal knowledge. Thus, no information was provided about the teaching method or the digital tool during the review process. The 38 projects that students created in project 1 were exhibited in the review space, and the experts spent two hours and a half to review them. Since project 2 focused on Richard Meier's formal language, the author gave a short presentation that explained Meier's formal language and familiarized the expert with it. Afterward, the author explained project 2 and asked the experts to review it using the project assessment survey of project 2. The 152 projects created by 38 students were exhibited in the review space, and the experts spent five hours to review them. At the end of the first day, the moderator (the author) conducted the first discussion session to collect data about project 1 and 2. It lasted for one hour and thirty minutes.

In the next day, the author started by explaining project 3 and asked the experts to review it using the project assessment survey of project 3. The 152 projects created by 38 students were exhibited in the review space and the experts spent six hours to review them. Afterward, the moderator (the author) conducted the second discussion session to collect data about project 3 and compare it to project 1 and 2. Before the end of the discussion session, the moderator gave a presentation about AIM and how it was applied in the three design studios. Then, the experts were asked about their opinion of AIM. The discussion session lasted for two hours and forty-seven minutes. Furthermore, the experts were asked to contribute to the research by suggesting

possible improvements and other areas to explore. Figure 38 shows the layout of the review space during the blind jury review process and during the discussion sessions.

**Table 9 The timeline of the expert panel**

	9:00	10:00	11:00	12:00	1:00	2:00	3:00	4:00	5:00	6:00
<b>Day One</b>										
Introduction	█									
Review of project 1 (38 projects)		█	█	█						
Presentation: Meier's formal language				●						
Review of project 2 (152 projects)					█	█	█	█	█	
Discussion (1)										█
<b>Day Two</b>										
Review of project 3 (152 projects)	█	█	█	█	█	█				
Discussion (2)							█	█	█	
Presentation: AIM								●		



**Figure 38 The expert panel. A: The review process of projects. B: The discussion sessions (experts in gray, the moderator in orange, recorder in red).**





**Figure 39 The expert panel. (from left to right): Vincent Canizaro, Awilda Rodriguez, and Ward Wells**

In the **review process**, the same template was used for all projects: project 1 (Figure 40), project 2 (Figure 41), and project 3 (Figure 42). In this template, all projects were de-identified and, students' names were replaced by coded entry. Moreover, all projects had the same graphic styles and layout, enabling expert panelists to focus on architectural quality in assessing designs and eliminate the differences among students in graphic ability. Furthermore, the use of the same template to review a large number of projects was expected to speed the review process and reduce the time needed to interpret drawings and different presentations.

In the **project assessment survey** of each project, the experts were asked to answer the same three question in addition to write notes for all the houses created by each student (Figure 43, Figure 44, Figure 45). The first question addresses the formal qualities of the house. In this question, formal qualities are concerned with the aesthetic appreciation of form (Carlson, 1979). According to Carlson (1979, p. 100), formalism holds that “an object is aesthetically good in

virtue of having formal qualities such as unity and balance – or more sophisticated variations such as ‘organic unity’ or ‘variety in unity’ - and aesthetically bad in virtue of having formal qualities such as disharmony or lack of integration.” The other two questions focus on formal language. In these two questions:

- Score 1 indicates the absence of any formal language.
- Score 3 indicates that each house has a defined formal language, but there are some differences between the formal language of each house. For instance, the formal language of house 2 is an iteration of the formal language of house 1.
- Score 5 indicates that all four houses share the *same* formal language.

The **discussion sessions** followed a semi-structured protocol. The first discussion session addressed project 1 and 2 through the following questions:

- What do you think about the projects that we saw today? Which projects impressed you?
- When we compare project 2 to project 1, how would you evaluate students’ ability to express formal knowledge in design?
- In project 2, do you think students were able to create houses that follow the formal language of Richard Meier? What are your thoughts on the range of variation and complexity of architectural forms?
- In project 2, we can categorize student projects into three categories: (1) Category one: Projects that represent Meier or very close to Meier. (2) Category Two: Projects that missed more than one aspect of Meier’s formal language; however, they still have *a* language. (3) Category three: Projects that do not have a clear or defined formal language. What are your thoughts on each category?

- In your opinion, in what ways was the use of precedents such as Meier’s formal language helpful or valuable to students?

The following discussion addressed project 3, compared all three projects together, and asked for the experts’ opinion about AIM through the following questions:

- What do you think about the projects that we saw today? Which projects impressed you?
- When we compare project 3 to project 2 and 1, how would you evaluate students’ ability to express formal knowledge in design?
- In project 3, do you think students were able to develop a creative synthesis (or formal structure)? What do you think about the variety of formal languages in project 3? Would you categorize these projects? How?
- In your opinion, what are the things that students learned from project 2 and applied to project 3?
- Do you see a value of using abstract diagrams that establish a direct connection between the abstract and real? What value?
- What are your thoughts on requiring students to generate multiple design options?
- What do you think about the commonality of the presentation?
- What do you think about AIM as a framework that allows designers to use BIM to aid design thinking and support formal expression?

Following the expert panel, the recordings were transcribed. The transcriptions were structured around the answers to the previously mentioned questions. Then, they were organized around the emergent themes related to the goals of this research. The results of the expert panel are discussed in the next chapter.

PROJECT1 - HOUSE1

BD009871

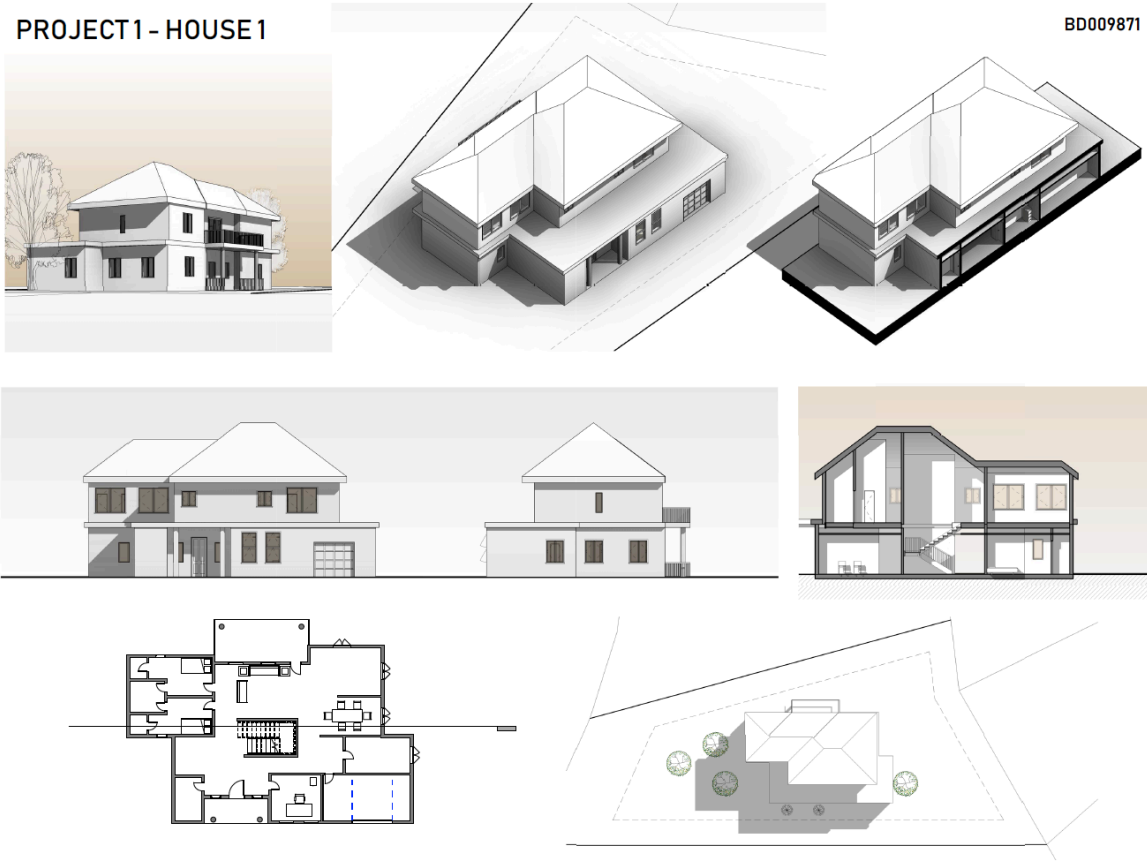


Figure 40 The template of project 1

# PROJECT 2 - HOUSE 4

BC007631

Private ■ Public ■ Roof 2 rectangles ■



Figure 41 The template of project 2

# HOUSE 4 PROJECT 3

HL005481

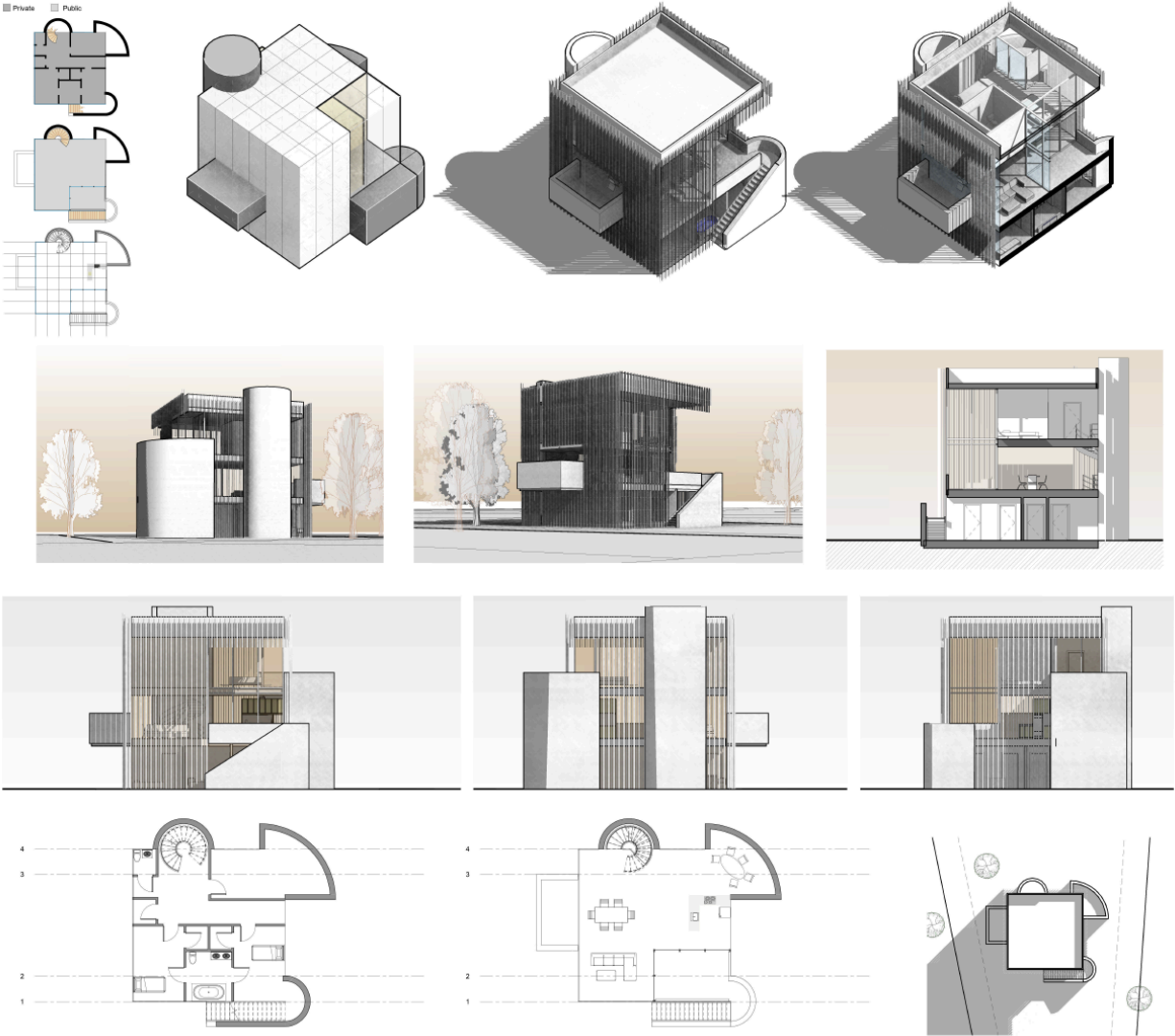
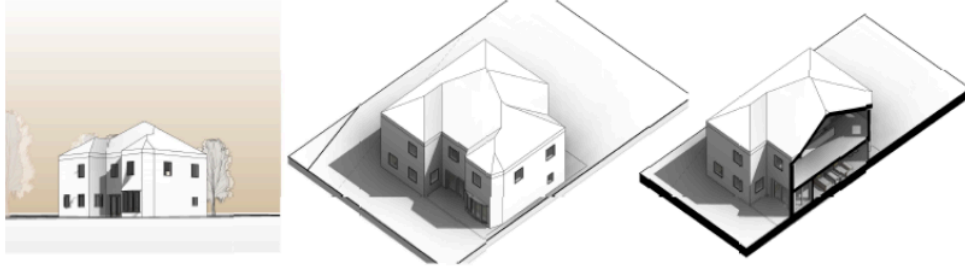


Figure 42 The template of project 3

**PROJECT 1**



Project code **BA003211**



**Question1:** On a scale of 1 - 5 with 5 being the most positive, rate the design of this house in terms of *formal qualities*:

- 1       2       3       4       5

**Question2:** On a scale of 1 - 5 with 5 being the most positive, this houses has a formal language:

- 1       2       3       4       5

**Question3:** On a scale of 1 - 5 with 5 being the most positive, this house has Meier's formal language:

- 1       2       3       4       5

Notes:

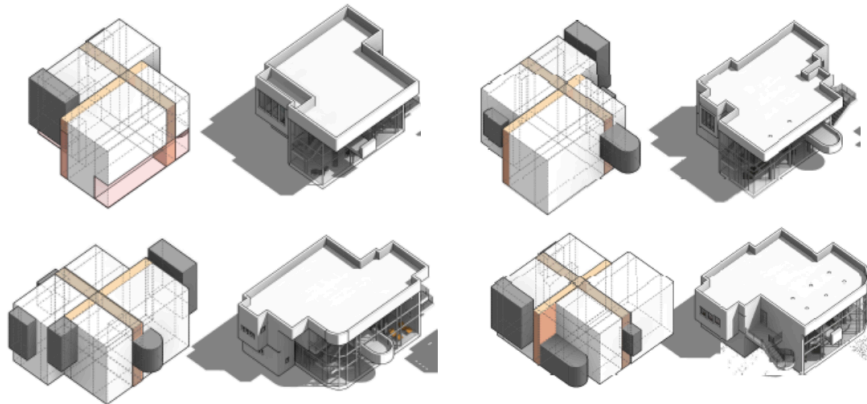
-----  
-----  
-----

**Figure 43** The evaluation sheet of project 1

PROJECT 2



Project code DV006543



**Question1:** On a scale of 1 - 5 with 5 being the most positive, rate the design of these house in terms of **formal qualities**:

- 1       2       3       4       5

**Question2:** On a scale of 1 - 5 with 5 being the most positive, these houses share a common formal language:

- 1       2       3       4       5

**Question3:** On a scale of 1 - 5 with 5 being the most positive, these houses have Meier's formal language:

- 1       2       3       4       5

Notes:

-----  
-----  
-----

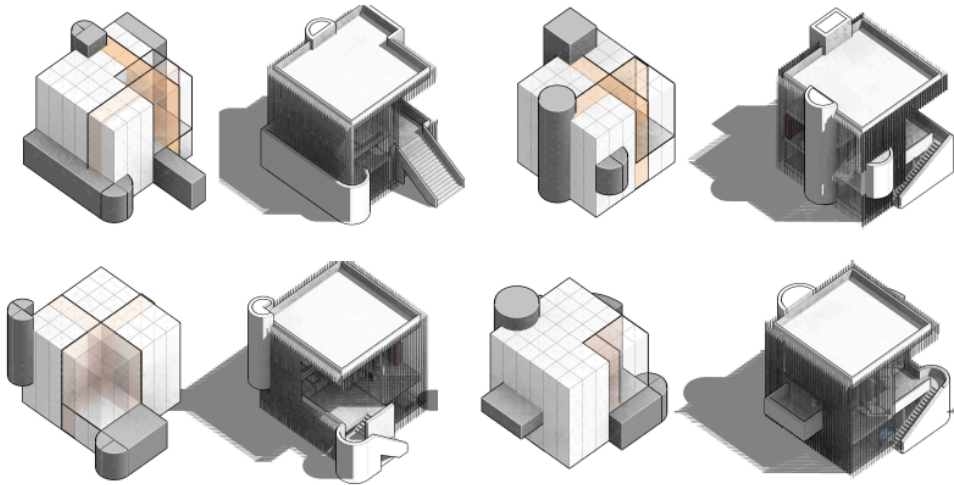
Figure 44 The evaluation sheet of project 2



PROJECT 3



Project code HL005481



**Question1:** On a scale of 1 - 5 with 5 being the most positive, rate the design of these house in terms of *formal qualities*:

- 1       2       3       4       5

**Question2:** On a scale of 1 - 5 with 5 being the most positive, these houses share a common formal language:

- 1       2       3       4       5

**Question3:** On a scale of 1 - 5 with 5 being the most positive, these houses have Meier's formal language:

- 1       2       3       4       5

Notes:

-----  
-----  
-----

Figure 45 The evaluation sheet of project 3

#### 5.4. Summary

This chapter discussed the pedagogical framework of this research, the intervention study in addition to the expert panel that evaluated students' projects.

The **pedagogical framework** of this research relies on *cognitivism* as a pedagogical philosophy. Cognitive approaches see learners as actively making sense of the environment through mental processes such as thinking, knowing, memory, and problem-solving. Moreover, the pedagogical framework in this research is framed around two related high-level pedagogies: *system thinking* and *active learning*. According to the selected high-level pedagogies, the pedagogical strategies of this research focused on enabling students to develop *higher-order cognitive skills* and *system thinking patterns*. Thus, Bloom's revised taxonomy was used to lead formulating these pedagogical strategies. In that sense, several pedagogical tactics were developed and aligned with the pedagogical strategies of this framework. These pedagogical tactics include design problems, computer-based tutorials, lectures, and reading assignments. The educational setting to apply this framework were also discussed.

The **intervention study** aimed to study the impact of implementing AIM in a design studio and validate its usefulness to support conceptual design. The intervention study took place in the second year of a four-year Bachelor of Environmental Design (B.E.D) at Texas A&M University. Three design studios from ARCH 205 Architecture Design I course participated in this study. All three studios were structured around three main design problems. Other tasks, such as precedent study, modeling exercise, and writing essays, were also introduced. In the first design problem, students were asked to employ what they learned from the lectures and the tutorials to design a single-family house using Revit. Afterward, students learned how to work with AIM, and they were introduced to the second design problem. In this design problem,

students were asked to use AIM to design a new house that has the formal language of Richard Meier. Then, students had to generate another three houses that also have Meier's formal language. In the third design problem, students were asked to develop their own formal language and design another four houses. After each design problem, students were asked to take a survey aimed to measure the change in their understanding of architectural design and BIM.

The **expert panel** was conducted with three design studio faculty from three different institutions to assess the projects created by students during the intervention study. In this panel, projects assessment took two formats. First, the experts used a project assessment survey to conduct a blind jury review. Second, the expert had two discussion sessions to discuss, evaluate, and compare all projects. Lastly, the panel intended to engage the experts in the research through discussing AIM after reviewing all projects and suggesting possible improvements for AIM as well as its pedagogical framework.

The results of the intervention study and the expert panel are discussed in the next chapter.

## 6. THE FINDINGS OF THE VALIDATION PHASE OF THE STUDY

This chapter illustrates the findings of the data collected during the validation phase of the study. The discussion of the findings is divided into two main sections. The first section addresses the results of the data collected during the intervention study. In this section, the results of the student survey, the content analysis of the writings assignments, and the observations are presented. The second section demonstrates the outcomes of the expert panel. In this section, the results of the project assessment survey, and the two discussion sessions are discussed.

### **6.1. The results of the intervention study**

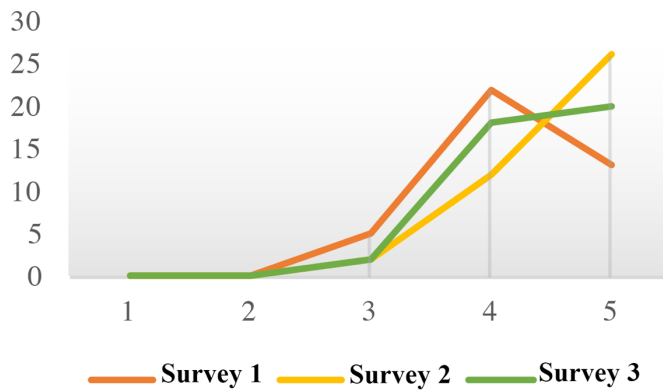
This section discusses the results of the data collected during the intervention study. The sample size of this study is *forty* students. The results include statistical analysis of the student survey, quantitative content analysis of their writing assignment, and the live data collected from design studios.

#### ***6.1.1. Survey***

The forty students took the survey (appendix II) three times: one pre-test survey and two post-test surveys after project 2 and project 3. The survey aims to identify variance in students' perception in five areas: design and formal language, diagrammatic thinking, BIM in design, the ability to generate multiple design options, and the level of *self-efficacy*. The survey used a *5-point Likert Scale* to the change in students' perception in these five areas.

#### *6.1.1.1. Students' understanding of design and formal language*

Through the theory of formal language, architectural design can be understood as a systematic process that relies on defining the vocabulary and the relationships between them, i.e., the syntax. This part of the survey focused on the variance in students' perception of architectural design. A One-Way Repeated Measures ANOVA was conducted to compare the effect of each intervention (i.e., project two and three) on students' perception of architectural design. First, students were asked if they can understand design as a systematic process that has an underlying logic (Figure 46). A One-Way Repeated Measures ANOVA showed that there was a significant effect ( $P < 0.05$ ) of taking project two and three on students' perception of design as a systematic process,  $F=5.773$ ,  $P = 0.00046$ . Second, students were asked if they can describe the vocabulary that they used in each project (Figure 47). A One-Way Repeated Measures ANOVA also showed that there was a significant effect ( $P < 0.05$ ) of taking project two and three on students' ability to recognize the design vocabulary,  $F=13.55$ ,  $P < 0.00001$ . Third, students were asked if they can describe the main rules that they used in their projects (Figure 48). A One-Way Repeated Measures ANOVA showed that there was a significant effect ( $P < 0.05$ ) of taking project two and three on students' ability to understand design rules or syntax,  $F=11.404$ ,  $P = 0.000045$ . Lastly, students were asked if they understand the influence of the elements of construction and their constraints (Figure 49). A One-Way Repeated Measures ANOVA showed that there was a significant effect of taking project two and three on students' ability to understand the constraints of the elements of construction,  $F=3.488$ ,  $P = 0.0354$ .

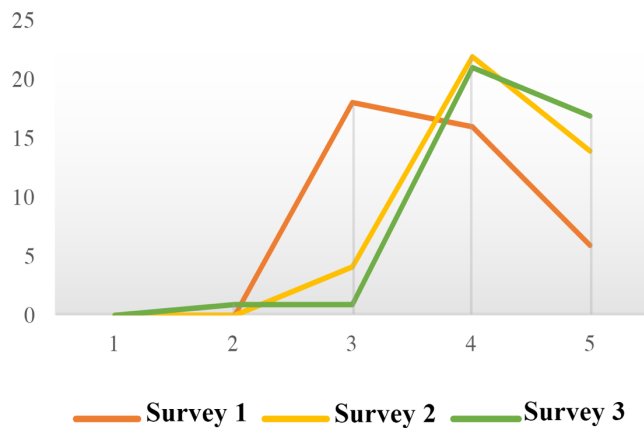


**Frequency Table**

<b>1</b>	0	0	0
<b>2</b>	0	0	0
<b>3</b>	5	2	2
<b>4</b>	22	12	18
<b>5</b>	13	26	20

	Survey 1	Survey 2	Survey 3
<b>Mean</b>	4.2	4.6	4.45
<b>Median</b>	4	5	4.5
<b>Mode</b>	4	5	5

**Figure 46 Q1: On a scale of 1 to 5 with 5 being the most positive, I think design can be approached as a systematic process that has an underlying logic.**

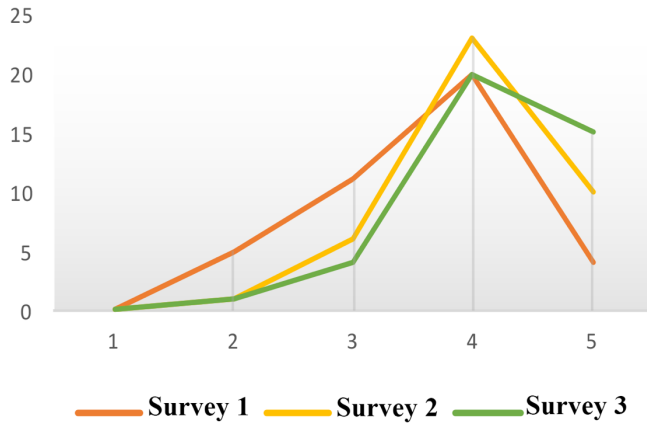


**Frequency Table**

<b>1</b>	0	0	0
<b>2</b>	0	0	1
<b>3</b>	18	4	1
<b>4</b>	16	22	21
<b>5</b>	6	14	17

	Survey 1	Survey 2	Survey 3
<b>Mean</b>	3.7	4.25	4.35
<b>Median</b>	4	4	4
<b>Mode</b>	3	4	4

**Figure 47 Q2: On a scale of 1 to 5 with 5 being the most positive, I can describe the main elements/ vocabulary that I used in my project.**

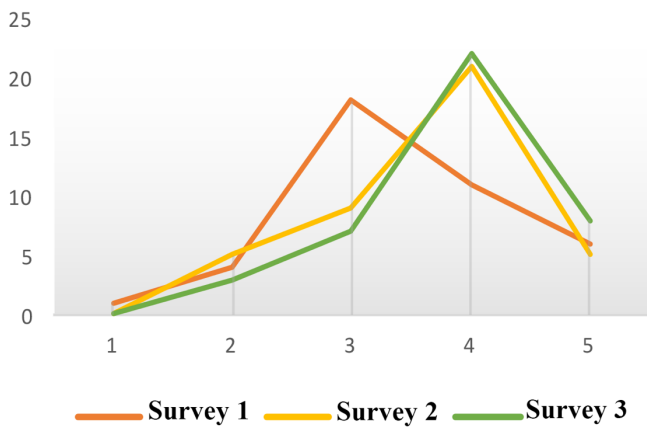


**Frequency Table**

<b>1</b>	0	0	0
<b>2</b>	5	1	1
<b>3</b>	11	6	4
<b>4</b>	20	23	20
<b>5</b>	4	10	15

	Survey 1	Survey 2	Survey 3
<b>Mean</b>	3.575	4.05	4.225
<b>Median</b>	4	4	4
<b>Mode</b>	4	4	4

**Figure 48 Q3: On a scale of 1 to 5 with 5 being the most positive, I can describe the main rules/ syntax that I used in my project.**



**Frequency Table**

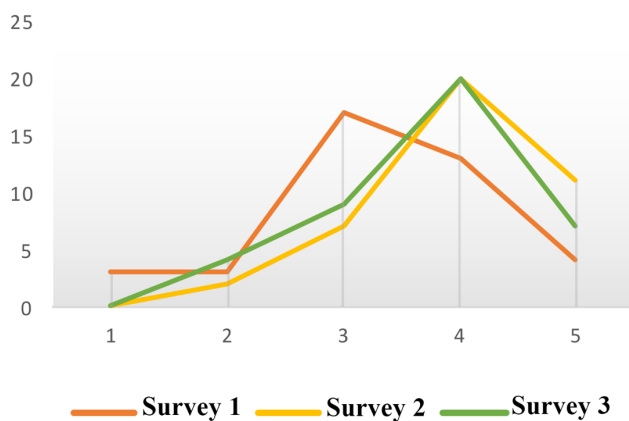
<b>1</b>	1	0	0
<b>2</b>	4	5	3
<b>3</b>	18	9	7
<b>4</b>	11	21	22
<b>5</b>	6	5	8

	Survey 1	Survey 2	Survey 3
<b>Mean</b>	3.425	3.65	3.875
<b>Median</b>	3	4	4
<b>Mode</b>	3	4	4

**Figure 49 Q4: On a scale of 1 to 5 with 5 being the strongest, rate the influence of real-life constraints on your design. These constraints include using elements of construction and being aware of their details.**

6.1.1.2. Students' understanding of diagrammatic thinking

Diagrams are the core of conceptual design and highlight the logic of form through its spatial configuration. They make geometric articulation explicit and help the architect to think about the relationship between abstract formal concepts and actual architectural space. In AIM, diagrams play an integral part in which the designer uses them to articulate the conceptual elements of the design and establish relationships between the elements. In this survey, students were asked about the diagram as an analytical device and as a generative one. A One-Way Repeated Measures ANOVA showed that there was a significant effect ( $P < 0.05$ ) of taking project two and three on students' perception of the role of the diagram as an analytical device,  $F=9.0739$ ,  $P = 0.000373$  (Figure 50). Moreover, the analysis showed that there was a significant effect ( $P < 0.05$ ) of taking project two and three on students' perception of the role of the diagram as a generative device,  $F=8.75$ ,  $P = 0.000373$  (Figure 51).



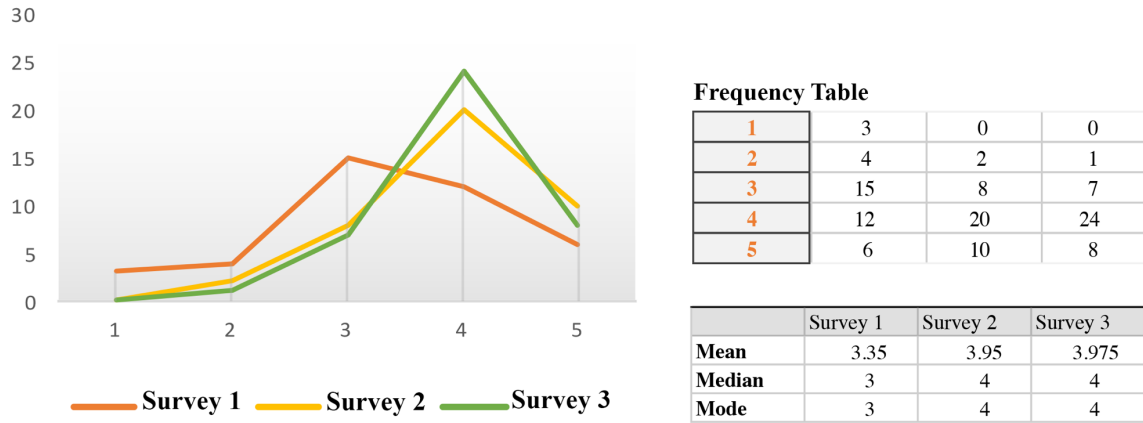
Frequency Table

1	3	0	0
2	3	2	4
3	17	7	9
4	13	20	20
5	4	11	7

	Survey 1	Survey 2	Survey 3
Mean	3.3	4	3.75
Median	3	4	4
Mode	3	4	4

**Figure 50 Q5: On a scale of 1 to 5 with 5 being the strongest, diagrams played an analytical role in my design. It helped me to communicate my ideas and explain form development.**





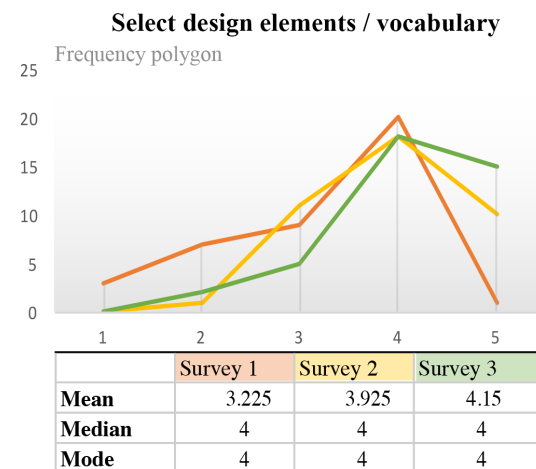
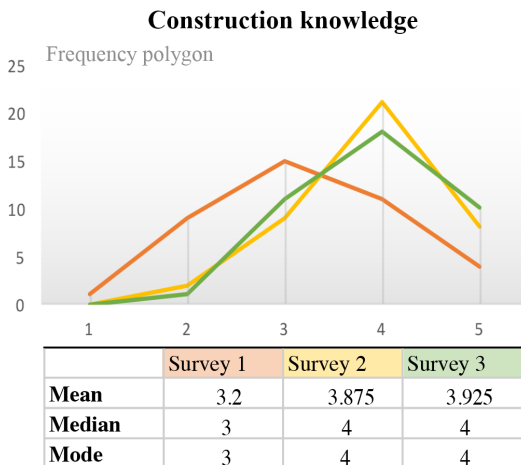
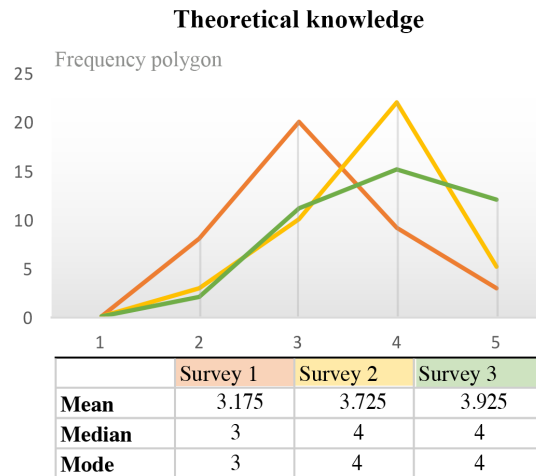
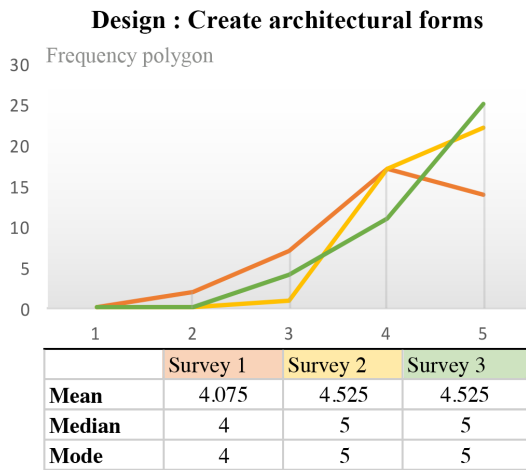
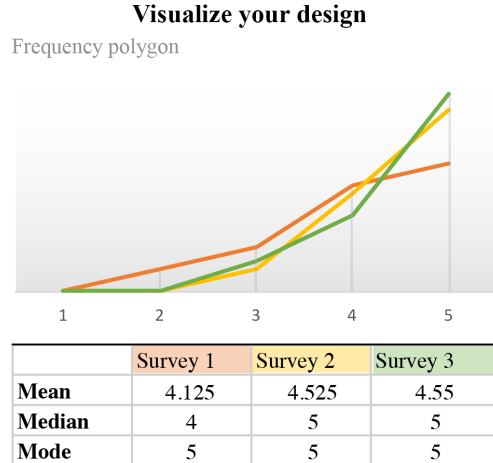
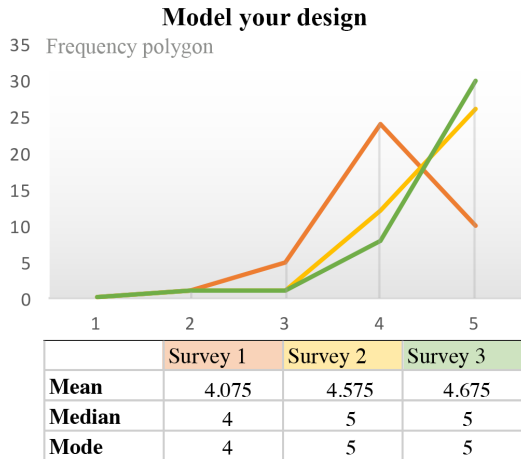
**Figure 51 Q6: On a scale of 1 to 5 with 5 being the strongest, diagrams played a generative role in my design. It helped me in developing my form, thinking about my design, and laying out my design elements according to some predefined rules.**

#### 6.1.1.3. The role of BIM tool in design

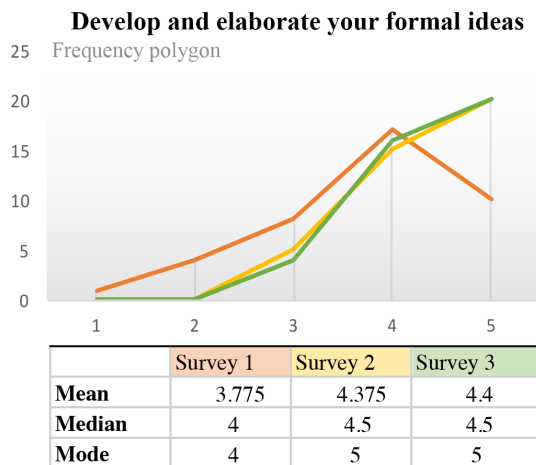
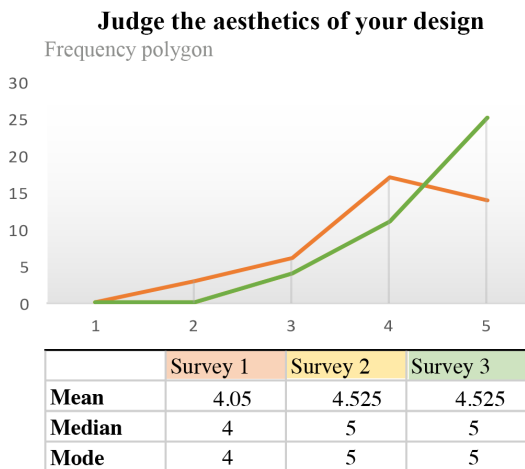
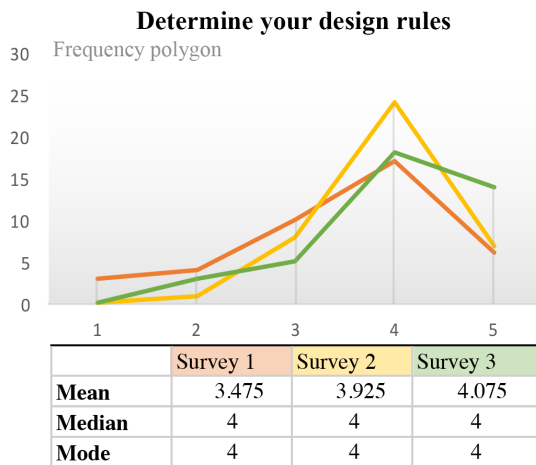
The benefits of BIM span all phases of design. However, many scholars have argued that BIM is a professional tool to represent the technical aspects of building. This part of the survey focused on the variance in students' perception of BIM (Revit) and its likelihood of contributing to their design. A One-Way Repeated Measures ANOVA was conducted to compare the effect each intervention (i.e., project two and three) on students' perception of the role of BIM in design (Figure 52 and Figure 53). The analysis showed that there was a significant effect ( $P < 0.05$ ) of taking project two and three on students' perception of the role of BIM in design as follows:

- Modeling: There was a significant effect ( $P < 0.05$ ) of taking project two and three on the role of BIM as a modeling tool,  $F=11.35$ ,  $P = 0.000047$ .
- Visualization: There was a significant effect ( $P < 0.05$ ) of taking project two and three on the role of BIM in visualizing design,  $F=5.89$ ,  $P = 0.0041$ .

- Design: There was a significant effect ( $P < 0.05$ ) of taking project two and three on the role of BIM in design and creating architectural forms,  $F=6.206$ ,  $P = 0.0031$ .
- Theory: There was a significant effect ( $P < 0.05$ ) of taking project two and three on the role of BIM as an exemplification of theoretical knowledge,  $F=14.74$ ,  $P < 0.00001$ .
- Construction: There was a significant effect ( $P < 0.05$ ) of taking project two and three on the role of BIM as a way to acquire construction knowledge,  $F=13.38$ ,  $P = 0.00001$ .
- Vocabulary: There was a significant effect ( $P < 0.05$ ) of taking project two and three on the role of BIM in selecting design elements and defining vocabularies,  $F=23.135$ ,  $P < 0.00001$ .
- Rules: There was a significant effect ( $P < 0.05$ ) of taking project two and three on the role of BIM in defining the design rules or syntax,  $F=7.443$ ,  $P = 0.0011$ .
- Aesthetics: There was a significant effect ( $P < 0.05$ ) of taking project two and three on the role of BIM in judging the aesthetics of design,  $F=13.55$ ,  $P < 0.00001$ .
- Formal concepts: There was a significant effect ( $P < 0.05$ ) of taking project two and three on the role of BIM in developing and elaborating formal concepts,  $F=10.658$ ,  $P = 0.000081$ .



**Figure 52** On a scale of 1-5 with 5 being the strongest influence, rate the following aspects of the digital tools (Revit) that you used as to their likelihood of contributing to your design: model your design, visualize your design, create architectural forms, theoretical knowledge, construction knowledge, and select design elements.

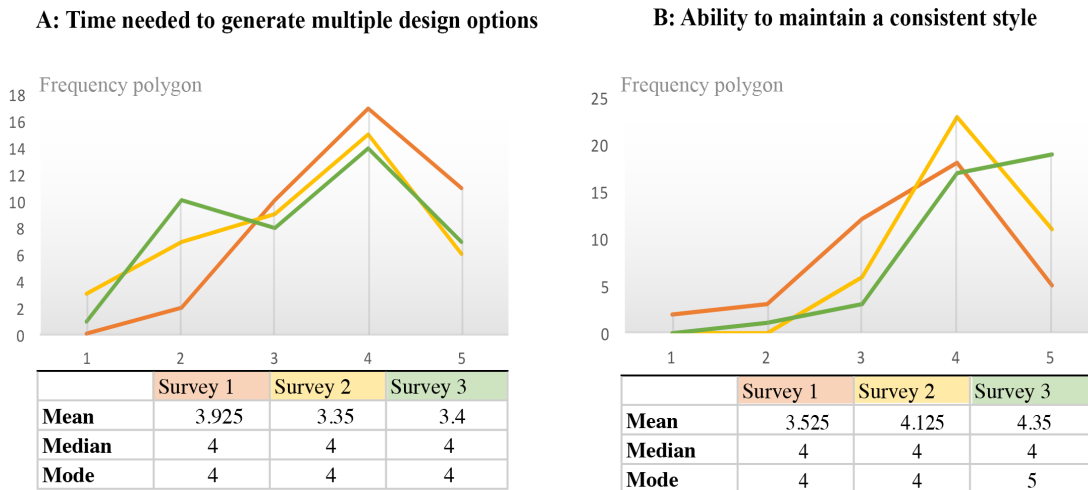


**Figure 53** On a scale of 1-5 with 5 being the strongest influence, rate the following aspects of the digital tools (Revit) that you used as to their likelihood of contributing to your design: determine design rules, judge the aesthetics of design, and develop formal ideas.

*6.1.1.4. Students' ability to generate multiple design options that have a consistent formal expression*

Options generation focuses on creating a set of design alternatives and exploring the range of possibilities in the space of alternative solutions. The generation process can explore creating design options that have one formal language or several languages. In this section of the

survey, students were asked about their thought of creating multiple design options in terms of time needed for this process and the formal consistency between options. A One-Way Repeated Measures ANOVA was conducted to compare the effect of each intervention on students' perception of generating multiple design options (Figure 54). The analysis showed that there was a significant effect ( $P < 0.05$ ) of taking project two and three on students' perception of the time needed to generate multiple design options,  $F=5.228$ ,  $P=0.007402$ . Moreover, A One-Way Repeated Measures ANOVA showed that there was a significant effect ( $P < 0.05$ ) of taking project two and three on students' perception of the time needed to generate multiple design options,  $F=16.007$ ,  $P < 0.00001$ .



**Figure 54 A: On a scale of 1 - 5 with 5 being the most positive, generating multiple design options is a process that consumes a lot of time (e.g. 3-7 days per option). B: On a scale of 1 -5 with 5 being the most positive, I can maintain a consistent style or formal expression (in terms of organizational rules and architectural elements) while generating multiple design options.**

#### 6.1.1.5. Students' level of self-efficacy

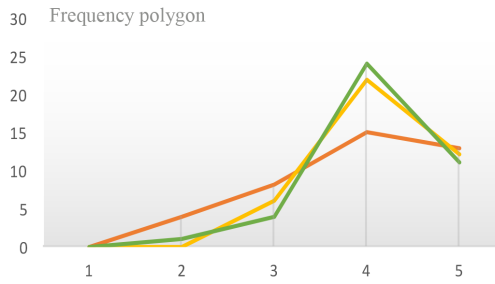
Self-efficacy refers to the belief in one's abilities to perform a task successfully. In this section of the survey, students were asked about their belief in their abilities to carry out several tasks. A One-Way Repeated Measures ANOVA was conducted to compare the effect each intervention (i.e., project two and three) on students' confidence of their ability to accomplish that main tasks in the study. The analysis showed that there was a significant effect ( $P < 0.05$ ) of taking project two and three on students' belief of their ability to perform all tasks *but* one as follows:

- There was a significant effect ( $P < 0.05$ ) of taking project two and three on students' belief of their ability to *develop their style or formal expression*,  $F=15.39$ ,  $P < 0.00001$ .
- There was a significant effect ( $P < 0.05$ ) of taking project two and three on students' belief of their ability to perform a *stylistic change*,  $F=12.303$ ,  $P = 0.000023$ .
- There was not a significant effect of taking project two and three on students' belief of their ability to use *representational media* to communicate their design ideas,  $F=1.5$ ,  $P = 0.22$ .
- There was a significant effect ( $P < 0.05$ ) of taking project two and three on students' belief of their ability to *use digital media to design*,  $F=18.345$ ,  $P < 0.00001$ .
- There was a significant effect ( $P < 0.05$ ) of taking project two and three on students' belief of their ability to *analyze precedents*,  $F=14.63$ ,  $P < 0.00001$ .
- There was a significant effect ( $P < 0.05$ ) of taking project two and three on students' belief of their ability to *use principles derived from precedents to inform their designs*,  $F=7.05$ ,  $P = 0.001527$ .

- There was a significant effect ( $P < 0.05$ ) of taking project two and three on students' confidence in their ability to *use formal organizational principles to inform their designs*,  $F=15.0458$ ,  $P < 0.00001$ .
- There was a significant effect ( $P < 0.05$ ) of taking project two and three on students' confidence in their *design skills*,  $F=7.7257$ ,  $P = 0.000869$ .
- There was a significant effect ( $P < 0.05$ ) of taking project two and three on students' confidence in their ability to deal efficiently with *similar new design tasks*,  $F=7.87$ ,  $P = 0.00077$ .
- There was a significant effect ( $P < 0.05$ ) of taking project two and three on students' confidence in their ability to deal efficiently with *new design tasks*,  $F=7.9$ ,  $P = 0.00074$ .
- There was a significant effect ( $P < 0.05$ ) of taking project two and three on students' confidence in their ability to *make decisions about their design* and solve most problems to accomplish their goals,  $F=6.9$ ,  $P = 0.00171$ .

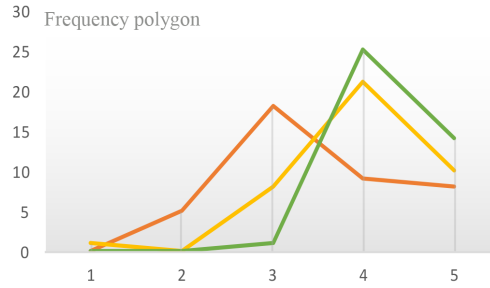
The results of the questions about students' level of self-efficacy are illustrated in Figure 55, Figure 56, and Figure 57.

### Use representational media



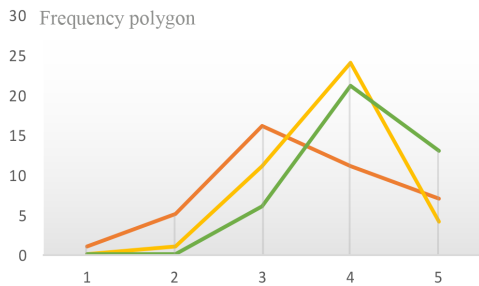
	Survey 1	Survey 2	Survey 3
<b>Mean</b>	3.925	4.15	4.125
<b>Median</b>	4	4	4
<b>Mode</b>	4	4	4

### Use digital media to design



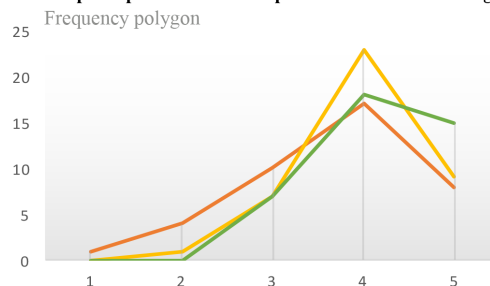
	Survey 1	Survey 2	Survey 3
<b>Mean</b>	3.5	3.975	4.325
<b>Median</b>	3	4	4
<b>Mode</b>	3	4	4

### Analyze precedent



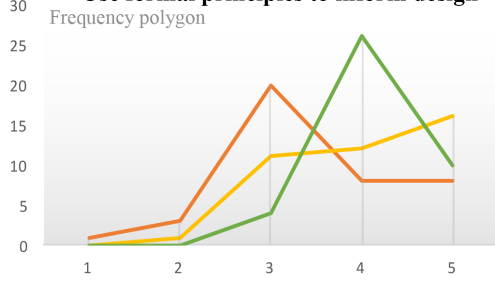
	Survey 1	Survey 2	Survey 3
<b>Mean</b>	3.45	3.775	4.175
<b>Median</b>	3	4	4
<b>Mode</b>	3	4	4

### Use principles derived from precedents to inform design



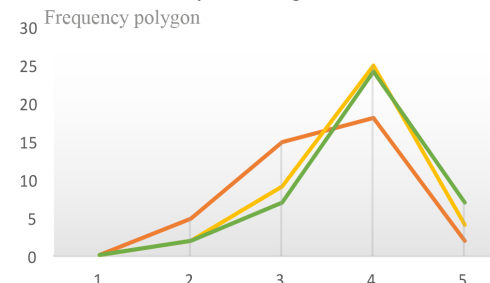
	Survey 1	Survey 2	Survey 3
<b>Mean</b>	3.675	4	4.2
<b>Median</b>	4	4	4
<b>Mode</b>	4	4	4

### Use formal principles to inform design



	Survey 1	Survey 2	Survey 3
<b>Mean</b>	3.475	4.075	4.15
<b>Median</b>	3	4	4
<b>Mode</b>	3	5	4

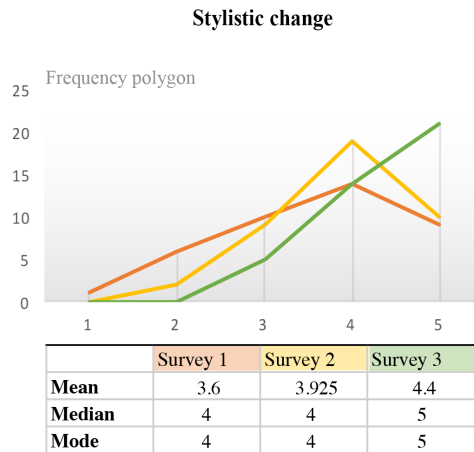
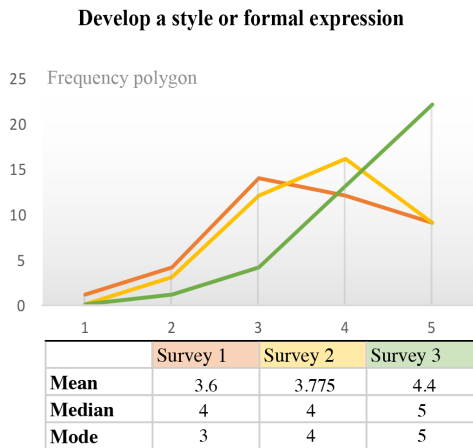
### Rate your design skills



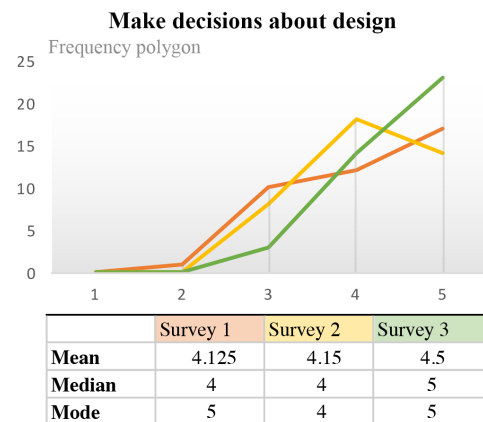
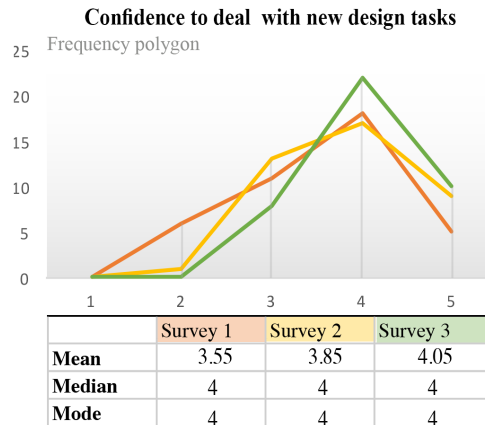
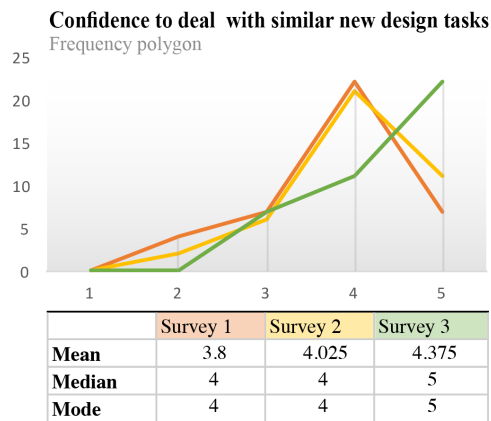
	Survey 1	Survey 2	Survey 3
<b>Mean</b>	3.425	3.775	3.9
<b>Median</b>	3.5	4	4
<b>Mode</b>	4	4	4

Figure 55 The results of the questions about students' level of self-efficacy, part 1



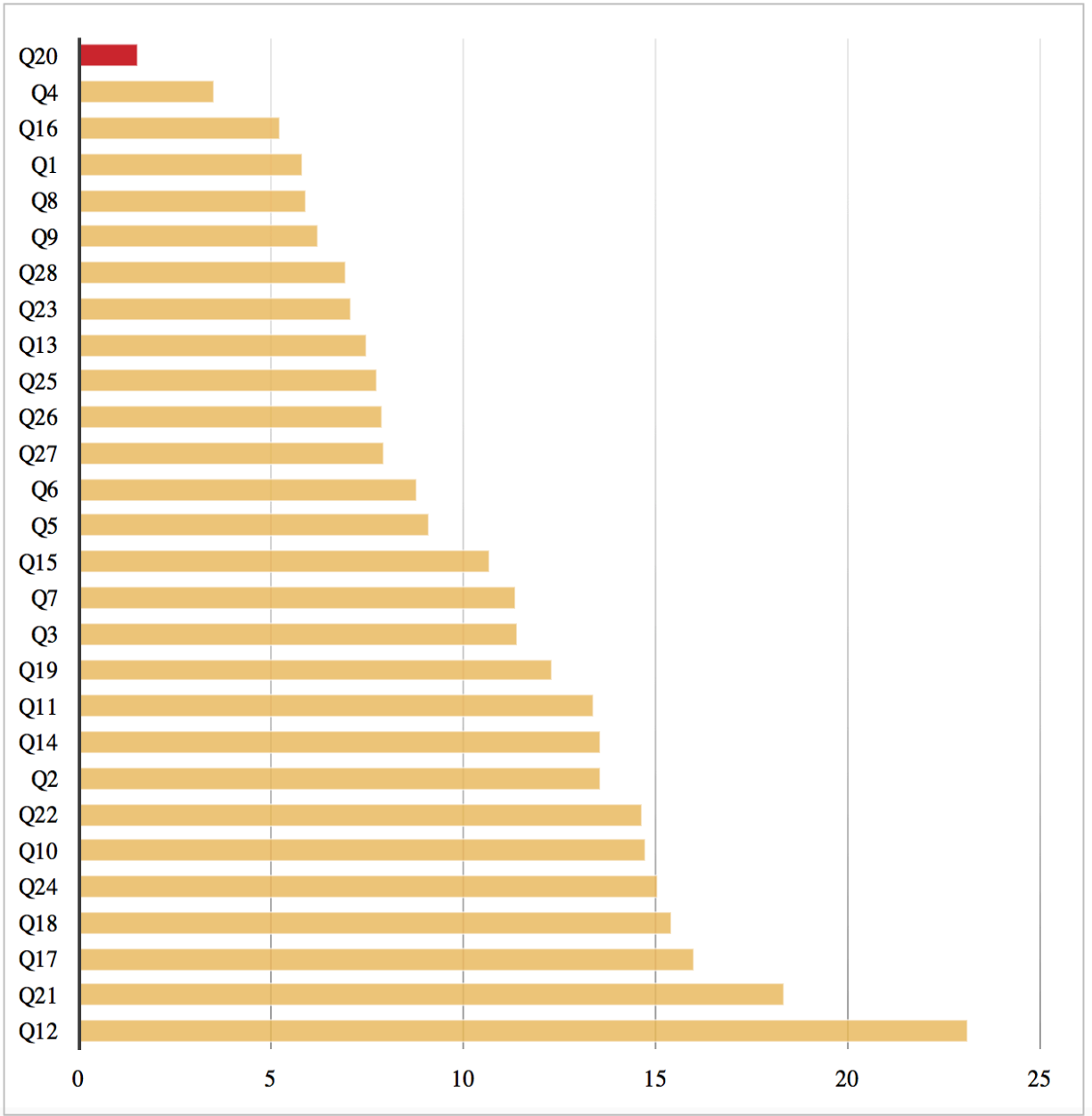


**Figure 56** The results of the questions about students' level of self-efficacy, part 2



**Figure 57** The results of the questions about students' level of self-efficacy, part 3

Statistically, in One-Way Repeated Measures ANOVA, the higher the F-value, the more substantial effect we can get. Thus, a comparison was made between the significant effect of taking project two and three on the outcomes of the survey (Figure 58 and Table 10). The comparison shows that the highest significant effect was in the role of BIM or Revit in selecting design elements and defining vocabularies. Students' confidence to use digital media to design came second while their ability to maintain a consistent style or formal expression came third. Students' confidence to develop a style or formal expression came fourth, and their confidence to use formal organizational principles came fifth. Interestingly, the contribution of BIM or Revit to theoretical knowledge came sixth. The complete comparison can be found below (Figure 58, Table 10).



**Figure 58 A comparison between the result of One-Way Repeated Measures ANOVA analysis**

**Table 10 The result of One-Way Repeated Measures ANOVA analysis ranked from the lowest significant effect (F=1.508) to the highest significant effect (F=23.134)**

Question	F ratio
Q20: On a scale of 1 -5, how certain you are that you can use representational media (e.g. models, drawings) to communicate your design ideas	1.50874
Q4: On a scale of 1 - 5 with 5 being the strongest, rate the influence of real-life constraints on your design. These constraints include using elements of construction.	3.48804
Q16: On a scale of 1 - 5 with 5 being the most positive, generating multiple design options is a process that consumes a lot of time (e.g. 3-7 days per option).	5.22791
Q1: On a scale of 1 to 5 with 5 being the most positive, I think design can be approached as a systematic process that has an underlying logic	5.77341
Q8: On a scale of 1-5 with 5 being the strongest influence, rate the following aspects of the digital tools (Revit) that you used as to their likelihood of contributing to your design - Visualize your design	5.89209
Q9: On a scale of 1-5 with 5 being the strongest influence, rate the following aspects of the digital tools (Revit) that you used as to their likelihood of contributing to your design - Design: to create architectural forms	6.20629
Q28: On a scale of 1 - 5 with 5 being the most positive, how confident you are that you can make decisions about your design, solve most problems if you invest the necessary effort, and accomplish your goals	6.92094
Q23: On a scale of 1 - 5, how certain you are that you can use principles derived from precedents to inform your design	7.05475
Q13: On a scale of 1-5 with 5 being the strongest influence, rate the following aspects of the digital tools (Revit) that you used as to their likelihood of contributing to your design - Determine your design rules	7.44372
Q25: On a scale of 1 - 5, how would you rate your design skills	7.72566
Q26: On a scale of 1 -5 with 5 being the most positive, how confident you are that you can deal efficiently with similar new design tasks (i.e., design new single-family house)	7.87031
Q27: On a scale of 1 -5 with 5 being the most positive, how confident you are that you can deal efficiently with new design tasks (not only single-family houses)	7.90319
Q6: On a scale of 1 - 5 with 5 being the strongest, diagrams played a generative role in my design. It helped me in developing my form, thinking about my design, and laying out my design elements according to some predefined rules.	8.74916
Q5: On a scale of 1 to 5 with 5 being the strongest, diagrams played an analytical role in my design. It helped me to communicate my ideas and explain form development.	9.07396
Q15: On a scale of 1-5 with 5 being the strongest influence, rate the following aspects of the digital tools (Revit) that you used as to their likelihood of contributing to your design - Develop and elaborate your formal ideas	10.65894
Q7: On a scale of 1-5 with 5 being the strongest influence, rate the following aspects of the digital tools (Revit) that you used as to their likelihood of contributing to your design - Model your design	11.35211
Q3: On a scale of 1- 5 with 5 being the most positive, I can describe the main rules/ syntax that I used in my project.	11.40388
Q19: On a scale of 1 -5 with 5 being the most positive, I can change the style or the formal expression of my design into another one (by changing the design elements and organizational principles).	12.30329
Q11: On a scale of 1-5 with 5 being the strongest influence, rate the following aspects of the digital tools (Revit) that you used as to their likelihood of contributing to your design - Construction knowledge	13.38552

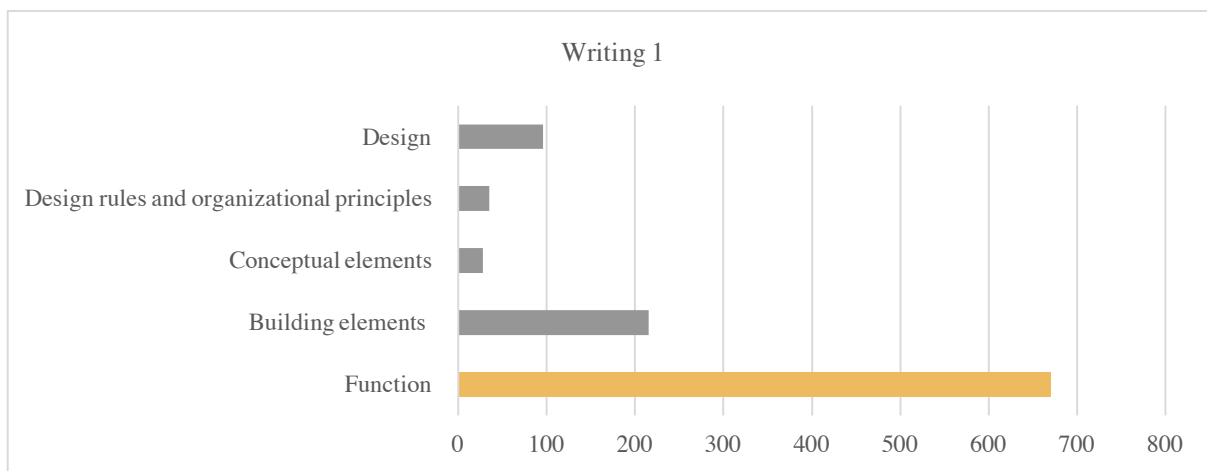
Q14: On a scale of 1-5 with 5 being the strongest influence, rate the following aspects of the digital tools (Revit) that you used as to their likelihood of contributing to your design - Judge the aesthetics of your design	13.55053
Q2: On a scale of 1 - 5 with 5 being the most positive, I can describe the main elements/ vocabulary that I used in my project	13.55319
Q22: On a scale of 1 -5, how certain you are that you can thoroughly analyze the precedents that you choose for your design	14.63367
Q10: On a scale of 1-5 with 5 being the strongest influence, rate the following aspects of the digital tools (Revit) that you used as to their likelihood of contributing to your design - Theoretical knowledge	14.73695
Q24: On a scale of 1 -5, how confident you are that you can use formal organizational principles to inform your design	15.0458
Q18: On a scale of 1 - 5 with 5 being the most positive, I can develop my own style or formal expression.	15.39331
Q17: On a scale of 1 -5 with 5 being the most positive, I can maintain a consistent style or formal expression (in terms of organizational rules and architectural elements) while generating multiple design options.	16.00705
Q21: On a scale of 1- 5, how confident you are in using digital media to design	18.34513
Q12: On a scale of 1-5 with 5 being the strongest influence, rate the following aspects of the digital tools (Revit) that you used as to their likelihood of contributing to your design - Select your design elements / vocabulary	23.13489

### 6.1.2. Writings

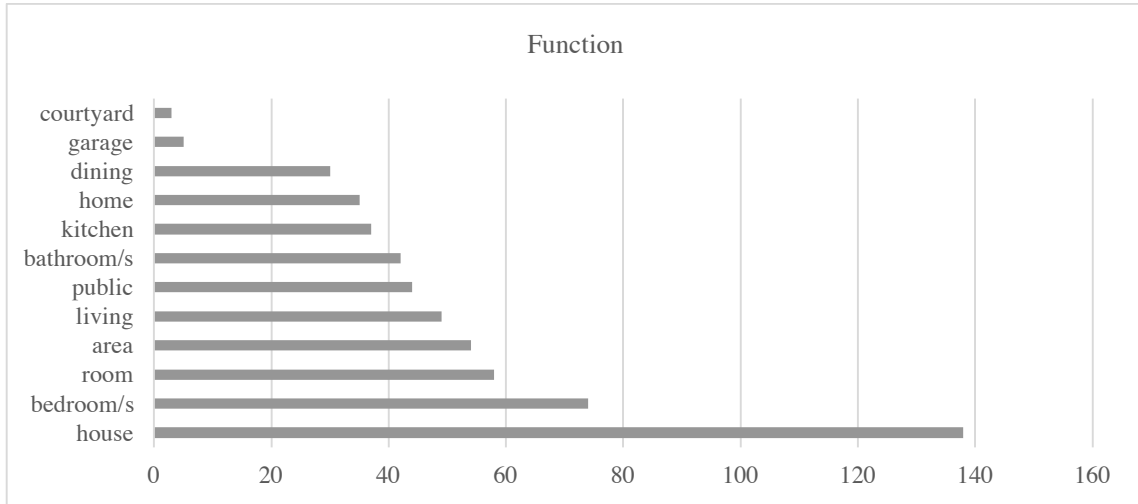
Students had three writing assignments during the study. However, the first and third writing assignments were dedicated to explaining the design process of project one and three, respectively while the second assignment was not connected to this research. All the writings that were collected from students in each assignment were compiled into a single document. Then, the two documents were analyzed using *conceptual content analysis* which involves analyzing text quantitatively through establishing the existence and frequency of concepts. Thus, each text was analyzed according to two units of analysis: *single word* and *phrase*. Then, the units of analysis were clustered according to five themes: function, building elements, conceptual design elements, design rules and organizational principles, and design.

The first writing assignment of all students comprises of 4054 words, and it has 1299 different words. The single word analysis shows that students were more inclined to use words

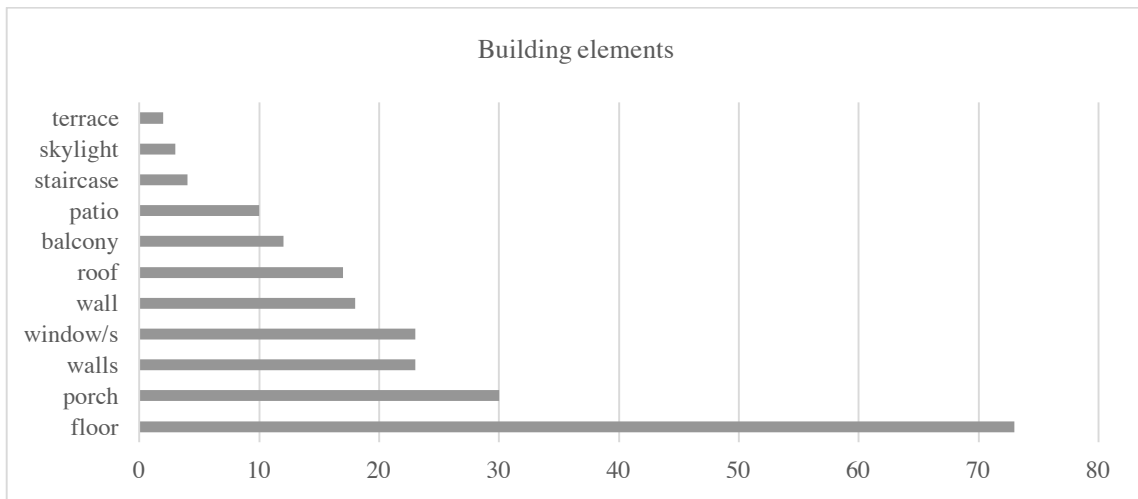
that describe the function of the house (Figure 59). They used 12 different words (occurrences = 671) to describe the *function* (Figure 60). They also used 11 different words (occurrences = 215) to talk about *building elements* (Figure 61). Before this assignment, students took theoretical lectures that explain architectural design and its conceptual elements and organizational principles. However, the use of words that signify design, conceptual elements, or design rules was infrequent. They used 4 different words (occurrences = 130) to describe *conceptual elements* (Figure 62). They used 7 different words (occurrences = 35) to talk about *design rules and organizational principles* (Figure 63). Additionally, they used 3 different words (occurrences = 96) to talk about *design* (Figure 64). Lastly, the phrase analysis shows that the most frequent phrases were about the function of the house (Figure 65).



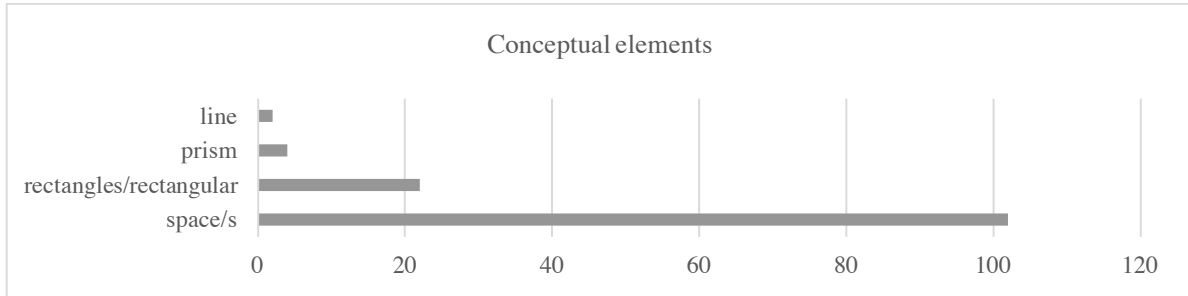
**Figure 59** Content analysis of the first writing assignment, the results of the single word analysis of the five themes



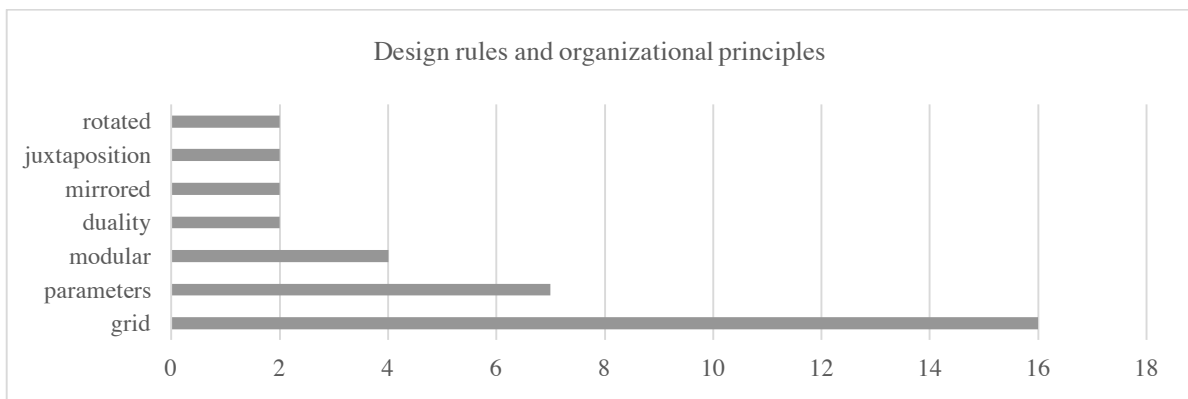
**Figure 60** Content analysis of the first writing assignment, the theme of function



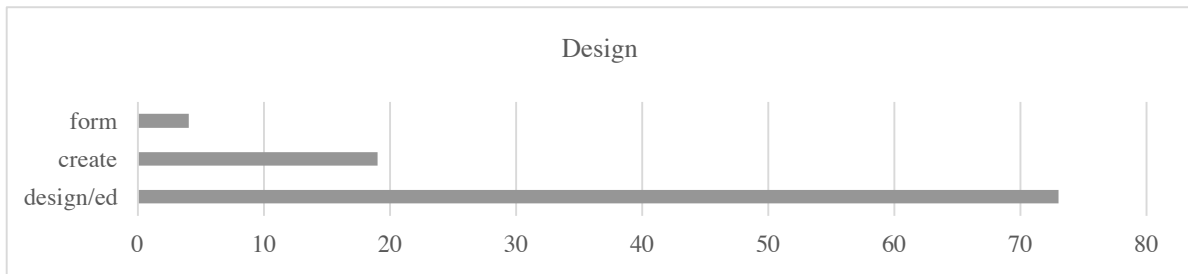
**Figure 61** Content analysis of the first writing assignment, the theme of building elements



**Figure 62 Content analysis of the first writing assignment, theme of conceptual elements**

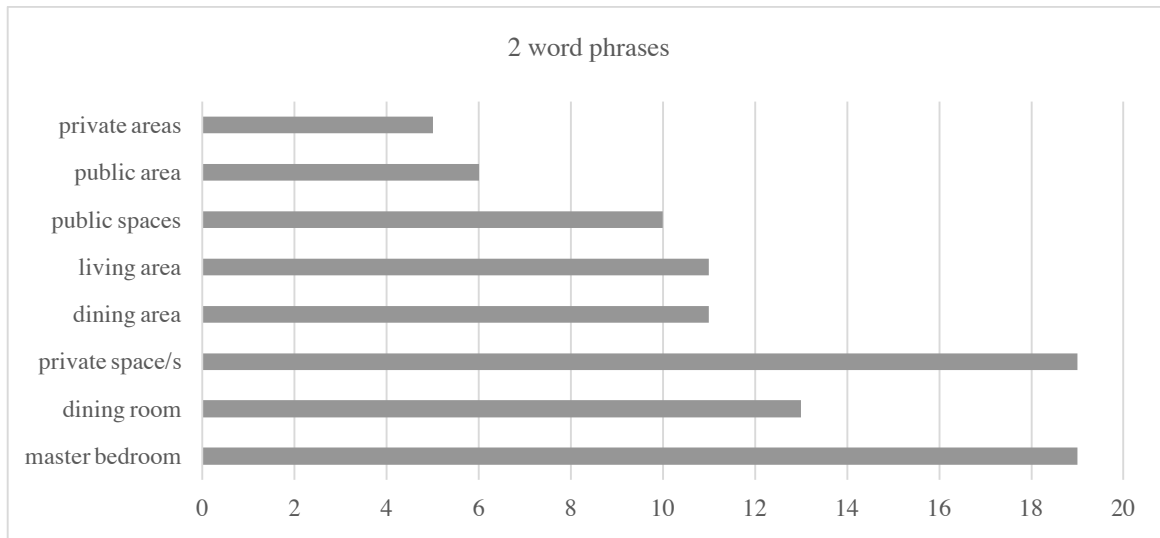


**Figure 63 Content analysis of the first writing assignment, the theme of design rules and organizational principles**



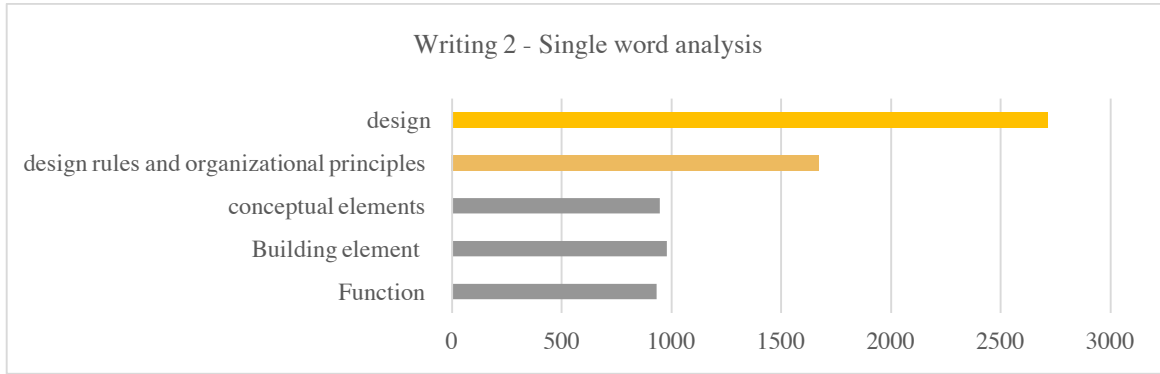
**Figure 64 Content analysis of the first writing assignment, the theme of design**



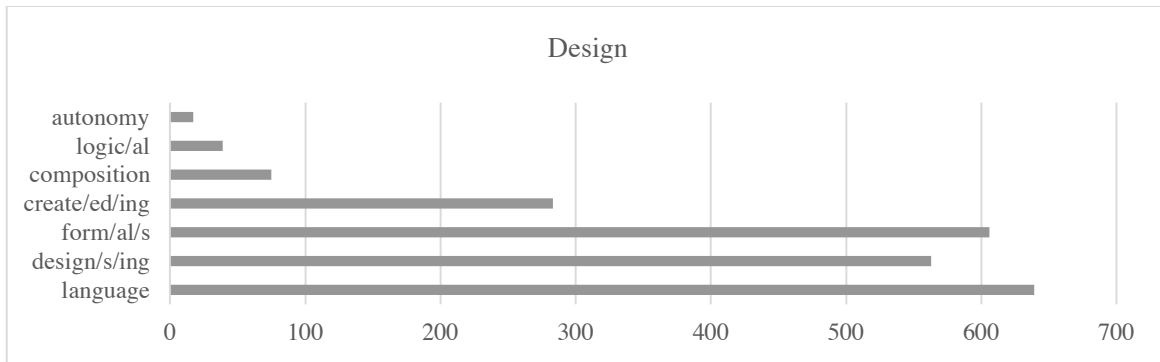


**Figure 65 Content analysis of the first writing assignment, 2-word phrases analysis**

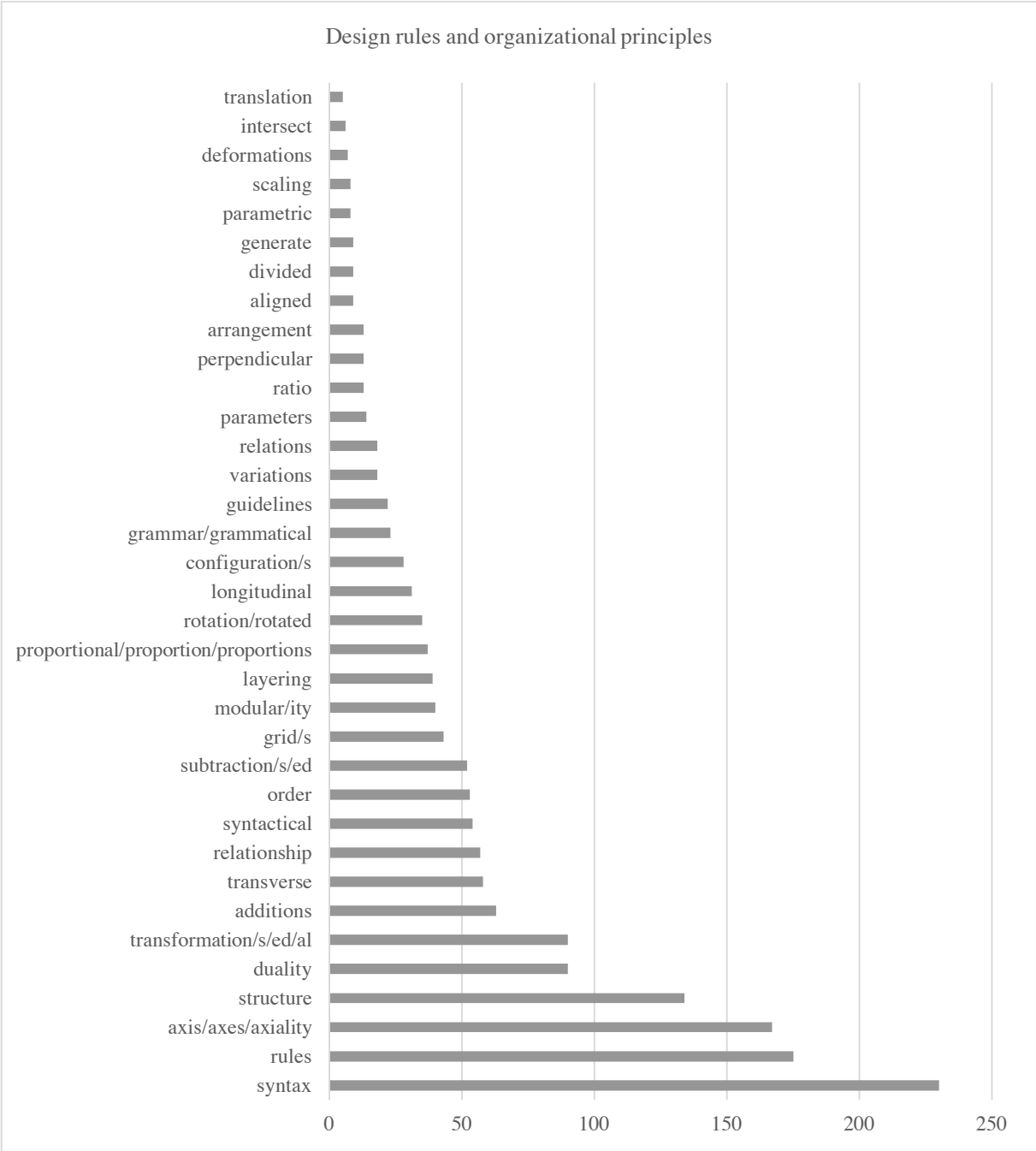
The second writing assignment of all students contains 25441 words, and it has 3243 different words. Unlike the previous one, the single word analysis shows students focused on using more words related to *design* while the focus on *function* was occasional (Figure 66). They used 7 different words (occurrences = 2222) to describe *design* (Figure 67). They also used 35 different words (occurrences = 1671) to talk about *design rules and organizational principles* (Figure 68). They used 13 different words (occurrences = 976) to describe *conceptual elements* (Figure 69). They used 19 different words (occurrences = 978) to talk about *building elements* (Figure 70). Additionally, they used 12 different words (occurrences = 931) to talk about *function* (Figure 71).



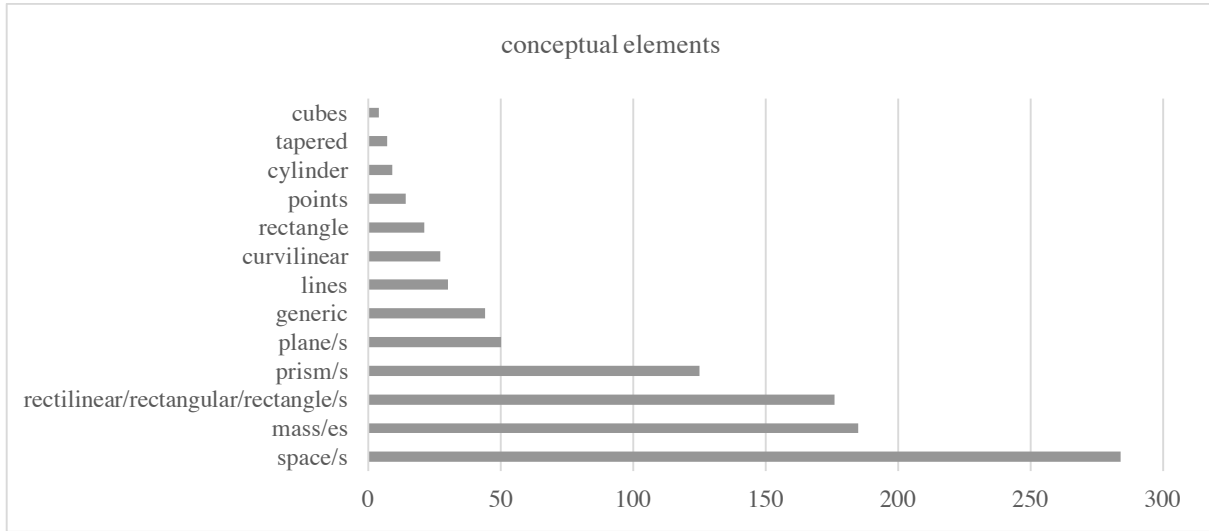
**Figure 66 Content analysis of the second writing assignment, the results of the single word analysis of the five themes**



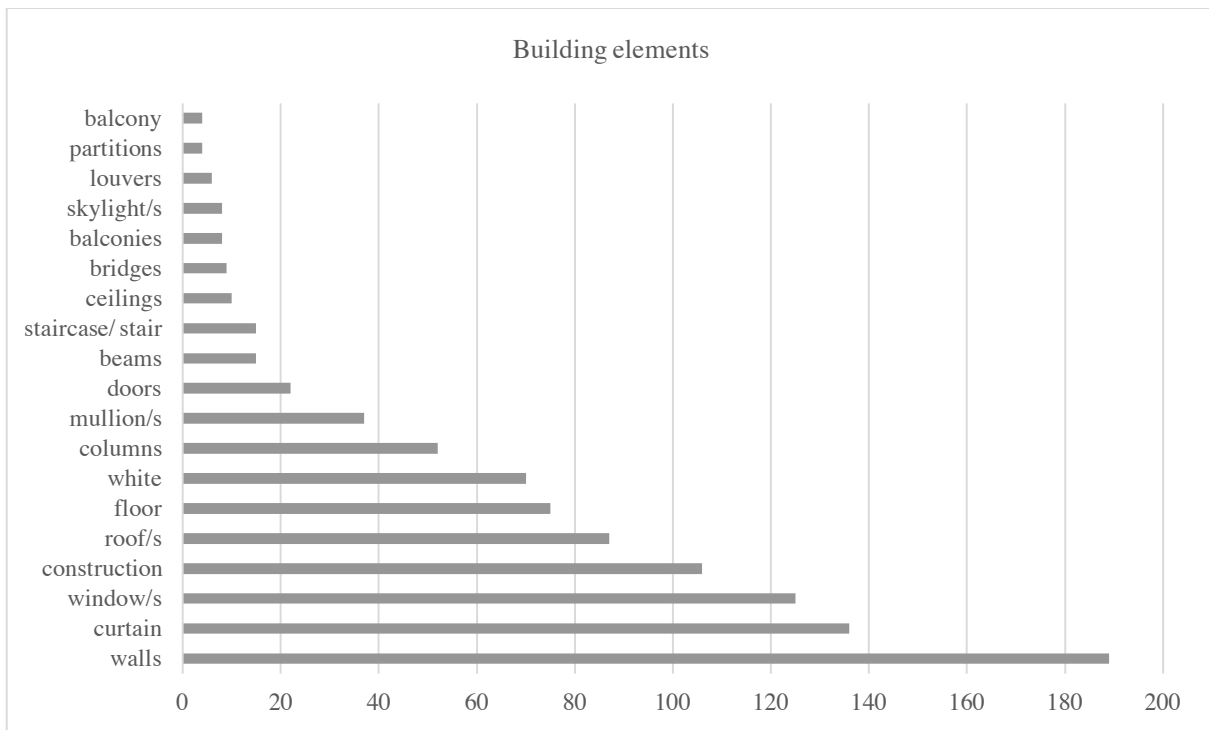
**Figure 67 Content analysis of the second writing assignment, the theme of design**



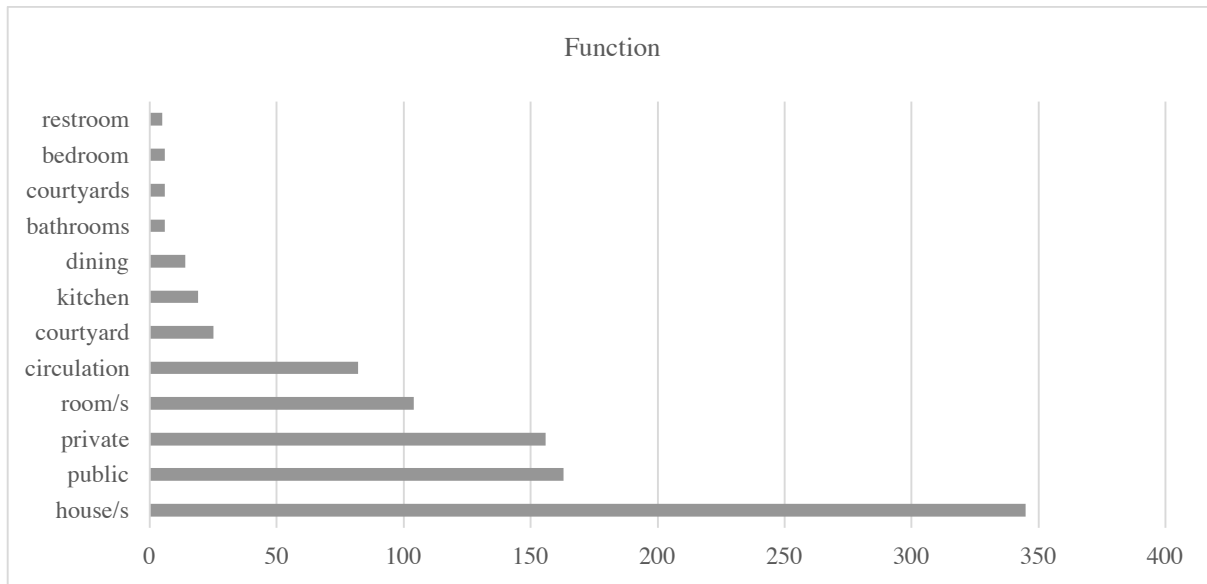
**Figure 68 Content analysis of the second writing assignment, the theme of design rules and organizational principles**



**Figure 69** Content analysis of the second writing assignment, the theme of conceptual elements



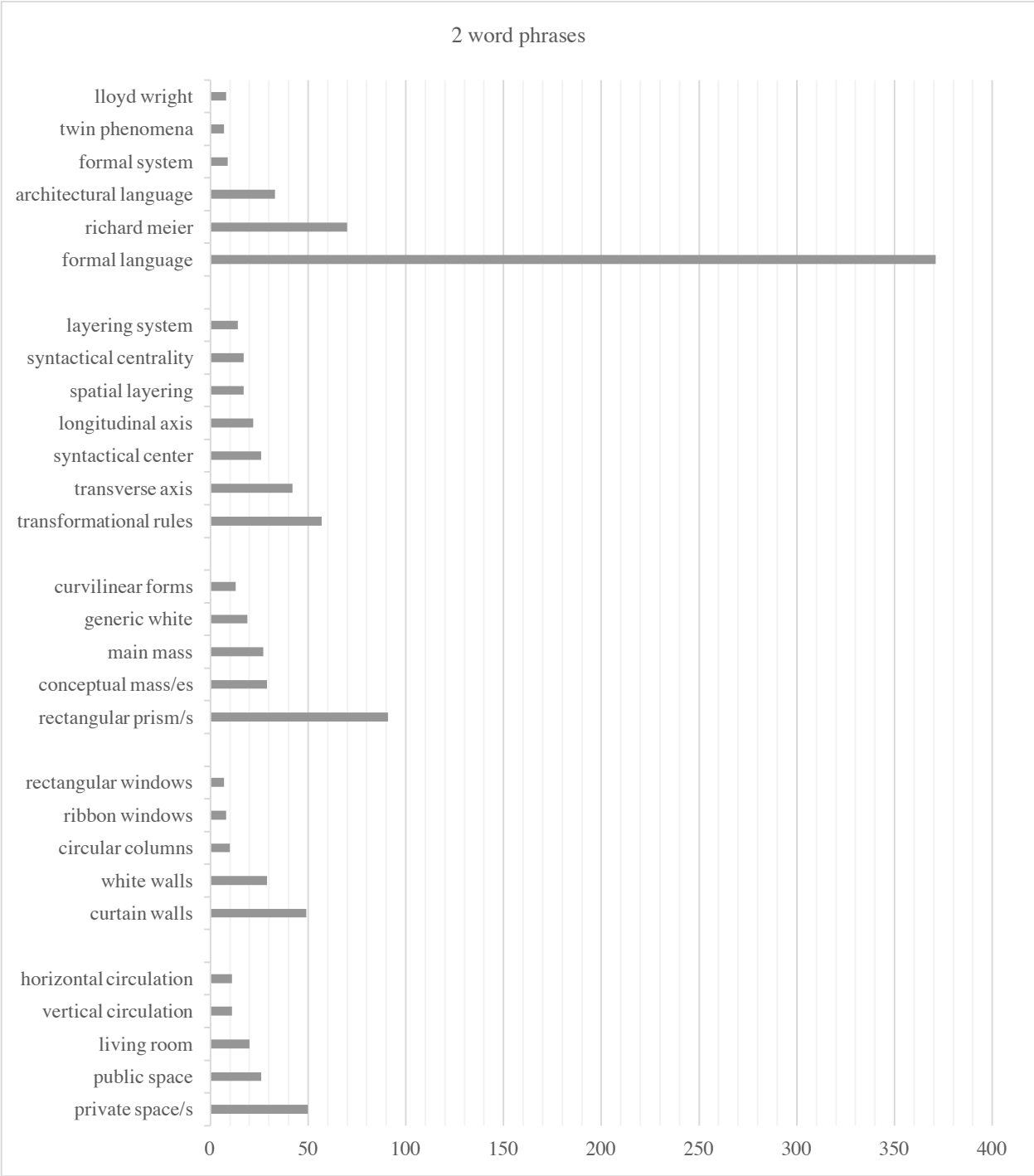
**Figure 70** Content analysis of the second writing assignment, the theme of building elements



**Figure 71 Content analysis of the second writing assignment, the theme of function**

The results of the phrase analysis of the second writing assignment are more rich and diverse in comparison to the previous one (Figure 72). Students used 7 unique phrases (occurrences = 498) to describe *design*. They used 7 different phrases (occurrences = 195) to describe the *design rules and organizational principles*. They used 5 distinctive phrases (occurrences = 195) to describe conceptual elements. Students also used 5 unique phrases (occurrences = 103) to describe *building elements*. Lastly, they used 5 different phrases (occurrences = 118) to describe *function*.

In summary, the content of the second writing assignment is richer than the first writing assignment in terms of quantity and diversity. In the second writing assignment, students were able to expand their vocabulary and articulate different design ideas. They did not only describe the function of the house but also they explained the formal language of their design. The use of plentiful words that manifest design rules, conceptual elements, and building elements was evidenced.



**Figure 72 Content analysis of the second writing assignment, 2-word phrases analysis. From top: the first group is design, the second group is design rules, the third group is conceptual elements, the fourth group is building elements, and the fifth group is function**

### **6.1.3. Observations**

The researcher used *semi-structured observation* to gather ‘live’ data from the studio during the intervention study. This study involves interaction between the researcher and students in the design studio. Therefore, to manage the researcher’s bias, all observations were discussed and confirmed with the second researcher and the supervisor of the study. The observation focused on the design process, the design quality of projects, the use of BIM tool, and the use of AIM framework.

#### *6.1.3.1. Project 2*

The first two weeks of project 2 were dedicated to teaching students how to work with AIM. In the third week of the project, around 35% of the students were facing problems in incorporating *analysis* in their designs. Students were constantly reminded that they are not creating new designs, and this project is about following Meier’s rules. The AIM framework of Meier that was presented to students requires integration between analysis and synthesis. Not all the organizational principles were explicitly defined in that framework. Only the rules of axiality, frontality, the duality between public and private, the duality between front and back, spatial layering, and grids were explicitly defined. Students were expected to do additional analysis to incorporate other Meier’s rules in their designs. These rules should regulate:

- The size and location of the syntactical center.
- The pattern of the mullions grid.
- The size and location of subtractions and additions in relationship to the main mass.
- The rectangular subdivisions of the spatial layout in to served and servant space.

- The size and location of the vertical circulations.

By the end of the fourth week of project 2, there were several *variations* of Meier's language. These variations emerged because not all of the rules were explicitly defined in AIM, and they were left to students and their analytical skills. For instance, some of the projects were closer to the work of other architects in New York Five, and some of them were closer to the work of Le Corbusier. This discrepancy happened because the student missed or misinterpreted one or more of the rules or elements. Besides, the different interpretations of the rules that were not explicitly defined by each instructor contributed to the degree of variations between the projects.

In addition to the issue of analysis, this framework also requires students to develop *abstraction* skills. However, around 20% of the students (3 students in each studio) were facing difficulties to differentiate between conceptual diagrams and the building components. Therefore, in the beginning, they relied only on the CDE to design the house. For instance, they used thin rectangular prisms to signify the walls and small cylinders to indicate the circular columns. Moreover, in the third week of the project, most students had difficulties in understanding the abstract layering system (e.g., A-B-A system). They were not able to comprehend the relationship between that system and the spatial planning of the house. However, in the following week, when they started working on spatial planning, most students understood that relationship. Although many students adjusted their designs according to the relationship between spatial layering and spatial planning, some of them only applied this idea to the new houses that they had to do and they did not revise any of the ones that they had already completed. Accordingly, the notion of spatial layering as an organizational principle was *not consistent* among the four houses.



Working with AIM requires students to understand design as an *iterative* process. It is not a linear process in which the designer would develop the conceptual diagram in CDE and then transform it into a building. Approaching the project as an iterative design requires students to develop the parametric conceptual diagram and the project file simultaneously. Some of the students were focusing on finishing the four houses without revising or iterating the design several times because of the lack of time. This also contributed to the *inconsistency* between the four design options.

Students were required to design four different houses that have Meier's language. The first instructor encouraged students to develop a strategy to achieve formal variations among the four options that incorporate changes in the program and the parameters of the main mass. Besides, students were encouraged to select different elements for addition and subtraction from Meier's library (Table 3). However, the second instructor limited the formal variations to only two operations: changing the parameters of the main mass and changing the location of the elements of addition and subtraction.

Although the curriculum of B.E.D program stated that the students of ARCH 205 were introduced to functional design principles and spatial understanding, most students did not show a great deal of knowledge retention. The lack of basic knowledge in this area appeared clearly during this project. Therefore, in the third week, AIM was updated, and students were provided with spatial planning families (Figure 36). However, not all students used them because they had one week to deliver the four houses.

In the final review of project 2, all students said that they learned a lot from the project because they learned design principles by reading about them and applying them explicitly in a

project. Students also stated the diagrams allowed them to formulate formal ideas and reveal design rules in a better way.

Lastly, students' projects from project two can be categorized according to the understanding of formal language as follows:

- Some students could not understand Meier's language; however, the 4 houses still have a formal language.
- Some students could understand the formal language of Meier in Smith and Douglas house, and they produced similar results without incorporating Meier's manipulations of deconstructing the mass and playing with planes.
- Some students could understand Meier's formal language in Rachofsky house, and they were able to produce more complex forms.
- Some students could understand some aspects of Meier's formal language. However, they missed some of Meier's rules such as frontality, layering, duality on the side elevation, the logic of additions/subtractions, no juxtaposition of solid elements on the curtainwall façade. Accordingly, these houses were more related to the language of Le Corbusier, or other NY5 architects. In terms of design elements, one student had elements that Meier did not use (e.g., Ribbon window).

#### *6.1.3.1. Project 3*

In project 3, students were asked to develop a new formal language. Students were encouraged to maintain a particular level of complexity in their formal language, i.e., they cannot delete all of Meier's rules. The feedback from instructors at this project was minor. Students had the freedom to explore and develop new designs. Although the duration of this project was four

weeks, most students had low productivity level in the first two weeks because they had a busy schedule. They were productive in the last two weeks of the project. The projects created by students can be categorized according to the approach they followed to establish a new formal language as follows:

- Adjust Meier's language: There were only *three* students who decided to work with Meier's formal language and transform it. They kept some of the rules and elements and changed others.
- Conduct a precedent study: There were *four* students who decided to analyze the work of an architect or artist to help them find new rules and vocabulary. These students selected: Frank Lloyd Wright, Charles Gwathmey, the Leimond Nursery School by Archivision Hirotani Studio, and Bruce Beasley bronze sculptures.
- Search for a new language: Most of the other projects fall in this category. The four houses represent an exploration of formal ideas. The search was inspired by features such as sharp angles, circle as plan generator, and courtyard house typology. Many of these were not consistent in terms of having the same rules and vocabulary among the four houses. However, each one of these houses has a particular number of organization principles, and at least one of them has an established formal language.

As a result of these three categories, students who were in the first two categories have relatively more established formal language that is consistent among the four houses. However, the work of the other thirty-three students in the third category is an exploration of a formal language that has a wide range of various formal concepts. Appendix XII contains a selection of students' project that is organized according to the categories discussed in this section.

## **6.2. The results of the expert panel**

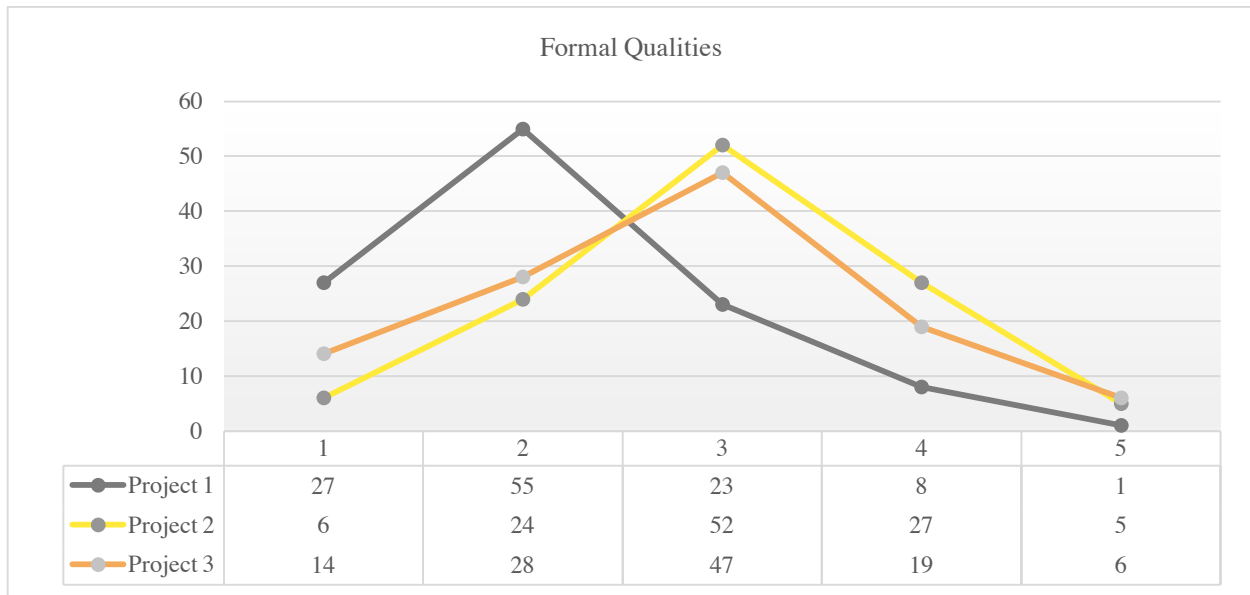
The expert panel was conducted with three design studio faculty: Awilda Rodriguez, Vincent Canizaro, and Ward Wells. The panel analyzed and assessed the projects created by students during the intervention study. Two types of data were collected: *quantitative* data from the project assessment survey and *qualitative* data from the discussion sessions.

### ***6.2.1. The project assessment survey***

The project assessment survey consists of three questions, as follows:

#### ***6.2.1.1. Formal qualities***

In this question, the three reviewers were asked to use a *5-point Likert Scale* to evaluate students' projects in terms of formal qualities. Formal qualities are concerned with the aesthetic appreciation of form. The frequency distribution of all scores collected from the three reviewers is illustrated in Figure 73. In project 1 (mean = 2.13, median=2, mode=2), most projects scored 2. There were 55 scores of 2, 27 scores of 1, and 23 scores of 3. In project 2 (mean = 3.01, median=3, mode=3), most projects scored 3. There were 52 scores of 3, 24 scores of 2, and 27 scores of 1. In project 3 (mean = 2.78, median=3, mode=3), most projects also scored 3. There were 47 scores of 3, 28 scores of 2, and 19 scores of 1. These numbers show that the formal quality of students' projects from project 2 and 3 has improved in comparison to project 1. However, the formal quality of students' projects from project 2 is slightly better than project 3. For instance, in project 3, there are 14 scores of 1 in comparison to 6 scores of 1 in project 2.

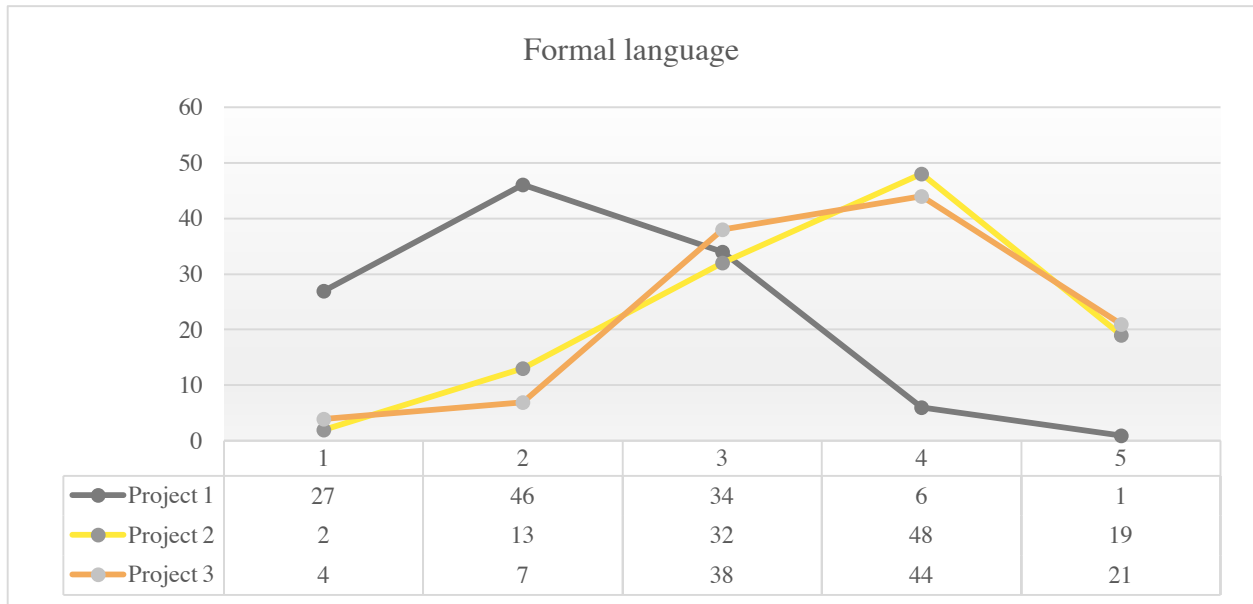


**Figure 73 Q1: On a scale of 1-5 with 5 being the most positive, rate the design of these houses in terms of formal qualities**

#### 6.2.1.2. Formal language

In this question, the three reviewers were asked to use a *5-point Likert Scale* to evaluate students' projects in terms of the *existence* of a formal language and the *consistency* of that language among the four design options. In this question, score 1 indicates the absence of a formal language. Score 3 indicates that there is a formal language, but it is not consistent in all design options, and score 5 indicates that the formal language is consistent. The frequency distribution of all scores collected from the three reviewers is illustrated in Figure 74. In project 1 (mean = 2.19, median=2, mode=2), most projects scored 2. There were 46 scores of 2, 27 scores of 1, and 34 scores of 3. In project 2 (mean = 3.61, median=4, mode=4), most projects scored 4. There were 48 scores of 4, 32 scores of 3, and 19 scores of 5. In project 3 (mean = 3.63, median=4, mode=4), most projects also scored 4. There were 44 scores of 4, 38 scores of 3, and

21 scores of 5. These numbers show that the average performance of students in project 2 and 3 have significantly improved from score 2 in project 1 to score 4.

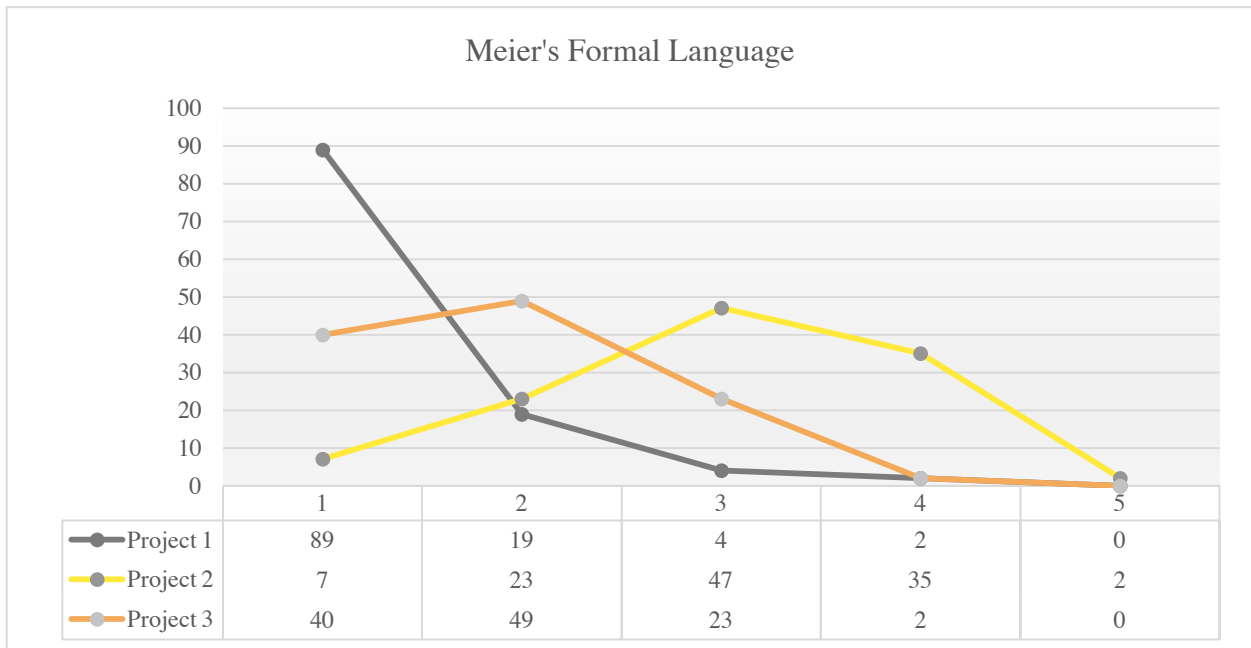


**Figure 74 Q2: On a scale of 1-5 with 5 being the most positive, these houses share a common formal language**

### 6.2.1.3. Meier's formal language

In this question, the three reviewers were asked to use a *5-point Likert Scale* to evaluate students' projects in terms of the *existence* of Meier's formal language and the *consistency* of that language among the four design options. The frequency distribution of all scores collected from the three reviewers is illustrated in Figure 75. In project 1 (mean = 1.23, median=1, mode=1), most projects scored 1. There were 89 scores of 1, and 19 scores of 2. In project 2 (mean = 3.02, median=3, mode=3), most projects scored 3. There were 47 scores of 3, and 35 scores of 4. In project 3 (mean = 1.89, median=2, mode=2), most projects scored 2. There were 49 scores of 2,

40 scores of 1, and 23 scores of 3. According to these numbers, the average performance of students in project 2 indicates that most students were able to apply Meier’s principles in their designs. However, score 3 also indicates that the formal language was *not consistent* in all the design options, and some of Meier’s principles were *missing* in one or more of these options. Additionally, it is evident that students did not use Meier’s formal language in the first and last project. Nevertheless, in project 3, some students, who score 3 or more, were influenced by Meier’s formal language.



**Figure 75 Q3: On a scale of 1-5 with 5 being the most positive, these houses have Meier’s formal language**

### 6.2.2. Discussion sessions

The two discussion sessions were conducted at the end of the first and second day of the expert panel. The author transcribed the two discussion sessions by using the video-recordings.

The analysis involved categorizing responses into several themes related to the goals of this research. The reviewers are identified by their first names: Vincent, Awilda, and Ward.

*6.2.2.1. The perceived main differences between project one and project two*

The reviewers expressed that there is a drastic difference between project one and project two in a short period. The main noticeable differences are exemplified in having more rigor in which students were able to understand design principles, plan, the relationship between two-dimensional plan and three-dimensional form, and differentiate between a building and architecture in project two.

**WARD:** ... *But the extraordinary difference between project one and project two, in a relatively short period of time, and there's this dry and dramatic movement. And that's not to say it was all good or whatever, but there was definitely a move in terms of understanding and evolution of certain design theory, moving through the process...*

**VINCE:** ... *the rigor that they show relative to whatever was created in two, the process they're following, because obviously, I mean, it's up here. And it is way beyond what was our project one. Even when it's bad, it's it has principles, ideas of axes, staircases, things are starting to make sense... Here, well thought out there major, something from a home builder in a magazine are supplying stuff. And here [project2], they might be applying what they're applying as a set of much better principles. Sure, and an educated set of principles. And so, I think it leads to already better results...*



**AWILDA:** ... *I saw great jump between understanding the two-dimensional plan specifically. You have rooms that don't work especially when they put furniture and then started kind of going away. And sometimes they understood the power of the grid, they don't always use it to their advantage. But in project 2 like that issue just kind of melted. Because there was more clarity on the proportions and the usefulness of the role...*

**VINCE:** ... *I also think that the worst project in project two is better than almost all of the projects in project one, in terms of rigor, plan, layout, understanding of plan. Also, knowing the difference between a building or house and architecture, it's more present in project 2 than in project 1 because the understanding of principles is the key difference between them...*

#### *6.2.2.2 The perceived formal principles that students applied in project two*

The reviewers articulated that, in project two, students learned numerous formal principles. These principles include: understand the relationship between architectural principles and the spaces that accompany these principles, develop better spatial systems and plans, distinguish between the public and private areas, and understand the duality between front and back façade. Moreover, students learned to use formal systems to produce a pleasant complexity that emerged from understanding the relationship between several formal systems and how they interact with each other. In addition, students learned to recognize architectural vocabulary, achieve formal consistency, understand scale, translate two-dimensional plan to three-dimensional form, and understand axuality.

**VINCE:** ... They learned to begin to understand either architectural principles or the spaces that are sort of accompanying those principles. For example, symmetry, we're talking about the division of space being divided by a circulation corridor. That's obviously something they all learned, because almost all of them apply that to some extent... But how much they learned, is it's obvious they learned much more rigor about how to lay out a plan. And in many cases, I think they also learned, not all of them but a good a third to a half, learned how to draw that up to the not just developing better plans, but better spatial systems and better facade systems... they learned about spaces, differences between public and private, these [ project 1 ] didn't exhibit public and private space, and these [ project 2 ] did, because that was one of the principles behind Meier's houses... I think there's a complexity in Meier's work of the synthesis of a bunch of those principles at the same time, spatial and formal and gestural, and so on. In project one, some projects at least demonstrated an originality but they just didn't have any rigor. And in project two, this system gave them rigor to produce a nice complexity... I think that the difference between one and two, is it they demonstrated the vocabulary because the kit of parts, which is another way of referring to what is in BIM. They were working with limited and defined vocabulary and the moves. It was also the way in which they deploy them. Also, because students referred back to exemplars, this created a zone of comfort and this affected how much did they learn. However, in the first project they had almost none of that...

**AWILDA:** ... And another issue is the translation from two-dimensional plan to three-dimensional form. What was surprising is that in project one you will have a very

*traditional plan, and then [in project 2] you have this contemporary growth and the understanding of how to comprehensively apply a principle... I think the biggest change from project one to project two for me is consistency. The massing got much clarity. In the project one, we had issues with scale where you have these two massive masses connected by these tiny masses and it just didn't flow. So, I think the volumes gain much more clarity. Then there is a big difference in the facade the development. In project two, students really understand how to use the elements. But in project one they did not understand the relationship between elements in the facade and how that can create a particular experience...*

**WARD:** *... This whole idea of going from plan to three-dimensional volume and how those interact together from the systems point of view. And that goes throughout Meier's work from public, to private to solid void, etc., it's all about that integration and that point of connection is both horizontally and vertically between those different systems. And they were picking that up pretty well... In project two, students understood that there was some relationship between systems.... Although individually, the ordering system look relatively simple and straightforward. But, the complexity is moving nine or 10 issues together and how you integrate those things. Then I found myself looking at them much the way I think a student was looking at it. And then I started becoming much more intrigued with more complex results. ... And to me, at least from my point of view, the ability to have that as part of the vocabulary says something more about the richness or the successful use of all these other principles. Because it is not just a column, screening, massing, or set of principles. But then all sudden, especially when you got a lot of these*

*that have significant public versus private, as soon as they go public, then all these other components start influencing the success of public versus private, in that you are now talking about a public area that may be made up of four or three different functional areas. And so, this is successful, when I start integrating those sets of components.*

**WARD:** *...And I found myself looking at the issue of the two axes. And then the one that probably was most obvious to me is the whole idea of the duality of the solid front versus open or transparent back. I think they all got that...*

### *6.2.2.3. The perceived possible ways to categorize the projects in project two*

The reviewers were asked about the possibility to categorize the projects in project two into three categories. The first category exhibits projects that have Meier's formal language or very close to that language. The second category represents projects that missed more than one aspects of Meier's formal language; however, they still have a language. The third category exemplifies projects that do not have a clear or defined formal language. The reviewers said that around 30% of the projects were in the first category, and the majority were in the second category. Nevertheless, all the reviewers stated that there was not any project that did not have formal principles.

**VINCE:** *...I had 12 for category one and I had three for category three, and that means the vast majority in category two...*

**WARD:** *... But that is a very clear statement: "projects that do not have a clear formal language". and the answer is no, I saw some of Meier principles in every single one. Actually, Category three is project one. Yeah... And I don't think you can use that*

*definition for category three because every single one of them had some aspect, or two or three even. They may not have pushed them enough but they were there...*

**AWILDA:** *...I think the majority were in category two. Category three, as they said, there were few, but they still have some principles that did not have in project one...*

#### *6.2.2.4. The perceived ability of students to produce designs that have Meier's formal language*

The reviewers thought that only a few students were very close to Meier's formal language in all the four houses. They believed that reaching the level of Meier's language requires a level of professionalism that is hard to acquire in a second-year studio. They also added that most students had a disparity between the four houses. The four houses were not consistent in terms of the development of Meier's formal language between all of the four houses. However, most students were able to express Meier's formal language in at least two of the four houses.

**AWILDA:** *... In my opinion, only a few were close to the brilliance of Richard Meier. But definitely, I think they tried but not to the level of professionalism. I have to keep in mind that this is second-year studio. For them, it is the first project in architecture. If it is compared to Richard Meier, I do not think they have the maturity to get to that level yet.*

**WARD:** *I would not have the expectation that students would master Meier in one semester and that might be obvious. But, I was pleasantly surprised by the number of people like felt really came to understand the principles and all...*

**VINCE:** ...I guess maybe that is like 30% of the students got the Meier thing right...Some of them might not be getting Meier, right, but there are some formal principles consistent throughout all of them. And so, they might have gotten a two and a four. And I think there is only a few of those where there is a big disparity between the house one, two, and three, where there's a good design, so it was a three, then a two, and then a four. They were not consistent in terms of the development of a formal language between all of the four houses...

Then, the author asked the reviewers: do you think that some students were able to express the language of Meier in at least one of the four houses.

**VINCE.:** *Yes!*

**WARD:** *Yes!*

**AWILDA:** *Yes, maybe two of the four houses.*

#### 6.2.2.5. *The perceived limitations and drawbacks in project 2*

The reviewers said that there are some of Meier's language principles that many students missed or misunderstood. These principles include the syntactical center, the mullion pattern, the duality on a deeper level (e.g., duality on the side elevation).

**VINCE:** ... *In terms of demonstration, I think it was the continuous vertical space adjacent to the two axes [the syntactical center]. Because it was hard to detect those. It might have been just because of the projection or the means of presentation. Sometimes I don't think it was continuous. But it was hard to tell and I struggled to identify...*

**AWILDA:** ...the mullion placement and breaking the curtain wall are very clear principles that that Meier follows. and I was surprised that they didn't apply that...

**VINCE:** ... Reaching deeper into the dualities was also an issue. They may have gotten one, but they didn't really dive into the two or three possibilities of a particular duality. The duality of front and back that were mentioned was evident in most of them. But sometimes I see inconsistencies in the relationship between the mullion pattern in a different part of the building...

Furthermore, the reviewers said that not all students were successful in achieving an acceptable degree of variations among the four design options. Therefore, they could not maintain the same level of design quality between the four options.

**WARD:** ... There is one in here that actually went, the first one was good. And the second one was not so good. And the third one was good again. And then the fourth one was not so good...

**VINCE:** ... And in this case, because it's all the same, and they could choose different programs, perhaps. I think some of them were struggling with looking for something different. And so, some of them just got lazy, and I had to make a set of two to three floors. And then drops down to one floor. Some of them like the fourth was terrible...

Lastly, the reviewers pointed out that most projects in project 2 neglected some essential aspects of architectural design. These aspects are understanding materials, structural systems, and the spatial quality of architecture experience.

**AWILDA:** *...So, the basics are there through that division. But we think the three of us want to try to go back to that spatial quality and we saw that does still missing...*

**VINCE:** *... I guess if there was another week, I want them also to design the utilitarian spaces, and think about the actual occupation of these buildings... [ in project 2] what they are missing is spatial syntax, maybe materiality, and an assumed sort of sense of structure...*

**WARD:** *... they need to understand structural principles. Structural idea as long-span short span columns, things that are bad things and don't work...*

#### *6.2.2.6. The perceived design attitudes in project 3*

The reviewers emphasized the importance of conducting project 3 to see the impact of project 2. The reviewers said that there were few cases where the students had a formal language that is close to Meier's or other architects such as Charles Gwathmey. However, the majority of students tried to break out of Meier's language. In this project, students expanded their vocabulary. They achieved rigor and formal consistency. Additionally, there were substantial improvements in the floor plan and façade development.

**VINCE:** *... In this project, I found more of them to be consistent through the four. There was formal consistency than yesterday in project two... all four houses do hold together.*



*But then they are different. I actually would like to have known what those intentions were...*

**WARD:** ... *They still accepted some set principles because there's a consistency of thought...if there's discipline there in terms of sets of principles at all, it is pretty complex, and principles are kind of hidden within it. But if there's consistency, there is a consistent language...*

**VINCE:** ... *This is meant to be the proof of whether it carried over or not, and I think it carried over in terms of more discipline of the project but it didn't necessarily carry over in the end result of the quality or if they have internal consistency, or even if they are just better houses...*

**AWILDA:** ... *I saw the biggest improvement on the floor plan... They expanded their vocabulary on the façade. So, in terms of fenestration, they actually increase their vocabulary. They were presented with more choices such as various curtain systems ... Their facade development got a little bit more sophisticated in terms of vocabulary...*

**VINCE:** ... *I would categorize them in terms of the ways in which they sought to break away from Meier. And it's either through bringing curves in section or curves in plan or Angular forms. I think the angular forms are more dominant, in terms of the distinction, because that's not a part of Meier's work... There were one or two who were Richard Meier and one Charles Gwathmey... They seem totally fighting against Meier.*

Moreover, the reviewers said that although the rigor has improved, it did not constrain students because they produced a wide variety of formal languages. However, the projects that relied heavily on Meier's language or other architect's language were perceived as a complete formal language because it has more rigor and consistency among the four houses. On the other hand, the other projects were perceived as a search for a formal language in which students are exploring and developing formal concepts.

**VINCE:** ... *it seems that the rigor has improved by any stretch, it's just that somehow they did not feel constrained, they felt free to move...*

**AWILDA:** ... *To me, I thought it was a bit of a search for a formal language... But comparing this to project one, which to me in a project one, they're coming from the nostalgia of what a house should look like. That go abandon on this and that nostalgia is kind of melted away...*

**VINCE:** ... *That's an example of what I was suggesting. That's a half step towards if they're going to develop their own, which I think is a bit much to ask at this point. So, she took Meier and then went to Gwathmey and did it again but on her own. And so, she's actually learning to carry that out as a process and she was very successful...*

Lastly, the reviewers said that, in a short time, most projects are actually finished although many of them are still in the process of exploring the formal potentials of a language.

**VINCE:** ... Yeah, I guess these were done quick enough. And I mean, they're quick and they're finished which is really interesting. These are look like legitimate real buildings. I think they're learning a lot now. And they're learning a lot through the process you're taking them through.

#### 6.2.2.7. *The perceived limitations and drawbacks in project 3*

The reviewers said that diagrams become the driver of the design and not just a conceptual or non-deterministic mean. However, in project 3, many students reduced the number of principles in the diagram, and eventually, they reduced the complexity of that diagram. For instance, most diagrams did not have void families of regulating planes like the ones in project 2. As a result, these diagrams became more deterministic because they were not conceptualized according to the possible formal variations that might emerge when the parameters are changed. In that sense, the reviewers stated that students had a better understanding and articulation of diagrams in project 2.

**AWILDA:** ... *The diagram became the final form, there was no translation of the diagram pushing it into having Boolean operations... there was not an effort to manipulate the diagram to get the form you want.... They all became positive space, and the voids (families) disappeared from the vocabulary, even though it was there before.... They have the tools that they learned from Meier which is regulatory planes. But it started to disappear...*

**VINCE:** ... *The diagram becomes the driver of the design not in the way diagrams traditionally do that, which is a sort of conceptual or non-deterministic. This becomes a*

*much more deterministic, and yes, you almost have to be anticipating things that you wouldn't know on time.... the traditional diagram has meant to be a very open drawing, it's a very non-deterministic drawing...*

**WARD:** *...And I think that's why, when we go to the project number two, with those principles and rules that actually is more than just one. Many of them are there and they allowed them to free up and have a better understanding from a diagram standpoint. And when we let them loose from that, or it's their choice, they reverted back to boxes of form-making as a diagram...*

Moreover, the reviewers stated that some students lost the sense of scale while they were exploring formal ideas. In addition to scale, the use of a grid to regulate form was less evident in project 3 than project 2.

**WARD:** *...something took over in this project, which is many of the people actually gotten involved in how complex can I make this. And it was a complexity that was well beyond the scale of the building...*

**AWILDA:** *... And the one that I felt was the most misused was the grid. So, they create a grid that is there like wallpaper. But then when you look at the form, it doesn't control anything. They did not understand the power of the grid...*

#### *6.2.2.8. The perceived benefits of the commonality of the presentation*

The reviewers asserted that the use of the template and the consistent presentation allowed them to review a large number of projects very fast. Besides, this allowed them to eliminate irrelevant factors such as individual differences in graphics ability and focus on the design itself.

**AWILDA:** *...I thought that was great. I appreciate it because I can quickly jump from doing a drawing and specifically looking for something... Presentation is a whole different set of skills that they need to have, and taking that out of the equation helped us to just focused on the design itself...*

**WARD:** *...For the purposes of this whole exercise, I think this is the only way or we would have gone mad because of all the different variations that we would have seen and scales and everything else...*

#### *6.2.2.9. The perceived value of AIM*

After a short presentation about AIM, the reviewers were asked about its value to teach formal concept. The reviewers stated that AIM is valuable to students. It allowed them to understand design principles more quickly. However, teaching AIM should be supported by a curriculum that allows educators to add more complexity to the framework.

**VINCE:** *... My initial assessment would be that it's more valuable to the students than it would be to professionals, for instance... I think it needs to be supported by a kind of curriculum of complexity, or of increasing complexity. So, that they don't just do this and*

*see it as a one-off, that it needs to be a part of a multi-stage process before it gets more sophisticated....*

**WARD:** *...I see significant contributions here in terms of moving students along quicker to understand certain principles and that's fantastic...*

Furthermore, the reviewers said that in AIM, the designer does not lose control of the design. On the contrary, AIM provides a more sophisticated way to explore the tool through the lens of architecture. As a result, AIM connects pedagogy and digital tools in architecture successfully.

**AWILDA:** *...Here, the designer does not lose control of the design because the designer controls the parameters and makes a lot of decisions. So, the software is actually not designing for me... So, I think what this framework allows you to simplify your exploration of the software. So, it gives you a more sophisticated way .... It is very important to understand how we teach software. Some schools tell us to take lynda.com, and then Revit or to go to the internet and use YouTube. I think these tools need to be taught with the lens of architecture. So, when you teach a software, to me, it is extremely important that the person is teaching it has an architectural background, so that it's not just like an IT person telling you to click here and there. No, this is design and you have to think through this. So, when you actually put a reference line, you have to understand its impact and how to start making those connections. So, very crucial to me, is how you teach it. It is not just acquiring to use Revit; it goes beyond that...*

**VINCE:** ...Right. And that's actually the connection between the pedagogy and the tool being successful...

#### 6.2.2.10. Suggested improvements and developments

The reviewers provided several suggestions to improve this research:

- Include *material* and *structures* as part of the framework
- Address the *spatial quality of architecture experience* as part of the pedagogical framework. By doing so, students can gain a better understanding of the relationship between syntax and vocabulary. The reviewers suggested several ways to achieve that. First, students can take a chunk of the house and explore the spatial quality there. Second, students can take one house that has most principles and explore the spatial quality there. Lastly, virtual reality (VR) can become part of AIM.
- Implement the idea of *self-evaluation* in the pedagogical framework. After finishing the design options, students should evaluate these options in terms of formal language and revise them. Eventually, this will reduce the disparity between design options, and it will strengthen students' understanding of design principles and formal language.
- Include *more analytical diagrams* in the template. The principle of duality between public and private spaces was evident in most of the projects because students were required to have a diagram of that relationship. Therefore, asking students to have more diagrams that express other design principles will strengthen their understanding of these principles.

Additionally, the reviewers suggested several recommendations to the research design for future studies:

- Trace the performance of each student throughout the study.
- Trace the performance of students in other design courses after this study.
- Consider other approaches to review the projects. For instance, instead of reviewing projects according to the project name (e.g., project 1, 2, 3), reviewers can review them all at once to illustrate the progress of each student. Reviewers can also grade each design option individually instead of grading all the four options together because they have to give the average of the four options. Besides, reviewers can review projects in a different order, for example, project 3 first, then project 1, then project 2.
- Conduct this study with *experienced participants* (e.g., in design, or BIM) and compare the results.
- Include a *control group* in the research design and compare how students learn design principles in each group.



## 7. ANALYSIS AND SYNTHESIS

This research suggested that BIM can be used to aid design thinking when it is enhanced with syntactical tools and supported with a theoretical framework. This chapter includes a synthesis of the significant findings as related to the literature on the theory of architecture, the computability of architectural design knowledge, Building Information Modeling (BIM), and architectural design education. Also included is a discussion on connections to the formulated computational framework (AIM) and the pedagogical framework of this study. The discussion in this chapter is organized according to three sections. From the standpoint of AIM, the first section addresses how BIM can aid conceptual design. The second section presents key findings that are related to BIM and architectural design education. The third section examines key findings related to researching about architectural design studios. Each section is comprised of several themes that are considered prominent factors to achieve the objectives of this study. The chapter concludes with a brief summary that synthesizes the major key findings.

This chapter contains a discussion to help answer the primary research question (P) and the secondary questions (S):

- **(P)**: Can we use BIM to aid design thinking?
- **(S1)**: Can one incorporate the architectural design theories into a BIM tool in order to establish a formalized theoretical foundation to aid conceptual design?
- **(S2)**: Can one utilize modeling methods and software development methods within BIM to offer *syntactical tools*, as well as a design vocabulary, to support conceptual design?

- (S3): Can one teach AIM to integrate design fundamentals and computational concepts effectively?

### **7.1. BIM and conceptual design**

This research formulated a computational framework (AIM) that allows the designer to use BIM at the conceptual design stage. From the perspective of AIM, the argument that BIM supports conceptual design is multidimensional, consisting of seven themes. The first theme suggests that the theory of formal architectural language can provide a theoretical foundation to aid design thinking in BIM. The second theme addresses the several methods that BIM provides to define design elements or vocabulary. The third theme addresses ways to overcome the complexity of BIM tool and making it more approachable for students. The fourth theme argues that BIM does not force a particular style or language. The fifth theme states that design in BIM requires higher-cognitive skills characteristic of design thinking. The sixth theme addresses the dynamic representational system that can be established to support conceptual design. The last theme discusses how BIM allows us to develop a practical symbiosis between the capabilities of the designers and the generative design tools. These themes are discussed according to the results from using the AIM computational framework in the intervention study.

#### ***7.1.1. The theory of formal language as a formalized theoretical foundation***

This research's results emphasized that the theory of formal language can provide a theoretical foundation to aid design thinking in BIM. The formulated computational framework in this research used the theory of formal language to establish connections between approaching design as a formal language and the notion of BIM.

The literature emphasized the importance of having a rigorous theoretical foundation to compute design knowledge (Kalay, 1990; Oxman & Oxman, 1990). Mitchell (1986) argues that a comprehensive and rigor theoretical foundation must support any attempt to use computer-aided architectural design tools. In line with this hypothesis, the findings show that utilizing the theory of formal language allowed the author to formulate AIM as a framework to understand BIM through the lens of architectural design. The participants in the expert panel agreed that connecting BIM to the theory of formal language allows the designer to understand the tool beyond the notion of technical skilling. Moreover, the results from the student survey in the intervention study showed that, in the students' estimation, the second-highest contribution of using the BIM tool in design was expressing theoretical knowledge. This contribution was more significant than other common aspects, such as using BIM for 3D modeling.

The literature stated that to compute design knowledge successfully, the design theory and the digital tool or software should share similar logic or underlying structure (Akin, 1990; Clayton, 2014). This hypothesis aligns with the results of this study. The synthesis stage in AIM shows that BIM shares many commonalities with the theory of formal language that are expressed in three main activities of dissection, articulation, and actualization.

Lastly, this research does not claim that the theory of formal language is the only way to establish a connection between BIM and design theories. Further research is needed to focus on the possibility of integrating other design theories.

### ***7.1.2. Vocabulary and syntax in BIM***

This study showed that BIM could offer several methods to define design elements (vocabulary), transformational rules (parametric variations), and design rules (syntax). The FE,

CDE, PE, as well as the visual programming tool (Dynamo) in Revit, allow the designer to attain this goal.

The literature listed several features that are needed to describe design rules and elements in a digital tool adequately. According to Mitchell (1986), first, the tool should allow the designer to define set *primitives* or vocabulary elements that can be structured according to various types of syntactical rules. Second, the tool should allow the designer to control the transformation or the parametric variation of each design element (Flemming, 1990; Mitchell, 1986). Third, the tools should support Boolean operations to allow the designer to combine primitives to create new ones (Mitchell, 1986). Fourth, Carrara et al. (1994) added that the design vocabulary should consist of a set of semantically rich parametric objects to code various types of properties and enable reasoning about configuration and performance. AIM shows that these four features were implemented as part of the workflow. The results from the test case and the intervention study agree with the literature regarding the importance of these four features to adequately describe the vocabulary and the syntax of a particular formal language in BIM. However, more methods can still be explored to describe complex conceptual vocabularies or other types of design rules.

### ***7.1.3. Overcome the complexity of BIM tool in conceptual design***

The literature suggested that BIM is a professionally-oriented tool that is highly elaborated and specialized. Consequently, it has been argued that BIM is less suitable for conceptual design (Michalatos, 2016). Contrary to this hypothesis, the results of this study showed that the complexity of BIM could be reduced by adopting a *divide and conquer strategy* and multiple levels of *abstraction*.

Akin (2015) argued that divide and conquer strategy can be used to overcome the sophistication of BIM tools. In accordance with this hypothesis, the results of the test case and the intervention study indicated that decomposing the formal design solution into syntactical units or individual design solutions allows the designer to overcome the sophistication of BIM. This strategy directs the focus on the act of creation in which formal configurations can be understood as a hierarchy of elements and subsystems.

Several scholars argued that the representation of design at multiple levels of abstraction allows designers to compute design knowledge and incorporate diagrammatic thinking in early design stages (Cigolle & Coleman, 1990; Do & Gross, 2001; Johnson & Vermillion, 2016; Logan, 1989). Clayton (2014) stated that Revit can support digital diagrams to express geometry, design rules such as proportions, and other associative semantics of the design. Equally, the results from the test case and the intervention study showed that diagrams played a major role in the stage of conceptual design. For instance, the students in the intervention study agreed that diagrams had not only an analytical role but also generative role in the designs they created. Additionally, the results from the expert panel emphasized that when the diagram of public/private spaces was part of the template, most students showed an understanding of those principles because it was simplified in a separate diagram.

Lastly, the expert panel stated that there is a relationship between implementing a divide and conquer strategy and the role of the diagram as a generative device. For instance, in project 3, many students ignored the divide and conquer strategy when they created the conceptual diagram. They did not take into consideration the possible formal solutions that can emerge through changing the relationship between the various sub-formal systems or syntactical units.

Accordingly, the diagram became a deterministic diagram. On the other hand, in project 2, most diagrams had non-deterministic nature, and they played a generative role in the design.

#### ***7.1.4. BIM does not enforce a particular formal style***

The research's results demonstrated that BIM does not enforce a particular language or formal style. The results refute the claim that BIM enforces the use of a supposedly architectural ontology that is based on the language of construction (Michalatos, 2016; Parthenios, 2005). The results also refute the assertion that BIM directs design toward physical objects and cannot address abstract spaces, aesthetics, concepts, or design rules (Coates et al., 2010). The results from the intervention study and the expert panel demonstrated that students in project 2 were able to create various architectural forms in Meier's formal language that exemplify formal concepts beyond the notion of physical elements or elements of construction. Additionally, in project 3, most students developed new formal languages, and they were distinctively different from Meier's formal language. Other students adopted the formal language of other architects such as Charles Gwathmey and Frank Lloyd Wright. On account of this, the use of AIM allowed students to explore various formal languages without being restricted by a particular style or the language of construction.

#### ***7.1.5. Design in BIM requires higher cognitive skills, not just technical ones***

The results of this research showed that using BIM to aid design thinking requires a cognitive model or framework that integrates BIM with the higher cognitive skills of design. This outcome confirms Akin's (2015) hypothesis that we cannot deal with BIM tools with our tacit and intuitive skills alone. Researcher, thus, should develop methods that integrate BIM with

the cognitive models of designers (Akin, 2015). On the other hand, this contradicts the claim that BIM cannot support conceptual design, because it requires higher cognitive skills characteristic of conceptual design, such as abstraction, analysis, synthesis and creativity (Coates et al., 2010; Michalatos, 2016; Parthenios, 2005; Yan & Demian, 2008).

In this research, the computational framework AIM and the pedagogical framework were both structured around the three main exercises in formal composition: the *analysis* of existing formal system or language, *synthesis*, and the *generation* of multiple design options. The designer needs to understand formal language as a formal system that requires higher-order cognitive skills and system thinking patterns, such as identify elements, understand behaviors, predict consequences, and devise modifications or adjustments. The results from the intervention study showed that students demonstrated higher-order cognitive skills and system thinking patterns in their projects. However, the expert panel suggested that the notion of *self-evaluation* should be emphasized more in the pedagogical framework. Besides, further research can be conducted to integrate evaluation methods in AIM to assess functional, formal, and environmental performances.

#### ***7.1.6. BIM has a dynamic representational system that can support conceptual design***

The research's results showed that the representational system in the BIM tool used in AIM has several features that were employed to aid conceptual design. The importance of these features is documented in the literature. In computing design knowledge, the literature stressed the importance of a representational system that can illustrate knowledge about design elements, and knowledge about the relationships between them (Kalay et al., 1990; Leeuwen, 1999). Additionally, Logan (1989) stated that the designer should be able to control the level of

abstraction that is needed at each design stage. Relatedly, Parthenios (2005) argued that any digital tool for conceptual design needs to have the right balance between productivity and freedom that will allow diversity and promote creativity. Accordingly, the digital tool should be loose enough to allow ease of expression and flexibility of attempts and be still precise and specific to allow refinement of design (Do & Gross, 2001; Flemming, 1990; Parthenios, 2005).

In line with the literature, the results from the test case and the intervention study showed that using AIM allows the designer to:

- Illustrate knowledge about design elements and rules through using color-code, text parameters, and labeling to add information about the design elements and rules.
- Work with several levels of abstractions and incorporate diagrammatic thinking in early design stages.
- Maintain a dynamic relationship between the abstract diagram in CDE and the physical form in PE.
- Iterate designs very fast without losing precision.

In view of these features, the expert panel acknowledged that although the projects created by students were done in a short period of time, they exhibited formal knowledge and looked “*finished*” or “*legitimate real buildings*.”

#### ***7.1.7. In BIM, a symbiotic relationship between the designer and the generative design tool can be established***

This research is consistent with the literature that discusses the benefits of computational design research that can create a symbiosis between computers and human designers (Carrara et



al., 1994; Kalay, 1990). Unlike other methods such as shape grammar, AIM develops a practical symbiosis between the capabilities of the designers and machines to enhance the capabilities of each partner. The results of this research showed that AIM works as an integrative design system that combines the capabilities of BIM tools and designers. Although the system is not entirely automated, it allows the designer to experiment, develop formal concepts, make decisions, and then automate selected aspects of the design using parameters and constraints. Accordingly, the role of BIM can be altered dynamically between an explorative design environment (e.g., project 3) that explore and develop design ideas and a generative design environment that can generate design options with a consistent formal language (e.g., the test case of Meier). The participants in the expert panel agreed that although the system has a generative power, the designer is still in control of the design. In that sense, AIM provides a more sophisticated way to explore the BIM tool within the context of how designers think.

## **7.2. BIM and architectural design pedagogy**

The assumption for what makes AIM beneficial to architectural design pedagogy consists of two principal themes: (1) teach formalism and computational concepts through active learning, (2) introduce a third trajectory to teach BIM beyond the form-centric and BIM-centric construction agendas. These themes address issues related to the secondary research question (S3) that investigates the practicability of teaching AIM to integrate design fundamentals and computational concepts.

### ***7.2.1. Teach formalism and computational concepts through active learning***

This research showed that students learned about formal concepts and computational concepts through active learning. Active learning focuses on *learning-by-doing* and *project-based learning* as methods promoting higher-order cognitive skills: *analyze, define, evaluate, and create*. The results of this research are in accordance with the hypothesis that active learning increases retention, content knowledge, problem-solving abilities, and creative thinking (Anderson et al., 2005; Roehl et al., 2013). After completing project 2, students stated that they understand design principles better because they had to apply them explicitly in their projects. However, in project 1, the results from the survey and the observations showed that the students had insufficient understanding of these principles because they relied only on lectures and readings. In line with these findings, the content analysis of the writing assignments revealed that students were able to expand their vocabulary and articulate abundant formal ideas in project 3. However, they lacked these skills in project 1, suggesting that they learned these concepts from the learning activities undertaken in project 2 and project 3.

Lastly, the literature stated that teaching formalism through computational design had been taught only through shape grammar. The results of this research presented an additional way to teach formalism using computational design. The developed method in this research corresponds to Flemming's (1990) recommendations to overcome the limitations of shape grammar. According to Flemming (1990), an efficient computational method to teach a formal language must be robust yet flexible, and easy to learn. It also should allow rules to be defined interactively and graphically through higher-level operations (e.g., alignment), picking and pointing, as well as parameters to create dimensional variations.

### ***7.2.2. A third trajectory to teach BIM beyond the form-centric and BIM-centric construction agendas***

The results of this research demonstrated that it is possible to formulate a third trajectory to teach formal concepts using BIM beyond separate form-centric agenda from BIM-centric construction agenda. The results from the pedagogical framework and the intervention study respond to the question in the literature: is there room for new trajectory that brings together form-centric and BIM-centric construction agendas (Cheng, 2006; Deamer & Bernstein, 2011)? Moreover, the findings show that students in the early core design studio can learn design fundamentals (e.g., form, composition) and learn BIM at the same time. Nevertheless, Deamer and Bernstein (2011) argued that the fact that many pre-BIM design fundamentals need to be covered is an obstacle to teach BIM in the early core design studio. The participants in the expert panel agreed that this research allows the educator to place BIM in the early core design studio; however, it should be supported with a ‘curriculum of increasing complexity.’ This curriculum would allow educators to incorporate other issues related to architectural design and building performance (e.g., virtual reality, construction, material, structure, optimization). From this perspective, further research is needed to develop a curriculum that integrates the form-centric and BIM-centric agendas and allow educators to add complexity to the AIM framework gradually.

### **7.3. Research in design studio**

This research contributed a novel and powerful mixed-methods approach to develop a computational design framework and test it in an educational setting. The method links theory and practice in educational research, situating this research as *design-based research*. The

success of the method is supported by the arguably high level of reliability and validity achieved for the conclusions. The findings of this research contribute a clearer understanding of *design as a research process*. An objective, systematic method to conduct research in a design studio was presented. The synthesis of findings shows that students' understanding of digital tools can be objectively assessed. There are several strategies contributed to the reliability and validity of the findings. These strategies include:

- Adopting a theoretical framework to guide the research
- Utilizing triangulation to combine several kinds of data and methods (e.g., computational modeling, cognitive modeling, quasi-experiment, observations, survey, expert panel, content analysis)
- Review students' projects using a unified presentation (i.e., standard layout and graphical expressions) to eliminate confounding variables related to individual differences in graphics ability. The participants in the expert panel indicated that adopting this method facilitated reviewing a large number of projects in a short time at a high level of confidence in objectivity.

#### **7.4. Summary**

To conclude, the discussion in this chapter aimed to address whether implementing AIM allows us to use BIM to aid conceptual design. The key findings related to implementing AIM can be synthesized and understood according to three main study areas: how to integrate BIM and conceptual design, the relationship between BIM and architectural design education, and research about the acquisition and use of knowledge in the design studio.

First, in terms of BIM and conceptual design, the discussion showed that the theory of formal language can provide a theoretical foundation to aid design thinking in BIM. Also, BIM can offer several methods to define the three components of a formal language: design elements, transformational rules, and design rules. Additionally, although it was suggested that BIM is a professionally-oriented tool that is highly specialized and consequently inadequate for conceptual design, the findings showed that the complexity of BIM can be reduced through adopting a *divide and conquer strategy* and multiple levels of *abstraction*. Further to this, the findings refuted the claim that BIM enforces the use of a supposedly architectural ontology based on the language of construction. Besides, the results showed that using BIM to aid design thinking requires a cognitive model or framework that integrates BIM with the higher cognitive skills of design. Furthermore, the results showed that using a dynamic and flexible representational system allows designers to integrate BIM in early design stages. Lastly, BIM facilitates a symbiotic relationship between the capabilities of the designer and the generative tool to enhance the capabilities of each partner.

Second, in terms of BIM and architectural design pedagogy, the findings revealed that AIM can be used to teach formal concepts in the early core design studio. This approach allows educators to teach formalism and computational design through active learning. In light of this, AIM provides another way to teach formalism and computation design that overcomes some of the limitations of using shape grammar to do that. Moreover, the findings showed that there is room for a new trajectory beyond the division of form-centric and construction-centric agendas. This new trajectory could be supported by a curriculum that integrates the two agendas by carefully using BIM to structure learning tasks, adding complexity to the AIM framework gradually.

Third, in terms of conducting research in design studio, the discussion illustrated that the adopted method in this research contributed a clearer understanding of design as a research process. The synthesis of findings shows that students' understanding of digital tools can be objectively assessed through strategies such as adopting a theoretical framework and triangulation of data and methods. Also, a unified presentation strategy was employed to review students' projects and eliminate confounding variables related to individual differences in graphics ability.

## 8. CONCLUSIONS AND FUTURE RESEARCH

The preceding chapters have developed a logical structure to support the research objectives and illustrate the key findings of this research. Chapter 1 introduced the research and presented key questions. Chapter 2 illustrated a review of literature that explored the theory of architectural design, the computability of architectural design knowledge, Building Information Modeling (BIM), and architectural design education. Chapter 3 outlined the research method that was employed to conduct this research. It discussed the used techniques and instruments in the development phase of the study and the validation phase of the study. Chapter 4 presented the development of the computational framework AIM and the test case. Chapter 5 presented the development of the pedagogical framework in an educational setting, the intervention study, and the expert panel. Chapter 6 presented the findings of the data collected during the intervention study and the expert panel. It discussed the results of the observations, the student survey, the content analysis of the writing assignments, and the analysis of students' projects from the expert panel. Chapter 7 provided a synthesis of the main findings in this research. The findings were discussed in relation to the research questions as well as the literature. The key findings were also discussed with respect to the formulated computational framework (AIM), the test case of Richard Meier, the pedagogical framework, and the intervention study.

This chapter concludes the research by providing a summary of the significance of the research and highlighting the main contributions. The limitations and the implications the research are discussed too. Lastly, the chapter concludes the research by providing recommendations for future research.

## **8.1. Significance of the research and contributions**

This research has produced significant original contributions in four areas. The first area deals with the use of Building Information Modeling (BIM). The second area is related to the theory of formal language and formal studies in architecture. The third area is related to architectural design education and the role of BIM in design studios. The fourth area deals with developing a research method to conduct research through design.

### ***8.1.1. BIM to AIM***

This research is the first time in which conceptual design is discussed and explored through integrating BIM and computational design. This research offers a new computational framework called AIM. AIM represents a shift from BIM as a construction-oriented modeling tool that is composed of 3D-building vocabulary into a design environment that can code architectural languages through vocabulary and syntactical rules. As a result, AIM allows the designer to use BIM to think, design, and generate multiple design options that incorporate explicit aesthetic and intellectual values. While BIM alone expresses the language of construction, AIM provides a structured method to represent the formal language of architecture explicitly and provide a generative description of an architectural style.

In contrary to the literature, this research showed that BIM can aid design thinking and support conceptual design. This research is the first to develop and test a computational framework that allows BIM to support conceptual design and integrate higher cognitive skills. Moreover, it employed several strategies (e.g., divide and conquer strategy, an adequate representational system, diagrammatic thinking) to overcome the limitations of BIM that were argued in the literature.



### ***8.1.2. Theory of formal language and formal studies in architecture***

This research exploited the theory of formal language as a rigorous theoretical foundation to aid design thinking in BIM. It establishes connections between approaching design as a formal language and the notion of BIM. On the other hand, in AIM, formal language is not just a theory. It is understood as a formal system. To design, means to create a generative system that can produce several design options. Therefore, in AIM, the notion of formal language was realized through the notion of system thinking. Moreover, this research presented a new way to understand the relationship between the abstract diagrams and the actual form. Both the abstract and the real exist simultaneously in the design environment. Therefore, the designer is forced to make precise or accurate conceptual diagrams that can exemplify a set of formal concepts. Additionally, this research contributed to the formal analysis and morphological studies in architecture. A generative description of the formal language of Richard Meier was presented.

### ***8.1.3. BIM in architectural education***

This research developed a pedagogical framework to implement AIM in an educational setting and tested that framework. The pedagogical framework offers a new way to teach formalism and computational concepts using BIM. For the first time, a third trajectory to teach BIM beyond the form-centric agenda and BIM-centric construction agenda is introduced. Students in the early core design studio can learn design fundamentals and learn BIM at the same time.

#### ***8.1.4. Design-based research method***

This research contributes a clearer understanding of design-based research. A mixed-methods approach to develop a computational design framework and test it in an educational setting was explored. Moreover, a method to objectively assess students' understanding of digital was introduced. Lastly, this research tested a projects review method that unifies presentations and graphical expressions. The review method proved to be effective to review a large number of projects in a short period of time. Besides, it helps to eliminate confounding variables related to individual differences in graphics ability.

### **8.2. Limitations**

The research has several limitations in consequence of research scope, research methods, participant samples, and other limitations related to conducting research in an educational setting.

**Research scope:** The stage of conceptual designs involves several aspects. In this research, the focus was only on developing architectural forms, defining the aesthetics of design, refining building program, and a basic understanding of the elements of construction. Other aspects such as materials, structures, environmental issues, site constraints other than topology, the meaning of form (i.e., semantic) and architectural experience were intentionally excluded from the scope of the research for many reasons. First, as shown in the literature, some of these topics BIM already can handle very well, such as materials, structures, and collaboration. Second, other topics were left for future research such as the meaning of form (i.e., semantic) and architectural experience. Furthermore, this research addresses the theory of formal language, which represents only one way to understand architectural design. Therefore, the findings of this

research do not imply that AIM can support all ways of design thinking. Further research in this area is needed. Lastly, this research focused only on whether BIM can aid design thinking or not. It did not compare BIM to other digital tools or methods, nor did it claim that this is the most appropriate way to approach conceptual design. Therefore, the findings should not be taken as evidence for such claims. However, the comparison between using AIM and other methods does suggest a direction for further research.

**Research method:** In the intervention study, the absence of a control group due to administrative constraints is one of the limitations in this research. However, it was not considered as a significant threat to the internal validity of the study because in the adopted research design (i.e., longitudinal mixed-methods design) the likelihood that extraneous factors account for the change was inconsiderable. Furthermore, the research makes use of distinctively novel methods in contrast to widely established norms that represent an implicit control group.

**Participant samples:** The expert panel had a modest number of participants because of budget constraints, time constraints, and individual schedules. Only a few people could come for two days to TAMU to participate in the panel. Nevertheless, the participants were carefully chosen to sample widely from possible the architectural education community.

**Educational research:** There are several limitations that emerged during the intervention study. First, students had a tight schedule that affected the time they dedicated to completing project 2 and project 3. Many of the students decided to use the first two weeks to study for their mid-term exams, and accordingly, they did not spend enough time on the project. Another limitation emerged from conducting the diagnostic assessment at the beginning of the semester only through a discussion with students. Although the curriculum of B.E.D program stated that the students of ARCH 205 were introduced to functional design principles and spatial

understanding in proportion to the scale of a human body in previous courses, most students did not show a great deal of knowledge retention. Accordingly, the pedagogical framework should be refined to include other types of diagnostic assessments. Furthermore, the expert panel stated that the pedagogical framework should include a more defined strategy to control the generation of various design options through establishing criteria for change. Lastly, teaching AIM can be limited by the analytical skills of the instructor or students. Other methods may be investigated to overcome this limitation, such as developing an automated method for formal analysis and revise the pedagogical framework to give students more time for the precedent study.

**Data analysis:** Qualitative research provides the researcher with complex '*rich data*' that can be analyzed, interpreted, and represented using various methods. Therefore, time is considered a significant factor in conducting qualitative research. In the intervention study, due to time and budget limitations, two other possible types of analysis were not considered because they are less significant to the stated objectives and hypotheses in this research. The first possible method focuses on analyzing the work of each student in the three projects and draw conclusions related to the learning patterns of students. The second method focuses on following the performance of students in the next semester and compare that to other students who did not take part in the intervention study. Finally, although these methods for analyzing the rich data of the intervention study were not addressed, they do suggest a direction for further research.

### **8.3. Implications of the research**

This research has implications on several levels. The relationship between BIM and conceptual design which is depicted in the computational framework AIM represents a new way to incorporate BIM in early design stages. As such, the research can contribute to introduce a

third trajectory to teach BIM beyond the form-centric and BIM-centric construction agendas. The research design in this study may provide a model for conducting design-based research in architectural education. Furthermore, this study may guide practitioners in a way to integrate BIM in the early design stages. This integration will streamline the information flow in the design process, supporting reuse of the information during the lifecycle of the building and across projects. Additionally, as shown in the test case of Richard Meier, AIM may be used in professional practice to define an explicit formal language that allows designers to control the quality of design, maintain formal consistency, communicate formal concepts, and externalize design intentions.

#### **8.4. Future research**

This research may evolve in two possible directions. The first direction address possible improvements to the computational framework AIM. The second direction focuses on implementing AIM in education and practice.

##### ***8.4.1. AIM development***

**Optimization:** Computational design, or parametric modeling, offers dynamic control over design parameters (e.g., geometry, components) in which designers can seek appropriate solutions with the assessment of multiple alternatives at the same time. This control, allows designers to modify and optimize designs to address various issues such as aesthetic preference; technical performance such as energy simulation, daylight simulation, cost estimating, structural analysis, code analysis; and other domains of performance (Rahmani Asl, Zarrinmehr, & Yan, 2013). In AIM framework, the formal language is expressed explicitly in terms of syntactical

rules and vocabulary. The language also includes parameters and data (geometric and non-geometric) that can be varied. These data can be utilized to produce variant design options that meet particular objectives such as daylighting and energy performance when its incorporated with other optimization frameworks such as BPOpt (Asl et al., 2015). There are many studies that have been conducted to incorporate BIM, using Autodesk Revit, to conduct simulation and optimization in field such as thermal and daylighting modeling (Jeong, Kim, Clayton, Haberl, & Yan, 2016), building envelop and energy saving (Gerber & Lin, 2014; Gerber, Lin, Pan, & Solmaz, 2012; Nour, Hosny, & Elhakeem, 2015), energy optimization and building components such as window sizes (Rahmani Asl et al., 2013) and kinetic facades (H. Kim, Asl, & Yan, 2015), as well as structural optimization (Humppi, 2015). In that sense, the complexity of AIM can be increased to incorporate some of these optimization methods. Accordingly, a formal language can be optimized to fulfill various objectives or criteria through utilizing the graphical (geometry) and non-graphical data in the Autodesk Revit conceptual design environment (CDE) and the project design environment (PDE).

**Virtual reality (VR):** The walkthrough mode in *Virtual reality* (VR) tools, such as Enscape and Autodesk Live, can be utilized to assess the aesthetics of architectural experience and highlight the content of form in AIM. The use of VR would also allow the designer to change the parameters of the design or change some design elements and assess the effect of these changes on the sensible form to achieve a preferred sensual experience.

**Other methods to define design vocabularies and rules:** More exploration is needed to investigate other possible methods to define design vocabularies and rules. This investigation can focus on developing appropriate methods to parametrically control more complex vocabularies

or even languages. Additionally, the possibility to integrate other design theories can be investigated.

**Automate the system:** One of the limitations of this research is related to the phase of analyzing an existing formal language. Since the analysis is done manually, any investigation in this area might be confined by the ability of the designer to comprehend and analyze a specific architectural style to encapsulate its underlying logic. Future research can be conducted to overcome this obstacle. Various research areas in artificial intelligence, machine learning, and computer vision can be applied to architectural design in order to automate this process. These areas include *shape matching* and *object recognition*, *symmetry detection* and *analysis*, *pattern recognition*, *pattern matching*, and *style learning*. However, the implementation of these methods in architecture is still limited.

#### ***8.4.2. Implementing AIM***

Further research is needed to implement AIM in education and professional practice. In *education*, future research may address the development of a curriculum that integrates the form-centric and BIM-centric agendas and allow educators to add complexity to the AIM framework gradually. Moreover, various recommendations were discussed to overcome the limitations of the pedagogical framework. These recommendations, as well as other possible improvements, can be incorporated to improve the pedagogical framework. Lastly, the benefit of implementing AIM in professional practice is an area that can be explored further.

## REFERENCES

- Ahlquist, S., & Menges, A. (2011). Introduction: Computational Design Thinking. In A. Menges & S. Ahlquist (Eds.), *Computational Design Thinking: Computation Design Thinking*: John Wiley & Sons.
- Ahmad, S., & Chase, S. C. (2012). Style representation in design grammars. *Environment and planning B: Planning and design*, 39(3), 486-500.
- Akin, Ö. (1990). Computational design instruction: toward a pedagogy. *Electronic Design Studio*, 301-316.
- Akin, Ö. (2015). Necessity of cognitive modeling in BIM's future. In K. Kensek & D. Noble (Eds.), *Building information modeling: BIM in current future practice* (pp. 17-27): John Wiley & Sons.
- Al-Assaf, N. (2014). *Understanding The Aesthetics Of Logical Form: A Comparative Study From Structuralism To Neo-Structuralism*. (Master of science in architecture), University of Jordan, Jordan.
- Al-Assaf, N., & Clayton, M. J. (2017). *Representing the Aesthetics of Richard Meier's Houses Using Building Information Modeling*. Paper presented at the ACADIA 2017: DISCIPLINES + DISRUPTION, Massachusetts Institute of Technology (MIT), Cambridge, MA.
- Al-Assaf, N., & Dahabreh, S. (2014). *The Aesthetics symptoms of architectural form: the case of Barcelona Museum of Contemporary Art*. Paper presented at the ARCHDESIGN '14 : Current Trends in Architectural Design and Methodologies, İstanbul, Turkey.



- Alexander, C. (1977). *A pattern language: towns, buildings, construction*: Oxford university press.
- Allen, S. (1999). Working Space: the uses of abstraction. In S. Allen (Ed.), *Richard Meier: Architect* (pp. 12-27). New York: Monacelli Press.
- Ambrose, M. (2009). Agent Provocateur–BIM and the Design Studio: Questioning Roles of Abstraction and Simulation in Design Education. *The Value of Design, ACSA, New York*, 85.
- Anay, H. (2012). (Epistemological) formalism and its influence on architecture: A Concise review. *A|Z ITU Journal of the Faculty of Architecture*, 9(1), 70-85.
- Anderson, W. L., Mitchell, S. M., & Osgood, M. P. (2005). Comparison of student performance in cooperative learning and traditional lecture-based biochemistry classes. 33(6), 387-393. doi:10.1002/bmb.2005.49403306387
- Apollonio, F. I., Gaiani, M., & Sun, Z. (2012). BIM-based modeling and data enrichment of classical architectural buildings. *J SCIRES-IT: SCientific RESearch Information Technology*, 2(2), 41-62.
- Argan, G. C. (1963). On the typology of architecture. *Architectural Design*, 33(12), 564-565.
- Arnold, R. D., & Wade, J. P. (2015). A definition of systems thinking: a systems approach. *Procedia computer science*, 44, 669-678.
- Asl, M. R., Zarrinmehr, S., Bergin, M., & Yan, W. (2015). BPOpt: A framework for BIM-based performance optimization. *Energy and Buildings*, 108, 401-412.
- Azizi, H. (2011). *Using pattern language for a single family house: teaching a beginning architecture design studio at Kabul University, Faculty of Engineering, Department of Architecture*. Kansas State University,

- Bachman, L. R. (2003). *Integrated buildings: the systems basis of architecture*: John Wiley & Sons.
- Baker, G. H. (1996). *Design strategies in architecture : an approach to the analysis of form*. 2nd ed. Geoffrey H. Baker: New York : Van Nostrand Reinhold
- Banathy, B. H., & Jenlink, P. M. (2003). Systems inquiry and its application in education. *Handbook of research for educational communications and technology*, 37-58.
- Barison, M. B., & Santos, E. T. (2010). *BIM teaching strategies: an overview of the current approaches*. Paper presented at the Proc., ICCCBCE 2010 international conference on computing in civil and building engineering.
- Barthes, R. (1972). The structuralist activity. *Critical essays*, 213-220.
- Becerik-Gerber, A. A., Burcin, Ku, K., & Jazizadeh, F. (2012). BIM-enabled virtual and collaborative construction engineering and management. *Journal of Professional Issues in Engineering Education and Practice*, 138(3), 234-245.
- Becerik-Gerber, B., Gerber, D. J., & Ku, K. (2011). The pace of technological innovation in architecture, engineering, and construction education: integrating recent trends into the curricula. *Journal of Information Technology in Construction*, 16(2011), 411-432.
- Bell, C. (1914). Art as significant form. eds. George Dickie, Richard Sclafani, Ronald Roblin, *Aesthetics: A Critical Anthology*, 73-83.
- Briscoe, D. (2015). *Beyond BIM: architecture information modeling*: Routledge.
- Broadbent, G. (1969). Design method in architecture. *Design methods in architecture*, 15-21.
- Broadbent, G. (1973). *Design in architecture: architecture and the human sciences*: John Wiley & Sons New York, USA.

- Cabrera, D., Colosi, L., & Lobdell, C. (2008). Systems thinking. *Evaluation and program planning*, 31(3), 299-310.
- Cagan, J., Campbell, M. I., Finger, S., & Tomiyama, T. (2005). A framework for computational design synthesis: model and applications. *Journal of Computing Information Science in Engineering*, 5(3), 171-181.
- Campbell, C. (2006). *Digital Design Pedagogy Setting the Foundation for Digital Design in the Architecture Curriculum*. Paper presented at the ACADIA 2006: Synthetic Landscapes Digital Exchange.
- Carley, K. (1990). Content analysis. *The encyclopedia of language linguistics*, 2, 725-730.
- Carlson, A. (1979). Formal Qualities in the Natural Environment. *Journal of Aesthetic Education*, 13(3), 99-114. doi:10.2307/3331996
- Carnell, B., & Fung, D. (2017). *Developing the Higher Education Curriculum: Research-based education in practice*: UCL Press.
- Carrara, G., Kalay, Y. E., & Novembri, G. (1994). Knowledge-based computational support for architectural design. *Automation in Construction*, 3(2-3), 157-175.
- Cassarà, S. (2005). *Richard Meier – Recent Works*: Universe.
- Celani, G. (2012). Digital Fabrication Laboratories: Pedagogy and Impacts on Architectural Education. In *Digital Fabrication* (pp. 469-482): Springer.
- Chase, S. C., & Koh, J. (2000). *Integration of Shape Grammars with Architectural Design Studio Projects*. Paper presented at the 2000 ACSA Technology Conference.
- Chase, S. C., & Liew, P. (2001). *A Systematic Method for Redesign-Using function, behaviour and structure to facilitate grammar transformation*. Paper presented at the Architectural Information Management :19th eCAADe Conference Proceedings Helsinki, Finland.

- Cheng, R. (2006). Suggestions for an integrative education. *Report on integrated practice*, 2.
- Chioncel, N. E., Veen, R. V. D., Wildemeersch, D., & Jarvis, P. (2003). The validity and reliability of focus groups as a research method in adult education. *International Journal of Lifelong Education*, 22(5), 495-517.
- Christenson, M. (2008). *Capabilities and limitations of Autodesk Revit in a construction technology course*. Paper presented at the Proceedings of the 2006 Building Technology Educators' Symposium, August 3-5, 2006, University of Maryland, School of Architecture, Planning, and Preservation.
- Cigolle, M., & Coleman, K. (1990). Computer integrated design: transformation as process. In M. McCullough, W. Mitchell, & P. Purcell (Eds.), *The Electronic Design Studio: Architectural Knowledge Media in the Computer Era* (pp. 333-346): CAAD Futures. Cambridge, Massachusetts: The MIT Press.
- Clayton, M. J. (2012). *Using BIM to aid diagrammatic reasoning about architectural aesthetic concepts*. Paper presented at the Design Computing and Cognition DCC'12.
- Clayton, M. J. (2014). Chapter 3: Modeling Architectural Meaning. In K. Kensek & D. Noble (Eds.), *Building Information Modeling: BIM in Current and Future Practice* (pp. 29-40): John Wiley & Sons.
- Clayton, M. J., Ozener, O., Haliburton, J., & Farias, F. (2010). *Towards Studio 21: Experiments in Design Education Using BIM*. Paper presented at the SIGraDi 2010 Proceedings of the 14th Congress of the Iberoamerican Society of Digital Graphics, SIGraDi, Bogota, Columbia.

- Coates, P., Arayici, Y., Koskela, L., Kagioglou, M., Usher, C., & O'Reilly, K. (2010). *The limitations of BIM in the architectural process*. Paper presented at the First International Conference on Sustainable Urbanization, Hong Kong, China
- Cohen, L., Manion, L., & Morrison, K. (2002). *Research methods in education*: Routledge.
- Colakoglu, B. (2005). Design by grammar: an interpretation and generation of vernacular hayat houses in contemporary context. *Environment and planning B: Planning and design*, 32(1), 141-149.
- Cook, T. D., Campbell, D. T., & Shadish, W. (2002). *Experimental and quasi-experimental designs for generalized causal inference*: Houghton Mifflin Boston, MA.
- Dahabreh, S. (2013). Douglas House: The Formation of a Language. *Ninth International Space Syntax, Seoul: Sejong University*, 2, 1-14.
- Dahabreh, S., & Al-Assaf, N. (2013). *The Aesthetics of Logical Form: The Case of The Smith House by Richard Meier*. Paper presented at the Arch Theo '13 :III. International Conference of Theory of Architecture, İstanbul, Turkey.
- Dans, E. (2014). The Absurd and Unfounded Myth of the Digital Native. *Jun*, 4, 2014.
- Dawes, M. J., & Ostwald, M. J. (2017). Christopher Alexander's A Pattern Language: analysing, mapping and classifying the critical response. *City, Territory, and Architecture*, 4(1), 17. doi:10.1186/s40410-017-0073-1
- Deamer, P. (2001). Structuring Surfaces: The Legacy of the Whites. *Perspecta*, 32, 90-99.
- Deamer, P. (2005). First year: the fictions of studio design. *Perspecta*, 36, 10-16.
- Deamer, P., & Bernstein, P. G. (2011). *BIM in Academia*: Yale School of Architecture.
- Denzer, A., & Hedges, K. (2008). From CAD to BIM: Educational strategies for the coming paradigm shift. *AEI*.

- Do, E. Y.-L., & Gross, M. D. (2001). Thinking with diagrams in architectural design. *Artificial Intelligence Review*, 15(1-2), 135-149.
- Dogan, F., & Nersessian, N. J. (2002). *Conceptual diagrams: representing ideas in design*. Paper presented at the International Conference on Theory and Application of Diagrams.
- Doyle, S., & Senske, N. (2016). *Between design and digital: bridging the gaps in architectural education*. Paper presented at the Architecture Conference Proceedings and Presentations. Paper 83.
- Dulić, O., & Aladžić, V. (2016). *A NOTE ON GRAPHICAL REPRESENTATIONS IN ARCHITECTURE–DIAGRAMS OVER SKETCHES*. Paper presented at the Proceedings of 4th International conference" Contemporary Achievements in Civil Engineering 2016.
- Eastman, C. (1994). A data model for design knowledge. *Automation in Construction*, 3(2-3), 135-147.
- Eastman, C., Teicholz, P., & Sacks, R. (2008). *BIM handbook: A guide to building information modeling for owners, managers, designers, engineers and contractors*: John Wiley & Sons.
- Economou, A. (2000). *Shape grammars in architectural design studio*. Paper presented at the 2000 ACSA Technology Conference. Hong Kong.
- Eden, A. H. (2001). *Formal specification of object-oriented design*. Paper presented at the International Conference on Multidisciplinary Design in Engineering.
- Eisenman, P. (1999). *Peter Eisenman: diagram diaries*: Thames & Hudson.
- Eisenman, P. (2006). *The formal basis of modern architecture. Peter Eisenman*: Baden, Switzerland : L. Müller, 2006.

- Ersanlı, C. Y. (2015). The relationship between students' academic self-efficacy and language learning motivation: A study of 8th graders. *Procedia-Social Behavioral Sciences*, 199, 472-478.
- Ewert, A., & Sibthorp, J. (2009). Creating outcomes through experiential education: The challenge of confounding variables. *Journal of Experiential Education*, 31(3), 376-389.
- Farrokhi, F., & Mahmoudi-Hamidabad, A. (2012). Rethinking Convenience Sampling: Defining Quality Criteria. *Theory Practice in Language Studies*, 2(4).
- Flemming, U. (1990). Syntactic structures in architecture: teaching composition with computer assistance. *The Electronic Design Studio: Architectural Knowledge and Media in the Computer Era*, MIT Press, Cambridge, Mass, 31-48.
- Frampton, K. (1975). Frontality vs. Rotation In P. Eisenman (Ed.), *Five Architects: Eisenman, Graves, Gwathmey, Hejduk, Meier*. New York: Oxford University Press.
- Frampton, K. (2003). *Richard Meier: Pall Mall*.
- Frankl, P. (1968). Principles of Architectural History, The Four Phases of Architectural Style 1420-1900, trans. *JF O'Gorman (Cambridge, Mass., 1968)*, 194.
- Gandelsonas, M., & Morton, D. (1972). On reading architecture. *Progressive architecture*, 53(3), 69-70.
- Garber, R. (2009). Optimisation stories: The impact of building information modelling on contemporary design practice. *Architectural Design*, 79(2), 6-13.
- Garrison, C., Chandler, D., & Ehringhaus, M. (2009). *Effective classroom assessment: Linking assessment with instruction*: National Middle School Association and Measured Progress.
- Gerber, D. J., & Lin, S.-H. E. (2014). Designing in complexity: Simulation, integration, and multidisciplinary design optimization for architecture. *Simulation*, 90(8), 936-959.

- Gerber, D. J., Lin, S.-H. E., Pan, B. P., & Solmaz, A. S. (2012). *Design optioneering: multi-disciplinary design optimization through parameterization, domain integration and automation of a genetic algorithm*. Paper presented at the Proceedings of the 2012 Symposium on Simulation for Architecture and Urban Design.
- Giovannini, J. (1996). Is Richard Meier really Modern. *Architecture*, 85(2), 65-69.
- Golafshani, N. (2003). Understanding reliability and validity in qualitative research. *The qualitative report*, 8(4), 597-606.
- Goodyear, P. (1999). Pedagogical frameworks and action research in open and distance learning. *European Journal of Open, Distance E-Learning*, 2(1).
- Goodyear, P. (2005). Educational design and networked learning: Patterns, pattern languages and design practice. *Australasian journal of educational technology*, 21(1).
- Gracia, M. (2010). *The Diagrams of Architecture: AD Reader*: Wiley.
- Groat, L. N., & Wang, D. (2013). *Architectural research methods*: John Wiley & Sons.
- Gross, M. D. (1985). *Design as exploring constraints*. Massachusetts Institute of Technology.
- Gu, N., & de Vries, B. (2012). *Two Approaches to Implementing BIM in Architectural Curricula*. Paper presented at the eCAADe 30, Czech Technical University, Prague.
- Hanna, G. S., & Dettmer, P. (2004). *Assessment for effective teaching: Using context-adaptive planning*: Allyn & Bacon.
- Harty, J., & Laing, R. A. (2010). Removing barriers to BIM adoption: clients and code checking to drive changes. *Handbook of research on building information modeling and construction informatics*.
- Hays, K. M. (1998). The oppositions of autonomy and history. *Oppositions Reader*.



- Hendrix, J. (2012). Theorizing a contradiction between form and function in architecture. *South African Journal of Art History* 27.1, 9-28.
- Hill, J. (2005). Building the drawing. *Architectural Design*, 75(4), 13-21.
- Hillier, B. (2007). *Space is the machine: a configurational theory of architecture*: Space Syntax.
- Holmberg, J. (2019). *Designing for added pedagogical value: A design-based research study of teachers' educational design with ICT*. Department of Computer and Systems Sciences, Stockholm University,
- Holzer, D. (2011). BIM's seven deadly sins. *International journal of architectural computing*, 9(4), 463-480.
- Horváth, I. (2000). *Conceptual design: inside and outside*. Paper presented at the Proceedings of the 2nd International Seminar and Workshop on Engineering Design in Integrated Product.
- Humppi, H. (2015). Algorithm-Aided Building Information Modeling: Connecting Algorithm-Aided Design and Object-Oriented Design.
- Ibrahim, M. (2014). *Thinking the BIM Way Early integration of Building Information Modelling in education*. Paper presented at the Fusion-Proceedings of the 32nd eCAADe Conference, Department of Architecture and Built Environment, Faculty of Engineering and Environment, Newcastle upon Tyne, England, UK.
- Ibrahim, M. S., Bridges, A., Chase, S. C., Bayoumi, S., & Taha, D. S. Use of Grammar for Shape Exploration with Novice Students.
- Jenkins, M., Bokosmaty, R., Brown, M., Browne, C., Gao, Q., Hanson, J., & Kupatadze, K. (2017). Enhancing the design and analysis of flipped learning strategies. *Teaching Learning Inquiry*, 5(1), 1-12.

- Jeong, W., Kim, J. B., Clayton, M. J., Haberl, J. S., & Yan, W. (2016). A framework to integrate object-oriented physical modelling with building information modelling for building thermal simulation. *Journal of Building Performance Simulation*, 9(1), 50-69.
- Johnson, J. S., & Vermillion, J. (2016). *Digital Design Exercises for Architecture Students*: Routledge.
- Kalay, Y. (1990, 22-25 Oct. 1990). *The computability of architectural design*. Paper presented at the Proceedings of the 5th Jerusalem Conference on Information Technology, 1990. 'Next Decade in Information Technology'.
- Kalay, Y., Swerdloff, L., & Majkowski, B. (1990). Process and knowledge in design computation. *Journal of Architectural Education*, 43(2), 47-53.
- Kensek, K. M. (2012). Advancing BIM in academia: Explorations in curricular integration. *Computational Design Methods and Technologies: Applications in CAD, CAM and CAE Education*, IGI-Global, PA, 101-121.
- Kim, H., Asl, M. R., & Yan, W. (2015). *Parametric BIM-based energy simulation for buildings with complex kinetic façades*. Paper presented at the Proceedings of the 33rd eCAADe Conference.
- Kim, M., Kirby, L., & Krygiel, E. (2016). *Mastering Autodesk Revit 2017 for Architecture*: John Wiley & Sons.
- Knight, T. (1981). Languages of designs: from known to new. *Environment and planning B: Planning and design*, 8(2), 213-238.
- Knight, T. (1986). *Transformations of languages of design*. (University of California Los Angeles ),

- Knight, T. (1995). *Transformations in design: a formal approach to stylistic change and innovation in the visual arts*: Cambridge University Press.
- Knight, T. (1999). *Applications in architectural design, and education and practice*. Paper presented at the NSF/MIT Workshop on Shape Computation.
- Koning, H., & Eizenberg, J. (1981). The language of the prairie: Frank Lloyd Wright's prairie houses. *Environment and planning B: Planning and design*, 8(3), 295-323.
- Kvan, T., Mark, E., Oxman, R., & Martens, B. (2004). Ditching the dinosaur: Redefining the role of digital media in education. *IJDC*, 8(01).
- Kweon, Y. (2002). A Comparative Study on Centrality in Museum Layouts-In the Case of the Royal Museum of Scotland and Burrell Gallery. *Journal of Asian Architecture Building Engineering*, 1(1), 205-212.
- Langer, S. (1967). *An Introduction to Symbolic Logic*: New York: Dover.
- Leeuwen, v., J. P. (1999). *Modelling architectural design information by features : an approach to dynamic product modelling for application in architectural design*. Eindhoven: Technische Universiteit Eindhoven,
- Lefavre, L., & Tzonis, A. J. H. A. R. (1984). The question of autonomy in architecture. 3(WIN), 27.
- Lewthwaite, S., & Nind, M. (2016). Teaching research methods in the social sciences: expert perspectives on pedagogy and practice. *British Journal of Educational Studies*, 64(4), 413-430.
- Li, X., Schmidt, L. C., He, W., Li, L., & Qian, Y. (2004). Transformation of an EGT grammar: new grammar, new designs. *Journal of Mechanical Design*, 126(4), 753-756.
- Logan, B. (1989). Conceptualizing design knowledge. *Design Studies*, 10(3), 188-195.

- Luhan, G. A. (2016). *Measurement of Self-Efficacy, Predisposition for Collaboration, and Project Scores in Architectural Design Studios*. (Doctoral dissertation), Texas A&M University Available electronically from <http://hdl.handle.net/1969.1/158950>.
- Madraza, L. (1994). Durand and the Science of Architecture. *Journal of Architectural Education* (1984-), 48(1), 12-24. doi:10.2307/1425306
- Mandhar, M., & Mandhar, M. (2013). BIMing the architectural curricula: integrating Building Information Modelling (BIM) in architectural education. *International Journal of Architecture*, 1(1), 1-20.
- Marcos, C. (2017). BIM Implications in the Design Process and Project-Based Learning: Comprehensive Integration of BIM in Architecture. *WIT Transactions on The Built Environment*, 169, 113-125.
- Mathew, A., & Barrow, L. (2004). *Digital Design Methodology and Terminology: Evolving a Formal Language Framework for Pedagogy and Practice*. Paper presented at the 2003-05 EAAE Proceedings: Writings in Architectural Education.
- Mathews, L. G., Jones, A., Szostak, R., & Repko, A. (2008). Using systems thinking to improve interdisciplinary learning outcomes: Reflections on a pilot study in land economics. *Issues in Interdisciplinary Studies*.
- McLeod, G. (2003). Learning theory and instructional design. *Learning Matters*, 2(3), 35-43.
- McPeck, K. T. (2009). *Collaborative design pedagogy: A naturalistic inquiry of architectural education*. (Doctoral dissertation), Texas A&M University Available electronically from <http://hdl.handle.net/1969.1/ETD-TAMU-2009-05-541>.
- Michalatos, P. (2016). Design Signals: The Role of Software Architecture and Paradigms in Design Thinking and Practice. *Architectural Design*, 86(5), 108-115.

- Mitchell, W. (1975). The theoretical foundation of computer-aided architectural design. *Environment and planning B: Planning and design*, 2(2), 127-150.
- Mitchell, W. (1986). Formal representations: a foundation for computer-aided architectural design. *Environment and planning B: Planning and design*, 13(2), 133-162.
- Mitchell, W. (1990). *The logic of architecture: Design, computation, and cognition*: JSTOR.
- Montana-Hoyos, C., & Lemaitre, F. (2011). Systems thinking, disciplinarity and critical thinking in relation to creativity within contemporary arts and design education. *SLEID Journal, Studies in Learning, Evaluation, Innovation and Development*, 8(2), 12-25.
- Morgan, D. L. (1996). *Focus groups as qualitative research* (Vol. 16): Sage publications.
- Morse, J. M., Barrett, M., Mayan, M., Olson, K., & Spiers, J. (2002). Verification strategies for establishing reliability and validity in qualitative research. *International journal of qualitative methods*, 1(2), 13-22.
- Norberg-Schulz, C. (1965). *Intentions in architecture*: MIT press.
- Nour, M., Hosny, O., & Elhakeem, A. (2015). A BIM based approach for configuring buildings' outer envelope energy saving elements. *Journal of Information Technology in Construction (ITcon)*, 20(13), 173-192.
- Ockman, J. (2012). *Architecture school: three centuries of educating architects in North America*: MIT Press.
- Oppenheimer, M. (2017). Histories of Design Pedagogy Virtual Special Issue for Journal of Design History. *Journal of Design History*, 1-24.
- Oxman, R., & Oxman, R. (1989). *The Joy of Syntax*. Paper presented at the CAAD: Education - Research and Practice: eCAADe Conference Proceedings, 531-5326. eCAADe: Conferences. , Aarhus, Denmark.

- Oxman, R., & Oxman, R. (1990). The computability of architectural knowledge. *The Electronic Design Studio: Architectural Knowledge and Media in the Computer Era*, 171-187.
- Oxman, R., & Oxman, R. (1994). Case-based design: cognitive models for case libraries. *Knowledge-based computer-aided architectural design*, 45-68.
- Parthenios, P. (2005). *Conceptual design tools for architects*: Harvard University.
- Pauwels, P., Verstraeten, R., De Meyer, R., & Van Campenhout, J. (2008). *Architectural information modelling for virtual heritage application*. Paper presented at the International Conference on Virtual Systems and Multimedia (VSMM).
- Pauwels, P., Verstraeten, R., De Meyer, R., & Van Campenhout, J. (2009a). *Architectural information modelling to address limitations of BIM in the design practice*. Paper presented at the 5th Conference on Information and Knowledge Management in Building (CIB W102 2009): Deconstructing Babel: sharing global construction knowledge.
- Pauwels, P., Verstraeten, R., De Meyer, R., & Van Campenhout, J. (2009b). Semantics-based design: can ontologies help in a preliminary design phase? *Design principles practices. An international journal*, 3(5), 263-276.
- Pevsner, N. (1972). *An outline of European architecture*. Baltimore: Penguin.
- Plano Clark, V. L., Anderson, N., Wertz, J. A., Zhou, Y., Schumacher, K., & Miaskowski, C. (2015). Conceptualizing longitudinal mixed methods designs: a methodological review of health sciences research. *Journal of Mixed Methods Research*, 9(4), 297-319.
- Prensky, M. (2001). Digital natives, digital immigrants part 1. *On the horizon*, 9(5), 1-6.
- Pupo, R., Pinheiro, E., Mendes, G., Kowaltowski, D., & Celani, G. (2007). *A design teaching method using shape grammars*. Paper presented at the Proc. 7th Int. Conf. Graphics Engineering for Arts and Design.

- Rahmani Asl, M., Zarrinmehr, S., & Yan, W. (2013). *Towards BIM-based parametric building energy performance optimization*. Paper presented at the ACADIA 2013 Adaptive Architecture Cambridge, Ontario, Canada.
- Roehl, A., Reddy, S. L., & Shannon, G. J. (2013). The flipped classroom: An opportunity to engage millennial students through active learning strategies. *Journal of Family Consumer Sciences*, 105(2), 44-49.
- Rush, R. D. (1986). *The building systems integration handbook*: American Institute of Architects. Butterworth-Heinemann.
- Rykwert, J. (1999). The Third Installment. In K. Frampton & J. Rykwert (Eds.), *Richard Meier, Architect, Vol. 3: 1992-1998*. New York, NY: Rizzoli.
- Salama, A. (1995). *New trends in architectural education: Designing the design studio*: Art-arch.
- Salama, A. (2005). *Skill-based/knowledge-based architectural pedagogies: An argument for creating humane environments*. Paper presented at the 7th International Conference on Humane Habitate-ICHH.
- Schlomer, G. L., Bauman, S., & Card, N. A. (2010). Best practices for missing data management in counseling psychology. *Journal of Counseling psychology*, 57(1), 1.
- Schnabel, M. A. (2007). Parametric designing in architecture. *Computer-Aided Architectural Design Futures (CAADFutures) 2007*, 237-250.
- Schön, D. A. (1985). *The design studio: An exploration of its traditions and potentials*: International Specialized Book Service Incorporated.
- Serriano, P. (2003). *Form follows software*. Paper presented at the Annual Conference Of The Association For Computer Aided Design, Indianapolis.

- Shafiq, M. T., Matthews, J., & Lockley, S. R. (2012). Requirements for model server enabled collaborating on building information models. *International Journal of 3-D Information Modeling (IJ3DIM)*, 1(4), 8-17.
- Shenton, A. K. J. E. f. i. (2004). Strategies for ensuring trustworthiness in qualitative research projects. *Education for information*, 22(2), 63-75.
- Simitch, A., & Warke, V. (2014). *The language of architecture: 26 principles every architect should know*: Rockport Pub.
- Simon, M. (2012). Design Pedagogy : Changing approaches to teaching design In J. Ockman (Ed.), *Architecture school: three centuries of educating architects in North America*: MIT Press.
- Sinclair, A. (2009). Provocative pedagogies in e-learning: Making the invisible visible. *International Journal of Teaching Learning in Higher Education*, 21(2), 197-212.
- Skyttner, L. (2005). *General systems theory: problems, perspectives, practice*: World scientific.
- Smith, D. K., & Tardif, M. (2009). *Building information modeling: a strategic implementation guide for architects, engineers, constructors, and real estate asset managers*: John Wiley & Sons.
- Steadman, P. (2008). *The Evolution of Designs: Biological analogy in architecture and the applied arts*: Routledge.
- Sterling, S. (2003). *Whole systems thinking as a basis for paradigm change in education: Explorations in the context of sustainability*. University of Bath,
- Stiny, G., & Gips, J. (1978). *Algorithmic aesthetics: computer models for criticism and design in the arts*: Univ of California Press.



- Stiny, G., & Mitchell, W. J. (1978). The palladian grammar. *Environment and planning B: Planning and design*, 5(1), 5-18.
- Terzidis, K. (2006). *Algorithmic architecture*: Routledge.
- Theodoropoulou, A. (2007). *Architectural authorship in generative design*. UCL (University College London),
- Till, J. (2009). *Architecture depends* (Vol. 55): MIT press.
- Tovey, M. M. (2015). *Design pedagogy: Developments in art and design education*: Routledge.
- Ulusoy, Z. (1999). To design versus to understand design: the role of graphic representations and verbal expressions. *Design Studies*, 20(2), 123-130. doi:[https://doi.org/10.1016/S0142-694X\(98\)00030-1](https://doi.org/10.1016/S0142-694X(98)00030-1)
- Utaberta, N., & Hassanpour, B. (2012). Reconstructing a Framework for Criteria-Based Assessment and Grading in Architecture Design Studio. *Procedia-Social Behavioral Sciences*, 60, 142-149.
- Vaismoradi, M., Turunen, H., & Bondas, T. (2013). Content analysis and thematic analysis: Implications for conducting a qualitative descriptive study. *Nursing health sciences*, 15(3), 398-405.
- von Bertalanffy, L. (1972). The history and status of general systems theory. *Academy of Management Journal*, 15(4), 407-426.
- Wang, T. (2010). A new paradigm for design studio education. *International Journal of Art & Design Education*, 29(2), 173-183.
- Watanabe, S. (1994). Knowledge integration for architectural design. *Automation in Construction*, 3(2-3), 149-156.

Wölfflin, H., Ballangé, G., & Teyssèdre, B. (1967). *Renaissance and baroque*: Cornell University Press Ithaca, NY.

Wortham, S. (2003). Learning in education. *GSE Publications*, 82.

Yan, H., & Demian, P. (2008). *Benefits and barriers of building information modelling*. Paper presented at the 12th International Conference on Computing in Civil and Building Engineering (ICCCBE XII) & 2008 International Conference on Information Technology in Construction (INCITE 2008), Beijing, China.

## APPENDIX I

### **Recruitment Script-Students**

You are being invited to take part in a research study entitled: Architectural Information Modeling (AIM): Teaching Formal Concepts of Design Using Building Information Modeling (BIM). This research will focus on the use of Building Information Modeling (BIM) to aid design thinking and communicate formal concepts in design studios.

Although you will not get personal benefit from taking part in this research study, your responses may help us to help us to in developing new pedagogical framework that integrates formal design theories and BIM tools in design studios.

You are being invited to take part in this research study because you are a student enrolled in ARCH205 in the Texas A&M University College of Architecture-Department of Architecture.

Your participation will involve complete a consent form during this session. During the semester, you will be asked to take a brief survey that measures your understanding of architectural design and digital tool. This procedure will be repeated three times over the course of the semester (pre-test at the beginning of the semester, post-test at or about midterm review, and post-test, at or about final review). Your midterm and final projects will be collected and evaluated by a cadre of external evaluators who will assess your work. This score will not be shared with anyone outside of the study team and will have no impact on your course grade. Your participation in this study will last up to 30-minutes over the course of the entire fall semester. This will include completing the survey as noted above.

Your participation in this research is voluntary, and you have the choice whether or not to be in this research study. You may decide to not begin or to stop participating at any time. If you choose not to be in this study or stop being in the study, there will be no effect on your academic standing as a student. Please note, that you should not take part in this study if you are under the age of 18.

We do not anticipate risks and discomforts beyond those you would normally experience in the course of your daily life and coursework.

Your response to the survey is anonymous which means no names will appear or be used on research documents, or be used in presentations or publications. The research Principal Investigator will not know that any information you provided came from you, nor even whether you participated in the study. Your information will be combined with information from other people taking part in the study. When we write about the study to share it with other researchers, we will write about the combined information we have gathered. You will not be personally identified in these written materials. We may publish the results of this study; however, we will keep your name and other identifying information private.

Please be aware, while we make every effort to safeguard your data once received from Qualtrics - the online survey/data gathering company, given the nature of online surveys, as with anything involving the Internet, we can never guarantee the confidentiality of the data while still on the survey/data gathering company's servers, or while en route to either them or us. It is also possible the raw data collected for research purposes may be used for marketing or reporting purposes by the survey/data gathering company after the research is concluded, depending on the company's Terms of Service and Privacy policies.

If you have questions about the study, please feel free to ask; my contact information is given below. If you have complaints, suggestions, or questions about your rights as a research volunteer, contact the staff in the Texas A&M Office of Research Integrity.

## APPENDIX II

### Students survey

#### Part one: Identification

1. Please identify yourself by providing UIN?

#### Part Two: Students' understanding of design

Based on the most recently accomplished task, answer the following questions:

1. On a scale of 1 – 5 with 5 being the most positive, I think design can be approached as a systematic process that has an underlying logic:

1      2      3      4      5

2. On a scale of 1 – 5 with 5 being the most positive, I can describe the main elements/ vocabulary that I used in my project.

1      2      3      4      5

3. On a scale of 1 – 5 with 5 being the most positive, I can describe the main rules/ syntax that I used in my project.

1      2      3      4      5

4. On a scale of 1 – 5 with 5 being the strongest, rate the influence of real life constraints on your design. These constraints include using elements of construction (not only conceptual elements such as plane, cube etc.), and being aware of the details of these elements and the requirements of using each one of them (e.g. where and how to start and end a wall or column).

1	2	3	4	5
<input type="radio"/>	<input type="radio"/>	<input type="radio"/>	<input type="radio"/>	<input type="radio"/>

### **Part Three: Students' understanding of diagrams**

Based on the most recently accomplished task, answer the following questions:

1. On a scale of 1 – 5 with 5 being the strongest, diagrams played an analytical role in my design. It helped me to communicate my ideas and explain form development.

1	2	3	4	5
<input type="radio"/>	<input type="radio"/>	<input type="radio"/>	<input type="radio"/>	<input type="radio"/>

2. On a scale of 1 – 5 with 5 being the strongest, diagrams played a generative role in my design. It helped me in developing my form, thinking about my design, and laying out my design elements according to some predefined rules.

1	2	3	4	5
<input type="radio"/>	<input type="radio"/>	<input type="radio"/>	<input type="radio"/>	<input type="radio"/>

#### Part Four: Students' understanding of the role of (BIM) digital tools

Based on the most recently accomplished task, answer the following questions:

1. On a scale of 1-5 with 5 being the strongest influence, rate the following aspects of the digital tools (Revit) that you used as to their likelihood of contributing to your design:

	1	2	3	4	5
<b>Model your design</b>	<input type="radio"/>	<input type="radio"/>	<input type="radio"/>	<input type="radio"/>	<input type="radio"/>
<b>Visualize your design</b>	<input type="radio"/>	<input type="radio"/>	<input type="radio"/>	<input type="radio"/>	<input type="radio"/>
<b>Design : to create architectural forms</b>	<input type="radio"/>	<input type="radio"/>	<input type="radio"/>	<input type="radio"/>	<input type="radio"/>
<b>Theoretical knowledge</b>	<input type="radio"/>	<input type="radio"/>	<input type="radio"/>	<input type="radio"/>	<input type="radio"/>
<b>Construction knowledge</b>	<input type="radio"/>	<input type="radio"/>	<input type="radio"/>	<input type="radio"/>	<input type="radio"/>
<b>Select your design elements / vocabulary</b>	<input type="radio"/>	<input type="radio"/>	<input type="radio"/>	<input type="radio"/>	<input type="radio"/>
<b>Determine your design rules</b>	<input type="radio"/>	<input type="radio"/>	<input type="radio"/>	<input type="radio"/>	<input type="radio"/>
<b>Judge the aesthetics of your design</b>	<input type="radio"/>	<input type="radio"/>	<input type="radio"/>	<input type="radio"/>	<input type="radio"/>
<b>Develop and elaborate your formal ideas</b>	<input type="radio"/>	<input type="radio"/>	<input type="radio"/>	<input type="radio"/>	<input type="radio"/>



**Part Five: Students' ability to generate multiple design options with consistence style**

Based on the most recently accomplished task, answer the following questions:

1. On a scale of 1 – 5 with 5 being the most positive, generating multiple design options is process that consumes a lot of time (e.g. 3-7 days per option).

1	2	3	4	5
<input type="radio"/>	<input type="radio"/>	<input type="radio"/>	<input type="radio"/>	<input type="radio"/>

2. On a scale of 1 – 5 with 5 being the most positive, I can maintain a consistent style or formal expression (in terms of organizational rules and architectural elements) while generating multiple design options.

1	2	3	4	5
<input type="radio"/>	<input type="radio"/>	<input type="radio"/>	<input type="radio"/>	<input type="radio"/>

3. On a scale of 1 – 5 with 5 being the most positive, I can develop my own style or formal expression.

1	2	3	4	5
<input type="radio"/>	<input type="radio"/>	<input type="radio"/>	<input type="radio"/>	<input type="radio"/>

4. On a scale of 1 – 5 with 5 being the most positive, I can change the style or the formal expression of my design into another one (by changing the design elements and organizational principles).

1	2	3	4	5
<input type="radio"/>	<input type="radio"/>	<input type="radio"/>	<input type="radio"/>	<input type="radio"/>

### Part six: Students' level of self-efficacy

Based on the most recently accomplished task, answer the following questions:

1. On a scale of 1 – 5, how certain you are that you can use representational media (e.g. models, drawings) to communicate your design ideas:

1	2	3	4	5
<input type="radio"/>	<input type="radio"/>	<input type="radio"/>	<input type="radio"/>	<input type="radio"/>

2. On a scale of 1 – 5, how confident you are in using digital media to design:

1	2	3	4	5
<input type="radio"/>	<input type="radio"/>	<input type="radio"/>	<input type="radio"/>	<input type="radio"/>

3. On a scale of 1 – 5, how certain you are that you can thoroughly analyze the precedents that you choose for your design:

1	2	3	4	5
<input type="radio"/>	<input type="radio"/>	<input type="radio"/>	<input type="radio"/>	<input type="radio"/>

4. On a scale of 1 – 5, how certain you are that you can use principles derived from precedents to inform your design:

1	2	3	4	5
<input type="radio"/>	<input type="radio"/>	<input type="radio"/>	<input type="radio"/>	<input type="radio"/>

5. On a scale of 1 – 5, how confident you are that you can use formal organizational principles to inform your design:

1	2	3	4	5
<input type="radio"/>	<input type="radio"/>	<input type="radio"/>	<input type="radio"/>	<input type="radio"/>

6. On a scale of 1 – 5, how would you rate your design skills:

1	2	3	4	5
<input type="radio"/>	<input type="radio"/>	<input type="radio"/>	<input type="radio"/>	<input type="radio"/>

7. On a scale of 1 – 5 with 5 being the most positive, how confident you are that you can deal efficiently with similar new design tasks (i.e. design new single-family house):

1      2      3      4      5

8. On a scale of 1 – 5 with 5 being the most positive, how confident you are that you can deal efficiently with new design tasks (not only single-family houses):

1      2      3      4      5

9. On a scale of 1 – 5 with 5 being the most positive, how confident you are that you can make decisions about your design, solve most problems if you invest the necessary effort, and accomplish my goals:

1      2      3      4      5

## APPENDIX III

### IRB Approval

DIVISION OF RESEARCH



#### EXEMPTION DETERMINATION

September 26, 2018

Type of Review:	IRB Amendment
Title:	Architectural Information Modeling (AIM): Teaching Formal Concepts of Design Using Building Information Modeling (BIM).
Investigator:	Mark J Clayton
IRB ID:	IRB2018-0557M
Reference Number:	081902
Funding:	
Documents Reviewed:	IRB Amendment - (Version 1.0) IRB Application (Human Research) - (Version 1.0) STUDENTS_ HRPP Informed consent (English) - (Version 1.0 Approved on 09/26/2018 ) Appendix III _Focus group_ Reviewers (1) - (Version 1.0 Approved on 09/26/2018 ) VII_ Recruitment Script- Design Reviewers (2) - (Version 1.0 Approved on 09/26/2018 ) VI_ Recruitment Script- Design Reviewers (1) - (Version 1.0 Approved on 09/26/2018 ) V_ Recruitment Script- Students - (Version 1.0 Approved on 09/26/2018 ) Appendix III _Focus group_ Reviewers (1) - (Version 1.0 Approved on 09/26/2018 ) Appendix II _Students Survey - (Version 1.0 Approved on 09/26/2018 ) Appendix IV _Reviewers (2) - (Version 1.0 Approved on 09/26/2018 ) Appendix IV _Reviewers (2) - (Version 1.0 Approved on 09/26/2018 )

Dear Mark J Clayton:

The HRPP determined on 08/15/2018 that this research still meets the criteria for Exemption in accordance with 45 CFR 46.101(b) under Category 1: Research conducted in established or commonly accepted educational settings, involving normal educational practices.

750 Agronomy Road, Suite 2701  
1186 TAMU  
College Station, TX 77843-1186

Tel. 979.458.1467 Fax. 979.862.3176  
<http://rcb.tamu.edu>

Category 2: Research involving the use of educational tests (cognitive, diagnostic, aptitude, achievement), survey procedures, interview procedures or observation of public behavior unless, the information is obtained in an identifiable manner and any disclosure of the subjects responses outside of research could reasonably place the subject at risk..

Your exemption is good for five (5) years from the Approval Start Date. At that time, you must contact the IRB with your intent to close the study or request a new determination.

**Please note that due to a change in HRPP policy, we are again stamping documents for exempt studies, which is why additional documents were attached to this submission.**

If you have any questions, please contact the IRB Administrative Office at 1-979-458-4067, toll free at 1-855-795-8636.

Sincerely,  
IRB Administration

## APPENDIX IV

### Students Consent Form

---

TEXAS A&M UNIVERSITY HUMAN RESEARCH PROTECTION PROGRAM  
STUDENTS - INFORMED CONSENT DOCUMENT

---

Project Title: **Architectural Information Modeling (AIM): Teaching Formal Concepts of Design Using Building Information Modeling (BIM).**

**You are invited to take part in a research study being conducted by Nancy Al-Assaf, the Protocol Director, a researcher from Texas A&M University, and Dr. Mark J. Clayton, the Study Principal Investigator. The information in this form is provided to help you decide whether or not to take part. If you decide to take part in the study, you will be asked to sign this consent form. If you decide you do not want to participate, there will be no penalty to you, and you will not lose any benefits you normally would have. You may choose to withdraw from the study at any time without penalty. NOTE: If you are employed then it is your responsibility to work with your employer regarding work leave for participation in this study if during work hours.**

#### **Why Is This Study Being Done?**

The purpose of this study is to study the use of Building Information Modeling (BIM) to aid design thinking and communicate formal concepts in design studios. By doing so, the researchers aim to develop new pedagogical framework that integrates formal design theories and BIM tools in design studios rather than teaching them separately.

#### **Why Am I Being Asked To Be In This Study?**

You are being asked to be in this study because you are a student enrolled in ARCH 205 design studio course in the College of Architecture-Department of Architecture at Texas A&M University.

#### **How Many People Will Be Asked To Be In This Study?**

Fifty-five (55) people (participants) will be invited to participate in this study locally.

#### **What Are the Alternatives to being in this study?**

The alternatives to participation are either to sign up for another study (another ARCH205 section) or staying at the same section and choosing not to participate. By choosing staying at the same section and not to participate, the Principal Investigator and Protocol Director will not know who decided to participate or not.

#### **What Will I Be Asked To Do In This Study?**

You will be asked to take a brief survey that measures your understanding of architectural design and digital tool. This procedure will be repeated three times over the course of the semester (pre-test at the beginning of the semester, post-test at or about midterm review, and post-test, at or about final review). Your midterm and final projects will be collected and evaluated by a cadre of external evaluators. They will assess your work and determine a project score. This score will not be shared with anyone outside of the study team and will have no impact on your course grade. Your participation in this study will last up to 30-minutes over the course of the entire fall semester. This will include completing the survey as noted above.

**TEXAS A&M UNIVERSITY HUMAN RESEARCH PROTECTION PROGRAM**  
**STUDENTS - INFORMED CONSENT DOCUMENT**

---

\_\_\_\_\_ I give my permission for my projects and assignments to be accessed for use in this research study.

\_\_\_\_\_ I do not give my permission for my projects and assignments to be accessed for use in this research study.

**Are There Any Risks To Me?**

The things that you will be doing are no more than risks than you would come across in everyday life.

**Will There Be Any Costs To Me?**

Aside from your time, there are no costs for taking part in the study.

**Will I Be Paid To Be In This Study?**

You will not be paid for being in this study.

**Will Information From This Study Be Kept Private?**

The records of this study will be kept private. No identifiers linking you to this study will be included in any sort of report that might be published. Research records will be stored securely and only the data broker / "Honest Broker" in Student Services will have access to the linked data and records.

Information about you will be stored on a secure, password-protected server located on the Texas A&M University campus in the College of Architecture, Building Langford A. Printed materials will be stored in a locked file cabinet. This consent form will be filed securely in an official area.

People who have access to your information include the Principal Investigator and research study personnel, however, any information that is sent to them will be coded with a number so that they cannot tell whom you are. The honest broker is the only person who can see information that is linked to you and has your name on it. If there are any reports about this study, your name will not be in them. Representatives of regulatory agencies such as the Office of Human Research Protections (OHRP) and entities such as the Texas A&M University Human Subjects Protection Program may access your records to make sure the study is being run correctly and that information is collected properly.

Information about you and related to this study will be kept confidential to the extent permitted or required by law.

**TEXAS A&M UNIVERSITY HUMAN RESEARCH PROTECTION PROGRAM**  
**STUDENTS - INFORMED CONSENT DOCUMENT**

---

**Who may I Contact for More Information?**

You may contact the Principal Investigator, Dr. Mark J. Clayton to tell him about a concern or complaint about this research at 979-845-2300 or [mark-clayton@tamu.edu](mailto:mark-clayton@tamu.edu). You may also contact the Protocol Director, Nancy Al-Assaf at 979-402-9988 or [nancy.lassaf@tamu.edu](mailto:nancy.lassaf@tamu.edu).

For questions about your rights as a research participant, to provide input regarding research, or if you have questions, complaints, or concerns about the research, you may call the Texas A&M University Human Research Protection Program (HRPP) by phone at 1-979-458-4067, toll free at 1-855-795-8636, or by email at [irb@tamu.edu](mailto:irb@tamu.edu). The informed consent form and all study materials should include the IRB number, approval date, and expiration date. Please contact the HRPP if they do not.

**What if I Change My Mind About Participating?**

Your participation in this research is voluntary, and you have the choice whether or not to be in this research study. You may decide to not begin or to stop participating at any time. If you choose not to be in this study or stop being in the study, there will be no effect on your academic standing as a student. Any new information discovered about the research will be provided to you. This information could affect your willingness to continue your participation.



**TEXAS A&M UNIVERSITY HUMAN RESEARCH PROTECTION PROGRAM**  
**STUDENTS - INFORMED CONSENT DOCUMENT**

---

**STATEMENT OF CONSENT**

**I agree to be in this study and know that I am not giving up any legal rights by signing this form. The procedures, risks, and benefits have been explained to me, and my questions have been answered. I know that new information about this research study will be provided to me as it becomes available and that the researcher will tell me if I must be removed from the study. I can ask more questions if I want. A copy of this entire consent form will be given to me [or can be printed from this survey].**

\_\_\_\_\_  
Participant's Signature

\_\_\_\_\_  
Date

\_\_\_\_\_  
Printed Name

\_\_\_\_\_  
Date

**INVESTIGATOR'S AFFIDAVIT:**

Either I have or my agent has carefully explained to the participant the nature of the above project. I hereby certify that to the best of my knowledge the person who signed this consent form was informed of the nature, demands, benefits, and risks involved in his/her participation.

\_\_\_\_\_  
Signature of Presenter

\_\_\_\_\_  
Date

\_\_\_\_\_  
Printed Name

\_\_\_\_\_  
Date

## APPENDIX V

### Expert Panel Recruitment Email

Dear [NAME OF RECIPIENT]

My name is Nancy Al-Assaf, and I am a doctoral student in College of Architecture at Texas A&M University. I am conducting a research study examining the use of Building Information Modeling (BIM) to aid design thinking and communicate formal concepts in design studios. You are invited to participate in the study because you are a faculty member teaching in a design studio in USA.

The Principal Investigator and Protocol Director of this project would like to request your help in developing new pedagogical framework that integrates formal design theories and BIM tools in design studios. Your participation will involve participating in a focus group at Texas A&M University, College of Architecture. In this study, you will be asked to evaluate and comment on students' projects. Participation in this study is voluntary. Your identity as a participant is *not* anonymous during and after the study.

If you have questions about the study, please contact me below.

Sincerely,  
Nancy Al-Assaf  
PhD Candidate in Architecture  
Department of Architecture | College of Architecture  
Texas A&M University  
(979) 403-9988  
E-mail: nancy.alassaf@tamu.edu

## APPENDIX VI

### Expert Panel Consent Form

---

TEXAS A&M UNIVERSITY HUMAN RESEARCH PROTECTION PROGRAM  
REVIEWERS 1 - INFORMED CONSENT DOCUMENT

---

Project Title: **Architectural Information Modeling (AIM): Teaching Formal Concepts of Design Using Building Information Modeling (BIM).**

**You are invited to take part in a research study being conducted by Nancy Al-Assaf, the Protocol Director, a researcher from Texas A&M University, and Dr. Mark J. Clayton, the Study Principal Investigator. The information in this form is provided to help you decide whether or not to take part. If you decide to take part in the study, you will be asked to sign this consent form. If you decide you do not want to participate, there will be no penalty to you, and you will not lose any benefits you normally would have. You may choose to withdraw from the study at any time without penalty. NOTE: If you are employed then it is your responsibility to work with your employer regarding work leave for participation in this study if during work hours.**

Nancy Al-Assaf : nancy.lassaf@tamu.edu  
Mark J. Clayton, PhD: mark-clayton@tamu.edu

**Why Is This Study Being Done?**

The purpose of this study is to study the use of Building Information Modeling (BIM) to aid design thinking and communicate formal concepts in design studios. By doing so, the researchers aim to develop new pedagogical framework that integrates formal design theories and BIM tools in design studios rather than teaching them separately.

**Why Am I Being Asked To Be In This Study?**

You are being asked to be in this study because you are a faculty member in an architecture school in the United States.

**How Many People Will Be Asked To Be In This Study?**

4 people (participants) will be invited to participate in this study locally.

**What Are the Alternatives to being in this study?**

The alternative to being in the study is not to participate.

**What Will I Be Asked To Do In This Study?**

You will be asked to participate in a focus group. In this study, you will be asked to discuss and evaluate students' projects. Your participation in this study will last up to 3 hours.

**TEXAS A&M UNIVERSITY HUMAN RESEARCH PROTECTION PROGRAM**  
**REVIEWERS 1 - INFORMED CONSENT DOCUMENT**

---

**Will Photos, Video or Audio Recordings Be Made Of Me during the Study?**

The researchers will take make a video recording during the study so that the discussion of the projects is documented to review it in depth. If you do not give permission for the video recording to be obtained, you cannot participate in this study.

\_\_\_\_\_ I give my permission for video recordings to be made of me during my participation in this research study.

**Are There Any Risks To Me?**

The things that you will be doing are no more than risks than you would come across in everyday life.

Although the researchers have tried to avoid risks, you may feel that some questions/procedures that are asked of you will be stressful or upsetting. You do not have to answer anything you do not want to.

**Will There Be Any Costs To Me?**

Aside from your time, there are no costs for taking part in the study.

**Will I Be Paid To Be In This Study?**

You will not be paid for being in this study.

**Will Information From This Study Be Kept Private?**

During the course of focus group discussion, no personal or private information will be discussed or recorded. Only the discussion of students' projects and architectural design will be documented. Therefore, the records of this study will not be kept private. Your name will be used in connection with tapes, transcripts, and publications resulting from this focus group.

\_\_\_\_\_ I give my permission for using my name used in connection with tapes, transcripts, and publications resulting from this focus group.

**Who may I Contact for More Information?**

You may contact the Principal Investigator, Dr. Mark J. Clayton to tell him about a concern or complaint about this research at 979-845-2300 or mark-clayton@tamu.edu. You may also contact the Protocol Director, Nancy Al-Assaf at 979-402-9988 or nancy.alassaf@tamu.edu.

For questions about your rights as a research participant, to provide input regarding research, or if you have questions, complaints, or concerns about the research, you may call the Texas A&M University Human Research Protection Program (HRPP) by phone at 1-979-458-4067, toll free at 1-855-795-8636, or by email at [irb@tamu.edu](mailto:irb@tamu.edu). The informed consent form and all study

**TEXAS A&M UNIVERSITY HUMAN RESEARCH PROTECTION PROGRAM**

**REVIEWERS 1 - INFORMED CONSENT DOCUMENT**

materials should include the IRB number, approval date, and expiration date. Please contact the HRPP if they do not.

**What if I Change My Mind About Participating?**

Your participation in this research is voluntary, and you have the choice whether or not to be in this research study. You may decide to not begin or to stop participating at any time. If you choose not to be in this study or stop being in the study, there will be no effect on your employment, evaluation, or relationship with Texas A&M University. Any new information discovered about the research will be provided to you. This information could affect your willingness to continue your participation.

**STATEMENT OF CONSENT**

**I agree to be in this study and know that I am not giving up any legal rights by signing this form. The procedures, risks, and benefits have been explained to me, and my questions have been answered. I know that new information about this research study will be provided to me as it becomes available and that the researcher will tell me if I must be removed from the study. I can ask more questions if I want. A copy of this entire consent form will be given to me.**

\_\_\_\_\_  
Participant's Signature

\_\_\_\_\_  
Date

\_\_\_\_\_  
Printed Name

\_\_\_\_\_  
Date

**INVESTIGATOR'S AFFIDAVIT:**

Either I have or my agent has carefully explained to the participant the nature of the above project. I hereby certify that to the best of my knowledge the person who signed this consent form was informed of the nature, demands, benefits, and risks involved in his/her participation.

\_\_\_\_\_  
Signature of Presenter

\_\_\_\_\_  
Date

\_\_\_\_\_  
Printed Name

\_\_\_\_\_  
Date

## APPENDIX VII

### Course Descriptions – College of Architecture, Texas A&M University

#### **ARCH 205 Architecture Design I**

**Credits 4. 1 Lecture Hour. 9 Lab Hours.**

Issues and methods in designing environments for human habitation and well-being; projects addressing site, functional planning, spatial ordering, form generation through a recognition of the synthesis of space, structure, use and context; reinforcement of appropriate graphic and model building techniques.

Prerequisites: ENDS 105, ENDS 108, ENDS 115.

#### **ENDS 105 Design Foundations I**

**Credits 4. 1 Lecture Hour. 8 Lab Hours.**

Visual and functional design principles; development of skills in perception, thought and craft as they apply to the formation of two- and three-dimensional relationships; design attitudes and environmental awareness.

#### **ENDS 106 Design Foundations II**

**Credits 4. 1 Lecture Hour. 6 Lab Hours.**

Approaches to problem identification and problem solving emphasizing an awareness of human, physical and cultural factors influencing design; reinforcement of visual and verbal communication as applied to the design process.

## **ENDS 115 Design Communication Foundations**

**Credits 3. 1 Lecture Hour. 4 Lab Hours.**

(ARCH 1307) Design Communication Foundations. Introduction to and practice of tools, methods, techniques available for graphic communication; graphic communication and the design process; observation and other forms of free-hand drawing and drawing systems that develop representational and descriptive capabilities.

## APPENDIX VIII

### Precedents Study Exercise

ARCH 205

## PRECEDENT STUDY



### Analysis

Precedent study in architecture focuses on the analysis and interpretation of the built form to create new design solutions. This helps designers to understand diverse ways that principle might be applied to a current project. It is usually limited to characteristics that can be diagrammed. This study aims to assist your understanding of architectural design through examining the work of known architects and to gain a comprehensive understanding of spatial organization, formative ideas, and organizational principles. Analyzing a precedent includes many aspects such as: formal analysis, functional analysis and spatial organization, tectonics and technology, building performance, and context (e.g. culture). However, this course will focus on the formal aspects of architectural form. Accordingly, in your analysis you are required to address:

- i. **Design elements** such as conceptual elements (e.g. masses, planes, lines) and building components (e.g. shape and type of windows).
- ii. **Design rules:**
  1. **Transformational rules:** they are operations that convert one state of an element into another. Transformational rules include: translation, rotation, reflection, scaling, stretch, sheer, perspective transformation, subtractions, deformations, etc.
  2. **Modularity and proportion:** such as square grid, 9 square grid, 1:2 proportion, 1:  $\sqrt{2}$ , golden ration.
  3. Axiality
  4. **Layering:** spatial layers and planes.
  5. **Duality:** for example: public/ private, solid /void, subtraction/addition, transparent/opaque etc.
  6. **Alignment**
- iii. **Organizational principles/ concepts:**
  1. **Pattern**
    - a. **Proximity:** such as: included, related, tangent, interlocked, nested and juxtaposition.
    - b. **Sequence:** gradation, repetitive rhythm, alternating rhythm, progressive rhythm.
    - c. **Repetition**
    - d. **Organization:** linear organization, radial organization, grid organization, figural organization.
  2. Hierarchy
  3. Balance: symmetry, asymmetry
  4. Aggregation
  5. Subdivision





## Examples

Architect	Examples
Taller d'arquitectura	– House at Montras , 1977
Jeronimo Junquera and Estanislao Perez Pita	– House at Santander, 1984
Glenn Murcutt	– Marie Short/Glenn Murcutt House, 1975 – House at Bingie Pint, 1985
Edmond and Corrigan	– Athan House, 1989
James Stirling	– House at Cowes, 1956
Atelier 5	– House Merz (1958-59) in Motier, Switzerland – Haus Alder, 1958
Edward Cullinan	– Marvin house, 1959
Team 4	– House at Creek Veau, 1966 – Jaffe House (Skybreak House) , 1966
Foster + Partners	– Cho en Dai House , 1994
Rob Krier	– Siemer House, Warmbronn, Alemania, 1968 – Haus Weidemann   Stuttgart, Alemania, 1975 – Dickes House, Luxembourg, 1974-1975
Frank Lloyd Wright	– Robie House , 1909 – Falling water, 1935 – Price house, 1951 – Elam Residence
Gerrit Rietveld	– The Schröder House, 1924
Amyas Connell	– New farm, 1932
Hans Scharoun	– Villa Schminke in Lobou Saxony, Germany, 1933
Luckhardt Brothers: Hans and Wassili Luckhardt with Alfons Anker.	– Villa Kluge, "Am Rupenhorn" in Berlin, 1928.

<b>William Lescaze</b>	– Own house, 1934
<b>Hiroshi Fujii</b>	– House Within a House /1: Todoroki Residence, 1976
<b>Philip Johnson</b>	– Wiley house, 1953
<b>Giuseppe Terragni</b>	– Villa Bianca, 1937 – Villa Sul Lago
<b>Le Corbusier</b>	– Villa Stein, 1927 – Villa Savoie , 1930
<b>Mies van der Rohe</b>	– Lange House, 1928 – Tugendhat House, 1930 – Fransworth House, 1945
<b>Marcel Breuer</b>	– Sayer House, Glanville, Calvados, France 1972–3 – The McMullen House, 1960 – The Jacques and Christina Koerfer House, 1965 – The Bill and Mariana Staehelin House, 1958 – The Andy and Jamie Gagarin House I, 1955 – The June Halverson Alworth House, 1955 – The Marcel Breuer House III, 1951 – Gagarin House I, Litchfield, Connecticut 1955–7
<b>Amancio Williams</b>	– Country House at Mar Del Plata , 1944
<b>William Turnbull</b>	– Zimmerman House, 1975
<b>Oscar Niemeyer</b>	– own house, 1953 – unbuilt Burton G. Tremaine, Sr. Home in Santa Barbara, California, 1947 – Casa das Canoas, Gavea, Rio de Janeiro, 1953.
<b>Richard Neutra</b>	– Warren Termaine House, 1948
<b>Tadao Ando</b>	– Horiuchi House, 1978
<b>Mario Botta</b>	– Bianchi house at Riva San Vitale, 1972-1973
<b>Louis Kahn</b>	– Norman Fisher House, 1960 – Esherick House, 1959-1961. – Adler House, 1955 – Goldenberg House, 1959

<b>Serge Chermayeff</b>	<ul style="list-style-type: none"> <li>- Bentley wood, 1938</li> </ul>
<b>Paul Rudolph</b>	<ul style="list-style-type: none"> <li>- Leavengood residence, St. Petersburg, Florida, 1950-1951</li> <li>- Finney Guest House, : Sarasota, 1947</li> </ul>
<b>Jorn Utzon</b>	<ul style="list-style-type: none"> <li>- Utzon House, Hellebek , 1952</li> </ul>
<b>Peter Eisenman</b>	<ul style="list-style-type: none"> <li>House I, Princeton, New Jersey, 1967-68</li> <li>House II, Hardwick, Vermont, 1969-70</li> <li>House III, Connecticut, 1969-71</li> <li>House IV, Falls Village, Connecticut, 1972-76</li> <li>House VI, Connecticut, 1972-75</li> <li>House X, Bloomfield, Michigan, 1975</li> <li>House 11a, Palo Alto, California, 1978</li> <li>-</li> </ul>
<b>Richard Meier</b>	<ul style="list-style-type: none"> <li>- Smith House , 1967</li> <li>- House in Pound Ridge,1969</li> <li>- Douglas House, 1973</li> <li>- Shamberg House, 1974</li> <li>- Rachofsky House, 1996</li> <li>- Oxfordshire Residence , 2007-2017</li> <li>- Bodrum Houses , 2007 -</li> <li>- Dune Road Residence, 2010</li> </ul>
<b>John Hejduk</b>	<ul style="list-style-type: none"> <li>- Bye House, 1973.</li> <li>- One half House, 1966, unbuilt</li> <li>- Diamond House A (1963-1967)</li> </ul>
<b>Michael Graves</b>	<ul style="list-style-type: none"> <li>- Hanselmann House, 1967</li> <li>- Benacerraf House Addition, 1969</li> </ul>
<b>Charles Gwathmey</b>	<ul style="list-style-type: none"> <li>- Gwathmey Residence and Studio, 1966</li> <li>- Bridgehampton Residence, 1970</li> <li>- The Kenneth Cooper House, 1969</li> <li>- The Tolan Residence, 1970</li> <li>- The Marshall and Maureen Cogan Residence, 1972</li> <li>- The Maurice and Marilyn Cohn Residence, 1973</li> <li>- The Melville I. Haupt Residence, 1976</li> <li>- The Weitz House, 1976</li> <li>- The John S. and Carol K. Crowley Residence, 1978</li> <li>- The Gabriele Viereck Residence, 1979</li> <li>- The Lloyd Taft House, 1980</li> <li>- The Francois de Menil Residence, 1983</li> </ul>



## Suggested References

### Analysis

Clark, R. H., & Pause, M. (2012). *Precedents in architecture: analytic diagrams, formative ideas, and partis*. John Wiley & Sons. [<https://www.scribd.com/doc/7819960/Precedents-in-Architecture> ]

Eckler, J. F. (2012). *Language of Space and Form: Generative Terms for Architecture*. John Wiley & Sons.

Ching, F. D. (2014). *Architecture: Form, space, and order*. John Wiley & Sons.

### Examples

Davies, C. (2006). *Key houses of the twentieth century: plans, sections and elevations*. Laurence King Publishing.

## APPENDIX IX

### Project 1

ARCH 205

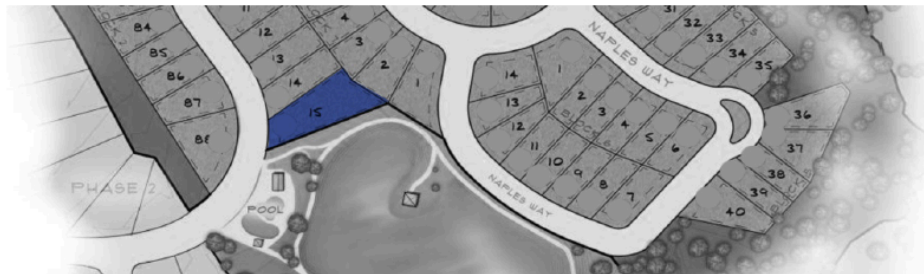
# Design a House



Use Autodesk Revit to **design** a house in a new development in Bryan, Texas. This development is called Siena. More information about this development can be found at the following link:

<https://www.stylecraftbuilders.com/find-your-home/bryan-college-station/siena>

You will design the house on **lot 15**.



### DESIGN BRIEF AND CONSTRAINTS

**Maximum Area:** 2500 square feet. (This is the area of all conditioned space stories)

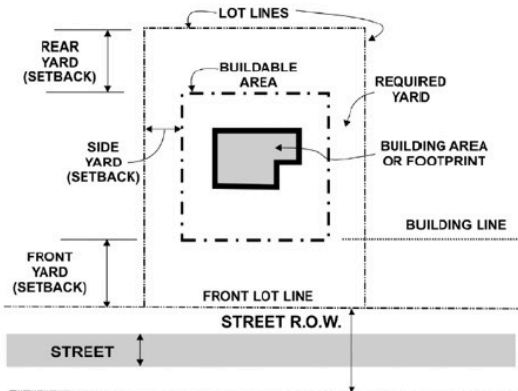
**Maximum Height:** 30 feet.

**Function:**

- 3 or 4 bedrooms
- 3 bathrooms
- Living area
- Kitchen area
- Dining area
- An outdoor porch
- One staircase if you have two stories, 2 staircases if you have three stories.

## Setbacks

- Front setback: 25'
- Side setback: 10'
- Rear setback: 10'



## SUBMISSION FORMAT

You only need to submit a Revit file. Upload your file to the google drive of ARCH 205, a new folder will be created for this submission. This file should include your design proposal and each room should have a tag (e.g. Bedroom, Kitchen). You can use furniture to define the function of each room too. The following video explains how to define rooms in Revit using color legend and tags.

<https://www.youtube.com/watch?v=3aqNgtwT3hA>

## DUE DATE

Wednesday, September 12, 11:59 pm.

## NOTE

You will be provided with a Revit project file that has the lot and the setbacks. Use that file to do your design.

## APPENDIX X

### House Types for Project 2 And Project 3

#### Functional Scenarios

##### House Type A

This is the most common house type in America, typically built and sold on speculation in large, middle-class subdivisions. It is intended to accommodate a typical working class or middle-class family.

- Foyer
- Living room/dining room
- Kitchen
- Primary bedroom with private bath and walk-in closet
- Two secondary bedrooms with clothes closets
- Bathroom
- Coat closet
- Mop closet
- Two car garage
- HVAC return chase, about 9 SF (HVAC units can be on roof)
- Enclosed conditioned floor area: 1,300 SF Enclosed conditioned volume: 18,200 CF
- Quantities may vary up to 10% below or 10% above
- Hallways as needed

##### House Type B

For one or two professionals with no children, a small house meets needs for an active social lifestyle.

- Foyer
- Living room
- Kitchen/breakfast room
- Primary bedroom with private bath and walk-in closet
- One secondary bedroom with clothes closet
- Small office
- Bathroom
- Coat closet
- Mop closet
- One car carport
- HVAC return chase, about 9 SF (HVAC units can be on roof)
- Enclosed conditioned floor area: 1,100 SF Enclosed conditioned volume: CF 13000
- Quantities may vary up to 10% below or 10% above

Hallways as needed

### **House Type C**

Several children living with parents requires a variety of spaces.

Foyer  
Powder room  
Great room (for everyday living and hosting parties)  
Formal dining room  
Family room (entertainment, games, TV)  
Kitchen/breakfast room  
Primary bedroom with private bath and walk-in closet  
Three secondary bedrooms with bathrooms and clothes closet  
Bathroom  
Small office  
Laundry room  
Coat closet  
Mop closet  
Two car garage with 60 sf of storage  
HVAC return chase, about 9 SF (HVAC units can be on roof)  
Enclosed conditioned floor area: 2200 SF Enclosed conditioned volume: 33,000 CF  
Quantities may vary up to 10% below or 10% above  
Hallways as needed

### **House D**

A speculative, rental vacation house, such as at a ski resort, can be rented in multiple ways. An extended family or pair of families may rent the entire double together, or each unit could be rented by independent families or groups.

Communal foyer  
Laundry room  
Two units that can be operated as a single unit, each with

Foyer  
Powder room  
Coat closet  
Living room  
Dining room  
Kitchen with breakfast nook  
Laundry room  
Primary bedroom  
Primary bathroom  
3 Secondary bedrooms, each with clothes closet  
Secondary bathroom  
4-car garage



HVAC return chase, about 9 SF (HVAC units can be on roof)  
Enclosed conditioned floor area: 3300 SF Enclosed conditioned volume: 45,000 CF

Quantities may vary up to 10% below or 10% above  
Hallways as needed

## House Type E

Two individuals or two couples may wish to share costs in a rental or build equity together in an owned unit.

Foyer  
Coat closet  
Small office  
Living room/dining room (for everyday living and hosting parties)  
Family room (entertainment, games, TV)  
Kitchen/breakfast nook  
2 primary bedroom suites with private bath and walk-in closet  
Powder room  
Mop closet  
Laundry room  
Two car garage with 30 sf of storage  
HVAC return chase, about 9 SF (HVAC units can be on roof)  
Enclosed conditioned floor area: 1450 SF Enclosed conditioned volume: 18,800 CF  
Quantities may vary up to 10% below or 10% above  
Hallways as needed

## House Type F

An empty nest couple may wish to have a cottage nearby for visits from their children. Or an adult may wish to have a cottage nearby for an aging parent.

Foyer  
Living room/dining room  
Kitchen  
Primary bedroom with private bath and walk-in closet  
Two secondary bedrooms with clothes closets  
Bathroom  
Coat closet  
Mop closet  
Two car garage  
Attached or detached cottage  
Foyer  
Living room/dining room  
Kitchen

Primary bedroom with clothes closet

Bathroom

Mop closet

Coat closet

HVAC return chase, about 9 SF (HVAC units can be on roof)

Enclosed conditioned floor area: 2370 SF Enclosed conditioned volume: 35,600 CF

Quantities may vary up to 10% below or 10% above

Hallways as needed

APPENDIX XI

A Sample of Transformation Matrices from Project 3

Student: HL005481

Dissection					
Elements of design		Delete	Add	Substitute	Explain more
	rectangular prism		X		
	plane		X		
	½ circle	X			
	¼ circle	X			
	curvilinear forms		X		
	cone	X			
	cylinder		X		
	Angled families	X			
	Stacked elements	X			
	Triangular prism	X			
	Cube form		X		No length emphasis on either elevation
	Prism		X		
Elements of Construction	generic white walls		X		
	generic white flat roofs		X		
	generic white floors		X		
	circular columns	X			
	chimney	X			
	curtain wall		X		
	mullions		X		
	rectangular windows		X		
	louvers			X	Paneling on glazed facade
	pipe railings		X		
	stairs			X	Different design - more like Gwathmey
	bridges	X			
	ramps	X			
	rectangular beams	X			

Articulation					
Syntax	Duality of public / private & open /closed in one main mass			X	Doesn't depend on front/back - can be defined by different levels
	Frontality (L > W)	X			All forms are cubic
	Spatial layering A-B-A	X			5x5 grid system
	Two perpendicular axis		X		
	longitudinal axis that defines horizontal circulation		X		
	Transverse axis that defines the entrance		X		Always in the corner and on the exterior
	Modularity		X		5x5 grid system
	Proportion: 1:2	X			
	Proportion: golden rectangle	X			
	Proportion: root 2 rectangle	X			
	mullions grid aligned with columns and floors		X		Aligned with the 5x5 grid system
	Rectangular subdivision: Served / servant spaces			X	defined by level and not front/back
	Minor additions			X	Additions stand out against the main mass
	Minor subtractions			X	Major subtraction for entrance
Configuration	syntactical centrality			X	Living space does not completely rely on the syntactical center, but is arranged around it. Syntactical center has no importance in the private levels

Student: **MP007761**

Dissection					
		Delete	Add	Substitute	Explain more
Elements of design	rectangular prism				
	plane				
	½ circle	X			
	¼ circle	X			
	curvilinear forms	X			
	cone	X			
	cylinder	X			
Elements of Construction	generic white walls			X	Brick walls, varying colors
	generic white flat roofs			X	Non-flat roofs, shingles
	generic white floors			X	Generic wood floors
	circular columns	X			
	chimney				
	curtain wall	X			
	mullions	X			
	rectangular windows				
	louvers				
	pipe railings	X			
	stairs				
	bridges				
	ramps	X			
	rectangular beams				
	Ribbon Windows		X		

Articulation					
Syntax	Duality of public / private & open /closed in one main mass		X		
	Frontality (L > W)		X		
	Spatial layering A-B-A			X	A-B Layering
	Two perpendicular axis				
	longitudinal axis that defines horizontal circulation	X			
	Transverse axis that defines the entrance	X			
	Modularity		X		
	Proportion: 1:2	X			
	Proportion: golden rectangle	X			
	Proportion: root 2 rectangle	X			
	mullions grid aligned with columns and floors	X			
	Rectangular subdivision: Served / servant spaces				
	Minor additions	X			
	Minor subtractions	X			
Configuration	syntactical centrality			X	Core centrality

Student: **MK005671**

Dissection					
		Delete	Add	Change	Explain more
Elements of design	rectangular prism		x		
	plane	x			
	½ circle		x		
	¼ circle		x		
	curvilinear forms		x		
	cone	x			
	cylinder	x			
Elements of Construction	generic white walls		x		
	generic white flat roofs		x		
	generic white floors		x		
	circular columns		x		
	chimney	x			
	curtain wall		x		
	mullions		x		
	rectangular windows	x			
	louvers	x			
	pipe railings			x	
	stairs			x	
	bridges	x			
	ramps	x			
	rectangular beams	x			
	Mess skin		x		
	courtyard		x		
	Colonnade walkway		x		
	Parapet walls		X		
Overhanging eaves		X			

	Roof access - "roof garden"		X		
<b>Articulation</b>					
<b>Syntax</b>	Duality of public / private & open /closed in one main mass			x	Duality between prospect and refuge- max refuge with "castle wall" max prospect with courtyard
	Frontality (L > W)			x	Interior vs exterior frontality
	Spatial layering A-B-A		x		
	Two perpendicular axis			x	U shaped axis
	longitudinal axis that defines horizontal circulation			x	U shaped axis
	Transverse axis that defines the entrance			X	Along courtyard
	Modularity	x			
	Proportion: 1:2	x			
	Proportion: golden rectangle	x			
	Proportion: root 2 rectangle	x			
	mullions grid aligned with columns and floors	x			
	Rectangular subdivision: Served / servant spaces	x			
	Minor additions			x	major
	Minor subtractions	x			
	Vertical circulation with tower		x		
	Everything arranged in relation to U shape		x		
Duality- curves on outside straight lines along inside		x			
<b>Configuration</b>	syntactical centrality			x	Around courtyard

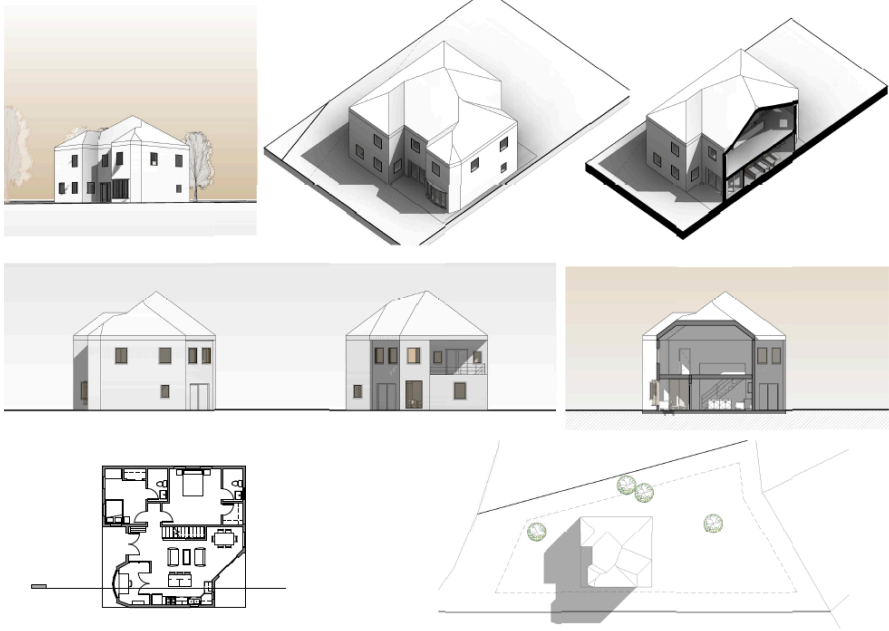


APPENDIX XII

Selected Projects - Project 1

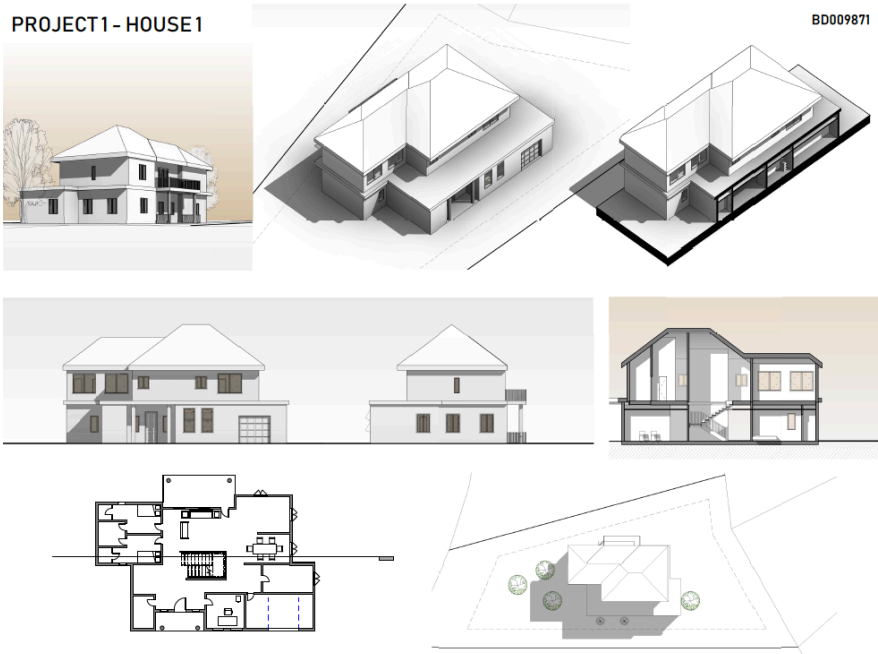
PROJECT1 - HOUSE 1

BA003211



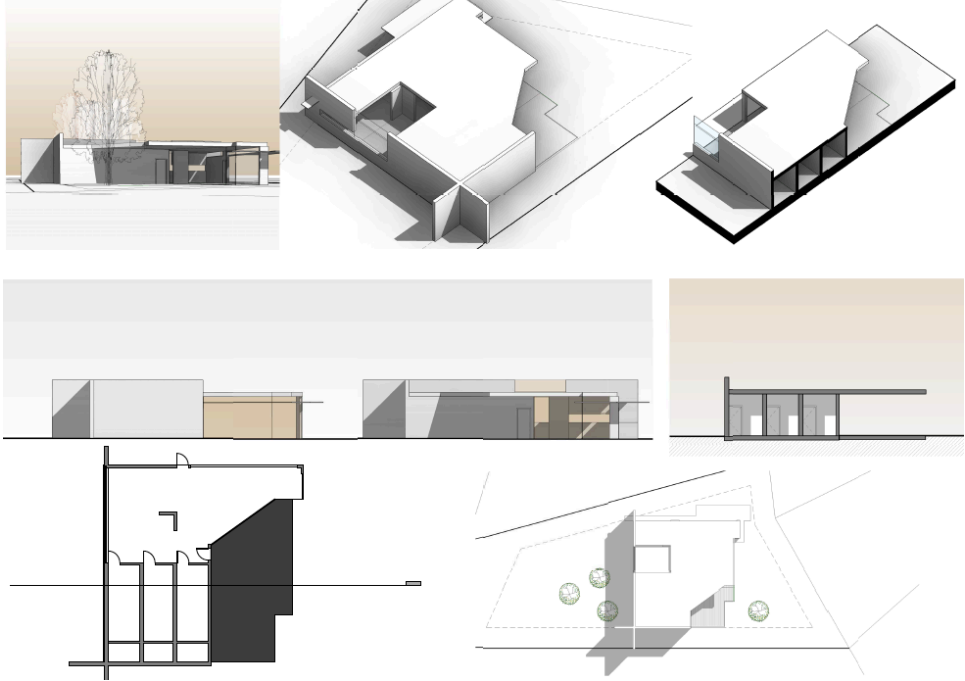
PROJECT1 - HOUSE 1

BD009871



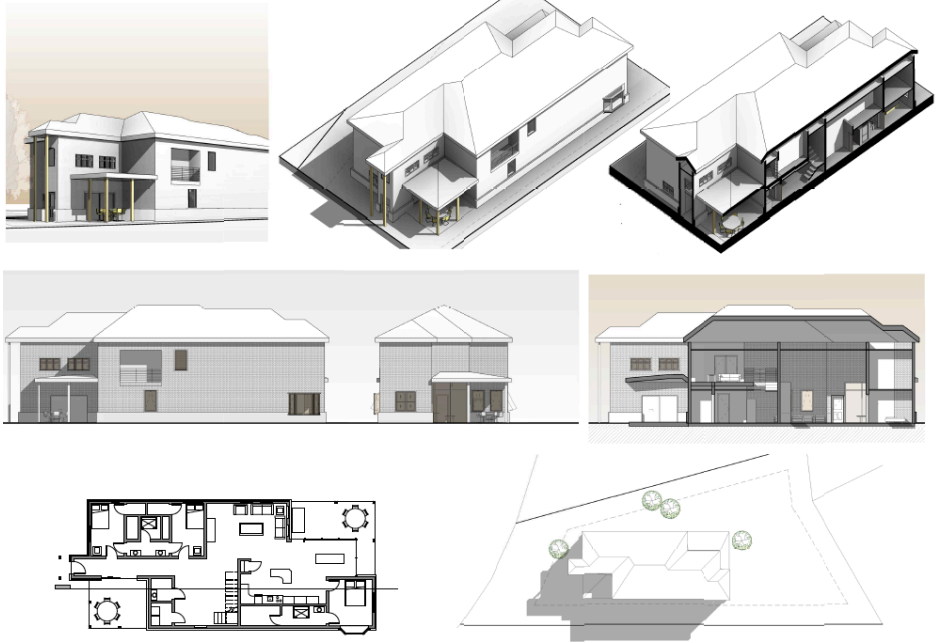
PROJECT1 - HOUSE1

BG009086



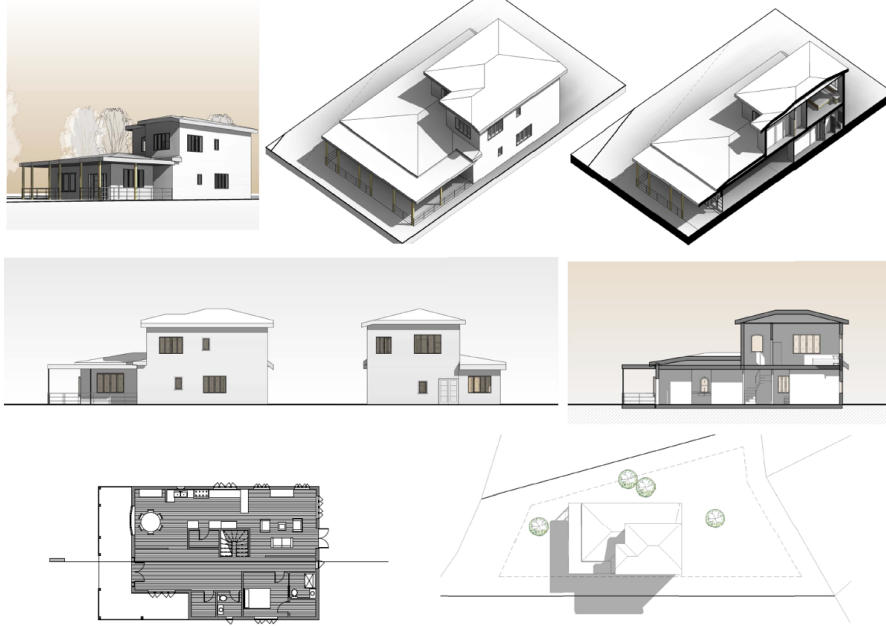
PROJECT1 - HOUSE1

FG005421



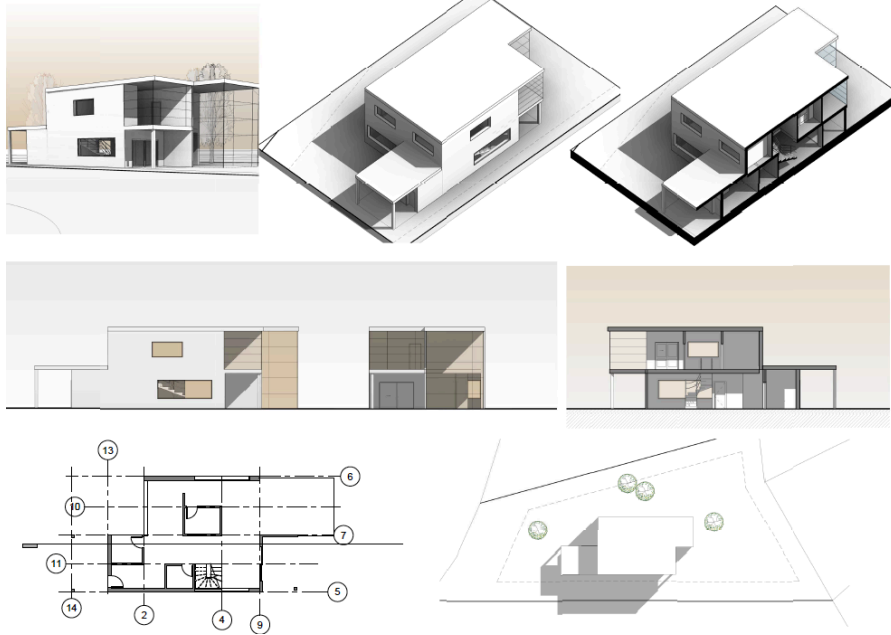
PROJECT1 - HOUSE1

HL005481



PROJECT1 - HOUSE1

TK007721

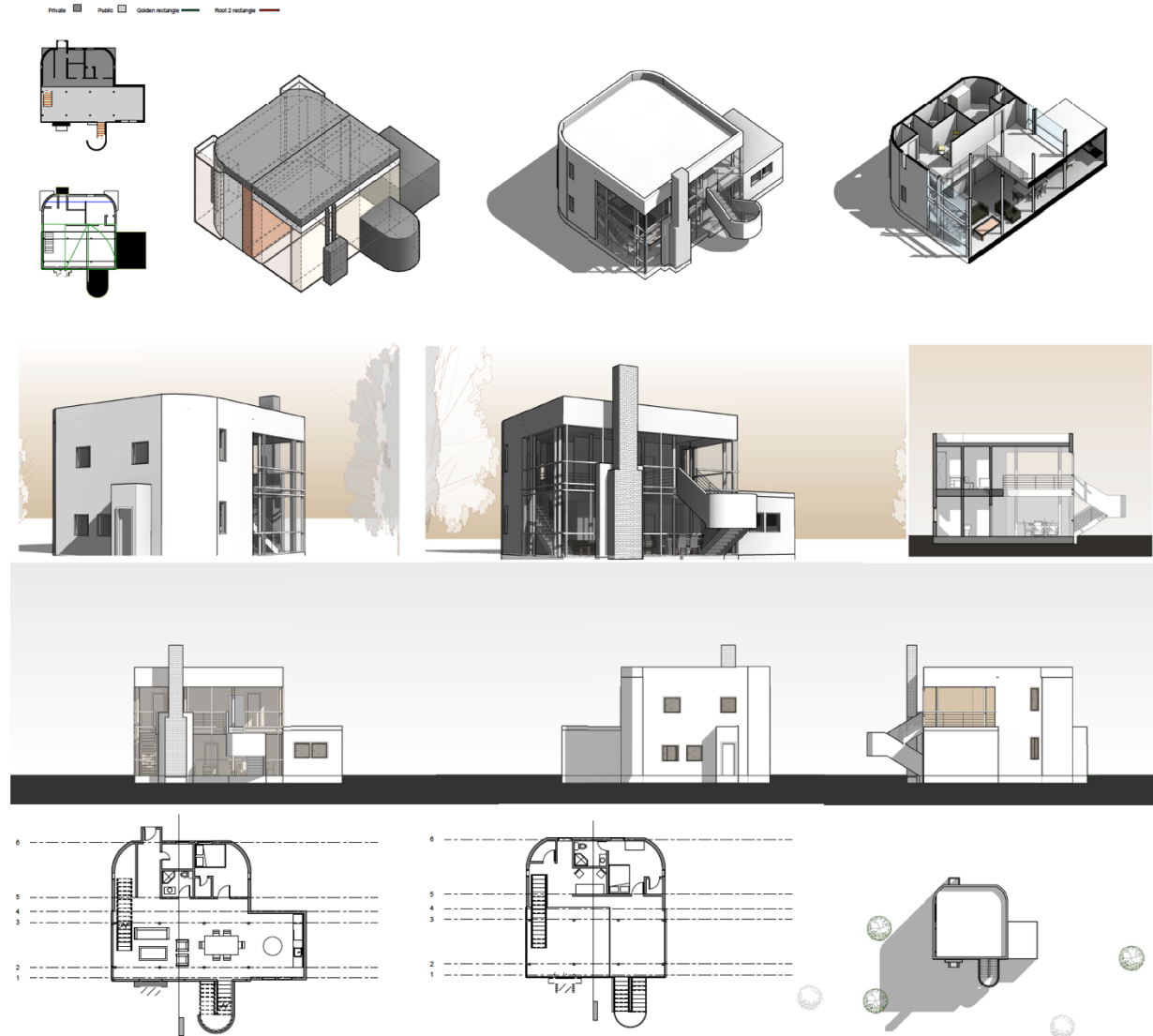


## Selected Projects - Project 2

**Theme 1:** Houses that are derived from Smith House and Douglas House

### PROJECT 2 - HOUSE 1

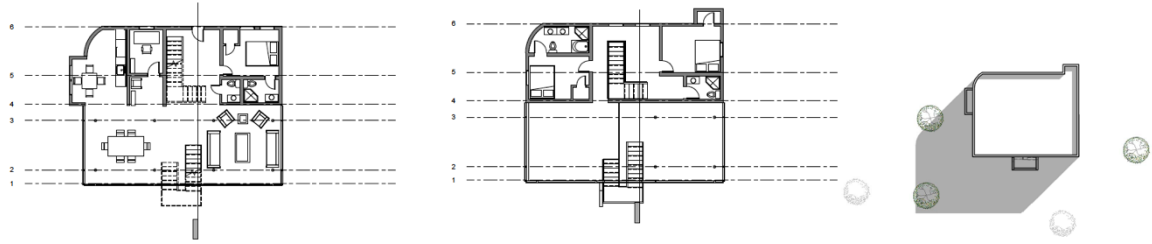
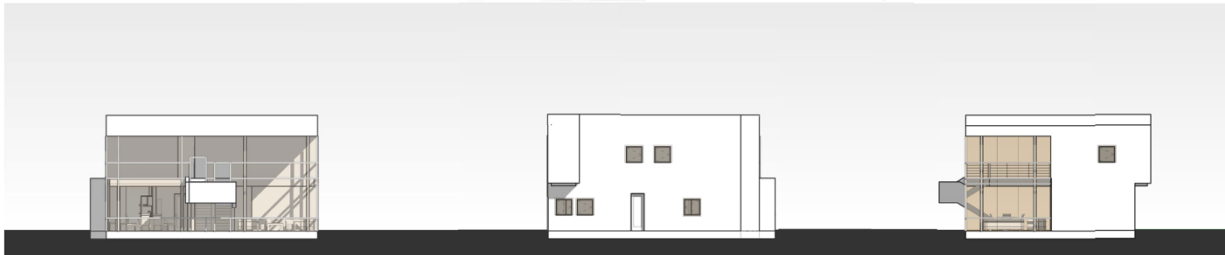
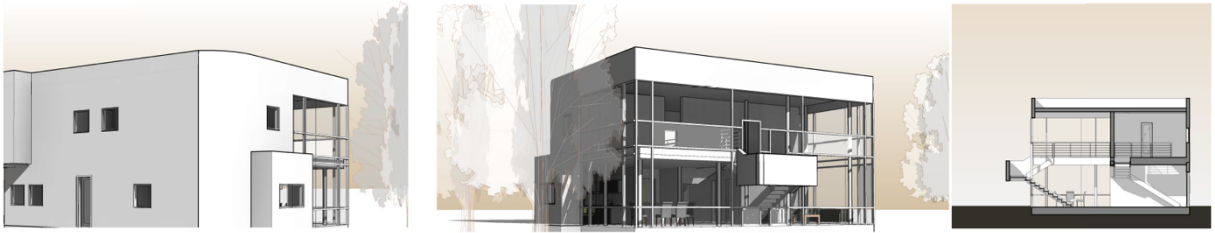
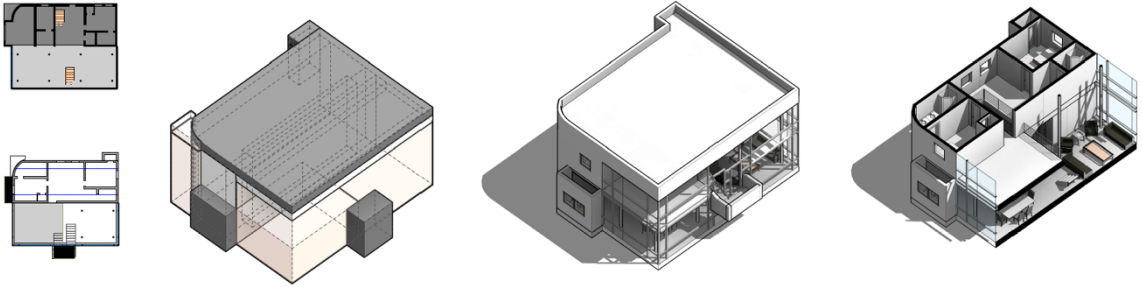
BD009871



# PROJECT 2 - HOUSE 2

BD009871

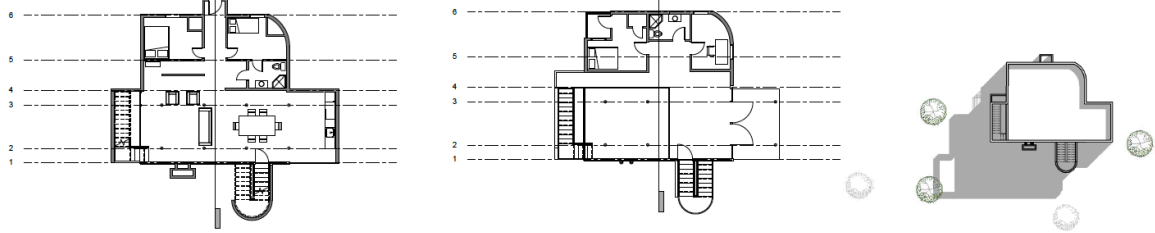
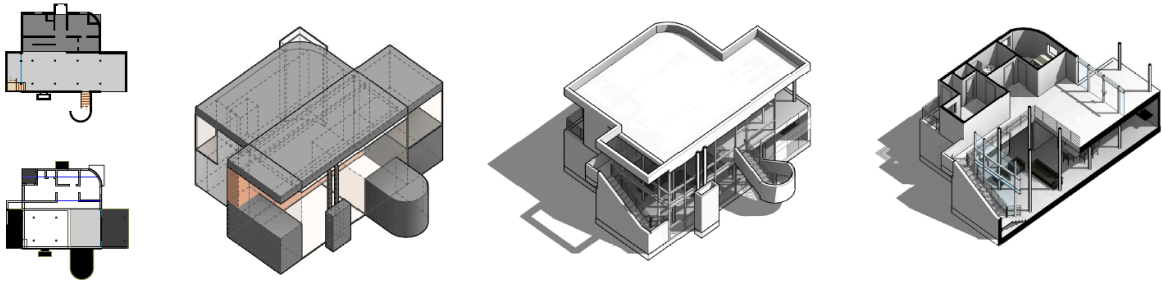
Private Public Golden rectangle Root 2 rectangle



PROJECT 2 - HOUSE 3

BD009871

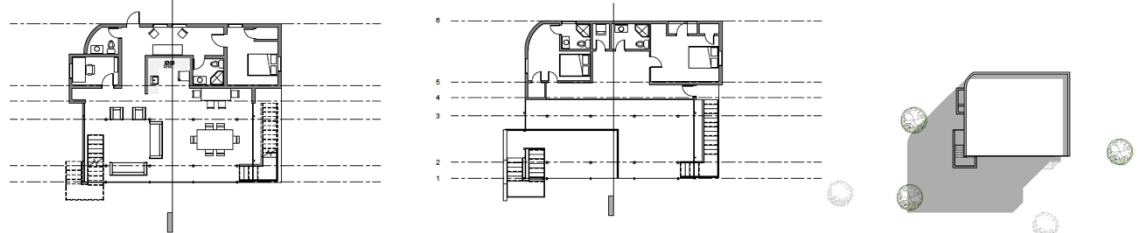
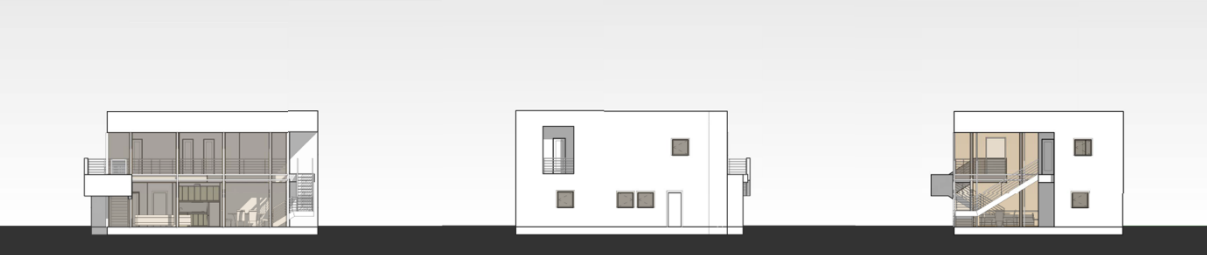
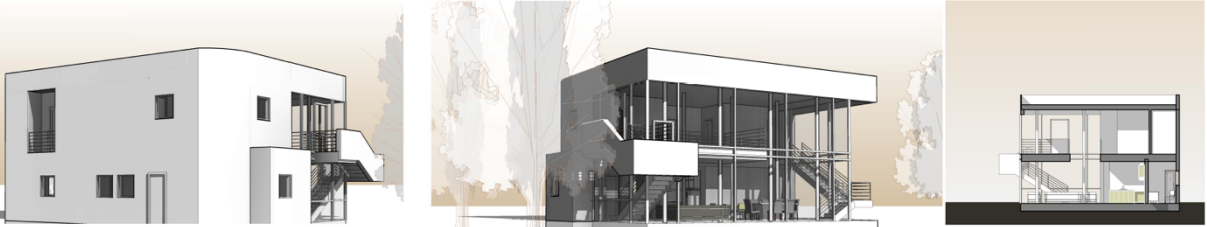
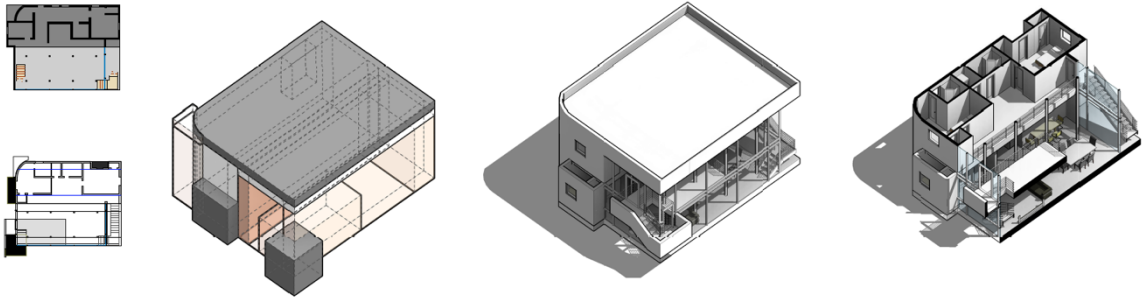
Private ■ Public □ Golden rectangle ■■■■ Roof 2 rectangle ■■■■



PROJECT 2 - HOUSE 4

BD009871

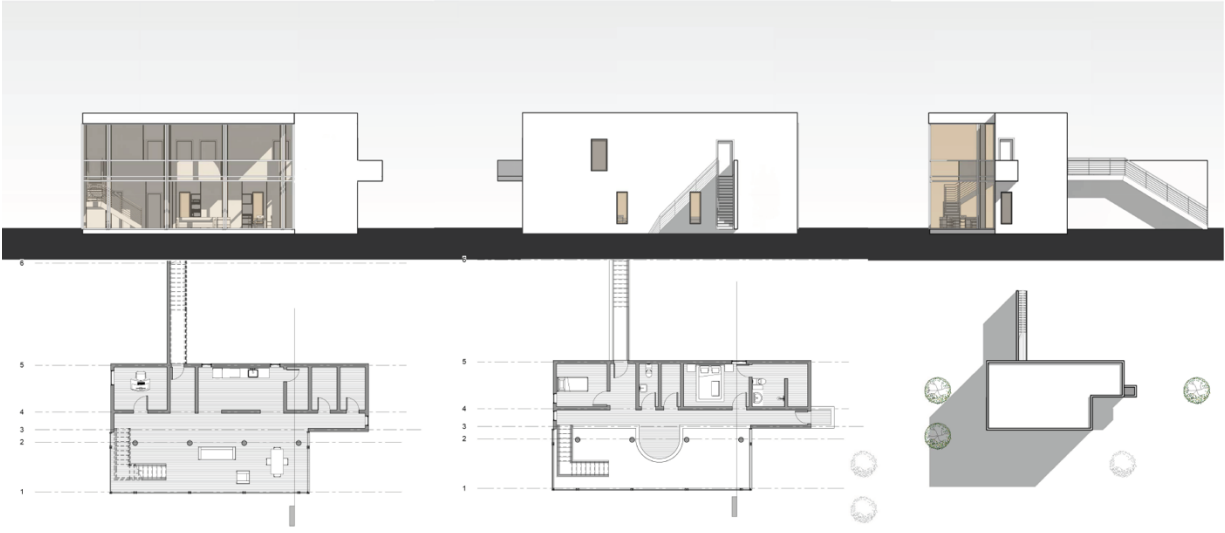
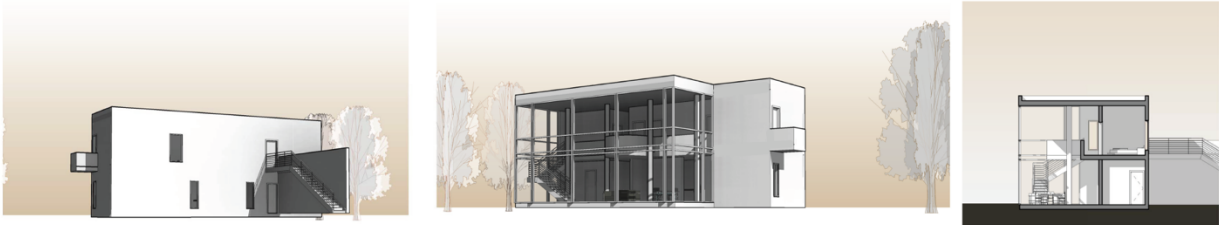
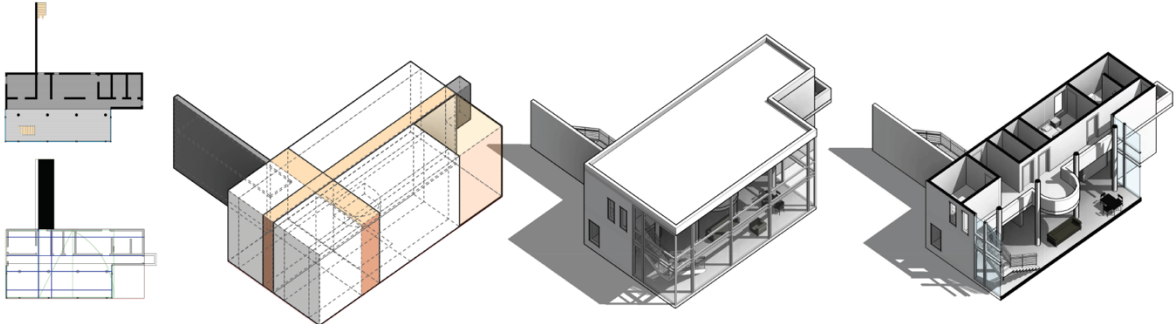
Private ■ Public □ Golden rectangle ■■■■ Roof 2 rectangle ■■■■



PROJECT 2 - HOUSE 1

YB004329

Private Public Golden rectangle Roof 2 rectangle

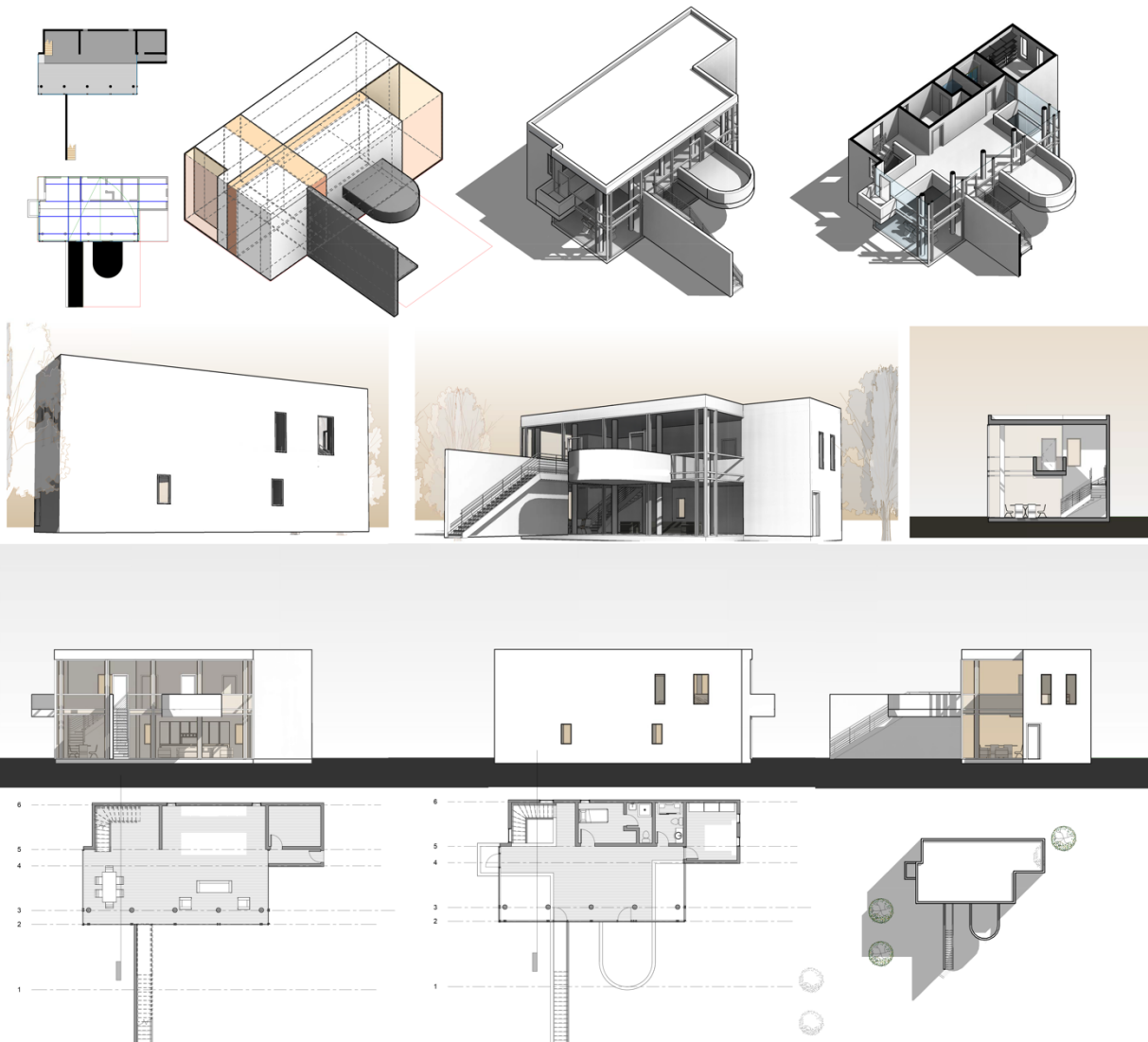




# PROJECT 2 - HOUSE 2

YB004329

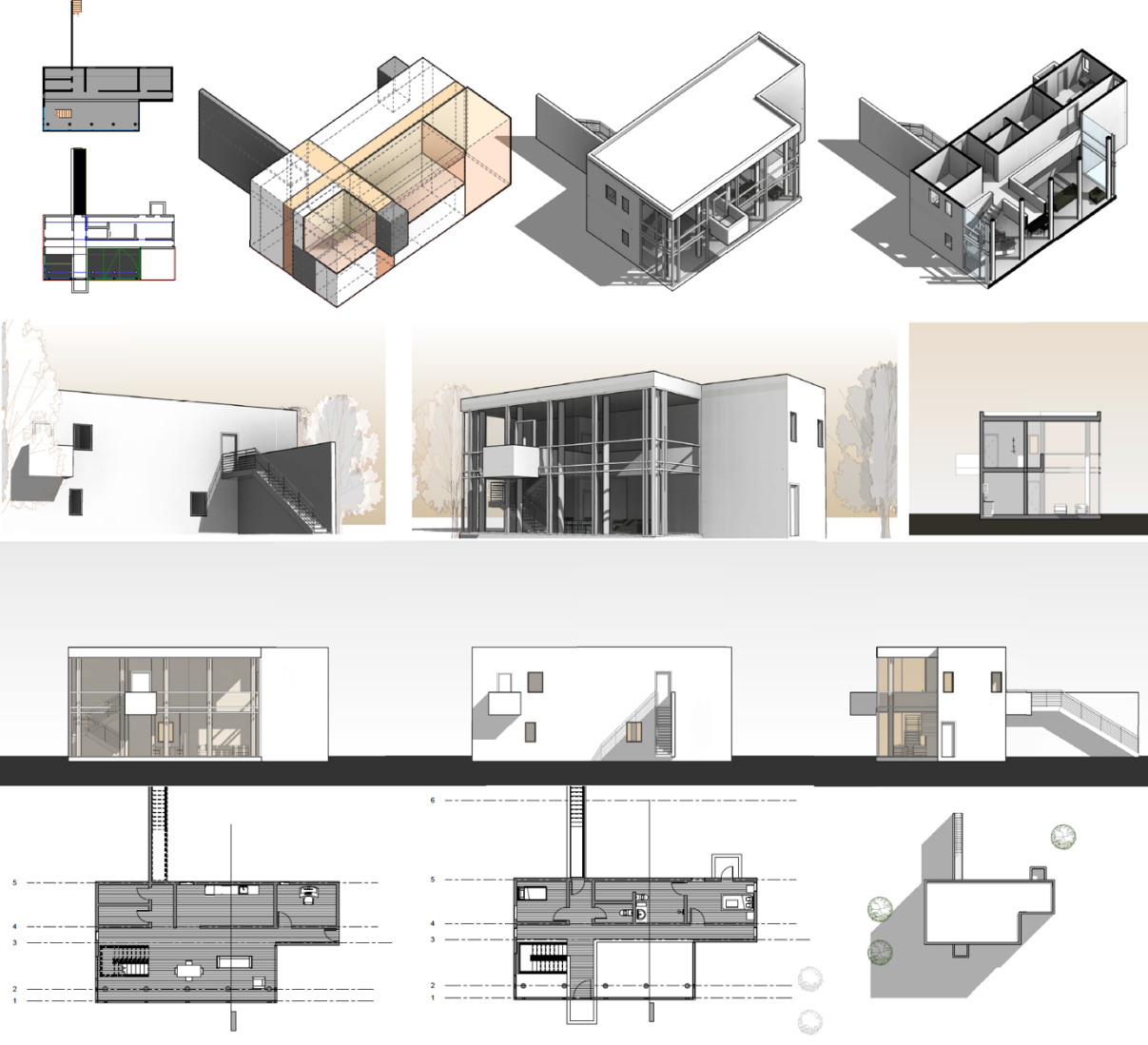
Private ■ Public ■ Gallery rectangle ■ Roof 2 rectangle ■



PROJECT 2 - HOUSE 3

YB004329

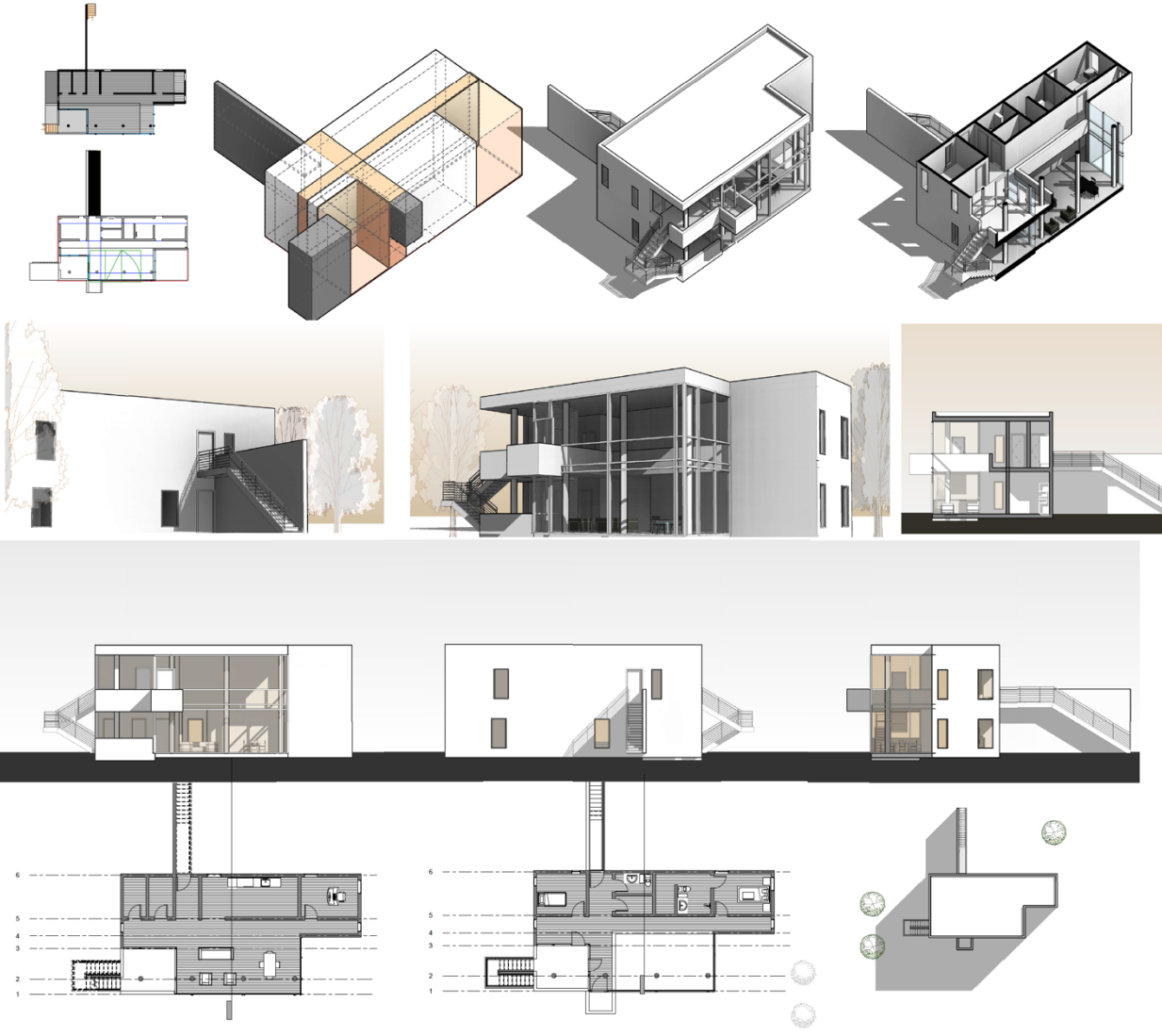
Private ■ Public □ Golden rectangle ■ Red 2 rectangle ■



# PROJECT 2 - HOUSE 4

YB004329

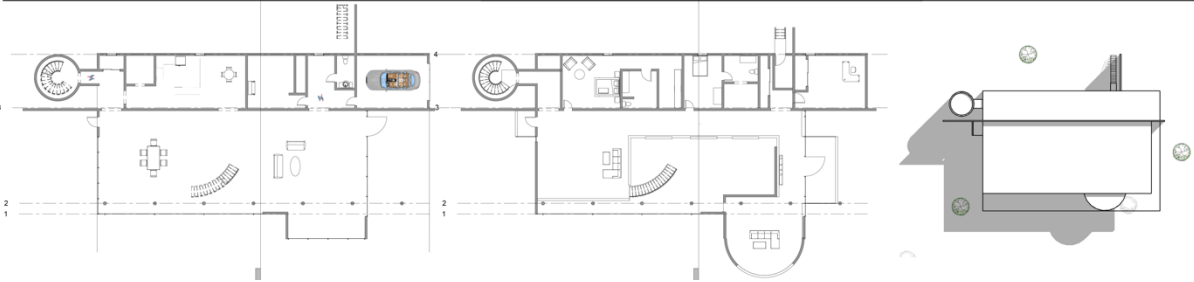
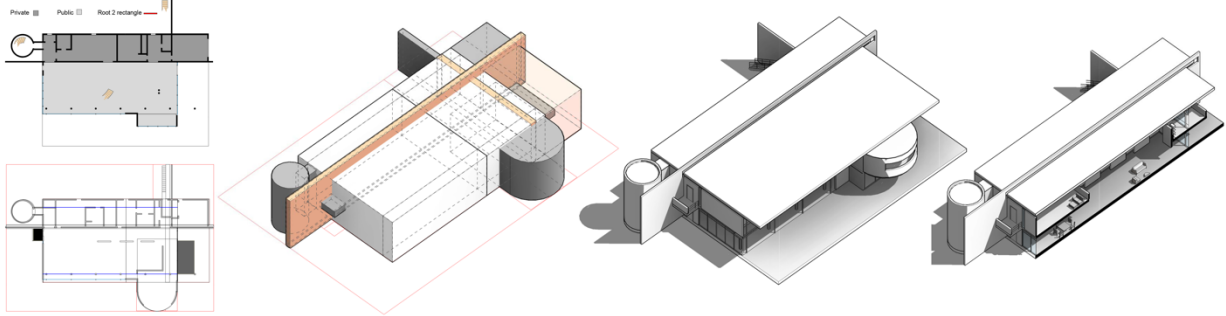
Private ■ Public □ Golden rectangle ■ Roof 2 rectangle ■



**Theme 2:** Houses that are derived from Rachofsky House (either in the diagram or mass articulation or both)

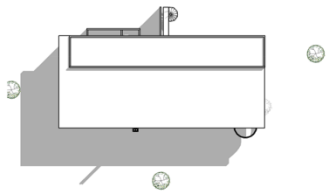
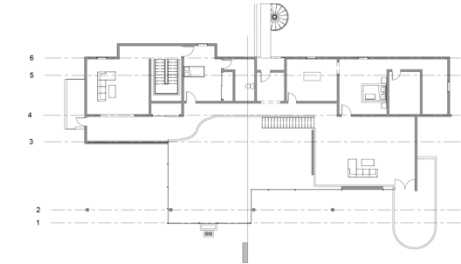
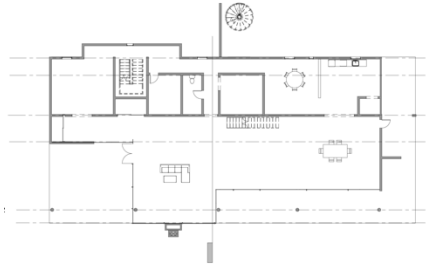
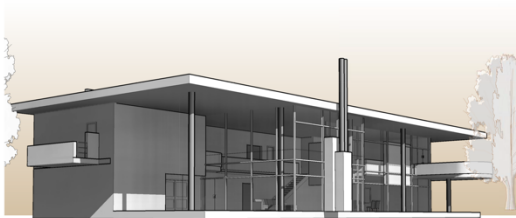
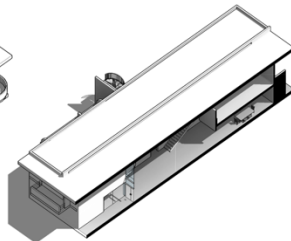
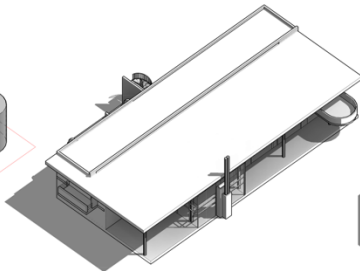
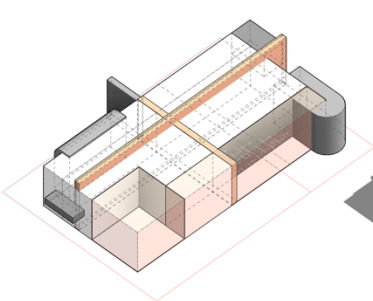
**PROJECT 2 - HOUSE 1**

BC007631



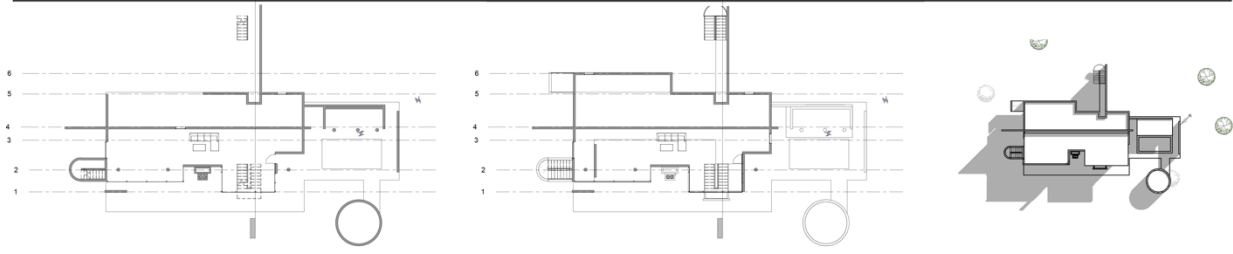
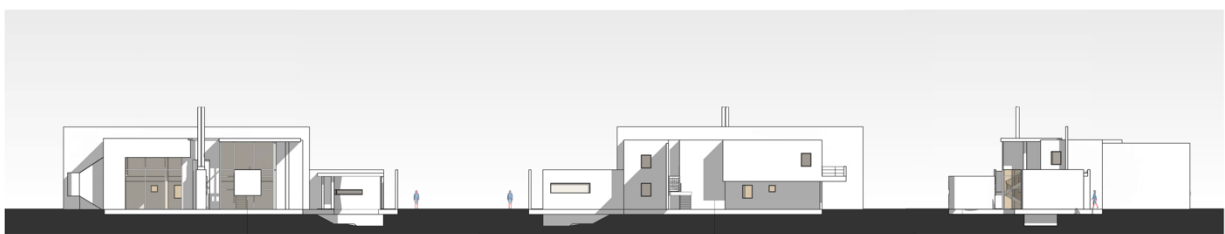
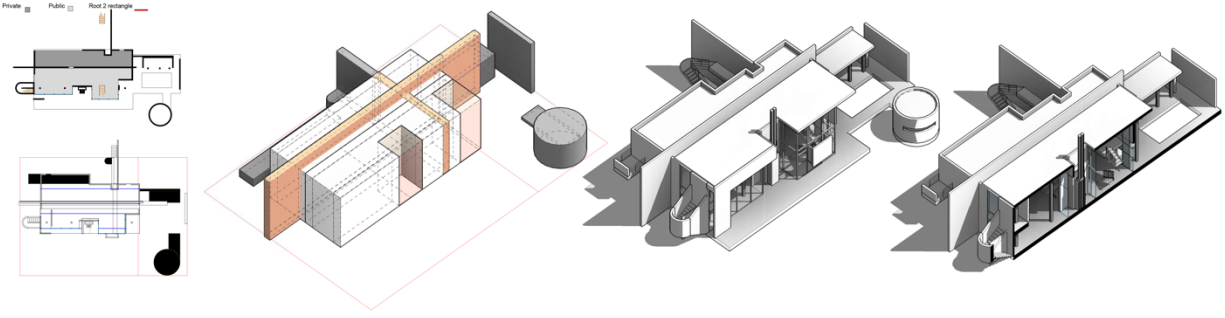
PROJECT 2 - HOUSE 2

BC007631



PROJECT 2 - HOUSE 3

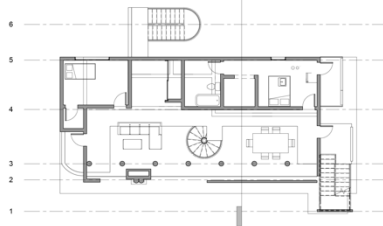
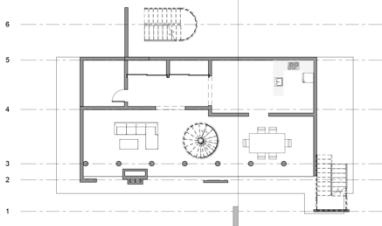
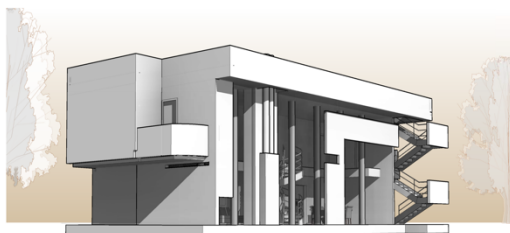
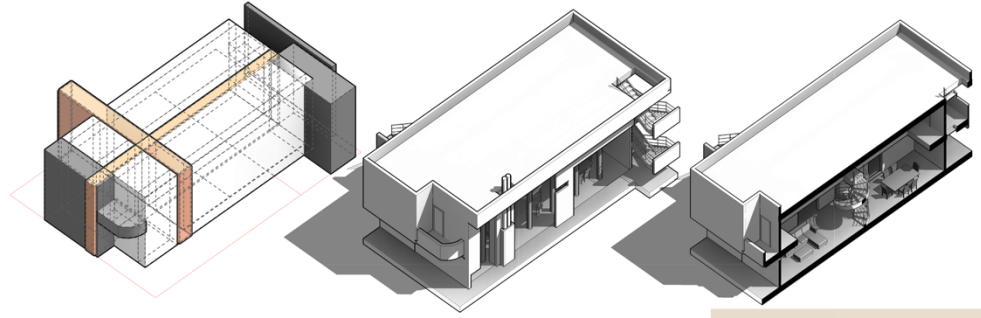
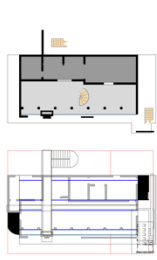
BC007631



# PROJECT 2 - HOUSE 4

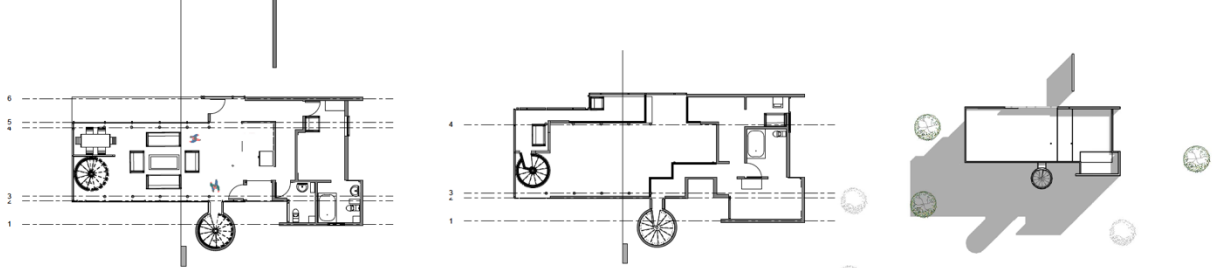
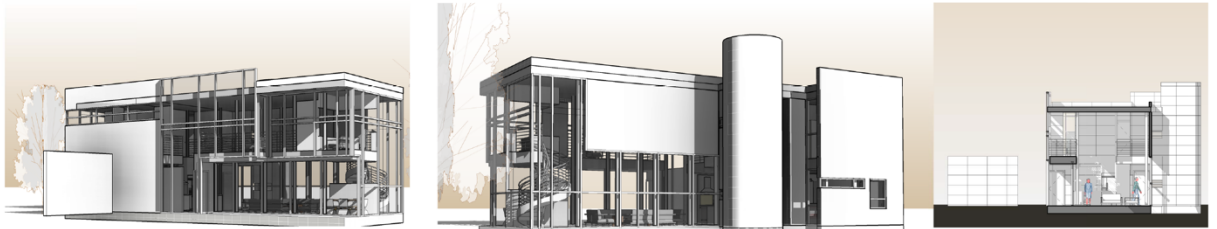
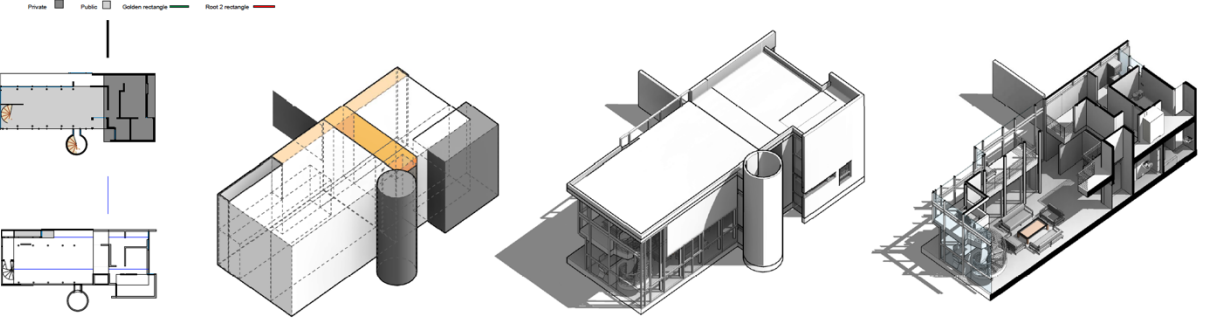
BC007631

Private Public Rest 2 restrooms



PROJECT 2 - HOUSE 1

BG009086

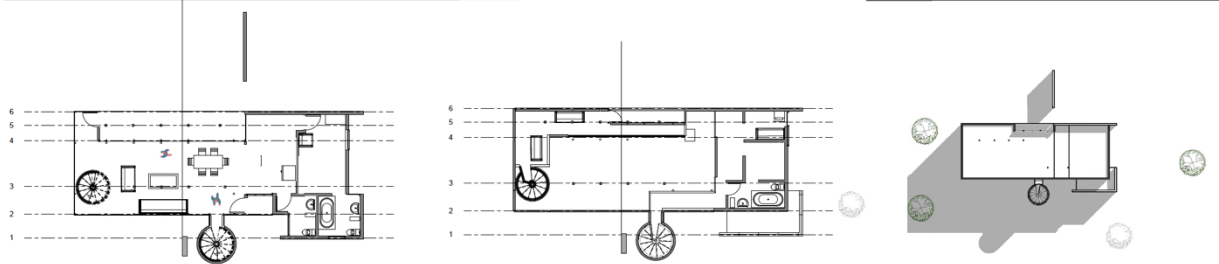
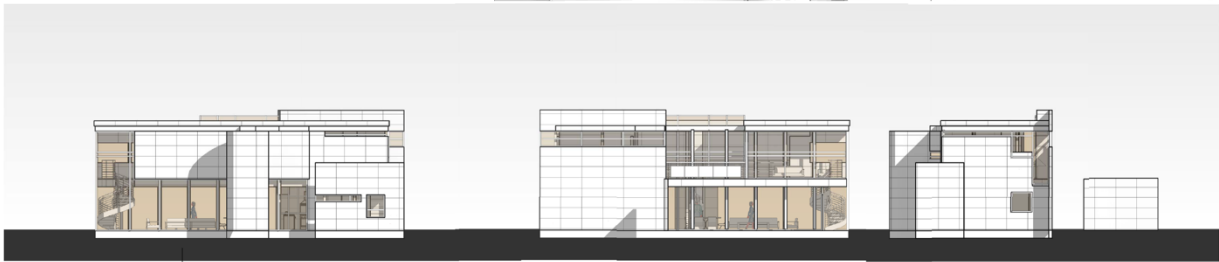
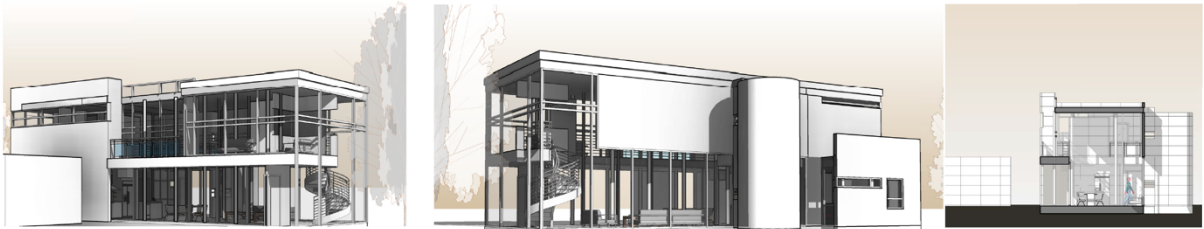
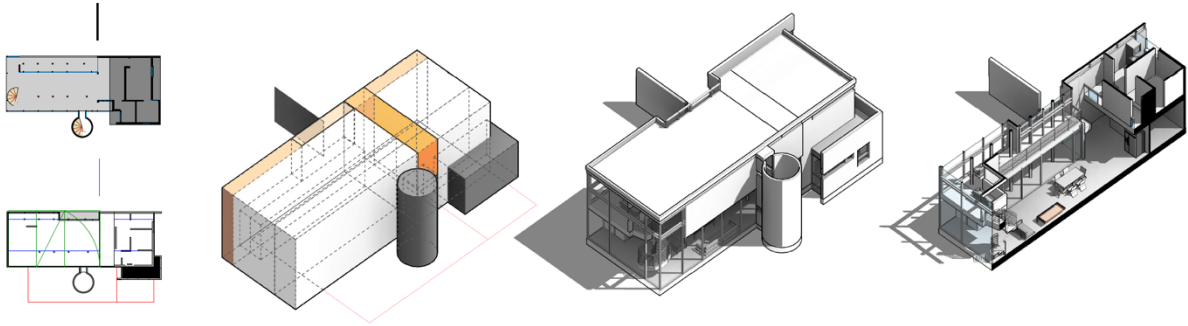




# PROJECT2 - HOUSE 2

BG009086

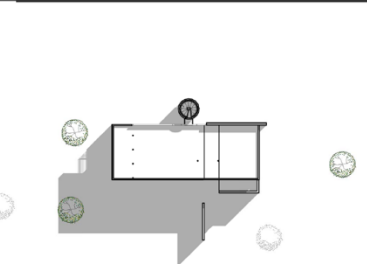
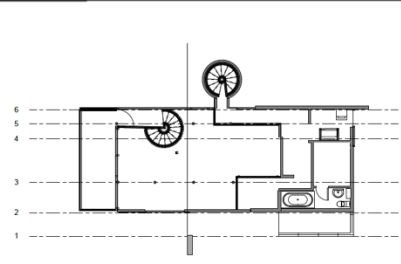
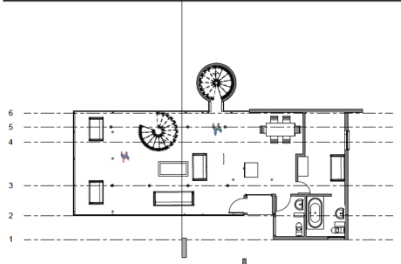
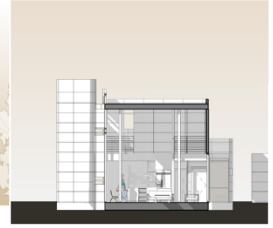
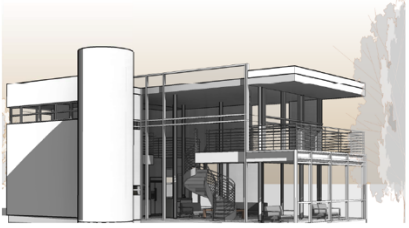
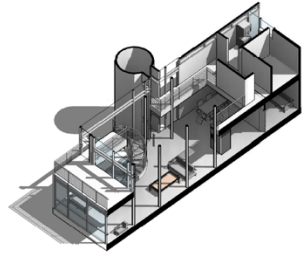
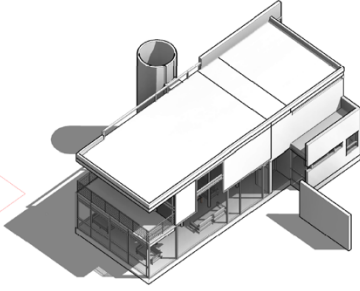
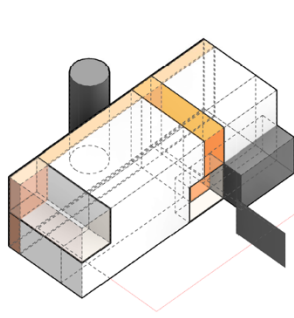
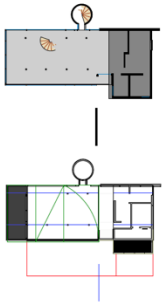
Private ■ Public ■ Golden rectangle ■ Red 2 rectangle ■



# PROJECT 2 - HOUSE 3

BG009086

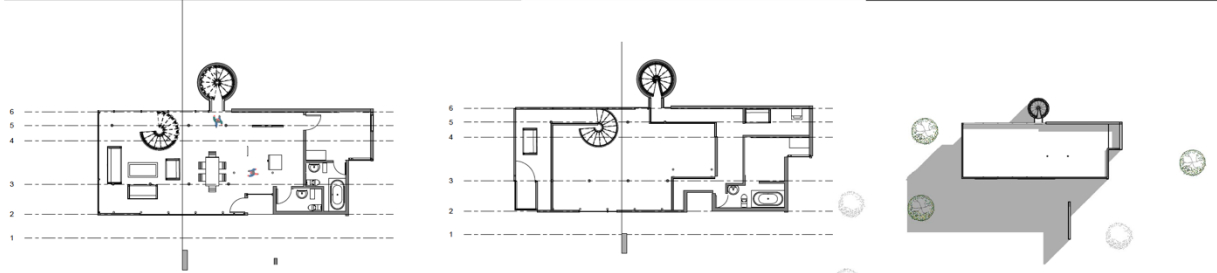
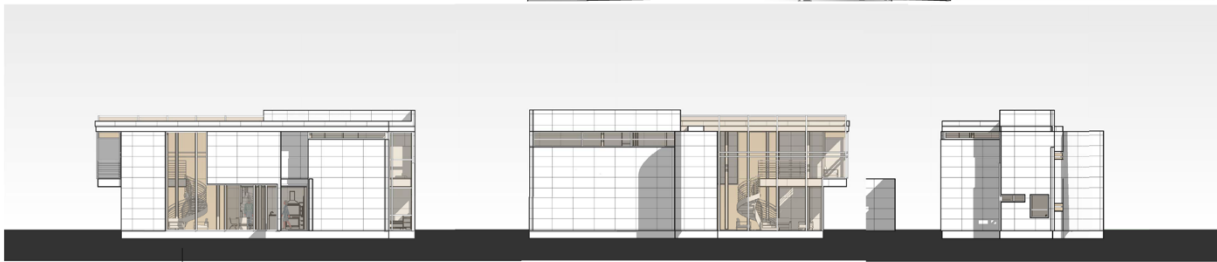
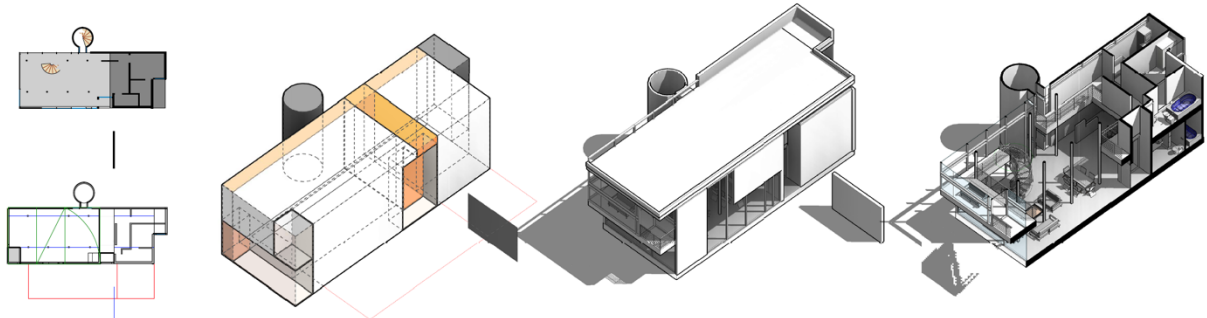
Private ■ Public □ Golden rectangle — Red 2 rectangle —



# PROJECT 2 - HOUSE 4

BG009086

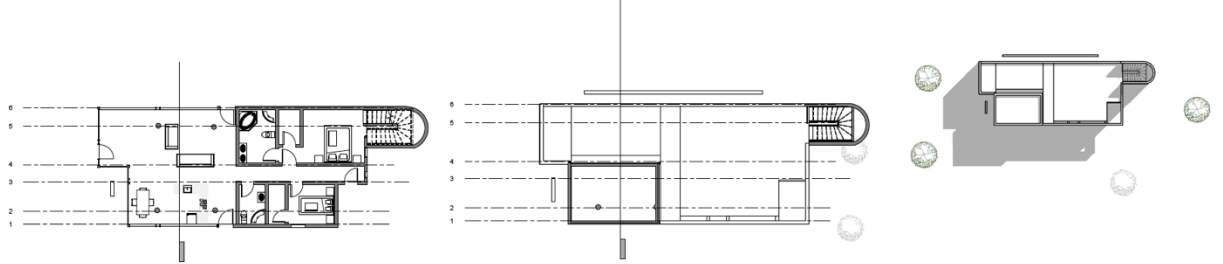
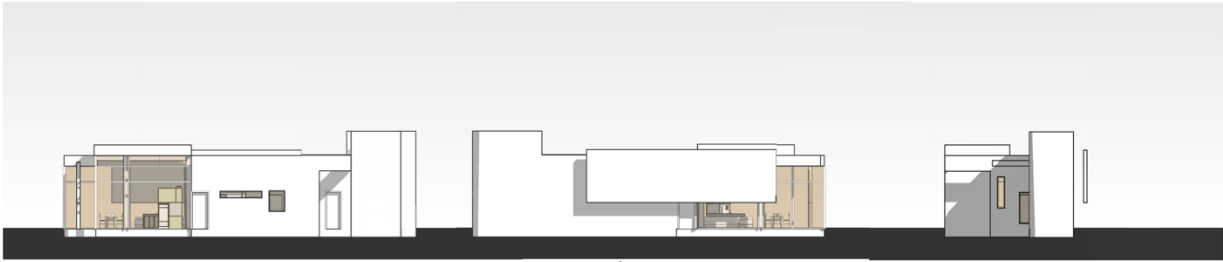
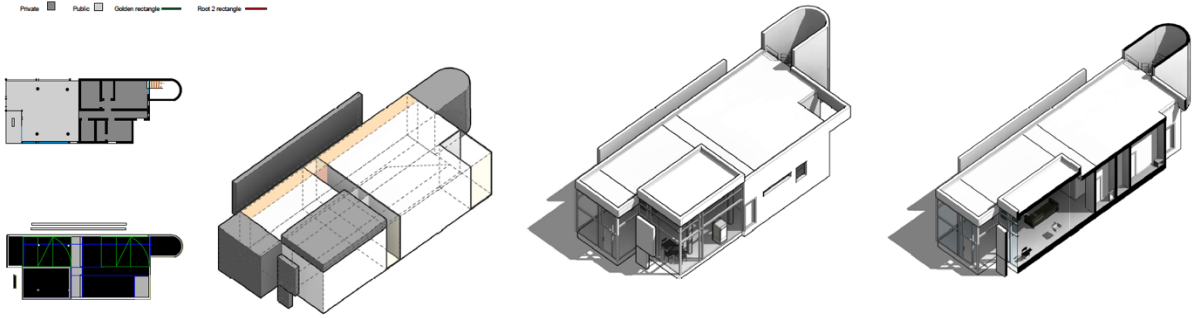
Private ■ Public □ Golden rectangle ■ Roof 2 rectangle ■



PROJECT 2 - HOUSE 1

BP007683

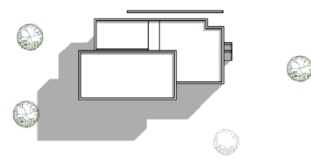
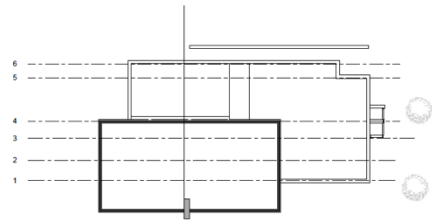
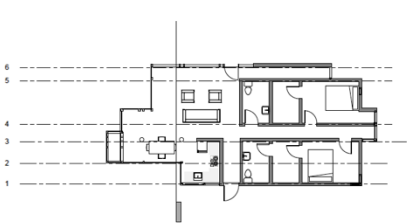
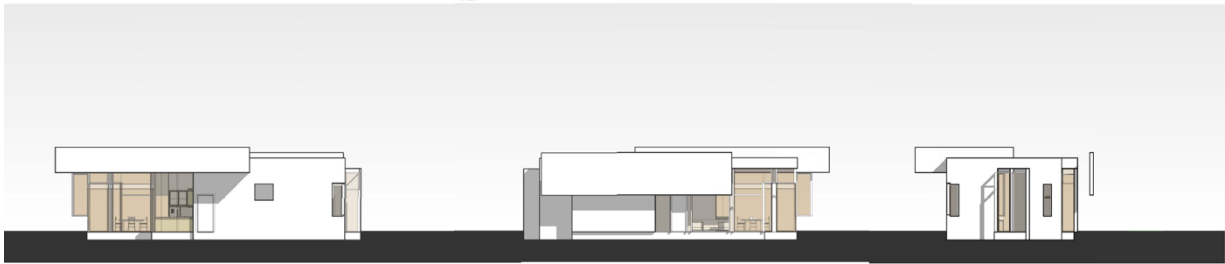
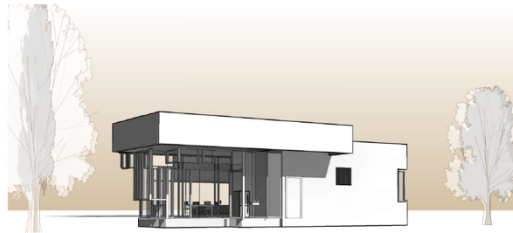
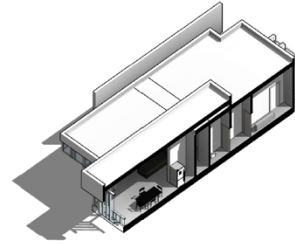
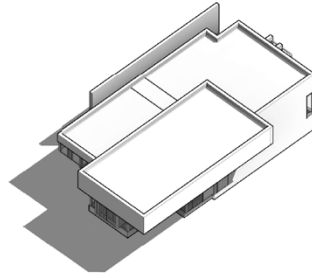
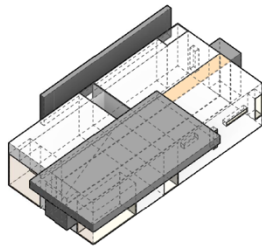
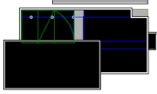
Private Public Outdoor rectangle Roof 2 rectangle



# PROJECT 2 - HOUSE 2

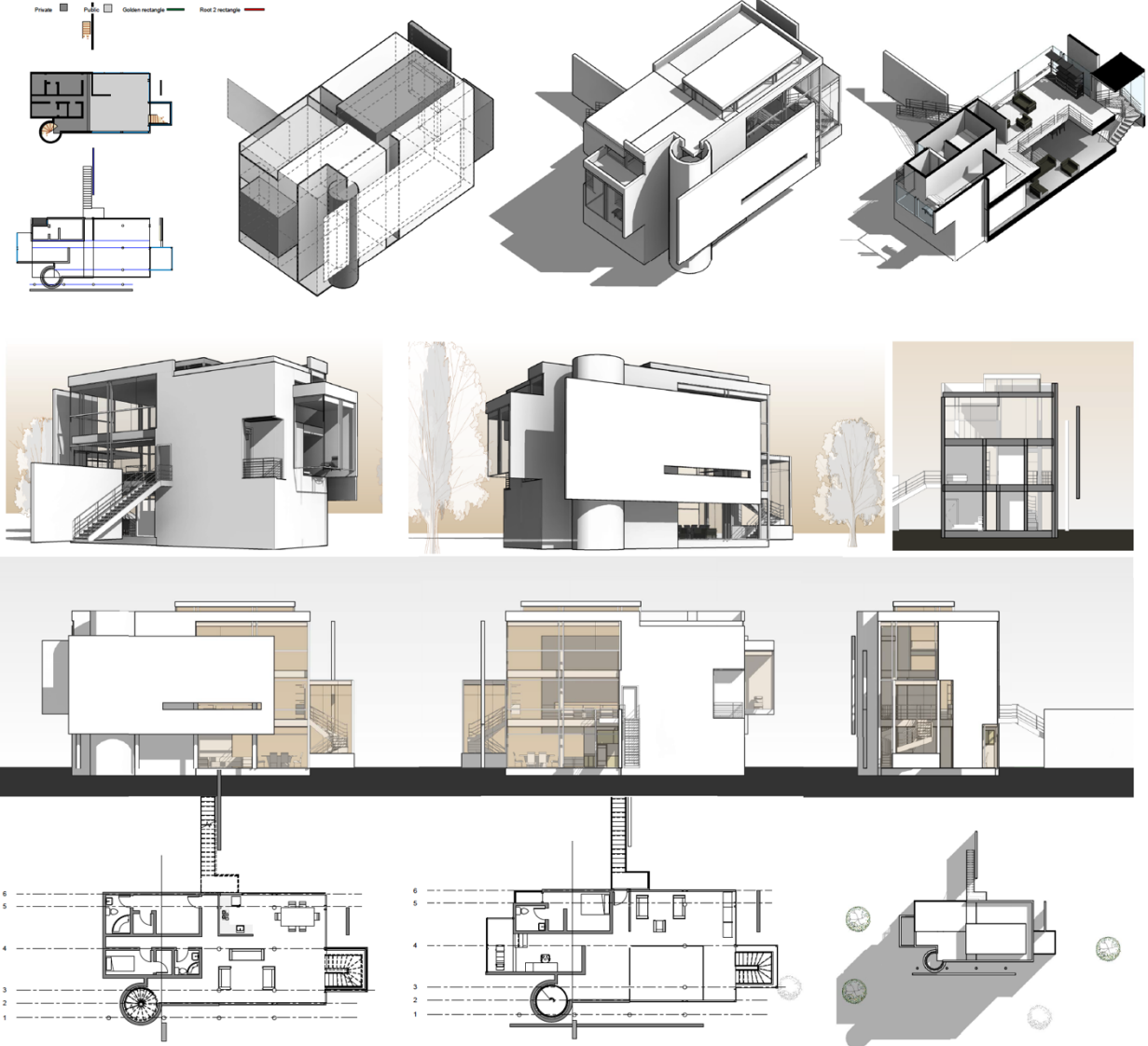
BP007683

Private Public Golden rectangle Root 2 rectangle



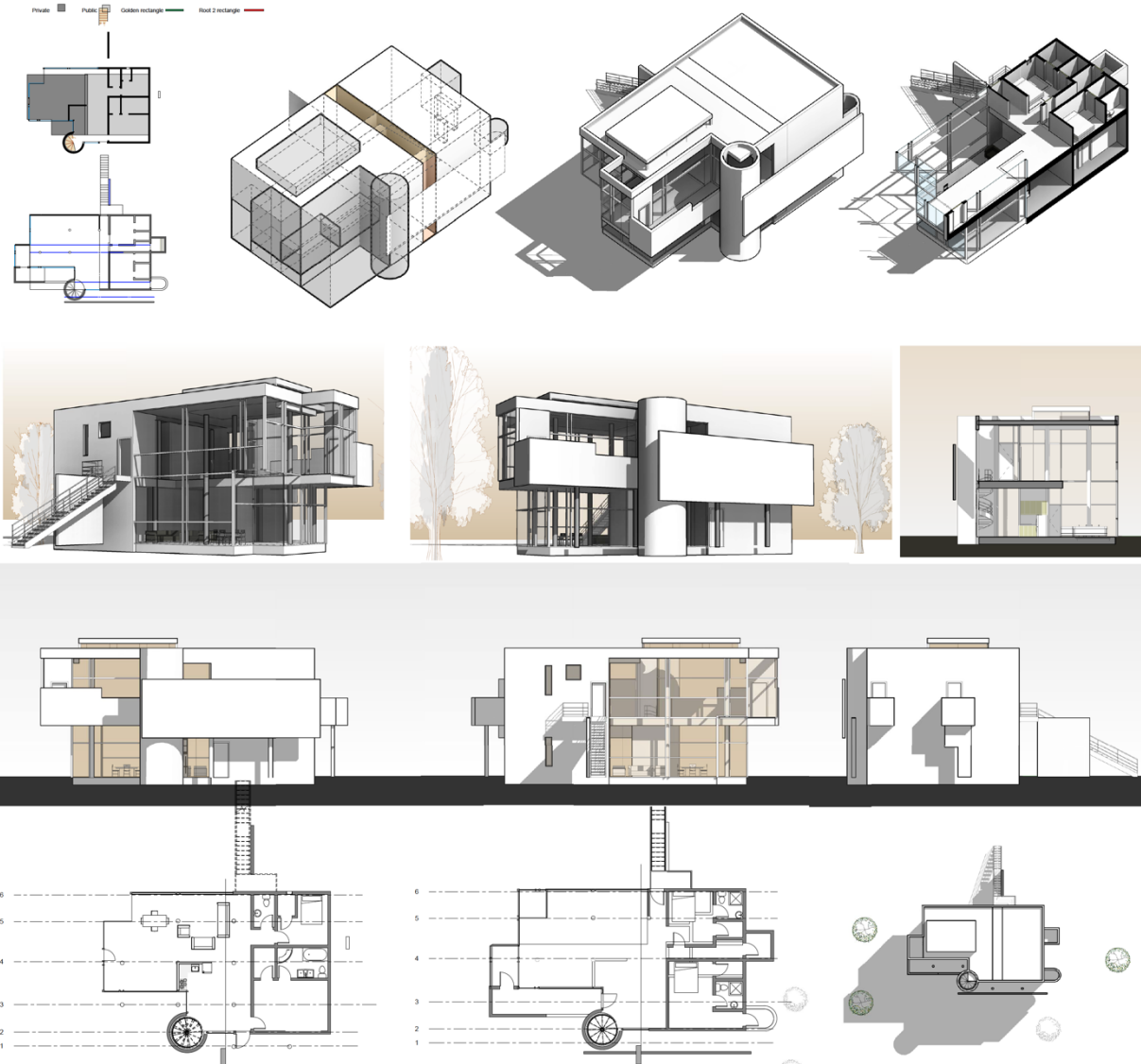
# PROJECT 2 - HOUSE 3

BP007683



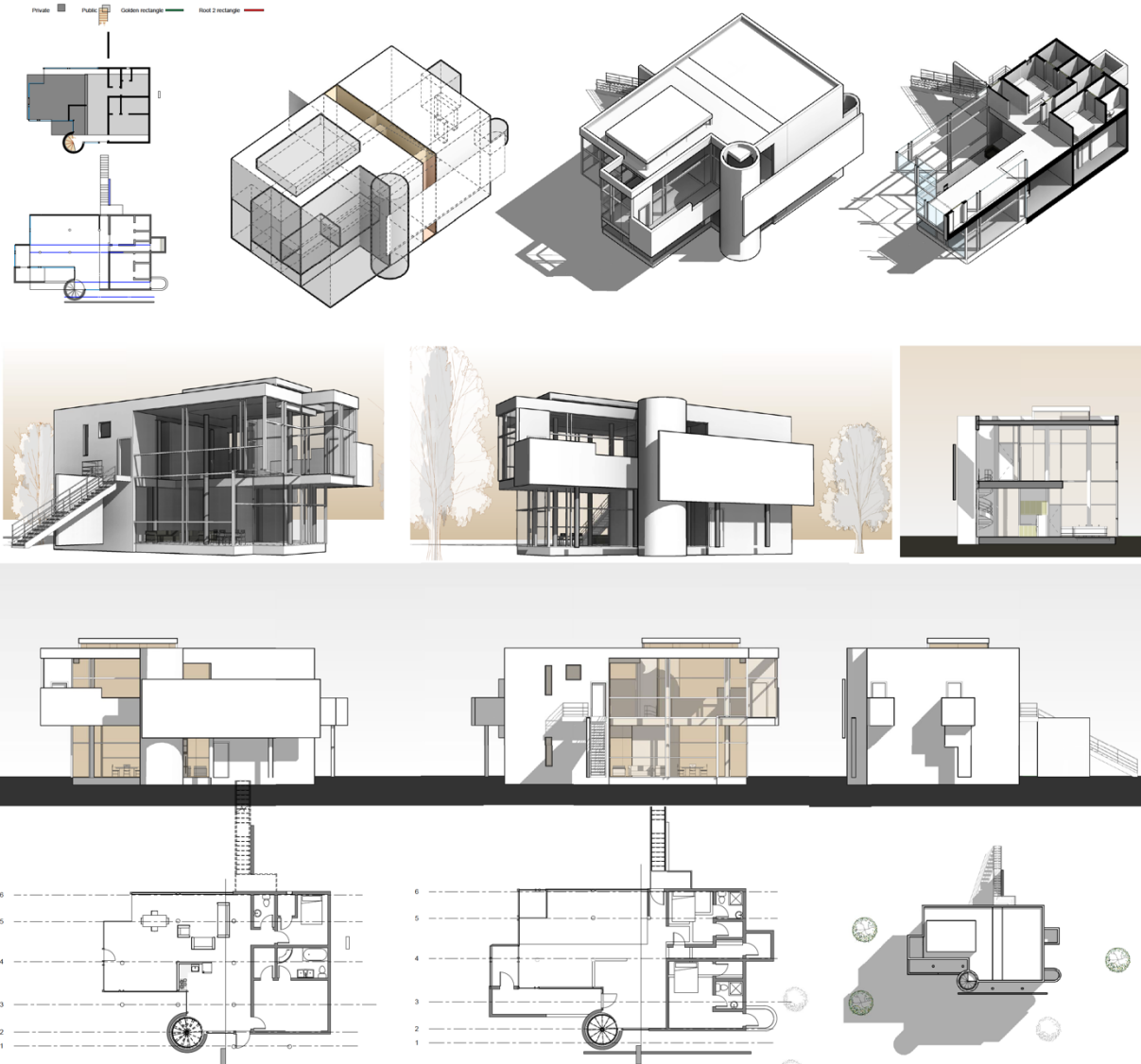
PROJECT 2 - HOUSE 4

BP007683



# PROJECT 2 - HOUSE 4

BP007683

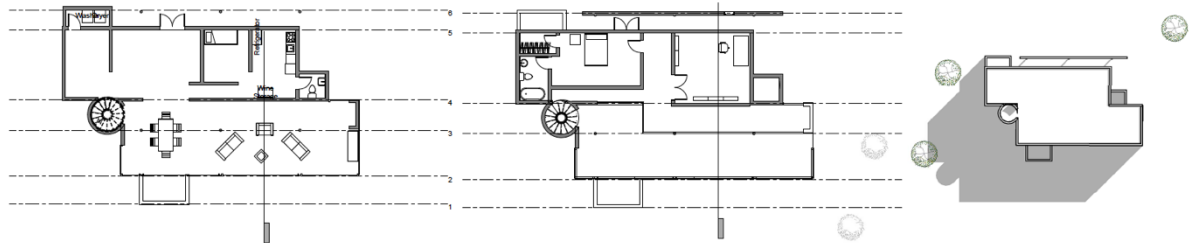
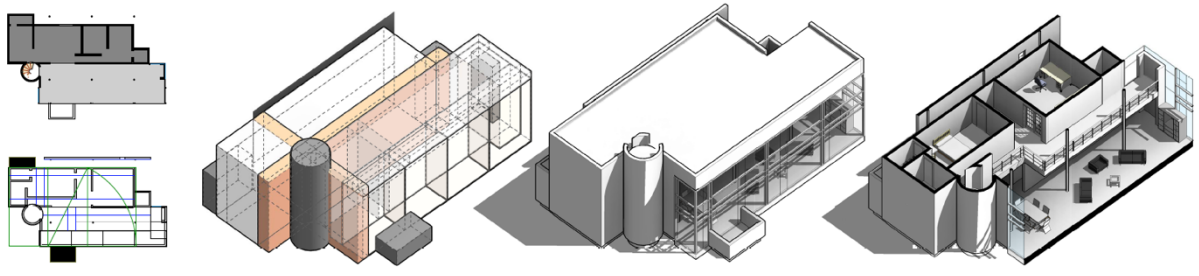




PROJECT 2 - HOUSE 2

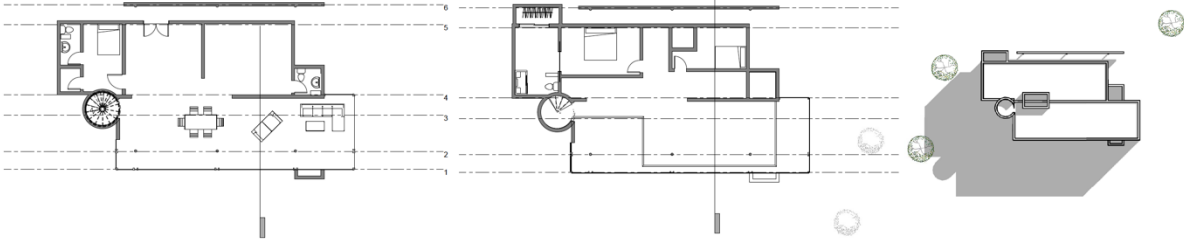
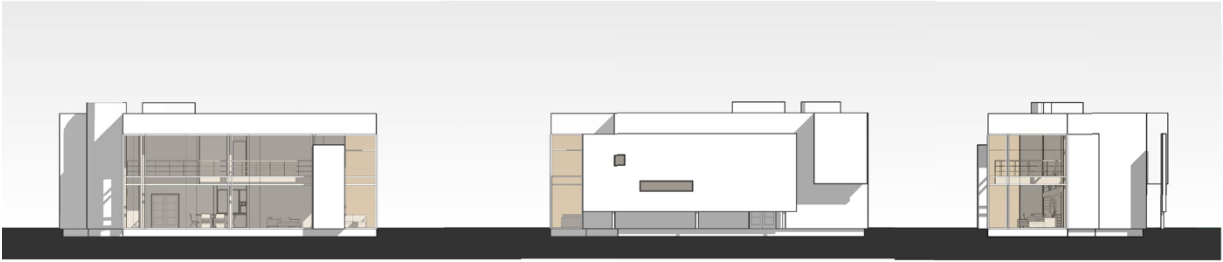
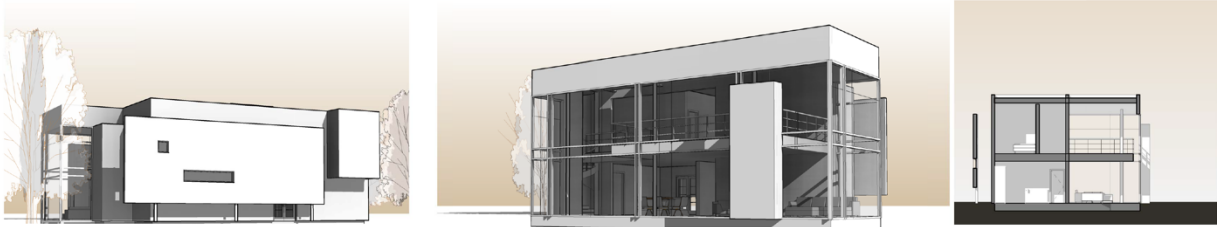
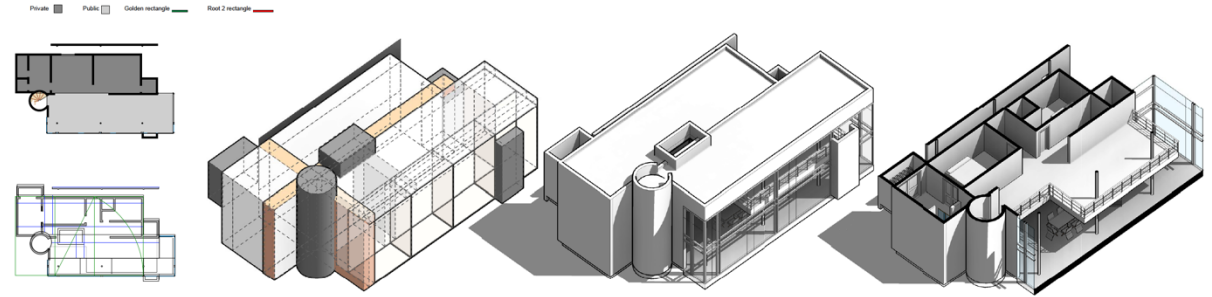
KA004432

Phase ■ Public □ Green rectangle --- Floor 2 rectangle ---







PROJECT 2 - HOUSE 3

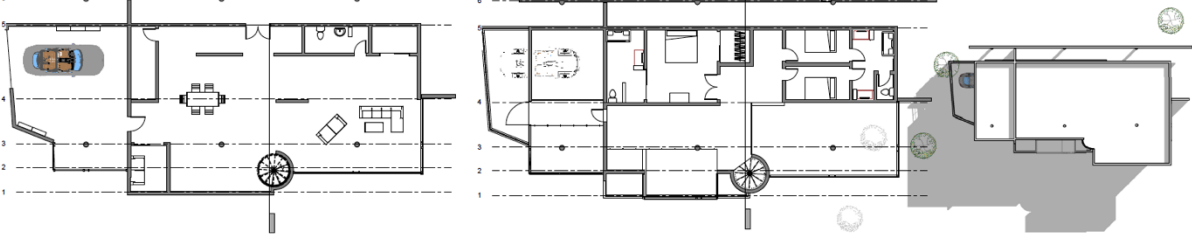
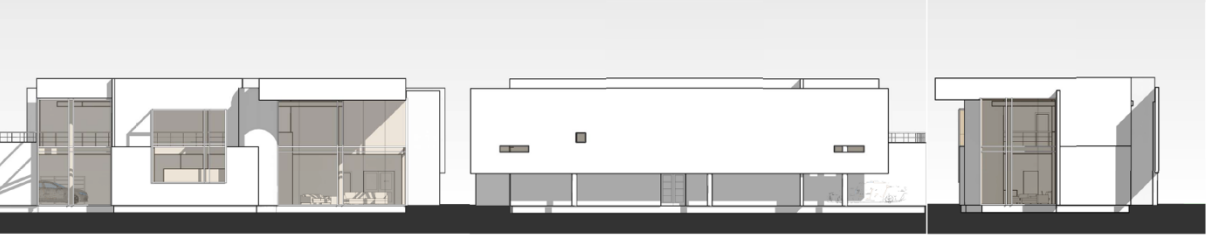
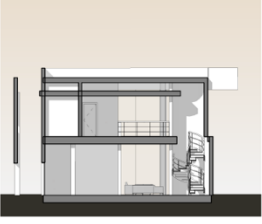
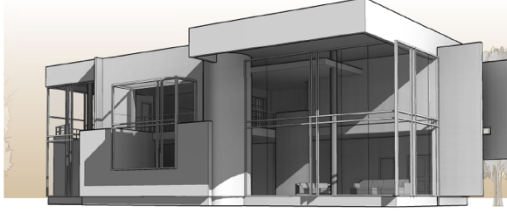
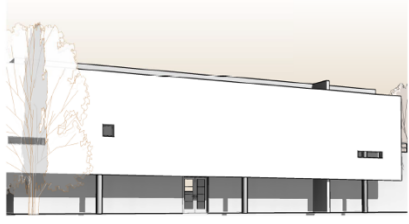
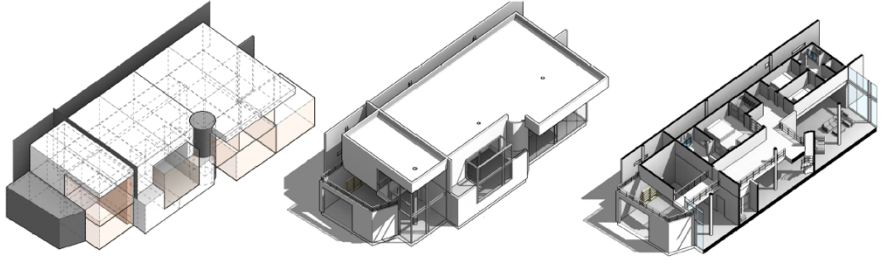
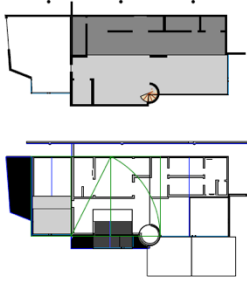
KA004432



# PROJECT 2 - HOUSE 4

KA004432

Private  Public  Golden rectangle  Roof 2 rectangle 

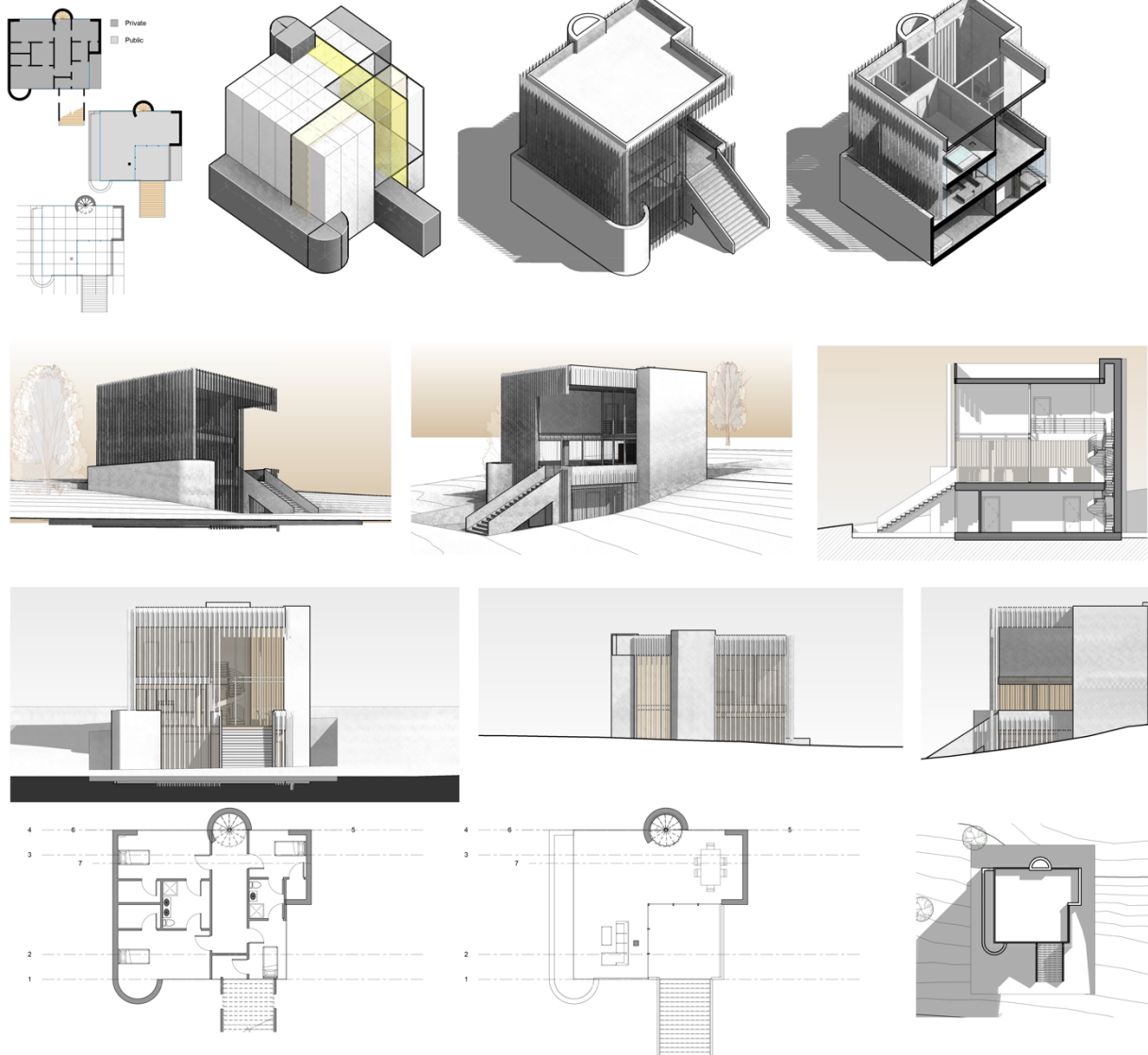


## Selected Projects - Project 3

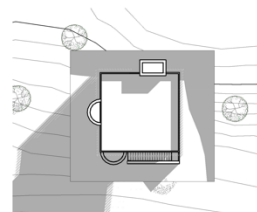
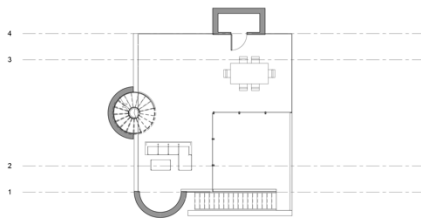
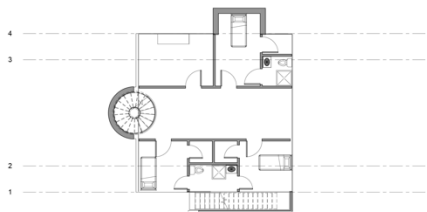
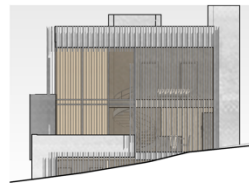
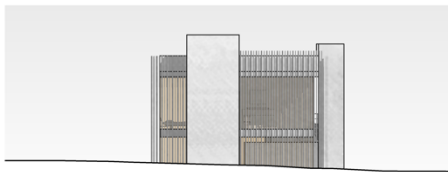
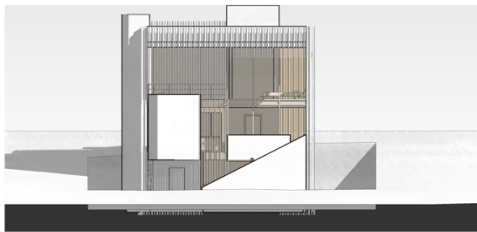
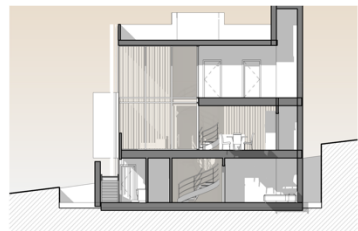
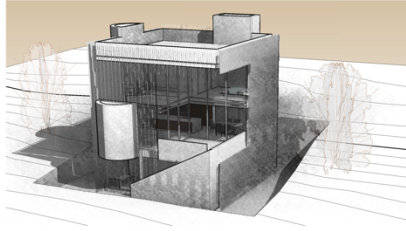
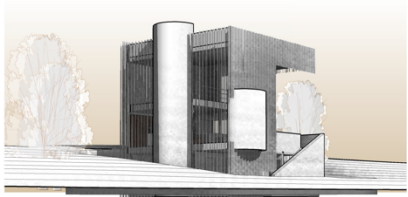
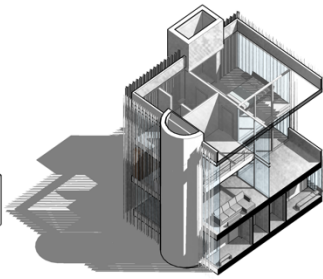
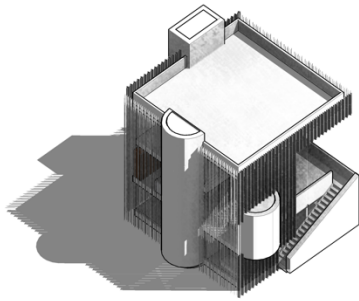
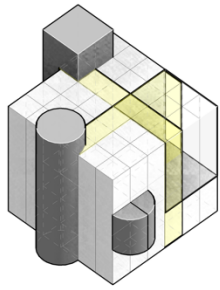
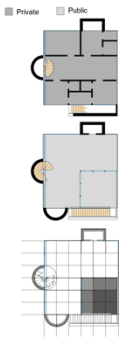
**Theme 1:** Houses that were based on principles from other architects, work of art, or certain typology.

1. Based on the work of Charles Gwathmey

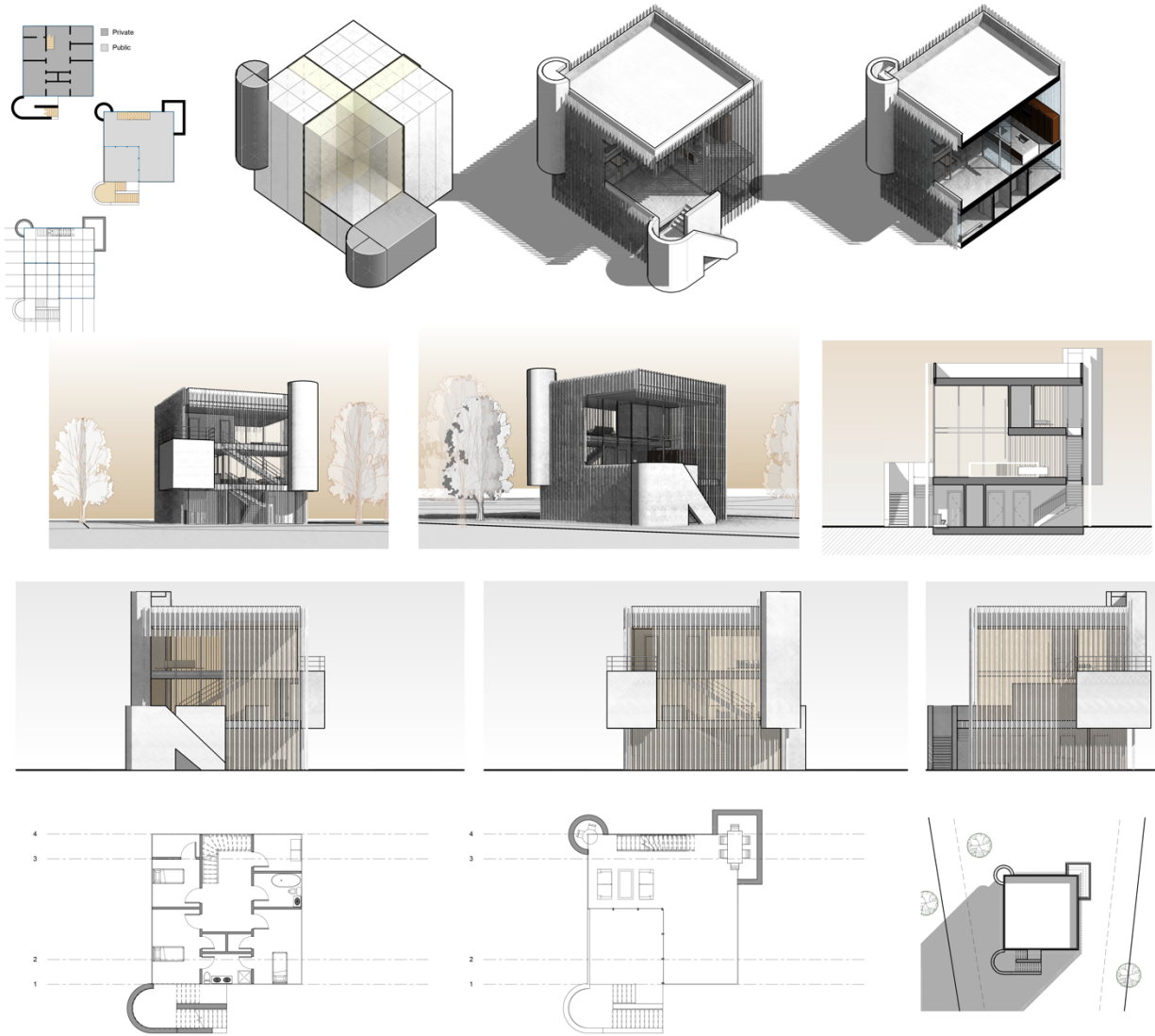
### HOUSE 1



# HOUSE 2

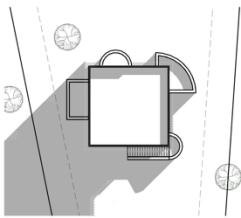
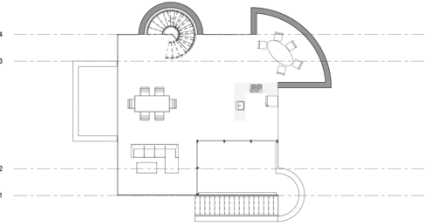
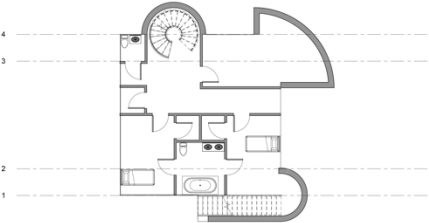
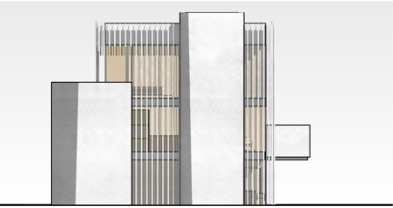
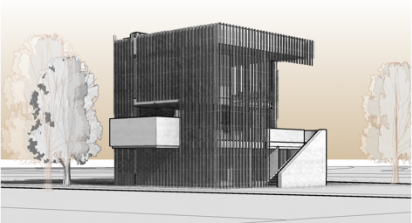
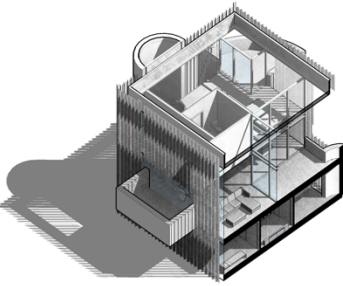
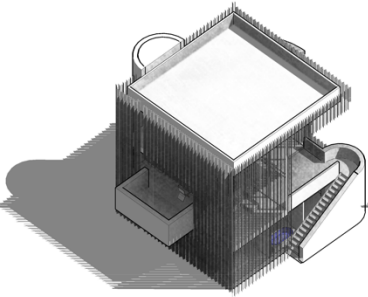
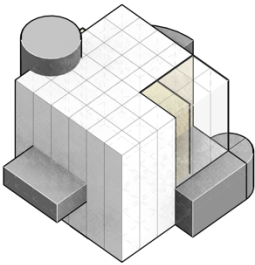
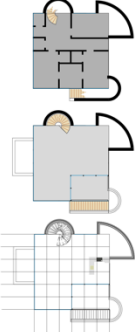


# HOUSE 3



# HOUSE 4

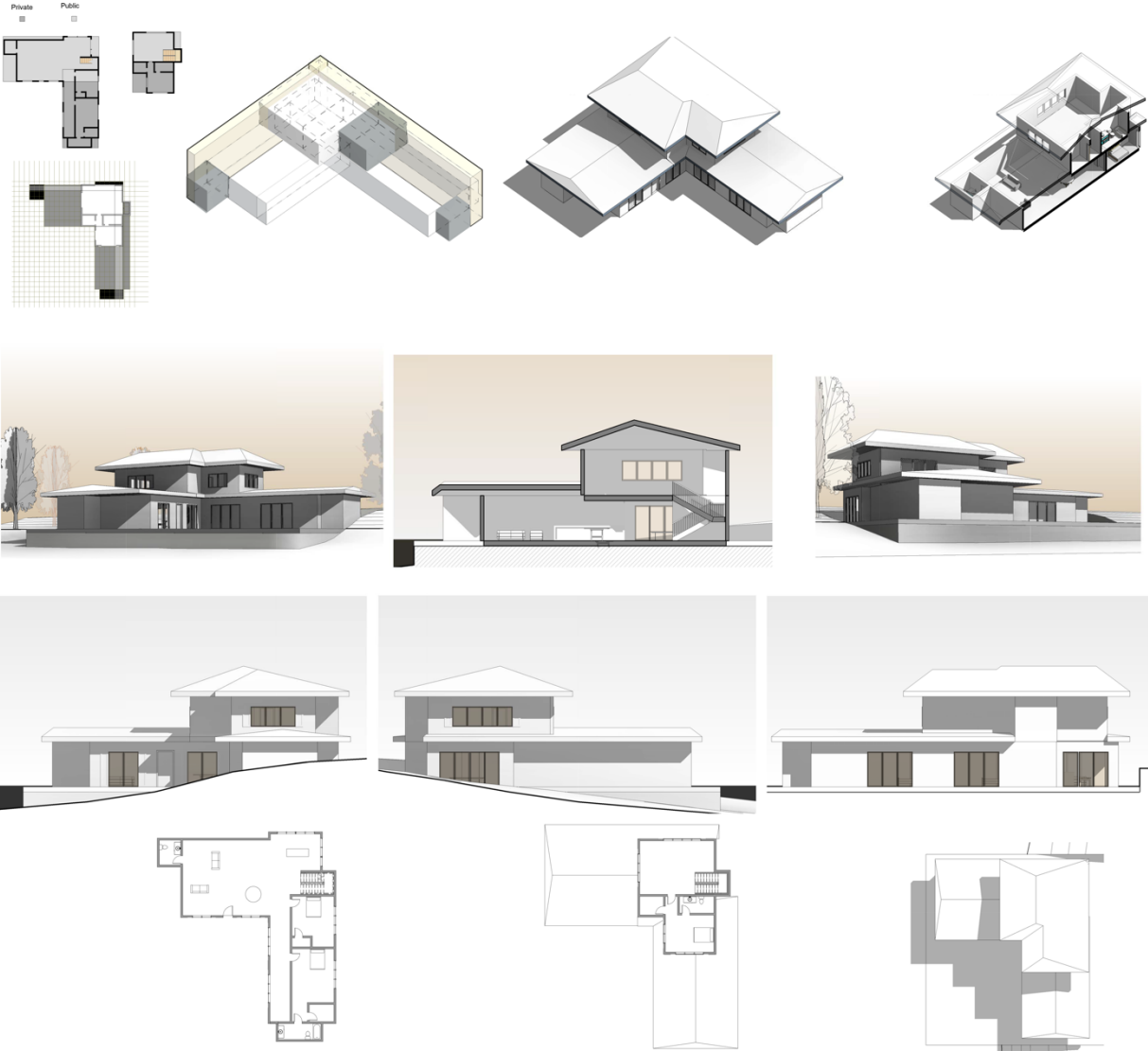
■ Private ■ Public





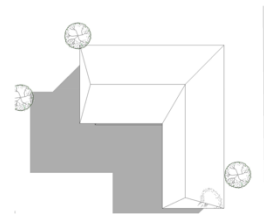
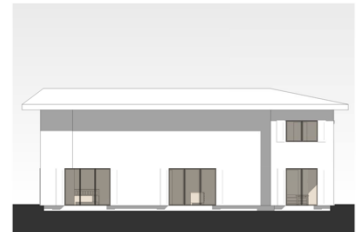
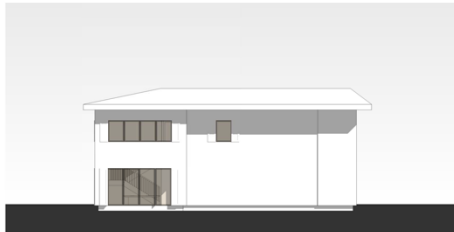
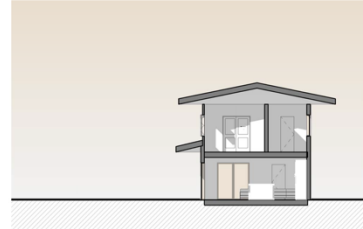
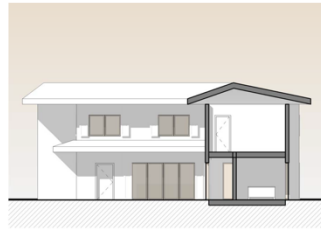
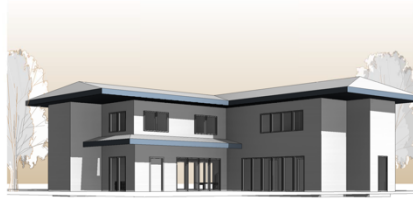
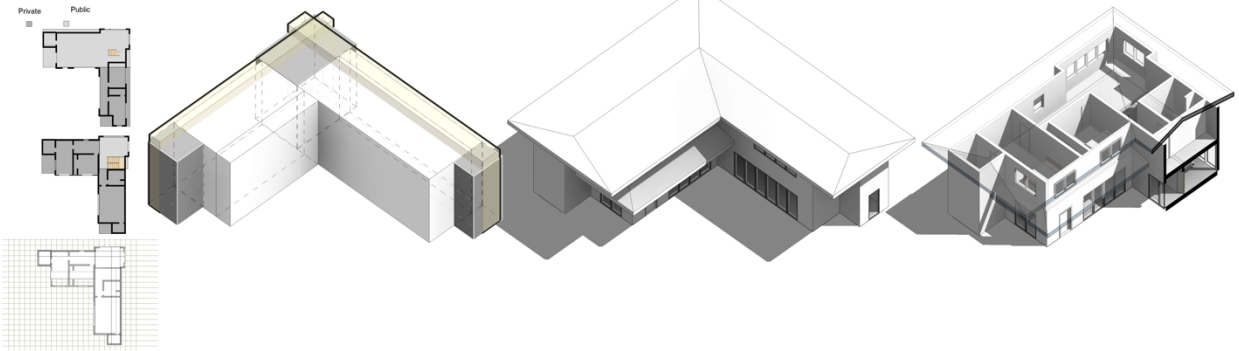
2. Based on the prairie houses by Frank Lloyd Wright

HOUSE 1

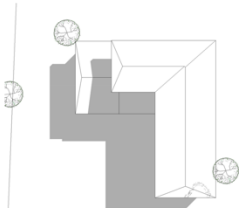
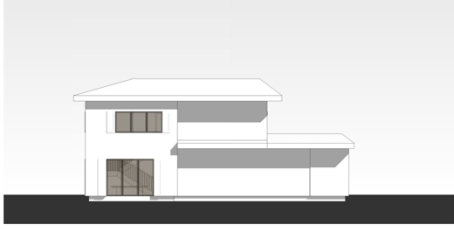
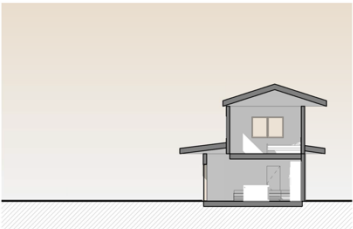
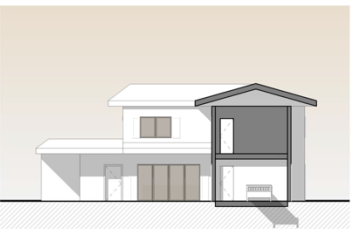
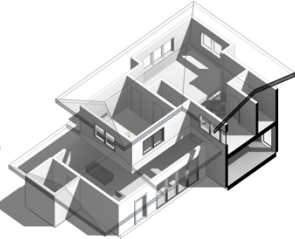
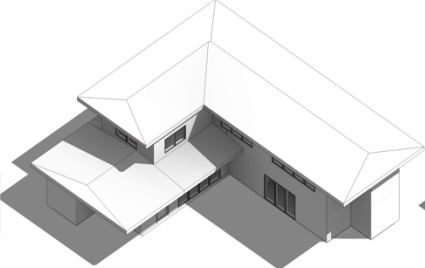
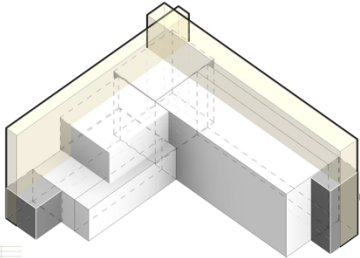
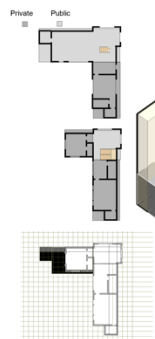




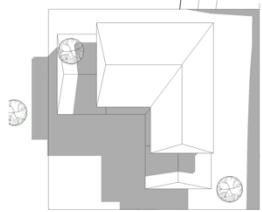
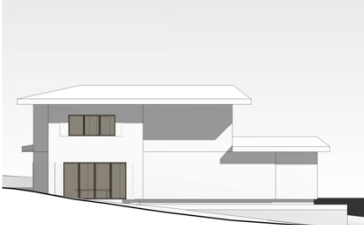
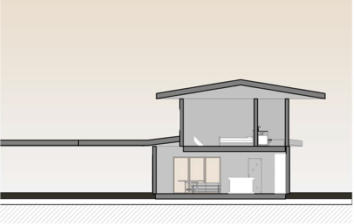
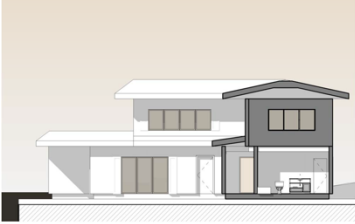
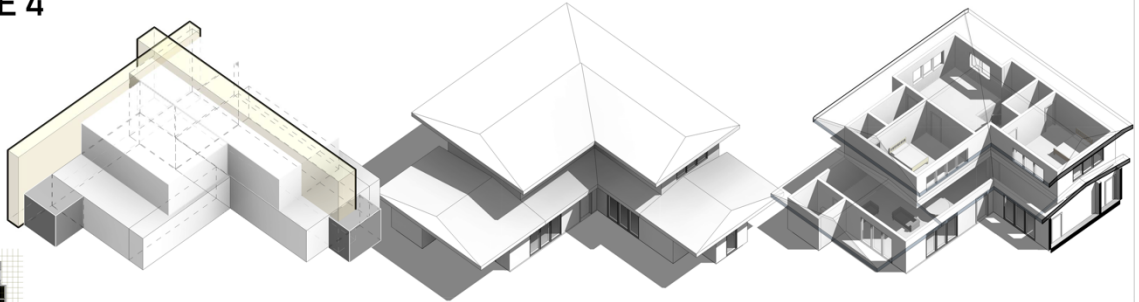
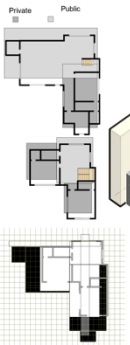
# HOUSE 2



# HOUSE 3

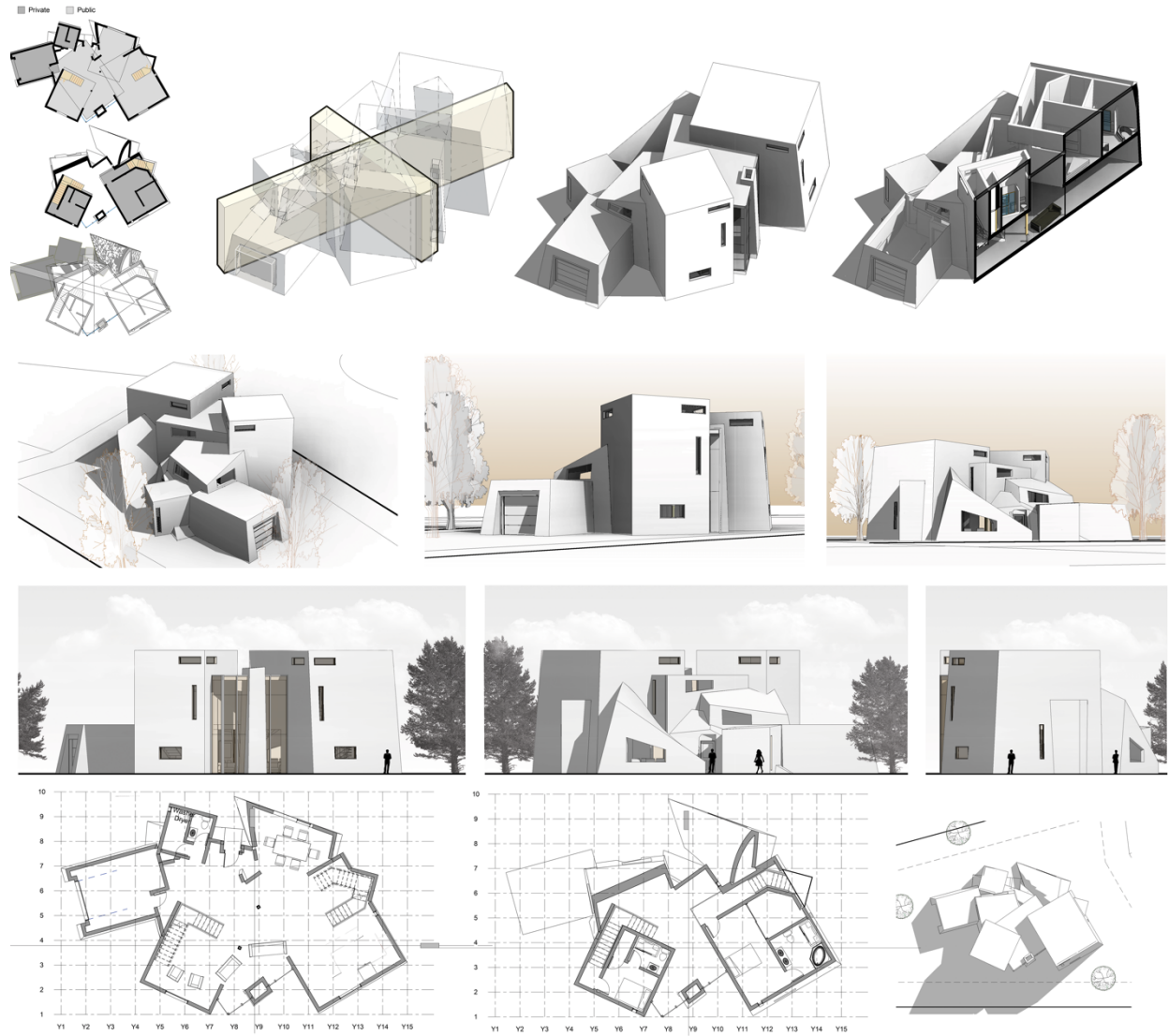


# HOUSE 4

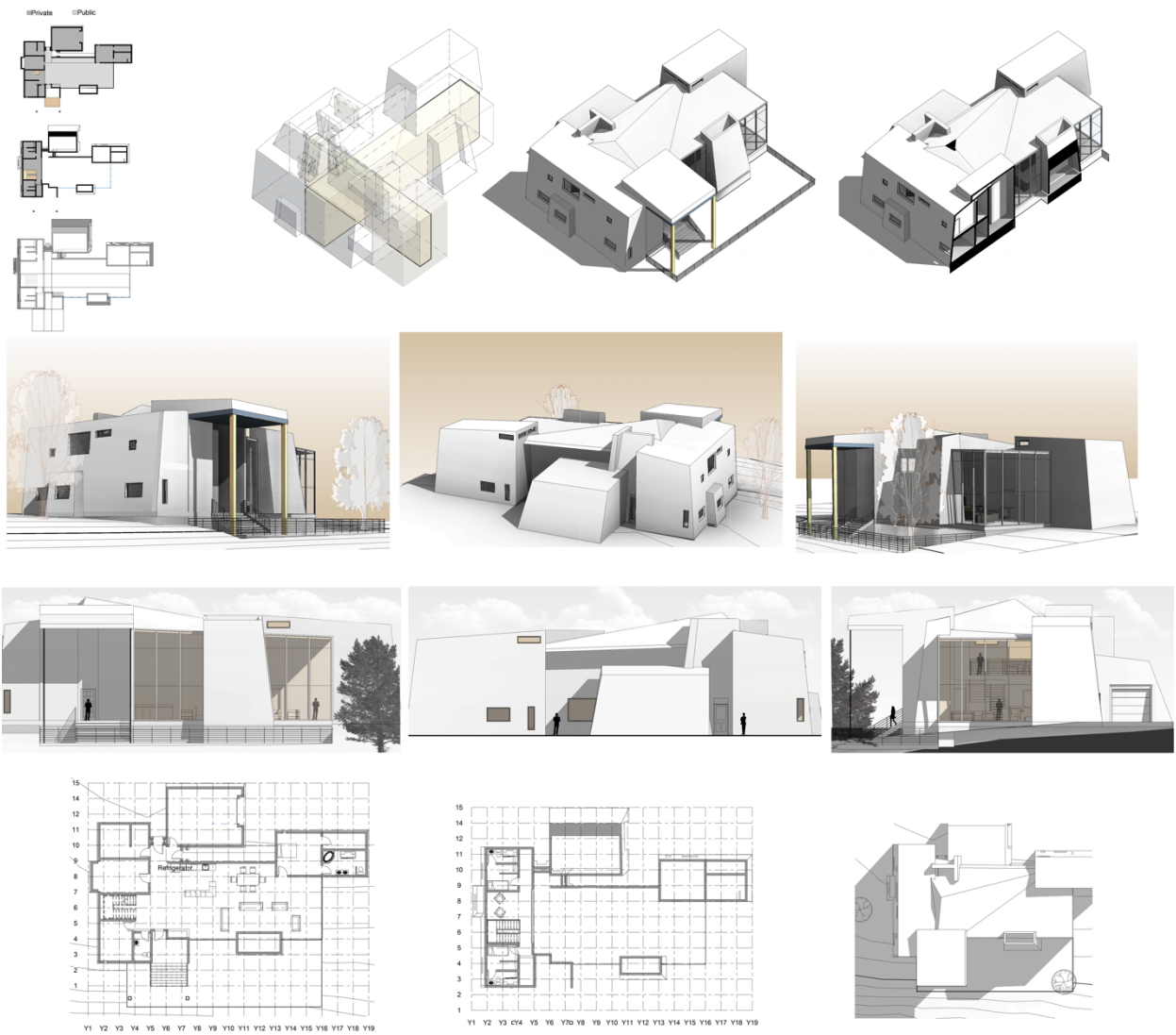


### 3. Based on Bruce Beasley bronze sculptures

## HOUSE 1 PROJECT 3

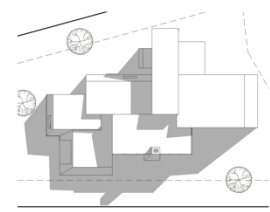
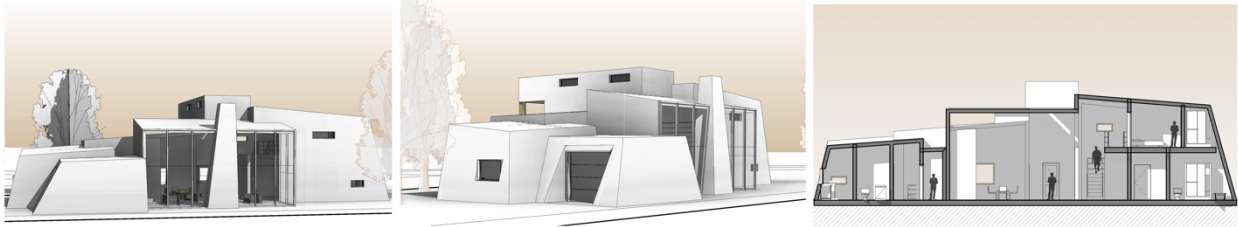
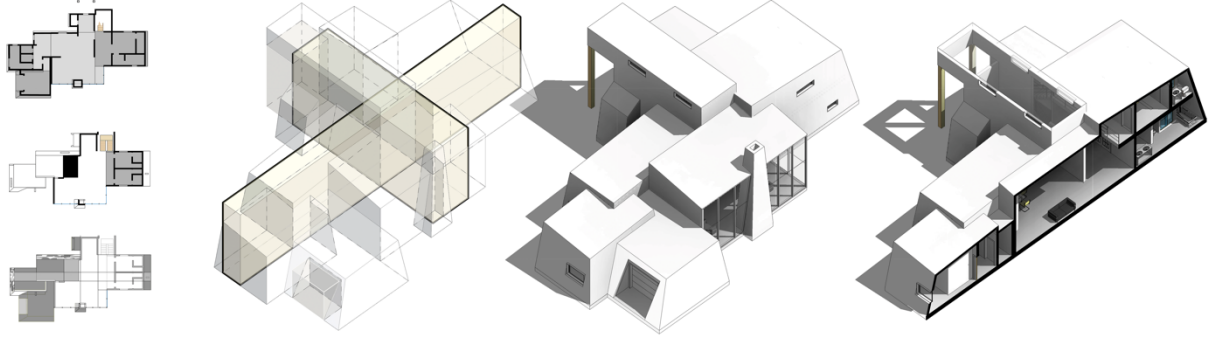


# HOUSE 2 PROJECT 3

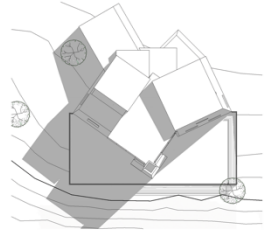
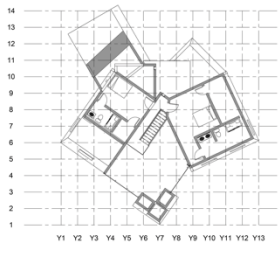
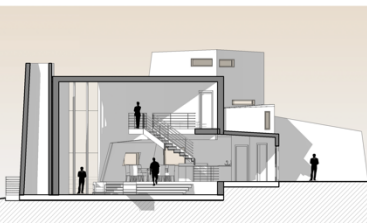
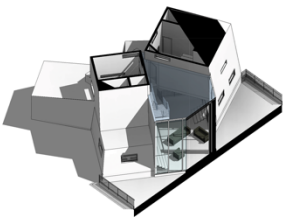
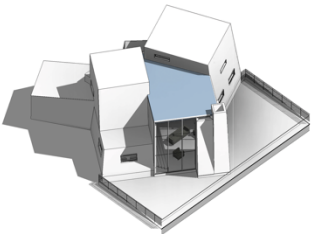
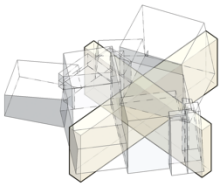


# HOUSE 3 PROJECT 3

Private Public



HOUSE 4 PROJECT 3

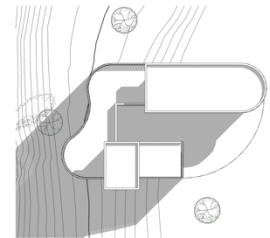
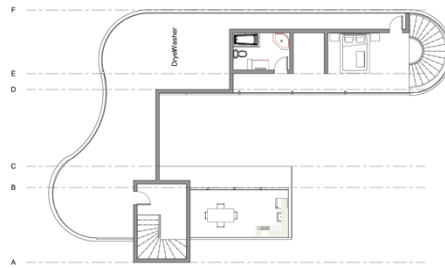
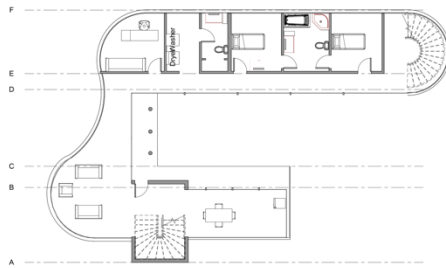
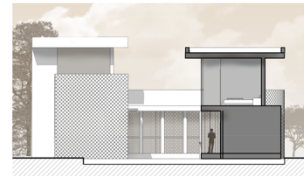
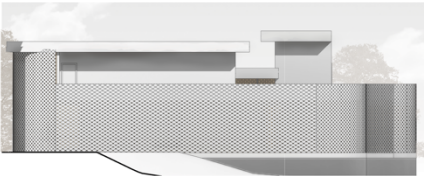
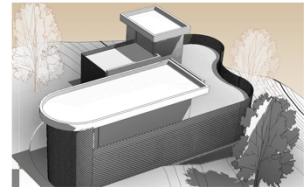
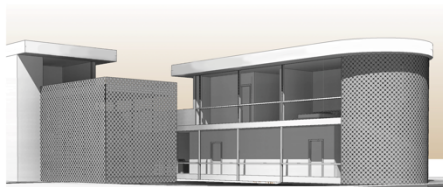
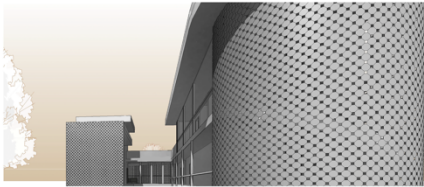
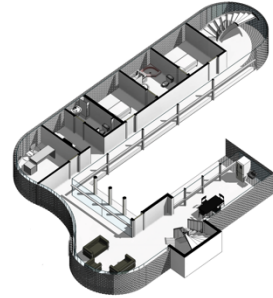
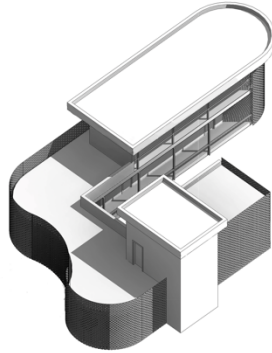
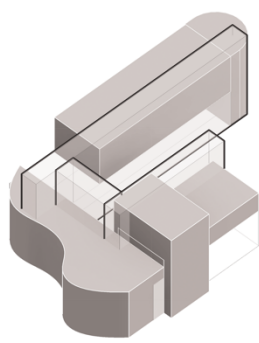
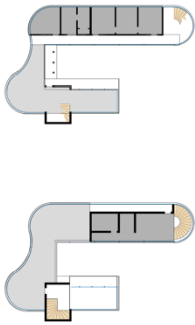




#### 4. Based on the typology of courtyard house

### HOUSE

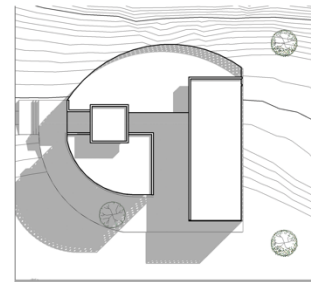
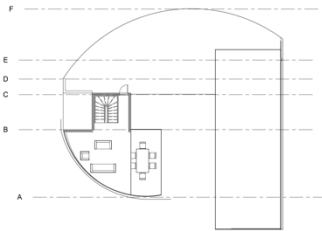
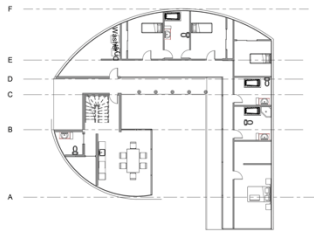
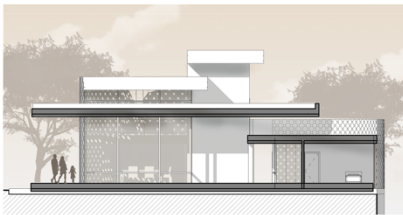
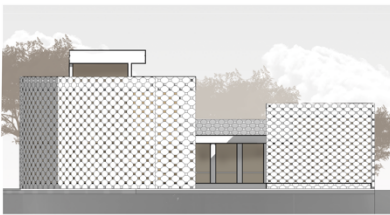
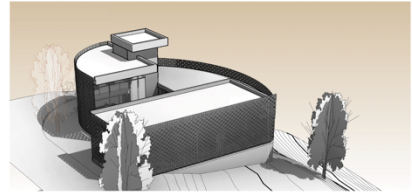
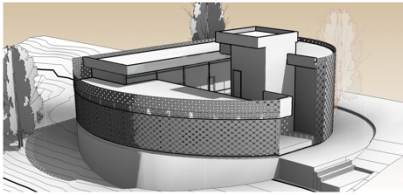
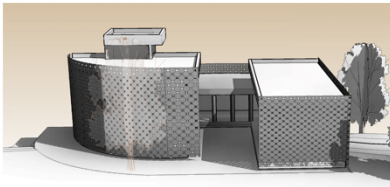
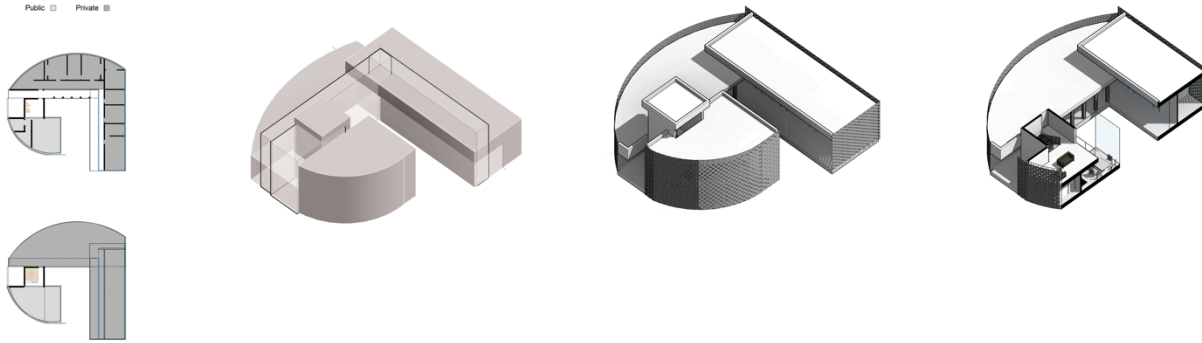
Private ■ Public ■





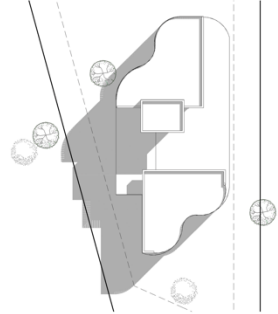
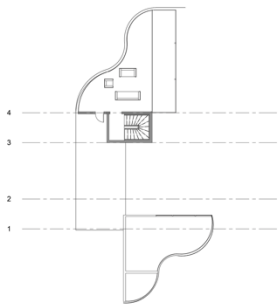
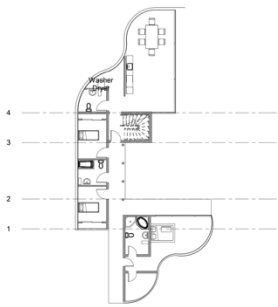
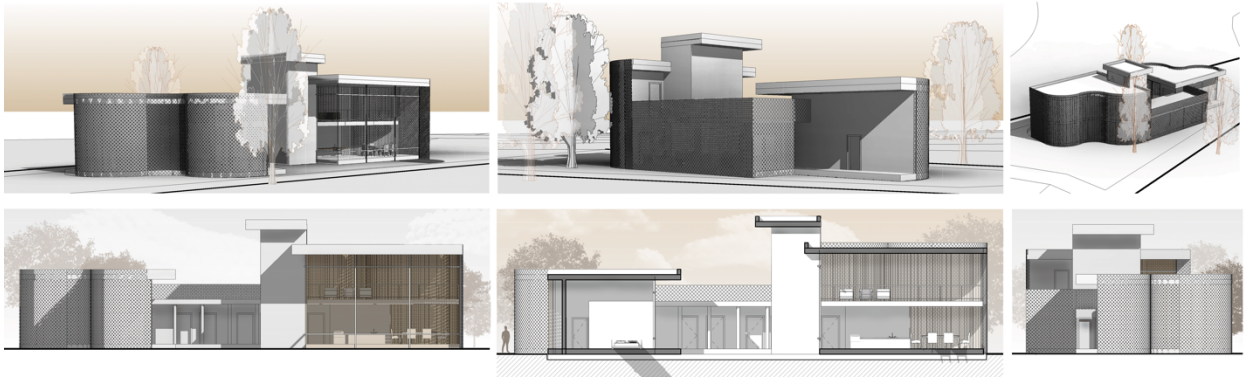
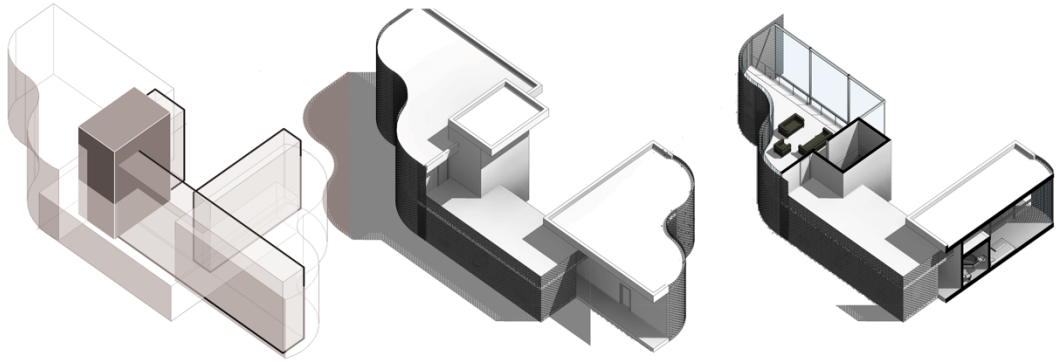
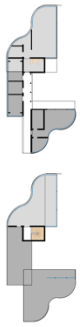
# HOUSE

Public ■ Private ■



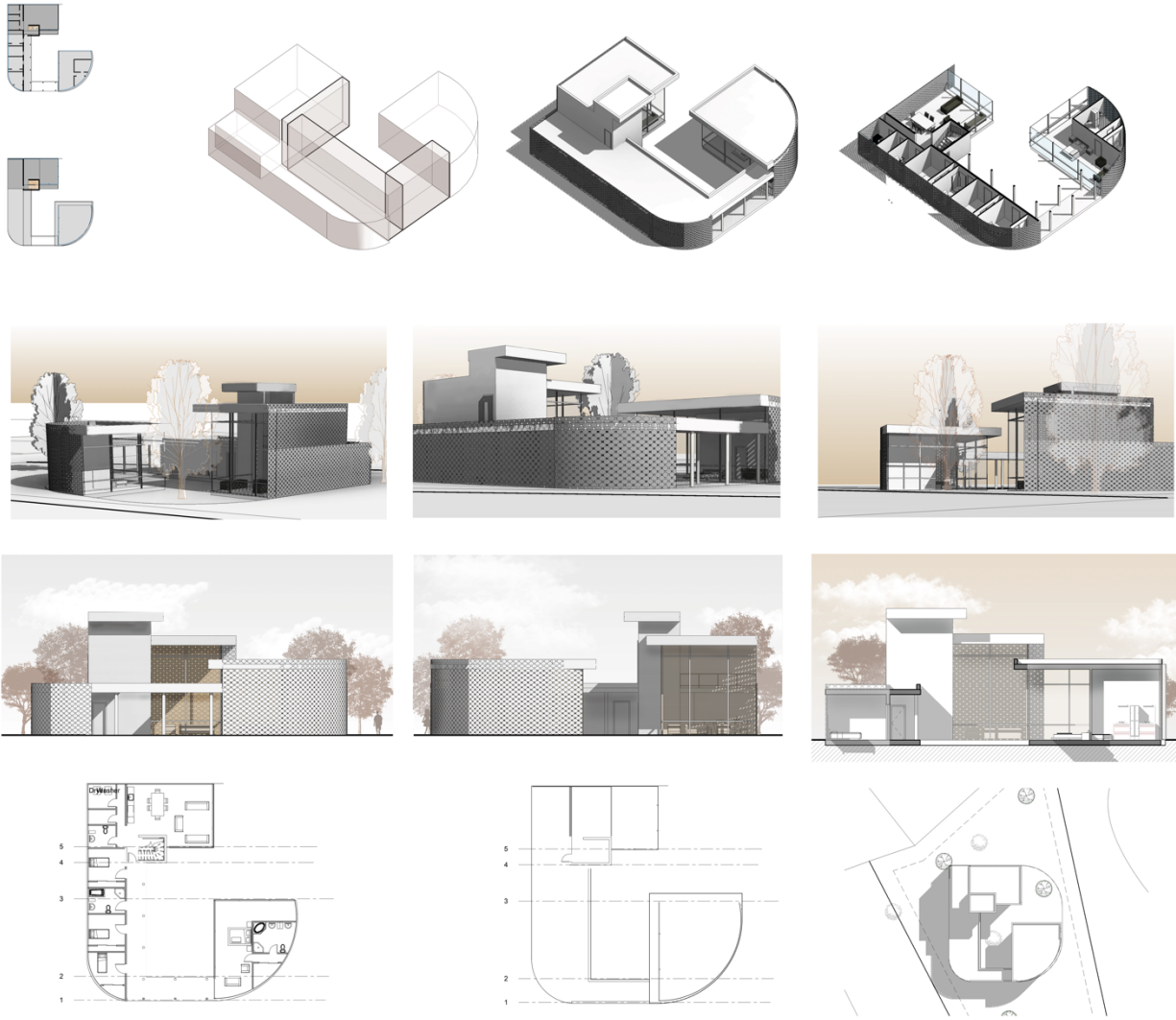
# HOUSE

Private ■ Public □



# HOUSE

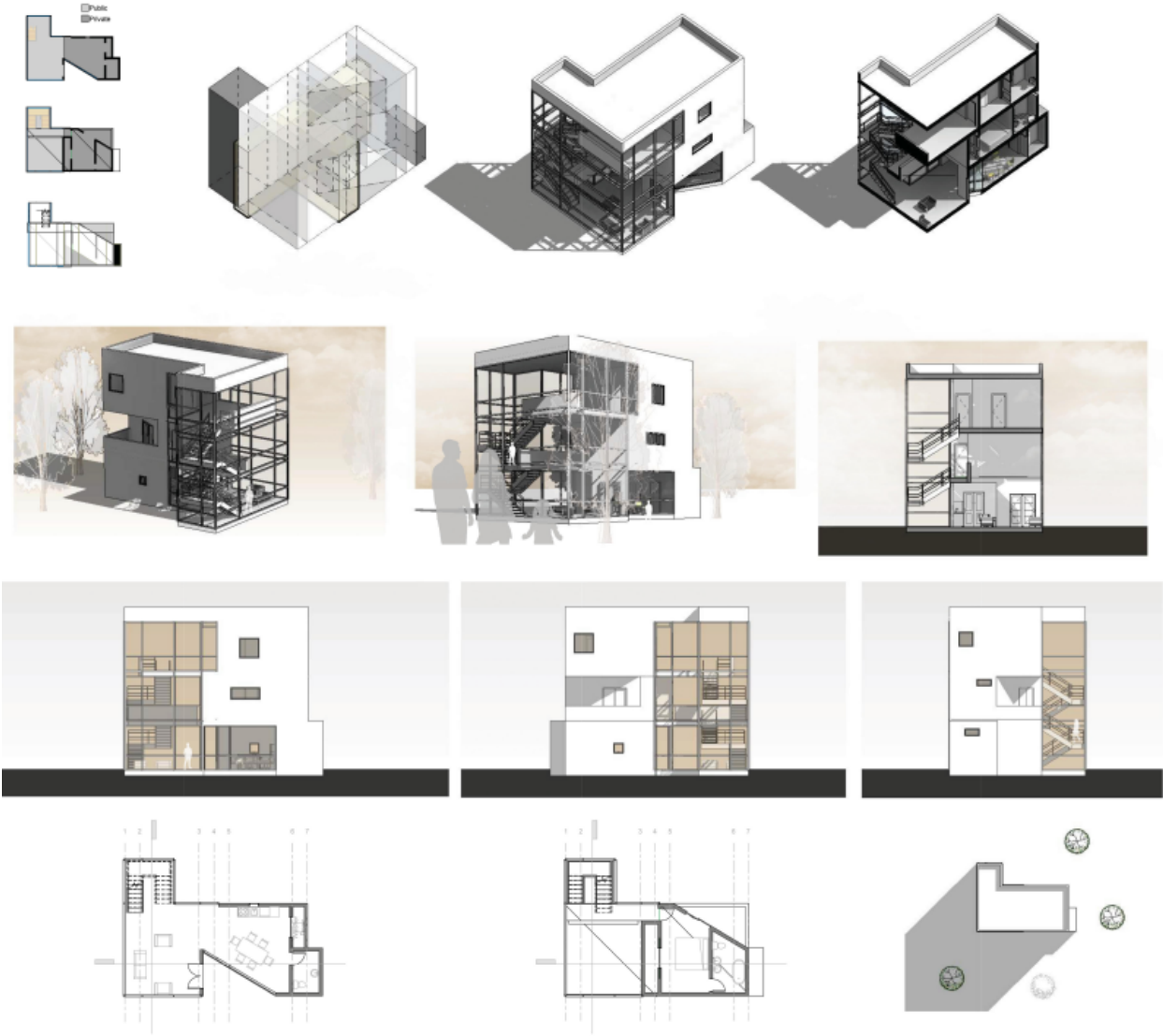
Public □ Private □



Theme 2: Houses that were based changing some of the principles in Meier's formal language.

HOUSE 1 PROJECT 3

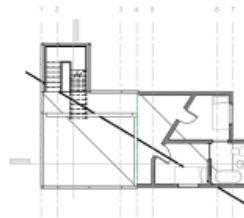
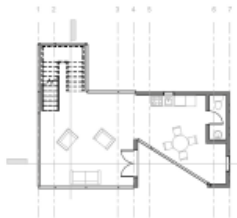
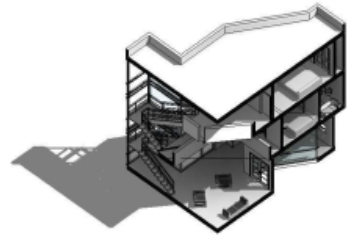
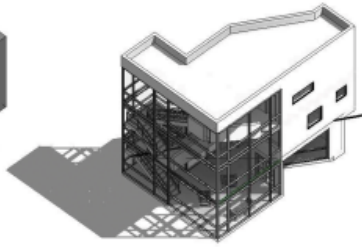
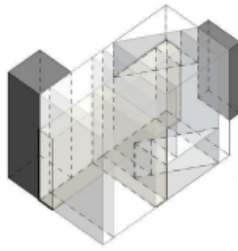
SJ004438



# HOUSE 2 PROJECT3

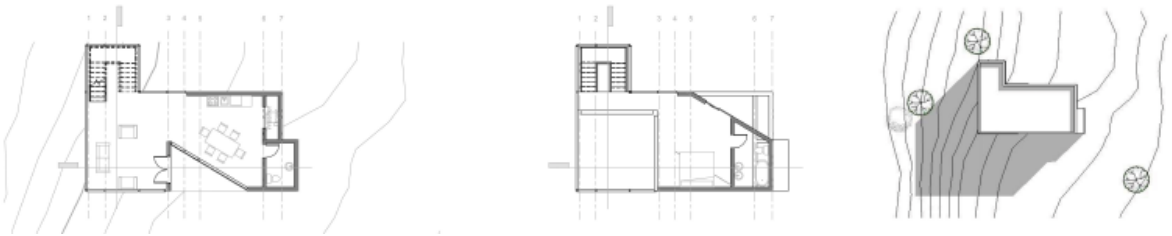
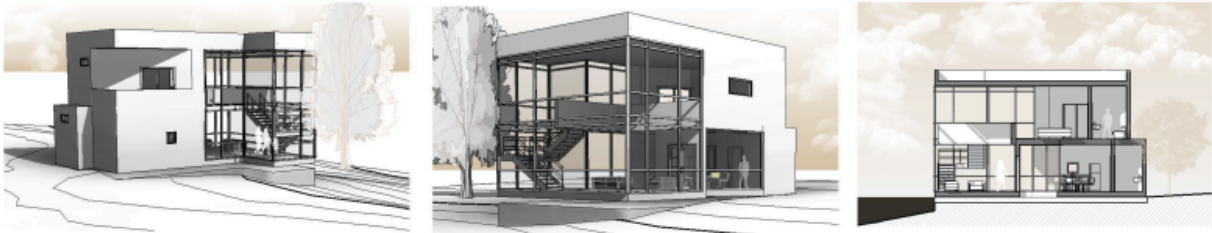
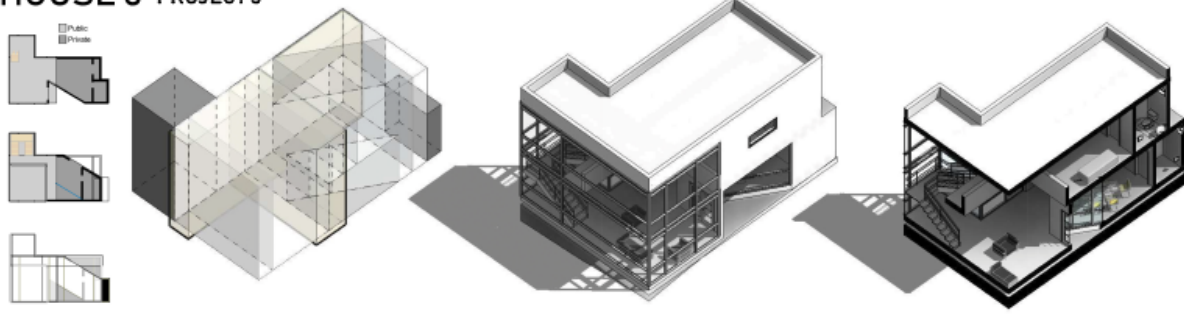
SJ004438

Private Public



# HOUSE 3 PROJECT 3

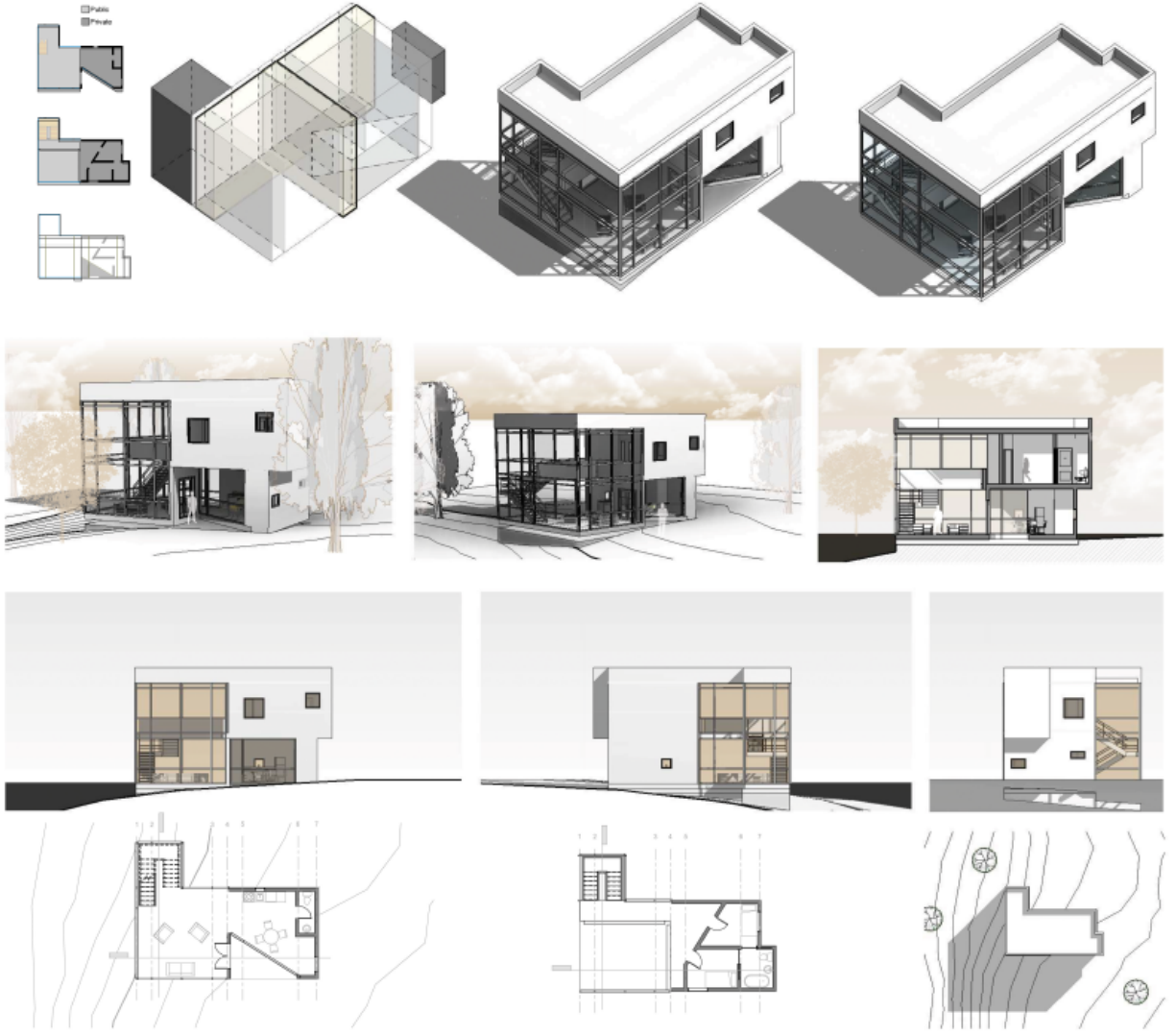
SJ004438





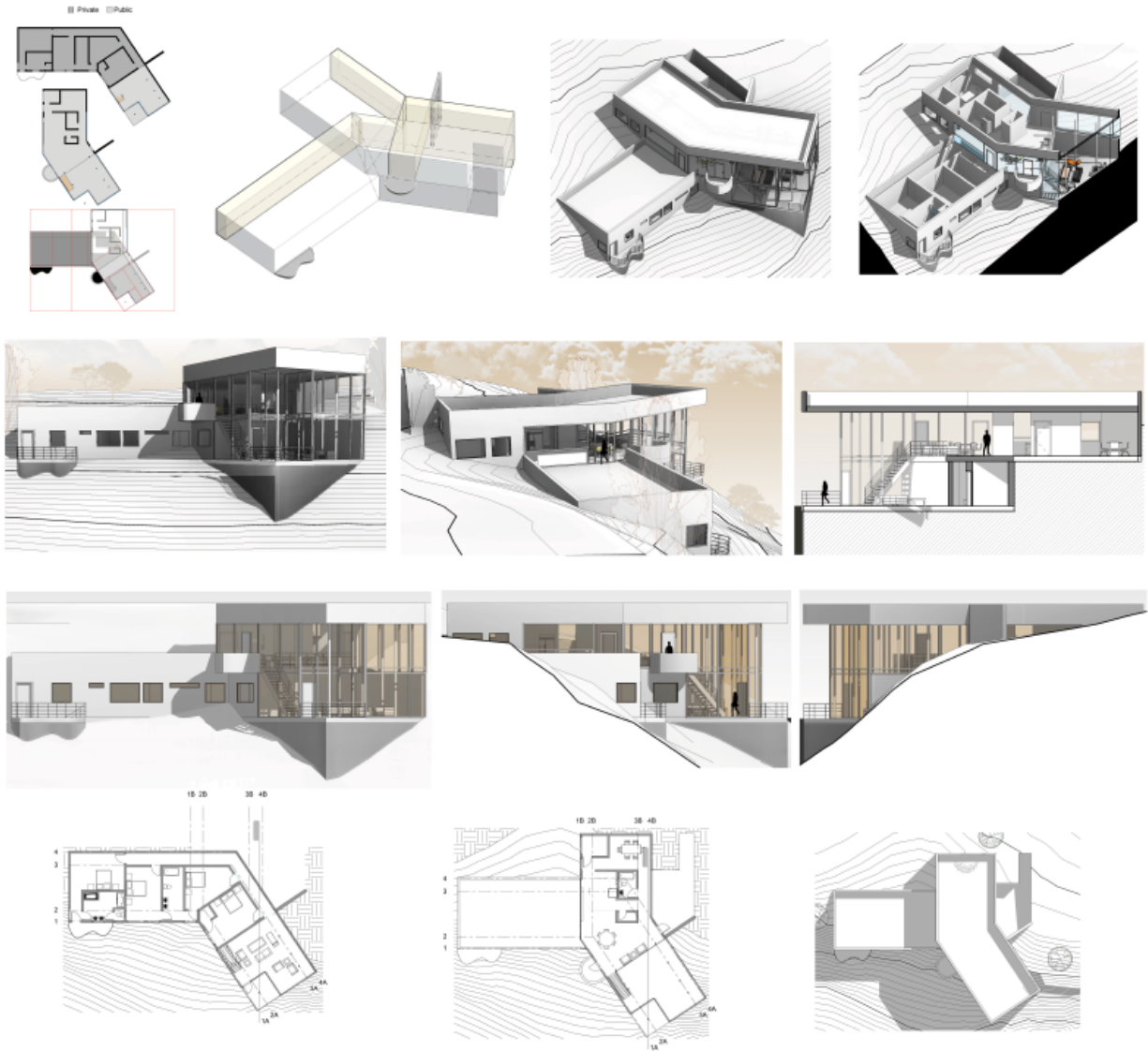
# HOUSE 4 PROJECT 3

SJ004438



# HOUSE 1 PROJECT 3

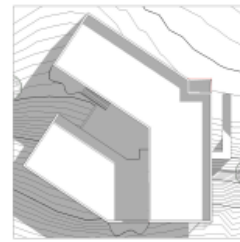
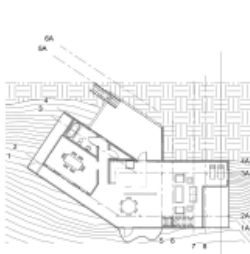
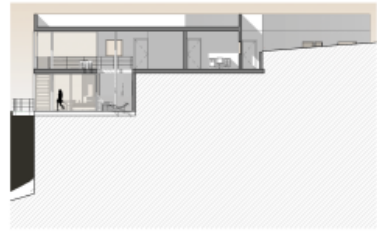
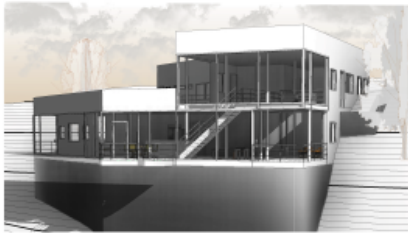
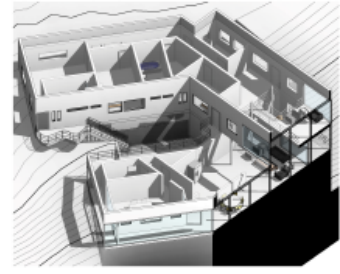
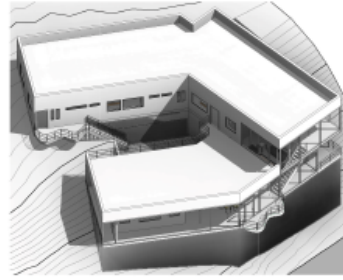
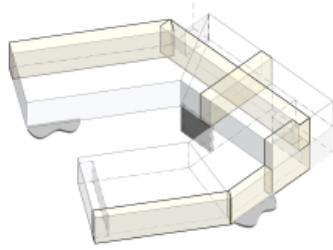
GN007513





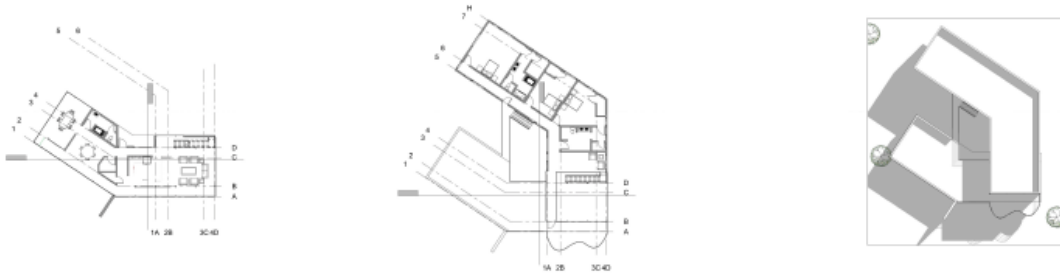
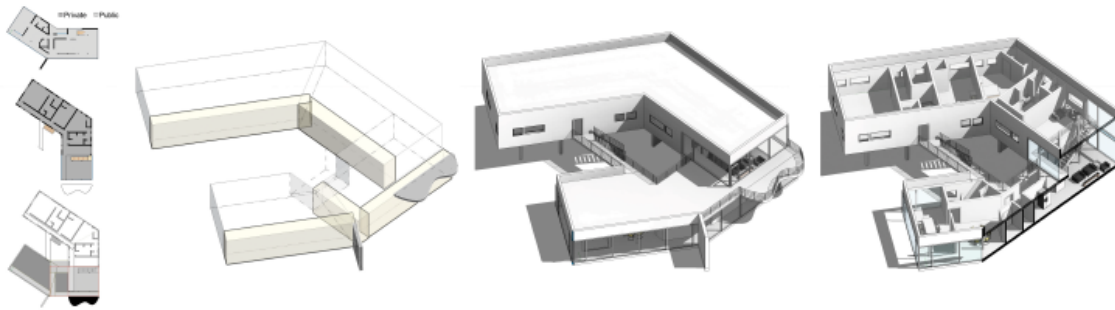
# HOUSE 2 PROJECT 3

GN007513

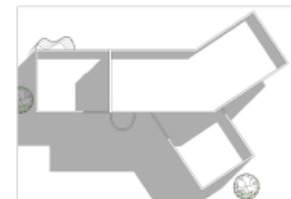
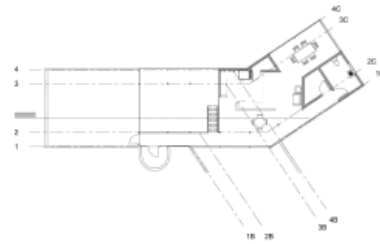
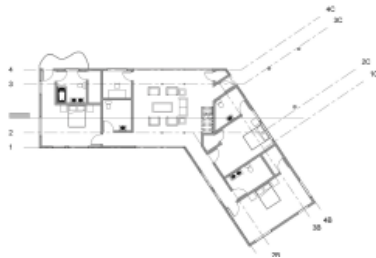
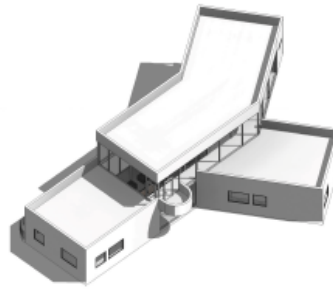
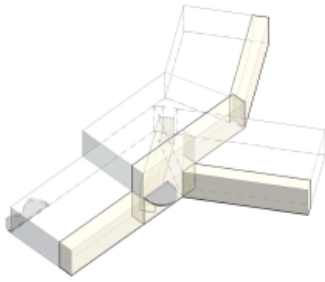


# HOUSE 3 PROJECT 3

GN007513



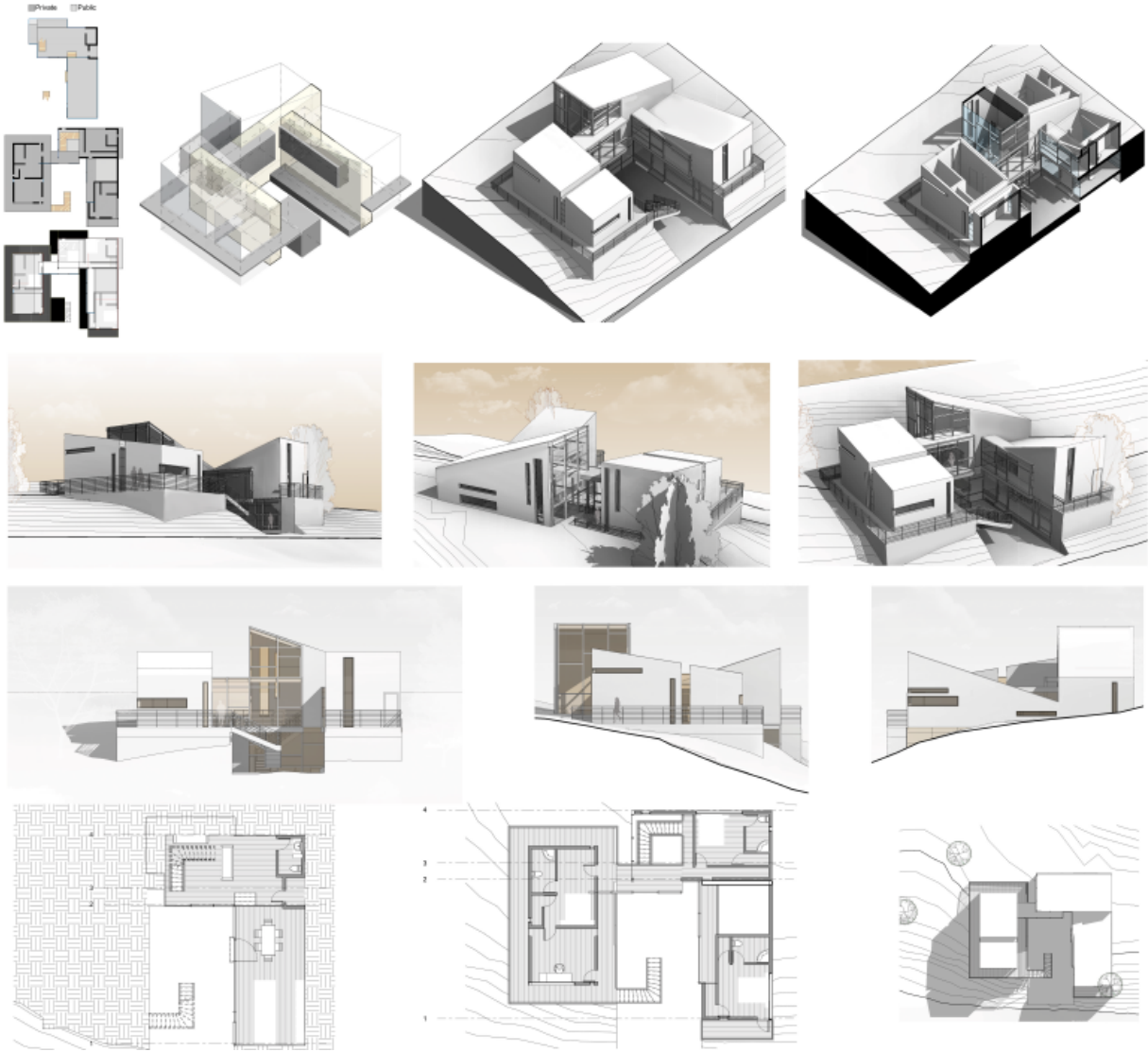
# HOUSE 4



Theme 3: Houses that explore formal concepts

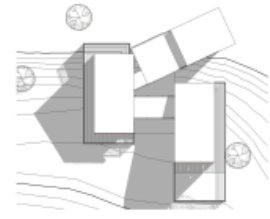
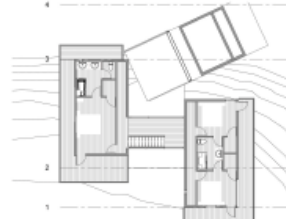
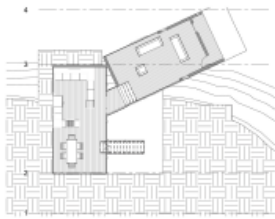
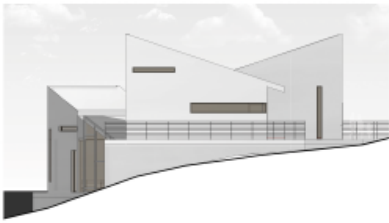
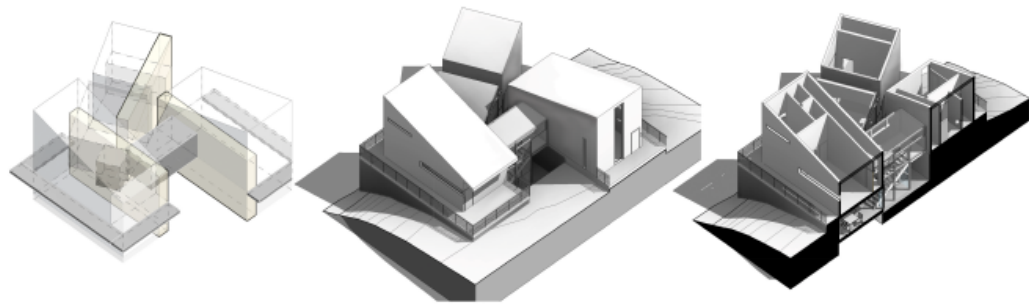
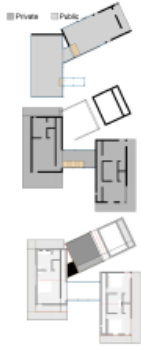
HOUSE 1 PROJECT 3

BJ006621



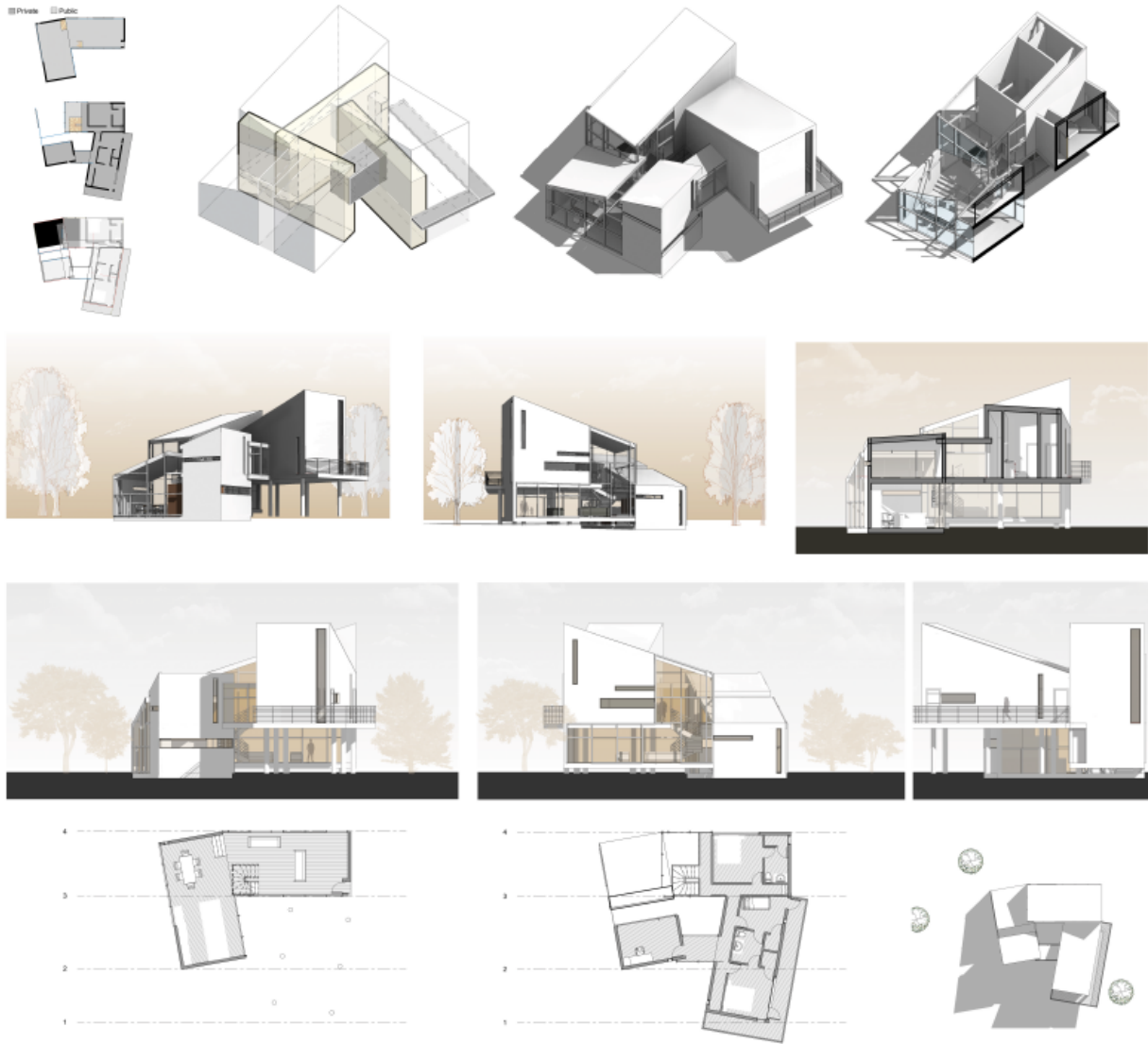
# HOUSE 2 PROJECT 3

BJ006621



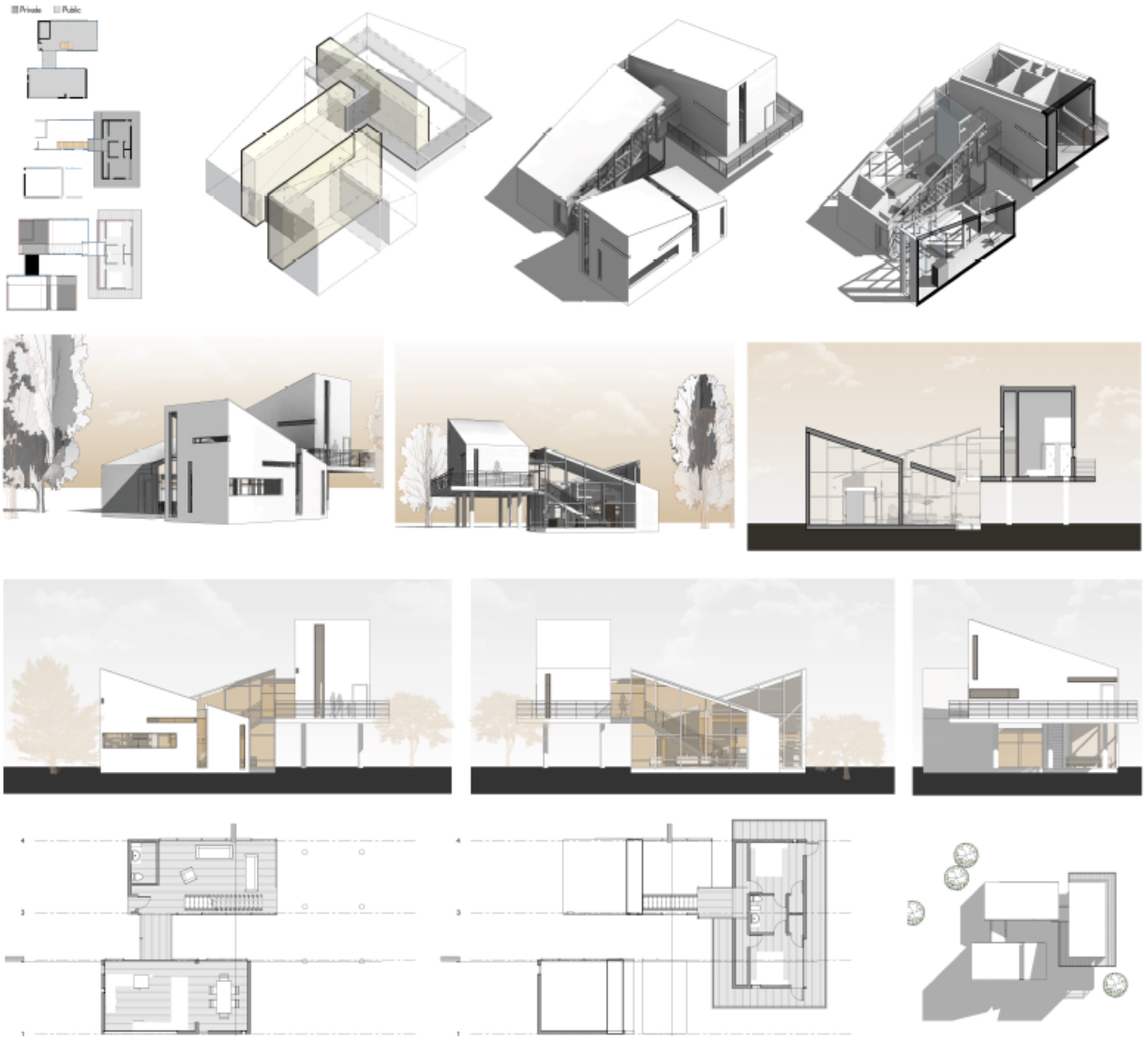
# HOUSE 3 PROJECT 3

BJ006621



# HOUSE 4 PROJECT 3

BJ006621

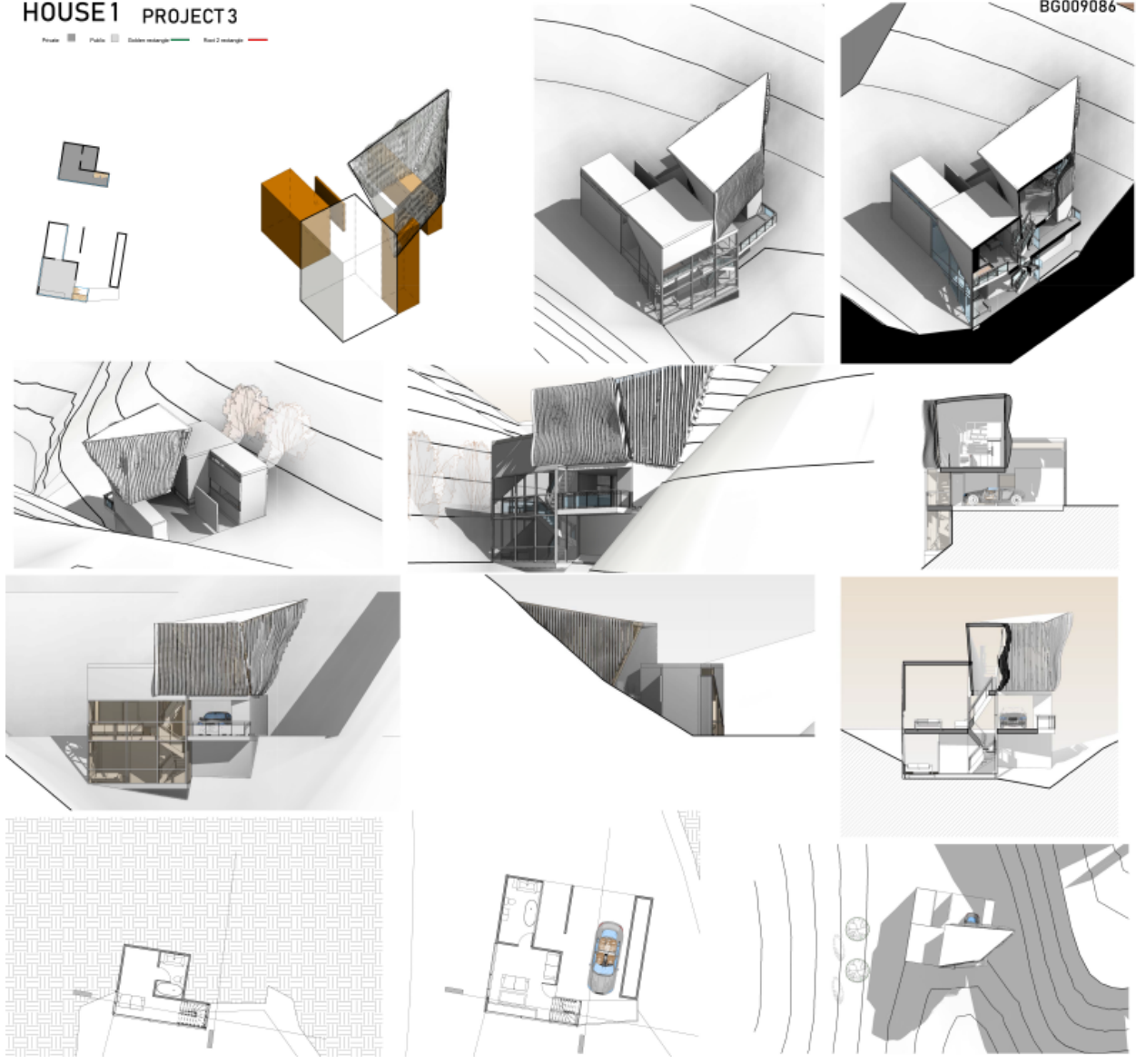




HOUSE1 PROJECT3

Private Public Outdoor coverage Road coverage

BG009086

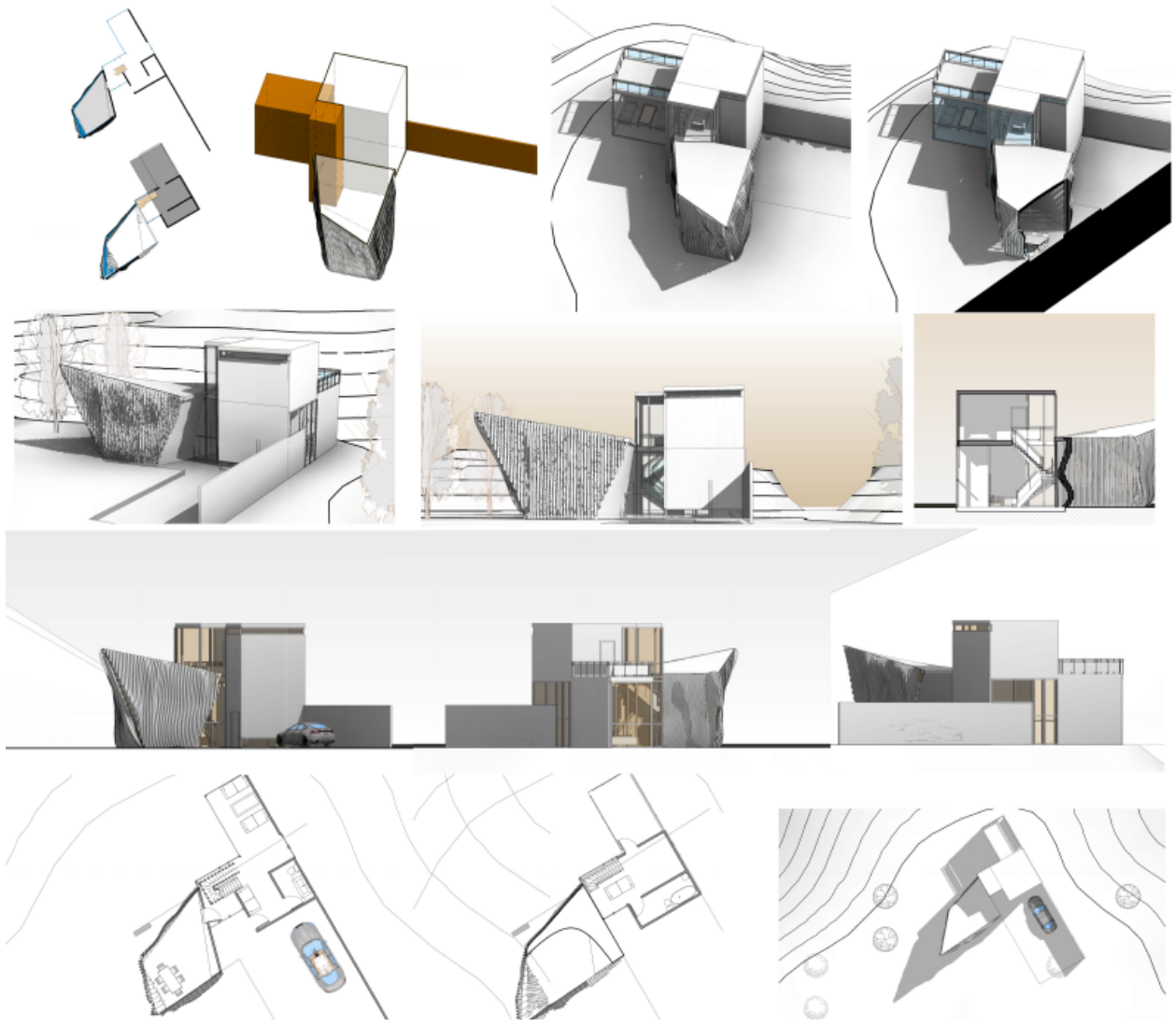




HOUSE 2 PROJECT 3

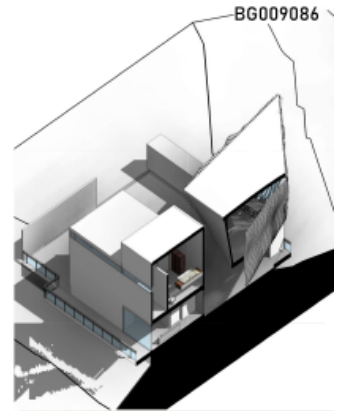
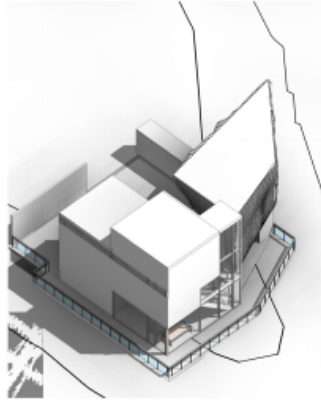
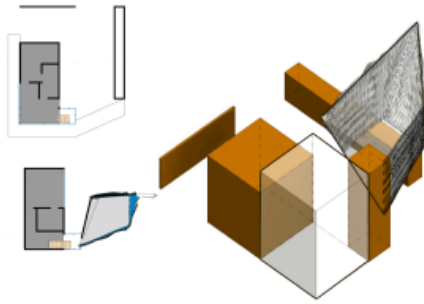
BG009086

Private Public Outdoor envelope Roof 2 envelope

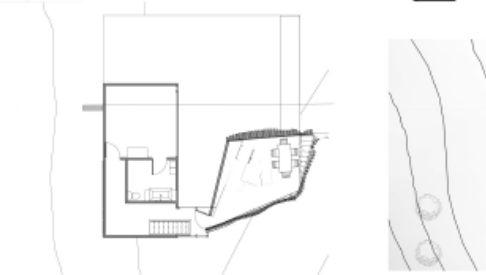
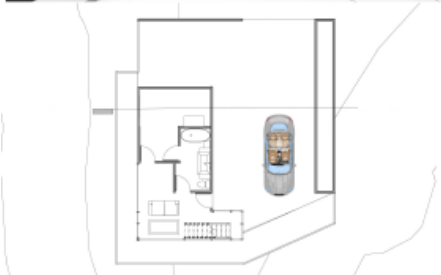
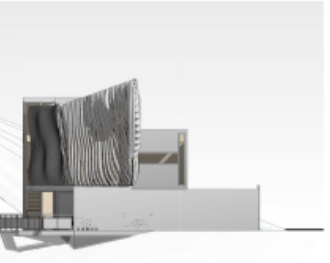
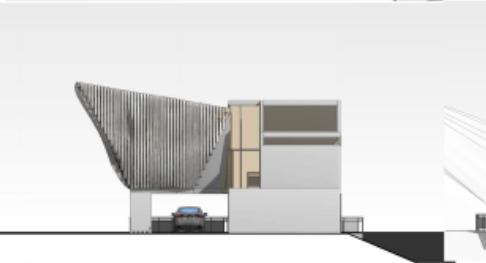


# HOUSE 3 PROJECT 3

Frame ■ Plank ■ Substructure ■ Roof Structure ■



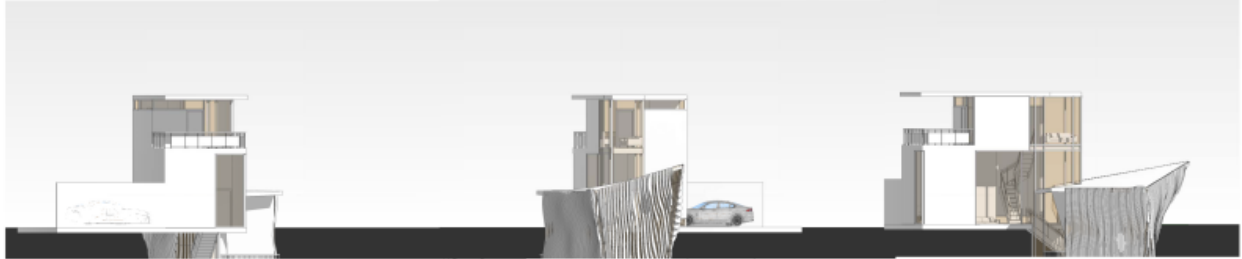
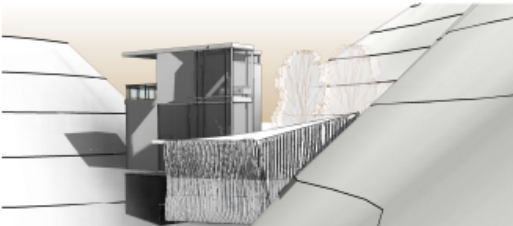
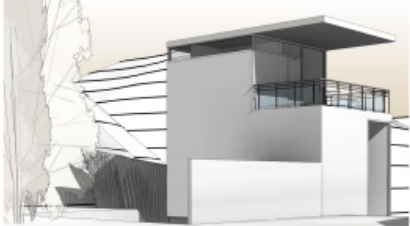
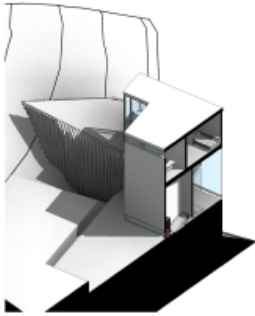
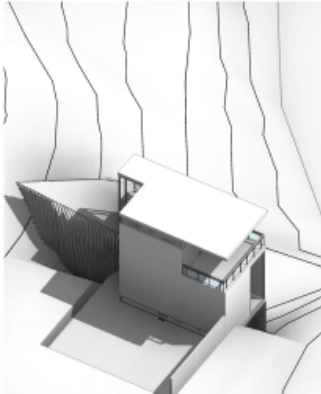
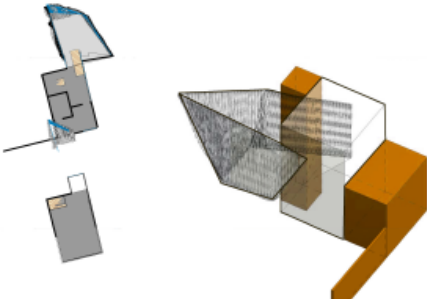
BG009086



HOUSE 4 PROJECT 3

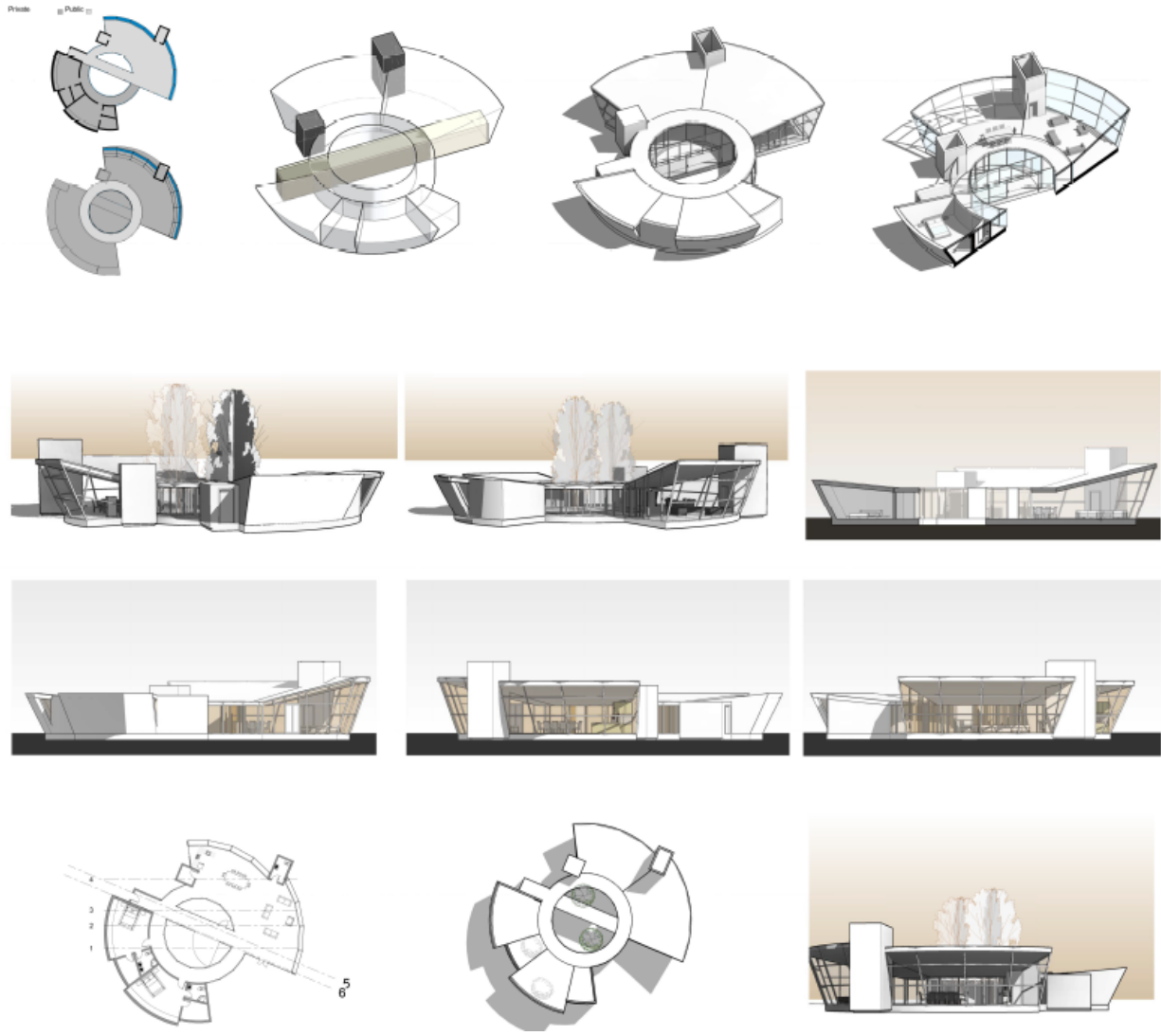
Private Public Stairs entrance East 2 entrance

BG009086



HOUSE1 PROJECT3

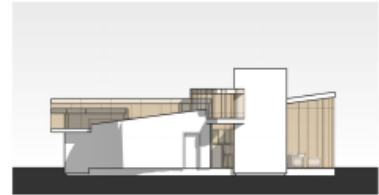
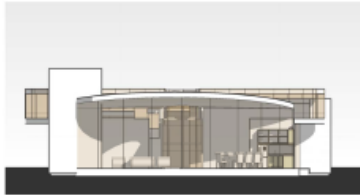
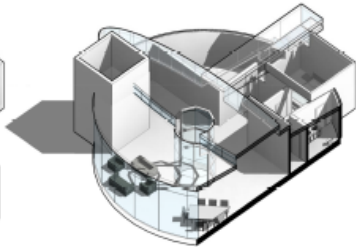
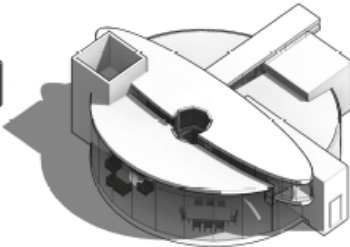
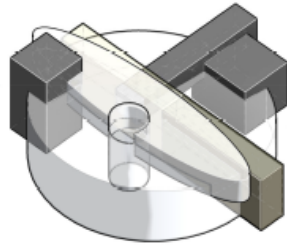
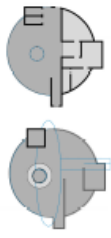
BP007683



HOUSE 2 PROJECT 3

BP007683

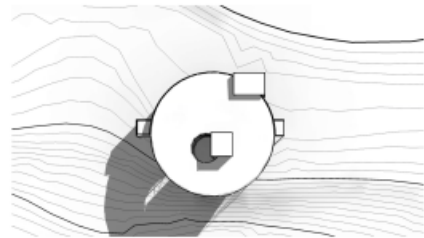
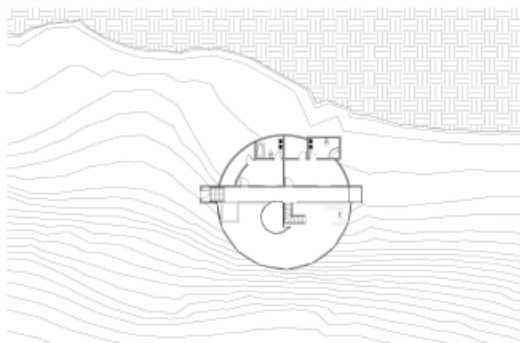
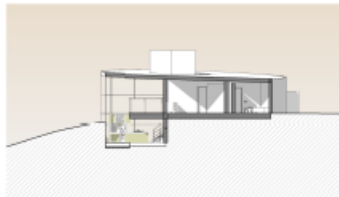
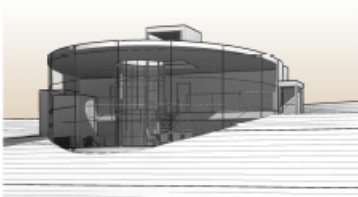
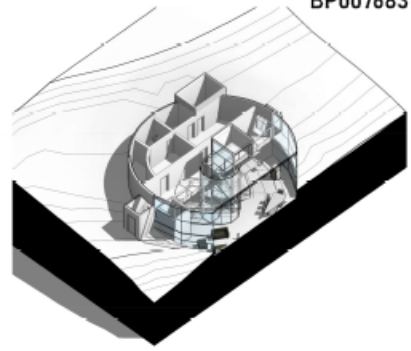
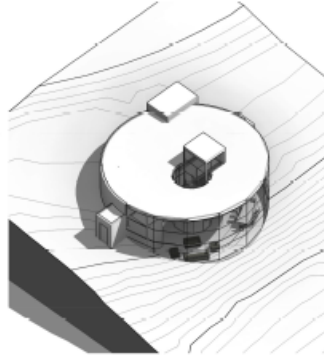
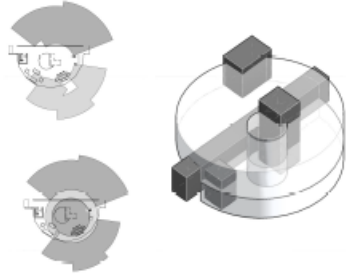
Private Public



# HOUSE 3

BP007683

FLOOR II FLOOR I



HOUSE 4 PROJECT 3

BP007683

Private Public

