

*Article*

## Greenhouse Gas Emissions from Ground Level Area Sources in Dairy and Cattle Feedyard Operations

Md Saidul Borhan \*, Sergio C. Capareda, Saqib Mukhtar, William B. Faulkner, Russell McGee and Calvin B. Parnell

Department of Biological and Agricultural Engineering, Texas A&M University, 2117 TAMU, College Station, TX 77843-2117, USA; E-Mails: scapareda@tamu.edu (S.C.C.); mukhtar@tamu.edu (S.M.); faulkner@tamu.edu (W.B.F.); romcgee@tamu.edu (R.M.); c-parnell@tamu.edu (C.B.P.)

\* Author to whom correspondence should be addressed; E-Mail: mborhan@tamu.edu; Tel.: +1-979-845-1286; Fax: +1-979-847-8828.

*Received: 13 March 2011; in revised form: 2 August 2011 / Accepted: 4 August 2011 /*

*Published: 9 August 2011*

---

**Abstract:** A protocol that consisted of an isolation flux chamber and a portable gas chromatograph was used to directly quantify greenhouse gas (GHG) emissions at a dairy and a feedyard operation in the Texas Panhandle. Field sampling campaigns were performed 5 consecutive days only during daylight hours from 9:00 am to 7:00 pm each day. The objective of this research was to quantify and compare GHG emission rates (ERs) from ground level area sources (GLAS) at dairy and cattle feedyard operations during the summer. A total of 74 air samples using flux chamber were collected from the barn (manure lane and bedding area), loafing pen, open lot, settling basin, lagoons, and compost pile within the dairy operation. For the cattle feedyard, a total of 87 air samples were collected from four corner pens of a large feedlot, runoff holding pond, and compost pile. Three primary GHGs (methane, carbon dioxide, and nitrous oxide) were measured and quantified from both operations. The aggregate estimated ERs for CH<sub>4</sub>, CO<sub>2</sub>, and N<sub>2</sub>O were 836, 5573, 3.4 g hd<sup>-1</sup> d<sup>-1</sup> (collectively 27.5 kg carbon dioxide equivalent (CO<sub>2</sub>e) hd<sup>-1</sup> d<sup>-1</sup>), respectively, at the dairy operation. The aggregate ERs for CH<sub>4</sub>, CO<sub>2</sub>, and N<sub>2</sub>O were 3.8, 1399, 0.68 g hd<sup>-1</sup> d<sup>-1</sup> (1.7 kg CO<sub>2</sub>e hd<sup>-1</sup> d<sup>-1</sup>), respectively, from the feedyard. The estimated USEPA GHG ERs were about 13.2 and 1.16 kg CO<sub>2</sub>e hd<sup>-1</sup> d<sup>-1</sup>, respectively, for dairy and feedyard operations. Aggregate CH<sub>4</sub>, CO<sub>2</sub> and N<sub>2</sub>O ERs at the dairy facility were about 219, 4 and 5 times higher, respectively, than those at the feedyard.

At the dairy, average CH<sub>4</sub> ERs estimated from the settling basin, primary and secondary lagoons were significantly higher than those from the other GLAS, contributing about 98% of the aggregate CH<sub>4</sub> emission. The runoff holding pond and pen surface of the feedyard contributed about 99% of the aggregate CH<sub>4</sub> emission. Average CO<sub>2</sub> and N<sub>2</sub>O ERs estimated from the pen surface area were significantly higher than those estimated from the compost pile and runoff pond. The pen surface alone contributed about 93% and 84% of the aggregate CO<sub>2</sub> and N<sub>2</sub>O emission, respectively. Abatement and management practices that address GHG emissions from these sources will likely be most effective for reducing facility emissions.

**Keywords:** methane; nitrous oxide; carbon dioxide; dairy; feedyard; free-stall; emission rates

---

## 1. Introduction

Concentrated animal feeding operations (CAFOs) contribute a considerable amount of GHGs to the atmosphere. The US Environmental Protection Agency (USEPA) has begun to regulate greenhouse gases (GHGs) emitted by the stationary sources, including manure management from CAFOs [1]. Therefore, it is important to obtain accurate estimates of GHG emissions from various ground level area sources (GLASs) at CAFOs to improve emission inventories and to devise source-specific abatement strategies. It is well recognized that ruminant livestock operations, especially dairy cows, beef cattle, and sheep, contribute to the production of GHGs.

The primary GHGs produced by agricultural sources are methane (CH<sub>4</sub>), nitrous oxide (N<sub>2</sub>O), and carbon dioxide (CO<sub>2</sub>). These gases are believed to play a major role in the global warming of Earth's climate [2]. Greenhouse gas emissions from livestock vary by animal type and growth stage due to different diets, feed conversion mechanisms, and the manure management [3]. Methane is produced by the microbes in the rumen of ruminant animals due to enteric fermentation, from freshly deposited manure due to bacterial processes, and from storage lagoons and settling basins due to anaerobic degradation [4–6]. Methane, with a global warming potential (GWP) of 25, can affect climate directly through its interaction with long-wave infrared energy and indirectly through atmospheric oxidation reactions. Global warming potential is used as a relative index to standardize emissions of GHGs for comparing how effectively each gas traps heat in the atmosphere [7]. Methane is second in rank to CO<sub>2</sub> in importance and contributes around 18% of the greenhouse effect [7]. At CAFOs, CO<sub>2</sub> is released from the use of fertilizers in crop/pasture production, fossil fuel use to run farm machinery (tractors, loaders, and irrigation pumps) and feed processing operations, the loss of forest for crop production, and carbon loss from the soil for feed production [8]. However, CO<sub>2</sub> and enteric CH<sub>4</sub> emissions from CAFOs are not currently regulated.

Nitrous oxide (N<sub>2</sub>O) is a GHG that contributes to stratospheric ozone depletion and is 310 times more potent as a GHG than CO<sub>2</sub>. Nitrous oxide is produced in soils through microbial processes of nitrification and denitrification [4] and is released from manure and urine excreta [4,9], from fertilizer and manure slurry applied for crop/pasture production and aerobic and anaerobic degradation of

livestock manure/waste in the lagoons and dry manure pile [9,10]. Chadwick *et al.* [3] also reported that immediate emissions of N<sub>2</sub>O from the beef manure was likely due to rapid nitrification of ammonium or denitrification of nitrate already in the beef manure. Land application is considered the main source of agricultural N<sub>2</sub>O since fertilizer and manure applications significantly increase microbial production of N<sub>2</sub>O from soils [11]. The agricultural sector is reported to be the greatest contributor of N<sub>2</sub>O and the third greatest contributor of CH<sub>4</sub> in the U.S. [7,12]. Therefore, appropriate strategies must be developed for reducing or minimizing net GHG emissions.

### 1.1. Greenhouse Gas Inventory

During the last two hundred and fifty years, human activities, including demanding agricultural production, have increased the global atmospheric concentration of greenhouse gases, namely CO<sub>2</sub>, CH<sub>4</sub>, and N<sub>2</sub>O by 36, 148, and 18%, respectively [2]. Total greenhouse gas (GHG) emissions in the US increased by 14.7% from 1990 to 2006. All agricultural sources combined were estimated to have generated 454 Tg (10<sup>12</sup> g) of CO<sub>2</sub> equivalents in the U.S. during 2006 [13]. The CH<sub>4</sub> emissions from enteric fermentation and manure management represent about 25 and 8% of the total CH<sub>4</sub> emissions from anthropogenic activities. The USEPA *Inventory of U.S. Greenhouse Gas Emissions and Sinks* identified manure management as generating 24 and 5% of CH<sub>4</sub> and N<sub>2</sub>O emissions, respectively, from agricultural sources [12,13].

A review of published literature identified reports of CH<sub>4</sub>, CO<sub>2</sub> and N<sub>2</sub>O emissions data from free-stall and naturally ventilated dairy operations [7,13,14]. Based on a review using limited data, emissions of CO<sub>2</sub> from the dairy slurry manure storage facilities averaged 72 kg CO<sub>2</sub> m<sup>-3</sup> yr<sup>-1</sup> (data ranged from 8.6 to 117 kg CO<sub>2</sub> m<sup>-3</sup> yr<sup>-1</sup>) [7,15,16]. Emissions of CO<sub>2</sub> from dairy housing averaged 1989 kg CO<sub>2</sub> hd<sup>-1</sup> yr<sup>-1</sup> (data ranged from 1697 to 2281 kg CO<sub>2</sub> hd<sup>-1</sup> yr<sup>-1</sup>, where hd<sup>-1</sup> is per head) [16]. Kinsman *et al.* [17] reported that the mean daily CH<sub>4</sub> emission per dairy cow (602 kg mean bodyweight) in a tie-stall barn ranged from 373 to 617 g CH<sub>4</sub> AU<sup>-1</sup> d<sup>-1</sup> (436 to 721 L), while the mean daily CO<sub>2</sub> emission per cow ranged from 11,900 to 17,500 g CO<sub>2</sub> AU<sup>-1</sup> d<sup>-1</sup> (5032 to 7427 L). In a study by Amon *et al.* [18], CH<sub>4</sub> and N<sub>2</sub>O emissions per livestock unit (LU = 600 kg of body weight) or animal unit (AU = 500 kg of body weight) from tie stalls for dairy cows were measured several times in the course of a year. Average emissions were 619.2 mg N<sub>2</sub>O LU<sup>-1</sup> d<sup>-1</sup> (516 mg N<sub>2</sub>O AU<sup>-1</sup> d<sup>-1</sup>), and 194.4 g CH<sub>4</sub> LU<sup>-1</sup> d<sup>-1</sup> (162 g CH<sub>4</sub> AU<sup>-1</sup> d<sup>-1</sup>). Emissions of CH<sub>4</sub> and N<sub>2</sub>O from animal housing averaged 54 (1.0–100) kg CH<sub>4</sub> hd<sup>-1</sup> yr<sup>-1</sup> and 0.3 (0.0–0.6) kg N<sub>2</sub>O hd<sup>-1</sup> yr<sup>-1</sup>, respectively [16,18]. Ngwabie *et al.* [14] reported CH<sub>4</sub> emissions ranging from 25 to 312 g hd<sup>-1</sup> d<sup>-1</sup> (9 to 114 kg hd<sup>-1</sup> yr<sup>-1</sup>) in a naturally ventilated dairy barn.

Most of the published literature reporting CH<sub>4</sub> emissions from feedlot manure system used atmospheric dispersion modeling (inverse dispersion, backward lagrangian stochastic model, IPCC tiers I and II algorithm, and Blaxter and Clapperton algorithm) to estimate emissions from whole farm [19–21]. Zoe *et al.* [19] estimated summer CH<sub>4</sub> ER data for two Australian feedyards using an open-path tunable near infrared diode laser and backward lagrangian stochastic model of atmospheric dispersion. Methane ERs reported were 146 and 166 g hd<sup>-1</sup> d<sup>-1</sup> for Victoria and Queensland, respectively. Using the same techniques, the average CH<sub>4</sub> emissions were 166 and 214 g CH<sub>4</sub> hd<sup>-1</sup> d<sup>-1</sup> for feedlots in Queensland and Alberta, respectively [20]. Average daily CH<sub>4</sub> emissions were estimated

to be  $323 \text{ g hd}^{-1} \text{ d}^{-1}$  for a large beef feedlot in western Canada using inverse dispersion model [21]. Phetteplace *et al.* [22] determined GHG emissions from simulated beef and dairy livestock systems in the United States using a computer spreadsheet program. The methane  $\text{N}_2\text{O}$ , and  $\text{CO}_2$  ERs reported were 1.56, 11.4 and  $3411 \text{ g hd}^{-1} \text{ d}^{-1}$  from manure management systems of a feedlot. Direct measurements using micrometeorological mass difference technique reported  $70 \text{ g CH}_4 \text{ hd}^{-1} \text{ d}^{-1}$  emissions from a confined beef feedyard in Australia where animals were fed a highly digestible high grain diet [23]. However, limited published information quantifying GHG emissions from ground level area sources (GLASs) in U.S. dairy and feedyard production systems were found in the literature.

### 1.2. Greenhouse Gas Measurement

Gas chromatography is recognized to be a highly accurate, precise, and reference method for measuring GHGs compared to other methods [24]. In this study, a protocol (similar to EPA Method TO-14A) that consisted of isolation flux chamber method and a portable gas chromatograph was used to quantify GHG emissions directly from GLASs at a dairy and a feedyard. All components essential to Method TO-14A sample analysis (*i.e.*, GC and GC detectors) are included except that the GC was taken to the field to analyze samples on site rather than storing them in gas canisters and analyzing them in a laboratory. The objectives of this research were to: (1) determine GHG concentrations from various GLASs at a free-stall dairy and a feedyard operation; (2) estimate and compare the ERs of  $\text{CH}_4$ ,  $\text{CO}_2$ , and  $\text{N}_2\text{O}$  from various GLASs at those two operations; and (3) identify areas in those two facilities that have the largest contribution to facility-wide GHG emissions.

## 2. Materials and Methods

### 2.1. Site Description

#### 2.1.1. Free-Stall Dairy

This study was conducted at a free-stall dairy operation in the Texas Panhandle (Figure 1). This dairy had three naturally ventilated free-stall barns with open sides and ends and housed a total of 3200 milking cows. The open-lots at this free-stall dairy were allocated for heifers and dry cows and were provided with feeding and watering systems. The open-lots contained about 3750 heifers and the surface was mostly dry with portions containing scattered feed, feces, and urine. No air sample from an open-lot pen with dry cows was collected and dry cows were not used to calculate emissions rates. Manure accumulated in the open-lot was removed by tractor mounted scraper twice a week and cleaned the open-lots twice a year. The scraped manure was stockpiled and either applied in the crop fields or pastures or composted on-site. The runoff from the open-lot during a rain event was channeled to a runoff pond that was separate from the treatment lagoon.

Manure that accumulated in the free-stall barns was flushed every two hours from storage tanks that were recycled wastewater from the secondary lagoon. The flushed liquid manure then channeled to the gravity settling basin where most of the solids were separated. The separated liquid goes to an inclined screen mechanical solid separator for further separating liquid and solids. Screened solids were composted in windrows and used as bedding for loafing pens. The liquid manure from the mechanical

separator was channeled to the primary anaerobic lagoon. Then, effluent from the primary lagoon was conveyed to secondary lagoon through a pipe outlet. Air sampling using flux chamber was performed for five consecutive days during daylight hours (9:00 am to 7:00 pm) and concentration values reported for that period. These are the snapshot data of 5 consecutive days in summer, representing typical summer climate of the region. However, concentration values beyond this period might be different. Four measurements were taken 1 h after flushing and another 4 measurements were taken just before the next flush. A total of 74 samples were collected from the barn (manure lane and bedding area), loafing pens, open-lot, the settling basin, lagoons, and compost piles within the dairy operation (Table 2). Measurements were taken randomly at 8–14 locations in each GLAS. Seventy four chromatograms (visible records in a graph) showing the result of separation of the GHGs of an air mixture were collected during a week-long sampling campaign in summer from this dairy

**Figure 1.** Aerial photograph of the dairy facility located at the Texas Panhandle. The sampling sites are marked with an “X”. (Photo from Google Maps).

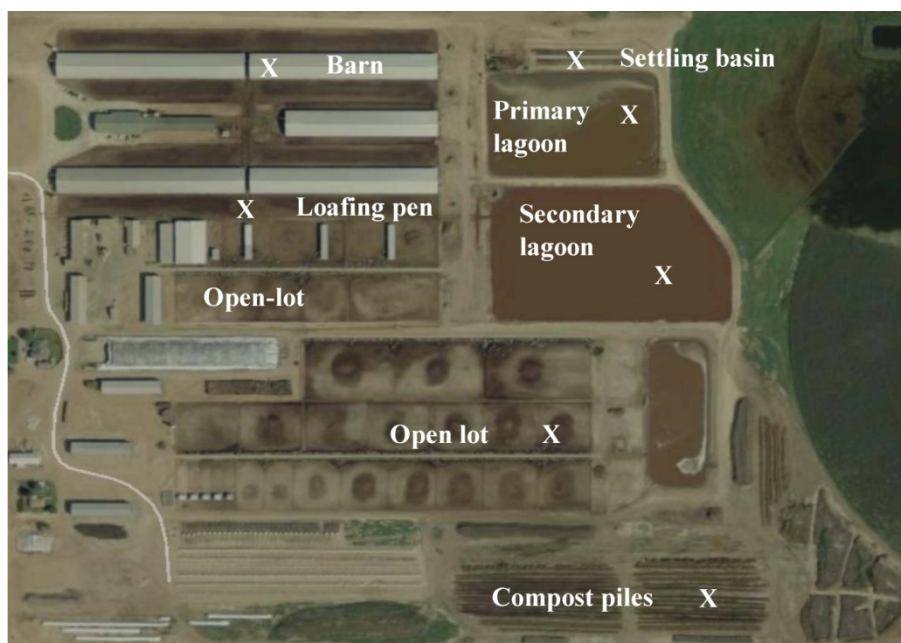

### 2.1.2. Feedyard

At the feedyard, air samples were collected for five consecutive days during daylight hours (9:00 am to 7:00 pm) in August 2010. The feedyard fed approximately 40,000 head of cattle in the growth and finishing stages of beef production. Four corner pens of the feedlot were selected as sampling locations (Figure 2). Before sampling was initiated, an imaginary  $6 \times 6$  grid was made for each pen/GLAS and each cell was assigned a grid location. The numbers selected corresponded to the cell where the flux chamber was to be placed. Air samples were collected randomly at 8–20 locations in each GLAS corresponding to the total number of grid cells (e.g., 1 to 36 for a  $6 \times 6$  grid). The size of the entire pen surface, compost pile, and runoff pond were 910,000; 49,000; and 59,000  $\text{m}^2$ , respectively (calculated from the Google map). The feedlot pen surface was mostly dry with portions containing scattered feed, feces, and urine. The manure solids on feedyard pens are scraped after each growing cycle and the manure is hauled to the compost area. The surface runoff of the feedlot pen surface was channeled to

the runoff pond. Later, wastewater from the runoff pond piped or pumped to the runoff holding pond. A total of 87 air samples were collected from four corner pens of a large feedlot, runoff holding pond, and compost pile.

**Figure 2.** Aerial photograph of the beef cattle feedyard located at the Texas Panhandle. The sampling sites are marked with an “X”. (Photo from Google Maps).



### 2.1.3. Beef and Dairy Cattle Ration

Detailed ration information was not available due to proprietary concerns. According to data supplied by the dairy, the diets for milking cows were mainly comprised of forage (wheat hay, wheat silage, alfalfa hay, alfalfa hay chop, and corn silage), grain (broken corn, corn rolled, corn pericarp, and cotton seed), protein (cotton seed meal, beet pulp, canola, and dried distillers grain), vitamin (A & D), and water. The ration constituted about 43.2, 32.9, 2.3, 18.0, and 3.6% of these constituents on an as fed basis, respectively. Similarly, heifers in open-lots were fed 93.6% forage, 2.3% grain, 3.7% protein, and 0.44% mineral on an as fed basis. On the other hand, forage (corn silage), grain (steam flaked corn), protein (wet distillers corn and condensed corn distillers), fat, beef finisher, and trace elements (rumensin, tylan, vitamin A & D) were 19, 57.2, 20.1, 0.8, 2.1, 0.8% on an as fed basis, respectively, for the feedyard. The dairy cattle ration contained 24.2% (on an as fed basis) more forage and 24.3% less grain than the feedlot ration. The protein contents were similar for both milking cows and feedyard rations. Dairy and feedyard animals were fed a mixed ration twice daily at around 7:00 and 14:00 h. In Texas, average weight of cow/heifers, dairy-milk cows, and finishing beef were 454, 590, and 546 kg, respectively [25].

### 2.2. Sampling Protocol (Isolation Flux Chamber, Flux Generation, and Air Sampling)

There is debate about the appropriateness of flux chambers for quantifying pollutant emissions at concentrated animal feeding operations (CAFOs) and other area sources due to the creation of

microenvironments in the chamber and the small measurement footprint relative to the size of the source. In this research, we have used an isolation flux chamber and followed a standard EPA method [26] to estimate greenhouse gas emissions from ground level area sources related to manure management at dairy cattle feedyard facilities.

The GHG sampling train consisted of a GC, flux chamber, and associated air sampling accessories (tubing, mass flow controllers, vacuum pump, gas cylinder, *etc.*). Figure 3 shows the dynamic flux chamber with sampling line and the GC system housed in an air-conditioned mobile trailer. The flux chamber was used to collect air samples from each GLAS (Figure 4). The upper (hemispherical dome) portion of the flux chamber used in the field was made of plexiglas, while the bottom (cylindrical skirt) was made of stainless steel. The two portions were flanged together by 6.35 mm (1/4 in.) steel bolts. The footprint area of the flux chamber was 0.192 m<sup>2</sup>. The flux chamber was placed at a random location within each sampled GLAS. Before sampling was initiated, the flux chamber was purged with air (zero-grade air) at a flow rate of 5 L min<sup>-1</sup> for thirty minutes. The compressed zero-grade air had O<sub>2</sub> content between 19.5 and 23.5% and total hydrocarbon (THC) concentrations below 0.2 ppb<sub>v</sub>. Teflon tubing (0.635 cm i.d.) was used to convey 5 L min<sup>-1</sup> zero-grade air (“sweep air”) to the flux chamber. The sweep air is a certified GHG free zero grade air from Praxair (Praxair, Inc). Three holes on the top of the chamber (Figure 4) allowed air to escape while a fourth hole at the apex of the dome was used to convey sample air into another 45 m long Teflon tube identical to that used to convey sweep air. Sweep air entered the flux chamber through one of the holes in the dome of the chamber. The Teflon tube connected at the apex of the chamber conveyed air sampled at a rate of 2 L min<sup>-1</sup> from the flux chamber to the GC over a 5 min sampling period by a positive displacement pump. The volume of air samples drawn from the flux chamber was regulated by mass flow controllers connected to the pump. Both Teflon tubes were contained in a hard PVC pipe to protect them from animals and sun exposure (Figure 3). Of the 2 L min<sup>-1</sup> of air drawn from the flux chamber, 200 mL min<sup>-1</sup> was directed to the 1 mL sample loop of the GHG GC for 30 s to ensure the sample loop was always full. Thus, excess air was purged out of the GC while the sample loop with air was ready to be injected to the GC.

**Figure 3.** Portable instrument system housed in a mobile trailer showing isolation flux chamber and sampling line.

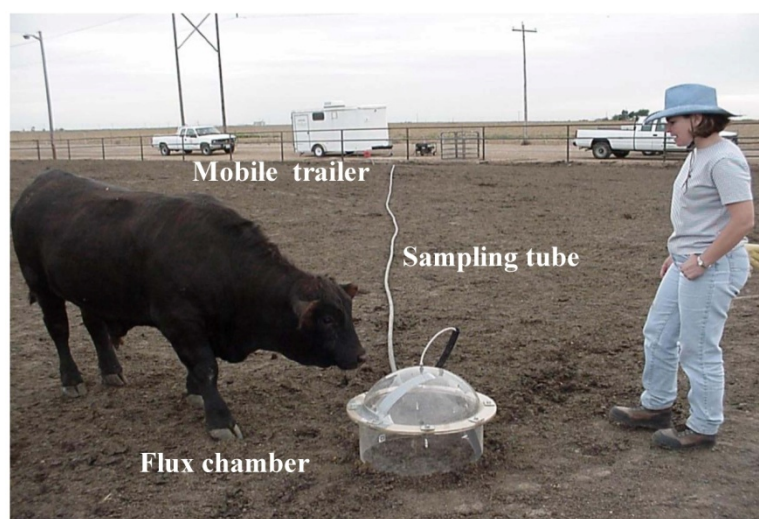

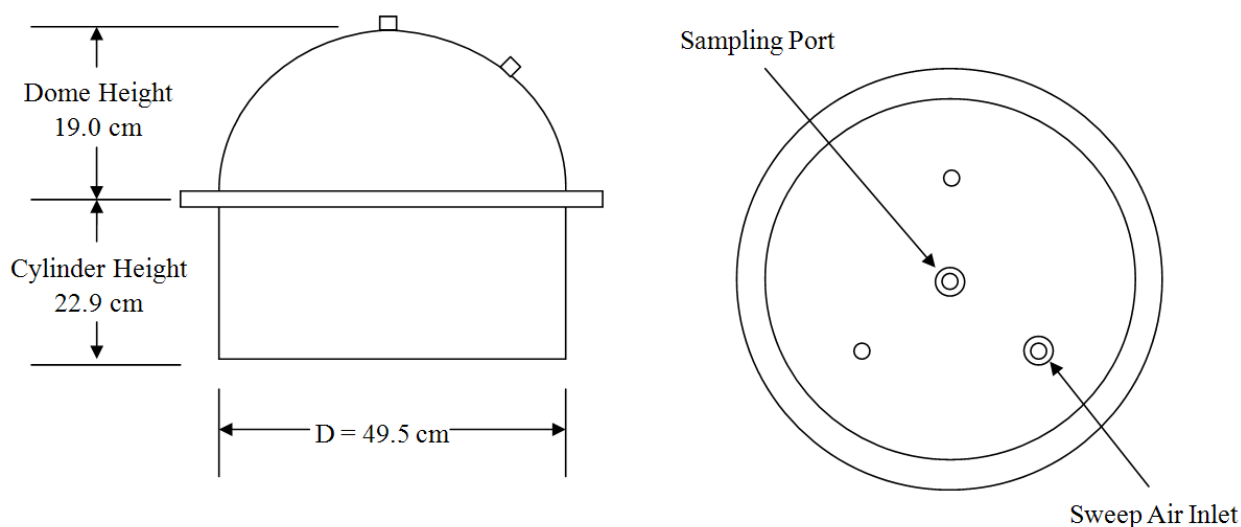
**Figure 4.** Diagram and dimension of the Flux Chamber used for air sampling.

A portable GHG GC (Model No. 8610C, SRI Instruments, Torrance, CA, USA) with event programming capabilities was used in this study. The event programmer controlled the duration of sampling by timing the vacuum pump operation, time to inject sampled air into column, and setting of column temperature. This GC has a 10-port valve coupled with a 1ml sample loop. A built-in vacuum pump was used to keep the sample loop filled with sample air at all times and inject it into the GC column in a consistent manner when desired. A combination of two non-specific detectors flame ionization detector (FID) and electron capture detector (ECD) was used to analyze GHG concentrations sampled directly from the GLAS. The ECD detects  $N_2O$  while the FID/Methanizer detects  $CH_4$  and  $CO_2$ . The system was operated using nitrogen as the carrier gas at 20 psi, which generated a flow rate of  $250 \text{ mL min}^{-1}$ . Hydrogen and air were supplied to the FID/Methanizer using a built-in air compressor and an external hydrogen generator (Model: PH200-600, Peak Scientific Instrument, Scotland, UK). The temperatures for FID and ECD were set at  $300 \text{ }^\circ\text{C}$  and  $350 \text{ }^\circ\text{C}$ , respectively. The GC column temperature was programmed to maintain a temperature of  $60 \text{ }^\circ\text{C}$  for 15 min. Compound peaks were recorded and analyzed with PeakSimple Chromatography Data System Software (Ver. 3.72; SRI Instruments, Torrance, CA, USA). Blank samples were run before air sampling began at each location (GLAS) to ensure that the column was clean and functioning properly.

### 2.3. Compound Quantification, Calibration, Minimum Detection Limit, and Percent Recovery

Quantification of compounds collected during field sampling was performed using certified calibration standard greenhouse gases ( $CH_4$ ,  $CO_2$ , and  $N_2O$ ), and GHG identification was confirmed by matching retention times. To ensure the accurate calculation of concentrations were made during field sampling tests, gas standards were introduced into the portable GC following the same field sampling protocol. To generate calibration equations (standard curves), four concentration levels of each standard gas (0, 5, 10, 15, 20  $\text{ppm}_v$  for  $CH_4$ ; 0, 102, 150, 301, 1000  $\text{ppm}_v$  for  $CO_2$ ; 0, 1, 5, 10, 20  $\text{ppm}_v$  for  $N_2O$ ) balanced in nitrogen were used. Thus, standard curves were developed from four known concentrations of each standard with five to seven replicates at each concentration. Regressions between the peak areas (GC responses) and different concentration levels of each compound through



the origin were used to interpolate the total concentration of compounds in field samples. Minimum detection limits (MDLs) were calculated per USEPA guidelines [27] as the product of the standard deviation of seven replicates and the Student's *t* value at the 99% confidence level. For seven replicates (6 degrees of freedom), a *t* value of 3.14 was used. MDLs are presented in Table 1. To determine percent recovery, the inlet of the sampling tube (45 m teflon) was held at about 1.5 m above the ground, pulling ambient air through it to a 10 L tedlar bag using a vacuum pump. We followed the same field sampling protocol except the flux chamber was not used. The GHG concentrations of the air mixture in the tedlar bag were determined before and after spiking the sample with known standard. The expected GHG concentrations of the spiked sample mixture were calculated based on equation for determining dilutions when ambient air and spike (known calibration standard) concentrations were known. Then, the percent recovery was determined by the ratio of the concentration of the analyte expected in the spiked sample to the measured concentration of the spiked sample times 100.

**Table 1.** Greenhouse gases (GHGs) quantified in this study.

GHGs	CAS No. <sup>a</sup>	MW <sup>b</sup> (g mol <sup>-1</sup> )	Retention Time (min)	Standard Equations	R <sup>2</sup>	MDL <sup>c</sup> (ppb)	Percent Recovery
Methane (CH <sub>4</sub> )	74-82-8	16.04	1.91	y = 0.122(x)	0.99	131	98.9
Carbon Dioxide (CO <sub>2</sub> )	124-38-9	44.01	3.33	y = 0.346(x)	0.99	993	102.9
Nitrous Oxide (N <sub>2</sub> O)	10024-97-2	44.01	4.22	y = 0.0019(x)	0.99	21	96.2

Notes: <sup>a</sup> CAS No. = Chemical Abstracts Service Number; <sup>b</sup> MW = molecular weight; <sup>c</sup> MDL = method detection limit; y = concentration in ppm<sub>v</sub>; and x = GC responses or area counts.

#### 2.4. Emission Estimation

The ideal gas law at standard temperature and pressure (25 °C and 1 atm) was used to convert volumetric concentrations of each GHG in parts per million (ppm<sub>v</sub>) to a mass concentration (μg m<sup>-3</sup>) (Equation 1). Equations 2 and 3 were used to calculate emission flux (EFlux) and emission rate (ER), respectively.

$$C_{mass} = \frac{1000 \times C_{ppm} \times MW_p}{24.45} \quad (1)$$

$$EFlux = \frac{C_{mass} \times V_{fc}}{A_{fc}} \quad (2)$$

$$ER = \frac{EFlux * 1.44 \times 10^{-3}}{TNA} \times A_{sc} \quad (3)$$

where  $C_{mass}$  is mass concentration of a given compound (μg m<sup>-3</sup>),  $C_{ppmv}$  is volumetric concentration of that same compound (ppm<sub>v</sub>),  $MW_p$  is molecular weight (g mol<sup>-1</sup>) of the compound at standard temperature and pressure,  $EFlux$  is the gas emission flux (μg m<sup>-2</sup> min<sup>-1</sup>),  $V_{fc}$  is the flow rate of air supplied to the flux chamber (m<sup>3</sup> min<sup>-1</sup>),  $A_{fc}$  is the foot print area of flux chamber (m<sup>2</sup>),  $A_{sc}$  is the area of source (GLAS, m<sup>2</sup>),  $ER$  is the emission rate (g hd<sup>-1</sup> d<sup>-1</sup>), and  $TNA$  is the total number of animals at each facility or GLAS. The ERs (g hd<sup>-1</sup> d<sup>-1</sup>) from individual GLASs were added to estimate the aggregate ER.

### 2.5. Statistical Analyses

Normality and equal variance tests revealed that the data was not normally distributed. Methane, CO<sub>2</sub>, and N<sub>2</sub>O concentration values for feedyard facility were transformed using log<sub>10</sub>, log<sub>10</sub>, and inverse square root transformations, respectively, to satisfy assumptions for normality and equal variances. Similarly, CH<sub>4</sub>, CO<sub>2</sub>, and N<sub>2</sub>O concentration values for dairy were transformed using log<sub>10</sub>, inverse square root, and log<sub>10</sub> transformations, respectively. Three outliers from pen surfaces (feedyard) and 2 outliers from open-lot (dairy) were eliminated since those concentration values were found outside of 3 standard deviations. Analysis of variance (ANOVA) was performed on transformed data to compare measured GHG (CH<sub>4</sub>, CO<sub>2</sub>, and N<sub>2</sub>O) concentrations and estimated ERs among various GLAS at the dairy and feedyard operations. The null hypothesis tested was that mean GHG concentrations and ERs among various GLAS were equal. All statistical analyses were performed in the SAS environment using the PROC Means, Generalized Linear Model (GLM) procedures [28]. Mean emission rates were then separated using Duncan's Multiple Range Test [29] at a significance level (*p*) of 0.05. In this manuscript, the median (instead of mean) of the original data (non-transformed) was reported along with statistical test results (a, b, c, ..., and g letter for grouping) from transformed analysis (ANOVA test results with transformed data) [30]. The quartiles (lower and upper quartiles) were also reported along with the median to indicate variability within a GLAS.

## 3. Results and Discussion

### 3.1. Greenhouse Gas Concentrations at the Dairy

The coefficient of determination ( $R^2$ ) of each standard equation and percent recovery reflect the accuracy and reliability of the direct GHG measurements using a portable GHG gas chromatograph (Table 1). The MDLs indicate the ability of the measurement system to accurately determine (with 99% confidence) CH<sub>4</sub>, CO<sub>2</sub>, and N<sub>2</sub>O concentrations as low as 131, 993, and 21 ppb<sub>v</sub>, respectively. The average ambient temperature during the sampling period ranged from 28.8 and 35.9 °C (Table 2). The minimum and maximum median volumetric concentrations of GHG measured at various GLASs during the summer were 1.96 to 3739, 339 to 2758, and 0.4 to 0.12 ppm<sub>v</sub> for CH<sub>4</sub>, CO<sub>2</sub>, and N<sub>2</sub>O, respectively (Table 2). These values were well above the MDLs for all three gases of interest. The measured gas concentrations within and among the GLASs were found to vary widely (indicated by quartiles), likely due to spatially variable manure loading rates and variations in populations of microorganisms that were responsible for gaseous emissions at various GLASs at the dairy operation. Husted [31] reported that emissions of CH<sub>4</sub> and N<sub>2</sub>O from animal manure stored under the summer and winter conditions were highly variable due to dispersal distribution of manure. Similar ranges in GHG concentrations were also reported inside a naturally ventilated dairy barn as 0.16 to 0.75 ppm<sub>v</sub> for N<sub>2</sub>O, 9 to 283 ppm<sub>v</sub> for CH<sub>4</sub>, and 644 to 3530 ppm<sub>v</sub> for CO<sub>2</sub> [14].

**Table 2.** Volumetric concentration (median and quartiles) measured from various GLASs in a dairy.

GLAS	N	Average Temperature (°C)	Median CH <sub>4</sub> LQ–UQ (ppm <sub>v</sub> )	Median CO <sub>2</sub> LQ–UQ (ppm <sub>v</sub> )	Median N <sub>2</sub> O LQ–UQ (ppm <sub>v</sub> )
Manure lane	8	35.9	3.51 <sup>a</sup> 2.53–6.2	339 <sup>a</sup> 319–351	0.10 <sup>a</sup> 0.06–0.26
Bedding area	8	35.9	1.96 <sup>b</sup> 1.5–2.8	382 <sup>ab</sup> 369–392	1.12 <sup>b</sup> 0.56–1.49
Loafing pen	14	30.3	11.10 <sup>c</sup> 4.4–18.4	480 <sup>c</sup> 414–3501	0.79 <sup>b</sup> 0.66–0.81
Settling basin	8	28.8	1457 <sup>d</sup> 1289–2425	2641 <sup>de</sup> 1846–3457	0.16 <sup>ca</sup> 0.12–0.17
Primary lagoon	8	30.9	3739 <sup>e</sup> 3118–4173	2758 <sup>e</sup> 2569–2945	0.055 <sup>d</sup> 0.05–0.061
Secondary lagoon	8	30.9	458 <sup>f</sup> 447–485	761 <sup>cf</sup> 698–780	0.04 <sup>d</sup> 0.03–0.058
Open lot	10	30.9	13 <sup>c</sup> 10.4–18.3	1269 <sup>df</sup> 938–1923	1.10 <sup>b</sup> 0.76–1.78
Compost piles	10	32.3	0.36 <sup>g</sup> 0.25–0.48	543 <sup>bf</sup> 381–715	0.20 <sup>c</sup> 0.16–0.36
Total	74				

Notes: letters a to g indicate whether a particular compound among GLAS are statistically different; Medians followed by the same letter in columns for a particular compound are not significantly different ( $p > 0.05$ ); LQ is the lower quartile value; UQ is the upper quartile value; N is the number of observations.

### 3.1.1. Methane Concentrations

The median CH<sub>4</sub> concentrations measured from the primary lagoon, settling basin, and secondary lagoon (3739; 1457 and 458 ppm<sub>v</sub>, respectively) were significantly different ( $p < 0.05$ ) and higher than those from other GLAS (Table 2). Cumulative, these three sources constituted about 23% of the total GLAS area (Figure 5). High temperatures during the summer were the main factor leading to higher CH<sub>4</sub> emissions from the settling basin and lagoons. Previous research reported that methanogenesis and subsequent methane production in the anaerobic settling basin and lagoons is strongly dependent on temperature that accelerated anaerobic decomposition of organic matter [32]. Weiske *et al.* [33] also reported that increased microbial activity due to higher temperature during the summer amplified the CH<sub>4</sub> production in a slurry-based manure management system. The highest median concentration was measured from the primary lagoon followed by the settling basin, secondary lagoon, open-lot, and loafing pen. Cumulatively, those five sources constituted about 88% of the total GLAS area (Figure 5). Concentrations measured at the manure lane, bedding area, and compost piles were significantly different but lower than those measured from other GLAS. Although not statistically different, median CH<sub>4</sub> concentrations measured from the loafing pen and open-lot (11 and 13 ppm<sub>v</sub>, respectively) trended higher than those in manure lane, bedding area, and compost piles. This was likely due to fermentation induced by the anaerobic environment of the loafing pen and open-lot pen, and anaerobic

soil layers produced immediately under the manure's top surface [5]. The average CH<sub>4</sub> concentration was 0.36 ppm<sub>v</sub> from compost piles, which was lower than other sources, likely because the manure was already partially degraded.

**Figure 5.** GLAS contribution to overall CH<sub>4</sub> ERs and area at Free-stall dairy during the summer. (Note: ML = manure lane; BA = bedding area; LP = loafing pen; SB = settling basin; PL = primary lagoon; SL = secondary lagoon; OL = open lot; and CP = compost pile).

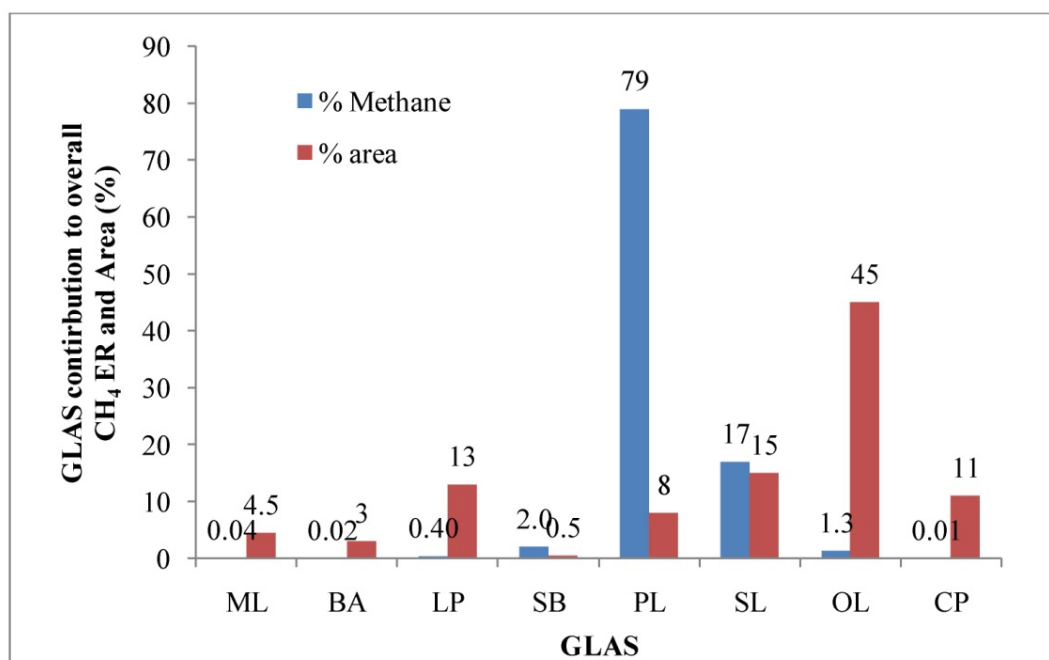

### 3.1.2. Carbon Dioxide Concentrations

The highest median CO<sub>2</sub> concentration was measured from the primary lagoon followed by the settling basin, open-lot, and secondary lagoon. Cumulatively, these four sources constituted about 68% of the total GLAS area (Figure 6). Higher CO<sub>2</sub> concentrations from those four GLAS were emitted due to anaerobic degradation of manure with high temperature in the summer. The median CO<sub>2</sub> concentration measured from the primary lagoon was significantly higher than those from the other GLASs ( $p < 0.05$ ). Carbon dioxide concentrations between the primary lagoon and settling basin (2758 and 2641 ppm<sub>v</sub>, respectively), and settling basin and open-lot (2641 and 1269, respectively) were statistically similar ( $p > 0.05$ ); and significantly higher than those from the manure lane, bedding area, loafing pen, and compost piles. There were no significant differences in measured CO<sub>2</sub> concentrations between the open-lot and loafing pen ( $p > 0.05$ ). Similarly, the median CO<sub>2</sub> concentration among manure lane, bedding area, and compost piles were significantly different and lower than those measured from other GLASs ( $p < 0.05$ ).

**Figure 6.** GLAS contribution to overall CO<sub>2</sub> ERs and area at Free-stall dairy during the summer. (Note: ML = manure lane; BA = bedding area; LP = loafing pen; SB = settling basin; PL = primary lagoon; SL = secondary lagoon; OL = open-lot; and CP = compost pile).

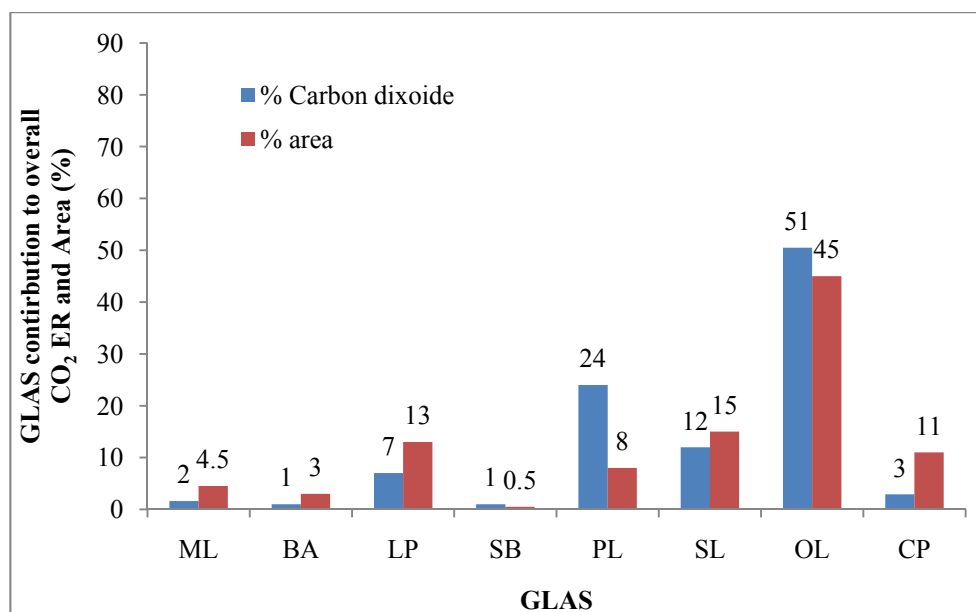

### 3.1.3. Nitrous Oxide Concentrations

The highest average N<sub>2</sub>O concentration was measured from the bedding area, open-lot, and loafing pen. They were statistically similar ( $p > 0.05$ ). Nitrous oxide concentrations measured from those three GLASs were significantly higher and different than those in the manure lane, settling basin, primary and secondary lagoons, and compost piles. There were no significant differences in the median N<sub>2</sub>O concentrations between the primary and secondary lagoons; settling basin and compost piles; and manure lane and settling basin ( $p > 0.05$ ; Table 2). Average atmospheric concentrations of CH<sub>4</sub>, CO<sub>2</sub>, and N<sub>2</sub>O are approximately ~1.7, ~379, and ~0.3 ppmv [2]. Nitrous oxide concentrations measured from the manure lane, settling basin, primary and secondary lagoons, and compost pile (0.1, 0.16, 0.06 and 0.04, and 0.2 ppm<sub>v</sub>, respectively) were much lower than those in the ambient (background) atmospheric concentration (~0.3 ppm<sub>v</sub>). Low N<sub>2</sub>O concentrations were due to the diluting effect of sweep air (zero grade air used to generate flux) inside the flux chamber since those GLASs contributed very little to emit N<sub>2</sub>O. The freshly deposited manure in the manure lanes was the anaerobic product of enteric fermentation inside the rumen, which contains low N<sub>2</sub>O. Similarly, a true anaerobic condition in the slurry (settling basin) and liquid manure in the lagoon produced low N<sub>2</sub>O emissions. This was because N<sub>2</sub>O is formed during aerobic nitrification and anaerobic denitrification. These results showed a good agreement with previous work by Osada *et al.* [34]. They observed that slurry manure emits a small amount of N<sub>2</sub>O due to the poor aerobic conditions. Higher N<sub>2</sub>O concentrations in the open-lot, bedding area, and loafing pen compared to other GLAS were likely due to occasional mixing of urine with manure and soil (open-lot pen), compost or separated solids (loafing pen), and sand (bedding materials) under aerobic nitrification process.

### 3.2. Estimation of Emission Rates (ERs) at the Dairy Operation

The minimum and maximum median emission rates (ERs) of GHG estimated at various GLASs during the summer were 0.04 to 666, 69 to 2824, and 0.004 to 2.41 g hd<sup>-1</sup> d<sup>-1</sup> for CH<sub>4</sub>, CO<sub>2</sub>, and N<sub>2</sub>O, respectively (Table 3). Similar to GHG concentrations (Table 2), the estimated ERs from each GLAS were found to vary widely as indicated by the relatively large quartiles (Table 3). Variations were likely due to temperature variations and uneven distribution of excretal returns at various GLASs at the dairy operation. Mukhtar *et al.* [35] reported highly variable ammonia emission rates from open-lot surfaces at a free-stall dairy in Central Texas due to variable temperature, manure loading rates, and manure bacterial activity of the GLAS.

**Table 3.** Estimated GHG ERs (median and quartiles) from various GLAS of the free-stall dairy during the summer.

GLAS	GLAS Area (m <sup>2</sup> ) (% contribution)	TNA	Emission Rates (ERs)		
			Median CH <sub>4</sub> LQ–UQ (g hd <sup>-1</sup> d <sup>-1</sup> )	Median CO <sub>2</sub> LQ–UQ (g hd <sup>-1</sup> d <sup>-1</sup> )	Median N <sub>2</sub> O LQ–UQ (mg hd <sup>-1</sup> d <sup>-1</sup> )
Manure Lane	12,527 (4.5%)	3200	0.34 <sup>a</sup> 0.25–0.60	89 <sup>a</sup> 84–93	26 <sup>a</sup> 16–70
Bedding Area	8451 (3%)	3200	0.13 <sup>b</sup> 0.99–0.19	69 <sup>ba</sup> 67–71	202 <sup>b</sup> 103–268
Loafing Pen	36,117(13%)	3200	3.1 <sup>c</sup> 1.24–5.11	366 <sup>c</sup> 316–2667	598 <sup>c</sup> 509–602
Settling Basin	1266(0.5)	3200	14.2 <sup>d</sup> 12.54–23.60	71 <sup>b</sup> 49–92	4 <sup>d</sup> 4–5
Primary Lagoon	23,182(8%)	3200	666 <sup>e</sup> 556–744	1348 <sup>cd</sup> 1256–1440	27 <sup>a</sup> 25–30
Secondary Lagoon	40,110 (15%)	3200	141 <sup>f</sup> 138–150	644 <sup>c</sup> 590–660	34 <sup>a</sup> 27–49
Open lot	123,670(45%)	3750	11 <sup>d</sup> 8.42–14.89	2824 <sup>d</sup> 2089–4280	2410 <sup>e</sup> 1702–3965
Compost pile	30,674 (11%)	6950	0.04 <sup>g</sup> 0.027–0.053	162 <sup>e</sup> 113–213	59 <sup>f</sup> 47–107
<b>Total</b>	<b>275,997 (100%)</b>		<b>836</b>	<b>5573</b>	<b>3360</b>

Notes: ER is the emissions rate; GLAS is the ground level area sources; TNA is the total animal used to estimate ER at each GLAS; LQ is the lower quartile value; UQ is the upper quartile value; Medians followed by the same letter in columns for a particular compound are not significantly different ( $p > 0.05$ ).

#### 3.2.1. Methane Emission Rates

The aggregate CH<sub>4</sub> ER for this dairy was 836 g hd<sup>-1</sup> d<sup>-1</sup> in the summer (Table 3). The high aggregate CH<sub>4</sub> ER was mainly due to a higher methane concentration measured from the anaerobic lagoon at the dairy operation (Table 2). Methane production in an anaerobic lagoon mainly depends on the amount of degradable organic material in the wastewater and temperature. Previous researches also

indicated that methanogenesis and subsequent methane production in the anaerobic manure storage and treatment structures such as lagoons, settling basins, and slurries were strongly dependent on high temperature [31–33]. The anaerobic primary lagoon contributed approximately 80% of the aggregate CH<sub>4</sub> ER. Based on the USEPA estimate [1], the aggregate CH<sub>4</sub> ER for this dairy was 238 g hd<sup>-1</sup> d<sup>-1</sup>. The direct field CH<sub>4</sub> ER measurement was about 3.5 times higher than that of EPA estimate. Previous research reported an underestimation of CH<sub>4</sub> emission from anaerobic lagoon by 65% using the EPA method [36]. The median CH<sub>4</sub> ER estimated from the primary lagoon was significantly higher than those from the other GLAS ( $p < 0.05$ ). This source alone contributed about 80% of the overall CH<sub>4</sub> emission and comprised about 8% of the total GLAS (Figure 5). The highest average CH<sub>4</sub> ER was estimated from the primary lagoon, followed by the secondary lagoon, settling basin, and open-lot pen. Methane production occurred during anaerobic manure decomposition with favorable high temperatures in the summer that increased manure bacterial activity and produced high CH<sub>4</sub> concentrations compared to other GLAS. Higher ERs from the settling basin, primary lagoon, and secondary lagoon were likely due to high CH<sub>4</sub> concentrations despite the relatively small footprint areas. Those three GLAS contributed about 98% of the overall CH<sub>4</sub> emission and comprised about 24% of the total emitting area (total GLAS). Therefore, abatement and management practices that address emissions from these sources will likely be most effective for reducing facility-wide emissions. There were no significant difference in CH<sub>4</sub> ERs between the settling basin and open-lot pen ( $p > 0.05$ ). In contrast, there were significant differences in CH<sub>4</sub> ERs among the manure lane, bedding area, loafing pen, and compost piles ( $p > 0.05$ ).

### 3.2.2. Carbon Dioxide Emission Rates

The overall calculated CH<sub>4</sub> ER for this dairy was 5573 g hd<sup>-1</sup> d<sup>-1</sup> in the summer (Table 3). The average CO<sub>2</sub> ER estimated from the open-lot pen was significantly higher than those from the other GLAS ( $p < 0.05$ ). This source alone contributed about 51% of the overall CO<sub>2</sub> emission and comprised about 45% of the total GLAS (Figure 6). The highest average CO<sub>2</sub> ER was estimated from the open-lot, followed by primary lagoon, secondary lagoon, and loafing pen. These four GLAS altogether contributed about 94% of the overall CO<sub>2</sub> emission and comprised about 81% of the total emitting area (total GLAS). Therefore, abatement and management practices to reduce CO<sub>2</sub> emissions can be directed to those four GLASs. It is likely that the anaerobic decomposition of the manure in the primary lagoon during summer resulted higher CO<sub>2</sub> ER and this source (GLAS) alone contributed about 24% of the overall emission and comprised of 8% of the total emitting area (Figure 6). Higher CO<sub>2</sub> in the open-lot and the loafing pen may be due to the incomplete anaerobic decomposition of the mixture of manure, urine, and soils (open-lot pen); and mixture of manure, urine and separated solids (loafing pen). There were no significant difference in CO<sub>2</sub> ERs among the loafing pen, and primary and secondary lagoons. The CO<sub>2</sub> ERs from those three sources were significantly higher than those estimated from the manure lane, bedding area, settling basin, and compost piles ( $p < 0.05$ ).

### 3.2.3. Nitrous Oxide Emission Rates

The overall estimated  $N_2O$  ER for this dairy was  $3.4 \text{ g hd}^{-1} \text{ d}^{-1}$  in the summer (Table 3). Based on the USEPA estimate [1], the aggregate  $N_2O$  ER for this dairy was  $0.7 \text{ g hd}^{-1} \text{ d}^{-1}$ . In-field measurements of  $CH_4$  emissions were about 5 times higher than EPA estimates. Similar to  $CH_4$  emissions,  $N_2O$  emission estimates may have been underestimated by the USEPA method. The average  $N_2O$  ER estimated from the open-lot was significantly higher than those from the other GLASs ( $p < 0.05$ ). Higher  $N_2O$  from the open-lot pen compared to other GLAS were likely due to the mixing of urine with manure and soil that facilitated aerobic nitrification process. This source (open-lot) alone contributed about 72% of the overall  $N_2O$  emission and comprised about 45% of the total GLAS (Figure 7). The highest average  $N_2O$  ER was estimated from the open-lot, followed by the loafing pen, and bedding area ( $p < 0.05$ ). These three GLAS altogether contributed about 96% of the overall  $N_2O$  emission and comprised about 61% of the total emitting area (Figure 7). Therefore, abatement and management practices that address emissions from these three sources will likely be most effective to reduce  $N_2O$  emissions for this dairy. There were no significant difference in  $N_2O$  ERs among the manure lane, and primary and secondary lagoons.

**Figure 7.** GLAS contribution to overall  $N_2O$  ERs and area at Free-stall dairy during the summer. (Note: ML = manure lane; BA = bedding area; LP = loafing pen; SB = settling basin; PL = primary lagoon; SL = secondary lagoon; OL = open-lot; and CP = compost pile).

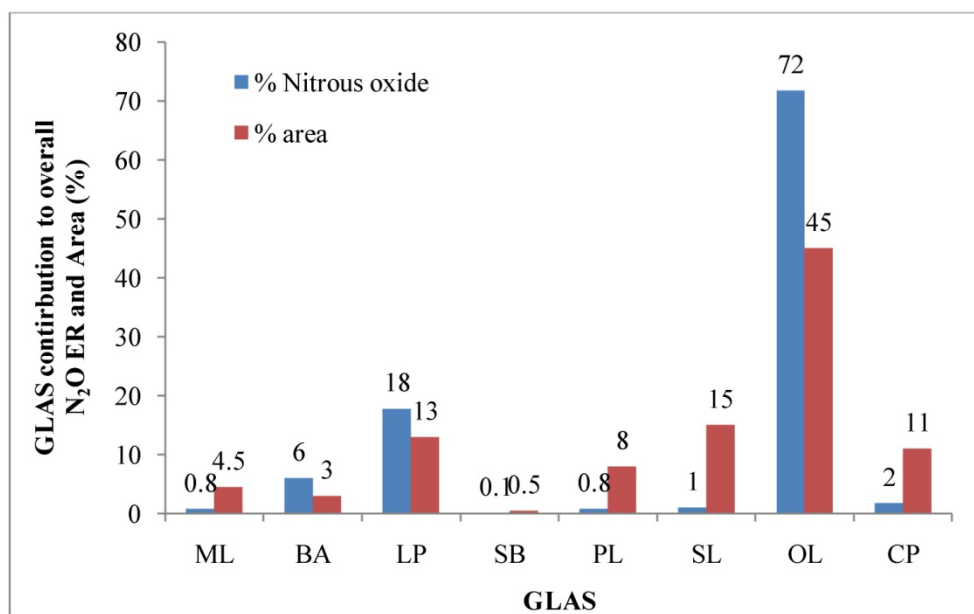

### 3.3. Greenhouse Gas Concentrations in the Feedyard

#### 3.3.1. Comparison of GHG Concentrations in the Individual Pens

At the feedyard, four corners of a large feedlot were sampled for GHGs. The minimum and maximum median volumetric concentrations of GHGs measured at various pen surfaces during the summer were 2.8 to 5.3, 668 to 1054, and 0.31 to 0.41 ppm<sub>v</sub> for  $CH_4$ ,  $CO_2$ , and  $N_2O$ , respectively (Table 4a). The highest average  $CH_4$  concentration was measured from the SE corner pen, which had



relatively more manure on the surface compared to other pens ( $p < 0.05$ ). No significant differences in median CH<sub>4</sub> concentrations among the NW, SW, and NE corner pens. No significant differences in CO<sub>2</sub> concentration were detected between NE and SE corner pens and they were significantly higher than those measured from NW and SW corner pens ( $p < 0.05$ ). Carbon dioxide concentrations between NW and SW corner pens were statistically similar ( $p > 0.05$ ). Similarly, no significant differences in N<sub>2</sub>O concentrations between NW, SW, and NE corner pens, but they were significantly higher than that from the SE corner pen. The measured gas concentrations within and among the pens were found to vary widely as indicated by quartiles (Table 4a), likely due to spatially variable manure loading rates, fluctuations in temperature, and variations in populations of microorganisms that were responsible for gaseous emissions at various pen surfaces. The pooled data (70 observations) from four pens were used to represent the concentration and emission rate from the entire feedlot pen surface.

**Table 4a.** Volumetric concentration (median and quartiles) GHGs measured from various pens at a feedlot.

Pen ID	N	Average Temperature (°C)	Median CH <sub>4</sub> LQ–UQ (ppm <sub>v</sub> )	Median CO <sub>2</sub> LQ–UQ (ppm <sub>v</sub> )	Median N <sub>2</sub> O LQ–UQ (ppm <sub>v</sub> )
NW corner	17	32.8	2.8 <sup>a</sup> 2.4–3.2	849 <sup>a</sup> 484–1047	0.41 <sup>a</sup> 0.37–0.44
SW corner	20	34.1	2.2 <sup>a</sup> 1.9–5.9	668 <sup>a</sup> 499–817	0.36 <sup>a</sup> 0.35–0.41
NE corner	16	34.9	4.1 <sup>a</sup> 3.4–4.8	956 <sup>b</sup> 858–1248	0.40 <sup>a</sup> 0.32–0.44
SE corner	17	33.8	5.3 <sup>a</sup> 1.9–6.0	1054 <sup>b</sup> 754–1679	0.31 <sup>b</sup> 0.27–0.33
<b>Total</b>	<b>70</b>				

Notes: Medians followed by the same letter in columns for a particular compound are not significantly different ( $p > 0.05$ ); LQ is the lower quartile value; UQ is the upper quartile value; N is the number of observations.

### 3.3.2. Methane Concentration

The highest CH<sub>4</sub> concentration was measured at the runoff holding pond, followed by the pen surface (feedlot) and compost piles. Median CH<sub>4</sub> concentrations in the runoff holding pond were significantly different and higher than those in the pen and compost pile areas. The average CH<sub>4</sub> concentration measured from the runoff holding pond was about 22 and 57 times higher than those from the pen surface and compost pile areas (Table 4b). The average methane (CH<sub>4</sub>) concentration measured over the pen surface was about 2.6 times higher than that measured at the compost pile. Higher CH<sub>4</sub> concentrations in the anaerobic runoff holding pond were likely due to high temperature during summer time. Previous research reported that methanogenesis and subsequent methane production in anaerobic settling basins and lagoons is strongly dependent on temperature [31]. CH<sub>4</sub> concentrations measured from the compost pile were the lowest among the sources (Table 4b). The decomposed organic manure in the compost piles produced low CH<sub>4</sub> ER.

**Table 4b.** Volumetric concentration (median and quartiles) of GHGs measured from three major GLASs at a feedyard.

GLAS	N	Median CH <sub>4</sub> LQ–UQ (ppm <sub>v</sub> )	Median CO <sub>2</sub> LQ–UQ (ppm <sub>v</sub> )	Median N <sub>2</sub> O LQ–UQ (ppm <sub>v</sub> )
<sup>1</sup> Pen surface	70	3.1 <sup>a</sup> 2.2–5.4	852 <sup>a</sup> 662–1152	0.37 <sup>a</sup> 0.33–0.41
Runoff holding pond	9	68 <sup>b</sup> 45–70	417 <sup>b</sup> 394–433	0.072 <sup>b</sup> 0.071–0.074
Compost piles	8	1.2 <sup>c</sup> 0.78–1.44	552 <sup>b</sup> 255–887	1.03 <sup>c</sup> 0.33–1.20
<b>Total</b>	<b>87</b>			

Notes: Medians followed by the same letter in columns for a particular compound are not significantly different ( $p > 0.05$ ); LQ is the lower quartile value; UQ is the upper quartile value; N is the number of observations; <sup>1</sup> Pooled data from four pens were considered for average volumetric concentration for entire pen surface.

### 3.3.3. Carbon Dioxide Concentrations

Median CO<sub>2</sub> concentrations were also highly variable within each GLAS as indicated by the large quartiles (Table 4b). Unlike CH<sub>4</sub> concentrations, median CO<sub>2</sub> concentrations measured from the pen surface were significantly different and higher than those measured from the runoff holding pond and compost pile area. The median CO<sub>2</sub> concentration measured from the pen surface was about 2 and 1.5 times, respectively, higher than those from the runoff pond and compost pile areas (Table 4b). Median CO<sub>2</sub> concentrations were higher at the compost pile area compared to the runoff holding pond, although, there was no significance difference in CO<sub>2</sub> concentrations between those two GLAS. Higher CO<sub>2</sub> concentrations above the compost pile were likely due to high temperatures during summer time.

### 3.3.4. Nitrous Oxide Concentrations

Similar to CH<sub>4</sub> and CO<sub>2</sub> concentrations, N<sub>2</sub>O concentrations were also highly variable within each GLAS as indicated by the quartiles (Table 4b). The highest median N<sub>2</sub>O concentration was measured from compost piles, followed by the pen surface and runoff pond. Median N<sub>2</sub>O concentrations in those three sources were significantly different ( $p < 0.05$ ). Median N<sub>2</sub>O concentrations measured at the compost pile were about 2.8 and 14 times higher than those in the pen surface and runoff pond, respectively (Table 4b). The low median N<sub>2</sub>O concentration above the runoff holding pond was due to a true anaerobic condition since N<sub>2</sub>O is formed during aerobic nitrification and anaerobic denitrification. Previous work also reported that slurry manure emits a small amount of N<sub>2</sub>O due to the poor aerobic conditions [34].

## 3.4. Estimation of Emission Rates (ERs) from the Feedyard

Similar to GHG ERs at the dairy operation (Table 3), the estimated ERs from each GLAS of the feedyard operation were found to vary widely as indicated by the quartiles (Table 5). The highest CH<sub>4</sub> ER was estimated from the runoff pond, followed by the pen surface, and compost pile. There were no

significant differences in estimated CH<sub>4</sub> ERs between the pen surface and runoff pond. However, the median CH<sub>4</sub> ER estimated from compost pile was significantly lower than those from the pen surface and runoff pond. Median CH<sub>4</sub> ERs from the pen surface and runoff pond were about 43 and 51 times, respectively, higher than that from compost pile area (Table 5). Already degraded manure in the compost pile resulted in lower CH<sub>4</sub> ER. The runoff pond and pen surface contributed about 99% of the aggregate CH<sub>4</sub> emission and comprised of about 94% of the total area (Figure 8). Thus, abatement and management practices that address emissions from these two sources will likely be most effective to reduce CH<sub>4</sub> emissions for this feedyard operation. The aggregate CH<sub>4</sub> ER for this feedyard was 3.8 g hd<sup>-1</sup> d<sup>-1</sup> in the summer (Table 3). Based on the USEPA estimate, the aggregate CH<sub>4</sub> ER for this feedyard was 4.5 g hd<sup>-1</sup> d<sup>-1</sup> in the summer [1]. The EPA estimate was about 1.2 times higher than that of direct measurement.

**Figure 8.** Percent contribution of each GLAS to overall CH<sub>4</sub> ER and area at the feedyard.

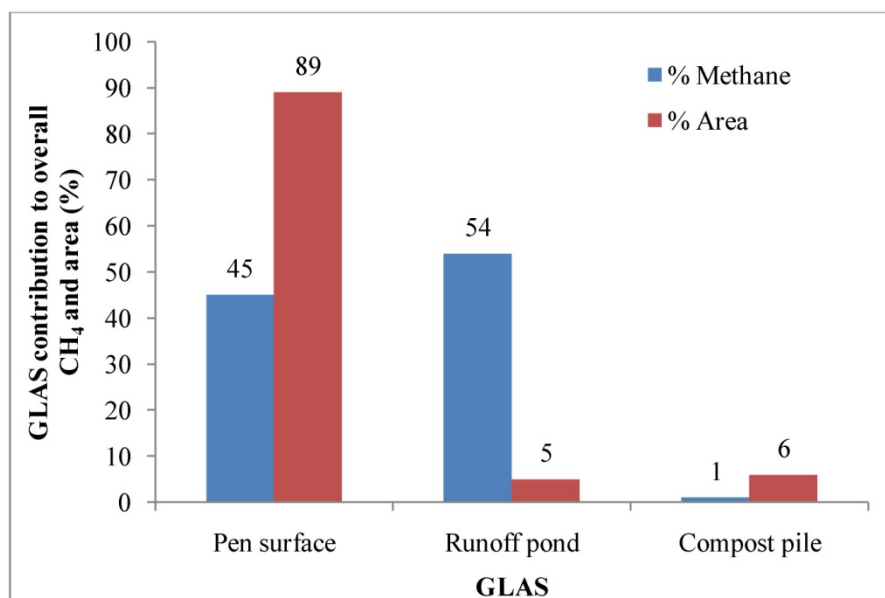

The highest CO<sub>2</sub> ER was estimated from the pen surface, followed by the compost pile and runoff pond. The median CO<sub>2</sub> ER estimated from the pen surface was about 37 and 24 times, respectively, higher than those from the runoff pond and compost pile (Table 5). There was no significant difference in CO<sub>2</sub> ERs between the runoff holding pond and compost pile. However, the median CO<sub>2</sub> ER from the pen surface was significantly higher than those from the compost pile and runoff pond. The aggregate CO<sub>2</sub> ER for this feedyard was 1399 g hd<sup>-1</sup> d<sup>-1</sup> in the summer (Table 5). The pen surface alone contributed about 93% of the aggregate CO<sub>2</sub> emission from this feedyard (excluding boilers, engines, and enteric fermentation) and comprised about 89% of the total GHG emitting area from the feedyard operation (Figure 9).

The aggregate N<sub>2</sub>O ER for this feedyard was 0.68 g hd<sup>-1</sup> d<sup>-1</sup> in the summer (Table 5). Based on the US EPA estimate, the aggregate CH<sub>4</sub> ER for this feedyard was 3.97 g hd<sup>-1</sup> d<sup>-1</sup> in the summer [1]. The EPA estimate was about 5.8 times higher than that of direct measurement. The highest N<sub>2</sub>O ER was estimated from the pen surface, followed by the compost pile and runoff pond. The estimated N<sub>2</sub>O ER from the pen surface was significantly higher than those estimated from the compost pile and runoff

pond ( $p < 0.05$ ). The median  $N_2O$  ER estimated from the pen surface was about 57 and 6 times higher than those from the runoff pond and compost pile, respectively (Table 5). There was no significant difference in  $N_2O$  ERs between the runoff pond and compost pile ( $p > 0.05$ ). Similar to  $CO_2$  emission, the pen surface alone contributed about 84% of the aggregate  $N_2O$  emission of this feedyard (Figure 10). Thus, to reduce  $N_2O$  emissions from this feedyard, the abatement and management practices should be directed to the pen surface.

**Figure 9.** Percent contribution of each GLAS to overall  $CO_2$  ER and area at the feedyard.

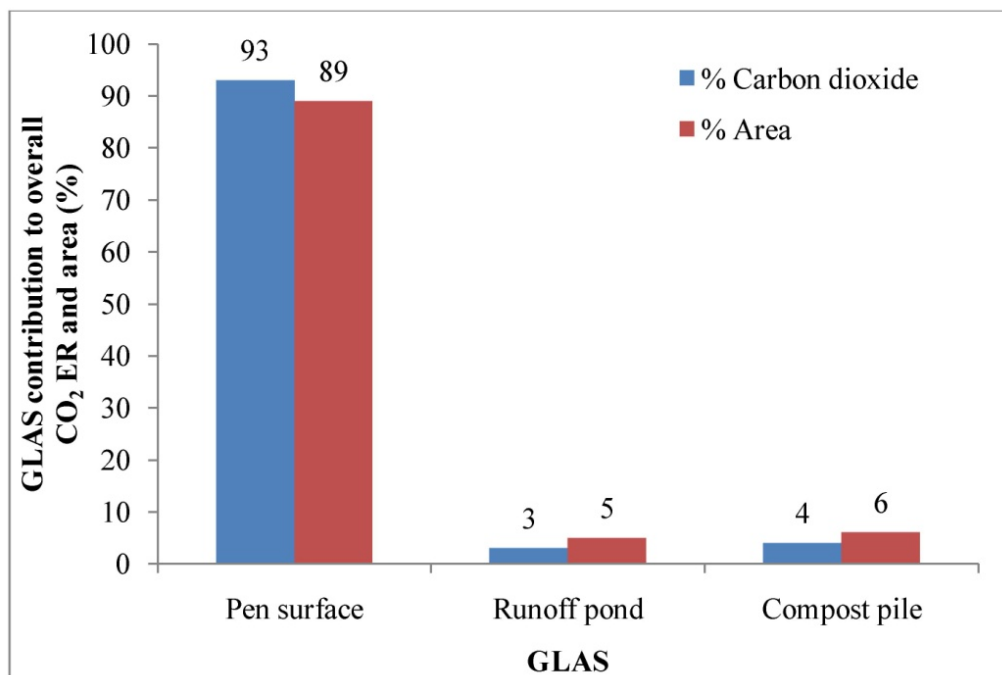
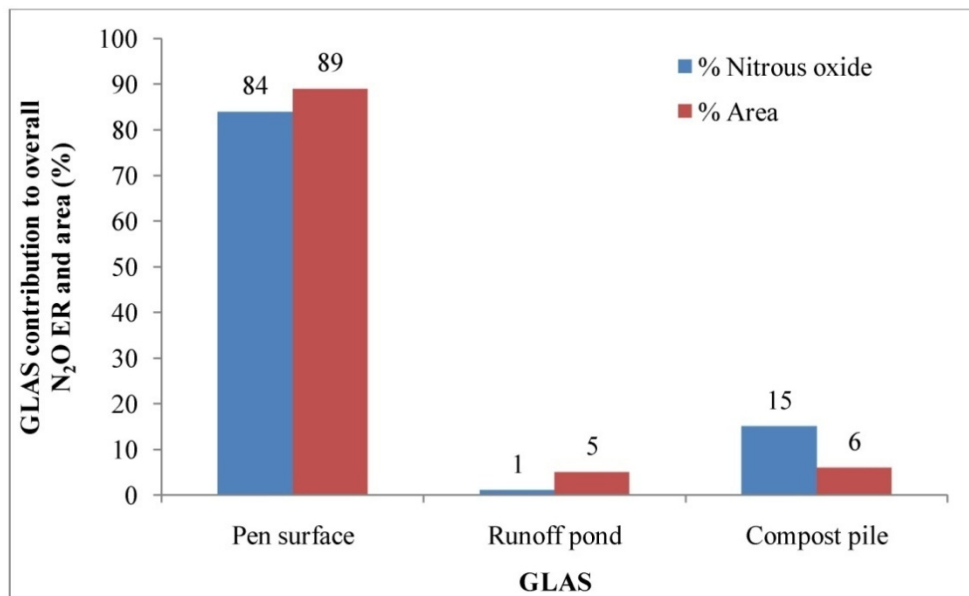

**Table 5.** Estimated emission rates (median and quartiles) from various GLASs at of the feedyard using pooled data-set.

Pen ID	GLAS area (m <sup>2</sup> ) (% contribution)	TNA	Median CH <sub>4</sub> LQ–UQ (g hd <sup>-1</sup> d <sup>-1</sup> )	Median CO <sub>2</sub> LQ–UQ (g hd <sup>-1</sup> d <sup>-1</sup> )	Median N <sub>2</sub> O LQ–UQ (g hd <sup>-1</sup> d <sup>-1</sup> )
<sup>1</sup> Pen surface	910,252 (89%)	40,000	1.71 <sup>a</sup> 1.3–3.0	1309 <sup>a</sup> 1017–1770	0.57 <sup>a</sup> 0.5–0.63
Runoff holding pond	49,107 (5%)	40,000	2.05 <sup>a</sup> 1.4–2.1	35 <sup>b</sup> 33–36	0.01 <sup>b</sup> 0.006–0.011
Compost piles	59,000 (6%)	40,000	0.04 <sup>b</sup> 0.03–0.05	55 <sup>b</sup> 25–88	0.10 <sup>c</sup> 0.03–0.12
<b>Total</b>	<b>1,018,357 (100%)</b>		<b>3.8</b>	<b>1399</b>	<b>0.68</b>

Notes: ER is the emissions rate; GLAS is the ground level area sources; TNA is the total animal used to estimate ER at each GLAS; Medians followed by the same letter in columns for a particular compound are not significantly different ( $p > 0.05$ ); LQ is the lower quartile value; UQ is the upper quartile value; <sup>1</sup> Pooled data from four pens were considered for median emission rate for entire pen surface (feedlot).

**Figure 10.** Percent contribution of each GLAS to overall N<sub>2</sub>O ER and area at the feedyard.



### 3.5. Uncertainty Analysis

Uncertainty analysis was performed on GHG sampling and analyzing system by using the first order Taylor series techniques, which indicates the maximum uncertainty expected using a particular set of primary measurements. The overall uncertainty results from the uncertainty in the measurement of each independent variable propagating through data reduction equations [37]. This analysis was performed for determining potential errors in primary measurements such as the flux chamber diameter, sweep air volume, gas concentration by GC, area of the GLAS, and number of animals. Table 6 shows the average overall uncertainties estimated from different GLAS in dairy and feedyard facilities. Anaerobic manure management systems such as lagoons, runoff pond, settling basin, and compost piles resulted in higher uncertainties in N<sub>2</sub>O measurement due to low N<sub>2</sub>O emissions from those sources. In this research, measurements of the volume flow rate of the sweep air to the flux chamber and gas concentration measurements contributed the most to overall uncertainty.

**Table 6.** Average overall uncertainties (g hd<sup>-1</sup> d<sup>-1</sup>) estimated from different GLAS in dairy and feedyard facilities.

Free-stall dairy			
GLAS	CH <sub>4</sub>	CO <sub>2</sub>	N <sub>2</sub> O
Primary lagoon	10.42	21.50	0.006
Manure lane	0.015	1.44	0.006
Bedding	0.01	1.12	0.005
Loafing pen	0.06	15.67	0.008
Settling basin	0.30	1.104	0.001
Secondary lagoon	2.27	10.10	0.018
Open lot	0.22	50.91	0.065
Compost	0.01	2.64	0.006

Table 6. Cont.

Feedyard			
GLAS	CH <sub>4</sub>	CO <sub>2</sub>	N <sub>2</sub> O
Entire pen	0.073	3.45	0.032
Runoff pond	0.005	0.11	0.002
Compost	0.005	0.17	0.002

### 3.6. Comparison of GHG Emissions from the Dairy and Cattle Feedyard Operations

#### 3.6.1. Comparison of Emission Estimated Based on Field Measurement

The aggregate ERs for CH<sub>4</sub>, CO<sub>2</sub>, and N<sub>2</sub>O were 836; 5573; and 3.4 g hd<sup>-1</sup> d<sup>-1</sup>, respectively, for the dairy operation during the summer excluding enteric CH<sub>4</sub> emissions. Similarly, the aggregate summer ERs for CH<sub>4</sub>, CO<sub>2</sub>, and N<sub>2</sub>O were 3.8; 1399; and 0.68 g hd<sup>-1</sup> d<sup>-1</sup>, respectively, estimated from the feedyard. The aggregate, CH<sub>4</sub>, CO<sub>2</sub>, and N<sub>2</sub>O ERs from the dairy facility during the summer were about 220, 4, and 5 times higher, respectively, than those from the feedyard operation. Greenhouse gas ERs are also expressed in CO<sub>2</sub> equivalent (CO<sub>2</sub>e) as kg of CO<sub>2</sub>e hd<sup>-1</sup> d<sup>-1</sup> taking into account all the compounds (CH<sub>4</sub>, CO<sub>2</sub>, and N<sub>2</sub>O). To calculate CO<sub>2</sub>e, conversion factors of 25 and 310 were used for CH<sub>4</sub> and N<sub>2</sub>O, respectively. Aggregate GHG ERs estimated from the dairy and feedyard operations were about 27.5 and 1.7 kg hd<sup>-1</sup> d<sup>-1</sup> CO<sub>2</sub>e, respectively, when all three compounds (CO<sub>2</sub>, CH<sub>4</sub>, and N<sub>2</sub>O) were used in estimating CO<sub>2</sub>e. The aggregate summer GHG CO<sub>2</sub>e in terms of kg hd<sup>-1</sup> d<sup>-1</sup> estimated from the dairy was about 16 times higher than that from the feedyard. It was estimated that about 76% of the aggregate GHG CO<sub>2</sub>e was obtained from CH<sub>4</sub> and 4% from N<sub>2</sub>O at this dairy operation. In contrast, the contributions of CH<sub>4</sub> and N<sub>2</sub>O to the aggregate GHG CO<sub>2</sub>e were 6 and 12%, respectively, from the feedyard operation. This was because the low CH<sub>4</sub> emissions from the runoff holding pond attributed to lower aggregate CO<sub>2</sub>e from the feedyard operation.

Based on the GHG ERs for this dairy with 6,950 animals (milking cows and heifers), an estimated total GHG emission during the summer was approximately 191 tons of GHG CO<sub>2</sub>e per day. For the feedyard with 40,000 cattle heads, an estimated summer GHG emission was about 68 tons of CO<sub>2</sub>e per day. The summer GHG emission estimated from the dairy operation was approximately 3 times higher than that from the feedyard operation. Greenhouse gas emissions depend on animal type and growth stage due to different diets, feed conversion mechanisms (feed digestibility), and the manure management [3]. Higher aggregate GHG CO<sub>2</sub>e emissions from the dairy compared to the feedyard were driven by differences in CH<sub>4</sub> emissions. This was due to different manure handling and management processes such as the use of an anaerobic settling basin and lagoons. These sources inherently emit more CH<sub>4</sub> than a feedyard operation. Phetteplace *et al.* [22] also reported higher aggregate GHG emissions (in CO<sub>2</sub>e) from dairy operations relative to feedyards.

#### 3.6.2. Emission Comparison Based on the USEPA Recommendation

The aggregate GHG ER from this study was also compared with that estimated based on the USEPA proposed rule. According to the proposed rule, facilities annually emitting 25,000 metric tons of CO<sub>2</sub>e or more report their GHG emissions to the EPA [1]. Emission rates were estimated based on

the annual GHG CO<sub>2</sub>e emission limit (25,000 metric tons of CO<sub>2</sub>e) imposed by the USEPA and the corresponding threshold population for a particular manure management operation [38]. Per USEPA recommendation henceforth USEPA ER, for a particular type of operation (e.g., dairy or feedyard) with manure management system types (e.g., for dairy: cows with uncovered anaerobic lagoon with solid separation, heifers and calves are on dry lot and for feedyard: steers and heifers on feedlot, and manure composted), the average annual ambient temperature °C (region), and animal population threshold with respect to the emission cap (25,000 metric tons of CO<sub>2</sub>e) were used to estimate the USEPA ER [38]. In this research, a region with an annual average ambient temperature of about 14.5°C [39] and animal population threshold (5,500 and 59,100 for the type of dairy and feedyard, respectively) level below which facilities were not required to report emissions from manure management was chosen [38].

On a “per head” basis, the aggregate USEPA GHG ER (based on annual average) was about 12.45 and 1.16 kg hd<sup>-1</sup> d<sup>-1</sup> CO<sub>2</sub>e for dairy and feedyard operations, respectively [37]. The annual USEPA GHG ER in kg hd<sup>-1</sup> d<sup>-1</sup> CO<sub>2</sub>e for dairy was about 11 times higher than that of the feedyard. Estimated aggregate summer ERs from this study at dairy and feedyard operations were 27.5 and 1.7 kg hd<sup>-1</sup> d<sup>-1</sup> of CO<sub>2</sub>e, respectively. The summer GHG ER at the feedyard based on direct measurement was about 1.5 times higher than the annual USEPA ER based on annual average (1.7 and 1.16 kg hd<sup>-1</sup> d<sup>-1</sup> CO<sub>2</sub>e, respectively). Similarly, aggregate summer GHG CO<sub>2</sub>e at the dairy obtained from the direct measurement was approximately 2.2 times higher than that of the USEPA ER. A recent study reported CH<sub>4</sub> ER from anaerobic lagoons estimated using the USEPA approach may be underestimated by 65% [36]. Higher CH<sub>4</sub> concentrations (Table 2) from anaerobic liquid manure treatment sources (settling basin, primary and secondary lagoons) contributed to high aggregate CO<sub>2</sub>e from the dairy operation.

The proposed USEPA emissions threshold table does not include CO<sub>2</sub> [1]. Therefore, GHG ERs in terms kg of CO<sub>2</sub>e hd<sup>-1</sup> d<sup>-1</sup> was also estimated in our study using CH<sub>4</sub> and N<sub>2</sub>O only. Greenhouse gas ERs estimated from the dairy and feedyard operations were about 22 and 0.31 kg hd<sup>-1</sup> d<sup>-1</sup> CO<sub>2</sub>e when CO<sub>2</sub> was not included in estimating CO<sub>2</sub>e. According to the new calculation, the aggregate dairy GHG ER based on direct measurements was about 1.8 times higher than that of the annual USEPA ER. In contrast, the USEPA ER for feedyard GHG (1.16 kg CO<sub>2</sub>e hd<sup>-1</sup> d<sup>-1</sup>) was about 3.7 times higher than that obtained with the direct measurement (0.31 kg CO<sub>2</sub>e hd<sup>-1</sup> d<sup>-1</sup>). It is well recognized that GHG emissions vary with weather conditions especially with temperature change. Higher temperature in the summer accelerates GHG emissions from same anaerobic manure management operations than those in the winter with lower temperature. Previous research reported that the overall CH<sub>4</sub> and N<sub>2</sub>O ERs during the summer were approximately 5.3 and 2.2 times higher than those in the winter for a free-stall dairy in central Texas [40].

#### 4. Summary and Conclusions

A protocol that consisted of an isolation flux chamber method and a portable GC was used to quantify GHG emissions directly at various ground level area sources at dairy and feedyard facilities during the summer. The measured gas concentrations within and among the sources varied widely due to spatially variable manure loading rates and manure microbial activity. The following results and conclusions can be drawn from this research:

- Aggregate estimated ERs for CH<sub>4</sub>, CO<sub>2</sub>, and N<sub>2</sub>O were 836; 5573; and 3.4 g hd<sup>-1</sup> d<sup>-1</sup>, respectively, from the dairy operation.
- Aggregate estimated ERs for CH<sub>4</sub>, CO<sub>2</sub>, and N<sub>2</sub>O were 3.8; 1399; and 0.68 g hd<sup>-1</sup> d<sup>-1</sup>, respectively, from the feedyard operation.
- Aggregate CH<sub>4</sub>, CO<sub>2</sub>, and N<sub>2</sub>O emissions from the dairy facility were about 220, 4, and 5 times higher, respectively, than those from the feedyard.
- Estimated aggregate ERs from dairy and feedyard operations were 27.5 and 1.7 kg hd<sup>-1</sup> d<sup>-1</sup> of CO<sub>2</sub>e, respectively. An aggregate CO<sub>2</sub>e emission from the dairy facility was about 16 times higher than those from the feedyard operation when CO<sub>2</sub> was used in estimating CO<sub>2</sub>e.
- The aggregate dairy GHG CO<sub>2</sub>e obtained from the direct measurement was about 1.8 times higher than that of the annual USEPA ER when CO<sub>2</sub> was not used in estimating CO<sub>2</sub>e. Measured GHG emissions from feedyard was about 4 lower than that of the USEPA estimates for the feedyard operation (0.27 and 1.16 kg hd<sup>-1</sup> d<sup>-1</sup> CO<sub>2</sub>e, respectively).
- At the dairy operation, about 76% of the total CO<sub>2</sub>e was from CH<sub>4</sub> and 4% from N<sub>2</sub>O. The contributions of CH<sub>4</sub> and N<sub>2</sub>O in the aggregate GHG CO<sub>2</sub>e from the feedyard were about 6 and 12%, respectively.
- At the dairy, CH<sub>4</sub> emissions from the settling basin, primary lagoon, and secondary lagoons contributed about 98% of the aggregate CH<sub>4</sub> emissions and comprised about 24% of the total emitting area (total GLAS).
- At the feedyard, the runoff holding pond and pen sources contributed about 99% of the aggregate CH<sub>4</sub> emission and comprised of about 94% of the total area. The pen surface alone contributed about 93% and 84% of the aggregate CO<sub>2</sub> and N<sub>2</sub>O emissions, respectively, and comprised about 89% of the total GHG emitting area.
- Based on these observations, abatement and management practices that address emissions from pen surfaces, runoff holding pond, and lagoons will likely be most effective for reducing facility-wide GHG emissions.

## Acknowledgements

This research was supported by Grant No. 2009-34466-20025 from the USDA National Institute of Food and Agriculture. The authors would also like to thank the State Initiative through Texas AgriLife Research, the Center for Agricultural Air Quality Engineering and Science (CAAQES), and the Texas Cattle Feeders Association (TCFA) for the funding and continued support in this research.

## References

1. Federal Register. *Mandatory Reporting of Greenhouse Gases*; Proposed rule. Volume 74, Number 68, pp. 16448–16731, 10 April 2009. National Archive and Records Administration: Washington, DC, USA, 2009.
2. IPCC. Chapter 2: Changes in atmospheric constituents and in radiative forcing. In *Climate Change 2007: The Physical Science Basis*; Contribution of Working Group I to the 4th Assessment Report of the Intergovernmental Panel on Climate Change; Cambridge University Press: New York, NY, USA, 2007.



3. Chadwick, D.R.; Pain, B.F.; Brookman, S.K.E. Nitrous oxide and methane emissions following application of animal manures to grassland. *J. Environ. Q.* **2000**, *29*, 277–287.
4. Luo, J.; Sagggar, S. Nitrous oxide and methane emissions from a dairy farm stand-off pad. *Aust. J. Exp. Agric.* **2008**, *48*, 179–182.
5. Sagggar, S.; Bhandral, R.; Hedley, C.B.; Luo, J. A review of emissions of methane, ammonia, and nitrous oxide from animal excreta deposition and farm effluent application in grazed pastures. *N. Z. J. Agric. Res.* **2004**, *47*, 513–544.
6. Craggs, R.; Park, J.; Heubeck, S. Methane emissions from anaerobic ponds on a piggery and a dairy farm in New Zealand. *Aust. J. Exp. Agric.* **2008**, *48*, 142–146.
7. Sedorovich, D.M.; Rotz, C.A.; Richard, T.L. Greenhouse Gas Emissions from Dairy Farms. Presented at the ASABE Annual International Meeting, St. Joseph, MI, USA, 17–20 June 2007; Paper No. 074096.
8. Conner, D.; Rozeboom, D. *Literature Review: A Comparison of Dairy Production*; Department of CARRS, Michigan State University: East Lansing, MI, USA, 17 August 2009.
9. De Klein, C.A.M.; Eckard, R.J. Targeted technologies for nitrous oxide abatement from animal agriculture. *Aust. J. Exp. Agric.* **2008**, *48*, 14–20.
10. Schils, R.L.M.; van Groenigen, J.W.; Velthof, G.L.; Kuikman, P.J. Nitrous oxide emissions from multiple combined applications of fertiliser and cattle slurry to grassland. *Plant Soil* **2008**, *310*, 89–101.
11. Davidson, E.A. The contribution of manure and fertilizer nitrogen to atmospheric nitrous oxide since 1860. *Nat. Geosci.* **2009**, *2*, 659–662.
12. Burns, R.T.; Li, H.; Xin, H.; Gates, R.S.; Overhults, D.G.; Earnest, J.; Moody, L. Greenhouse Gas (GHG) Emissions from Broiler Houses in the Southeastern United States. Presented at the ASABE Annual International Meeting, St. Joseph, MI, USA, 29 June–2 July 2008; Paper No. 084649.
13. U.S. Environmental Protection Agency. *Inventory of U.S. Greenhouse Gas Emissions and Sinks*. Report Number EPA 430-R-08-005; U.S. Government Printing Office: Washington, DC, USA, 2008.
14. Ngwabie, N.M.; Jeppsson, K.-H.; Nimmermark, S.; Swensson, C.; Gustafsson, G. Multi-location measurements of greenhouse gases and emission rates of methane and ammonia from a naturally-ventilated barn for dairy cows. *Biosyst. Eng.* **2009**, *103*, 68–77.
15. Hensen, A.; Groot, T.T.; van den Bulk, W.C.M.; Vermeulen, A.T.; Olesen, J.E.; Schelde, K. Dairy farm CH<sub>4</sub> and N<sub>2</sub>O emissions from square meter to full farm scale. *Agric. Ecosyst. Environ.* **2006**, *112*, 146–152.
16. Jungbluth, T.; Hartung, E.; Brose, G. Greenhouse emissions from animal houses and manure stores. *Nutr. Cycl. Agroecosyst.* **2001**, *60*, 133–145.
17. Kinsman, R.; Saucer, F.D.; Jackson, H.A.; Wolynetz, M.S. Methane and carbon dioxide emissions from dairy cows in full lactation monitored over a six-month period. *J. Dairy Sci.* **1995**, *78*, 2760–2766.
18. Amon, B.; Amon, Th.; Boxberger, J.; Alt, Ch. Emissions of NH<sub>3</sub>, N<sub>2</sub>O, and CH<sub>4</sub> from dairy cows housed in a farmyard manure tying stall (housing, manure storage, manure spreading). *Nutr. Cycling Agroecosyst.* **2001**, *60*, 103–113.
19. Zoe, L.; Chen, D.; Mei, B.; Naylor, T.; Griffith, D.; Hill, J.; Denmead, O.T.; McGinn, S.; Edis, R. Measurement of greenhouse gas emissions from Australian feedlot beef production using

- open-path spectroscopy and atmospheric dispersion modeling. *Aust. J. Exp. Agric.* **2008**, *48*, 244–247.
20. McGinn, S.M.; Chen, D.; Loh, Z.; Hill, J.; Beauchemin, K.A.; Denmead, O.T. Methane emissions from feedlot cattle in Australia and Canada. *Aust. J. Exp. Agric.* **2008**, *48*, 183–185.
  21. Van Haarlem, R.P.; Desjardins, R.L.; Gao, Z.; Flesch, T.K.; Li, X. Methane and ammonia emissions from a beef feedlot in western Canada for a twelve-day period in the fall. *Can. J. Anim. Sci.* **2008**, *88*, 641–649.
  22. Phetteplace, H.W.; Johnson, D.E.; Seidl, A.F. Greenhouse gas emissions from simulated beef and dairy livestock systems in the United States. *Nutr. Cycling Agroecosyst.* **2001**, *60*, 99–102.
  23. Harper, L.A.; Denmead, O.T.; Freney, J.R.; Byers, F.M. Direct measurements of methane emissions from grazing and feedlot cattle. *J. Anim. Sci.* **1999**, *77*, 1392–1401.
  24. Johnson, K.A.; D.E. Johnson, D.E. Methane emissions from cattle. *J. Anim. Sci.* **1995**, *73*, 2483–2492.
  25. Mukhtar, S. *Manure Production and Characteristics: Its Importance to Texas and Animal Feeding Operation*; University libraries digital Texas A&M: College Station, TX, USA, 2009. Available online: <http://tammi.tamu.edu/pubs.html> (accessed on 3 August 2011).
  26. Gholson, A.R.; Albritton, J.R.; Yayanti, R.K.M. *Evaluation for the Flux Chamber Method for Measuring Volatile Organic Emissions from Surface Impoundments*; Project Summary EPA/600/S3-89/008; U.S. Environmental Protection Agency: Washington, DC, USA, 1989.
  27. U.S. Environmental Protection Agency. *Definition and Procedure for the Determination of the Method Detection Limit-Revision 1.11*; 40CFR Part 136; U.S. Government Printing Office: Washington, DC, USA, 1995.
  28. SAS. *SAS User's Guide: Statistics Ver 8*; SAS Institute Inc.: Cary, NC, USA, 1999.
  29. Steel, R.C.D.; Torrie, J.H.; Dickey, D.A. *Principles and Procedures of Statistics: A Biometrical Approach*; McGraw-Hill: Singapore, 1997.
  30. ANOVA Transformed Means. Available online: [http://dawg.utk.edu/diag/interpret\\_transformed\\_means.htm](http://dawg.utk.edu/diag/interpret_transformed_means.htm) (accessed on 4 August 2011).
  31. Husted, S. An open chamber technique for determination of methane emission from stored livestock manure. *Atmos. Environ.* **1993**, *27*, 1635–1642.
  32. Husted, S. Seasonal variations in methane emission from stored slurry and solid manures. *J. Environ. Qual.* **1994**, *23*, 585–592.
  33. Weiske, A.; Vabitsch, A.; Oleson, J.E.; Schelde, K.; Michel, J.; Friedrich, R.; Kaltschmitt, M. Mitigation of greenhouse gas emissions in European conventional and organic dairy farming; *Agric. Ecosyst. Environ.* **2006**, *112*, 221–232.
  34. Osada, T.; Rom, H.B.; Dahl, P. Continuous measurements of nitrous oxide and methane emission in pig units by infrared photoacoustic detection. *Trans. ASAE* **1998**, *41*, 1109–1114.
  35. Mukhtar, S.; Mutlu, A.; Capareda, S.C.; Parnell, C.B. Seasonal and spatial variations of ammonia emissions from an open-lot dairy operations. *J. Air Waste Manag. Assoc.* **2008**, *58*, 369–378.
  36. Lory, J.A.; Massey, R.E.; Zulovich, J.M. An evaluation of the USEPA calculations of greenhouse gas emissions from anaerobic lagoons. *J. Environ. Q.* **2010**, *39*, 776–783.
  37. Coleman, H.W.; Steele, W.G. *Experimental and Uncertainty Analysis of Engineers*; John Wiley & Sons: New York, NY, USA, 1999.

38. Animal Population Threshold Level Below Which Facilities Are Not Required to Report Emission from Manure Management. Available online: [http://www.epa.gov/climatechange/emissions/GHG-calculator/documents/draft\\_table.pdf](http://www.epa.gov/climatechange/emissions/GHG-calculator/documents/draft_table.pdf) (accessed on March 2011).
39. United States Climate, Plainview, Texas. Available online: <http://www.usclimatedata.com/climate.php?location=USTX1059> (accessed on 10 March 2011).
40. Borhan, M.S.; Capareda, S.; Mukhtar, S.; Faulkner, W.B.; McGee, R.; Parnell, C.B. Determining seasonal greenhouse gas emissions from ground level area sources in a dairy operation in central texas. *J. Air Waste Manag. Assoc.* **2011**, *61*, 786–795.

© 2011 by the authors; licensee MDPI, Basel, Switzerland. This article is an open access article distributed under the terms and conditions of the Creative Commons Attribution license (<http://creativecommons.org/licenses/by/3.0/>).