

**NOVEL COLLIMATOR DESIGN FOR EXPERIMENTAL USE AND
MEDICAL APPLICATIONS**

An Undergraduate Research Scholars Thesis

by

BENJAMIN SARAWICHITR

Submitted to the Undergraduate Research Scholars program at
Texas A&M University
in partial fulfillment of the requirements for the designation as an

UNDERGRADUATE RESEARCH SCHOLAR

Approved by Research Advisor:

Dr. John Ford

May 2019

Major: Nuclear Engineering

TABLE OF CONTENTS

	Page
ABSTRACT.....	1
ACKNOWLEDGMENTS	2
NOMENCLATURE	3
CHAPTER	
I. INTRODUCTION	4
Multi-leaf Collimators	5
Variable Aperture Collimators.....	6
Diffraction and Edge Effects	6
II. METHODS	7
Collimator Design.....	7
Monte Carlo Simulation.....	9
III. RESULTS	12
Collimator Design Simulation Results.....	12
Leaf Track Simulation Results.....	13
Design and Leaf Track Comparison	14
IV. CONCLUSION.....	16
REFERENCES	17

ABSTRACT

Iris Multi-leaf Collimator

Benjamin Sarawichitr
Department of Nuclear Engineering
Texas A&M University

Research Advisor: Dr. John Ford
Department of Nuclear Engineering
Texas A&M University

Intensity modulated radiation therapy (IMRT) is a type of radiation therapy that tries to minimize the radiation dose to healthy tissue through the use of various types of collimators that shapes the radiation beam to the shape of the tumor (Ezzell et al.). A series block and wedge collimators are used to square off the beam before a multi-leaf collimator (MLC) shapes the beam to the shape of the tumor. While the MLC can shape the beam to the shape of the tumor, the shaped beam is not to the exact shape of the tumor. This is due to the leaves of the collimator being rectangular creating a stairstep pattern beam shape causing some healthy tissue to receive radiation (Boyer et al.). A variable aperture collimator attempts to solve this issue by having circular contour that matches the smooth contours that tumors have. However, the variable aperture collimator is restricted to solely circles of various sizes to shape the beam (van de Water et al.). Even though this solves the problem of the stairstep pattern of the multi-leaf collimator, it presents its own problem since tumors are not perfect circles, so there will still be mismatch between the prescribed treatment field and the beam shape. A collimator that has the shape variability of the multi-leaf collimator and the smooth contours of the iris collimator might be

able to further reduce the amount of radiation dose healthy tissues receive while maximizing the amount of dose that the tumor receives.

A design that combines a multi-leaf and a variable aperture collimator was developed in order to achieve the goal of maximizing radiation dosage to the tumor and minimizing the dosage to the surrounding healthy tissue. The effects of how the shape of this new design attenuates and shapes a radiation beam was studied by simulating a beam in Monte Carlo N-Particle Transport Code (MCNP) and by creating the design and testing with a radiation beam and using radiochromic film to observe the dose distribution and edge effects.

ACKNOWLEDGEMENTS

I would like to thank my thesis advisor, Dr. John Ford for his guidance and support throughout the course of this project.

Thanks also go to my friends, colleagues, and the Department of Nuclear Engineering faculty and staff for making my time at Texas A&M University a great experience. I also want to extend my gratitude to Michael Kerstetter for teaching me how to mill and for building my prototype

NOMENCLATURE

EBRT	External Beam Radiation Therapy
IMRT	Intensity Modulated Radiation Therapy
MLC	Multi-leaf Collimator
MCNP	Monte Carlo N-Particle Transport Code
VAC	Variable Aperture Collimator

CHAPTER I

INTRODUCTION

The treatment of cancerous tumors involves chemotherapy, radiation therapy, or a combination of the two. Chemotherapy treats the tumors using one or more anti-cancer drugs with an intent to cure the cancer or prolong symptoms. Radiation therapy uses ionizing radiation to control or kill cancerous tumor cells. There are various types of radiation therapy with the three main types being external beam radiation therapy, sealed source radiotherapy, and systematic radioisotope therapy. External beam radiation therapy (EBRT) is the most common radiation treatment and it utilizes an external source of ionizing radiation that is pointed towards a certain part of the body. In contrast, sealed source radiotherapy and systematic radioisotope therapy treats the tumor using a radiation source that is placed inside of the body (Pawlicki, Scanderbeg, and Starkschall). An important aspect of all three types is reducing the amount of radiation the healthy tissue surrounding the tumor receives. Intensity modulated radiotherapy (IMRT) is a type of EBRT that uses collimators to shape the radiation beam to the approximate profile of a tumor and modulates the beam strength based on the prescribed dosage of that profile.

Multi-leaf Collimators

One of the major advantages of IMRT is its ability to shape the beam to the profile of the tumor using a combination of beam blocks and a multi-leaf collimator. A MLC uses multiple pairs of rectangular blocks called leaves to shape the beam. The ends of each leaf are curved in order to attenuate the beam and control the size of the penumbra of the collimated radiation beam. Controlling the penumbra width is important since beam attenuation at the leaf edge can

vary as the leaves move further from the center of the MLC. In order to minimize interleaf leakage, each leaf has a tongue and groove so that they overlap and fit into each other. These leaves are usually made of a tungsten alloy because of tungsten's high density and photon attenuation which are crucial in blocking radiation. Typically, a MLC has about 30 to 80 leaf pairs and each leaf can be moved independently of each other using computer controls to shape the radiation beam to the prescribed treatment field for the tumor.

Variable Aperture Collimators

Variable aperture collimators (VAC) differ from multi-leaf collimators because VACs can only create circular beam shapes. VACs are used in Accuray's CyberKnife systems, and they can have up to 12 collimators that are used to shaped the beam. Typically though, only one or two are used. The main advantage of VACs is the smooth contours it can create; this solves the issue of the stair-step pattern of MLCs. However, tumors are not perfect circles so there will still be a mismatch in the beam shape and the tumor's profile.

Diffraction and Edge Effects

One of the main goals of this project was to observe the edge effects of the design. When the radiation beam comes into contact with the edge of the collimator, edge diffraction occurs. Edge diffraction is the redirection of electromagnetic waves when the waves strike a well-defined object. This creates umbra and penumbra. The Umbra is the shadow that is created when a light source is blocked completely by an object. This is the darkest part of a shadow. The penumbra is the region that is partially blocked by an object.

CHAPTER II

METHODS

Collimator Design

The objectives for this design were to combine the shape variability of an MLC and the smooth contours of a VAC, have each leaf be able to interlock with each other, and be scalable so that more leaves could be used. The leaves needed to be interlocking so that interleaf radiation transmission is minimized. The number of leaves needed to be scalable so that when more leaves are added the design can be more accurate when shaping a radiation beam to the cross section of a tumor. A design was developed by looking at the mechanisms behind camera irises and by taking inspiration from origami. Figure 1 shows the origami model that was the inspiration for this design.

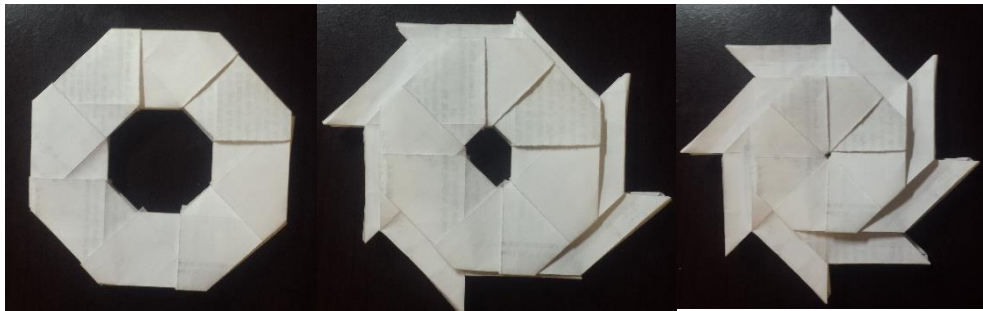

Figure 1. Origami model of the 8-point transforming ninja star that was the inspiration for the design

Each of the objectives were able to be accomplished. The collimator design is able to be shaped into shapes such as octagons, squares, and various irregular shapes. By having an octagonal design, the contours of the design were relatively smooth. Dovetail cuts were made to create tracks that work as a tongue and groove in the design so that each leaf could be moved

independently from each other and be interlocking. Each leaf of the design is a 45° right triangle, so an octagon is formed when all of the leaves are assembled. By using 22.5° triangles, a sixteen-sided polygon is formed when the leaves are assembled together, so the design is scalable by reducing the angle of the leaves. A model was created in SolidWorks and was machined using a 6061-aluminum alloy. A leaf of the design can be seen in Figure 2 while the collimator assembly can be seen in Figure 3. The 6061-aluminum alloy was chosen because of its workability since precise cuts needed to be made.

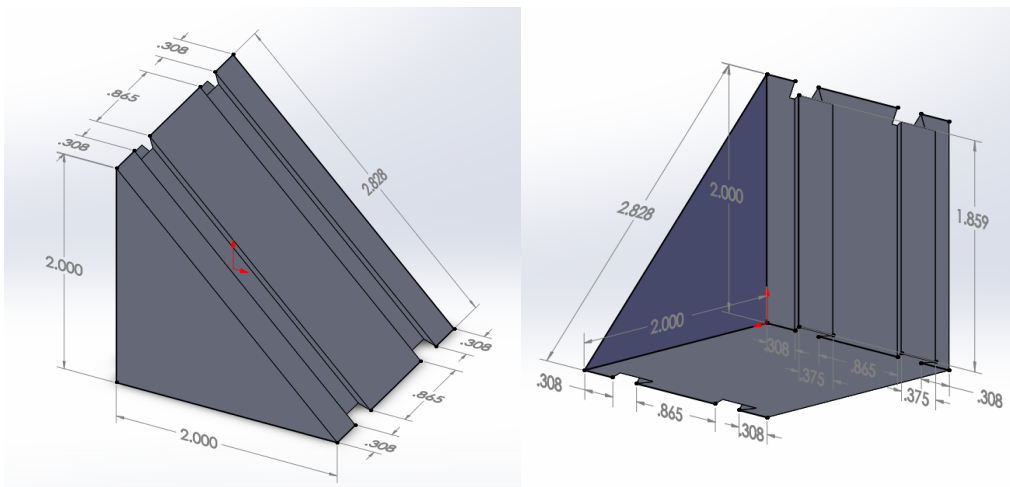

Figure 2. New collimator leaf dimensions created using SolidWorks. All values are in inches.

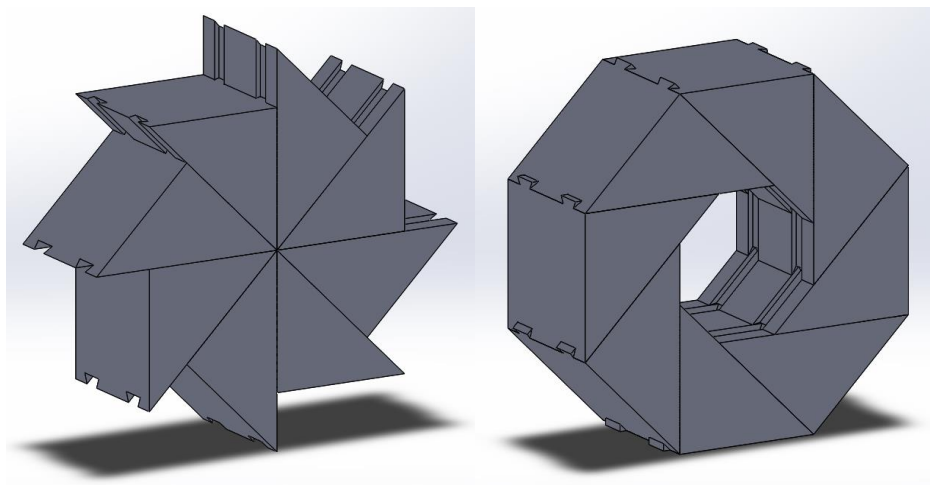

Figure 3. New collimator design when fully closed and fully opened.

Monte Carlo Simulation

Monte Carlo methods were used to create a simulation of the design. Monte Carlo methods are computation algorithms that rely on repeated random sampling to obtain results. Simulations ran using these methods sample from the probability distribution of certain events and produce results of all of the possible outcomes of a scenario. These results are then analyzed and the probability of various outcomes are given. Monte Carlo N-Particle Transport Code (MCNP) (Werner, et. al.) is a Monte Carlos simulation method that can simulate particles such as electron and photons and how they interact with various materials. MCNP was used to simulate the effects of a radiation beam of photons on the collimator design.

Collimator Design Simulation

The design was simulated using MCNP. While the dimensions for the design was created using inches, the simulation in MCNP needed to be done in centimeters. The collimator was simulated using both aluminum and tungsten. Aluminum was simulated because the prototype that was created was made out of an aluminum allot. Tungsten was simulated because a tungsten alloy is the material typically used for collimators. The composition of both the aluminum and tungsten alloy were simplified to just pure aluminum and tungsten since there are various alloys that could be used and the scope of this study was not to study the material effects. The inner tracks of the design were ignored in this simulation because of the difficulty in defining the geometry of the tracks in MCNP. A 4 MeV radiation beam with a radius of 5 cm was placed 50 cm above the collimator design. Point detectors were placed 5 cm below the design in the center and 4 cm from the center detector in each direction Figure 4 shows how the design and how it was simulated in MCNP. This simulation was run to measure the amount of dose delivered to the center of the design and through the material of the design.

Two more simulations were ran with radiograph tallies instead of point detectors. One of the simulations was ran with the radiograph tally below the design and the other simulation was ran with the radiograph tally in the cross section of the design. These simulations were ran in order to produce radiograph images that show how the collimator affected the radiation beam.

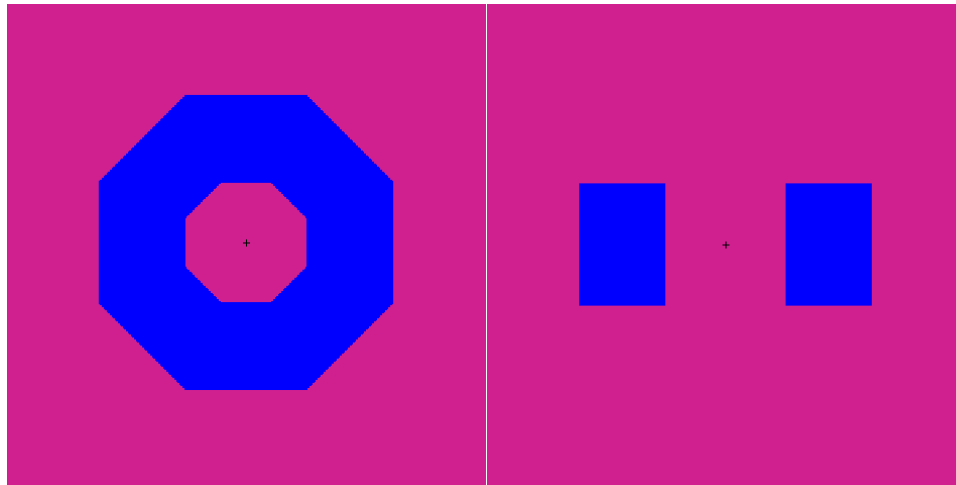

Figure 4. Top down and cross-sectional view of the MCNP simulation of the design.

Leaf Track Simulation

Another simulation in MCNP was ran to observe the effects of the tracks in opposing leaf pairs. This was done with only one pair of leaves since it was simpler to define the geometry of the tracks with just two leaves than the entire collimator design. Figure 5 shows how the leaf pair was simulated in MCNP. Even though each leaf is a triangular prism, the simulation used rectangular prisms. This was done because the objective of this simulation was not to see the effects of the shape of each leaf, so the effective shape of the leaf in the collimator was used. The same 4 MeV radiation beam used in the first simulation was used in this simulation. Point detectors were not used in this simulation because the objective of this simulation was not to measure the dose, but to see how the tracks affected the shape of the radiation beam. Radiograph

tallies were used instead and were placed 5 cm below the leaves and through the cross section of the design.

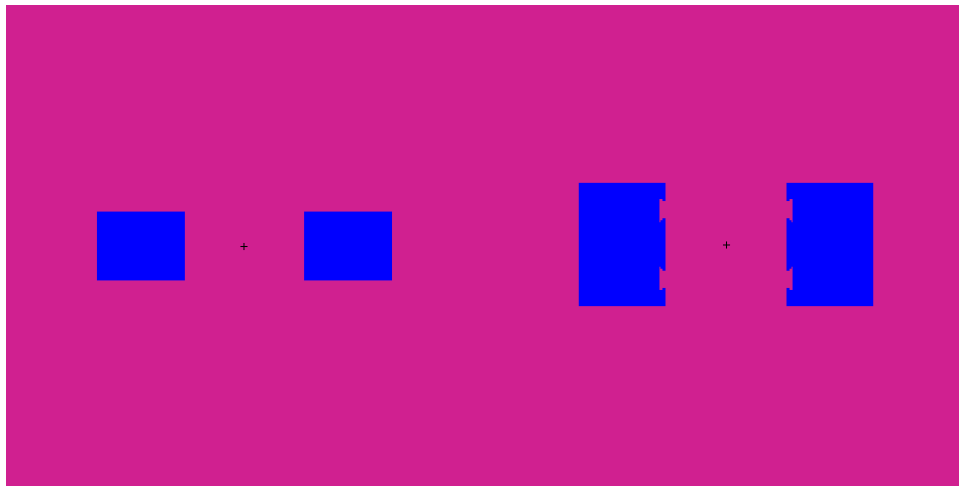

Figure 5. Top down and cross-sectional view of the leaf track MCNP simulation.

CHAPTER III

RESULTS

Collimator Design Simulation Results

Material Comparison

The collimator design was simulated with aluminum and then tungsten as the material. Figure 6 shows the radiograph image that was produced from the simulations. The aluminum collimator was not able to affect the radiation beam. This result was expected since aluminum is not a good photon attenuator. However, the tungsten collimator was able to have an effect on the radiation beam. The amount of photon flux was maximized through the center of the collimator and minimized through the material of the collimator. From these results, the decision was made to run the rest of the simulations with tungsten as the material of the design as it was more effective than the aluminum. However, when in the future when testing the aluminum prototype a lower energy radiation beam will have to be used. From the simulation that was ran with the point detectors, the dose that was delivered to the center of the design was 2311.65 R/hr and the dose that was delivered through the material was 91.10 – 94.12 R/hr. The amount of dose was maximized to the center of the design and minimized through the material.

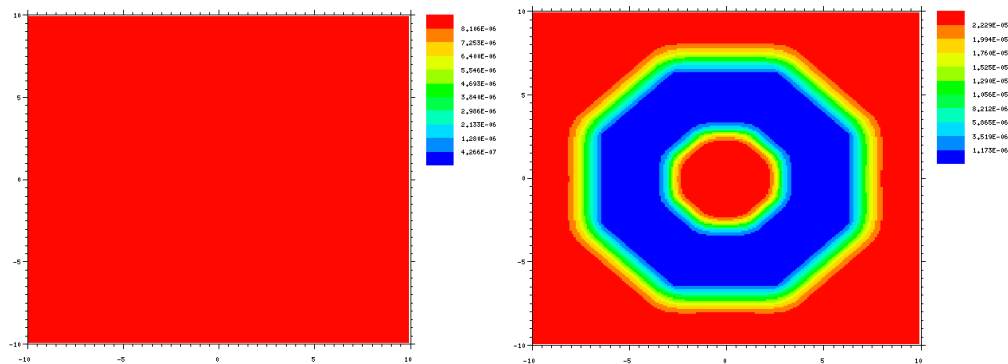

Figure 6. Radiograph image of the design simulation with aluminum and tungsten.

Collimated Beam Shape

The collimated beam shape of the tungsten design is shown in Figure 7. The figure shows that the collimator creates two umbra that are because of the collimator blocking the radiation beam. The collimator ends at about the 6 cm tick mark on the x axis. The penumbra region can be seen before the 6 cm tick mark as the radiation beam if diffracted to the area behind the collimator. This result was expected since radiation can be diffracted along edges of an object. Results also show that the collimator was effective in shaping the radiation beam.

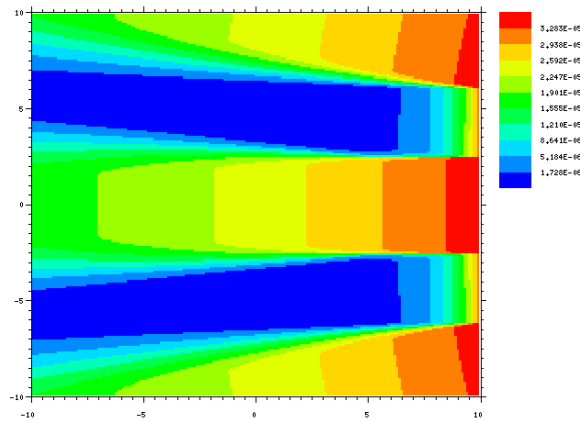

Figure 7. Radiograph image of the collimated beam shape.

Leaf Track Simulation Results

From the leaf track simulation, the radiograph image in Figure 8 was produced. Again, the photon flux was maximized through the center of the leaves and minimized through the material of the leaves. Figure 9 shows the radiograph image of beam shape. In general, it looks very similar to the beam shape produced by the collimator. Both of the beam shapes have the same umbra and penumbra regions.

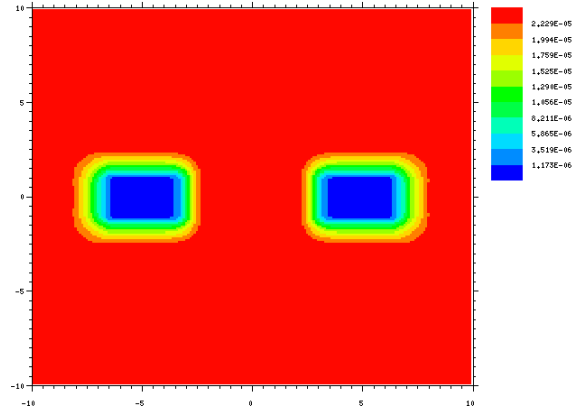

Figure 8. Top down radiograph image of the leaf track simulation in MCNP

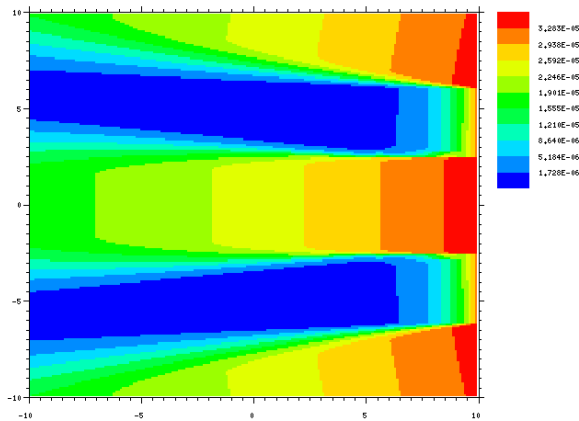

Figure 9. Radiograph image of the leaf track beam shape.

Design and Leaf Track Comparison

Looking closely at the radiograph images of both beam shapes, there is a very slight difference near the bottom edge of the collimator and leaf images. At about 6.5 cm on the x axis, there is a slight fluctuation in flux that can be seen. Figure 10 is a zoomed in image highlighting the fluctuation in flux.

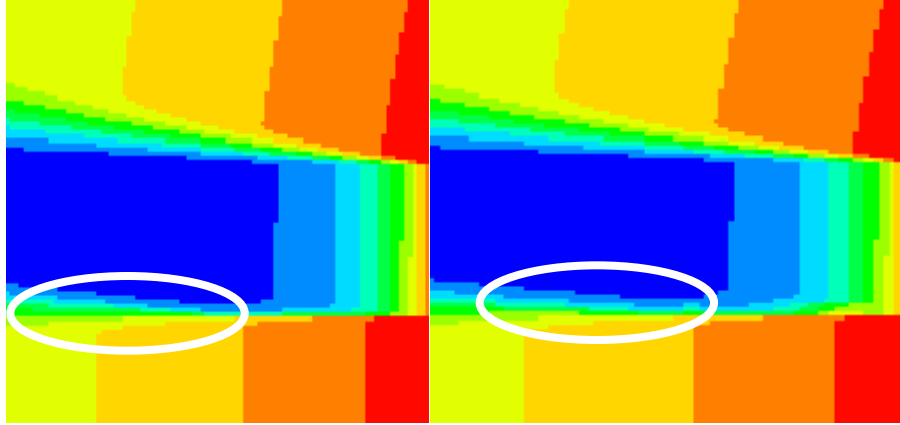

Figure 10. The left image is the collimated beam shape of the full design without track while on the right image is the collimated beam shape of the leaf pair with track

CHAPTER IV

CONCLUSION

The collimator was able to shape the radiation beam maximizing dose and photon flux in the center of the design and minimizing it through the material. Overall, it can be said that that the design was very effective. The simulation of the leaf tracks shows that there were small differences between the collimator simulation and the leaf track simulation. Both simulations showed that both of the beam shapes had the same umbra and penumbra regions. The small fluctuations in photon flux because of the tracks were very minimal and did not have a great effect on the general beam shape, so it is reasonable to say that the track had little to no effect on the beam shape.

Further studies need to be done in order to determine how the tracks would affect the design. A simulation may need to be done with the collimator design having all of the tracks present. Real life testing of the prototype could also accomplish this study. By placing the prototype in a medical radiation beam with radiochromic film would allow for the observation of the edge effects if any and the dose distribution. More research is also needed to develop the mechanism that will move each of the leaves in the collimator as well as determining what kind leaf movement algorithms would be the most effective.

REFERENCES

- Aginian, M. A., et al. Coherent X-Ray Diffraction Radiation Produced by Microbunched Beams Passing Close to the Edge of a Slab. Vol. 47, no. 2, 2012, pp. 53–57, doi:10.3103/S1068337212020028.
- Boyer, Arthur, et al. BASIC APPLICATIONS OF MULTILEAF COLLIMATORS Report of Task Group No. 50 Radiation Therapy Committee. 2001, www.medicalphysics.org.
- Ceylan, Cemile, et al. “Original Article Dosimetric and Physical Comparison of IMRT and CyberKnife Plans in the Treatment of Localized Prostate Cancer.” Reports of Practical Oncology and Radiotherapy, vol. 15, no. 6, Wielkopolskie Centrum Onkologii, 2010, pp. 181–89, doi:10.1016/j.rpor.2010.10.003.
- Echner, G. G., et al. “The Design, Physical Properties and Clinical Utility of an Iris Collimator for Robotic Radiosurgery.” Physics in Medicine and Biology, vol. 54, no. 18, IOP Publishing, Sept. 2009, pp. 5359–80, doi:10.1088/0031-9155/54/18/001.
- Ezzell, Gary A., et al. “Guidance Document on Delivery, Treatment Planning, and Clinical Implementation of IMRT: Report of the IMRT Subcommittee of the AAPM Radiation Therapy Committee.” Medical Physics, vol. 30, no. 8, 2003, pp. 2089–115, doi:10.1118/1.1591194.
- Hwang, Ing-ming, et al. An Effective Method for Smoothing the Staggered Dose Distribution of Multi-Leaf Collimator Field Edge. Vol. 495, 2002, pp. 132–38.
- Pawlicki, Todd, et al. Hendee’s Radiation Therapy Physics. 2016.
- SolidWorks [Computer software]. (2018). Retrieved from <http://www.solidworks.com>
- van de Water, Steven, et al. “Variable Circular Collimator in Robotic Radiosurgery: A Time-Efficient Alternative to a Mini-Multileaf Collimator?” International Journal of Radiation Oncology*Biophysics, vol. 81, no. 3, Elsevier, Nov. 2011, pp. 863–70, doi:10.1016/J.IJROBP.2010.12.052.

Werner, C.J. et al., "MCNP6.2 Release Notes", Los Alamos National Laboratory, report LA-UR-18-20808 (2018).

Werner, C.J. (editor), "MCNP User's Manual - Code Version 6.2", Los Alamos National Laboratory, report LA-UR-17-29981 (2017).