



47<sup>TH</sup> TURBOMACHINERY & 34<sup>TH</sup> PUMP SYMPOSIA  
HOUSTON, TEXAS | SEPTEMBER 17-20, 2018  
GEORGE R. BROWN CONVENTION CENTER

## Development of New Heat Treatment Method to impart high creep strength and high toughness to rotor material for condensing steam turbine

### **Mayank Jain**

Engineer, Turbine Engineering & Design Section  
Mitsubishi Heavy Industries Compressor Corporation  
Hiroshima, Japan

### **Yuzo Tsurusaki**

Engineer, Turbine Engineering & Design Section  
Mitsubishi Heavy Industries Compressor Corporation  
Hiroshima, Japan

### **Kyoichi Ikeno**

Engineer, Turbine Engineering & Design Section  
Mitsubishi Heavy Industries Compressor Corporation  
Hiroshima, Japan

### **Katsumi Terada**

Engineer, Turbine Engineering & Design Section  
Mitsubishi Heavy Industries Compressor Corporation  
Hiroshima, Japan

### **Shinya Morioka**

Mitsubishi Heavy Industries Ltd.  
Research & Innovation Center  
Hiroshima, Japan



*Mayank Jain is Engineer, Turbine Engineering & Design Section, Mitsubishi Heavy Industries Compressor Corporation, Hiroshima, Japan. He has 2 year experience as a turbine engineer. Mr. Jain has B.Tech degree in Mechanical Engineering from Indian Institute of Technology (IIT), Kanpur, India.*



*Katsumi Terada is Engineer in Turbine Engineering & Design Section, Mitsubishi Heavy Industries Compressor Corporation, Hiroshima, Japan. He has 12 years of experience as a turbine engineer. Mr. Terada graduated from Kurume National College of Technology (Mechanical Engineering).*



*Yuzo Tsurusaki is Acting Manager in Turbine Engineering & Design Section, Mitsubishi Heavy Industries Compressor Corporation, Hiroshima, Japan. He has 17 years of experience as a turbine engineer. Mr. graduated from Kurume National College of Technology (Mechanical Engineering).*



*Shinya Morioka is Senior Metallurgist in No. 1 Material Laboratory, Research & Innovation Center, Mitsubishi Heavy Industries, Ltd. He is engaged in material research and development of various machineries for 9 years. Mr. Morioka has M.S. degrees in Metallurgical Engineering from Kyushu University in Japan.*



*Kyoichi Ikeno is Manager, Turbine Engineering & Design Section, Mitsubishi Heavy Industries Compressor Corporation, Hiroshima, Japan. He has 19 years of R&D experience for mechanical drive steam turbines. Mr. Ikeno has B.S. and M.S. degrees in Mechanical Engineering, Miyazaki University and Kyushu University, respectively.*



47<sup>TH</sup> TURBOMACHINERY & 34<sup>TH</sup> PUMP SYMPOSIA  
HOUSTON, TEXAS | SEPTEMBER 17-20, 2018  
GEORGE R. BROWN CONVENTION CENTER

## ABSTRACT

Higher temperatures in the HP section of the condensing Turbine require a rotor with high creep strength while low temperatures in the LP section require the rotor to have high toughness. The design basis for current rotor material, Ni-1.25Cr-Mo-V forged steel was high toughness at low temperatures. This led to rotor having insufficient creep strength in very high temperature region around control stage which limited the maximum allowable temperature of inlet steam thereby limiting the efficiency of the Turbine.

This paper highlights the development of new heat treatment method to improve Ni-2.25Cr-Mo-V forged steel (10325MTE) as rotor material. The creep strength of the material was found to be equivalent to 1Cr-Mo-V (used for back-pressure steam turbine). The toughness of the material is equivalent to Ni-1.25Cr-Mo-V. The conventional heat treatment method for MTE rotor material with separate treatments for HP and LP section to have different mechanical properties can't be applied for rotors with small/medium bearing span so a new heat treatment technique for the rotor was developed.

To improve the mechanical properties of the material, heat treatment simulations were performed. Oil quenching followed by Tempering was carried out to develop the required creep strength and toughness of the material. A series of tests were done on the rotor. These tests evaluated the creep strength at high temperatures and toughness low temperatures. Mass effect on heat treatment was evaluated by carrying out various mechanical strength tests (tensile, impact tests etc.). SCC (Stress Corrosion Cracking) susceptibility was evaluated in an accumulated corrosive environment (high temperature water) using SSRT (Slow Strain Rate Test). The results of the tests indicated that the material has required creep strength at high temperatures and toughness at low temperatures among other properties. The paper also presents the improvement in the efficiency of HP part and the life of the rotor at high temperature. This paper presents the detailed investigation procedure, new heat treatment method and test results along with efficiency improvement for the HP section.

## INTRODUCTION

In today's turbomachinery business, great emphasis is placed on improving the efficiency and reliability of the rotating equipment. Efficiency improvements lead to energy savings, which is an important factor in today's marketplace. One way of accomplishing efficiency improvement is by decreasing control stage load (increase after control stage temperature). The temperature after control stage is limited by the creep strength of rotor material thereby limiting the efficiency of Turbine.

The rotor in a condensing turbine should have high creep strength for high temperature stages and high toughness for low temperature stages. The current rotor material for high temperature is 2-1-S, a Ni-1.25Cr-Mo-V alloy which has high toughness at low temperatures (50% FATT or FATT<sub>50</sub> around 40°C) but low creep strength at high temperatures. A large thermal drop across control stage is required as excessive stress in the first stage disk limits the maximum temperature to around 480°C which in turn limits the max. allowable inlet temperature for steam turbines. Another rotor material 1-3-S, a 1Cr-Mo-V with excellent creep strength at high temperatures, mainly used in back-pressure Turbines but can't be used in condensing Turbines due to insufficient toughness at low temperatures (FATT<sub>50</sub> around 80°C).

Fracture Appearance Transition Temperature (FATT<sub>50</sub>) is the temperature at which the fracture surface is 50% ductile and 50% brittle.

## TARGET

The target of the study was to develop/improve rotor material for high-temperature and high-pressure turbines with creep strength equivalent to 1-3-S rotor material at high temperatures and toughness equivalent to 2-1-S rotor material at low temperatures. Rotor material 10325MTE, a Ni-2.25Cr-Mo-V alloy was found to have similar properties. A new heat treatment method was developed to improve the mechanical properties of the material as conventional heat treatment method was insufficient for rotors with short/medium bearing spans.



	Max. Temperature	Low temperature toughness
2-1-S (Ni-1.25Cr-Mo-V)	Not great Limit around 480°C	Good (FATT <sub>50</sub> around 40°C)
1-3-S (1Cr-Mo-V)	Good Limit > 500°C	Bad (FATT <sub>50</sub> around 80°C)
10325MTE (Ni-2.25Cr-Mo-V)	Around 510°C	FATT <sub>50</sub> around 40°C



Table 1: Mechanical properties of rotor material

	C	Si	Mn	P	S	Ni	Cr	Mo	V
Ni-1.25Cr-Mo-V	0.25~0.33	0.15~0.35	0.35~0.65	≤0.015	≤0.015	1.00~1.50	1.00~1.50	0.40~0.60	0.05~0.15
1Cr-Mo-V	0.27~0.37	0.15~0.35	0.70~1.00	≤0.015	≤0.015	≤0.50	0.85~1.25	1.00~1.50	0.20~0.30
Ni-2.25Cr-Mo-V	0.21~0.30	≤0.10	0.35~1.00	≤0.010	≤0.003	0.50~0.95	2.00~2.50	1.00~1.25	0.21~0.29

Table 2: Chemical composition of rotor material

The technical basis for development, strength evaluation and test results of a study undertaken to develop new heat treatment method to improve the mechanical properties of rotor material are presented.

### LIMITATION OF CONVENTIONAL HEAT TREATMENT METHOD

The rotor material 10325MTE used a conventional heat treatment method to impart different mechanical properties using separate heat treatment for HP and LP section. A 50 mm plate was inserted around the center part of rotor to separate the HP and LP portion for respective quenching methods. The transition zone with mixed effects estimated using FEM analysis is approximately 500 mm on both sides of the plate. This method couldn't be applied to rotors with small/medium bearing spans as minimum transition area of 1050mm couldn't be kept. The transition area for HP and LP sections with conventional heat treatment method is shown in Figure 1.

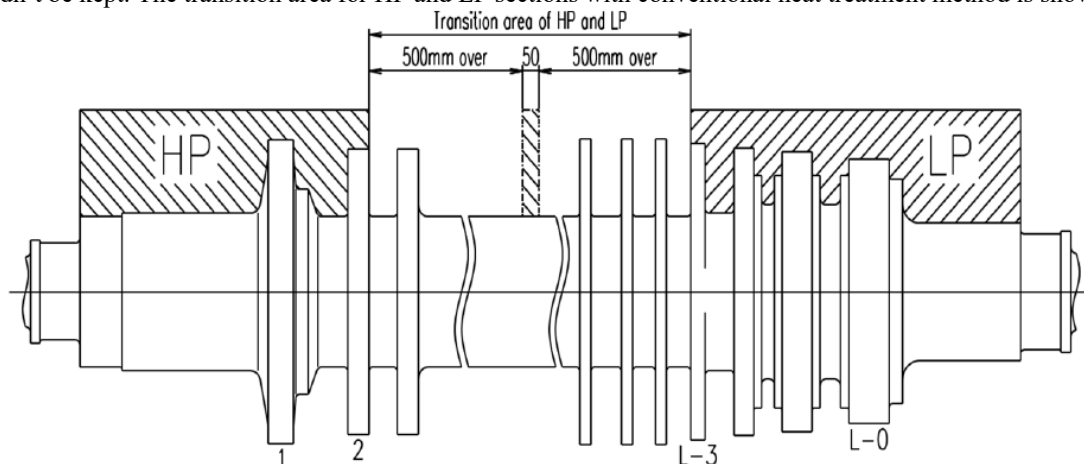

Figure 1: Minimum transition area with conventional heat treatment method

Single heat treatment method was developed so that the material can be used for steam turbine rotor to achieve the required creep strength and toughness. Lab simulations were performed to determine the heat treatment conditions and cooling rate.



## DETERMINATION OF HEAT TREATMENT CONDITIONS

Proper heat treating requires precise control over heating temperature and cooling rate. Quenching is the process of cooling a metal at a rapid rate. This is done here to produce a martensite or bainite transformation. To harden by quenching, a metal must be heated above the upper critical temperature and then quickly cooled. Cooling speeds, from fastest to slowest, go from brine, polymer (i.e. mixtures of water + glycol polymers), fresh water, oil, and forced air. Untempered quenched steel, while very hard, is too brittle to be useful for most applications. A method for alleviating this problem is called tempering. Most applications require that quenched parts be tempered. Tempering consists of heating steel below the lower critical temperature, (depending on the desired results), to impart some toughness to the material.

Lab simulations were conducted to determine quenching and tempering conditions. The conventional type heat treatment used blast cooling for HP section and water cooling for LP section as shown in Table 3. For rotors with small/medium bearing spans, drum diameter is less than 1000 mm so the cooling rate at center should be faster. FEM analysis was conducted to estimate the cooling rate distribution at core of rotor for different drum diameters and different heat treatment methods. For each cooling method, it was assumed that the surface of rotor for different drum diameter will have same cooling rate. The test pieces simulated the cooling rate at peripheral and core of rotor with varying drum diameter ( $\phi 500$ ,  $\phi 1000$ ,  $\phi 1500$ ) as shown in Figure 2.

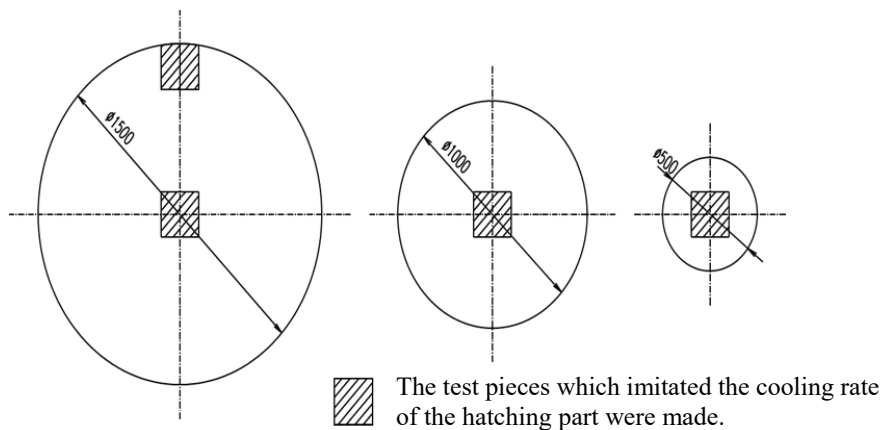

Figure 2: Lab test pieces

Creep-stress rupture data for high-temperature creep-resistant alloys are often plotted as log stress to rupture versus a combination of log time to rupture and temperature. One of the most common time-temperature parameters used to present this kind of data is the Larson-Miller (L.M.) parameter. The Larson-Miller parameter (LMP) was used to predict the lifetime of the particular material for various heat treatment methods using a correlative approach based on the Arrhenius rate equation. The value of the parameter is:

$$P(L.M.) = T[\log t_r + 20] * 10^{-3}$$

The creep strength at peripheral of rotor for different heat treatment methods was predicted using hit and trial basis on lab test pieces which imitated the cooling rate at the peripheral for different quenching methods. Based on the lab test results, we were able to plot the LMP curve. Larson-Miller parameter for all quenching methods was larger than the minimum criteria [minimum rupture time based on 20 years lifetime excluding design margin]. It was concluded that all quenching methods satisfied the creep strength criteria although water cooling was very close to the limit. The summary for creep strength for conventional and new heat treatment is shown in Table 3.

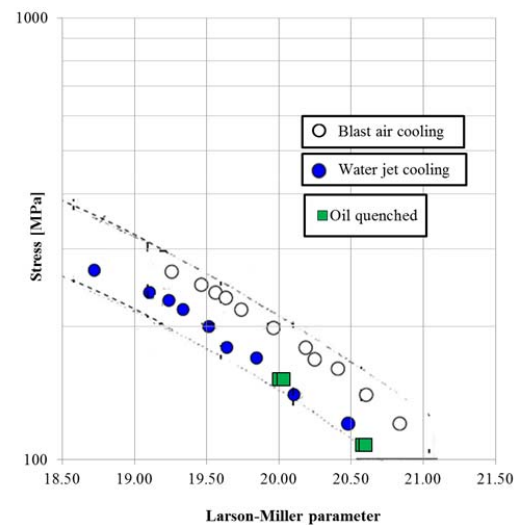

Figure 3: LMP for different quenching methods



FEM results and lab tests predicted the cooling rate at core for different drum diameters and the results are shown in Table 3.

Imparted Properties	Heat treatment methods	Conventional Drum diameter $\phi 1000 \sim 2000$		Single heat treatment (Predicted) Drum diameter $< \phi 1000$	
		Result	Cooling rate (at core) ( $^{\circ}\text{C}/\text{min}$ )	Result	Cooling rate (at core) ( $^{\circ}\text{C}/\text{min}$ )
Creep strength (at high temp.) *1	Blast cooling	Best	-	Best	-
	Oil cooling	Good	-	Good	-
	Water cooling	Possible *2	-	Possible *2	-
Toughness (at low temp.)	Blast cooling	Impossible	$< 0.8$	Impossible	$0.8 \sim 1.4$
	Oil cooling	Impossible *3	$0.7 \sim 1.6$	Good *4	$1.6 \sim 3.3$
	Water cooling	Good	$0.8 \sim 2.5$	Best	$2.5 \sim 6.1$

Table 3: Heat Treatment comparison for conventional and new heat treatment method

NOTE:

\*1 Test result for creep rupture does not depend on rotor size as test piece is taken from the periphery of the material.

\*2 It was confirmed that the test piece has creep property near the lower limit of acceptable range and it conforms to material specifications.

\*3 Due to slow cooling rate, quenching effect is not enough at the core of the rotor and the test results for FATT<sub>50</sub> didn't satisfy the requirement of material specification.

\*4 It is expected that the oil cooling should be acceptable for low-diameter rotor as it meets the criteria of material specifications due to adequate cooling rate.

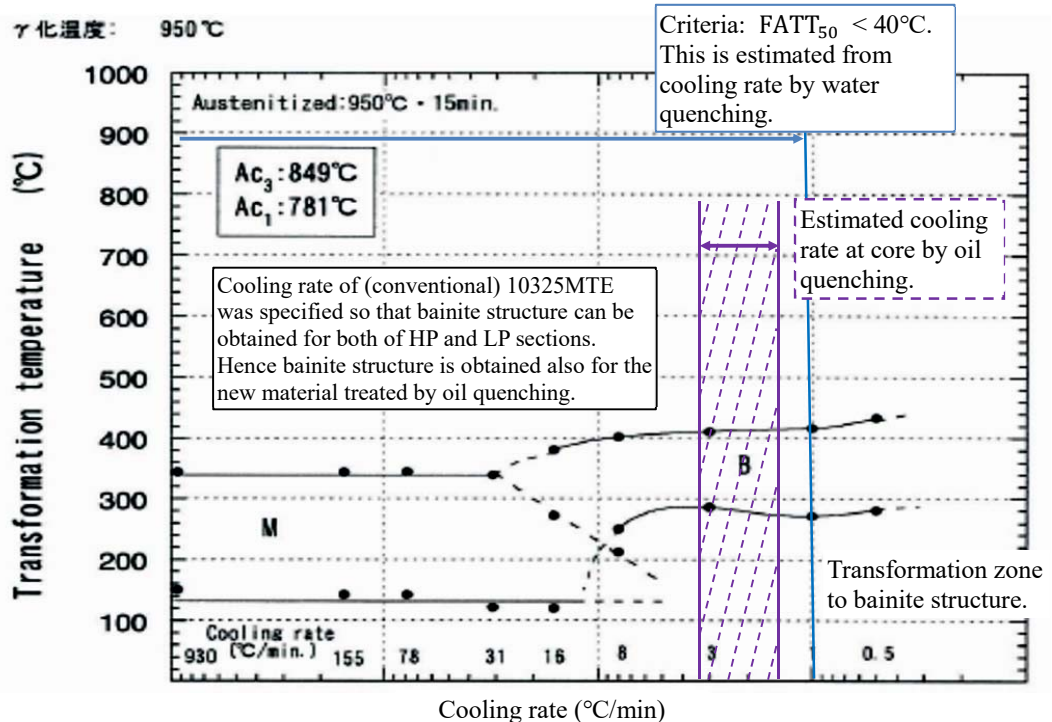

Fig 4: Continuous Cooling transformation curve for 10325MTE rotor material



Continuous Cooling Transformation (CCT) curve for 10325MTE material predicts the required cooling rate for transformation into Bainite structure with the target of  $FATT_{50} < 40^{\circ}C$ . Based on FEM result for different quenching method and estimated cooling rate from CCT curve, oil quenching which has a cooling rate between blast cooling and water cooling. For rotors with small diameter, the cooling rate at the center was faster so it was predicted that HP section and LP section of rotor can possess the required characteristics by oil quenching.

### TEMPERING PARAMETER AND LAB TESTS

In order to establish heat treatment conditions, test pieces were prepared through oil quenching at  $950 \pm 10^{\circ}C$ . Tempering was done at 4 conditions ( $645^{\circ}C$ ,  $655^{\circ}C$ ,  $665^{\circ}C$  and  $675^{\circ}C$ ) on different test pieces for 10 hrs. Test pieces were manufactured by simulating the cooling rate at the core of rotor for  $\phi 500$ ,  $\phi 1000$ , and  $\phi 1500$  rotor. For surface (periphery) of rotor, test piece was simulated from  $\phi 1500$  rotor as it was assumed that cooling rate at peripheral will be same for all size rotors. The toughness was at the core of rotor is severe than peripheral as the cooling rate at the core is lower. Similarly, creep strength at surface is severe as the cooling rate is higher at surface compared to core. Hence, the creep strength tests were only performed at the test piece taken from the peripheral of rotor. The various test performed on samples along with the target are summarized in the below table:

Test method	Description	Target
Tensile test	1 test piece per condition. For measurement of Mechanical properties.	Same as 2-1-S (Ni-1.25Cr-Mo-V alloy)
Charpy impact test	2 test pieces per condition. For measurement of Absorbed energy.	
$FATT_{50}$	6 test pieces per condition. For measurement of $FATT_{50}$ .	
Microstructure observation	For confirmation of no Ferrite structure.	-
Creep rupture test	4 pieces picked up from the periphery of material. For checking material property in high- temperature environment by means of short time creep rupture test.	Same as 1-3-S (1Cr-Mo-V alloy)

Table 4: Description of various tests

The lab test for  $FATT_{50}$  measurement and short-duration creep rupture test results are shown in the table below:

		Target		Lab test results									
		Periphery	Core	Periphery		Core of $\phi 500$ piece		Core of $\phi 1000$ piece		→	Core of $\phi 1500$ piece	→	
Temperature of Tempering process	[ $^{\circ}C$ ]			665	675	665	675	665		675	665		675
Temper parameter	[—]			19698	19908	19698	19908	19698		19908	19698		19908
$\sigma_y$	[MPa]	$\geq 637$	$\geq 578$	709	665	736	652	736		649	712		666
$\sigma_{ts}$	[MPa]	$\geq 784$	$\geq 706$	839	796	866	786	873		783	847		801
Elongation	[%]	$\geq 15$	$\geq 14$	21.2	21.2	20.6	19.4	17.4		19.6	17.0		19.6
Reduction of area	[%]	$\geq 40$	$\geq 36$	70.8	73.0	70.8	75.0	66.4		73.0	61.6		70.8
Charpy absorbed energy	[J/cm <sup>2</sup> ]	$\geq 49.1$	$\geq 44.2$	263.0	288.0	189.0	277.0	122.0		266.0	156.0		189.0
				253.0	284.0	193.0	262.0	124.0		233.0	145.0		181.0
$FATT_{50}$	[ $^{\circ}C$ ]	<40	<44	-50	-85	5	-25	5		-5	45		10

Table 5: Laboratory test results



The results from the lab tests indicated that  $FATT_{50}$  was  $-25^{\circ}\text{C}$  to  $5^{\circ}\text{C}$  for tempering conditions around  $665^{\circ}\text{C}$  and  $675^{\circ}\text{C}$  for  $\phi 500$  and  $\phi 1000$  test piece. However, low temperature toughness ( $FATT_{50}$ ) decreased as the diameter becomes larger and  $FATT_{50}$  value was  $45^{\circ}\text{C}$  for test piece from the core of  $\phi 1500$  rotor.

Temper parameter is defined as:  
 $[T(^{\circ}\text{C}) + 273] * [20 + \log(t)]$

The temperature was calculated to keep the temper parameter within the range of 19,698 and 19,908. The tempering conditions for different test pieces are shown in Figure 5.

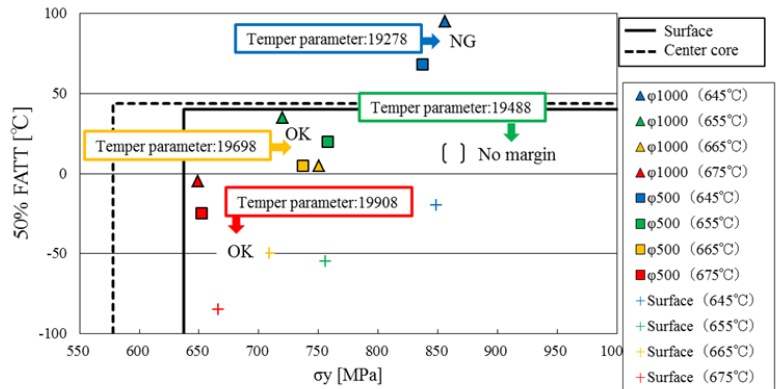

Figure 5: Allowable temper parameter values

Based on temper parameter range of 19,698 and 19,908, a curve depicting Tempering temperature and retention time was plotted to give an estimate of the available Tempering parameters.

Based on the above results, short duration creep rupture test was performed on the test piece taken from the peripheral of  $\phi 1500$  rotor. As the creep strength mainly depends on grain size which is decided by quenching conditions, it was predicted that the tempering parameter has a little effect on creep strength. Tests were carried out at different temperatures and varying stress, the results are shown in the Table 6. The creep strength at varying conditions was above the minimum acceptable limit.

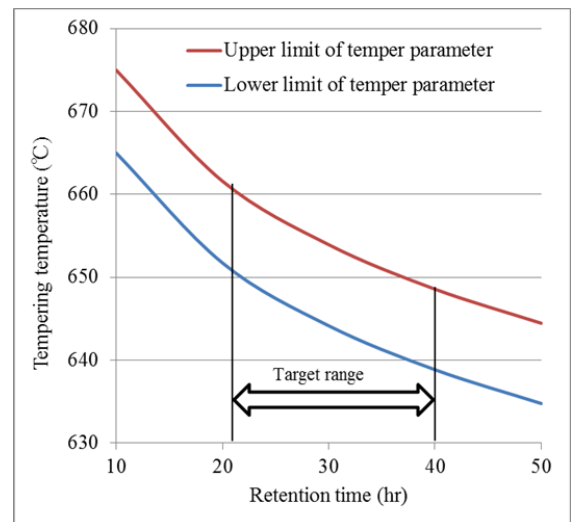

Figure 6: Tempering temperature vs retention time

Test temperature ( $^{\circ}\text{C}$ )	Applied stress (MPa)	Rupture time			
		Specified lower limit (Hr)	LMP* $10^3$ (specified) (—)	Actual rupture time (Hr)	LMP* $10^3$ (Actual) (—)
538	310	102	17849	185	18059
538	338	38	17501	65	17690
593	221	67	18901	103	19063
593	265	18	18901	103	19063

Table 6: Short duration creep rupture test result

Based on the creep rupture test and toughness test results, it was concluded that quenching temperature can be set at  $950 \pm 10^{\circ}\text{C}$  for oil cooling along with minimum tempering temperature of  $630^{\circ}\text{C}$  for furnace cooling for specimen with diameter less than  $\phi 1000$ . As diameter of rotors for most of the Turbines is less than  $\phi 1000$ , the result was acceptable.



## VERIFICATION WITH ACTUAL TEST ROTOR

To verify whether the heat treatment conditions determined by FEM and lab tests can be applied to the actual rotor, large test pieces were manufactured and various verification tests were carried out. Figure 7 shows the sampling position at the test piece. The test rotor simulates an infinite cylinder of diameter  $\phi 1000$  by affixing heat insulation material on the sides. Test pieces C-1 and X-2 taken from the core and  $\phi 400$  location of rotor were tested for low temperature toughness ( $FATT_{50}$ ) as the locations had lowest cooling rate. The centrifugal force is largest at  $\phi 400$  during operation (disc root equivalent position) so test piece X-2 was another critical point for toughness. Test piece X-1 was taken from the surface of the rotor and checked for creep strength. The cooling rate at surface is highest which makes it the critical point for creep failure.

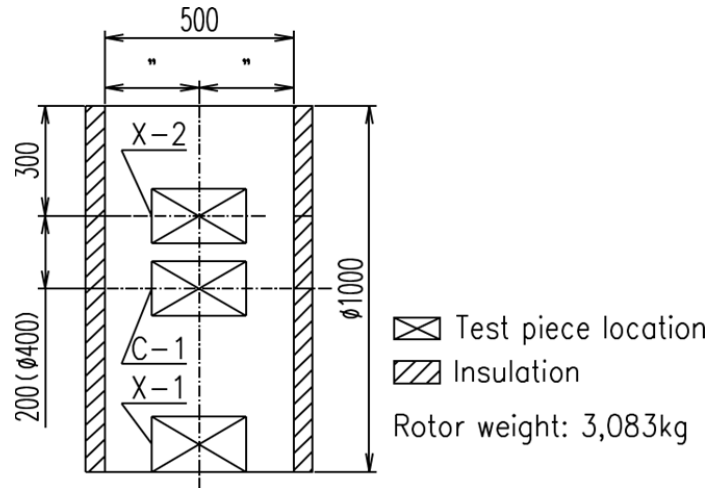

Figure 7: Location of Test pieces

The surface at the sides of this test piece is not cooled from the sides so the cooling rate is slower than actual rotor. It creates a favorable condition for high temperature creep rupture test. Another test piece from actual rotor was taken to verify the creep strength later.

Tensile test was used to determine the yield strength, tensile limit and other mechanical properties of 3 test pieces per location. Charpy test was used to measure impact behavior and likelihood of brittle fracture. Impact energy was measured at  $20^{\circ}\text{C}$ . Fracture surface appearance was used to estimate the ductile to brittle transition zone (DBT) and estimate the  $FATT_{50}$  temperature. Short time creep rupture test was performed for 100 hrs and long-time creep rupture test for 4000 and 20,000 hrs depending on temperature and applied stress conditions. The tests are summarized in the below table.

Test method	Description
Tensile test	3 test pieces per position. For measurement of Mechanical properties.
Impact test	2 test pieces per position. For measurement of Absorbed energy.
$FATT_{50}$	6 test pieces per position. For measurement of $FATT_{50}$ .
Microstructure observation	For confirmation of no Ferrite structure.
Tensile test in high temperature	5 test pieces picked up from each position. For measurement of Mechanical properties in high- temperature condition.
Long- time Creep rupture test (5,000hr $\approx$ 7months)	4 pieces picked up from each position of material. For checking material property in high- temperature condition by means of long time creep test.

Table 7: Description of various tests

The results of various tests for lab test piece and test piece from actual rotors are shown in Table 7 and Table 8. From the test results, it can be seen that the  $FATT_{50}$  temperature at the core of  $\phi 1000$  rotor is  $17^{\circ}\text{C}$  which is way lower than the target value. The bainite structure was verified under microscope. The creep rupture test for short term and long term satisfied the criteria for time at different temperature and stress level. Based on the results, we were able to confirm that heat treatment method imparts sufficient strength and toughness to the material and can be applied to the actual rotor.





	Test piece position	Tempering condition		Temper parameter	$\sigma_y$ [MPa]	$\sigma_{ts}$ [MPa]	Elongation [%]	Reduction of Area [%]	Impact value at 20°C [J/cm <sup>2</sup> ]		50% FATT [°C]	Hardness [Hv]
		Temperature [°C]	Retention time [Hr]									
Target	Surface				$\geq 637$	$\geq 784$	$\geq 15$	$\geq 40$	$\geq 49.1$		$< 40$	
	Center				$\geq 578$	$\geq 706$	$\geq 14$	$\geq 36$	$\geq 44.2$		$< 44$	
Test coupon $\phi 1000$	Surface	645	32.5	19748	713	842	26	70	241	235	-30	261
	Surface	650	25.5	19758	715	843	23	67	222	202	-20	-
	D/4	645	36.0	19789	701	826	22	67	179	169	20	-
	Center	645	36.0	19789	702	828	23	66	169	176	17	-
Actual rotor	Surface	645	37.0	19800	717	844	24	69	240	211	-17	263
	Surface	650	23.5	19725	702	831	25	72	258	263	-23	262

Table 8: Test conditions and results

	Temperature (°C)	Stress (MPa)	Time (Hr)	Test Result
Creep test (Short time)	510	274	$\geq 100$	Completed with no rupture
	538	211	$\geq 100$	
	566	152	$\geq 100$	
	593	108	$\geq 100$	
Creep test (Long time)	575	108	20,000	Completed with no rupture
	600		4,000	
	550	152	20,000	
	575		4,000	

Table 9: Short and Long time creep test results

### STRESS CORROSION CRACKING (SCC) SUSCEPTIBILITY

Stress corrosion cracking is cracking due to a process involving conjoint corrosion and straining of a metal due to residual or applied stresses. It is the growth of crack formation in a corrosive environment which can lead to unexpected sudden failure of normally ductile metals subjected to a tensile stress, especially at elevated temperature. What makes SCC more dangerous is the fact that it can go undetected prior to failure. Parts with severe SCC can appear bright and shiny, while being filled with microscopic cracks. The occurrence of SCC depends on the simultaneous achievement of three requirements: a susceptible material, an environment that causes SCC for the material and sufficient tensile stress. As the quenching temperature 950°C is higher than the temperature of conventional heat treatment method for LP section, it is possible that SCC susceptibility might be increased. Corrosion test was performed to evaluate the SCC resistance of the rotor material and compare to current rotor material 2-1-S prior to its application in the Turbine.

#### Test Conditions:

- Test Piece : 10325MTE and 2-1-S
- Temperature : 130°C (max. temperature for wet region in LP stages)
- Atmosphere : 3 cases
- ① Non-corrosive environment : Atmospheric condition



47<sup>TH</sup> TURBOMACHINERY & 34<sup>TH</sup> PUMP SYMPOSIA  
 HOUSTON, TEXAS | SEPTEMBER 17-20, 2018  
 GEORGE R. BROWN CONVENTION CENTER

- ② Actual Turbine : DO2 ( $\leq 7\text{ppb}$ )  
 pH9 ( $\text{H}_3\text{BO}_3 10^{-2}\text{M} + \text{NaOH } 10^{-2}\text{M}$ )
- ③ SCC accelerated environment<sup>2)</sup> : DO2 ( $\leq 7\text{ppb}$ )  
 pH6 ( $\text{CH}_3\text{COONa } 10^{-2}\text{M} + \text{CH}_3\text{COOH } 10^{-3}\text{M}$ )

Strain rate : 0.0001 mm/min for test ② & ③  
 0.0005 mm/min for test ①

SCC sensitivity :  $\epsilon_{\text{SCC}}/\epsilon_0$ ,  $\sigma_{\text{SCCmax}}/\sigma_{0\text{max}}$ , SCC fracture area/Sectional area

**SCC Test Results:**

In the actual corrosive environment (water, pH 9), both 2-1-S and MTE exhibited a ductile fracture although SCC didn't occur. On the other hand, SCC accelerated environment (water, pH 6) caused both the material to crack and the SCC fracture rate was 30.8% for 2-1-S and 45.4% for 10325MTE.

- SCC susceptibility can be evaluated by comparing the drop in maximum applied stress under different conditions. The drop in max. applied stress in pH 6 accelerated environment is similar for both material. It was concluded that SCC susceptibility of both materials is equivalent.
- The absolute value of elongation and brittle fracture rate are larger compared to 2-1-S. The fracture mode for MTE material is considered to be brittle in comparison to 2-1-S. This effect is attributed to coarsening of crystal grains at high quenching temperature.

The SCC test results of both materials are shown in the table below:

Material	Temp. (°C)	Environment	pH		Maximum applied stress $\sigma_{\text{max}}$ (MPa)	Normalized with the value at atmospheric condition	Elongation during maximum applied stress (%)	Normalized with the value at atmospheric condition	Elongation at breaking point (%)	Normalized with the value at atmospheric condition	Reduction of area (%)	Normalized with the value at atmospheric condition	Percentage of brittle fracture area (%)
			Test start	Test end									
2-1-S	130 °C	Atmospheric	—	—	824	1.0	12.2	1.0	22.5	1.0	70.5	1.0	0.0
			—	—	828		12.2		22.2		70.4		0.0
			—	—	Ave. 826		Ave. 12.2		Ave. 22.4		Ave. 70.5		0.0
		water, pH=9	10.74	10.46	851	1.0	11.8	1.0	21.3	1.0	70.1	1.0	0.0
		water, pH=6	5.72	5.79	807	1.0	6.9	0.6	9.8	0.4	14.6	0.2	30.8
10325MTE Single heat treated	130 °C	Atmospheric	—	—	759	1.0	10.0	1.0	20.4	1.0	72.2	1.0	0.0
			—	—	756		9.7		19.4		68.2		0.0
			—	—	Ave. 758		Ave. 9.9		Ave. 19.9		Ave. 70.2		0.0
		water, pH=9	10.74	10.54	766	1.0	7.0	0.7	14.2	0.7	55.6	0.8	0.0
		water, pH=6	5.72	5.86	753	1.0	5.1	0.5	7.9	0.4	16.0	0.2	45.4

Table 10: SCC test results in different environment for both materials

**CONCLUSIONS**

New heat treatment was proposed to improve the high temperature creep strength and low temperature toughness of an alloy so that it can be used as rotor material in high temperature and high pressure Turbines with short/medium bearing spans. Series of tests were conducted on test pieces and actual rotor to check the mechanical properties, creep strength and FATT<sub>50</sub> temperature. Corrosion test was conducted to check the SCC in the material. Based on the results, it was confirmed that the new heat treatment method was effective and can be applied to the Turbine rotor.



47<sup>TH</sup> TURBOMACHINERY & 34<sup>TH</sup> PUMP SYMPOSIA  
HOUSTON, TEXAS | SEPTEMBER 17-20, 2018  
GEORGE R. BROWN CONVENTION CENTER

Adoption of the new rotor material means that after control stage temperature can be increased to approx. 480°C from 460°C (conventional) with no impact on rotor life. This can increase the efficiency of the HP section by 5% leading to huge energy savings. The effectiveness of the material can be seen from the fact that the lifetime of rotor will be 8 times that of the conventional rotor material if the maximum temperature of rotor is kept 460°C.

## NOMENCLATURE

HP	= High pressure	
LP	= Low pressure	
SCC	= Stress corrosion cracking	
SSRT	= Slow strain rate test	
FATT	= Fracture Appearance Transition Temperature	
FEM	= Finite element method	
$\phi$	= Diameter	(mm)
P(L.M.)	= Larson-Miller parameter	
T	= Temperature	(°C)
$t_r$	= Stress-rupture time	(h)
CCT	= Continuous Cooling Transformation	
$\sigma_y$	= Yield stress	
$\sigma_{ts}$	= Ultimate tensile stress	
DBT	= Brittle transition zone	
ppb	= Parts per billion	

## REFERENCES

- Kondo, Kakuya, Furuyama, Shimizu: Takahiko 2510380A 21/4 Evaluation study on SCC resistance of high and low pressure integral rotor material (Part 2)
- Hitomi Itoh, 2001, Stress corrosion cracking in 3.5 Nicrmov steel in a 403 k potential-pH diagram, Proceedings of ICONE 9, 9th International Conference on Nuclear Engineering

## ACKNOWLEDGEMENTS

The authors wish to thank all involved colleagues from MCO and Lil Kassie for the technical assistance and the precious feedback.