

Author's Biographies

➤ Isham Sudardjat – Qatar Petroleum

Reliability Engineer, QP Offshore Operations.

Isham graduated from Bandung Institute of Technology in 1998 majoring in Mechanical Engineering. Having 16 years of experiences in Major Oil and Gas Operators with various roles, he is also Certified in Maintenance and Reliability Professional (CMRP) and holding level-2 vibration analyst. Since 2010, he has been appointed as General Secretary of Qatar Reliability Forum.

➤ Sankar Ganesh – GE Bently Nevada

The Lead Engineer of GE-Bently Nevada Machinery Diagnostics Services for Qatar & Kuwait Region. He received Bachelor of Mechanical Engineering from Bharathidasan University-India at 1993.

He is working for GE, Bently Nevada for 8 years and has over 20 years experience in vibration field, including rotating equipment balancing, vibration analysis, diagnostics and root cause analysis. Published case studies in METS and Turbomachinery symposium.

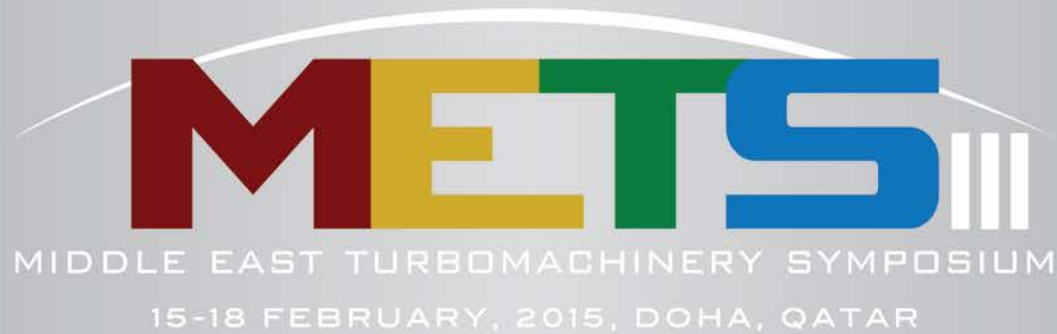

Advancement in Vibration Monitoring Techniques to Identify and Prevent Motor Failures on MOL Pumps at QP Offshore

Isham Sudardjat
Reliability Engineer
QP Offshore Operations

Sankar Ganesh
Lead MDS Engineer
GE-Bently Nevada



Contents

- Background
- Machine description
- Data analysis
 - First Visit
 - Second Visit
- Initial Conclusions
- Machine Inspection results
- Final Conclusions
- Actions Taken
- Lessons Learned

Background

- Qatar Petroleum (QP) Offshore Operations is comprised of two production platforms, PS-2 & PS-3
- Each platform includes three Main Oil Pumps (A, B, and S)
- Main Oil Pumps critical to oil production
- Two motors failed within a span of less than one year.
- Motor X tripped on overload during start. After inspection, failures were found on coupling, Motor DE bearing, motor rotor and stator. No damage to the pump.

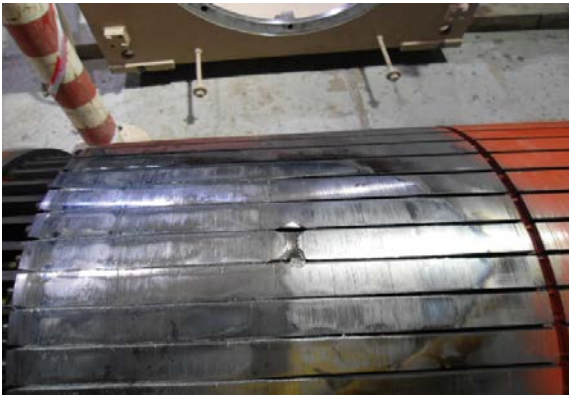

- QP requested GE-Bently Nevada to collect data on both the stations and provide detailed analysis.

Machine Description



- **Motor - Induction type, 486 kW, 3300 Volts, 50 Hz, 2971 RPM**
- **Pump – Capacity 358 m³/hr**
- **Motor Bearings – Ball / Roller Bearings**
- **Pump Bearings – Radial sleeve, Thrust Ball Bearings**
- **Motor & Pump Assembly mounted on a common skid**
- **Baseplate Welded to Structural beams using pads**

Data Analysis

First Visit – Steady State Data on the Motor / Pump casings

Location	Overall Vibration velocity (mm/s rms)				
	PS-2 Pump A	PS-2 Pump S	PS-3 Pump A	PS-3 Pump B	PS-3 Pump S
Motor NDE - Horizontal	0.75	1.40	1.34	0.60	0.71
Motor NDE - Vertical	0.80	0.92	1.00	0.76	0.75
Motor NDE - Axial	0.80	1.21	0.70	0.87	0.97
Motor DE - Horizontal	1.00	1.20	1.24	0.73	1.02
Motor DE - Vertical	0.97	1.76	1.26	0.86	1.20
Motor DE - Axial	0.45	0.68	0.52	0.59	0.61
Pump DE - Horizontal	2.12	2.13	2.30	2.55	2.18
Pump DE - Vertical	3.90	4.87	2.51	6.67	2.69
Pump DE - Axial	2.26	3.92	1.30	1.67	1.12
Pump NDE - Horizontal	2.92	2.17	2.20	3.24	2.09
Pump NDE - Vertical	9.38	16.55	1.95	3.65	1.69
Pump NDE - Axial	2.52	1.66	1.20	1.39	1.23

*Note: PS-2 Pump B was Not Available due to Motor

Failure

Steady state motor vibration was well within acceptable limits whereas pump vibration was excessive.

Data Analysis

Frequency Spectrum Analysis on

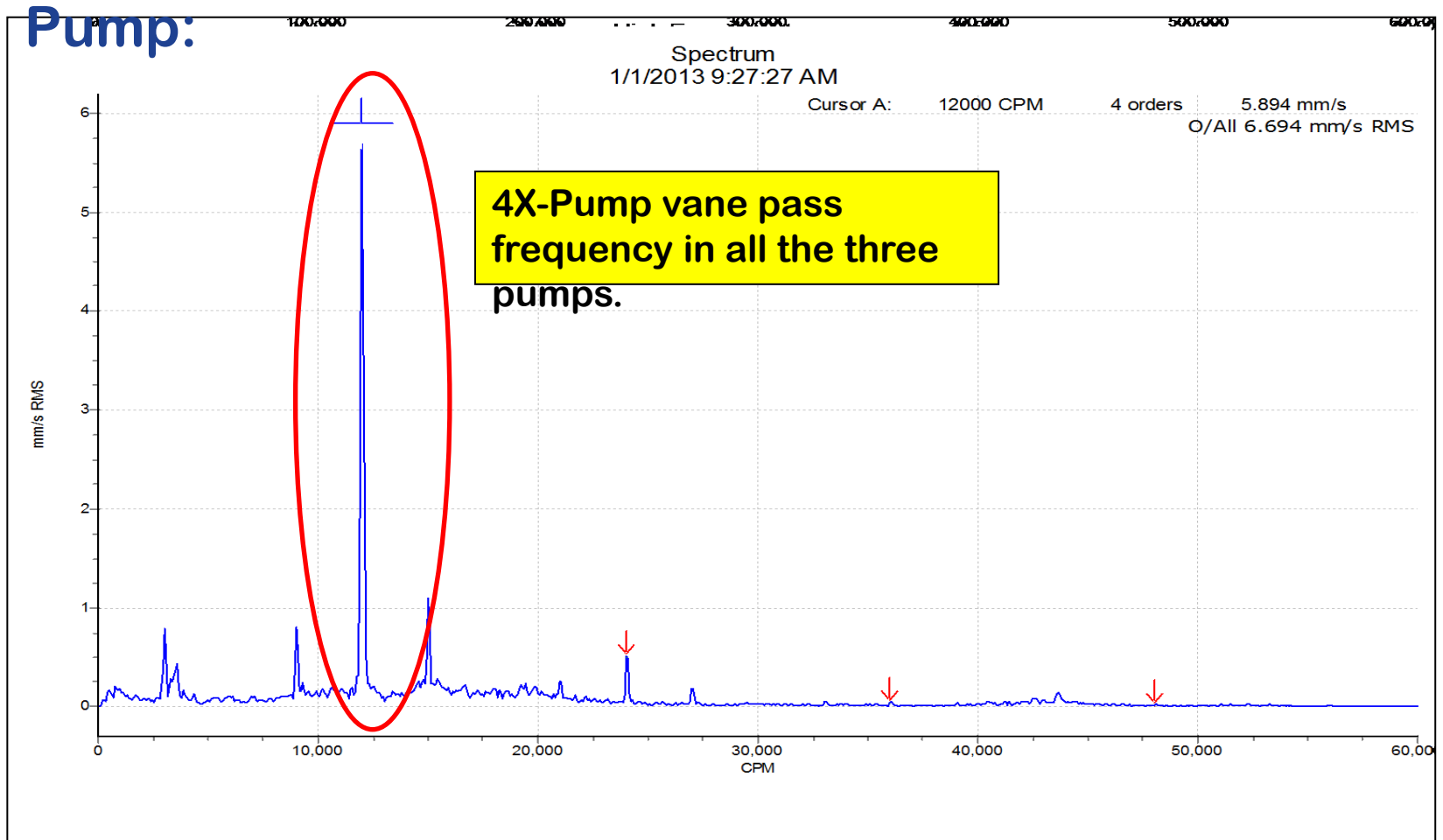

Abnormal Behavior – High amplitude of pump vane pass frequency observed since commissioning, but not damaging.

Data Analysis

Relative Phase Analysis: Velometers installed vertically on the base plate just above the pads

Locations Between	PS-2 Pump A	PS-2 Pump S	PS-3 Pump A	PS-3 Pump B	PS-3 Pump S
1 & 2	20°	0°	15°	10°	30°
1 & 3	20°	10°	10°	20°	50°
1 & 4	Low 1X Amp	120°	10°	170°	30°
1 & 5	50°	150°	10°	150°	40°
6 & 7	8°	20°	10°	20°	30°
6 & 8	10°	15°	10°	15°	20°
6 & 9	Low 1X Amp	180°	10°	170°	10°
6 & 10	80°	170°	10°	140°	40°

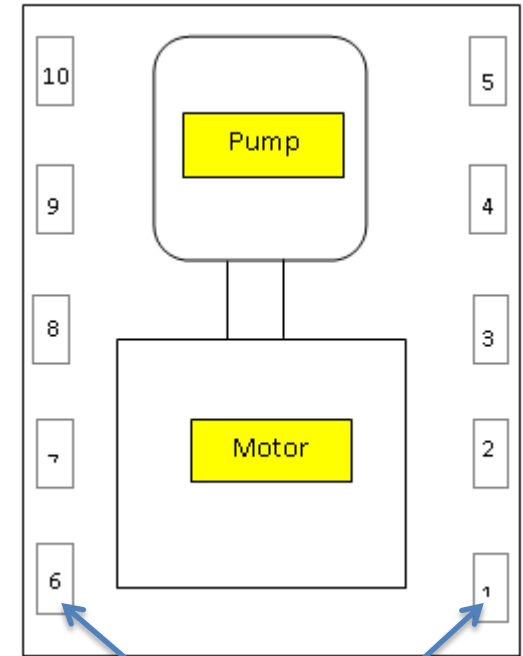

Pads

Abnormal Behavior:
Base frame vibration out of phase on PS2 Pump S and PS3 Pump B.

Data Analysis

Demodulation spectrum analysis on motor

bearings:

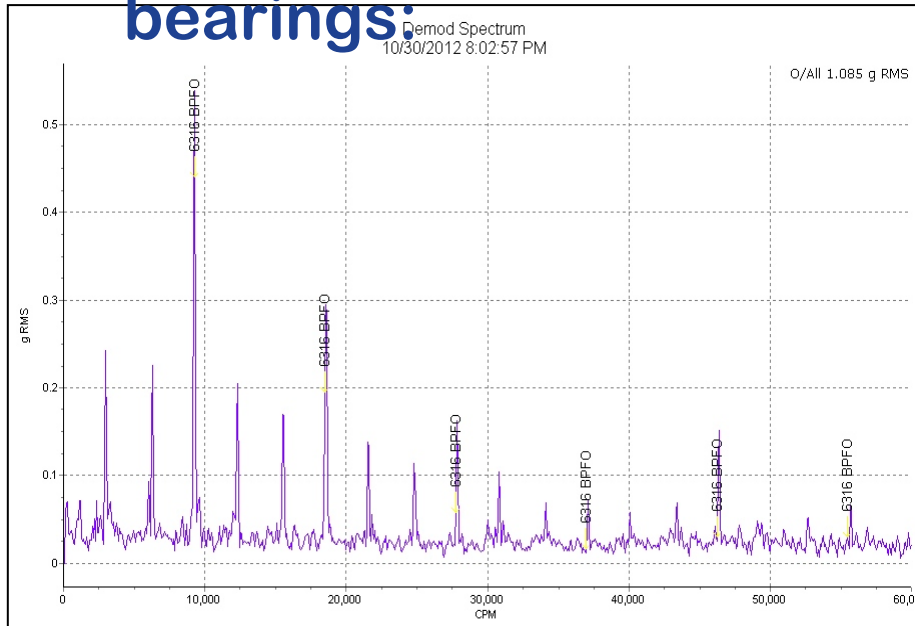

PS 2 Pump - S

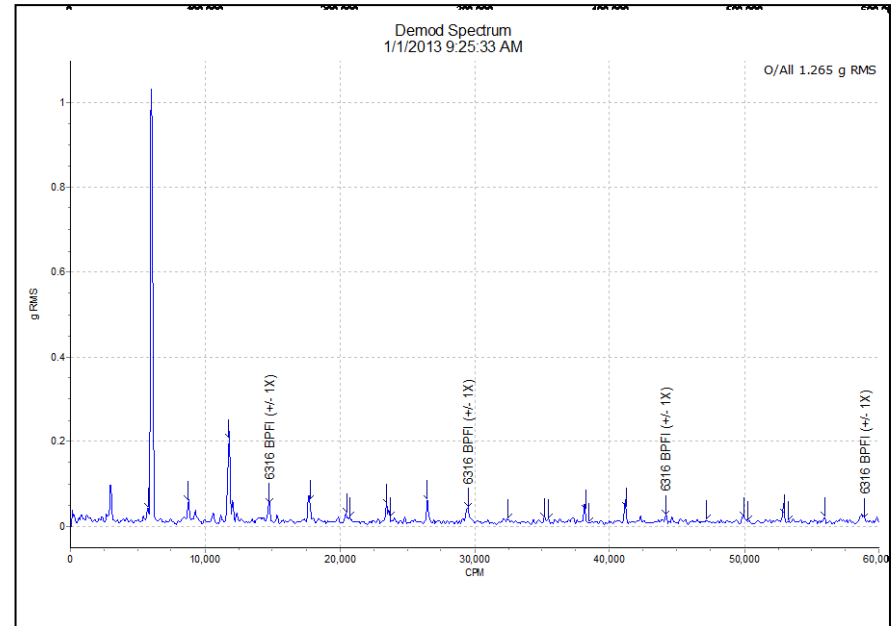

PS 3 Pump - B

- ✓ Bearing defect frequencies observed on two motors even though overall amplitudes were well within limits.
- ✓ Coincidentally, these two motors' base frames showed out-of phase behavior.

Data Analysis

High frequency spectrum analysis on motors:

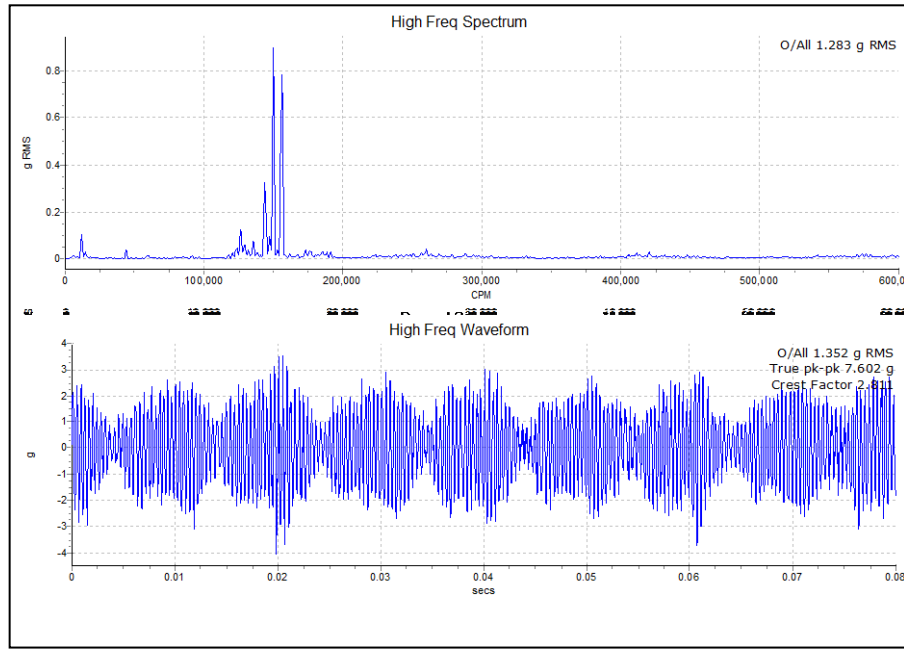

PS 2 Pump - S

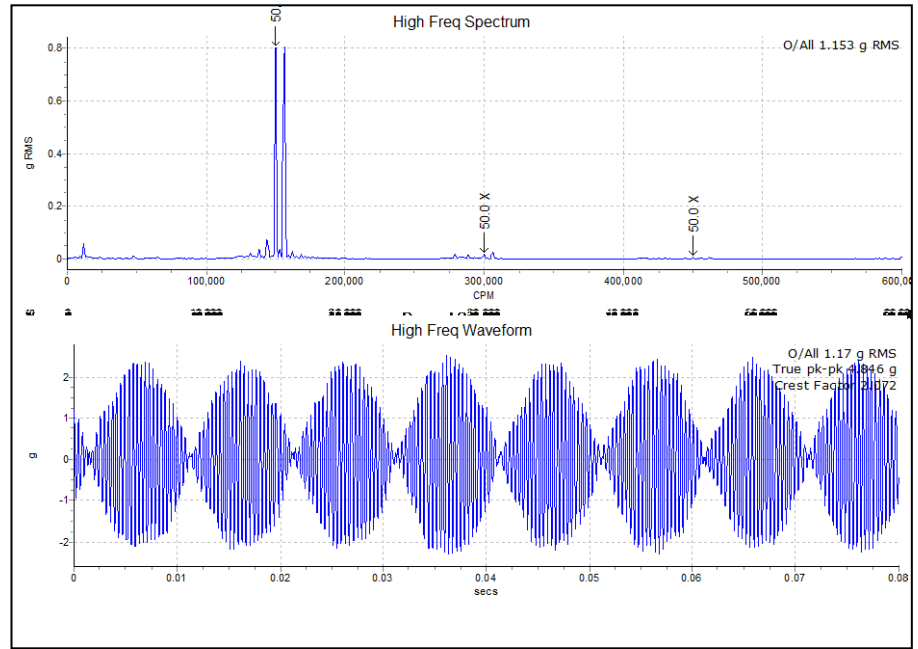

PS 3 Pump - B

- ✓ High frequency peak at 50X with 2 times line-frequency side bands, attributed to rotor bar pass frequency
- ✓ Suspected to be inherent since commissioning
- ✓ Found on all motors.

Data Analysis

Second Visit – Transient data collection using Keyphasor

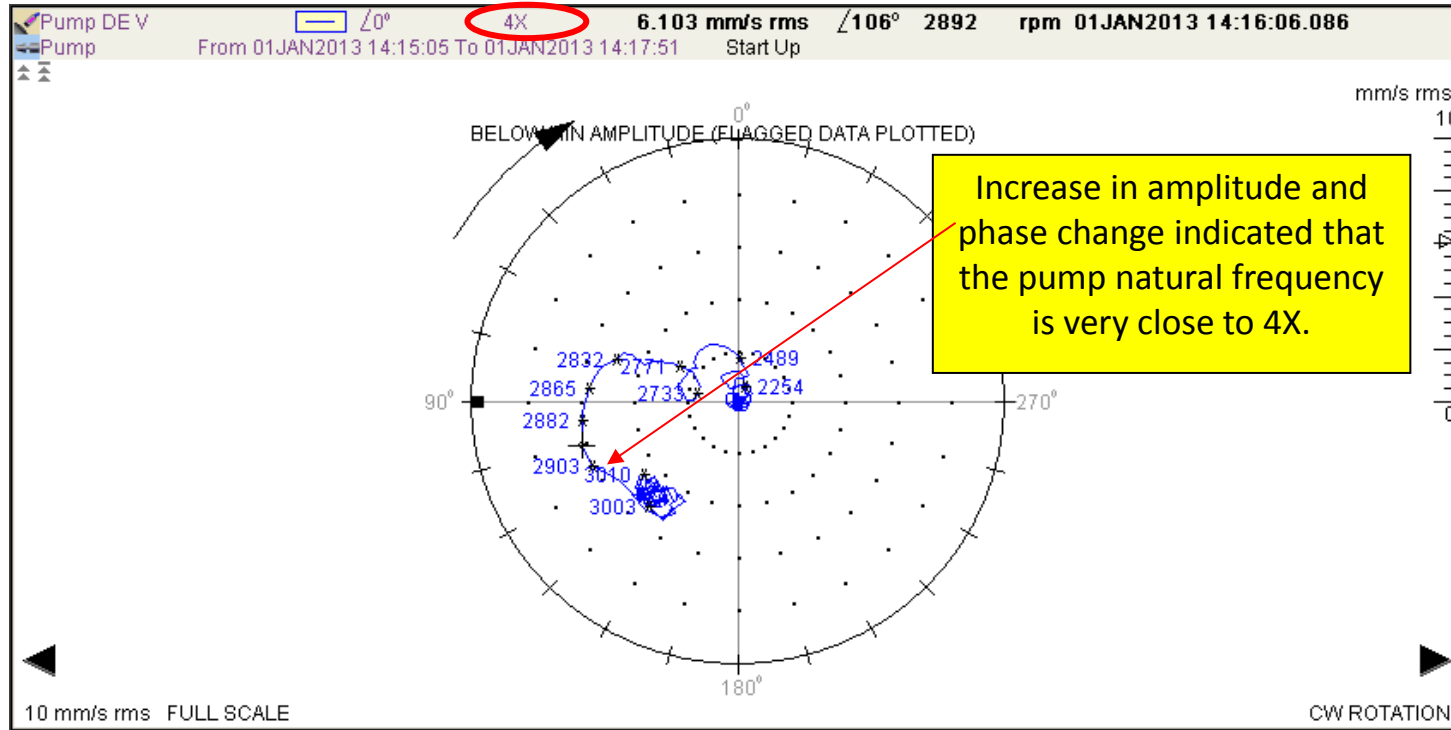

- 4X variable (vane pass frequency) spectral bands configured for all pumps.
- Coast down test conducted on pumps.
- 4X polar plot clearly indicated second natural frequency very close to the 12000 cpm.

Data Analysis

Startup Bode plots for Motor DE:

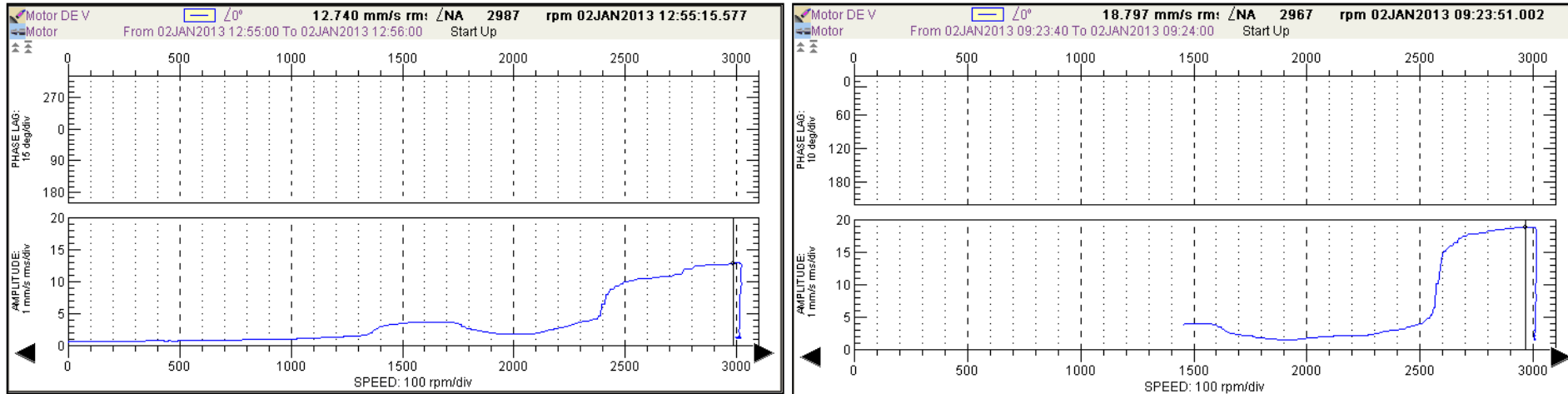

**Note: Phase data is not plotted since the high amplitude of overall vibration was due to sub synchronous component at 6Hz (not 1X).*

- 4 Velomiters on base locations 1,4 & 9 – Vertical direction
- 1 Velomitor on both Motor DE V and Pump DE V locations.
- High vibration (18 mm/s) was observed on Motor DE

Data Analysis

Startup Spectrum Waterfall for Motor DE:

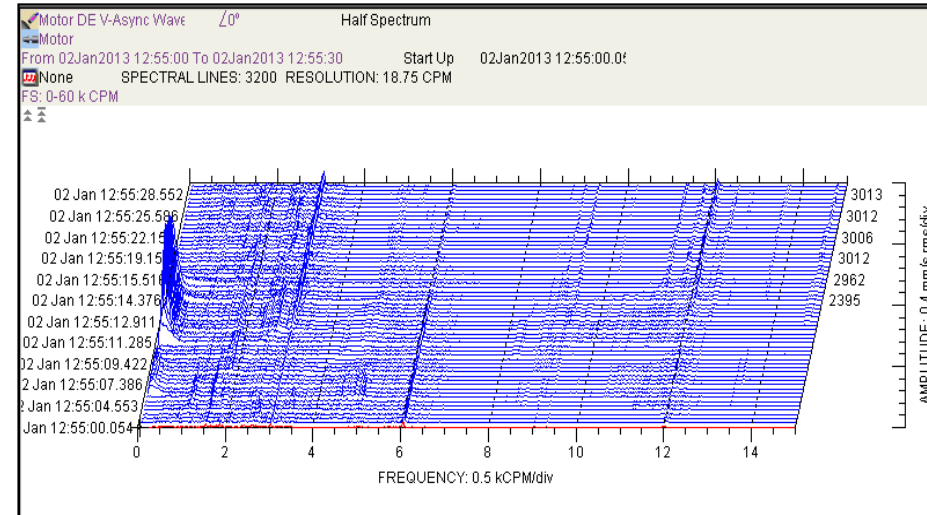
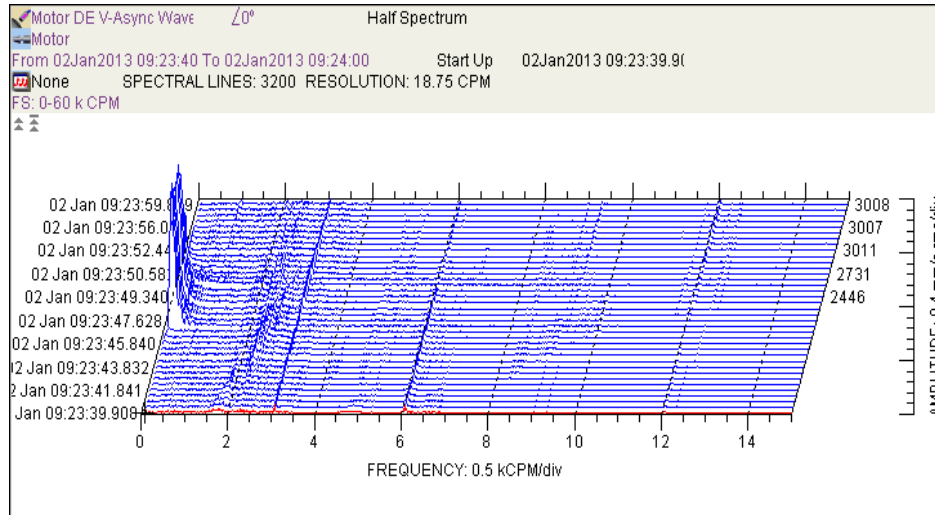

- Startup spectrum waterfall indicated very low frequency components, close to 6Hz.
- Low frequency component appear at speed between 2500 to 3000 rpm, disappearing at 3000 rpm.
- Expert Analysts concluded that the low frequency sub-synchronous component was due to torsional vibration from the coupling.

Initial Conclusions

- Rocking of Base frame (Out-of-phase)
 - ✓ Non-uniform contact between the base plate and structural beam
- Inner/outer race defect frequency with sidebands of 1X on motor
 - ✓ Rocking of base frame leading to premature motor bearing faults
- High vibration at Pump DE Vertical location
 - ✓ Excitation of Vane Pass Frequency (VPF)
 - ✓ VPF and housing natural frequency coincides
- Rotor bar pass frequency on all motors
 - ✓ Could be inherent
 - ✓ Not an immediate threat
- High vibration during start-up
 - ✓ Torsional vibration suspected from coupling

Machine Inspection Results

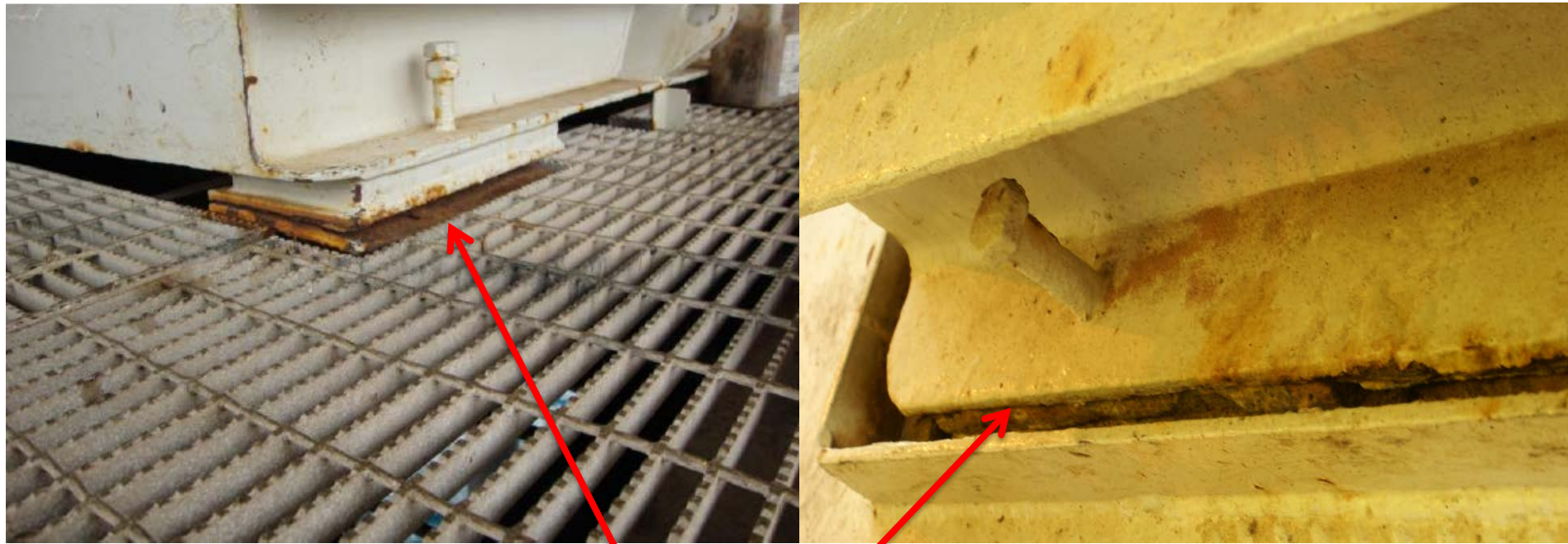

The plates welded between base plate and the structural beam found corroded

Final Conclusions

Primary Cause:

- Corroded plate between motor base frame and structural beam
 - ✓ Baseplate looseness caused motor bearing to fail prematurely, damaging the motor internals.

Contributing Causes:

- High vibration during startup
 - ✓ Effect of base plate looseness
 - ✓ Torsional vibration from coupling suspected

Actions Taken

- Corroded plate replaced and base frame rectified for Pump-S in PS2 – Measurement pending due to pump non availability.
- Correction of rotor centering reduced the vane pass frequency amplitude on pumps at PS-3 platform.
- Motor online condition monitoring technologies being explored.
- Vibration Monitoring program modified to capture and trend the Motor Rotor Bar Pass Frequency.
- Coupling replacement for pump-A & S in PS3 reduced the startup vibration significantly.

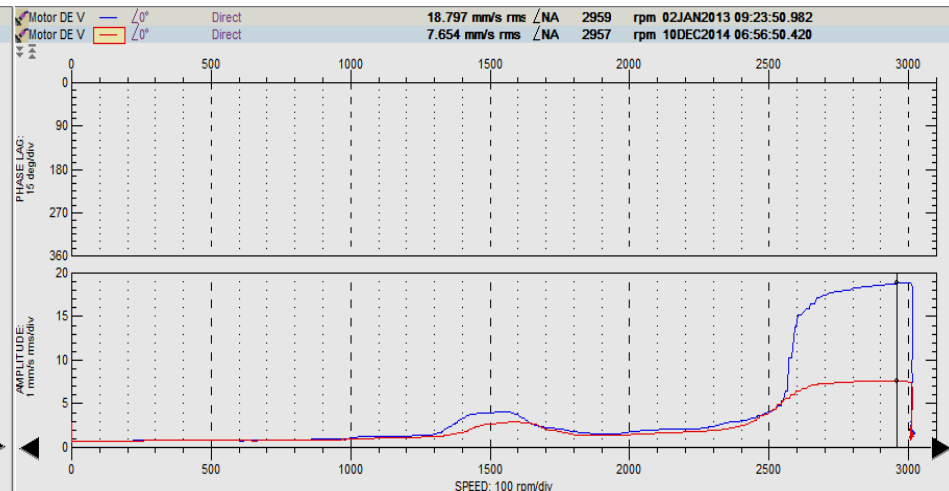
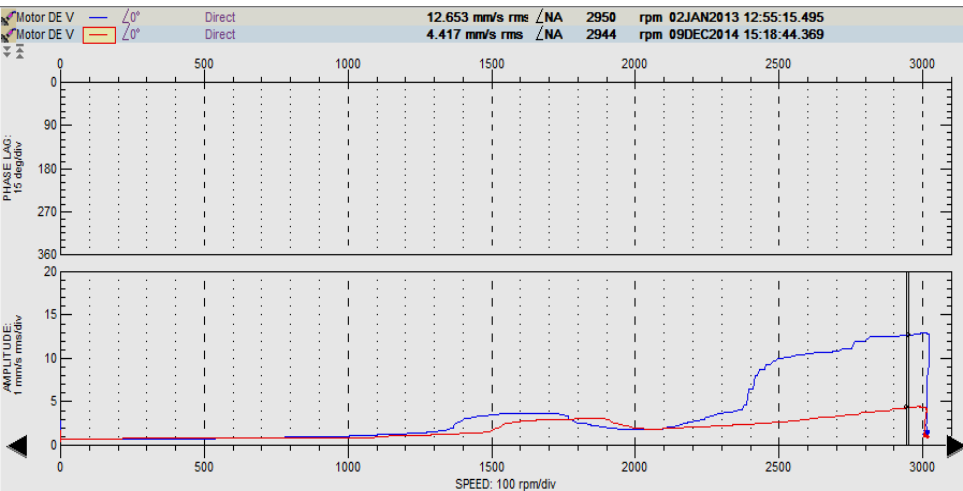

Lessons Learned

- Visual inspections can not always be relied upon to determine the condition of machinery components. Advanced vibration techniques are sometimes needed to quantify the condition.
- Overall vibration readings can be misleading, especially for very rigid or heavy units. Even seemingly minor changes in overall vibration reading should be monitored and reviewed promptly.
- To review the overall condition of critical machines which do not have online monitoring systems, ad-hoc advance vibration techniques are preferable and more cost effective.