

Preventing unstable operation of a synthesis compressor using Dynamic System Simulation

TNO | Knowledge for business



Mr. J.P.M. Smeulers, M.Sc.*
TNO Science & Industry
T: +31 15 269 2121
F: +31 15 269 2111
E: jan.smeulers@tno.nl

Mr. D. Meulendijks, M.Sc.
TNO Science & Industry
T: +31 15 269 2263
F: +31 15 269 2111
E: dennis.meulendijks@tno.nl

* Corresponding author

D. Meulendijks

Unstable operation of a synthesis gas compressor

- An example of unexpected dynamic response
- Results of an analysis using modeling of the complete compressor installation

- 1. Lay-out of the compressor system**
- 2. Description of the problem**
- 3. Measurements**
- 4. Analysis by means of a computer model**
- 5. Conclusions**



Lay-out of the compressor system

- 3-stage compressor, with all stages on a single shaft
- Suction pressure speed controlled
- Suction pressure 23 bar; Discharge pressure 133 bar
- Nitrogen flow is controlled to have a constant 3:1 hydrogen-nitrogen ratio

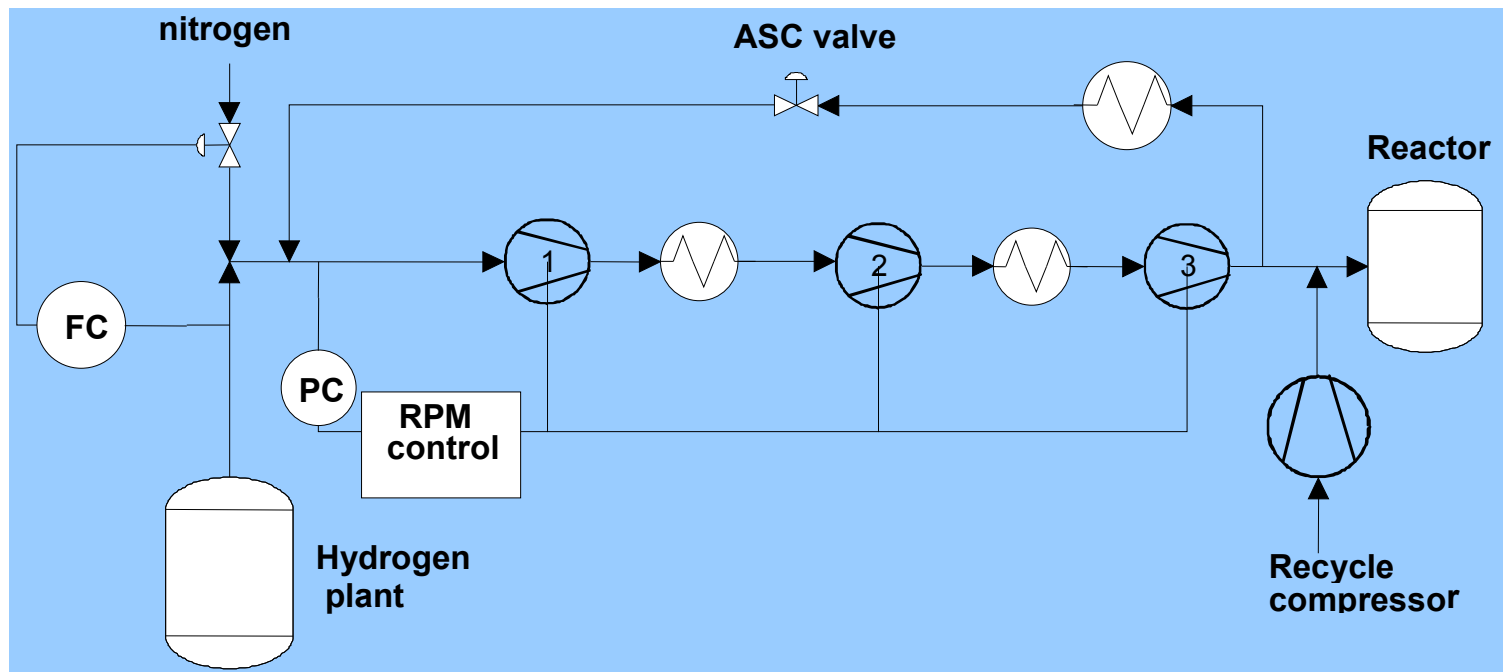

Problem description

- Compressor operated stable for rated capacity
- Compressor started surging far away from the surge point, limiting the operating envelope
- No operation possible at part load
- At 90% capacity pressure variations occurred that increase until surge occurs
- Temporary solution was to apply a large surge margin, resulting in a considerable reduction of part load efficiency



Analysis - Measurements

suction →

discharge 1st stage →

discharge 2nd stage →

discharge 3rd stage →

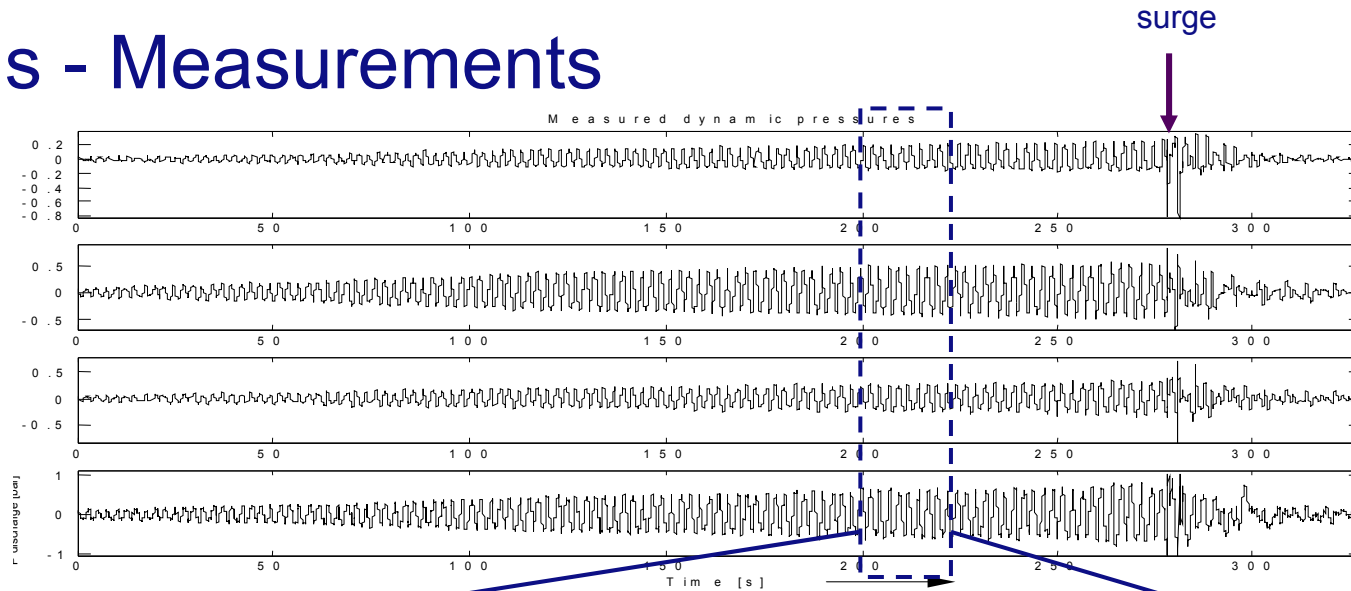

suction →

discharge 1st stage →

discharge 2nd stage →

discharge 3rd stage →

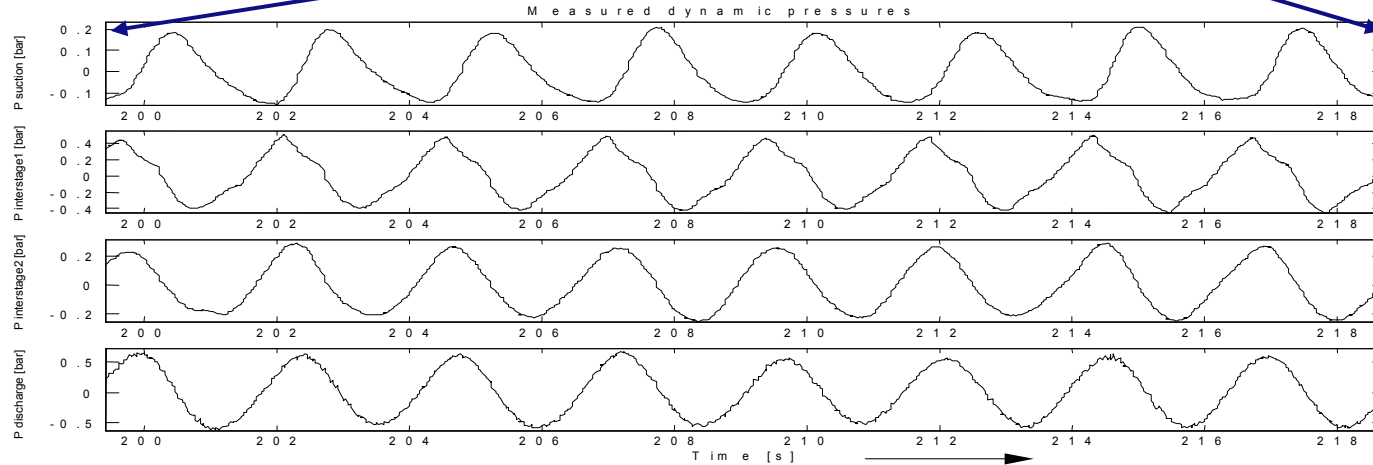

Pressure variations start to grow autonomously

→ not a classical surge phenomenon, but a system instability

Analysis – Measurements interpretation

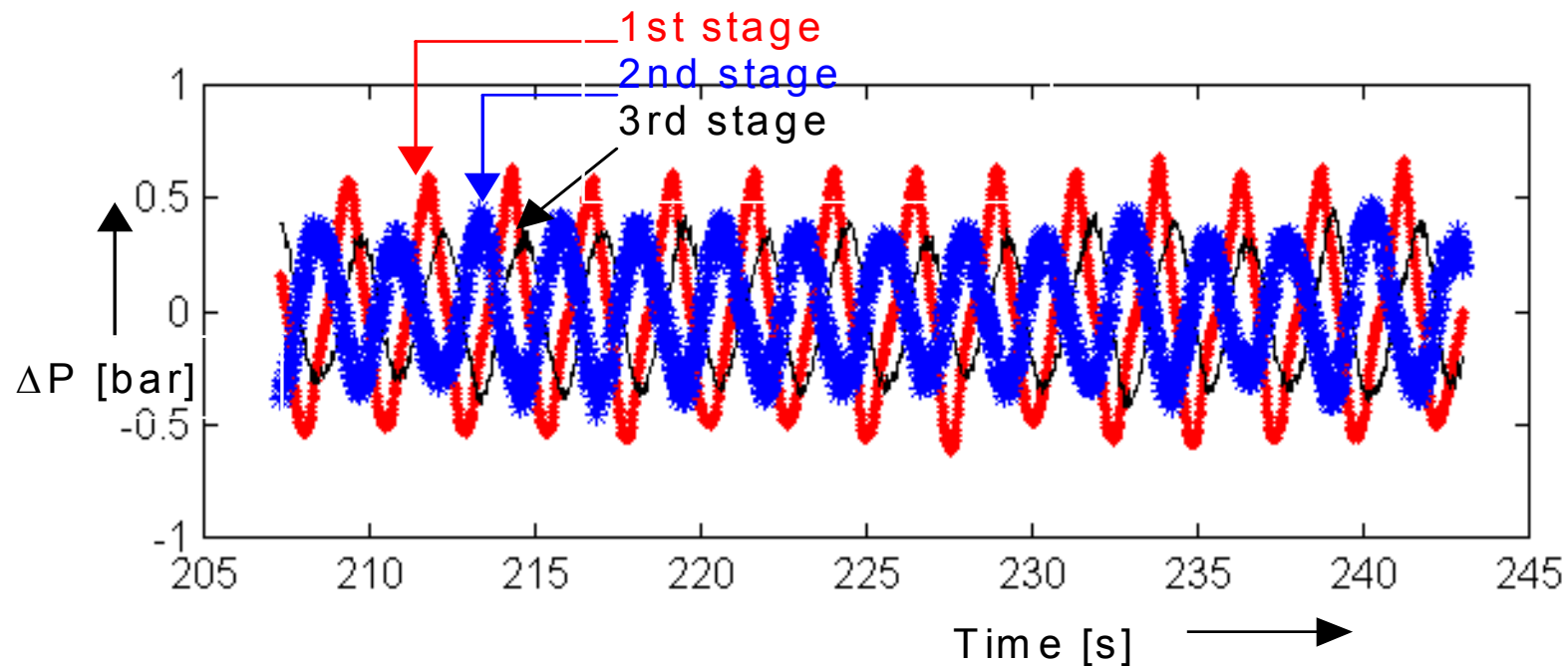

- Each stage has a phase shift of approximately 60 degrees
- Consumed power varies for each stage
- The sum of the power variations even out to a large extent:
 - When stage 1 requires more power the other stages require less

Analysis – Computer model

A model has been built to analyse this using PULSIM, which has building blocks for:

- Fluid machinery: compressor stage, rotor, driver
- Pipe system: pipes, volumes, ...
- Controllers

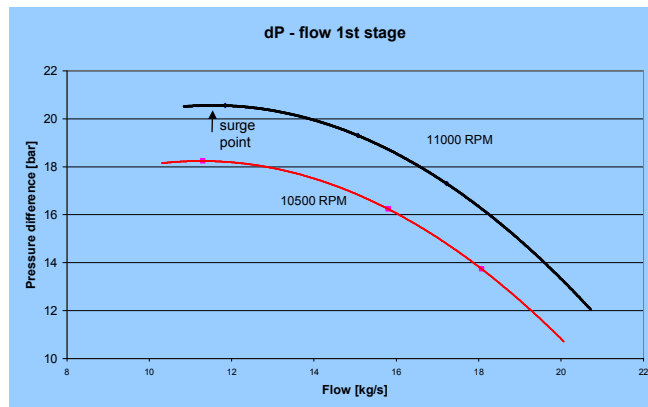
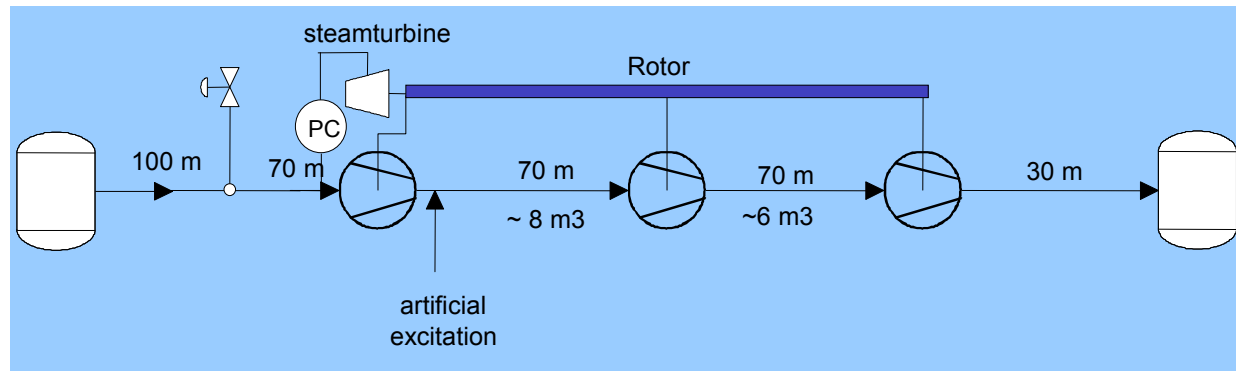

Approximated dP - flow curve

$$\Delta P = A.Q^2 + B.Q + C$$

A negative, B~ RPM and C~ RPM²

Analysis - Response to artificial excitation

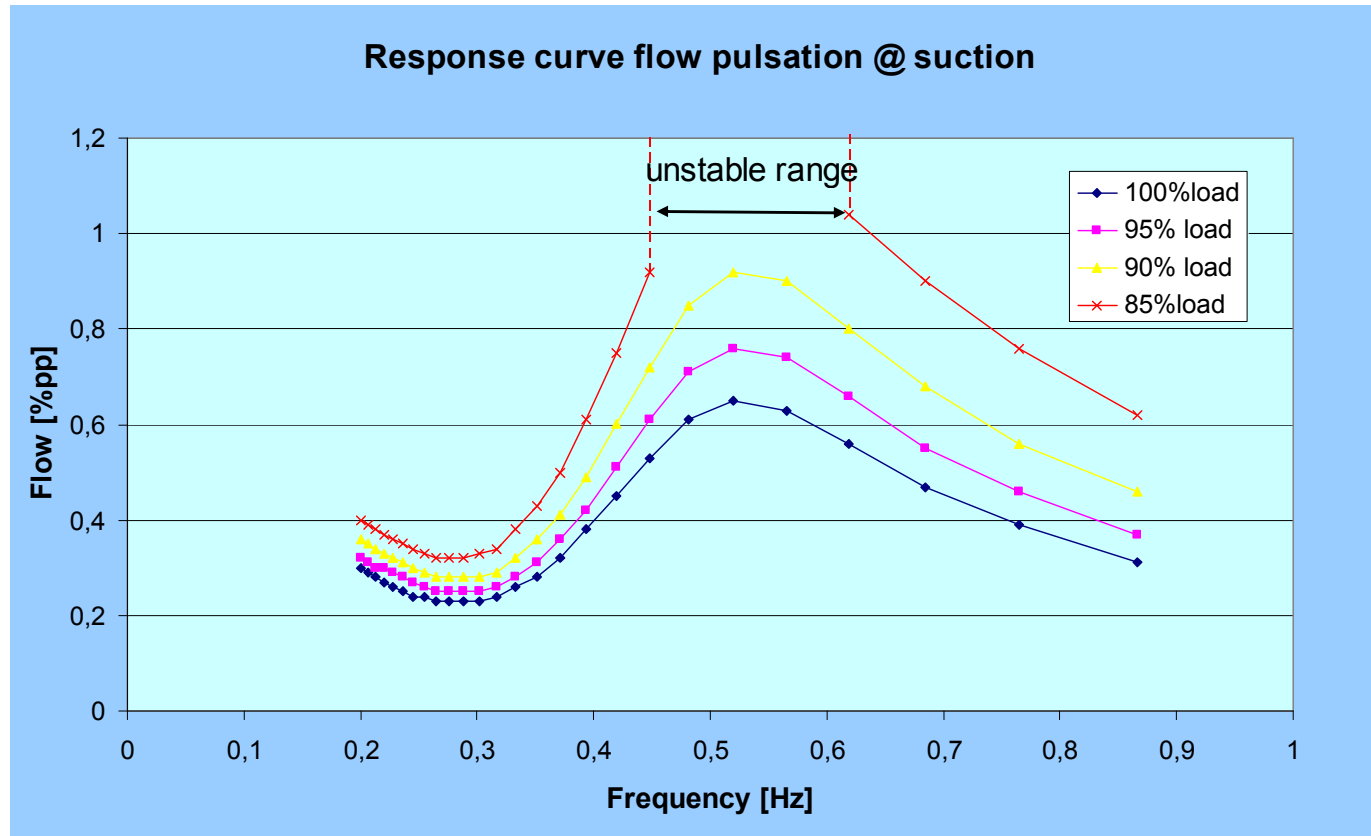

Conclusion: system is marginally stable for 85% load

Analysis - Causes of unstable behavior

1. Reduced compressor impedance at lower flows

- Idealised curve

$$\Delta P = A.Q^2 + B.Q + C$$

- Compressor impedance

$$R_c = -d \Delta P / dQ = -2.A.Q - B$$

- Surge for $R_c < 0$ or $Q < -B / (2.A)$

- @90% load the compressor impedance is a factor of 2 smaller than @100% load

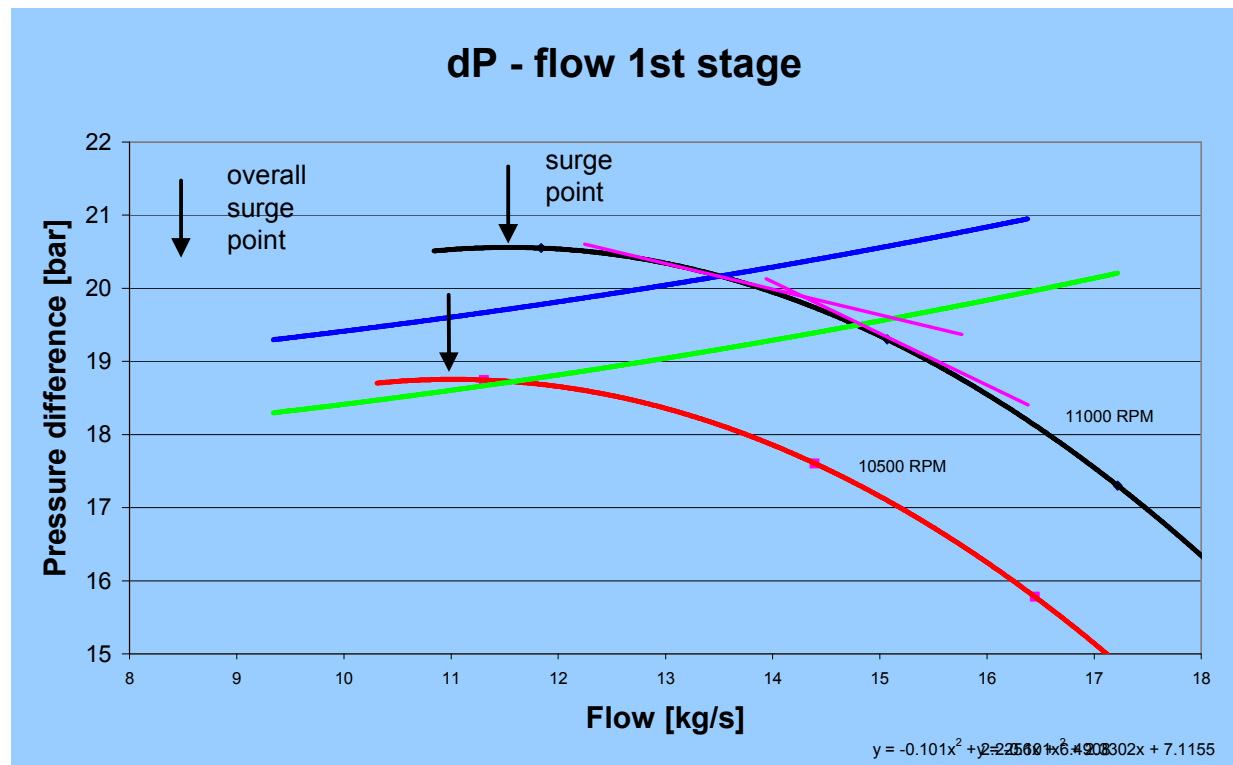

Analysis - Causes of unstable behavior

1. *Reduced compressor impedance at lower flows*
2. **Exchange of power between stages via rotor**

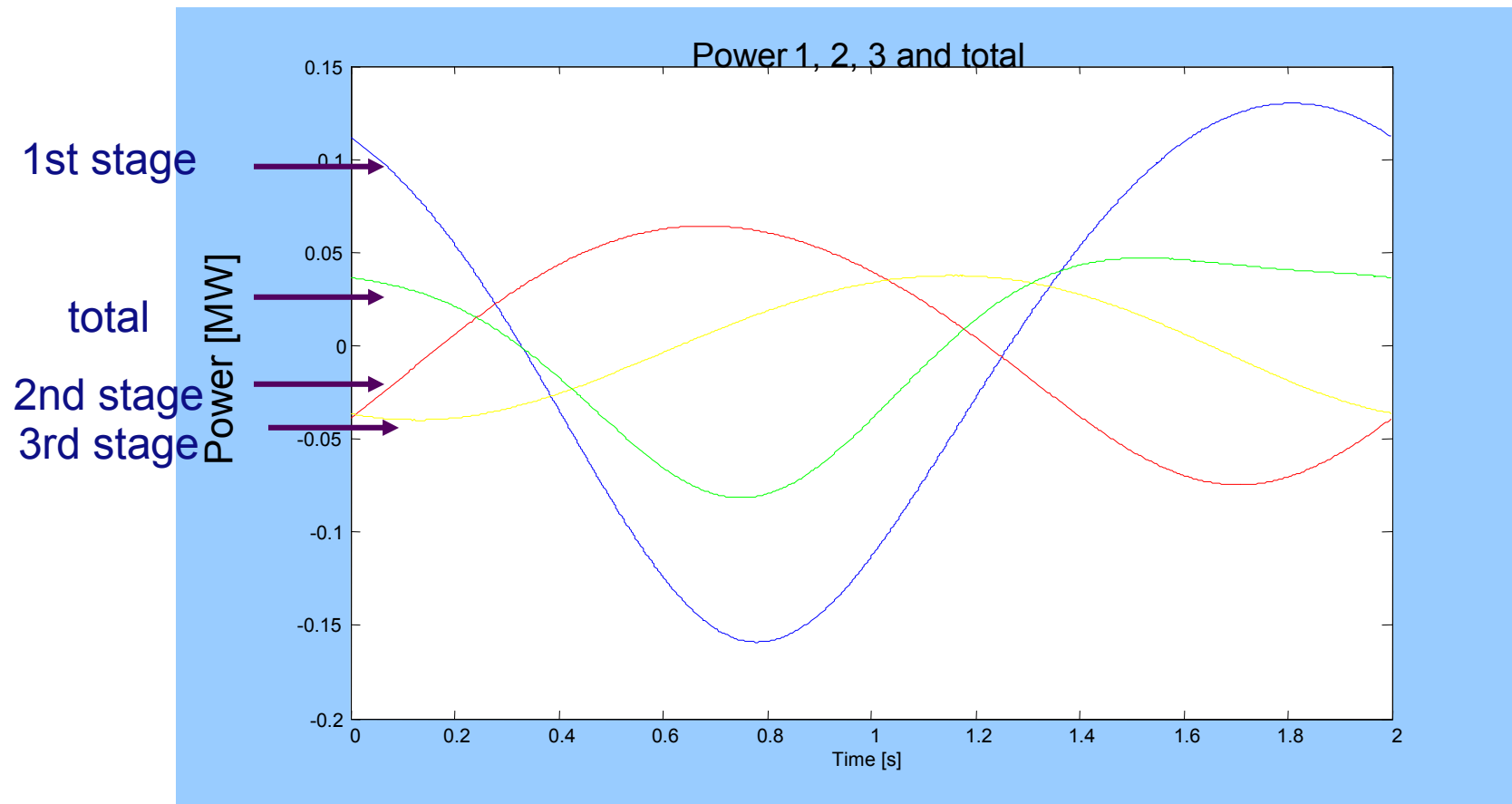

Analysis - Causes of unstable behavior

1. *Reduced compressor impedance at lower flows*
2. *Exchange of power between stages via rotor*
3. **Poor controllability of suction pressure control: small changes in suction pressure lead to large variations in flow**
4. **Variation of molecular weight caused by pulsations**
Flow variations at mixing point cause change of composition that travels with the flow velocity to the compressor. Travel time 7 seconds or ca. 3.5 period of instability cycle.

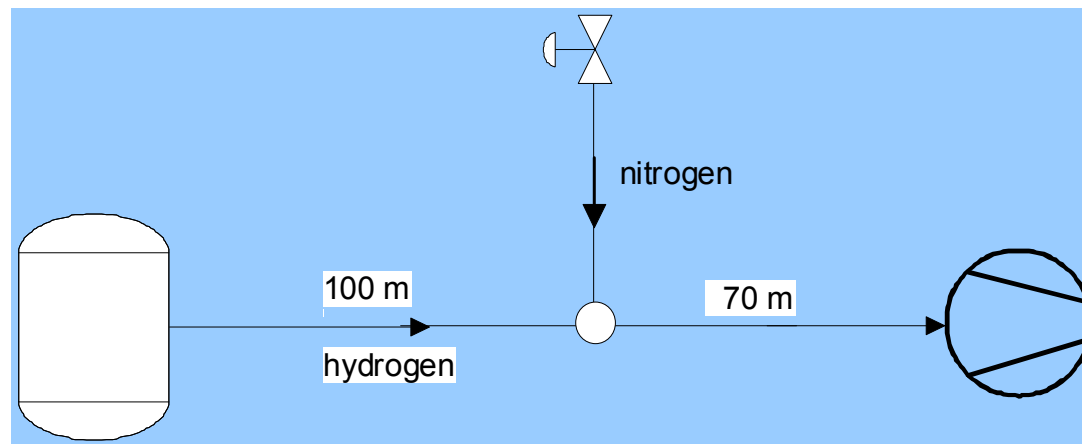

Solution - Stabilising the system

1. Improve characteristic of first stage (steeper)
2. Flow control instead of suction pressure control (cascade with suction pressure control)
3. Reduce variation of molecular weight (mixing vessel or hydrogen flow control)
4. Dampen the resonance: orifice plate or control valve in hydrogen line

Difficult to achieve in an existing system

The orifice was actually implemented, and the system operated stable

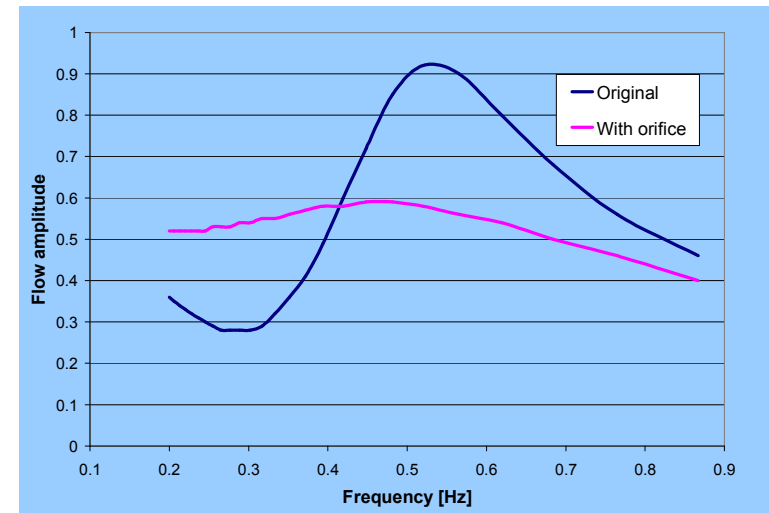

Concluding remarks

1. Unexpected instabilities can occur in a compressor installation as a result of pipe system and compressor dynamics
2. Low pressure loss systems with multi-stage compressors are susceptible for instabilities
3. Compressor head-flow curves are not as smooth as presented here. Especially 'multiple wheel stages' show deviations from the idealised quadratic curves. Differences exist between 'design', 'test' and 'real' curves.
4. Analysis of the compressor control during the design stage is recommendable. Powerful simulation tools are available to analyse the dynamics and control. However, this is no replacement for understanding what is going on in the system.
5. Surge cycles itself can also be simulated nowadays, i.e. the unstable behavior.

