

BONE-DRY RUNNING TESTS UTILIZING DIAMOND LIKE CARBON COATED SILICON CARBIDE BEARINGS AND POLYMER LUBRICATING STRIPS IN AN ANSI MAGNETIC DRIVE PUMP

by

Anthony E. Stavale

Manager of Research and Development

ITT A-C Pump Company

Cincinnati, Ohio

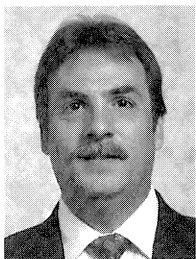

Anthony E. Stavale is Manager of Research and Development for ITT A-C Pump in Cincinnati, Ohio. He is primarily responsible for the design and administration of new products and the administration of new product development, applied research, and technology projects. He holds a B.S. degree (Mechanical Engineering) from the New Jersey Institute of Technology (1975) and is a registered Professional Engineer in the States of Ohio and New

Jersey.

Mr. Stavale joined ITT Marlow in 1991, as Manager of Special Projects and was previously employed by Worthington Pump Corporation as Manager of Product Technology and Magnetic Drive Pump Business Unit Manager. He has 22 years experience covering the design and application of ANSI B73, API 610, and sealless magnetic drive pumps. He has published three papers and received one U.S. patent. Mr. Stavale serves as a member to the ASME B73 Committee for Chemical Standard Pumps and has participated in sealless pump working groups for the Hydraulic Institute.

ABSTRACT

Dry run failures in sealless pumps continue to be of major concern to users and, in some cases, have precluded the purchase of these types of pumps. Users are demanding robust pump designs that are more tolerant of dry running caused by system upsets and occasional operator error. Although silicon carbide is the best material choice for product lubricated bearings during normal wet operation, it will quickly overheat and seize in a matter of seconds, if allowed to run dry. There are other bearing material choices available, such as carbon-graphite and various polymer materials that will permit some degree of short term dry running, but sacrifices must be made in wear resistance, chemical inertness, and/or load carrying capability. The purpose of this study is to investigate the bone-dry run performance of amorphous diamond-like carbon (ADLC) coated silicon carbide bearings both with and without Teflon® lubricating strips.

The test pump was a 1.5 × 1 × 6 ANSI magnetic drive pump fitted with a nonconductive containment shell and rated for 7.5 hp at 3600 rpm. Ten bearing configurations were tested, including repeatability tests, cycle tests, and tests with covered suction and discharge flanges to eliminate the effect of air cooling. A baseline test was conducted for silicon carbide without the ADLC coating or Teflon® strips in order to determine survivability under bone-dry run conditions. Not surprisingly, this configuration seized in under five sec operation and sustained the most massive damage of all configurations tested.

Results showed that the configuration with ADLC SiC(P) bearings and Teflon® lubricating strips was superior to all configurations tested. During this test, the maximum bearing temperature leveled off at 139°F after five hours of bone-dry run operation. This configuration had the longest operating time, lowest temperature rise, and least wear of all configurations tested. An examination showed that the SiC bearings had virtually no damage and it was expected that this configuration could have continued to run bone-dry for many more hours. The bearing configuration with ADLC SiC(P) without Teflon® strips also performed well and had an average bone-dry run time of 142 min prior to reaching the 300°F bearing temperature limit previously set for terminating the test. Post-test bearing condition for this configuration was good with only light to moderate scoring evident. It was found through repeatability testing that the dry run performance of the ADLC coated SiC(P) bearings was reasonably consistent. Prior experience with this coating indicated that it had significantly contributed to a 62 percent reduction in failure rate, during a frequency of repair audit at a large German chemical plant.

INTRODUCTION

Dry running of product lubricated bearings in sealless pumps is still the most common cause of failure for these types of pumps; especially during the startup phase of operation. Dry running can also be a result of misapplication or misoperation of the pump. Typical causes of dry run failures can be as obvious as the attempted startup of a pump prior to filling it with liquid, to extended broken suction operation that occurs commonly in tank car unloading operations. Other more subtle causes of dry running, in the broadest sense, relate to misapplication, such as insufficient NPSH, system pressure-temperature transients, entrained air/gases, or blocked lubrication and circulation paths. While it is never encouraged that silicon carbide bearings be deliberately run dry, it is recognized that it is a fact of life and that some provision for extending survivability under dry running conditions is highly desirable. Dry run failures in sealless pumps have been of major concern to users, as evidenced by lively discussion group sessions during previous pump users symposiums. A recent market survey conducted by an independent research firm for a major pump manufacturer confirmed that dry run failures were either of major concern to those using sealless pumps or identified as a decided factor that precluded the purchase of these types of pumps. As shown in Table 1, 72 percent of the respondents at the plant level indicated that dry running capability was extremely important. The same plant level survey summarized in Table 2 indicated that 59 percent of the respondents listed "concerns with dry running" as the reason for not purchasing sealless pumps.

Dry Running Conditions and Material Choices

The three basic types of dry running encountered are as follows:

- *Bone-Dry*—Pump is completely free of any liquid.

Table 1. The Importance of Dry Run Capability—as Evidenced by a Market Survey.

Degree of Importance	Dry Run Capability (%)
Extremely Important	72
Moderately Important	18
Slightly Important	9
Not Important	1
Total	100

Table 2. Reasons Given for Not Purchasing Sealless Pumps.

Reasons for Not Ordering Sealless Pumps	% of Sample Mentioning Reason
Concern about Dry Running	59
The Higher Initial Cost of Sealless Pumps	36
Lack of Confidence in Sealless Technology	27
Large Particles in Liquid	25
Concentrated Slurries	19
Sealed Pumps are Heavier Duty	14

• *Drained Pump*—Completely drained down pump in which the only liquid present is that trapped between the product lubricated bearings (initially boundary lubrication only).

• *Broken Suction*—Common in tank car unloading operations when a vessel is pumped dry. A significant amount of liquid still remains within the pump.

Previous research [1, 2] has identified the performance of SiC bearings, while operating under broken suction and drained pump conditions, as defined above, and showed that short term dry running of silicon carbide is possible under conditions where only boundary lubrication exists. The purpose of this research is to investigate a means for extending dry running further under conditions even harsher than previously tested. Bone-dry running is, without question, the severest type of dry running that can be encountered.

Sintered silicon carbide is the best bearing material choice during normal wet operation; however, bone-dry running of sintered silicon carbide can result in overheating and seizure of the rotor in a matter of seconds due to its high friction coefficient; particularly if even slight misalignment is present. The effect of even a minor amount of misalignment has a dramatic influence on the ability of silicon carbide to run dry as evidenced in a drained casing pump test of controlled porosity sintered silicon carbide [1]. This misaligned test configuration reduced the dry run time to failure to 20 percent that of a similar properly aligned bearing.

A silicon carbide journal running against a stationary carbon bushing is a much better arrangement for bone-dry running [2]; however, carbon bearings have limitations in wear resistance, load carrying capability, and chemical inertness.

Amorphous Diamond Like Carbon Coating (ADLC)

An amorphous diamond-like carbon (ADLC) coating has been successfully developed for application over silicon carbide. The coating thickness is two to three μm and is applied by a plasma assisted chemical vapor deposition process (PACVD) to a manufacturer's standard controlled porosity sintered silicon carbide (SiC(P)) bearings. The process temperature which stays below 392°F opens up the process to a wide variety of base materials. This coating has a hardness that is higher than that of the base silicon carbide ($H_{\text{Vickers}}(0.05) = 4000$ to 6000 for ADLC vs 2800 for SiC) plus universal corrosion resistance. There are no known wet chemical agents that can attack ADLC within its useful temperature range.

As shown in Figure 1, the dry friction coefficient of this coating is as low as 0.05 (ADLC vs ADLC) compared to 0.5 and higher for sintered silicon carbide. The friction coefficient under normal lubricated operation is typically less than 0.01.

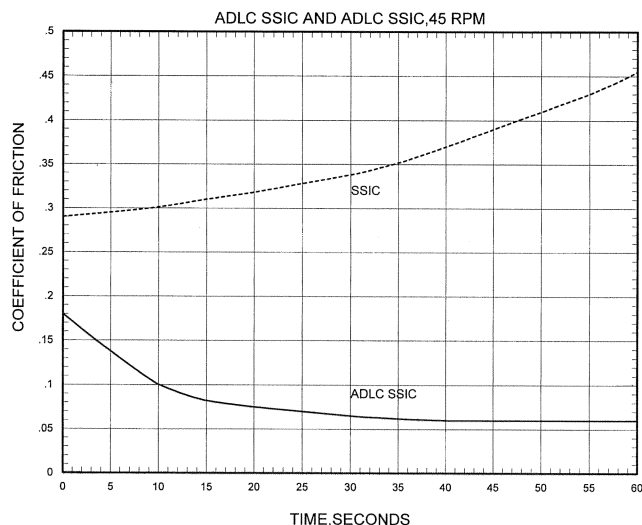

Figure 1. Dry Coefficient of Friction Vs Time.

The coating has good elasticity despite its high hardness, high wear resistance, and has an application temperature range to 572°F continuous operation. Although the thermal stability of ADLC is shown to be in the range of 842°F to 896°F, the structure at the interface between the substrate and coating undergoes changes that tend to decrease the adhesion of the coating thereby limiting the continuous temperature range.

The resultant process properties of the coating are greatly influenced by a defined range of ion bombardment of the surface to be coated. Very low ion impact energies can result in soft, polymer like films, while impact energies that are too high, result in graphitization, which also leads to soft nonwear resistant coatings. Therefore, the experience of the supplier is of paramount importance in obtaining a consistent high performing coating.

Worldwide there are several companies that are specializing in the deposition of hard, diamond like coatings by various processes.

TEST PUMP, MODELS, AND PROCEDURE

Test Pump

The test pump was a $1.5 \times 1 \times 6$ horizontal end suction ANSI magnetic drive pump fitted with a nonconductive containment shell as shown in Figure 2. The magnet drive was rated for 7.5 hp at 3600 rpm and was built using standard production parts. The threaded-on impeller was fastened with adhesive, as a precaution, to prevent possible loosening under dry running operation. The impeller front clearance was increased, for test purposes, to allow for any unexpected thermal growth of the shaft. The pump was coupled to a five hp 3600 rpm motor. Type J thermocouple wires were fitted to the OD of the stationary inboard and outboard bearings at approximately the midpoint of the bearing, since it was impractical to monitor temperature at the interface of the rotating and stationary bearings. Prior to testing, the thermocouple wires were calibrated for accuracy. During testing, ambient, inboard, and outboard bearing temperatures were recorded on a data acquisition system as a function of time. Observations were noted for any unusual noise, excessive vibration, or burning odors. Upon shutdown, the outer shaft was observed for a smooth, gradual coastdown.

Prior to assembly, all bearing configurations were wiped dry with a clean, lint free cloth. The bearing test configurations are shown in Table 3 and the as-measured diametrical bearing clearances are shown in Table 4 for each test model. All measurements were taken on a coordinate measurement machine (CMM) with the bearings mounted in a production bearing carrier.

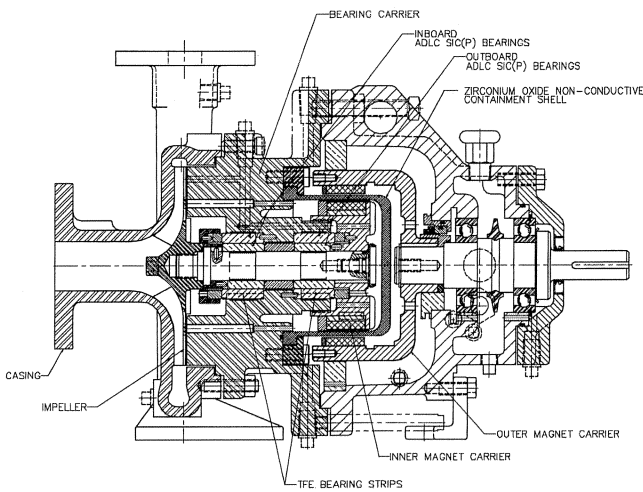

Figure 2. Test Model 1.5 x 1 x 6 ANSI Magnetic Drive Pump—7.5 HP/3600 RPM.

It should be noted that the same bearing carrier was used throughout all tests in order to minimize the effect of misalignment as a variable in the test results as much as possible. The degree of parallel bearing misalignment was measured for each test configuration prior to the start of each test. The calculated dry PV was 6500 psi ft/min for the outboard bearing and 1000 psi ft/min for the inboard bearing. All tests were conducted utilizing the same pump parts with an exception of the stationary bearing tolerance rings that are not reusable, and the bearings to be tested.

Table 3. Test Configurations.

Test Number	Stationary Bearings	Rotating Bearings	Thrust Bearings	Test Type
1	ADLC SiC(P)	ADLC SiC(P)	ADLC SiC(P)	Air Flow
2	ADLC SiC(P)	SiC(P)	SiC(P)	Air Flow
3	SiC(P)	ADLC SiC(P)	ADLC SiC(P)	Air Flow
4	SiC(P)	SiC(P)	SiC(P)	Air Flow
5	SiC(P) w/TFE Strips	SiC(P)	SiC(P)	Air Flow
6	ADLC SiC(P)	ADLC SiC(P)	ADLC SiC(P)	No Air Flow
7	ADLC SiC(P)	ADLC SiC(P)	ADLC SiC(P)	Cycle Test
8	ADLC SiC(P)	ADLC SiC(P)	ADLC SiC(P)	Repeat Test 1
9	ADLC SiC(P)	ADLC SiC(P)	ADLC SiC(P)	Repeat Test 1
10	ADLC SiC(P) w/TFE Strips	ADLC SiC(P)	ADLC SiC(P)	Air Flow

Table 4. Pre-Test Diametrical Bearing Clearances.

Test Number	Inboard Bearing	Outboard Bearing	Parallel Misalignment
1			
2	0.0020	0.0028	0.0004
3	0.0026	0.0020	0.0004
4	0.0026	0.0027	0.0004
5	0.0023	0.0027	0.0004
6	0.0026	0.0024	0.0006
7	0.0016	0.0022	0.0005
8	Not Measured	Not Measured	Not Measured
9	0.0015	0.0015	0.0002
10	0.0020	0.0018	0.0003
	0.0019	0.0025	0.0002

The ADLC coated surfaces are shown in Figure 3 for the stationary bushing, rotating journals, and thrust bearings. The bearing substrate material was controlled porosity sintered silicon carbide. The three grooves shown in the stationary bushing were

filled with Teflon® strips in Tests 5 and 10, and omitted in all other tests. The Teflon® strips are L-shaped in order to provide dry lubricant to both radial and thrust faces of the silicon carbide bearings. As heat is generated at the rotating and stationary bearing interface during dry running, these polymer strips expand outward due to their greater thermal expansion coefficient and wipe both the radial and thrust surfaces of the bearing. Once normal pumping is established, and excessive heat is no longer generated, the strips would retreat back into their grooves and remain inactive.

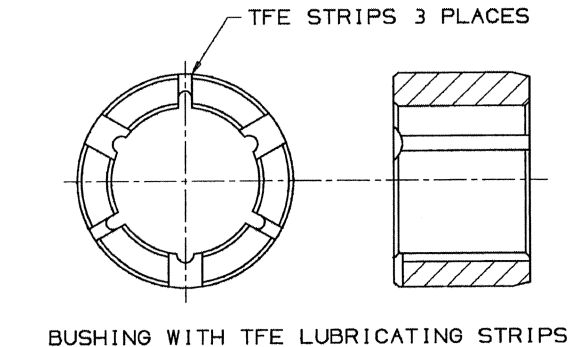
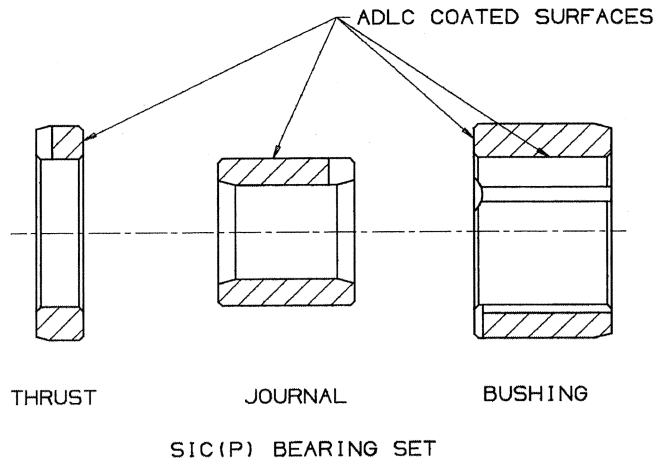

Figure 3. Bearing Test Configurations.

Test Configurations

Tests 1, 2, 3, 4, and 5 were continuous tests conducted with the suction and discharge open to air flow as may or may not occur in an actual field installation. It should be noted that the rotating impeller acts like a fan and accordingly creates significant air movement from suction to discharge. Test 6 was a continuous test also, similar to Test 1, but conducted with suction and discharge flanges blanked off to eliminate any cooling effect of the air movement. A 300°F temperature limit was arbitrarily selected for discontinuation of the test, unless seizure occurred first. The only exception was Test 10, which was discontinued due to time constraints. At the conclusion of each test, a dismantling inspection was performed to inspect for any internal rubbing and for observation of bearing condition. Bearing clearances were remeasured where the bearings survived intact.

The purpose of Test 7 was to investigate the influence of cycling on the survivability of the unit. The cycle selected was two min of bone-dry running followed by a three min shutdown. This test was repeated for 80 cycles before dismantling the pump for inspection.

Tests 8 and 9 were duplications of Test 1 for purposes of confirming the repeatability of results. Test 10 investigated the influence of Teflon® lubricating strips on bone-dry running operation when used in combination with the ADLC coated bearings.

Nonconductive Containment Shell

All tests were performed utilizing a nonconductive containment shell (zirconium oxide). The use of a zero eddy current loss containment shell is of major importance if the pump is to survive dry running [1]. Even for shell materials of very high electrical resistivity, such as Hastelloy C, eddy current losses can be very significant at 3600 rpm. These power losses, which manifest themselves as heat, are typically 10 percent to 20 percent of the maximum magnet drive rating at 3600 rpm. For example, a magnet drive rated for 50 hp and 3600 rpm can have up to 10 hp of additional heat input due to eddy current losses. Aside from the operating speed and electrical resistivity of the material used for the shell, eddy current losses are also influenced by containment shell geometry. A thicker shell will increase eddy current losses proportionately, while an increased shell diameter influences these power losses according to the cube power. During dry running, shell temperatures due to eddy current losses can easily reach 1000°F in a matter of seconds [3].

RESULTS AND DISCUSSION

ADLC On Both Running Surfaces

A time vs temperature plot of inboard and outboard bearing temperatures for Test Configuration 1, which consisted of ADLC SiC(P) rotating and stationary bearings, is shown in Figure 4. This arrangement successfully ran bone-dry for 161 min prior to reaching the 300°F temperature limit previously set for terminating the test. During the test, it was observed that the pump ran quietly and smoothly and there were no burning odors emanating from the pump. Upon shutdown, the coastdown of the outer shaft was smooth. A slight squeak was heard when rotating the shaft by hand; however, the noise disappeared after a few minutes of cooling. After dismantling the unit for inspection, light to moderate scoring was observed between the stationary and rotating bearings as shown in Table 5. Bearing wear was not measured during this test. Two additional repeat tests were performed using new bearing sets of the same test configuration (Tests 8 and 9). As shown in Table 6, nearly all wear occurred in the stationary bushings for these tests and ranged between 0.0004 in to 0.0008 in. This wear was evidenced by approximately ¼ tsp of black SiC powder that was found between the bearing running surfaces. A photograph of the SiC powder is shown in Figure 5. It is apparent that the ADLC coating has been worn away, at least in the stationary bushing, considering the degree of wear involved. However, despite this wear, the bearing set was still able to maintain its dry run performance. This may be attributed to the parts having lapped themselves together while operating, thereby eliminating any high spots and any minor amounts of edge loading present. The arrangement also shows that it has the ability to run dry even in the presence of solid particles, in this case, very abrasive SiC powder. Although bearing temperature will increase in the presence of solids due to the added friction involved, operating temperatures are still low enough to virtually eliminate the risk of thermal shock should liquid suddenly enter the pump. In addition, a reduced amount of axial bearing float, such as used in an open impeller design, would be highly desirable to reduce the risk of mechanical shock due to “slamming” of the rotor once liquid is admitted to the pump.

Repeatability Tests

As mentioned previously, duplicate tests were conducted (Tests 1, 8, and 9) to determine the repeatability of dry run performance

Table 5. Damage Assessment.

Test No.	IB Sleeve	OB Sleeve	IB Thrust	OB Thrust	IB Bushing	OB Bushing
1	Rotating light scoring	Rotating moderate scoring	Rotating slight shining	Rotating shined	Stationary light scoring	Stationary light scoring
2	shined	cracked	cracked	shined	slight chipping	slight scoring/chipping
3	chipped	cracked	shined	cracked	excellent	slight scoring/chipping
4	shattered	shattered	excellent	slight shining	cracked	cracked
5	cracked	cracked	excellent	excellent	excellent	slight scoring TFE strips worn
6	light scoring	moderate scoring	excellent	excellent	light scoring	light scoring
7	shined	chipped	excellent	chipped	shined	shined
8	light scoring	moderate scoring	shined	excellent	light scoring	moderate scoring
9	light scoring	moderate scoring	shined	excellent	light scoring	light scoring
10	light shining	light shining	light shining	light shining	light shining	light shining

Table 6. Silicon Carbide Bearing Wear.

Test #	IB Bushing (in)	OB Bushing (in)	IB Sleeve (in)	OB Sleeve (in)	Test Time Minutes	Peak OB Bush Temp °F	Peak IB Bush Temp °F
1	Not Measured	Not Measured	Not Measured	Not Measured	161	300	198
6	0.0008	0.0005	0.0002	0.0000	88 *	300	263
8	0.0008	0.0005	0.0001	0.0000	147	300	193
9	0.0004	0.0005	0.0001	0.0001	117	300	195
10	0.0001	0.0002	0.0000	0.0000	300	139	107

* Suction and Discharge Flanges Covered

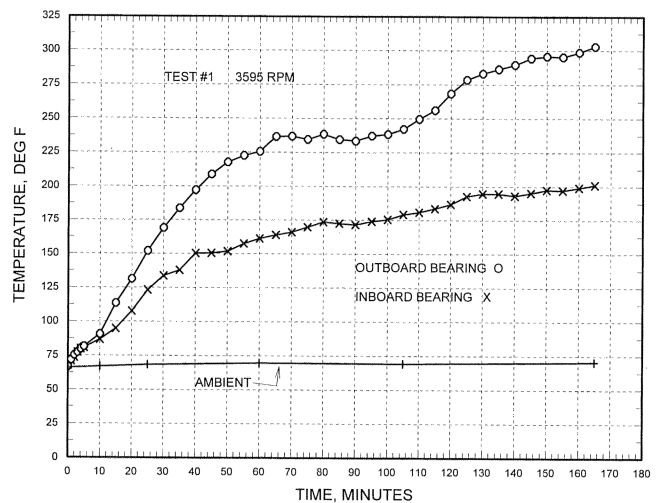

Figure 4. Bone-Dry Run Test—SiC(P) ADLC Stationary and Rotating Bearings.

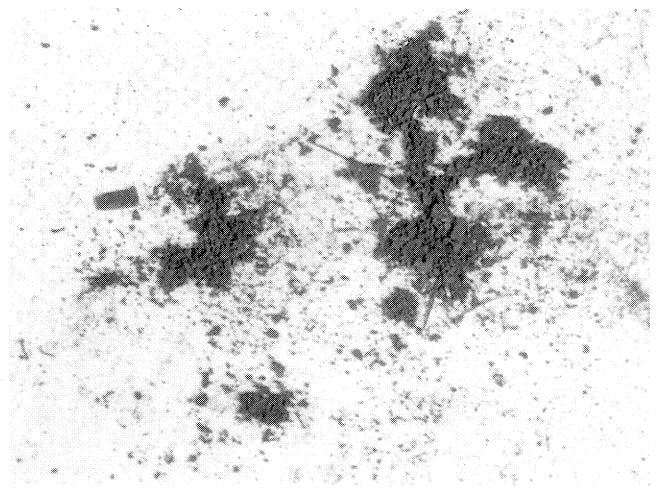

Figure 5. SiC Powder Observed After Testing.

for the ADLC SiC(P) vs ADLC SiC(P) bearing arrangement. It was found that the repeatability between these tests was reasonably consistent as shown in Figure 6. The bone-dry run times to reach 300°F were 161, 147, and 117 min, respectively, for Tests 1, 8, and

9. The average dry running time for this configuration was 142 min. As shown in Table 5, an inspection of the bearings after all three test trials found their condition to be very similar. The bearings were judged to be in good condition and it would be expected that they could be put into service without problem. It should be noted that the outboard bearing ran consistently hotter than the inboard bearing. This is attributed to the following:

- The dry PV rating is higher for the outboard bearing.
- The air movement caused by the impeller is more effective for the inboard bearing due to its closer proximity.
- The zirconium oxide containment shell tends to insulate the outboard bearing.

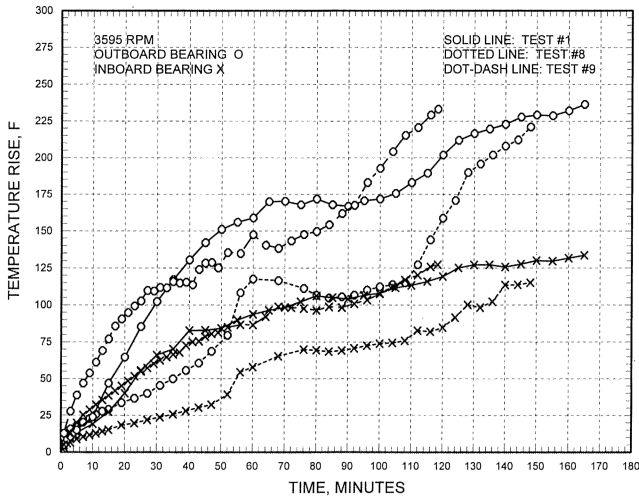

Figure 6. Bone-Dry Run Repeatability Tests—SiC(P) ADLC Stationary and Rotating Bearings.

Effect of Air Cooling

In an actual field installation, the degree of cooling attainable will depend on the volume of piping in the system and whether or not the discharge valve is open. Accordingly, a configuration was tested (Test 6) with the suction and discharge flanges covered with blind flanges to simulate a worse case condition, thereby greatly diminishing the cooling effect of the air flow. The results of this test are shown in Figure 7. The dry run time to reach 300°F was nearly 1.5 hr, which is very significant dry run protection under these unfavorable conditions. After dismantling the unit for inspection, the bearing condition was found to be very similar to Tests 1, 8, and 9 (with air flow). The bearing wear for Test 6 was a maximum of 0.0008 in.

Effect of Cycling

Test 7 was done to investigate the effect of cycling on dry run survivability. The dry run cycle chosen was two min of bone-dry running followed by at least a three min shutdown. The test was conducted for 80 cycles prior to inspection. This gave a total dry run operating time of 160 min, which is comparable in duration to Test 1. As shown in Table 5, the bearing condition for the cycle test was even better than that found in the continuous tests except for some chipping of the SiC sleeve and thrust bearings at the antirotation pin slot. This was easily remedied by installing larger diameter pins to decrease the effect of the pin impacts on the slot during start-stop operation.

ADLC on One Running Surface

Also of interest was the possibility of using the ADLC coating on only one of the running surfaces; i.e., either the stationary or

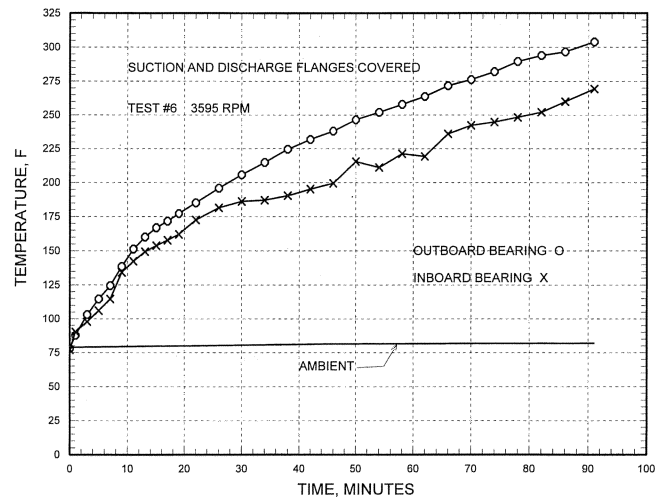

Figure 7. Bone-Dry Run Test with Flanges Covered—SiC(P) ADLC Stationary and Rotating Bearings.

rotating bearing, while using uncoated silicon carbide on the other running surface. This would be advantageous from a cost standpoint. Test 2 utilized the ADLC on the stationary bearings only, while Test 3 incorporated the ADLC coating only on the rotating bearings. Both of these configurations seized prematurely; however, there was no internal contact with the containment shell. As shown in Figure 8, the ADLC coating on the stationary bearing only (Test 2) seized in under 2.5 min. The ADLC coating on the rotating bearings only, fared much better. As shown in Figure 9, Test 3 ran bone-dry for 32 min prior to seizing. In both of these configurations (Test 2 and 3), the outboard sleeve bearing cracked as detailed in Table 5. Although the 32 min dry run time of Test 3 was much shorter than that achieved in Test 1 (161 min), an argument can be made that if monitoring is not provided, the unit will eventually fail in either case without manual intervention. Therefore, the configuration with ADLC coating on the rotating surface only may still have some merit, based on cost considerations, and would serve to reduce the cost per bearing set by at least half.

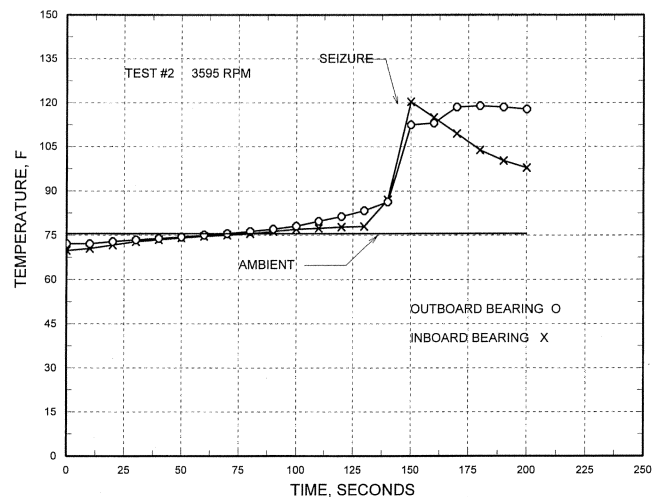

Figure 8. Bone-Dry Run Test—SiC(P) ADLC Coated Stationary vs SiC(P) Uncoated Rotating Bearings.

It should be noted that power monitors can be important protective devices in avoiding dry run failures provided they are properly set to detect this condition.

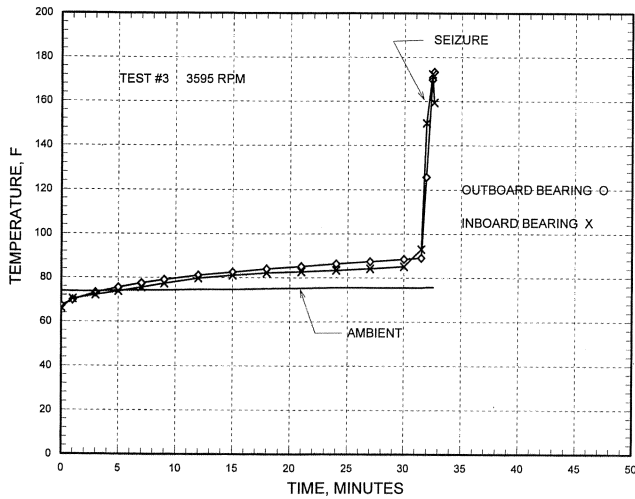

Figure 9. Bone-Dry Run Test-SiC(P) Uncoated Stationary vs SiC(P) ADLC Coated Rotating Bearings.

SiC(P) Baseline Test

A bone-dry baseline test (Test 4) was performed on the test pump at 3595 rpm with SiC(P) rotating and stationary bearings without the ADLC coating or Teflon® strips, in order to determine the extent of dry running possible with plain silicon carbide. Not surprisingly, this configuration seized in under five sec operation. It should be noted that the failure was too sudden to develop a meaningful data curve. An inspection of the parts showed this failure to be the most severe of all test configurations; however, no internal rubbing of the containment shell occurred. It was found that both sleeve bearings were shattered and both stationary bushings were cracked. The addition of Teflon® strips in the stationary bushing showed a remarkable improvement in bone-dry run performance (Test 5). As shown in Figure 10, this low cost configuration incorporating Teflon® strips with SiC(P) vs SiC(P) bearings without the ADLC coating, extended dry run operation prior to seizure from just under five sec to nearly four min.

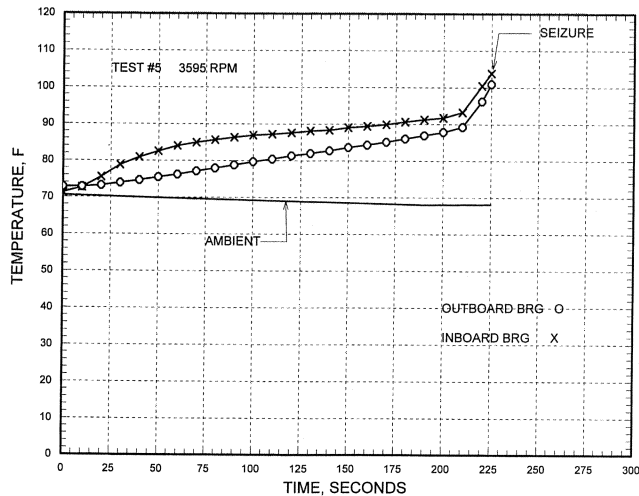

Figure 10. Bone-Dry Run Test-SiC(P) Uncoated Stationary and Uncoated Rotating Bearings with TFE Strips.

ADLC with Teflon® Strips

The final test configuration (Test 10) investigated the effect of adding Teflon® strips to the ADLC SiC(P) vs ADLC SiC(P)

bearings; the result offered a major advance in dry run technology. As shown in Figure 11, the outboard bearing temperature leveled off at only 139°F ($\Delta T = 58^\circ F$) after five hr of bone-dry run operation. The inboard bearing stabilized at 107°F ($\Delta T = 26^\circ F$). The test was stopped after five hours due to time constraints, but it was expected that this configuration would have continued to run bone-dry successfully for many more hours. It was noted that there was no squeak audible when turning the shaft by hand after the unit was shutdown, as was detected in previous tests. In comparison, the best performing ADLC SiC(P) vs ADLC SiC(P) test experienced an outboard bearing temperature which peaked at 300°F ($\Delta T = 233^\circ F$) and an inboard bearing which reached 198°F ($\Delta T = 131^\circ F$) after 161 min of operation (Test 1). As shown in Table 5, the bearings from Test 10 were found to be free from scoring and judged to be in very good to excellent condition (the best of all configurations tested), despite having been in dry run operation nearly twice as long as the longest lasting previous test (Test 1). A comparison of outboard sleeve bearings between Tests 1 and 10 is shown in Figure 12. As shown in Table 6, the amount of bearing wear for Test 10 after five hr of bone-dry run operation ranged from 0.0001 in to 0.0002 in. This is an eight-fold improvement in wear resistance over Test Configuration 8. One interesting observation that should be noted is that, during the dismantling inspection, there was barely any silicon carbide powder found between the bearing running surfaces as was so evident during previous tests. This explains why the bearing temperatures and wear were so low. The SiC powder, which gets trapped between bearing running surfaces, will increase friction and consequently operating temperature. Additionally, the very abrasive nature of the SiC powder will only tend to exacerbate wear further. Based on these test results, the introduction of the Teflon® strips appears to maintain a low friction and soft running surface even in areas where the ADLC coating has been abraded away. This helps to reduce the abrasion and grinding action of SiC against SiC, which lessens the formation of SiC powder; consequently reducing friction and heat buildup.

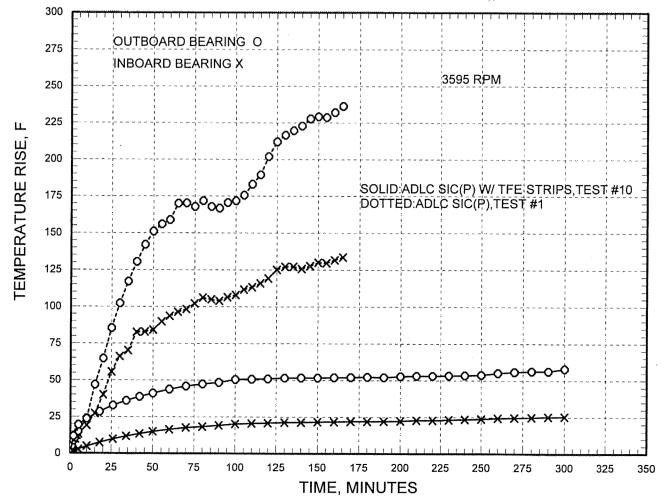

Figure 11. Test Comparison of ADLC SiC(P) and ADLC SiC(P) Coated Bearings with TFE Strips.

ADLC in Plastic Lined Magnetic Drive Pumps

Bone-dry run tests conducted with plastic lined magnetic drive pumps, such as shown in Figure 13, indicate that the plastic lining, normally 1/8 in to 3/16 in, has an insulating effect on the efficient transfer of heat away from the SiC bearings. The large difference in dry run performance between a lined and metal bearing carrier is shown in Figure 14. These plastic lined magnetic drive pumps

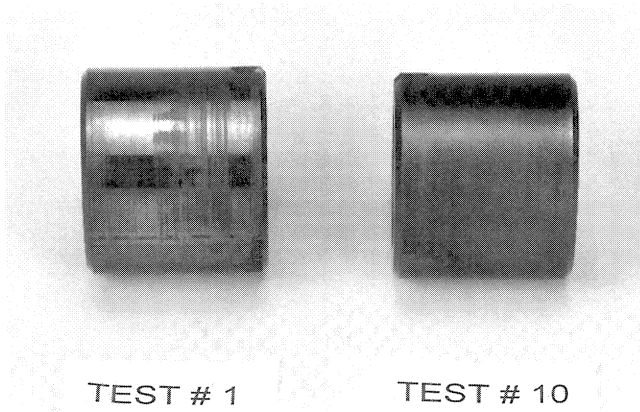

Figure 12. Comparison of Outboard Sleeve Bearing Condition-Tests 1 and 10.

are becoming increasingly popular. Plastic lining materials, such as PFA/PTFE, are available and offer the highest degree of confidence in a liner material, virtually inert to chemical attack. They can be applied in highly corrosive services up to 356°F. High performance plastic lined magnetic drive pumps can begin to become of economic importance when comparing their costs to pumps with metallurgies such as 316ss and alloy 20. A favorable cost benefit can be especially realized when comparing these pumps against metallurgies such as the Hastelloys and more “exotic” alloys, such as titanium and tantalum [4]. Inherent to a plastic lined magnetic drive pump is a nonconductive containment shell, which is essential to dry run survivability, as mentioned previously.

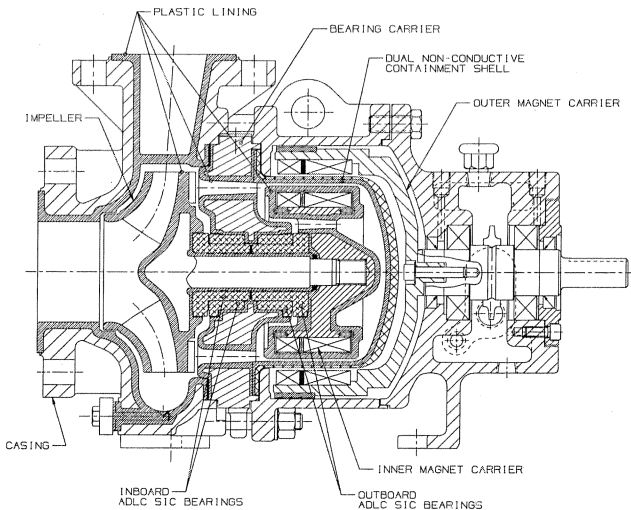

Figure 13. Plastic Lined ANSI Magnetic Drive Pump.

The 1990 and 1992 repair trends of magnetic drive pumps at a large German chemical plant [5] are shown in Figures 15 and 16. Manufacturer F, of plastic lined magnetic drive pumps, began to introduce the ADLC coating on SiC bearings during late 1990 and it was found that the repair frequency had fallen dramatically. During 1990, the repair frequency at this plant for Manufacturer F was 29 percent and had fallen to 11 percent during 1992, which represents a 62 percent reduction in failure rate. Although it is uncertain exactly what percentage of this reduction can be attributed to the ADLC coating and/or improvements in operating procedures and maintenance practices by plant personnel, it is

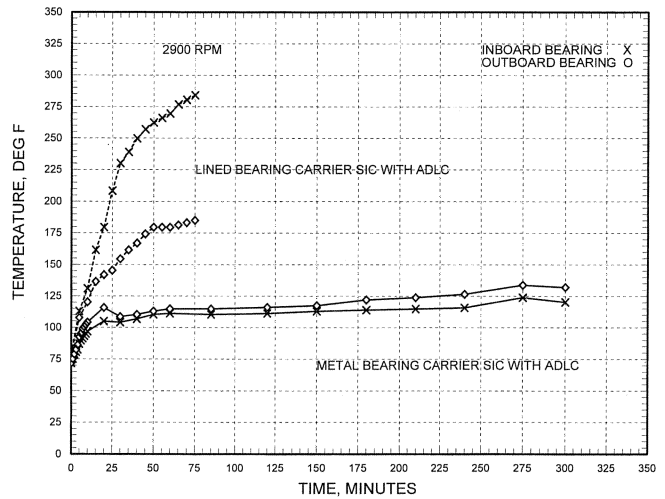

Figure 14. Bone-Dry Run Test Comparison with Lined and Metal Bearing Carrier.

clear that Manufacturer F had the largest reduction in failure rate among both metal and plastic lined magnetic drive pump suppliers at this plant. This same trend has been confirmed by this manufacturer at other chemical plants.

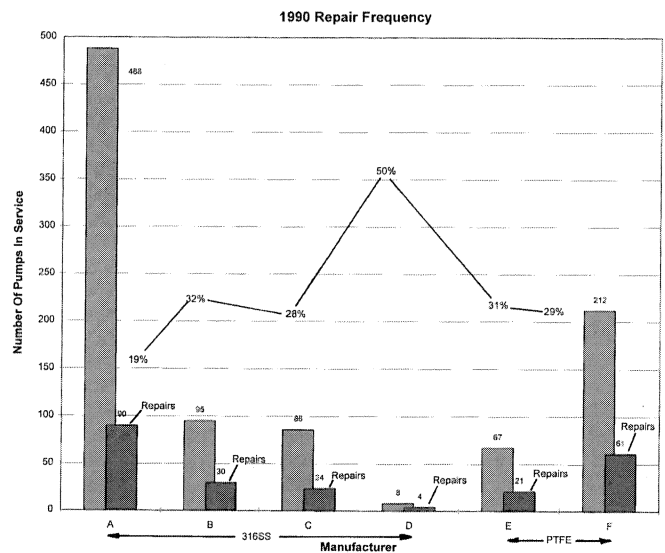

Figure 15. 1990 Repair Trends of Magnetic Drive Pumps at a Large German Chemical Plant.

CONCLUSION

Test results show that the bearing test configuration with Teflon® lubricating strips and ADLC SiC(P) vs ADLC SiC(P) bearings was superior to all configurations tested under bone-dry run operation. This bearing arrangement successfully ran bone-dry for five hr at 3600 rpm and had the longest operating time, lowest temperature rise, and least wear of all configurations tested. After examination of the unit, virtually no damage was found to the ADLC coated SiC(P) bearings and it was expected that the pump could have continued to run successfully in this condition for many more hours. The maximum temperature rise (ΔT) after five hr of bone-dry run operation, as measured at the OD of the stationary bushing, was 58°F for the outboard bushing and 26°F for the inboard bushing.

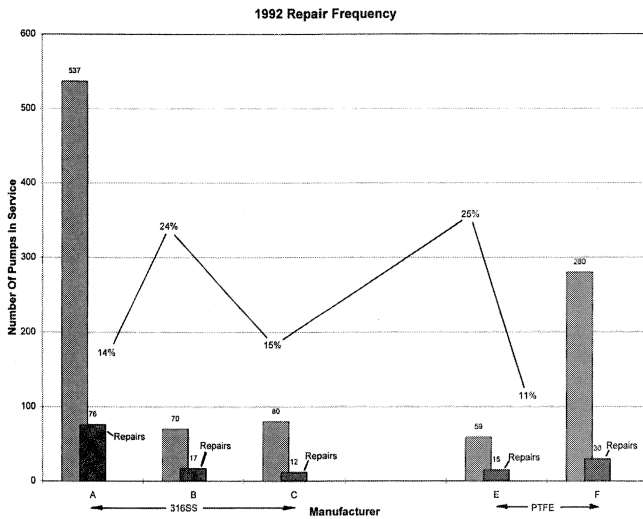

Figure 16. 1992 Repair Trends of Magnetic Drive Pumps at a Large German Chemical Plant.

The arrangement with ADLC SiC(P) vs ADLC SiC(P) bearings without Teflon® lubricating strips also performed well. This arrangement had a peak temperature rise (ΔT) of 233°F after 161 min of bone-dry run operation. Repeatability tests for ADLC coated SiC(P) bearings showed it to be reasonably consistent. By contrast, the manufacturers standard SiC(P) vs SiC(P) bearing arrangement without the ADLC coating or Teflon® strips failed in less than five sec operation and was found to have the most massive damage of all configurations tested. It should be noted that in *no test cases* did the inner magnet carrier have contact with the containment shell.

The test results are based on a $1.5 \times 1 \times 6$ ANSI magnetic drive pump operating at 3600 rpm with a calculated maximum dry PV value of 6500 psi ft/min. Although tests with higher dry PV values were not conducted, future tests are planned.

Prior experience by a plastic lined magnetic drive pump manufacturer indicates that the ADLC coated SiC bearings had significantly contributed toward a 62 percent reduction in failure rate during frequency of repair audits at a large German chemical plant. Similar experiences have also been confirmed at other chemical plants.

REFERENCES

1. Stavale, A. E., "Dry Running Tests Utilizing Silicon Carbide Bearings and Polymer Lubricating Strips with Conductive and Nonconductive Containment Shells in an ANSI Magnetic Drive Pump," *Proceedings of the Twelfth International Pump Users Symposium*, Turbomachinery Laboratory, Texas A&M University, College Station, Texas, pp. 77-82 (1995).
2. Lorenc, J. A. and Nelik, L., "Analysis and Testing of Alternative Bearing Materials for Application in Sealless Pumps," *Proceedings of the Eleventh International Pump Users Symposium*, Turbomachinery Laboratory, Texas A&M University, College Station, Texas, pp. 51-56 (1994).
3. Ooka, K. and Klein, M., "Operation Protection for Mag Drive Pumps," *Pumps and Systems Magazine*, pp. 30-34 (February 1996).
4. Stavale, A. E., "Plastic-Lined Mag-Drives," *Chemical Processing*, pp. 40-43 (December 1995).
5. Naasner, G., "Managing Extreme Requirements with Plastic Magnetic Coupling Pumps," *Fourteenth Technical Conference of the BPMA*, Birmingham, United Kingdom, pp. 483-498 (1995).