

DEVELOPMENT OF A TWIN HYBRID NONCONTACTING GAS SEAL AND ITS APPLICATION TO PROCESS PUMPS

by

Shifeng Wu

Senior Consulting Engineer

Christopher A. Kowalski

Consulting Engineer

A.W. Chesterton Company

Groveland, Massachusetts

and

Lynn E. Stafford

Senior Mechanical Inspector

Shell Chemical Company

Geismar, Louisiana

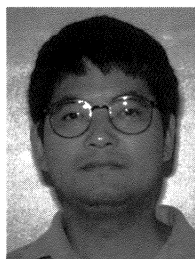

Shifeng Wu is a Senior Consulting Engineer with A. W. Chesterton Company, in Groveland, Massachusetts. He has been performing product research, design, and analysis there since 1996. Prior to joining A. W. Chesterton Co., he was employed by John Crane Inc. in the capacities of Development Engineer, Consulting Engineer, and Senior Consulting Engineer for about five years.

Dr. Wu holds an M.S. degree (1986) and a Ph.D. degree (1990), both in Mechanical Engineering, from Northwestern University.

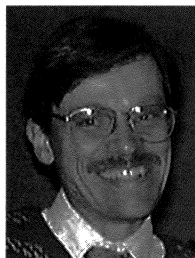

Christopher A. Kowalski performs the function of Consulting Engineer, presently employed at A. W. Chesterton Company, in Groveland, Massachusetts. He provides research and development project management. The application of close film gas sealing technology to pumps and compressors has been a focal interest since 1990. He also has 15 years of high-pressure compressor design and maintenance in his experience.

Mr. Kowalski is a graduate of Stevens Institute of Technology and a member of ASME and STLE.



Lynn E. Stafford is a Senior Mechanical Inspector for Shell Chemical Company, in Geismar, Louisiana. He has been with Shell for more than 21 years, working in maintenance, machinist-training, machine shop supervision, inspection, and engineering.

Mr. Stafford, at the present time, is a focal point on the Shell/Equilon/Motiva/SSI Seal Committee.

ABSTRACT

In this paper, an innovative approach of applying gas-lubricated, noncontacting sealing technology to process pumps is presented, in which a novel "twin hybrid" design is incorporated to address the issues of gas seal applications to process pumps. In this design, orifice-injected inert barrier gas between concentric twin seal faces gives rise to hydrostatic action, so that the inner seal face with hydrodynamic lift features upon running can initiate and maintain stable face separation, even at extremely slow speed. The outer plain face seal, by way of higher barrier gas pressure, prevents any process fluid on the outer diameter cavity from leaking or emitting through sealing faces. The twin face design compacting two seals to one seal ring not only reduces greatly the cartridge size so as to fit all pumps without stuffing box modifications, but maintains its dual seal functionality with the single seal simplicity. The hybrid feature combining hydrostatic action for start/stop and slow speed operations, and hydrodynamic action for initiating and maintaining stable face separation not only enhances the sealing performance, but also expands its application ranges. Detailed design features and operating principles including reducing O-ring hysteresis and pressure reversal or loss-of-barrier gas are discussed.

Extensive laboratory and field tests were conducted to validate the designs. A field test is described to exemplify its applications in process pumps including its performance in abnormal operating conditions.

INTRODUCTION

Noncontacting gas lubricated mechanical face seals have been in use since the 1960s, primarily in high speed and high pressure applications such as centrifugal gas compressors, expanders, and turbines (Cheng, et al., 1968; Shapiro and Crolsher, 1971; Gardner, 1973; and Sedy, 1978). In those applications, ordinary face seals overheat because of the intolerable face contact. Like gas bearings, there are basically two types of gas lubricated mechanical seals: hydrostatic design and hydrodynamic design. Both hydrostatic and hydrodynamic designs incorporate face surface features to boost interface pressure and film stiffness within the interfacial fluid film between mating faces (Cheng, et al., 1968).

A hydrostatic seal typically has features designed to modify interface pressure distribution radially to generate film stiffness, regardless of relative motion between seal faces. Two notable examples of this category are orifice-compensated hydrostatic seal

(Figure 1(a)) and radial Rayleigh step hydrostatic seal (Figure 1(b)). The former seal relies on orifices to introduce either internal upstream gas or an external gas with a higher pressure into the interface to boost the hydrostatic pressure profile. These properly sized orifices also act as restrictors or compensating elements to generate film stiffness within the fluid film.

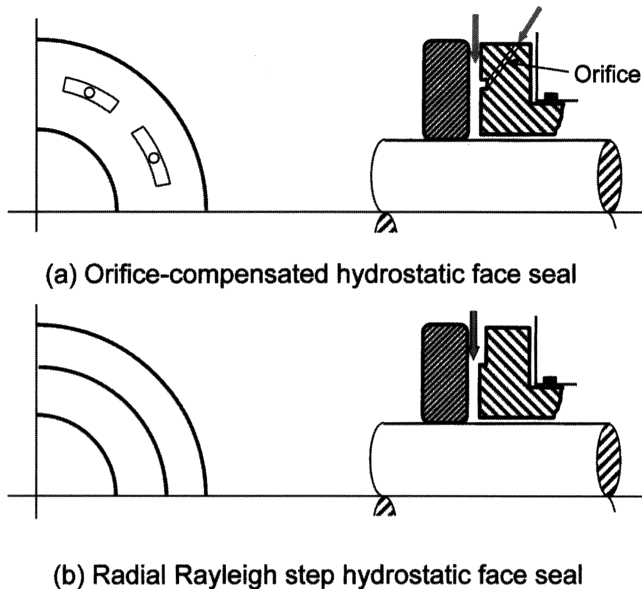

Figure 1. Examples of Hydrostatic Seals.

The principle of operation of an orifice compensated hydrostatic seal is illustrated in Figure 2, in which the axial force balance on the floating component of a single seal with pressure distributions is shown. In this figure, F_c and F_o represent the closing and opening forces, respectively; p_p is the sealed fluid pressure; p_a , the atmospheric pressure; p_s , converted spring pressure; and h , film thickness, with h_o being the referenced film thickness. From this illustration, it can be seen that the interfacial pressure distribution of an orifice compensated hydrostatic seal lies between high-end pressure and somewhat of a linear drop, as if there were no orifices. Seals of this design behave such that when the film thickness decreases, the pressure at the recess increases, and when the film thickness increases, the interface pressure decreases. This behavior gives rise to film stiffness, which is essential to the existence of a fluid film so that no contact occurs at design operating conditions. The latter uses a step surface geometry to form a converging fluid film in the flow direction to boost hydrostatic pressure and promote film stiffness.

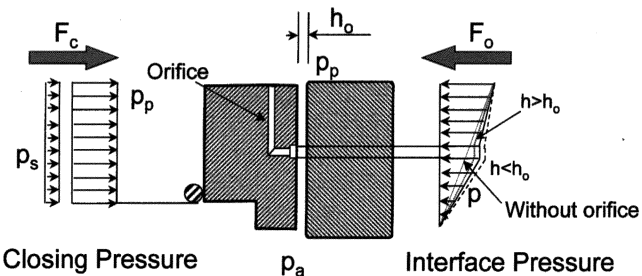

Figure 2. Operating Principle of Orifice-Compensated Hydrostatic Seal.

Hydrodynamic seals use relative motion between uneven sealing surfaces circumferentially to generate pressure rise and film stiffness in the interface. The most widely utilized hydrodynamic

surface patterns are of the spiral groove and circumferential Rayleigh pad designs, as shown in Figure 3. The operating principle of spiral grooved hydrodynamic seals is similar to that of the well-known spiral grooved thrust bearing (Muijderman, 1967) and is depicted in Figure 4. Similar to that in Figure 2, Figure 4 shows the axial force balance on the floating component of a single seal with pressure distributions. The nomenclature in this figure is the same as that in Figure 2. Relative motion between sealing faces causes the fluid to be pumped in the grooves because of viscous shearing and pressure gradient across the seal face. When the flow in the grooves reaches the sealing dam, which provides a restriction against the flow, pressure buildup occurs. In the circumferential direction, viscous flow crosses groove-land step bearings, which also generate pressure increases. These pressure augmentations increase with a decreasing film thickness and decrease with an increasing film thickness, thus result in a strong film stiffness that is essential to a continuous noncontacting operation, irrespective of operating condition changes. The Rayleigh steps work in somewhat the same fashion as that of spiral grooves.

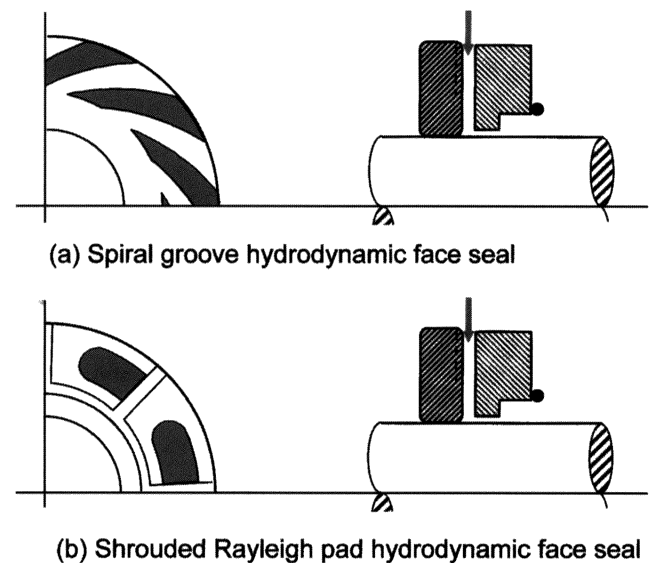

Figure 3. Examples of Hydrodynamic Seals.

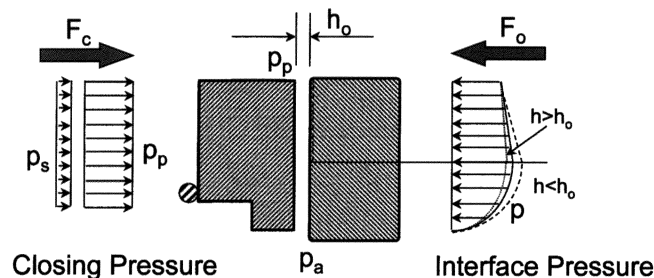

Figure 4. Operating Principle of Spiral Groove Hydrodynamic Seal.

The main characteristics of noncontacting face seals are their abilities of generating stiffness within the fluid film and operating in rather close clearance without any contact (Cheng, et al., 1968). These features manifest themselves in the ability of dynamic tracking, negligible interfacial heat generation, and wear at the expense of some small leakage, which, in fact, must occur to maintain a continuous fluid film. These are also the primary reasons why noncontacting face seals have been in use in applications of high speed and high pressure, such as gas

compressors. However, recent advances in noncontacting gas seal designs make them possible to be adapted for use in process pumps in the form of gas barrier seals (Wasser, et al., 1994; O'Brien and Wasser, 1997).

This paper presents a novel design with laboratory tests of a coplanar gas lubricated noncontacting, "twin hybrid" mechanical seal, in which two concentric seals are incorporated in one common ring and both hydrostatic and hydrodynamic actions are combined for face separation. Its applications to process pumps for fugitive emission containment and other purposes are also discussed.

GAS BARRIER SEALS FOR PROCESS PUMPS

The acceptance of gas barrier seals in process pump applications is, to a large degree, due to the increasingly stricter limits on fugitive emissions in process plants by the governments (EPA, 1991). Concerns about product contamination and operating costs, because of the use of liquid barrier fluids in traditional seal selections, are other factors that gas seals are gaining acceptance among plant maintenance engineers. Ultimately, it is the reliability, longevity, and low power consumption of noncontacting gas lubricated seals that dictate their applications in process pumps.

Traditionally, either single or dual contacting liquid seals can be selected for fugitive emissions containment, depending on the emission level requirements and the specific gravity of sealed fluid (STLE, 1990; Key, et al., 1992; Surprise and Krogel, 1993). Single contacting liquid seals are the most economical selections for sealing, if a certain amount of product emission to atmosphere can be tolerated. A properly designed single seal can limit product emission to below 1000 ppm, and in some applications, an emission reading of less than 100 ppm can be achieved. Dual seals, either with unpressurized buffer fluid or pressurized barrier fluid, can achieve zero emissions if equipped with appropriate environmental control systems. A dual seal with unpressurized buffer fluid is typically used in situations where process contamination by buffer fluid is intolerable and needs a vapor recovery system to achieve near zero emissions. A dual seal with pressurized barrier fluid is typically used for zero emissions where a certain amount of barrier fluid leaking into product is tolerable.

The apparent shortcomings of using liquid contacting seals are the high face wear and high frictional energy consumption due to heavy face contact. High face wear shortens seal life and can be a source of process contamination. High energy consumption manifests itself in interface heat generation. This heat input raises significantly the face temperature and the process fluid temperature within the stuffing box, resulting in thermal degradations of process fluid and elastomeric O-rings, and eventually seal failure. To alleviate thermal induced abnormalities, maintenance intensive, costly buffer/barrier liquid support systems have to be utilized to increase circulation and take heat away from the sealing area.

In response to the obvious deficiencies of using conventional contacting seals for emission control, dry-running, noncontacting gas barrier seals were developed for process pump applications (Wasser, et al., 1994). Advantages of using a dry-running, noncontacting gas barrier seal in lieu of a liquid contacting seal are apparent because of the absence of physical contact in the former. They include negligible seal face heat generation and wear, low torque/power consumption, and the elimination of maintenance intense, costly liquid support systems. More important, the existence of a thin fluid film with certain stiffness in the gas seal interface makes it operate with stability as process conditions vary.

In a typical gas barrier seal for pumps, there are two sets of seal faces arranged in the back-to-back fashion as that illustrated in Figure 5. The product is sealed on the inside diameter of the inboard seal by way of barrier gas, with higher pressure running through a hydrodynamically designed inboard seal. The outboard seal has also hydrodynamic features on its sealing face and its sole purpose is to contain barrier gas pressure (Wasser, et al., 1994).

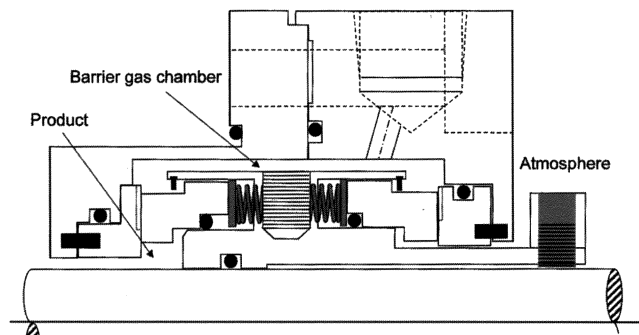

Figure 5. Schematic of a Typical Gas Barrier Seal for Pumps.

Although most gas barrier seals currently available on the market for pumps have the appearance of dual seals (back-to-back arrangement), they do not at all function like dual contacting liquid seals. Typically, the outboard seal in a dual liquid seal assembly is expected to take the full duty in the event of the inboard seal failure. In a gas seal, however, either inboard or outboard seal failure will result in the whole seal assembly becoming inoperable, for the outboard noncontacting seal merely maintains a barrier gas chamber and cannot be used as a backup seal. Another notable feature of gas barrier seals is the shifting dynamic O-ring on the inboard seal for double balancing, in case of pressure reversal or loss-of-barrier gas. While the dynamic O-ring shifting does keep the inboard seal faces closed when pressure reversal or loss-of-barrier occurs because of double balancing, this dynamic O-ring may not shift back to its proper position, due to possible product contamination when the barrier gas supply is restored. This may cause the often mentioned O-ring hangup gas seal failure.

TWIN HYBRID GAS BARRIER SEAL DESIGN

As elaborated in the previous section, most process pump gas seals are direct adaptations of those for large gas compressors. These adaptations are not without compromise. For example, most barrier gas seals for pumps require larger physical space both radially and axially to fit to a process pump. That is due to the wider face width of a gas seal compared with the narrower face width of a liquid seal, and also to the fact that there are two sets of seals arranged axially for a gas barrier chamber. The fact that all the gas barrier seals for pumps have products sealed at the inner diameter of the inboard seal makes it a less desirable design, particularly for a sealed product with solids in the event of loss-of-barrier or pressure reversal.

Realizing the shortcomings of the existing designs, a great deal of effort was made in researching all existing gas and liquid mechanical seals, including their arrangement. Under stringent criteria of designing a new noncontacting, gas-lubricated barrier seal for process pumps, a concentric coplanar configuration was the most promising candidate (Greiner, 1971), for the new seal was to fit all existing pumps and to seal the product on its outer diameter. By combining two seals in one seal ring, the axial length can be reduced to a single seal configuration. By introducing a barrier gas with a higher pressure to the seal interface between the twin sealing faces, the product can be sealed at the outer diameter of the seal assembly. The challenge lies in reducing the radial dimension to fit all existing pumps and yet to have enough face width for a workable noncontacting gas seal.

Description of Twin Hybrid Seal Design

Numerous twin face configurations, including those having hydrodynamic features on both seals, were exploited before the realization that one face can be maximized for maximum hydrodynamic action to generate pressure and film stiffness. The other face can be a plain seal face to merely provide a restriction to the gas flow. Although the hydrodynamic surface features can be

placed in either the lower or upper face of the twin seals, it is preferable that they be placed in the lower face as shown in Figure 6 for process pumps, because of loss-of-barrier considerations that will be discussed in more detail later. In this design, an enclosed spiral groove pattern is selected to provide hydrodynamic action for its ability to generate greater loading capacity and film stiffness than any other type. Figure 7 shows the enclosed spiral grooves for both clockwise and counterclockwise rotations on the rotary, which is typically made of hard materials such as silicon carbide or tungsten carbide. There are two seal rings in the whole assembly configured in a single compact cartridge seal arrangement. The barrier gas is injected through a series of holes equally spaced circumferentially on the floating stationary to an annular groove that separates the twin seals incorporated into these two seal rings. The upper interface seals the product by way of a pressure differential between barrier fluid over product on the outer diameter, and the lower interface seals the barrier fluid from the atmosphere. The floating stationary seal ring is typically made of carbon graphite and can also be made of silicon carbide or tungsten carbide, if so desired.

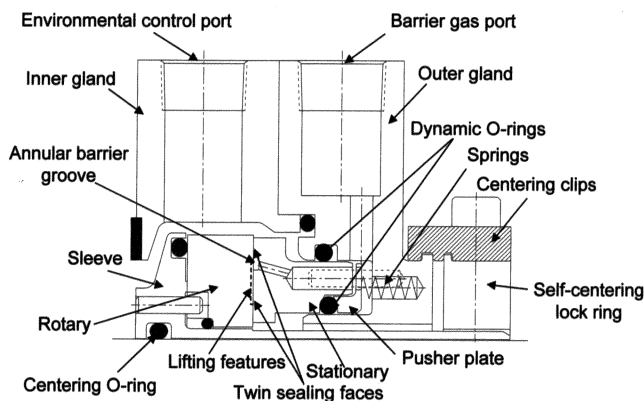

Figure 6. Configuration of Twin Hybrid Gas Barrier Seal.

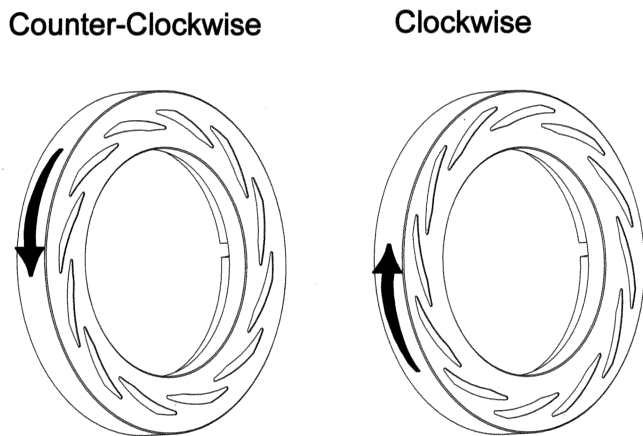

Figure 7. Enclosed Spiral Groove Patterns on Rotating Seal Face.

There are two dynamic O-rings on the floating stationary seal ring, one separating the barrier gas from the process and the other separating the barrier from the atmosphere. Special attention was paid to the functions of these two O-rings, since dynamic O-ring hangup is a major failure mode of any gas-lubricated mechanical seal. The upper O-ring is captured in an O-ring groove for pressure reversal or loss-of-barrier situations. Since normally there is only a small pressure differential (about 1.4 bar or 20 psi) across this O-ring and a micropolish process gives the O-ring surface on the seal ring an RMS finish of 0.1 μm to 0.2 μm (4 μin to 8 μin), the

O-ring friction has been reduced to a minimum. The lower O-ring, which experiences the highest pressure differential and is in contact only with clean barrier gas, is springloaded by a special loading mechanism. This O-ring is urged by a series of springs, via a pusher plate, toward the back of the stationary seal ring in such a way that sealing occurs only at two locations: the back of the seal ring and the O-ring surface of the outer gland. Special features fabricated on the back of the seal ring and the pusher plate urge the O-ring into contact with the aforementioned sealing spots with a controlled O-ring squeeze that accommodates the O-ring and component dimensional variance. This minimizes O-ring hysteresis and ensures the O-ring functioning the desired way. This significantly reduces the possibility of dynamic O-ring hangup.

Compared with the product fluid being sealed at the inner diameter of the seal face, it is advantageous to seal the product at the outer diameter of the seal ring for pumps. In the former case, heavy particles in the process and the fluid itself tend to work their way more easily into the seal interface, and in the latter, they tend to be centrifuged away from the interface, especially in conjunction with the use of an environmental control port. This environmental control port can be piped not only to take away solids, but for heat dissipation as well, particularly when the outer seal is running in contact, in the event of loss-of-barrier gas pressure.

It is well known that a convergent film profile in the direction of flow offers a statically stable film for noncontacting gas seals. Therefore, the deflection of seal faces must be well controlled, for they cannot rely on wear to facilitate the final face adjustment like that of a contacting seal. The seal face deflections are controlled through careful positioning of the two dynamic O-rings, the O-ring on the back of the rotary, and the rotary support through sophisticated computational means.

Principle of Operations

Like most hydrodynamic noncontacting mechanical seals, this twin hybrid seal maintains face contact at static condition because of the biased spring force and overall pressure balance as illustrated in Figure 8, in which force balance on the floating stationary seal ring is shown. The pressure distribution curves on the right hand side depict those forces acting on the back side of the stationary as the closing pressures, where p_p is product pressure; p_b , the barrier pressure; p_s , the spring load induced pressure through the lower dynamic O-ring. The summation of all the closing components gives rise to the closing force, F_c . The pressure distribution profiles on the left hand side depict those in the seal interface acting on the face of the floating stationary seal ring as the opening pressures, where p is the interfacial hydrostatic pressure and p_c , the face contacting pressure. The dotted line represents the hydrostatic pressure drop if there were no spiral grooves in the interface. The integration of these interfacial pressure profiles over the seal face produces the opening force, F_o , which is always equal to F_c , the closing force. Keeping the faces in contact at static condition not only eliminates noticeable barrier gas consumption when machinery is not running, but more important, it ensures the initiation of hydrodynamic liftoff of seal faces upon running.

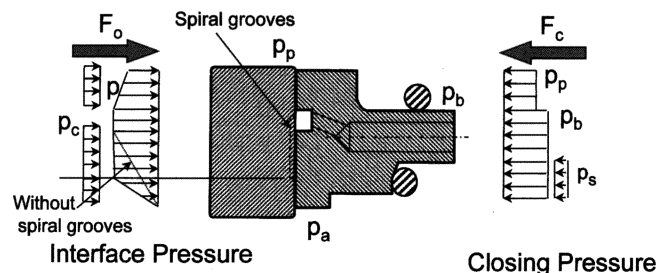

Figure 8. Principle of Operation—Static Condition.

The dynamic operation provides the relative motion in the seal interface necessary for the spiral grooves to hydrodynamically generate additional pressure increases in the circumferential direction. This hydrodynamic contribution, illustrated in Figure 9 as the portion superimposed on the usual hydrostatic pressure drop, initiates at start and then maintains, subsequently, a thin fluid film between seal faces for stable noncontacting operations. The deflection of the seal faces is controlled in such a way that, upon face separation, a slight convergent fluid film profile exists so as to maximize the spiral groove generated loading capacity and film stiffness.

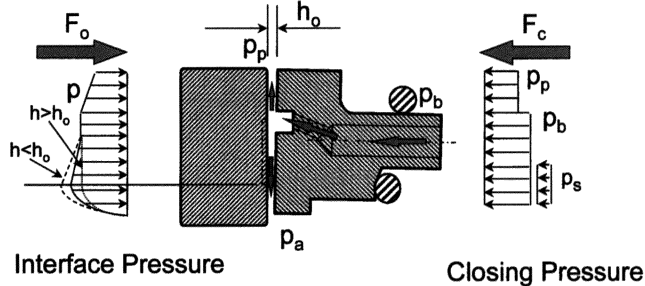

Figure 9. Principle of Operation—Hydrodynamic Action.

At normal operating conditions, the closing pressure distributions remain the same as those at static condition, as shown on the right hand side of Figure 9. The opening pressure profiles, however, take a totally different appearance: the contacting pressure disappears due to the lack of physical contact between sealing faces. The fluid film stiffness arises from the fact that this type of hydrodynamic pressure generation either increases or decreases, depending on whether the interfacial film thickness or gap is closing down or opening due to process pressure fluctuations or shaft excursions. Namely, a self-regulating mechanism exists within the hydrodynamically generated fluid film, which tends to bring the film thickness about its designed level whenever there is any system upset. It is not difficult to see the importance of a strong fluid film stiffness in a noncontacting seal, for it can affect significantly the seal's abilities of dynamic tracking and stable operations, regardless of operating condition changes.

The injection of a higher barrier gas pressure to an annular groove between the twin seals in the interface provides an active hydrostatic action. The hybrid design combining a maximized hydrodynamic action with an active hydrostatic action provides the seal with properties that either one alone does not possess. Especially with severe constraint in radial space, the ability of generating hydrodynamic action is somewhat limited. A strong hydrostatic action affords the seal with relatively less hydrodynamic action to initiate seal face separation. In this hybrid design, a change in pressure differential between barrier and process boosts the hydrostatic contribution to the opening force and thus results in an increase in operating film thickness, as shown in Figure 10. In this figure, the operating film thickness of h_1 and h_2 corresponds to the two levels of barrier pressure, p_{b1} and p_{b2} , and two levels of opening pressure, p_1 and p_2 , respectively. In Figure 10, there is also an unloading feature that further augments the active hydrostatic action when there is an increase in pressure differential. One benefit of having an adjustable pressure differential in this hybrid design is that, by increasing this ΔP , the augmented hydrostatic action compensates for lower hydrodynamic action in start/stop and slow speed operations. Hence, the liftoff speeds can be adjusted according to applications, simply by changing the pressure differential without physical modification to the seal.

Loss-of-barrier or pressure reversal conditions are some of the major causes of gas-lubricated seal failures in process pump applications. Care was taken in developing this twin hybrid seal of

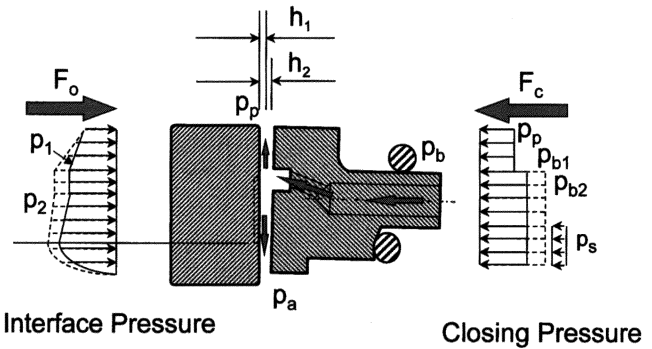

Figure 10. Principle of Operation—Hydrostatic Action.

a design that tolerates the abnormal conditions of loss-of-barrier or pressure reversal, and then recovers when normal condition is restored. When loss-of-barrier gas is experienced, the seal is designed to form a divergent profile in the interface, such that contact occurs on the outer seal of the stationary seal ring under modified pressure boundary conditions as shown in Figure 11. This pressure-caused face deflection at loss-of-barrier condition is designed to be large enough so that the subsequent thermal coning due to outer face contact cannot overcome it in the design operating ranges. That is, the seal reverts to a contacting narrow liquid sealing mode in response to barrier gas supply interruptions.

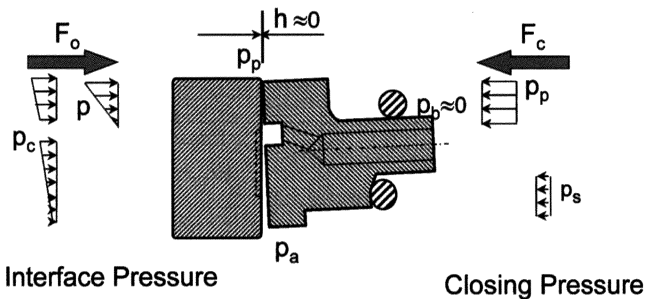

Figure 11. Principle of Operation—Loss-of-Barrier Condition.

This is in contrast with conventional gas barrier seals that rely on dynamic O-ring shifting to adjust the balance line, and maintain face closure in event of pressure reversal and loss-of-barrier. These seals may not recover when the gas supply is restored, because of the possible dynamic O-ring contamination by-product and face wear in the grooved interfaces. The twin hybrid design, on the other hand, will recover to its intended operation when the gas supply is restored. It relies solely on pressure caused seal face deflections to provide the desired convergent interface profile as the proper barrier gas pressure is reestablished. The outer seal on the common stationary ring, to a large degree, provides a restriction to limit barrier gas flow to process in normal operating condition, and is not susceptible to the type of wear experienced by a typical contacting liquid face seal.

Barrier Gas Consumption

The barrier gas consumption of the twin hybrid seal is relatively low, comparable with other barrier gas seals currently available on the market. Like any mechanical face seal, the fluid flow across seal faces is dominated by Poiseuille flow, which is pressure gradient driven. The Couette (shear) flow affects leakage rate indirectly by changing the interfacial film thickness, especially for hydrodynamic noncontacting gas seals. For the twin hybrid seal, most of the inert barrier gas introduced to the annular barrier groove goes to the environment, while the rest leaks into the process fluid. This is because the pressure differential between the barrier and the atmosphere is much higher than that between the barrier and the

process. Shown in Figure 12 are graphs of the calculated total barrier gas usage and the amount that seeps into the process as a function of process pressure for three different size seals. These curves are at normalized condition of ambient pressure and room temperature, with a rotating speed of 3600 rpm and a pressure differential of 1.4 bar, or 20 psi, between the barrier and the process. The increase in barrier gas consumption with increasing process pressure as displayed in these graphs is typical for a compressible fluid passing through a small gap. It is proportional not only to the pressure differential between the two ends of the gap, but to the average gas pressure passing through it as well (Lebeck, 1991). A comparison between some of the calculated barrier gas usage rates with those experimentally observed will be shown later.

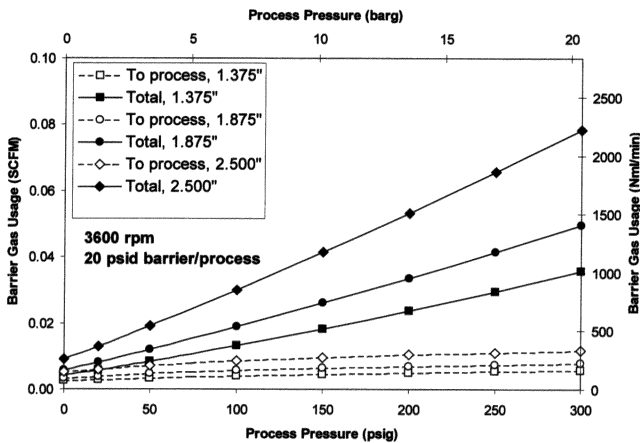

Figure 12. Estimated Barrier Gas Usage Rate.

LABORATORY TESTS

The 1.875 inch (48 mm) shaft diameter twin hybrid gas seal was modified slightly to allow for instrumentation to monitor the seal performance. A thermocouple was put on the stationary seal face near the inner diameter of the seal ring, along with the necessary routing for the thermocouple wires. The rotary seal ring was made of sintered silicon carbide with enclosed spiral grooves fabricated on it, and the stationary seal ring was made of metallized carbon graphite. The seal was installed in a test stand that consisted of a 3550 rpm 5 hp motor, a pump frame, and a pressure chamber, as shown in Figure 13. The product pressure to be sealed was generated using a positive displacement pump and regulated with a back pressure control regulator and a bypass line. The temperature of the product could be controlled with a heater in the product reservoir.

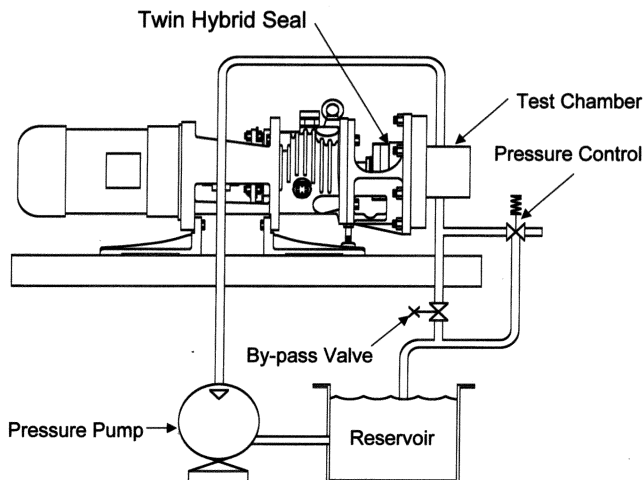

Figure 13. Configuration of Twin Hybrid Gas Seal Test Rig.

A barrier gas supply manifold was utilized in testing of the twin hybrid gas seal. A pressurized bottle of nitrogen was the source of the inert gas, passing through a 5 μm filter and a checkvalve, as illustrated in Figure 14. The pressure of barrier gas to the seal was controlled using a differential pressure regulator, with a reference to the product in the pressure chamber. The flowmeter monitored the usage of barrier gas. To facilitate ease of operation of the test stand, flexible lines were used. The data acquisition system with the associated thermocouples and pressure transducers monitored the system performance and operating parameters during the tests.

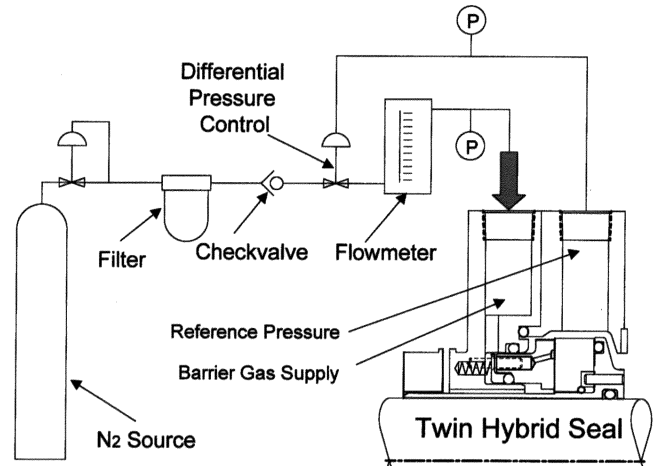

Figure 14. Barrier Gas Control Schematic for Laboratory Tests.

The twin hybrid gas seal was installed in the test stand with a pressure monitor in the gauge port on the seal gland housing. The installation was typically made following a standard procedure for single cartridge seals. A self-centering lock-ring was used to position and clamp the seal rotary components to the pump frame shaft. The seal centering clips positioned the stationary gland housing for testing. The environmental port on the adapter housing was not used during the characterization tests of the twin hybrid seal.

The twin hybrid gas seal was characterization tested by rotating the shaft at 3550 rpm and cycling the water pressure in the test chamber by adjusting the pressure control valve. The differential from barrier gas pressure to process pressure was maintained at 15 psi to 20 psi (1 bar to 1.4 bar). The resulting barrier gas flow is summarized in Figure 15, which indicates a maximum seal usage of 2 scfh (940 Nml/min) at 200 psig (14 barg) process pressure and an average of 0.8 scfh (380 Nml/min) at 100 psig (7 barg) process pressure. These seal gas usage levels are indicative of close film operation with a good balance of inboard and outboard film thickness. The flow demonstrated a general increasing trend with increasing process pressure as would be expected. Shown in Figure 15 is also the calculated barrier gas usage rate for 1.875 inch (48 mm) size twin hybrid gas seal running at 3550 rpm. A good correlation between theoretical prediction and experimental observation can be seen. The same figure shows the temperature differential between the thermocouple mounted to the stationary seal ring and a thermocouple in the process fluid. The temperature differential remains steady at less than 1°F (0.5°C) throughout the operating range of process pressure, as would be typical of noncontacting gas lubricated operation.

Successful loss-of-barrier gas operation was demonstrated by shutting off the nitrogen supply to the test stand while the seal was operating at 3550 rpm and 100 psig (7 barg) process pressure, as can be seen in Figure 16. The barrier gas pressure dropped to 0 psig, while the process pressure remained at 100 psig (7 barg). No barrier gas usage was registered at the flowmeter and no leakage of process fluid out of the seal was observed. The seal face has

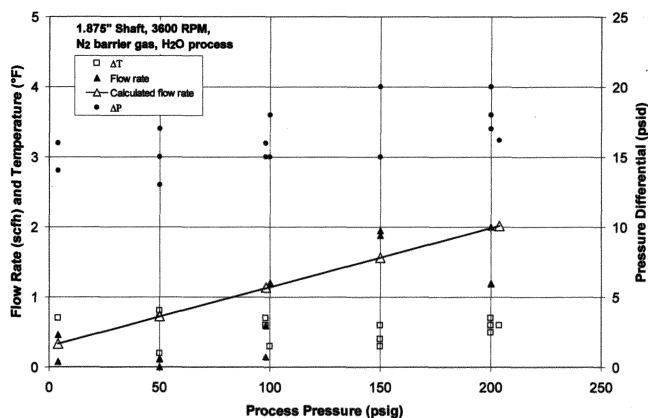

Figure 15. Twin Hybrid Seal Characterization Test Results.

converted from gas-lubricated noncontacting to a contacting seal on the inboard seal face. This operation results in an increase in differential temperature of the seal ring to the process fluid from a typical 1°F to 8°F (0.5°C to 4.5°C) and an increase in the temperature of the process from 95°F to 130°F (35°C to 55°C) as the seal face contact produced more frictional horsepower. After operating for approximately 0.3 hours in a loss-of-barrier condition, the barrier gas was restored to the twin hybrid seal. The twin hybrid seal face returned to normal operation with the barrier gas flow returning to previous levels, indicating that no face damage occurred. The temperature differential returned to normal and the process temperature started to decrease to previous levels with the absence of the high frictional horsepower of a contacting seal. Repeated loss-of-barrier cycles gave similar results, demonstrating that the twin hybrid seal can seal the process, survive, and recover from loss-of-barrier or pressure reversal conditions. Subsequent inspection of seal faces upon disassembly revealed no significant damages to either sealing face.

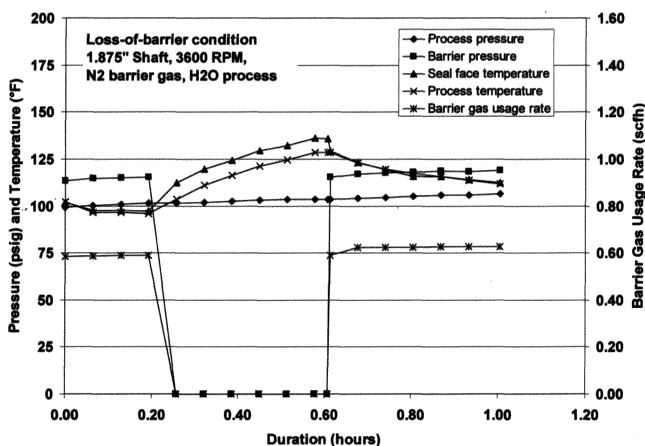

Figure 16. Twin Hybrid Seal Test Results at Abnormal Condition.

Additional testing has been completed to verify the twin hybrid gas seal performance under varying and off-design conditions. They include running air as the product, pump cavitation testing, vacuum testing, API 682 type propane testing (API, 1994), slow speed operation, and overpressure to 450 psig (31 barg). The twin hybrid gas seal surpassed expectations and demonstrated extraordinary robustness and adaptability to operating conditions.

FIELD TESTS

A total of 12 applications ranging from methanol to sodium hydroxide were selected for field tests. The operating conditions,

sealed products, and operation status of those field tests with customers' consents are listed in Table 1. The seal sizes for all the field tests were either for 1.875 inch (48 mm) shaft diameter (10 units) or for 2.500 inch (63.5 mm) shaft diameter (2 units). However, only the field test at Shell Chemical, which is listed as field test number one in Table 1, will be described in detail to typify the twin hybrid gas seal's applications in process pumps, including its performance in abnormal operating conditions.

Table 1. List of Field Tests of Twin Hybrid Gas Barrier Seal.

Test #	Sealed Product	Specific Gravity	Pressure (psig/bar)	Temperature (°F/°C)	Speed (rpm)	Date Installed	Status
1	Alcohol/product	0.94	60 / 4.14	120-275 / 49-135	3600	10/31/97	Bearing failure after 3 month, seal refurbished, in excellent operation with desired performance
3	Phosphoric acid/methyl isobutyl ketone (MIBK)	0.935	30 / 2.07	130-140 / 54-60	1750	12/16/97	In excellent operation with desired performance
4	Caustic water scrubber with thionyl chloride and bromine		65 / 4.48	< 400 / 204	1750	12/5/97	In excellent operation with desired performance
5	Methylene chloride	1.4	40 / 2.76	- 35 / 2	1810	9/11/97	Observed frozen product in 1 st week, continuous good operation subsequently with desired performance
6	Methanol / sodium methalate			200 / 93	1750	12/4/97	In operation for 6 months, out of service due to product crystallization
7	Propionitrile	0.782	22 / 1.5	50-77 / 10-25	2900	12/11/97	In excellent operation with desired performance
8	Methanol / salt solution /Duralink /water		40 / 2.76	158-194/ 70-90	1750	9/10/97	Experienced a few abnormalities in pressure extremes, otherwise in good operation with desired performance
9	Synthetic solvent	1.0 - 1.05	102 / 7.0	284 / 140	2950	12/15/97	Lower Δp than recommended due to supply limitation, in good operation to customer's satisfaction
10	Sodium formate	1.4		248-257 / 120-125	1480	12/16/97	Seal failure due to wrong O-ring selection (chemical attack on O-ring)

In this application, a 1.875 inch (48 mm) shaft diameter twin hybrid gas seal was installed to a reactor pump, with the process being decanol with traces of ethylene oxide (EO) and potassium hydroxide. The pump runs at 3600 rpm with a 50 hp motor. The discharge and suction pressures are 98 psig (6.8 barg) and 49 psig (3.4 barg), respectively, and the seal chamber pressure is estimated to be 58 psig (4 barg). The pumping temperature is 330°F (166°C). Nitrogen is used as the barrier gas and its header pressure is at 300 psig (21 barg).

The reactor pump provides two services: recirculating from and back to the reactor during the reaction phase, and then pumping out the reactor after the reaction is complete. The second phase, pumping out the reactor, is the most damaging to the pump because the vessel must be pumped out completely. At the end of this pump out phase, the pump runs dry for 1.5 minutes before the instrumentation automatically shuts down the pump. Then the remaining residue is blown out of the reactor to be sure one batch of product never touches the next one. This is because one batch may be a different formula from the next, and no interbatch contamination can be tolerated.

This dry-running of the pump for 1.5 minutes every batch, four times a day, was destroying conventional seals that require process liquid to lubricate the faces. Double seals with liquid pressure tanks failed because the excessive pressure drop across the outer seal caused them to fail prematurely. Then the subsequent loss of pressure in the barrier fluid system would cause the inner seal to fail, because it either had process across the faces or no lubrication when the pump was running dry. A tandem seal arrangement was never effective either, perhaps because the inner seal could not cope with the pressure reversal when suction pressure decreased due to the pump running dry. Another major problem was the possibility of EO bubbles entering the pump, if they had not been completely reacted before reaching the pump itself during recirculation. Since EO has a very high vapor pressure at this elevated pumping temperature, it could cause vaporization problems at the seal faces of conventional liquid seals. Past history of conventional liquid type seals showed blistering of the faces and burned O-rings. Various face materials were tried and so were several different types of O-rings. No significant improvement was evident through all of these attempts to solve the seal reliability problem.

The obvious sealing solution was then to use a seal that was designed to run dry, since the dry-running of the pump was the apparent cause for seal failures. A dry-running gas barrier seal with nitrogen barrier gas seemed to be the ideal choice. Other types of gas barrier seals were tried before the installation of a field test unit of this twin hybrid design. While most gas barrier seals performed acceptably in "normal" operating conditions, some problems did arise from "abnormal" situations, such as loss-of-barrier pressure when the nitrogen supply was either not turned on inadvertently before start of the pump, or shut down accidentally during pump operation. There was a good chance that the seal would not recover when the barrier gas supply was restored. When that happened, most of the time, the pump had to be shut down to replace the seal assembly.

The field test unit of twin hybrid gas barrier seal is configured as a single cartridge seal. Figure 17 shows its cutaway picture where all the major components are exposed. Its installation is similar to installing a single cartridge liquid seal with a flush line, except the flush line is replaced by a nitrogen barrier gas supply line. The barrier gas pressure is regulated by an external control manifold as shown in Figure 18, which was to be replaced by an in-gland control unit when available. After installation, the twin hybrid gas barrier seal ran successfully for three months, until bearing failures destroyed the pump and damaged the seal. During the three months, the seal experienced quite a few abnormal operating conditions, particularly the interruptions of barrier gas supply. Each time, when barrier gas supply was restored, the seal seemed to recover to its normal performance as measured by barrier gas consumption rate.

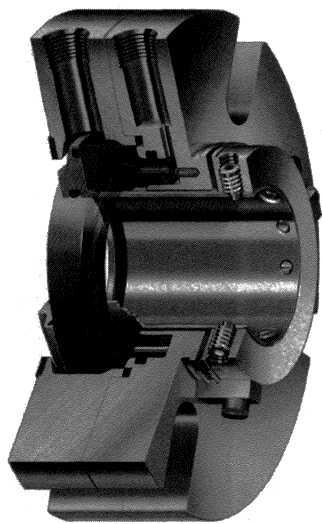

Figure 17. Cartridge Cutaway of Twin Hybrid Gas Seal.

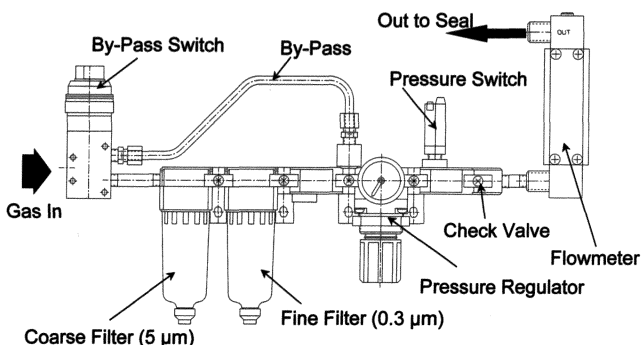

Figure 18. Barrier Gas Control Manifold for Field Test Seals.

The damaged field test unit, because of bearing failure, was returned to the factory for review. After careful examination, it was determined that the seal was still repairable. The inside of the stationary gland had heat marks from contacting the gas seal sleeve mounted on the pump shaft during operation. This thermal stress had caused permanent deformation of the balance diameter beyond reuse. The seal faces were in good condition, with minor areas showing evidence of face contact. The inner diameter of the stationary face had made slight contact with the seal sleeve. The inner stationary O-ring had been overheated in the hot spot on the balance diameter. The seal was refurbished and returned to the chemical company for continued operation.

CONCLUSION

A novel design of a gas-lubricated barrier seal is presented in this paper, in which a "twin hybrid" concept was utilized. The compacting of two seal interfaces into one physical ring not only reduces greatly the cartridge size to fit all pumps without stuffing box modifications as with a single seal assembly, but still maintains its dual seal's functionality. The hybrid design combining the hydrodynamic action with an active hydrostatic action in one integral configuration makes initiating and maintaining stable noncontacting operation more efficient, particularly for applications where frequent start/stop and slow speed operations are of concern. The special springloading mechanism on the dynamic O-ring reduces significantly the possibility of seal failure because of dynamic O-ring hangup. The seal's unique configuration as a gas barrier seal for pumps makes it tolerant of barrier gas supply interruptions. It reverts to a contacting liquid narrow face seal when pressure reversal or loss-of-barrier is experienced without shifting dynamic O-ring, because the product is sealed on the outer diameter of the seal ring, and process pressure caused moment renders a divergent interface profile with outer diameter contact. It is demonstrated through field test that the reliability of a well-designed noncontacting, dry-running gas lubricated seal can surpass that of the pump or its bearing assembly.

REFERENCES

- American Petroleum Institute, 1994, "Shaft Sealing Systems for Centrifugal and Rotary Pumps," API Standard 682, First Edition, Section 6.3, pp. 33-39.
- Cheng, H. S., Chow, C. Y., and Wilcock, D. F., April 1968, "Behavior of Hydrostatic and Hydrodynamic Noncontacting Face Seals," ASME Journal of Lubrication Technology, pp. 510-519.
- Environmental Protection Agency, 1991, "National Emissions Standards for Hazardous Air Pollutants; Announcement of Negotiated Equipment Leaks," Federal Register, Volume 56, No. 44.
- Gardner, J. F., 1973, "Recent Development on Non-Contacting Face Seals," ASLE Reprint Number 73AM-88-3.
- Key, W. E., Lavelle, K. E., and Wang, G., 1992, "Mechanical Seal Performance for Low Emissions of Volatile Organic Compounds," Proceedings of the Thirteenth International Conference on Fluid Sealing, BHRG, Cranfield, United Kingdom, pp. 313-331.
- Greiner, H. F., 1971, "Unloading Gas Barrier Face Seal," U.S. Patent No. 3572727.
- Lebeck, A. O., 1991, *Principles and Design of Mechanical Face Seals*, New York, New York: John Wiley & Sons, Inc., p. 356.
- Muijderland, E. A., July 1967, "Analysis and Design of Spiral-Groove Bearings," ASME Journal of Lubrication Technology, pp. 291-306.

- O'Brien, A. and Wasser, J. R., 1997, "Design and Application of Dual Gas Seals for Small Bore Chambers," *Proceedings of the Fourteenth International Pump Users Symposium*, Turbomachinery Laboratory, Texas A&M University, College Station, Texas, pp. 43-48.
- Sedy, J., 1978, "Improved Performance of Film-Riding Gas Seals Through Enhancement of Hydrodynamic Effects," *ASLE Trans.*, 23, (1), pp. 35-44.
- Shapiro, W., and Colsher, R., 1971, "Selection, Analysis and Preliminary Design of a Steam-Lubricated, Steam-Turbine Shaft Seal," *ASLE Trans.*, 14, (3), pp. 226-236.
- Society of Tribologists and Lubrication Engineers, 1990, "Guidelines for Meeting Emission Regulations for Rotating Machinery with Mechanical Seals," STLE SP-30.
- Surprise, T. C. and Krogel, E. T., 1993, "Control of Emissions from Rotary Equipment and Valves in the Paper Industry," *TAPPI Proceedings of 1993 Environmental Conference*, pp. 745-755.
- Wasser, J. R., Sailer, R., and Warner, G., 1994, "Design and Development of Gas Lubricated Seals for Pumps," *Proceedings of the Eleventh International Pump Users Symposium*, Turbomachinery Laboratory, Texas A&M University, College Station, Texas, pp. 63-67.

