

MECHANICAL SEALS IN DEAD-END SERVICE IN THE PULP AND PAPER INDUSTRY

by

Martin Demmel

Sales and Applications Engineer

Feodor Burgmann Dichtungswerke GmbH & Company

Wolfratshausen, Germany

and

Per-Eric Törnqvist

Managing Director

Tiivistetekniikka Oy

Vantaa, Finland

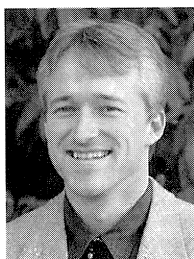

Martin Demmel is Sales and Applications Engineer in the Engineered Mechanical Seals Department at Feodor Burgmann Dichtungswerke GmbH & Company, in Wolfratshausen, Germany. His responsibilities have included, among other things, all matters concerning sealing technology in the worldwide pulp and paper industry, since he started with Burgmann in 1995.

Mr. Demmel has an Engineer degree (Mechanical Engineering, 1995) from the Munich Technical College.



Per-Erik Törnqvist is the Managing Director of Tiivistetekniikka Oy, in Vantaa, Finland. Tiivistetekniikka Oy is a company concentrating on seals for the process industry. The collaboration between Feodor Burgmann and Tiivistetekniikka has continued for more than 35 years. The biggest customer group is the pulp and paper industry. Mr. Törnqvist began his career as Design Engineer at Ahlstrom

Pumps in Finland. Later, he worked as Sales Engineer selling Sarlin submersible pumps, before starting as Sales Manager at Tiivistetekniikka Oy.

Mr. Törnqvist has an Engineer degree (Mechanical Engineering, 1971) from Tekniska Läroverket. He has more than 25 years of experience with pumps and mechanical seals in various industries.

ABSTRACT

The pulp and paper industry as well as all other industry branches are subject to continuous, ongoing development. Mechanical seals have already replaced stuffing-box packings in virtually all pulp and paper factories in Europe, as well as in a very large number of production plants throughout the world.

The advantages gained through the use of mechanical seals—for example lower leakage rates, friction output, and maintenance outlay—make a significant contribution toward sparing both environment and resources while enabling more economic production operations.

The chemical and petrochemical industries have already shown the way in this respect with impressive success. Yet these branches have had experience with mechanical seals for a long time and are using closed loop seal supply systems to keep the buffer fluid in its

place, in contrast to the pulp and paper industry where most systems consist of a mechanical seal, a control device to adjust buffer flowrate and pressure, and drainage where the buffer water goes after it leaves the seal. This results in high water consumption for mechanical seals in pulp and paper mills.

The dead-end seal is a kind of “closed-loop-system” in itself and has proven to save a lot of seal water (and, with this, money) in several applications, not only in the pulp and paper industry.

A description of the dead-end seal, its operation range, and plant studies are presented. The plant histories discuss economic, environmental, and reliability benefits achieved from using the dead-end seal in different fields of application.

INTRODUCTION

Environmental regulations and pollution control, also concerning effluent reduction, are getting more and more strict all over the world. This development is desirable, of course, to protect our planet from exploitation of valuable resources. Yet, as a result, water and raw materials for the manufacture of pulp, paper, and cardboard are becoming increasingly cost-intensive. Consequently, there is a particular demand for ideas, innovations, and developments toward sparing resources.

As a first step, pulp and paper mills convert their pump and machinery seals from traditional stuffing-box packing to mechanical seals. This helps save the resources as described above. However in most cases, when using an open system to supply the mechanical seal with adequate buffer water, a lot of water is required that is running through the seal into the drainage system and to the water processing plant of the mill. This was tolerated in the past as water and energy were not as expensive, and environmental regulations were not as strict as they are today and will be in the future.

The dead-end seal is a quite simple solution with no need of expensive additional supply system components to greatly reduce the water consumption. Also, no costly modification on an existing system is required. The dead-end seal helps to save resources and makes the operation of pumps and other machinery more economical and, in some cases, also more reliable and less service intensive.

Three plant studies are presented—UPM Rauma, Enso-Stora Anjalankoski, and Enso-Stora Kotka.

COMMON SEAL SUPPLY SYSTEM FOR DOUBLE-ACTING SEALS

When the process and media conditions require the use of a double mechanical seal in most industry branches, a dedicated system for supplying the requisite buffer medium at the appropriate pressure and temperature levels is used. As a rule, a system of this type comprises a small, closed circuit with measuring and control instruments as well as storage and circulating devices (Figures 1 and 2).

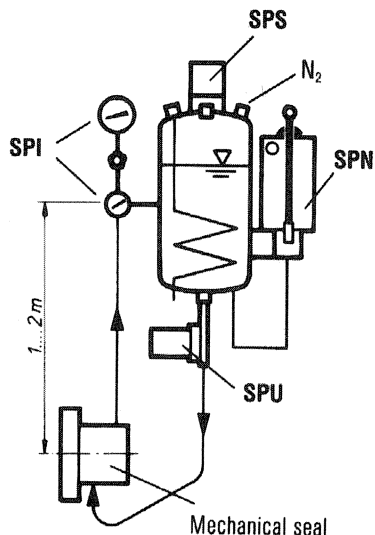

Figure 1. Structure of a Common Seal Supply System. (SPI = Pressure and temperature gauges; SPS = Level meter; SPN = Refilling unit; SPU = Circulation unit.)

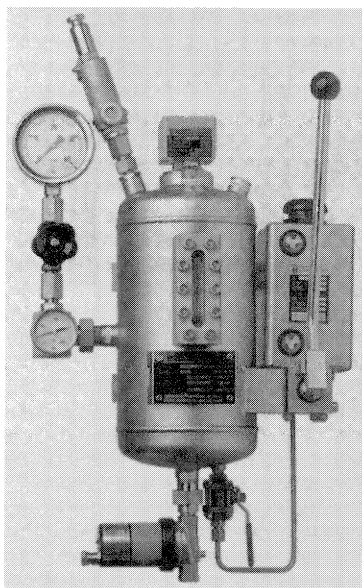

Figure 2. Seal Supply System.

The buffer medium, once filled into this closed loop system, remains and circulates there. Every now and then only a comparatively small quantity of buffer medium has to be refilled because of the natural leakage of the mechanical seal. Additional parts like pressure switches, temperature switches, level switches, heat exchangers, etc., are optional.

Though a seal supply system of this kind costs about three to four times the price of a double-acting mechanical seal, it is necessary to operate the seal using a buffer medium other than water, like oil or glycols. A seal operated with such a sophisticated supply system will operate reliably, with a long lifetime.

SEAL SUPPLY SYSTEM FOR DOUBLE-ACTING SEALS UTILIZED IN THE PULP AND PAPER INDUSTRY

In the pulp and paper industry, another simpler seal supply system is utilized. The ready abundance of water in the paper production process means that the mechanical seals (Figure 3, designated as "1") used can be supplied via a pipe link to the plant's

own water supply network. The required pressure level and delivery rates are set manually by means of a small measuring and control unit (Figure 4), which is connected to the seal as shown in Figure 3.

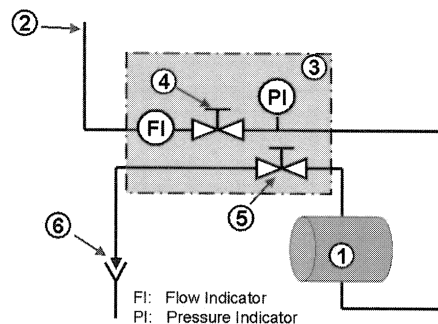

Figure 3. Structure of Seal Supply System Utilized in Pulp and Paper Industry.

Buffer pressure can be adjusted with a valve (Figure 3, designated as "4"), and buffer flowrate with another valve (Figure 3, designated as "5"). This is made possible by the fact that the buffer fluid pressure required in the paper industry (up to 3 bar/43.5 psi) is, in most cases, lower than the pressure in the plant's own water supply (4 to 8 bar/58 to 116 psi).

Downstream of the measuring and control unit, the buffer water passes into the atmosphere or into the drainage system (Figure 3, designated as "6") and, subsequently, into the reprocessing plant.

The greater the number of seals operated in this manner, the greater the volume of water that has to be supplied, and thus the larger the reprocessing plant has to be. All this costs money.

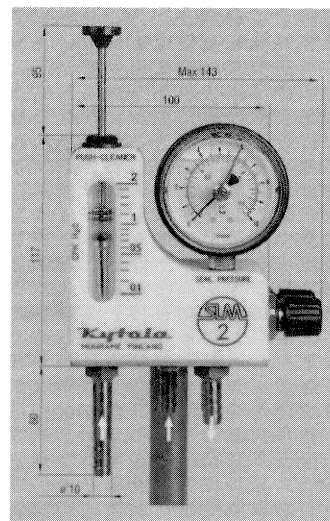

Figure 4. Example of a Measuring and Control Unit.

DEAD-END SEAL

The dead-end seal has been developed to address the above-mentioned issues. It has been modified in contrast to the usual double-acting seal by putting in additional bores (Figure 5, 6, and 7, designated as "1") in the housing, together with spiral slots (angle of 5 to 10 degrees) on the inner diameter of the housing (Figure 5, 6, and 7, designated as "3") to permit the buffer water in the unit to circulate from the sealing interface region on the product side to the sealing interface region on the atmosphere side and back again, caused by rotation of the pump shaft.

For cost reasons, usually double-acting seals have, on the atmospheric side, carbon against special cast CrMo steel as the

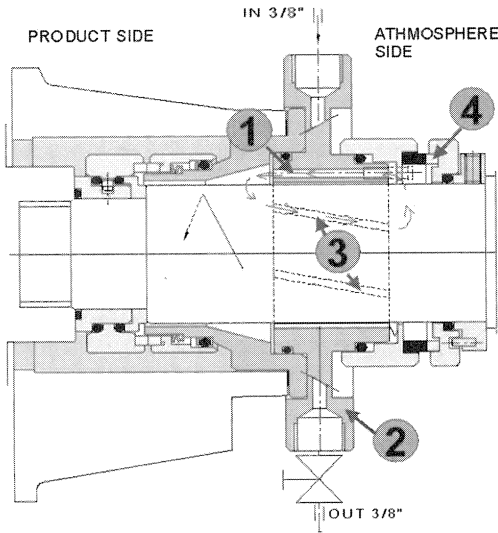

Figure 5. Cross Section of Dead-End Seal.

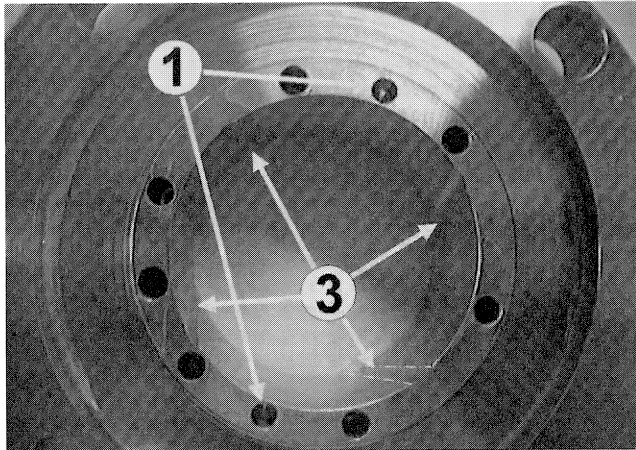

Figure 6. Bird's-Eye View of Seal Housing with Spiral Slots.

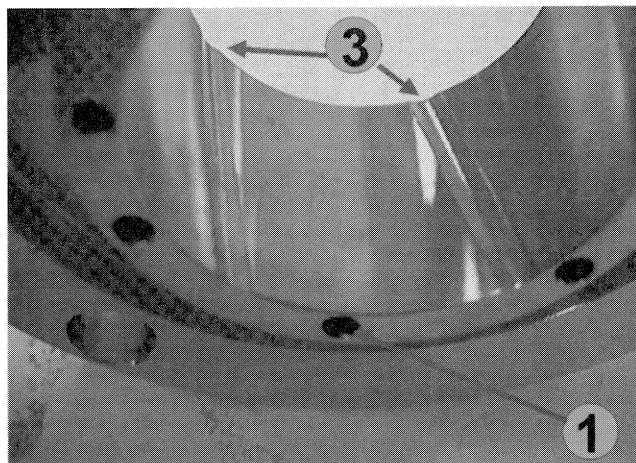

Figure 7. View of Spiral Slots in Housing.

sliding face combination. This was replaced by the higher-graded sliding face combination of carbon against silicon carbide, with better sliding and friction behavior for the dead-end version (Figure 5, designated as "4"). The surface of silicon carbide is smoother and harder than the surface of special cast CrMo steel.

Therefore, there is less friction loss and friction generated heat when sliding against carbon. Thus, the friction heat generation in the dead-end seal is reduced compared with the usual double-acting seal.

Figure 8 shows a comparison of friction loss to product pressure at 1500 rpm with both sliding face combinations carbon (A) against special cast CrMo steel (S), and carbon (A) against silicon carbide (Q1).

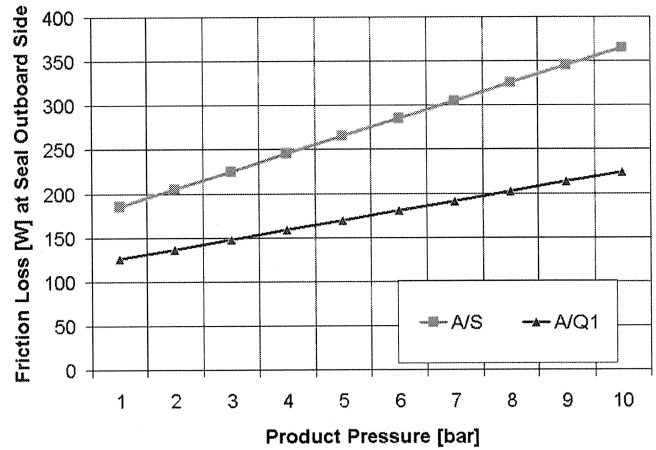

Figure 8. Comparison of Friction Loss to Product Pressure at 1500 RPM.

Figure 9 shows a comparison of friction loss to product pressure at 3000 rpm with both sliding face combinations: carbon (A) against special cast CrMo steel (S), and carbon (A) against silicon carbide (Q1). Both figures show calculated values.

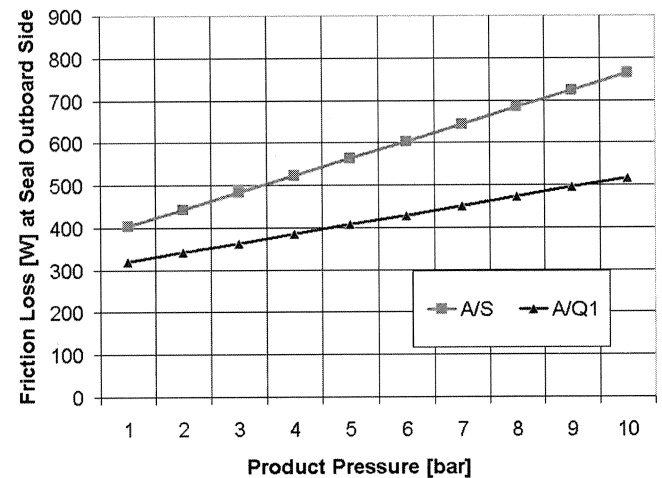

Figure 9. Comparison of Friction Loss to Product Pressure at 3000 RPM.

The buffer water supply (Figure 10, designated as "1") is connected as is customary, but the outlet of the seal (Figure 10, designated as "2") is closed with a valve (Figure 10, designated as "3"). This valve is only used before startup to vent the seal. A pressure control valve is optional (Figure 10, designated as "4"). The result is that only the very slight "natural" leakage (into the process and to atmosphere) to which a double mechanical seal is subject has to be compensated for. This means that a large volume of buffer water is saved annually per sealing point. Not only is water saved, but also energy otherwise needed for feeding the water into the plant's own water supply. In addition, it is easier to

maintain pressure in a system containing virtually immobile water than in a system through which water flows at a high rate.

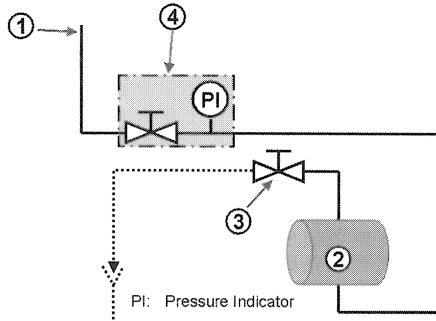

Figure 10. Dead-End System.

The seal functions in the same way as a heat exchanger. The mechanical seal on the atmosphere side is adequately cooled by the water circulating in the seal unit. The pump medium acts as coolant, which takes away the frictional heat of the inboard seal and heat from the circulating coolant by conduction through the inboard seal components.

Use of the system in all appropriate applications—its operating limits make it suitable for around 80 percent of cases where mechanical seals are called for in pulp and paper production—enables extremely high savings potential in terms of water and energy.

Control of a Dead-End Seal

It is very easy and inexpensive to control a dead-end seal. A thermometer probe is attached to the seal housing and connects it to a control device (e.g., computer system). As long as the temperature of the seal is constant, everything is good. If the temperature drops, more water must pass the seal to cool it. Consequently, there must be higher leakage through the seal (or the system) and it has to be checked. If the temperature of the seal rises, it has to be checked as well.

Such a thermometer probe costs no more than chewing gum. A usual supply system utilized in the pulp and paper industry needs at least a pressure gauge and flow control device with contacts, so that it can be connected to a control system. A pressure gauge and flow control device costs about \$100. So, here again, is a potential to save cost when using a dead-end seal.

Operating Limits for Dead-End Seals

The operation limits for the dead-end seal were determined with a simple test. This test was done with a pump that was used at the same time for testing wear of pumps in abrasive media. Different mixtures were pumped in a closed loop. The seal was a 40 mm seal that was tested with different speeds and buffer fluid pressures. The required values when starting the project were 0.2 to 1 MPa (2 to 10 bar/29 to 145 psi) buffer fluid pressure, 10 m/s sliding velocity, and pumped medium a maximum of 100°C (212°F). Allowed temperature at atmospheric seal faces was a maximum of 120°C (248°F). The temperature was measured with a noncontact thermometer. By the end of the project, the seal had been tested for more than 3000 hours. With the tested seal, the values were measured and the other values of the operation limit's table were calculated. Operation limits were determined as shown in Figure 11.

On one axis, the product temperature is applied; on the other one, the product pressure. The diagram shows graphs of different shaft speeds. The diagram shows graphs for a seal for a 50 mm shaft so that the results can easily be translated to other sizes because the determining parameter for friction heat is the sliding velocity, which is also given in the diagram.

seal Ø50mm

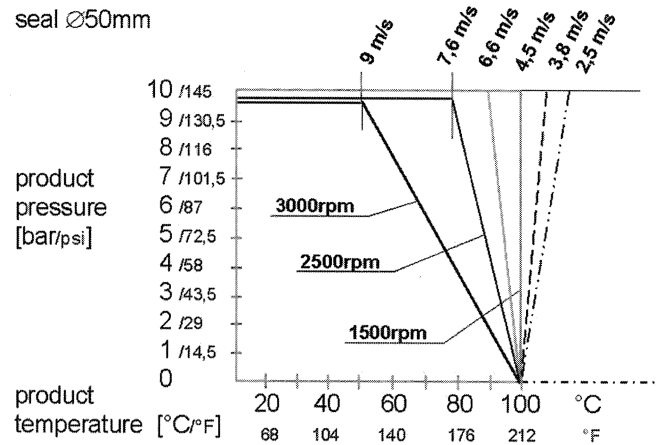

Figure 11. Operation Limits for the Dead-End Seal.

The test was made with carbon (A) against special cast CrMo steel (S) sliding face combination on the outboard side, so with carbon (A) against silicon carbide (Q1), the operation limits are higher.

Field Applications, Location 1

A dead-end seal of this type has been in operation at Location 1, in Finland, since August 1994, under the following conditions:

- Medium: Return water
- Buffer pressure: 6 bar (87 psi)
- Temperature: 65°C to 80°C (149°F to 176°F)
- Speed: 3000 rpm
- Shaft Size: 60 mm

The temperature at the carbon seal face on the atmosphere side was measured to a maximum of 82°C (180°F).

Field Applications, Location 2

Another dead-end seal has been in operation at Location 2, in Finland, since mid-1994, under the following conditions:

- Medium: Wood pulp
- Process pressure: 2 to 4 bar (29 to 59 psi)
- Buffer pressure: 6 bar (87 psi)
- Temperature: 90°C (194°F)
- Speed: 1500 rpm

Calculated Savings

(The previous seal used 5 l/min water) 5 l/min (1.3 gal/min) chemical pure water ($\approx 2.600 \text{ m}^3/\text{a}$; 686,848 gal/year—\$1373/year).

Field Applications, Location 3

A dead-end seal was tested under real conditions with a pressure filter screen at Location 3, in Finland. A pressure filter screen is a machine that separates pulp fibers of the right quality from the rejects. The seal was equipped with a temperature gauge at the atmospheric side sliding face. A temperature of 85°C (185°F) was measured while in operation.

- Medium: Wood pulp
- Process pressure: 3 to 4 bar (43.5 to 59 psi)
- Buffer pressure: 12 bar (174 psi)
- Temperature: 80°C (176°F)
- Speed: 700 rpm

After one year in operation, the seal was opened and no wear could be measured. The seal was reassembled without refurbishing and now it has been running for 36 months without any problems. Because of this good result, the customer has installed another dead-end seal for a bigger machine, which has been running since August 1998.

Calculated Savings

(The previous seals used approximately 5 l/min water each.) 5 l/min (1.3 gal/min) water per seal (two seals) ($\approx 5.200 \text{ m}^3/\text{a}$; 1,373,696 gal/year—\$2746/year).

Cost Comparison of All Three Discussed Seal Operation Systems

• Assumptions:

- Considered period of time: five years
- Considered seal size: 60 mm shaft
- 20 percent of seal price = repair cost per year
- The dead-end seal is slightly more expensive because of additional bores and grooves in housing and a higher quality sliding face combination on the outboard side

• Leakage of a double-acting seal: $\approx 20 \text{ ml/h} \times 24 \text{ h/d} \times 350 \text{ d/year} = 0.168 \text{ m}^3/\text{year}$; $0.168 \text{ m}^3/\text{year} \times \$0.528/\text{m}^3 = \$0.09/\text{year}$

• Common seal supply system for double-acting seals:

Mechanical seal	\approx \$2000.00
+ Repair of seal in five years	2000.00
+ Supply system (as described above)	\approx 4000.00
+ Water cost for leakage in five years	.44
Sum	\$8000.44 per five years
	= \$1600.09 per year

• Seal supply system utilized in the pulp and paper industry:

Mechanical seal	\approx \$2000.00
+ Repair of seal in five years	2000.00
+ Supply system (as described above)	\approx 500.00
+ Water cost for leakage in five years	.44
+ Water consumption cost (5 l/min)	6865.00
Sum	\$11,365.44 per five years
	= \$ 2273.09 per year

• Dead-end system:

Mechanical seal	\approx \$2400.00
+ Repair of seal in five years	2400.00
+ Supply system (as described above)	\approx 100.00
+ Water cost for leakage in five years	.44
Sum	\$4900.44 per five years
	= \$ 980.09 per year

The above-mentioned savings show that using a dead-end seal pays off very soon, approximately after one year. Further savings result from the dead-end seal running at slightly higher temperatures than usual double mechanical seals. There is not as much heat extraction from the process.

A far larger potential of cost savings appears when the plant is originally designed for the use of dead-end seals. Then, because of the lower need for seal water, a smaller water treatment plant can be utilized at lower cost.

Replacement for Single Seals

A further area in which these seals can be used is in applications where only single seals would normally be required. The service life of a seal is determined by the conditions under which it operates, e.g., pressure, temperature, speed of rotation, and the respective medium. In the case of single seals, the medium simultaneously acts as lubricant for the seal faces.

Media employed in the paper industry, in many cases, contains highly wearing constituents. It follows that seal service life can be considerably increased by using a double seal in which clean buffer water is contained in the sealing gap as lubricant. A long service life means less maintenance and repair costs. Though double seals have not been previously used for such applications due to the water consumption they involve, the dead-end system now makes it possible to cut maintenance costs.

A side effect of using a double seal compared with a single seal is that the process medium remains entirely within the process, thereby contributing yet further toward sparing resources and the environment.

CONCLUSION

A large number of dead-end seals are already in successful operation (also in other sectors such as the pharmaceutical, chemical, sugar, and foodstuff industries). The number of applications continues to grow. A typical application of dead-end seals is shown in Figure 12.

The dead-end double seal is a significant innovation particularly suited to saving resources in the pulp and paper industry and similar applications.

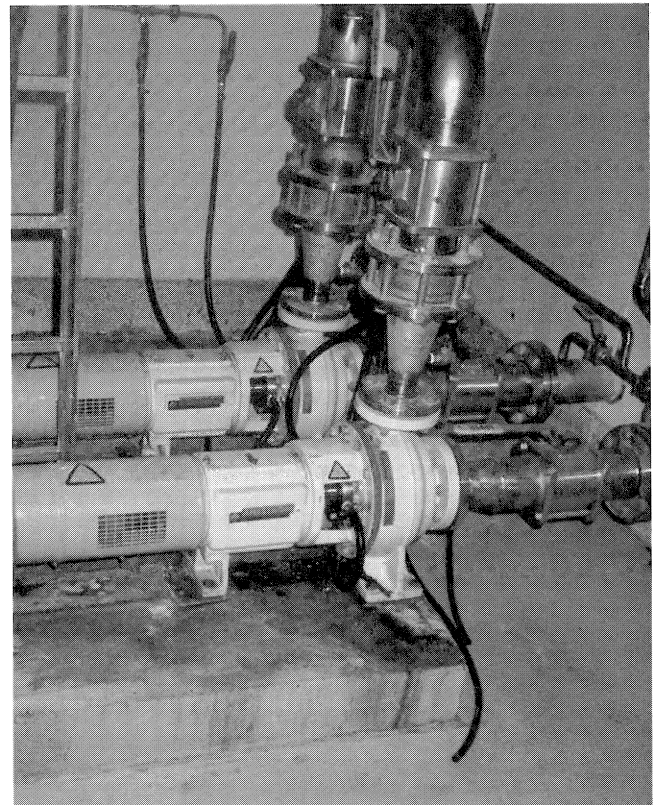

Figure 12. Dead-End Seals in Pumps at a Chemical Plant in Finland.

NOMENCLATURE

Sliding face materials used for mentioned mechanical seals:

- A = Carbon graphite, antimony impregnated
- S = Special cast CrMo steel
- Q1 = Silicon carbide, sintered pressureless

Water costs in North America (regional varying) (information from Mike Eckweiler, Burgmann subsidiary service center, Charlotte, North Carolina):

\$0.002/gal = \$0.528/m³ (August 10, 1999)

BIBLIOGRAPHY

Miettinen, J. 1993, "Usage of Mechanical Seals without Circulation Water," Lisensiate, Tampere University of Technology, Tampere, Finland.

ACKNOWLEDGEMENT

The authors would like to acknowledge the following without whose help and support this seal would not have been tested and running conditions calculated with such accuracy. The dead-end seal was developed by VTT (Technical Research Center of Finland) and Tampere University of Technology. Lis. Tech. Juha Miettinen made his Lisensiate work of this development available and we thank especially him, Professor Veli Siekkinen, and Lis.Tech. Erkki Jantunen who all helped with the analysis of the results.