

APPLICATION OF FUZZY LOGIC TO QUANTIFY THE UNCERTAINTY IN
LAYER OF PROTECTION ANALYSIS

A Dissertation

by

YIZHI HONG

Submitted to the Office of Graduate and Professional Studies of
Texas A&M University
in partial fulfillment of the requirements for the degree of

DOCTOR OF PHILOSOPHY

Chair of Committee,	M. Sam Mannan
Committee Members,	James Holste
	Mahmoud El-Halwagi
	Reza Langari
Head of Department,	M. Nazmul Karim

May 2017

Major Subject: Chemical Engineering

Copyright 2017 Yizhi Hong

ABSTRACT

Layer of Protection Analysis (LOPA) is a widely used semi-quantitative risk assessment method. LOPA includes both frequency and consequence expressed in an order of magnitude approximation. Compared with Quantitative Risk Analysis (QRA), LOPA provides a simplified but less precise method to assess the effectiveness of protection layers and the risk reduction of an incident scenario. The outcome frequency and consequence of LOPA are intended to be conservative, which makes the risk overestimated. A high risk indicates the requirement of additional Independent Protection Layers (IPLs), which calls for higher installation and maintenance costs. There are different sources and types of uncertainty in LOPA model that need to be identified and quantified.

Fuzzy logic is a method to deal with systems that are too complex or not clearly defined. Using fuzzy arithmetic, imperfect data are analyzed in a natural and flexible way. Through the application of fuzzy logic, uncertainty from data and experience from experts can be quantified, and a more accurate and precise risk value can be obtained. Various types of fuzzy logic systems, including type-1 fuzzy logic and type-2 fuzzy logic are studied in this work.

The goal of this work is to increase the accuracy and precision of LOPA model while retaining its simplicity. A probabilistic and fuzzy logic hybrid approach is developed to deal with the uncertainty in failure rate data. This method facilitates a more accurate and precise failure rate database considering generic database, plant-specific data and

expert experience. It has been applied to a distillation system, with a capacity to distill 40 tons of flammable n-hexane, and the results show that a more accurate failure rate can be achieved with the available data and expert judgment. Furthermore, a type-2 fuzzy logic risk matrix is developed to increase the precision of a risk matrix. This new method also provides an efficient way to aggregate several risk matrices into one universal risk matrix. Its application to aggregate three standard risk matrices has been shown through a case study.

This work demonstrates the effectiveness of applying fuzzy logic in quantifying uncertainty in layer failure data to be used in LOPA. Fuzzy logic can also be helpful in other types of risk assessment.

DEDICATION

To my father Caifu Hong, my mother Peili Jiang, and my wife Zhe Han, for their love and unconditional support, for being the main motivation to move forward and become a better person every day.

ACKNOWLEDGEMENTS

I would like to sincerely thank my committee chair, Dr. M. Sam Mannan, for his mentoring, which has gone beyond the academic level. His vision and inspiration for students to make a contribution in the process safety field motivated me throughout my research. I also thank him for giving me multiple opportunities to work on real world problems. His understanding during the difficult times is highly appreciated. I admire Dr. Mannan as a leader, a researcher, and a person.

I would like to offer my thanks to Dr. James Holste, Dr. Mahmoud El-Halwagi, and Dr. Reza Langari, for serving as my committee members, and for their guidance and support throughout the course of this doctoral research.

I would like to show my appreciation to Dr. Hans Pasman, Dr. Simon Waldram, and Dr. Maria Papadaki for giving me advice on my research project. I am sincerely thankful to them for their continuous advice and encouragement both in my research and life.

I would like to express my deep gratitude to Dr. Sonny Sachdeva and Dr. Noor Quddus for constant support and encourage throughout my graduate study. I am sincerely thankful to them for giving me insightful suggestions on my research.

I would also like to extend my thanks to the staff and members of the Mary Kay O'Connor Process Safety Center. Thanks to Valerie Green for her care and encouragement, to Alanna Scheinerman for her assistance in reviewing several manuscripts.

There are not enough words to thank my parents, Caifu Hong, Peili Jiang, and my wife Zhe Han, for their love and unconditional support, for being the main motivation to move forward and become a better person every day.

TABLE OF CONTENTS

	Page
ABSTRACT	ii
DEDICATION	iv
ACKNOWLEDGEMENTS	v
TABLE OF CONTENTS	vii
LIST OF FIGURES	ix
LIST OF TABLES	xii
1. INTRODUCTION.....	1
1.1. Uncertainty in LOPA.....	2
1.2. Chances vs. Fuzzy Logic	3
1.3. Dissertation Outline.....	4
2. BACKGROUND KNOWLEDGE OF LOPA.....	6
2.1. Risk Assessment.....	6
2.1.1. Hazard and Operability Study (HAZOP).....	8
2.1.2. Failure Mode and Effects Analysis (FMEA)	9
2.1.3. Dow Fire and Explosion Index (F&EI).....	9
2.1.4. Fault Tree Analysis (FTA)	10
2.2. Risk Matrix	10
2.3. Layer of Protection Analysis	12
3. BACKGROUND KNOWLEDGE OF FUZZY LOGIC.....	19
3.1. Classical Boolean Set	19
3.2. Type-1 Fuzzy Logic.....	23
3.2.1. Type-1 Fuzzy Set	24
3.2.2. Basic Operations and Properties	29
3.2.3. Type-1 Fuzzy Rules and Reasoning.....	31
3.2.4. Type-1 Fuzzy Modeling	38
3.3. Type-2 Fuzzy Logic.....	40
3.3.1. Type-2 Fuzzy Set	40
3.3.2. Interval Type-2 Fuzzy Set.....	44

	Page
3.3.3. Basic Operations	46
3.3.4. Interval Type-2 Fuzzy Reasoning	47
3.3.5. Interval Type-2 Fuzzy Modeling.....	48
4. A PROBABILISTIC AND FUZZY LOGIC HYBRID APPROACH.....	51
4.1. Uncertainty Sources in Failure Rate	51
4.2. Relevant Literature Review and Gap Identification	53
4.3. Present Hybrid Approach	56
4.4. Case Study	69
4.5. Conclusions	76
5. UNIVERSAL RISK MATRIX	77
5.1. Uncertainty Sources in Risk Matrix	77
5.2. Literature Review and Gap Identification	79
5.3. Relevant Methods	80
5.3.1. Interval Approach (IA).....	80
5.3.2. Linguistic Weighted Average (LWA).....	85
5.4. Universal Risk Matrix Method	88
5.5. Case Study	92
5.6. Conclusions	98
6. CONCLUSIONS AND FUTURE WORK	99
6.1. Conclusions	99
6.1.1. Uncertainty in the Frequency	100
6.1.2. Uncertainty in the Risk.....	101
6.2. Future Work.....	102
REFERENCES	103

LIST OF FIGURES

	Page
Figure 1. Diagrams for a Boolean set and a fuzzy set.	4
Figure 2. Spectrum of tools for risk-based decision making [28].	8
Figure 3. Risk matrix example I.	11
Figure 4. Layers of protection for a possible incident [28].	14
Figure 5. The process life cycle showing where LOPA is typically used [2].	15
Figure 6. LOPA pictured as an event tree analysis [28].	17
Figure 7. Diagrams for a Boolean set and a type-1 fuzzy set.	23
Figure 8. Membership function of a crisp set and a fuzzy set.	24
Figure 9. Core, support of a typical type-1 fuzzy set.	26
Figure 10. Membership function shapes [36].	27
Figure 11. Membership function of three linguistic terms for Age.	28
Figure 12. Type-1 fuzzy set operations: intersection (AND), union (OR) and complement.	29
Figure 13. An example of type-1 fuzzy set and an α -cut.	33
Figure 14. Illustration of the T1 FS Decomposition Theorem when n α -cuts are used.	35
Figure 15. Mamdani fuzzy inference system.	37
Figure 16. Sugeno (TSK) fuzzy inference system.	38
Figure 17. The structure of type-1 fuzzy logic system.	38
Figure 18. Type-2 membership function as a blurred type-1 membership function [44].	41
Figure 19. Type-2 fuzzy set example I.	42
Figure 20. Type-2 fuzzy set example II.	43

Figure 21. Type-2 fuzzy logic example III.	44
Figure 22. (a) Type-1 fuzzy set; (b) Interval type-2 fuzzy set.	45
Figure 23. Standard interval type-2 fuzzy sets operations (a). Interval type-2 fuzzy set <i>A</i> and <i>B</i> . (b). Standard union of <i>A</i> and <i>B</i> . (c). Standard intersection of <i>A</i> and <i>B</i>	46
Figure 24. The structure of type-2 fuzzy logic system.....	49
Figure 25. Structure of fuzzy logic and probabilistic hybrid approach.....	56
Figure 26. Fuzzy modeling of parameter variance modifier (PVM).....	58
Figure 27. Parameter Variance Modifier (PVM) membership function.	60
Figure 28. Database quality membership function.....	61
Figure 29. Database relevance membership function.	61
Figure 30. Database applicability membership function.....	61
Figure 31. Quantity of plant-specific data membership function.....	62
Figure 32. Data confidence membership function.	62
Figure 33. Experience level of expert (year of working experience).....	62
Figure 34. Fuzzy IF-Then rules of data relevance and database quality.	64
Figure 35. Fuzzy IF-Then rules of Data confidence.	65
Figure 36. Fuzzy IF-Then rules of PVM.....	66
Figure 37. The resultant fuzzy surface of data applicability.	68
Figure 38. The resultant fuzzy surface of data confidence.....	68
Figure 39. The resultant fuzzy surface of PVM.	69
Figure 40. A simplified distillation column system [36].	71
Figure 41. Final failure rates in histograms for three scenarios with parameter variance modifier (PVM) equals 1, 0.8, 0.65 respectively.	75
Figure 42. Standard risk matrix and its fuzzy risk matrix [11].	79

Figure 43. The flow diagram of Interval Approach.	81
Figure 44. The scale of frequency and an example of data interval.....	82
Figure 45. The resultant interval type-2 fuzzy set of Risk Matrix I – Frequency B.	85
Figure 46. The flow to develop a fuzzy universal risk matrix.	89
Figure 47. Risk matrix example I.....	90
Figure 48. Frequency of risk matrix I in fuzzy sets.	91
Figure 49. Three risk matrices.....	92
Figure 50. Type-2 fuzzy modeling and resultant risk matrix for risk matrix I.	94
Figure 51. Type-2 fuzzy modeling and resultant risk matrix for risk matrix II.	95
Figure 52. Type-2 fuzzy modeling and resultant risk matrix for risk matrix III.....	96
Figure 53. The weight of three risk matrices.	97
Figure 54. The universal fuzzy risk matrix by aggregating three example risk matrices.....	97
Figure 55. Overview of the fuzzy and probabilistic hybrid approach.....	101

LIST OF TABLES

	Page
Table 1. Boolean sets symbols and set relations.	20
Table 2. Boolean set operations.	21
Table 3. Properties of Boolean sets.	22
Table 4. The standard operation of type-1 fuzzy sets.	30
Table 5. Properties of fuzzy sets.	31
Table 6. The standard operation of type-2 fuzzy sets.	47
Table 7. Comparison of generic databases and plant-specific failure data.	53
Table 8. Fuzzy linguistic variables description.	60
Table 9. Fuzzy IF-Then rules of data relevance and database quality.	64
Table 10. Fuzzy IF-Then rules of Data confidence.	65
Table 11. Fuzzy IF-Then rules of PVM.	66
Table 12. Some result samples of PVM fuzzy modeling.	70
Table 13. Frequency and probability of failure on demand (PFD) data.	72
Table 14. Log-normal distributions of frequency and probability expressed as fm, v	74
Table 15. The evaluation results for Risk Matrix I – Frequency B from 4 experts.	83
Table 16. Transformation equations of the uniform distribution of data interval into the type-1 fuzzy set [56].	84
Table 17. Detail information of risk matrix example I.	91

1. INTRODUCTION *

Our world is expanding with new technologies, products and services, accommodating a highly developing global economy, and at the same time imposing increasing risks to human life, economy, and environment. It is especially true in chemical and petrochemical industries, where a wide range of toxic and flammable materials are processed. Examples of recent incidents include BP Texas City-USA (2005) [1], Buncefield-UK (2005) [2], and Formosa Plastics Illiopolis-USA (2007) [3]. Safety plays a key role in industrial production, and therefore, more reliable and effective safety systems as well as risk assessment tools should be developed to prevent incidents.

Layer of protection analysis (LOPA) is a widely used semi-quantitative risk assessment method. It provides a simplified and less precise method to assess the effectiveness of protection layers and the residual risk of an incident scenario. The outcome failure frequency and consequence of that residual risk are intended to be conservative by prudently selecting input data, given that design specification and component manufacturer's data are often overly optimistic. There are many influences, including design deficiencies, lack of layer independence, availability, human factors, wear by testing and maintenance shortcomings, which are not quantified and are dependent on type of process and location. This makes the risk in a conservative approach

* Part of this section is reprinted with permission from "A fuzzy logic and probabilistic hybrid approach to quantify the uncertainty in layer of protection analysis" by Yizhi Hong, Hans J. Pasman, Sonny Sachdeva, Adam S. Markowski, and M. Sam Mannan, 2016. *Journal of Loss Prevention in the Process Industries* 43, Copyright 2016 by Elsevier.

usually overestimated. Therefore, to make decisions for a cost-effective system, different sources and types of uncertainty in the LOPA model need to be identified and quantified. The objective of this study is first to quantify the uncertainty in LOPA, and second to keep the modified LOPA method simple.

1.1. Uncertainty in LOPA

Markowski divided uncertainty from all the sources in process safety analysis into three types [4]: completeness uncertainty, modeling uncertainty, and parameter uncertainty. The completeness uncertainty refers to the question of whether all significant phenomena and all relationships have been considered. Modeling uncertainty refers to deficiency and inadequacies in the models assumptions that are used in risk analysis and consequence analysis. Parameter uncertainty is the imprecision and inaccuracies in the parameters which are used as input in models.

Uncertainty exists in each step of LOPA model as it is a semi-quantitative risk assessment method. LOPA methodology is based on certain assumptions, such as, how each scenario has a single initiating event. However, many causes can occur at the same time in a real incident. The performance of a specific instrument can depend on operating conditions and the environment of processes, which are not considered in the LOPA model. These are examples of modeling uncertainty and completeness uncertainty. Parameter uncertainty could happen in the data acquisition and measurement approach. In

traditional LOPA models, numbers are usually selected to estimate failure probabilities conservatively in order to get a reliable result [5].

1.2. Chances vs. Fuzzy Logic

Achieving high levels of precision costs significant amounts of time and money. By accepting some level of imprecision, problems can be solved more efficiently and effectively. Theories and models have been developed to describe uncertainty, and Zadeh introduced fuzzy sets and fuzzy logic in 1965 [6]. Fuzzy logic was developed to deal with systems that are very complex or not clearly defined. It provides an effective means for conflict resolution of multiple criteria and better assessment of options. In case of lack of data, this enables experts to express their estimate of a parameter value in a semi-quantitative way by linguistic terms on an ordinal scale. Fuzzy logic is an effective method to quantify such expressions. Fuzzy logic theory has wide-spread applications in process safety analysis, including event tree analysis, fault tree analysis, fuzzy risk matrix, bow-tie analysis, *etc.* [7-23].

Fuzzy logic admits degrees of truth, and allows a proposition to be partially true and partially false at the same time. It challenges not only the probability theory, but also the classical binary logic [24]. The probability theory, based on a binary logic that admits only true or false, was the leading theory from the late 19th century to the late 20th century. A comparison between a classical binary set and a fuzzy set can be found in Figure 1. A Boolean set, also known as a classical set, is defined with crisp boundaries, while a fuzzy

set is described by gradually shaded boundaries. For a Boolean set, an element inside the set A indicates that it is a member of A ; otherwise it is not a member of A . However, for a fuzzy set \bar{B} , an element in the shaded part indicates that it partly belongs to \bar{B} .



Figure 1. Diagrams for a Boolean set and a fuzzy set.

There are two types of fuzzy logic, including type-1 fuzzy logic and type-2 fuzzy logic. When there are uncertainties in the problem, type-1 fuzzy sets can be applied to describe the parameters. Similarly, when the situation in the problem is very complex and the membership functions of type-1 fuzzy sets are difficult to determine, type-2 fuzzy sets can be applied. In this study, both types of fuzzy logic are used to describe the uncertainty in LOPA. One type-1 fuzzy set is used to describe the experience from one expert, and type-2 fuzzy sets are used to describe multiple expert experiences.

1.3. Dissertation Outline

The rest of this dissertation is organized as follows. Section 2 provides a brief introduction to various types of risk assessment and the basic conceptions and procedures

of Layer of Protection Analysis. Section 3 provides a brief introduction to the most basic concepts and operations of type-1 fuzzy logic and type-2 fuzzy logic. Section 4 introduces a fuzzy logic and probabilistic hybrid approach to determine the mean and to quantify the uncertainty of frequency. Section 5 introduces a type-2 fuzzy logic based approach to develop a universal risk matrix. Finally, Section 6 draws conclusions and proposes future works.

2. BACKGROUND KNOWLEDGE OF LOPA *

This section provides a brief introduction to various types of risk assessment and the basic concepts and procedures of Layer of Protection Analysis.

2.1. Risk Assessment

Risk is formally defined as the effect of uncertainty on objectives (ISO 31000:2009) [25]. Typically, risk assessment is trying to answer three questions:

- What can go wrong?
- How frequent is the incident?
- What's the consequence of the incident?

For this work, risk is interpreted as a measure of the severity and probability of occurrence of an event that causes consequences, such as human injury, environmental damage, or economic loss. Besides the inherent uncertainty of risk, there is the possible spread in the derived values of both probability and consequence as a secondary source of uncertainty. For a specific scenario, risk is the function of consequence and probability, and the probability is expressed per unit of time, hence as frequency [26, 27]. Risk being a key concept in process safety, engineering decisions should be taken with a well understood and assessed risk.

* Part of this section is reprinted with permission from “A fuzzy logic and probabilistic hybrid approach to quantify the uncertainty in layer of protection analysis” by Yizhi Hong, Hans J. Pasma, Sonny Sachdeva, Adam S. Markowski, and M. Sam Mannan, 2016. *Journal of Loss Prevention in the Process Industries* 43, Copyright 2016 by Elsevier.

To a specific scenario, risk is a function of frequency and consequence. Thus risk assessment consists of hazard identification and consequence analysis. In hazard identification, scenarios are developed and the frequency of events are determined. In consequence analysis, the damage of the incidents is qualitatively or quantitatively described in terms of loss of life, economic loss, and damage to the environment [26].

There are various risk assessment tools and they can be briefly divided into three categories: qualitative analysis, semi-quantitative analysis, and quantitative analysis methods, as shown in Figure 2. Typically, all possible incidents need to be considered. Each incident can be the result of a multiple of scenarios starting at different root causes or their combinations. All scenarios are identified and analyzed qualitatively, and some scenarios resulting in more serious incidents need semi-quantitative analysis. For obtaining an overall risk of an operation and possible severe incidents one proceeds to quantitative analysis. Some well-known and accepted risk assessment methods are introduced in the following sub-sections. Layer of Protection Analysis is a semi-quantitative risk assessment approach, and it is discussed in detail in Section 2.3.

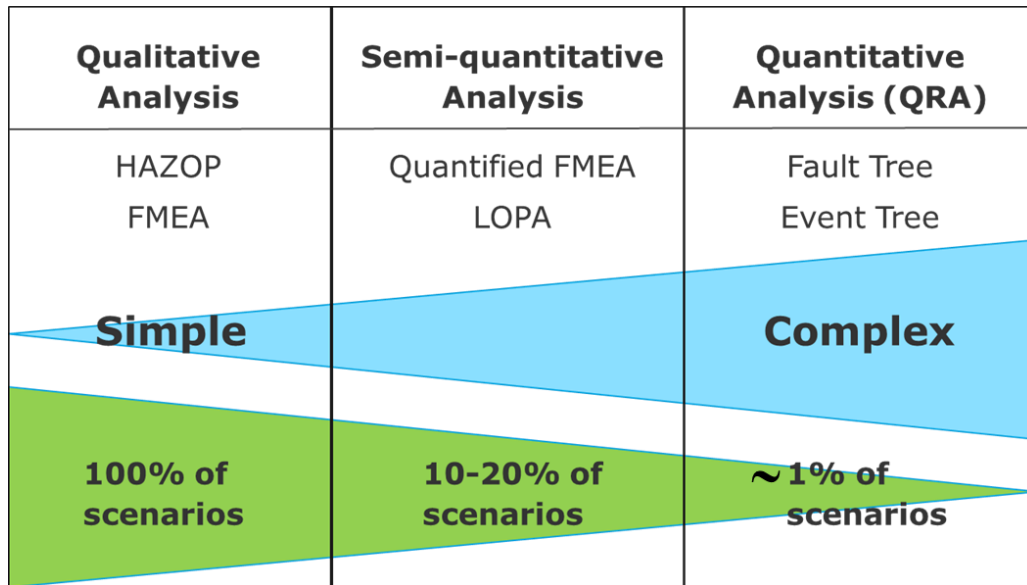

Figure 2. Spectrum of tools for risk-based decision making [28].

2.1.1. Hazard and Operability Study (HAZOP)

HAZOP is the most widely used systematic, qualitative hazard identification method, roughly assessing consequence and ways to avoid the hazard appearing. A HAZOP study starts from a P&ID of the process and breaks the complex design of process into a series of simpler sections, which are then reviewed separately. A HAZOP study is carried out by a group of experienced multi-disciplinary team. When identifying the deviations, the multi-disciplinary team uses a set of guide words, *e.g.*, NO, REVERSE, MORE, LESS, and associates them with some variables, *e.g.*, Flow, Temperature, Pressure, Composition.

2.1.2. *Failure Mode and Effects Analysis (FMEA)*

Failure Mode and Effects Analysis (FMEA) is a highly structured and systematic method to analyze the failure modes of equipment and their event sequences. FMEA was first developed to study problems that might arise from malfunctions of military systems in the late 1950s. A FMEA is mainly a qualitative analysis, but it can be put on a quantitative basis when the failure modes are well developed and failure rate data are available. Also the criticality of the failures can be assessed (FMECA).

2.1.3. *Dow Fire and Explosion Index (F&EI)*

The Dow Fire and Explosion Index (F&EI) was developed by Dow Chemical in 1964 [29]. It is a semi-quantitative index system that is used to evaluate the hazards of chemical substances and their processing. It is the most frequently used hazard evaluation index and has become a standard method in many countries. The first step is dividing the plant into a series of discrete units (*i.e.*, raw material storage, process stream storage, reactor feed pumps, reactors, strippers, recovery vessels, flash drums, K.O. drums, others). Critical items are then identified for each unit categories considering the chemical substances, process conditions, design conditions, past cases, *etc.* After this, the Material Factor, General Process Hazard Factor, Special Process Hazards Factors, Process Unit Hazard Factors are calculated. Then the Fire & Explosion Index is calculated by

multiplying the Process Unit Factor and Material Factor. The method is not suitable to consider details.

2.1.4. Fault Tree Analysis (FTA)

Fault Tree Analysis (FTA) was developed by H.A. Watson to evaluate a control system [30]. FTA is a type of quantitative risk assessment. FTA is a top down deductive system to analyze failure of a system using Boolean logic to propagate a fault in a series of events from a basic event upward. Starting from the initiating event, all the events are connected by using AND and OR gates. The development of FTA is a time-consuming process and it requires experts who know the methodology and are familiar with the process under analysis. With a well-developed Fault Tree and proven failure rate and equipment reliability data, the frequency of the top event can be calculated accurately.

2.2. Risk Matrix

Risk matrices are widely used in risk evaluation and assessment. They have been included in various risk management guidelines and standards, such as IEC 60812 and ISO (2010), and are used as formal corporate risk acceptance decision making tools [31, 32]. Risk matrix is a simple tool to rank and prioritize risk of different scenarios and events, and support risk-based decision making. Risk matrix has been widely used in different process hazard analysis (PHA), including LOPA.

A risk matrix uses discrete categories of risk, consequence, and frequency, and presents them graphically. Figure 3 shows an example of a risk matrix. The vertical side is the Frequency, and the horizontal side is the Consequence. Risk is divided into 4 categories: Not acceptable (NA), Tolerable not acceptable (TNA), tolerable (TA), acceptable (A); frequency is divided into 7 categories: Remote (A), Unlikely (B), Very Low (C), Low (D), Medium (E), High (F), very High (G)); consequence is divided into 5 categories: Negligible (I), Low (II), Moderate (III), High (IV), Catastrophic (V). The following examples of reading the risk matrix shown in Figure 3:

IF “Frequency” is Remote (A) AND “Consequence” is Negligible (I), THEN “Risk” is Acceptable (A).

IF “Frequency” is Medium (E) AND “Consequence” is Low (II), THEN “Risk” is Tolerable not acceptable (TNA).

		Consequence				
		I	II	III	IV	V
Frequency	G	TNA	NA	NA	NA	NA
	F	TNA	TNA	NA	NA	NA
	E	TA	TNA	TNA	NA	NA
	D	TA	TA	TNA	TNA	NA
	C	A	TA	TA	TNA	TNA
	B	A	A	TA	TA	TNA
	A	A	A	A	TA	TA

Figure 3. Risk matrix example I.

A risk matrix can be developed through the following steps:

- 1) Scaling and categorization of the severity of consequence;
- 2) Scaling and categorization of the frequency;
- 3) Scaling and categorization of the outcome risk index;
- 4) Developing the risk-based rules based on expert knowledge and standards;
- 5) Graphical presentation of the risk matrix.

Each step can be filled in by different experts in a different manner. A risk matrix has two main functions. One is to prioritize the risk for different events or scenarios; the other is to support the risk decision making by providing the acceptance criteria of risk. As described in section 2.1, risk is defined as a function of consequence and frequency. Cox[33], and Levine [34] calculate risk as the multiplication of probability and consequence. In a risk matrix, the risk is defined as a mapping of categories of consequence and frequency to category of risk. The mapping is based on subject-matter experts (SME) and industrial standards.

2.3. Layer of Protection Analysis

LOPA, as described in the IEC61511 standard [35], is a semi-quantitative technique for analyzing and assessing risk. In LOPA, both frequency and consequence are expressed as an order of magnitude. Usually LOPA is conducted after a HAZOP study has

revealed a particular hazard that can appear in a scenario with such high frequency that the resulting risk must be reduced. LOPA is trying to answer three questions:

- What is the safety criterion?
- How many protection layers are needed?
- How much risk reduction could the protection layers provide?

As defined by the Center for Chemical Process Safety (CCPS) [28] , the primary purpose of LOPA is to determine whether there are sufficient independent protection layers (IPLs) to reduce risk to a tolerable level for a selected incident scenario. An IPL is a protection layer whose probability of failure is independent of those of the initiating event and other layers of protection associated with the selected scenario. Figure 4 shows some typical IPLs in a plant. They are process design, basic process control system, critical alarms and human intervention, safety instrumented function (SIF), physical protection, post-release physical protection, plant emergency response, community emergency response.

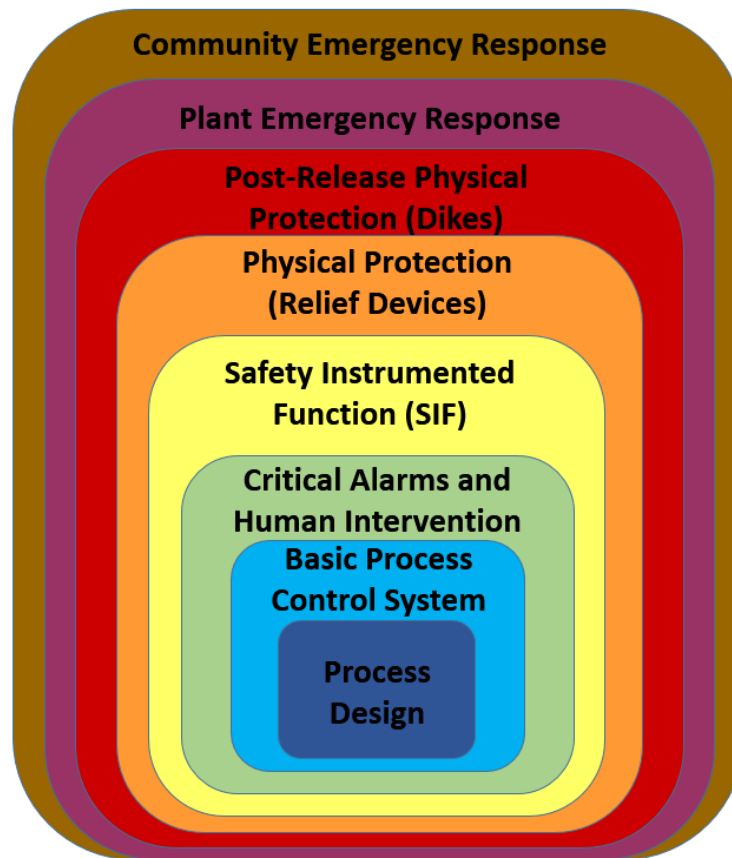

Figure 4. Layers of protection for a possible incident [28].

LOPA is applied to a single cause-consequence pair at a time. The outcome risk is compared with an acceptable or maximum tolerable risk. If the estimated risk of a selected scenario is too high, additional IPLs will be added to the process. Based on the assumption of independence, the failure frequency of the array of layers can be calculated by multiplying the frequency of the initiating event with the values of the individual probability of failure on demand.

As shown in Figure 5, LOPA can be applied to various stages in the process life, including research, process development, process design, operations, maintenance,

modifications, and decommissioning. However, LOPA is most frequently used during the process design stage and modification stage. In the design stage when a process flow diagram and a P&ID are available, LOPA is used to examine scenarios; in the modification stage, LOPA is applied to make sure enough IPLs are available to keep the risk in a tolerable range. LOPA is conducted by a team, thus the outcome from different teams can be slightly different. Due to this fact, it is important to keep the LOPA analysis consistent throughout the assessment.

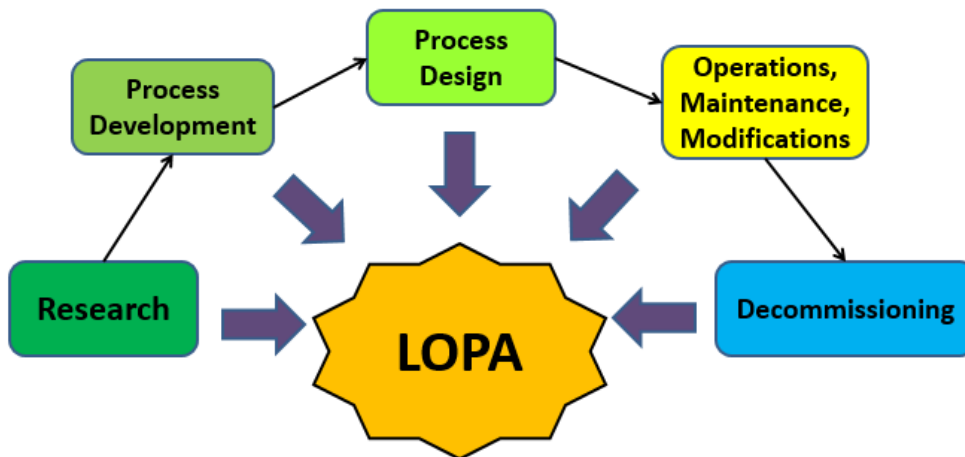

Figure 5. The process life cycle showing where LOPA is typically used [2].

As mentioned, LOPA is applied to a single cause-consequence pair at a time, and usually the most significant scenario is selected to calculate the risk. Each IPL reduces the frequency of the event if it is successful. The traditional LOPA methodology consists of six steps:

Step 1: Estimating consequences and severity. The category consequence is evaluated on a magnitude approximation. There are different endpoints for consequence analysis. Some companies are only interested in loss of containment, while other companies will further model the release and consider the fatalities, environmental impact, and economic loss. Either way is acceptable, but it is important to keep on a consistent basis for the whole LOPA process.

Step 2: Selecting a scenario. An incident scenario is a series of events, including initiating events and the failure of barriers and undesirable consequences. After we have a list of scenarios, LOPA is applied to one scenario at a time.

Step 3: Identifying initiating event and its frequency. Initiating events are not root causes, and it should be avoided to go too far into root causes. Sometimes, enabling events/conditions of initiating events should be considered. For LOPA, each scenario has a single initiating event.

Step 4: Identifying IPLs and estimating the probability of failure on demand. It is very important to identify the distinction between an IPL and a safeguard. IPLs, as safeguards, should satisfy the criteria of effectiveness, independence, and auditability [28]. A general step is to identify a list of safeguards first and then to screen safeguards to IPLs based on certain rules.

Step 5: Determining the frequency of scenarios. The risk of a scenario is calculated based on the data collected in the former steps. The frequency for a consequence can be calculated through Eq. (2-1).

$$\text{Eq. (2-1)} \quad f_i^C = f_i^l \times \prod_{j=1}^J PFD_{ij} = f_i^l \times PFD_{i1} \times PFD_{i2} \times \dots \times PFD_{ij}$$

- f_i^C : the frequency for consequence C for initiating event i
- f_i^l : the initiating event frequency for initiating event i ;
- PFD_{ij} : the probability of failure on demand (PFD) of the j th IPL for initiating event i .

LOPA can also be represented in a quantitative way, as shown in Figure 6. All the possible consequences for a given initiating event in an event tree are shown in the figure.

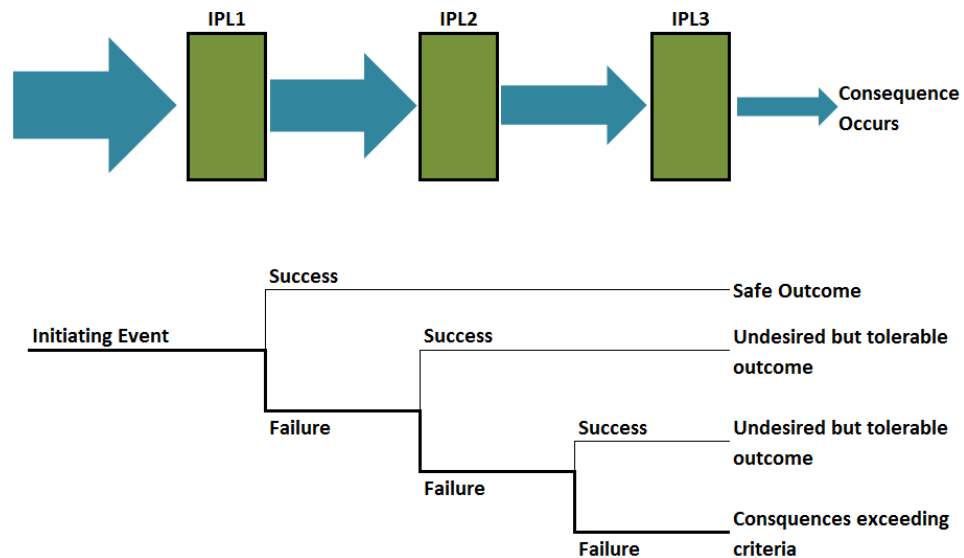

Figure 6. LOPA pictured as an event tree analysis [28].

Step 6: Making risk-based decisions using LOPA. The risk can be estimated using a risk matrix, and the value compared with the risk criteria of a company. If the risk is not tolerable, further actions are taken, such as adding a new IPL to reduce the risk.

3. BACKGROUND KNOWLEDGE OF FUZZY LOGIC

This section provides a brief introduction to the most basic concepts and operations of type-1 fuzzy logic and type-2 fuzzy logic that is necessary for the understanding of this project.

3.1. Classical Boolean Set

The theory of fuzzy logic is parallel to the theory of Boolean sets. Boolean sets are based on a binary logic that admits only true and false, was the leading theory from the late 19th century and the late 20th century. Fuzzy logic admits degrees of truth, and allows a proposition to be partially true and partially false at the same time [24]. Important concepts of Boolean set theory are introduced in this sub-section first.

Definition 3.1: Boolean set

A Boolean set, also known as a crisp set, is represented as a collection of elements, a_i , in a universe of discourse, U :

$$\text{Eq. (3-1)} \quad \mathcal{A} = \{ a_1, a_2, a_3, \dots, a_n \}$$

Table 1 shows the symbols and definition of Boolean sets symbols and set relations. In this table, \mathcal{A} and \mathcal{B} are two Boolean sets in the universe, U , while a and b are element in the universe.

Table 1. Boolean sets symbols and set relations.

Symbol	Symbol Name	Definition
$\{ \}$	Set	A collection of elements
U	Universe set	A collection of all possible values
\emptyset	Empty set	No element in an empty set. $\emptyset = \{ \}$
$\mathcal{A} \subseteq \mathcal{B}$	Subset	Subset \mathcal{A} has fewer or equal elements than set \mathcal{B}
$\mathcal{A} \subset \mathcal{B}$	Proper subset	Subset \mathcal{A} has fewer elements than set \mathcal{B}
$\mathcal{A} \not\subseteq \mathcal{B}$	Not subset	Set \mathcal{A} is not a subset of set \mathcal{B}
$\mathcal{A} = \mathcal{B}$	Equality	Set \mathcal{A} and Set \mathcal{B} has the same elements
$a \in \mathcal{A}$	Element of	Set membership
$a \notin \mathcal{A}$	Not element of	Not set membership
(a, b)	Ordered pair	A collection of two elements
$\mathcal{A} \times \mathcal{B}$	Cartesian product	Set of all ordered pairs from \mathcal{A} and \mathcal{B}
$ \mathcal{A} $	Cardinality	The number of elements of set \mathcal{A}

The operations of set \mathcal{A} and set \mathcal{B} can be found in Table 2. The main operations are union, intersection, complement and difference. The union of set \mathcal{A} and set \mathcal{B} , denoted $\mathcal{A} \cup \mathcal{B}$, represents all elements that belong to both set \mathcal{A} and set \mathcal{B} . The intersection of two sets, denoted $\mathcal{A} \cap \mathcal{B}$, represents all elements that belong to set \mathcal{A} or set \mathcal{B} . The complement of set \mathcal{A} , denoted $\bar{\mathcal{A}}$, represents all the elements in the universe U that does

not belong to set \mathcal{A} . The difference of set \mathcal{A} with set \mathcal{B} , denoted $\mathcal{A}|\mathcal{B}$, represents a collection of elements that belong to \mathcal{A} and do not belong to \mathcal{B} simultaneously.

Table 2. Boolean set operations.

Symbol	Symbol Name	Definition
$\mathcal{A} \cup \mathcal{B}$	Union	$\mathcal{A} \cup \mathcal{B} = \{a \mid a \in \mathcal{A} \text{ or } a \in \mathcal{B}\}$
$\mathcal{A} \cap \mathcal{B}$	Intersection	$\mathcal{A} \cap \mathcal{B} = \{a \mid a \in \mathcal{A} \text{ and } a \in \mathcal{B}\}$
$\bar{\mathcal{A}}$	Complement	$\bar{\mathcal{A}} = \{a \mid a \notin \mathcal{A}, a \in U\}$
$\mathcal{A} \mathcal{B}$	Difference	$\mathcal{A} \mathcal{B} = \{a \mid a \in \mathcal{A} \text{ and } a \notin \mathcal{B}\}$

The most important properties for defining Boolean sets are *associativity*, *distributivity*, *commutativity*, *idempotency*, *identity*, *transitivity*, and *involution*. Boolean sets also follow two special properties of set operations, known as *excluded middle axioms* and *De Morgan's principles*. Among all these properties, the *excluded middle axioms* are the only properties that are not valid for fuzzy sets operations. The *excluded middle axioms* consist of the *axiom of the excluded middle* and the *axiom of the contradiction*. Let \mathcal{A} , \mathcal{B} and \mathcal{C} be three Boolean sets on the universe U . All the properties and their definitions can be found in Table 3.

Table 3. Properties of Boolean sets.

Property	Definition
Associativity	$\mathcal{A} \cup (\mathcal{B} \cup \mathcal{C}) = (\mathcal{A} \cup \mathcal{B}) \cup \mathcal{C}$ $\mathcal{A} \cap (\mathcal{B} \cap \mathcal{C}) = (\mathcal{A} \cap \mathcal{B}) \cap \mathcal{C}$
Distributivity	$\mathcal{A} \cup (\mathcal{B} \cap \mathcal{C}) = (\mathcal{A} \cup \mathcal{B}) \cap (\mathcal{A} \cup \mathcal{C})$ $\mathcal{A} \cap (\mathcal{B} \cup \mathcal{C}) = (\mathcal{A} \cap \mathcal{B}) \cup (\mathcal{A} \cap \mathcal{C})$
Commutativity	$\mathcal{A} \cup \mathcal{B} = \mathcal{B} \cup \mathcal{A}$ $\mathcal{A} \cap \mathcal{B} = \mathcal{B} \cap \mathcal{A}$
Idempotency	$\mathcal{A} \cup \mathcal{A} = \mathcal{A}$ $\mathcal{A} \cap \mathcal{A} = \mathcal{A}$
Identity	$\mathcal{A} \cup \emptyset = \mathcal{A}$ $\mathcal{A} \cap U = \mathcal{A}$
Transitivity	If $\mathcal{A} \subseteq \mathcal{B}$ and $\mathcal{B} \subseteq \mathcal{C}$, then $\mathcal{A} \subseteq \mathcal{C}$
Involution	$\overline{\overline{\mathcal{A}}} = \mathcal{A}$
Axiom of the excluded middle	$\mathcal{A} \cup \overline{\mathcal{A}} = U$
Axiom of the contradiction	$\mathcal{A} \cap \overline{\mathcal{A}} = \emptyset$
De Morgan's principles	$\overline{\mathcal{A} \cap \mathcal{B}} = \overline{\mathcal{A}} \cup \overline{\mathcal{B}}$ $\overline{\mathcal{A} \cup \mathcal{B}} = \overline{\mathcal{A}} \cap \overline{\mathcal{B}}$

3.2. Type-1 Fuzzy Logic

Fuzzy set theory challenges not only the probability theory, but also the classical binary logic. A comparison between a classical binary set and a fuzzy set can be found in Figure 7. In this figure, set \mathcal{A} is a Boolean set, and set B is fuzzy set. A Boolean set is defined with crisp boundaries, while a fuzzy set is described by gradually shaded boundaries. For a Boolean set, an element inside the set A indicates that it is a member of A, otherwise it is not a member of A. However, for a fuzzy set B, an element in the shaded part indicates that it partly belongs to B.



Figure 7. Diagrams for a Boolean set and a type-1 fuzzy set.

Another way to understand the difference between Boolean sets and fuzzy sets is through the membership function $\mu(x)$. In a Boolean set, the membership function $\mu(x)=1$ when the element x belongs to the set A, and membership function $\mu(x)=0$ when the element x does not belong to the set A. However, partial membership function $\mu(x)$, which

can be any value between 0 and 1. Figure 8 shows the membership function $\mu(x)$ of a Boolean set and a fuzzy set.

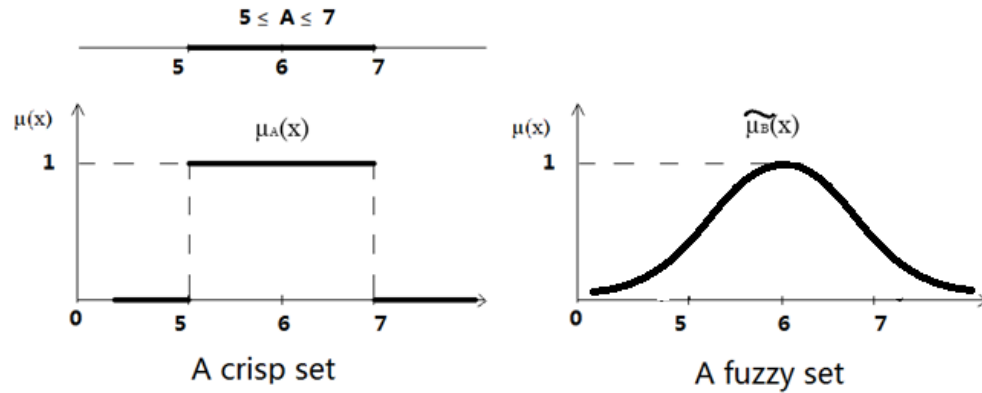

Figure 8. Membership function of a crisp set and a fuzzy set.

There are two types of fuzzy sets, type-1 fuzzy set and type-2 fuzzy set. Important concepts of type-1 fuzzy set theory are introduced in this sub-section.

3.2.1. Type-1 Fuzzy Set

Definition 3.2: Type-1 fuzzy set

In the universe of discourse, U , a type-1 fuzzy set A is defined as a set of ordered pair of the element and its membership function:

$$\text{Eq. (3-2)} \quad A = \{ (x, \mu_A(x)) \mid x \in U \}$$

- x : element of type-1 fuzzy set.
- $\mu_A(x)$: membership function of the type-1 fuzzy set A .

An alternative way to represent a type-1 fuzzy set A is through the following two equations. In Eq. (3-3), the element x is discrete; while in Eq. (3-4), x is continuous.

$$\text{Eq. (3-3)} \quad A = \left\{ \frac{\mu_A(x_1)}{x_1} + \frac{\mu_A(x_2)}{x_2} + \dots + \frac{\mu_A(x_n)}{x_n} \right\} = \left\{ \sum_i \frac{\mu_A(x_i)}{x_i} \right\}$$

$$\text{Eq. (3-4)} \quad A = \left\{ \int \mu_A(x)/x \right\}$$

- $\mu_A(x)$: membership function of the type fuzzy set A.
- $\frac{\mu_A(x_i)}{x_i}$: The division sign is not the mathematical operation of division. It means element x_i with its membership function $\mu_A(x_i)$.
- \int : a symbol indicates the collection of all points $x \in U$ with associated membership function $\mu_A(x)$.

Figure 9 shows a typical membership function of a fuzzy set. Some important definitions of a type-1 fuzzy set include “support” and “core”. The “support” of a type-1 fuzzy set is all the points x with its membership function larger than 0. The “core” of a type-1 fuzzy set is all the points x with its membership function equal to 1.

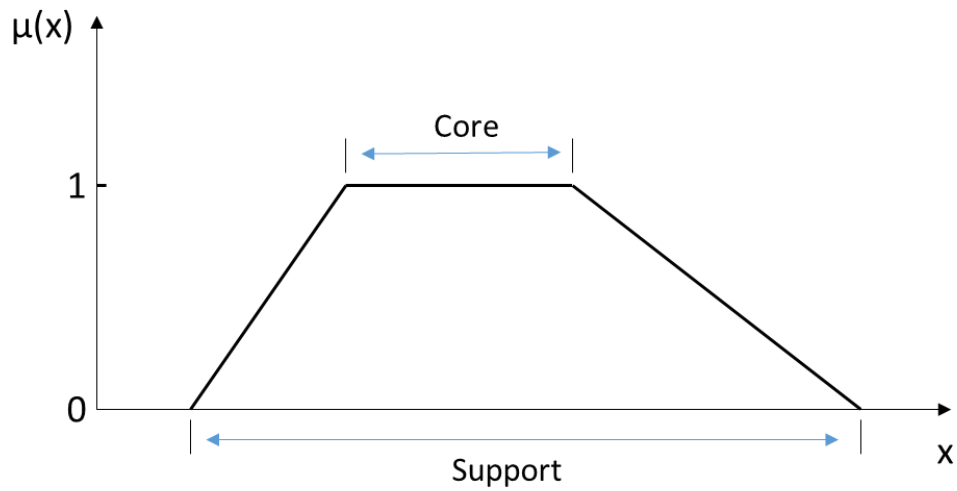

Figure 9. Core, support of a typical type-1 fuzzy set.

Definition 3.3: Support

The “support” of a type-1 fuzzy set is all the points x in U that $\mu_A(x) > 0$:

$$\text{support}(A) = \{x \mid \mu_A(x) > 0\}$$

Definition 3.4: Core

The “core” of a type-1 fuzzy set is all points x in U that $\mu_A(x) = 1$:

$$\text{core}(A) = \{x \mid \mu_A(x) = 1\}$$

Different shapes of membership functions can be used to establish fuzzy sets. Figure 10 represents the most commonly used shapes [36]. These are triangular, bell curves, trapezoid, Gaussian, and sigmoid. The selection of the shapes of the membership function is based on data and expert experience.

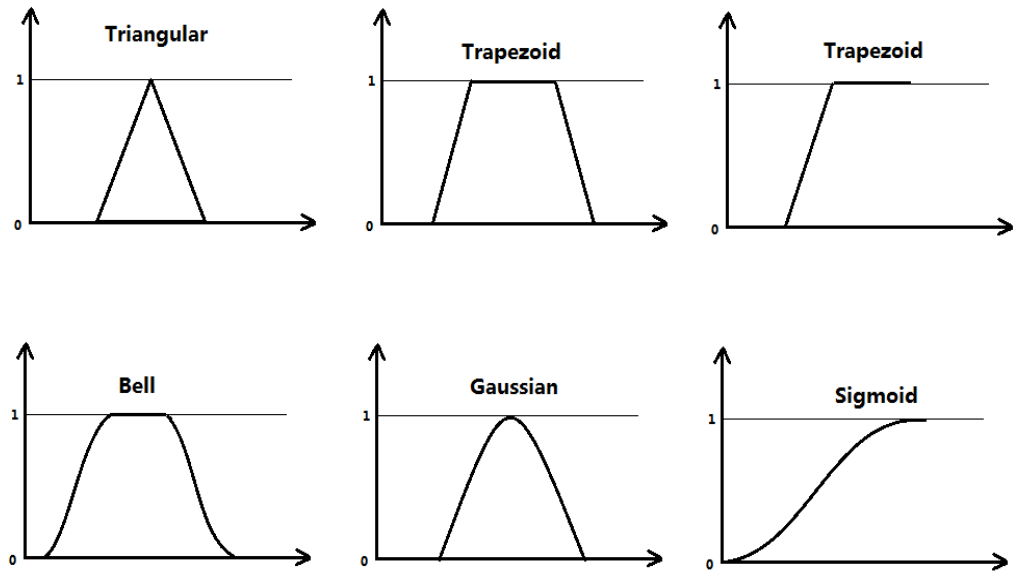

Figure 10. Membership function shapes [36].

One major advantage of the fuzzy logic system in modeling is the use of linguistic variables. A linguistic variable can be expressed by fuzzy sets allowing the fuzzy system to model with words or sentences in a natural language. For example, we can use linguistic variables to describe Age by “*young*”, “*mature*”, and “*old*”. As shown in Figure 11, three Gaussian combination membership functions are used to describe “*young*”, “*mature*”, and “*old*”, respectively.

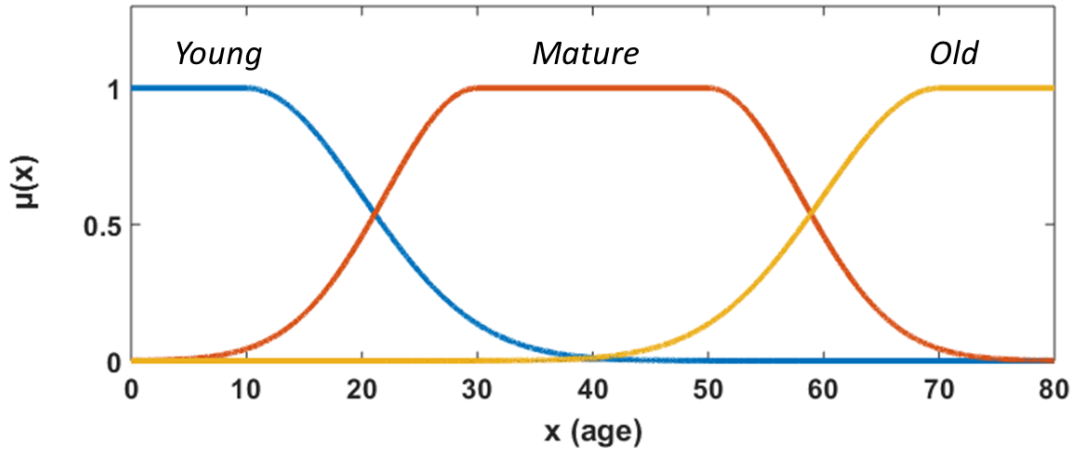

Figure 11. Membership function of three linguistic terms for Age.

The following three equations Eq. (3-5,6,7) are the mathematical expression of the three linguistic terms. The partial membership permits a numeric value to belong to more than one set. As shown in Figure 11, 60 years old partially belongs to “*mature*”, and partially belongs to “*old*”.

$$\text{Eq. (3-5)} \quad \mu(\text{"young"}, x) = \begin{cases} 1 & , 0 < x < 10 \\ e^{\frac{-(x-10)^2}{200}} & , x \geq 10 \end{cases}$$

$$\text{Eq. (3-6)} \quad \mu(\text{"mature"}, x) = \begin{cases} e^{\frac{-(x-30)^2}{128}} & , 0 < x \leq 30 \\ 1 & , 30 < x \leq 50 \\ e^{\frac{-(x-50)^2}{128}} & , x > 50 \end{cases}$$

$$\text{Eq. (3-7)} \quad \mu(\text{"old"}, x) = \begin{cases} e^{\frac{-(x-70)^2}{200}} & , 0 < x < 70 \\ 1 & , 70 \leq x < 80 \end{cases}$$

3.2.2. Basic Operations and Properties

The basic fuzzy sets operations are union, intersection, and complement. Figure 12 illustrates the standard fuzzy sets operations. Fuzzy set A and fuzzy set B are two fuzzy sets defined in the universe, U. In this figure, the results of the fuzzy set operations are marked in blue. Similar with the classical Boolean set operation, the standard fuzzy set union is based on maximum operation, the standard fuzzy set intersection is based on minimum operation, and the standard fuzzy set complement is based on complement operator. The standard fuzzy union is represented by the logic OR, while the standard fuzzy intersection is represented by logic AND. Table 4 shows the mathematical operations of type-1 fuzzy set operations.

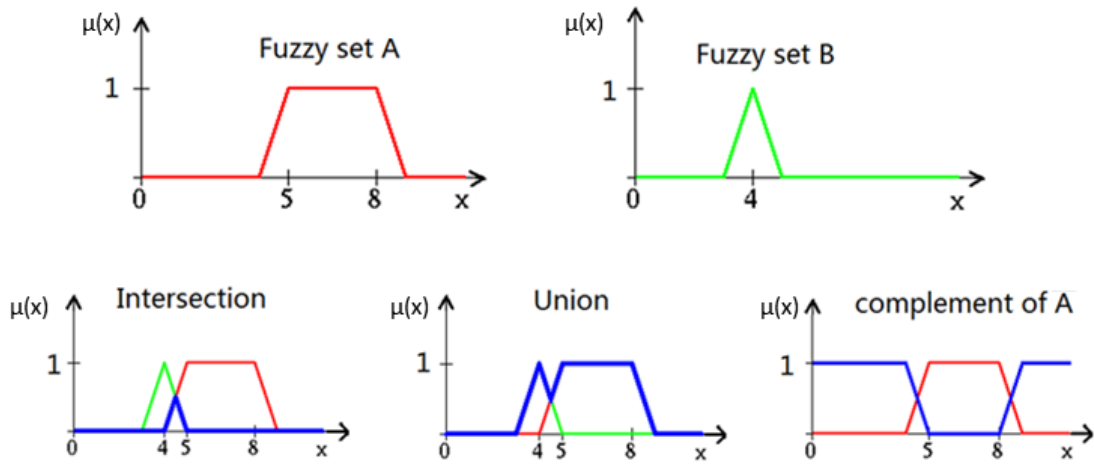

Figure 12. Type-1 fuzzy set operations: intersection (AND), union (OR) and complement.

Table 4. The standard operation of type-1 fuzzy sets.

Fuzzy operations	Definition
Standard fuzzy intersection of set A and B	$(A \cap B)(x) = \min[A(x), B(x)]$ for all $x \in U$
Standard fuzzy union of set A and B	$(A \cup B)(x) = \max[A(x), B(x)]$ for all $x \in U$
Standard fuzzy complement of set A	$A(x) = 1 - A(x)$ for all $x \in U$

Besides the standard fuzzy set union, intersection, and complement, there are some customized definition of fuzzy set operation based on dependent context and application. The empirical justification of these types of operations is based on either axiomatic definition or intuitive design. The family of fuzzy union operations is known as t-connorms, while the family of fuzzy intersection operations is known as t-norms [37].

Let A, B and C be three fuzzy sets in the Universe, U. Table 5 shows the properties of fuzzy sets. The important properties for fuzzy sets are *associativity*, *distributivity*, *commutativity*, *idempotency*, *identity*, *transitivity*, *involution*, and *De Morgan's principles*. The only properties that apply for Boolean sets but not apply for fuzzy sets are the *excluded middle axioms*, including the *axiom of the excluded middle* and the *axiom of the contradiction*. The following two equations express these two axioms for fuzzy sets:

$$\text{Eq. (3-8)} \quad A \cup \bar{A} \neq U$$

$$\text{Eq. (3-9)} \quad A \cap \bar{A} \neq \emptyset$$

Table 5. Properties of fuzzy sets.

Property	Definition
Associativity	$A \cup (B \cap C) = (A \cup B) \cap C$ $A \cap (B \cup C) = (A \cap B) \cup C$
Distributivity	$A \cup (B \cap C) = (A \cup B) \cap (A \cup C)$ $A \cap (B \cup C) = (A \cap B) \cup (A \cap C)$
Commutativity	$A \cup B = B \cup A$ $A \cap B = B \cap A$
Idempotency	$A \cup A = A$ $A \cap A = A$
Identity	$A \cup \emptyset = A$ $A \cap U = A$
Transitivity	If $A \subseteq B$ and $B \subseteq C$, then $A \subseteq C$
Involution	$\overline{\overline{A}} = A$
Morgan's principles	$\overline{A \cap B} = \overline{A} \cup \overline{B}$ $\overline{A \cup B} = \overline{A} \cap \overline{B}$

3.2.3. Type-1 Fuzzy Rules and Reasoning

In this section, type-1 fuzzy rules and reasoning are introduced, including fuzzy extension principal and α -cut Decomposition Theorem. The fuzzy rules and reasoning are

important for the arithmetic operations with fuzzy sets. Fuzzy rules and reasoning are the backbone of the fuzzy inferences, which are the key steps in the fuzzy logic modeling.

3.2.3.1. Fuzzy Relations

In addition, arithmetic operations are possible with fuzzy sets through the extension principle. The extension principle permits the fuzzification of mathematical structures based on set theory. A basic concept of fuzzy set theory provides steps to extend mathematical expression of crisp domains to fuzzy domains. Assume that f is a function from X to Y , as defined in Eq. (3-10).

$$\text{Eq. (3-10)} \quad A = \frac{\mu_A(x_1)}{x_1} + \frac{\mu_A(x_2)}{x_2} + \dots + \frac{\mu_A(x_n)}{x_n}$$

Through the mapping f , the fuzzy set A can be expressed as a fuzzy set B as

Eq. (3-11)

$$\text{Eq. (3-11)} \quad B = f(A) = \frac{\mu_A(x_1)}{y_1} + \frac{\mu_A(x_2)}{y_2} + \dots + \frac{\mu_A(x_n)}{y_n}$$

$$- \quad y_i = f(x_i)$$

If f is a many-to-one mapping, which means there exists $x_1, x_2 \in X, x_1 \neq x_2$, and $f(x_1) = f(x_2) = y^*, y^* \in Y$. In this situation, the membership function of B at $y = y^*$ is the maximum of the membership function of A at $x = x_1$ and $x = x_2$, since $f(x) = y^*$ may result from $x = x_1$ or $x = x_2$, as Eq. (3-12).

$$\text{Eq. (3-12)} \quad \mu_B(y) = \max(\mu_A(x))$$

Besides the extension principle, arithmetic operations with fuzzy sets can be obtained through the α -cut Decomposition Theorem, which give the same results by using Zadeh's extension principle [38].

Definition 3.7: “ α -cut”

The “ α -cut” of a type-1 fuzzy set A, denoted as A_α , is a crisp set defined by Eq. (3-13).

An example of the α -cut of a Trapezoid type-1 fuzzy set is shown in Figure 13.

$$\text{Eq. (3-13)} \quad A_\alpha = \{x \mid \mu_A(x) \geq \alpha\} = [a(\alpha), b(\alpha)]$$

- α is a value between 0 and 1.

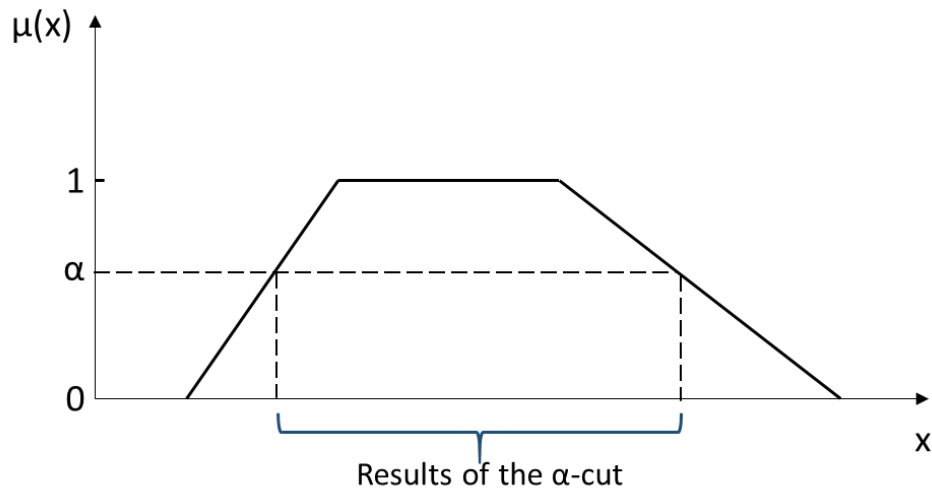

Figure 13. An example of type-1 fuzzy set and an α -cut.

Definition 3.8: Indicator function

$$\text{Eq. (3-14)} \quad I_{A(\alpha)}(x) = \begin{cases} 1, & \forall x \in A(\alpha) \\ 0, & \forall x \notin A(\alpha) \end{cases}$$

An important application of α -cut and indicator function is that they can be used to represent a type-1 fuzzy set. The following theorem is about the representation of a type-1 fuzzy set through α -cut and indicator function.

Theorem 1 (type-1 fuzzy set Decomposition Theorem)

A type-1 fuzzy set can be represented through Eq. (3-15) and Eq. (3-16) [39]. An example of the type-1 fuzzy set decomposed by n α -cuts is shown in Figure 14.

$$\text{Eq. (3-15)} \quad \mu_A(x|\alpha) = \alpha I_{A(\alpha)}(x)$$

$$\text{Eq. (3-16)} \quad \mu_A(x) = \bigcup_{\alpha \in [0,1]} \mu_A(x|\alpha)$$

- $\mu_A(x|\alpha)$ is all the points of x of a specific α -cut of the type-1 fuzzy set A.
- \bigcup Denotes the standard union operator.

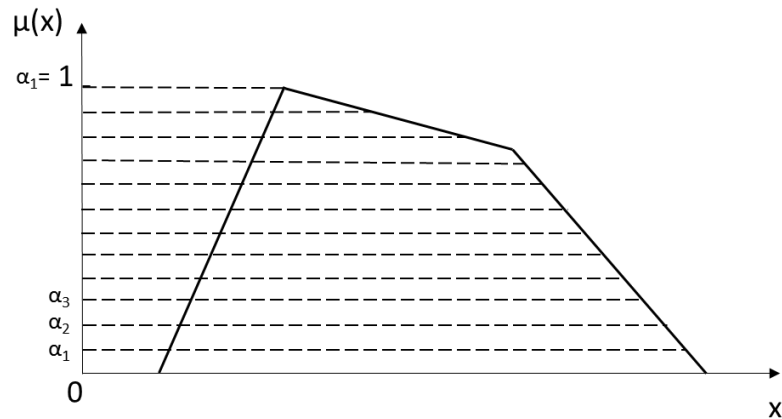

Figure 14. Illustration of the T1 FS Decomposition Theorem when n α -cuts are used.

3.2.3.2. Fuzzy Inference

Definition 3.9: Fuzzy If-Then Rules

A fuzzy if-then rule is presented in the form:

If x is A , then y is B .

- A : linguistic terms defined by fuzzy sets on the universes X , it also named premise or antecedent;
- B : linguistic terms defined by fuzzy sets on the universe Y , it also named conclusion or consequent.

There are many types of fuzzy inference systems that have been used in multiple applications, among which the most widely used are Mamdani fuzzy inference system [40], Sugeno fuzzy inference system (also known as TSK fuzzy system) [41] and

Tsukamoto fuzzy inference system[42]. Both Mamdani and Sugeno fuzzy procedures are used in this study.

A two fuzzy inference systems are used to illustrate the Mamdani and Sugeno procedures. Three linguistic variables are used in this example. Risk: {Tolerable, Not acceptable}; Frequency: {Medium, High}; Consequence: {Moderate, Catastrophic}. The Mamdani model uses if-then rules such as:

IF “*Frequency*” is Medium, AND “*Consequence*” is Moderate, “*Risk*” is Tolerable.

IF “*Frequency*” is High, AND “*Consequence*” is Catastrophic, “*Risk*” is Not acceptable.

The connector *AND* can be replaced by *OR* in some cases, and they are calculated by the operation of intersection and union, respectively. Figure 15 is an illustration of how a two-rule Mamdani fuzzy inference system derives the overall output “Risk” when subjected to two inputs “Frequency” and “Consequence”.

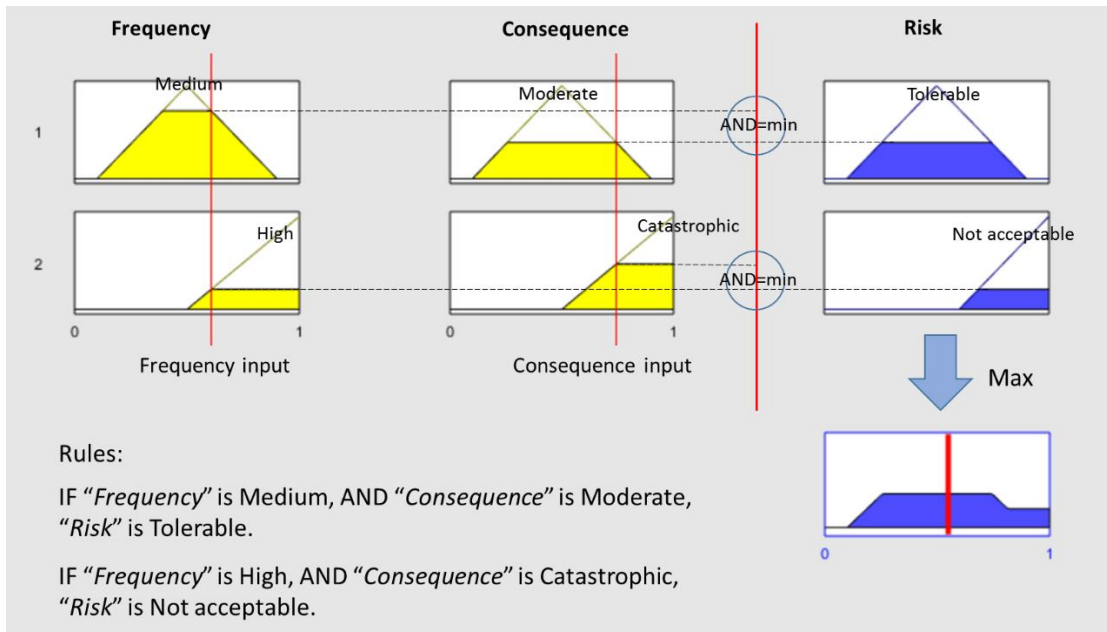

Figure 15. Mamdani fuzzy inference system.

Figure 16 illustrates the procedure of Sugeno (TSK) fuzzy inference system derives the overall output "Risk" when subjected to two inputs "Frequency" and "Consequence". The Sugeno model uses if-then rules such as:

IF "Frequency" is Medium, AND "Consequence" is Moderate,

"Risk"= $f_1(\text{frequency, consequence})$

IF "Frequency" is High, AND "Consequence" is Catastrophic,

"Risk"= $f_2(\text{frequency, consequence})$

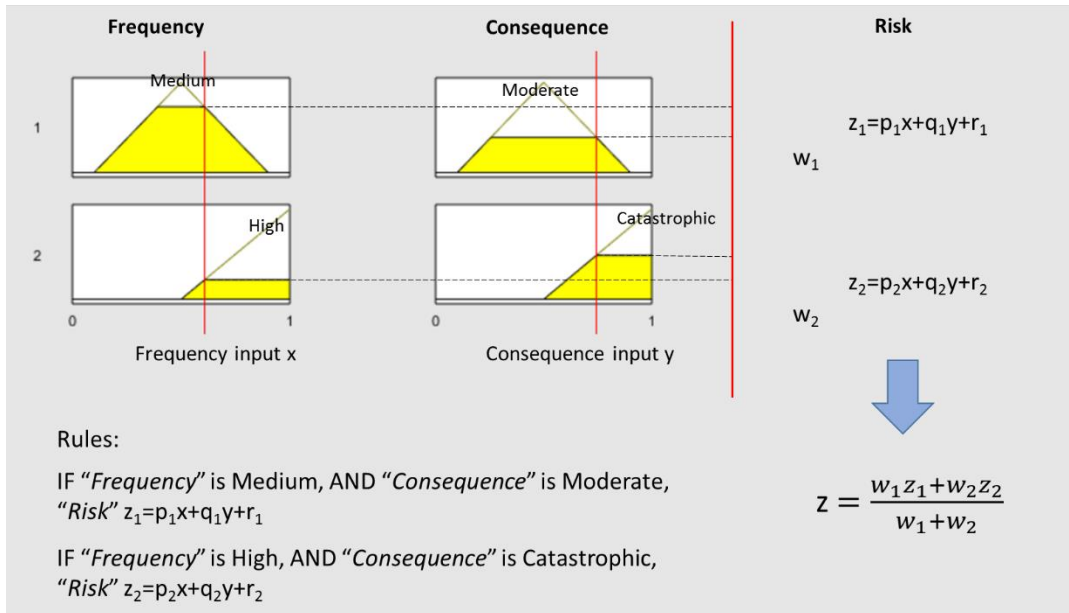

Figure 16. Sugeno (TSK) fuzzy inference system.

3.2.4. Type-1 Fuzzy Modeling

Fuzzy modeling can be implemented by four steps through Matlab Fuzzy logic tool box, and the conceptual structure of modeling system is interpreted in Figure 17.

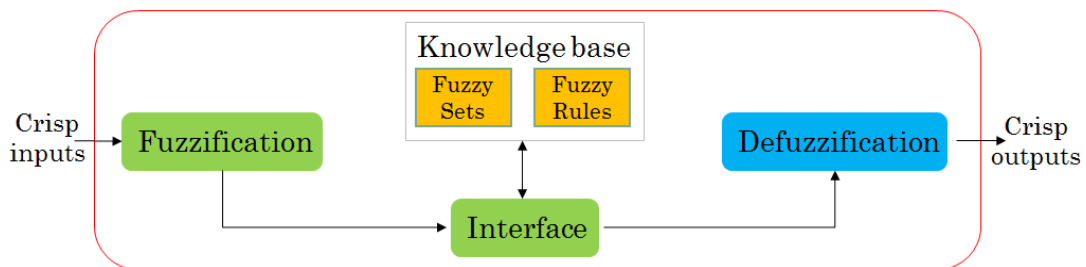

Figure 17. The structure of type-1 fuzzy logic system.

Step1: Fuzzification of input and output variables. Select relevant input and output variables as well as the universe of discourses for each variable. Then, determine the number of linguistic terms for each input and output variables and establish fuzzy membership functions.

Step 2: Fuzzy inference system. Choose a specific type of fuzzy inference system. Design a list of fuzzy if-then rules based on available knowledge and data (common sense, knowledge from experts, and physical laws).

Step 3: Defuzzification of the resultant fuzzy membership function. Translate the output from all fuzzy if-then rules into an understandable crisp value. There are many different types of defuzzification methods, including max membership principle, centroid method, weighted average method, mean max membership, center of sums, center of largest area, and first (or last) of maxima [37]. The most commonly used method is Centroid (COA) approach, as Eq. (3-17).

$$\text{Eq. (3-17)} \quad COA = \frac{\int x\mu_C(x)dx}{\int \mu_C(x)dx}$$

– $\mu_C(x)$: the resultant membership function of output.

Note: From the point of view of using all information for a decision, also the quantified uncertainty in the outcome, the defuzzification step can be regarded as a disadvantage of the method because, although the reading of a crisp value is more clear, by the defuzzification the uncertainty information is lost.

Step 4: Optimization of the whole system. Through the interview with human experts who are familiar with the target systems and more studies, parameters of

membership functions (MFs) can be further modified and more rules can be incorporated into the system.

3.3. Type-2 Fuzzy Logic

This section introduces the basic concepts, and basic operations for the type-2 fuzzy sets and modeling. Basically, a type-2 fuzzy set is a set in which we also have uncertainty about the membership function. A higher degree of approximation can be achieved in modeling real world problems.

3.3.1. *Type-2 Fuzzy Set*

In this study, type-2 fuzzy logic will also be used to modify the LOPA methodology. The concept of a type-2 fuzzy set was introduced by Zadeh in 1975 as an extension of the concept of the type-1 fuzzy set [43]. The difference between a type-1 fuzzy set and a type-2 fuzzy set is that the membership grade for each element of the type-1 set is a crisp number in $[0,1]$, while the membership grade of type-2 set is a fuzzy set in $[0,1]$. Type-1 fuzzy sets can be treated as a first-order approximation to the uncertainty in the real life, and type-2 fuzzy sets is a second-order approximation. As illustrated in Figure 18, we can get a type-2 fuzzy set by blurring a type-1 membership to the left and to the right.

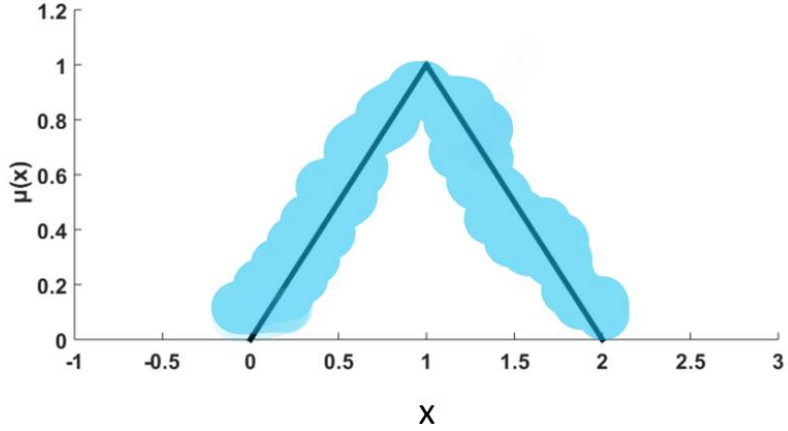

Figure 18. Type-2 membership function as a blurred type-1 membership function [44].

Definition 3.10: A type-2 fuzzy set \tilde{A} is characterized by its membership function:

$$\text{Eq. (3-18)} \quad \tilde{A} = \int_{x \in U_{\tilde{A}}} \int_{u \in J_x \subseteq [0,1]} \mu_{\tilde{A}}(x, u) / (x, u)$$

- x : the primary variable, and it has domain $U_{\tilde{A}}$.
- u : the secondary variable, and it has domain $J_x \subseteq [0,1]$ at each $x \in U_{\tilde{A}}$
- J_x : the primary membership of x , and it is defined in Eq. (3-4)
- $\mu_{\tilde{A}}(x, u)$: the secondary membership function of \tilde{A}

To better understand the concept of type-2 fuzzy sets and the difference between type-1 fuzzy set and type-2 fuzzy set, let's look at some examples.

Example 1. Consider the case of a type-2 fuzzy set characterized by a half circle membership function with a constant radius r , and the center is moving horizontally.

$$\text{Eq. (3-19)} \quad \mu(x) = \sqrt{1 - (x - a)^2}; \quad a \in [1, 1.4], \mu(x) \geq 0$$

In this example, the membership grade $\mu(x)$ of any specific x can be a number of any possible values depends on the value of a . For example, $\mu(x)$ can be any number between 0.886 and 0.994 when x equals to 1.5, as shown in the figure 19. In this example, the membership grade of the type-2 fuzzy set is an interval. While the membership grade of a type-1 fuzzy set is a crisp value.

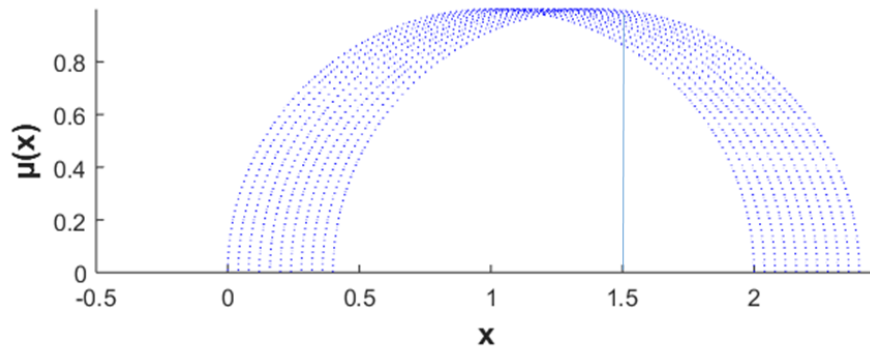

Figure 19. Type-2 fuzzy set example I.

Example 2. Consider the case of a fuzzy set characterized by a half circle membership function with a constant radius r , and the center is moving vertically, shown in Figure 20. Same with example 1, to a specific x value, the membership function $\mu(x)$ is an interval.

$$\text{Eq. (3-20)} \quad \mu(x) = \sqrt{1 - (x - 1)^2} - b ; b \in [0, 0.4], \mu(x) \geq 0$$

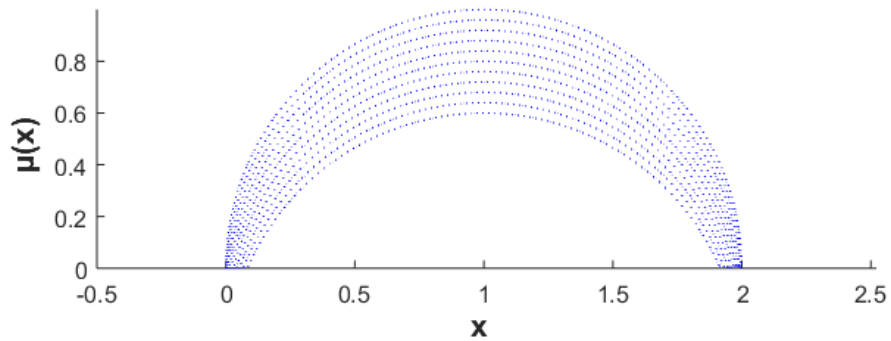

Figure 20. Type-2 fuzzy set example II.

Example 3. A torus type-2 is a fuzzy set in which the membership grade of every domain point is a half circle type-1 membership function, shown in Figure 21. This example shows a more complicated case. The membership function $\mu(x)$ is three-dimensional. To a specific x value, the membership function $\mu(x)$ is a type-1 fuzzy set.

Eq. (3-21)

$$f(x, y, z) = (R - \sqrt{x^2 + y^2})^2 + z^2 - r^2; R = 1, r = 0.2, y \geq 0, z \geq 0$$

- R : the distance from the center of the tube to the center of the torus;
- r : the radius of the tube.

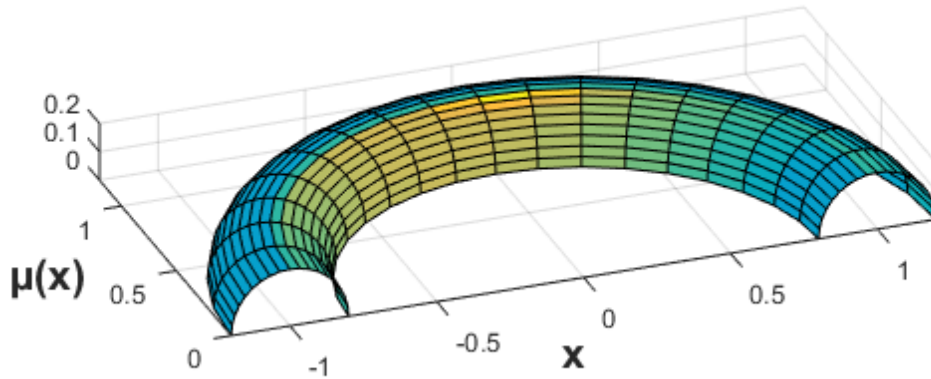

Figure 21. Type-2 fuzzy logic example III.

3.3.2. Interval Type-2 Fuzzy Set

Interval type-2 fuzzy set is one in which the membership grade of every domain point is a crisp set whose domain is some interval within $[0,1]$. Both figure 19 and figure 20 are interval type-2 fuzzy sets. Interval type-2 fuzzy set is a simplified version of type-2 fuzzy set. The membership function to a specific x value is a crisp set, whose domain is an interval between 0 and 1. The fuzzy sets in example 1 and example 2 are interval type-2 fuzzy sets. Figure 22 shows the comparison of a type-1 Trapezoid fuzzy set and an interval type-2 Trapezoid fuzzy set.

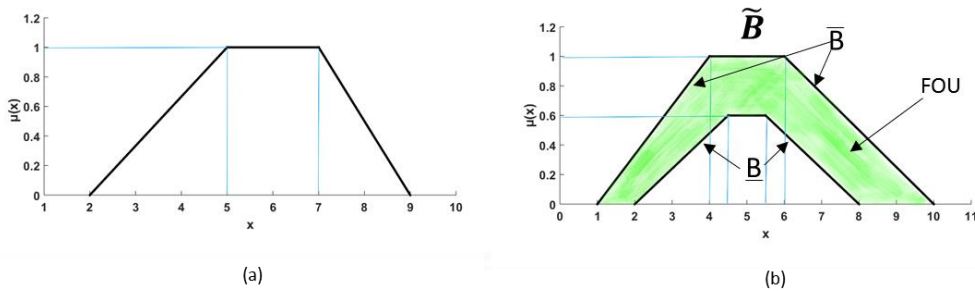

Figure 22. (a) Type-1 fuzzy set; (b) Interval type-2 fuzzy set.

An interval type-2 fuzzy set can be treated as a region between two type-1 fuzzy sets. As shown in the figure 22(b), the interval type-2 fuzzy set \tilde{B} can be treated as the region between the upper membership function \bar{B} and the lower membership function. In other words, the upper membership function \bar{B} is the upper boundary of an interval type-2 fuzzy membership function, and the lower membership function \underline{B} is the lower boundary of an interval type-2 fuzzy membership function. The green region in between is named the footprint of uncertainty (FOU). Mathematically, an interval type-2 fuzzy is the union of type-1 fuzzy membership function [45].

In example 2, the upper membership function is described in Eq. (3-22) and the lower membership function is described in Eq. (3-23). And the region in between \bar{B} and \underline{B} is the FOU. With the definition of FOU, Eq. (3-24) describes a very compact way to represent an interval type-2 fuzzy set.

$$\text{Eq. (3-22)} \quad \bar{B} = \sqrt{1 - (x - 1)^2} ; b \in [0, 0.4], \bar{B} \geq 0$$

$$\text{Eq. (3-23)} \quad \underline{B} = \sqrt{1 - (x - 1)^2} - 0.4 ; b \in [0, 0.4], \underline{B} \geq 0$$

$$\text{Eq. (3-24)} \quad \tilde{B} = 1/FOU(\tilde{B})$$

- $1/FOU(\tilde{B})$: The division sign is not the mathematical operation of division. It means that the secondary grade equals to 1 for all elements of FOU for set \tilde{B} .

3.3.3. Basic Operations

In this section we describe the operation of the interval type-2 fuzzy sets, including union, intersection and complement.

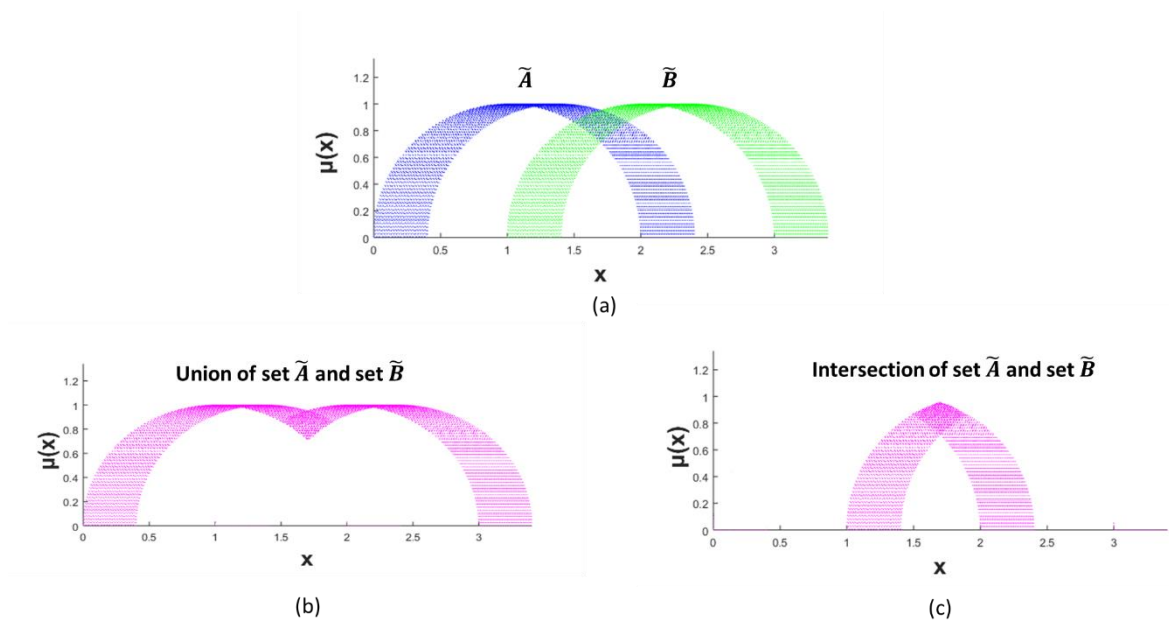

Figure 23. Standard interval type-2 fuzzy sets operations (a). Interval type-2 fuzzy set \tilde{A} and \tilde{B} . (b). Standard union of \tilde{A} and \tilde{B} . (c). Standard intersection of \tilde{A} and \tilde{B} .

Similar with standard type-1 fuzzy logic operation, interval type-2 fuzzy set union is based on maximum operation, interval type fuzzy set intersection is based on minimum operation, and interval type-2 fuzzy complement is based on complement operator. The

standard fuzzy union is represented by the logic OR, while the standard fuzzy intersection is represented by logic AND. Figure 23 shows the set operations of two interval type-2 fuzzy sets $\tilde{\mathbf{A}}$ and $\tilde{\mathbf{B}}$. Table 6 shows the mathematical definition of the interval type-2 fuzzy set operations.

Table 6. The standard operation of type-2 fuzzy sets.

Fuzzy operations	Definition
Standard fuzzy intersection of set $\tilde{\mathbf{A}}$ and $\tilde{\mathbf{B}}$	$(\tilde{\mathbf{A}} \cap \tilde{\mathbf{B}})(x) = \min[\tilde{\mathbf{A}}(x), \tilde{\mathbf{B}}(x)]$ for all $x \in X$
Standard fuzzy union of set $\tilde{\mathbf{A}}$ and $\tilde{\mathbf{B}}$	$(\tilde{\mathbf{A}} \cup \tilde{\mathbf{B}})(x) = \max[\tilde{\mathbf{A}}(x), \tilde{\mathbf{B}}(x)]$ for all $x \in X$
Standard fuzzy complement of set $\tilde{\mathbf{A}}$	$\tilde{\mathbf{A}}^c(x) = 1 - \tilde{\mathbf{A}}(x)$ for all $x \in X$

3.3.4. Interval Type-2 Fuzzy Reasoning

Theorem 2: Representation Theorem for an interval type-2 fuzzy set[46]

This theorem allows an interval type-2 fuzzy sets be represented in term of type-1 fuzzy sets. Assume x is the primary variable of an interval type-2 fuzzy set $\tilde{\mathbf{A}}$, and it is sampled at N values, x_1, x_2, \dots, x_N . μ_i is the primary memberships at each of x values, and it is sampled in M_i values, $u_{i1}, u_{i2}, \dots, u_{iM}$. Let A_e^j denote the j^{th} embedded type-1 fuzzy set for $\tilde{\mathbf{A}}$. The $\tilde{\mathbf{A}}$ is represented by the following equation:

Eq. (3-25)

$$FOU(\tilde{A}) = \bigcup_{j=1}^{n_A} A_e^j = \{\underline{A}(x), \dots, \bar{A}(x)\} \equiv [\underline{A}(x), \bar{A}(x)]$$

- n_A : the total number of M.
- A_e^j : the j^{th} embedded type-1 fuzzy set for \tilde{A} .

Same with type-1 fuzzy set, there are different types of fuzzy inference systems for type-2 fuzzy modeling, including Mamdani inference and Sugeno (TSK) inference. The consequent of a Mamdani rule is a fuzzy set, while the consequent of a Sugeno rule is a function.

3.3.5. *Interval Type-2 Fuzzy Modeling*

In the type-2 fuzzy system, as illustrated in Figure 24, there is a step called type-reducer before the final defuzzification. The final results of type-2 fuzzy membership function need to be reduced to type-1 fuzzy membership function, then defuzzified to a crisp value.

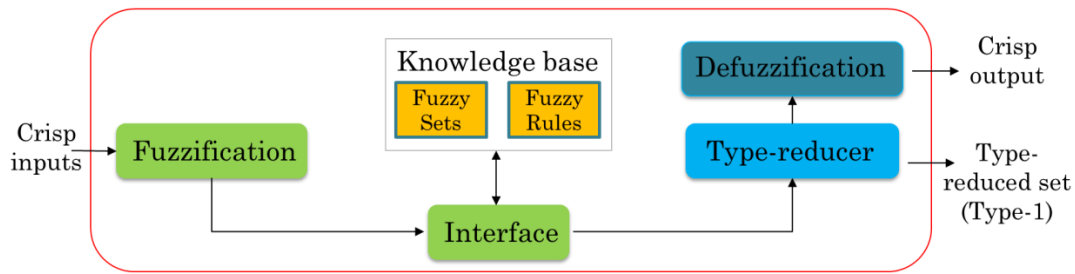

Figure 24. The structure of type-2 fuzzy logic system.

Step1: Fuzzification of input and output variables. (If Sugeno fuzzy inference is used, only fuzzification of input variables is needed. The output variables are then determined by a function of input variables.) Select relevant input and output variables as well as the universe of discourses for each variable. Then, determine the number of linguistic terms for each input and output variables and establish fuzzy membership functions.

Step 2: Fuzzy inference system. Choose a specific type of fuzzy inference system. Design a list of fuzzy if-then rules based on available knowledge and data (common sense, knowledge from experts, and physical laws).

The following shows an example of a Sugeno rulebase of an Interval type-2 fuzzy set consisting of N rules assuming the following forms:

$$R^n: \text{IF } x_1 \text{ is } \tilde{X}_1^n \text{ and } \dots \text{ and } x_l \text{ is } \tilde{X}_l^n, \text{ THEN } y \text{ is } Y^n \quad n = 1, 2, \dots, N$$

- R^n : n^{th} rule
- \tilde{X}_i^n : interval type-2 fuzzy set
- Y : $Y = [\underline{y}^n, \bar{y}^n]$ is an interval. For each rule, the consequent is an interval.

Assume the input vector is $x' = (x'_1, x'_2, \dots, x'_l)$. Then the firing interval of the n th rule, $F^n(x')$, can be calculated through the following function:

Eq. (3-26)

$$F^n(x') = [\mu_{\underline{X}_1^n}(x'_1) \times \dots \times \mu_{\underline{X}_l^n}(x'_l), \mu_{\overline{X}_1^n}(x'_1) \times \dots \times \mu_{\overline{X}_l^n}(x'_l)] \equiv [f^n, \bar{f}^n]$$

– $\tilde{X}_i^n = [\mu_{\underline{X}_i^n}(x'_i), \mu_{\overline{X}_i^n}(x'_i)]$: the membership function x'_i

Step 3: Type-reducer and defuzzification of the resultant fuzzy membership function. Type-reduction then is performed to combine $F^n(x')$ and the corresponding rule consequents. There are different methods, and the most widely used method is the center-of-sets type-reducer [47]:

$$\text{Eq. (3-27)} \quad Y_{cos}(x') = \bigcup_{\substack{f^n \in F^n(x') \\ y^n \in Y^n}} \frac{\sum_{n=1}^N f^n y^n}{\sum_{n=1}^N f^n} = [y_l, y_r]$$

KM algorithm [48] can be used to calculate y_l and y_r . The defuzzified output can be calculated through the following equation:

$$\text{Eq. (3-28)} \quad y = \frac{y_l + y_r}{2}$$

Step 4: Optimization of the whole system. Through the interview with human experts who are familiar with the target systems and more studies, parameters of membership functions (MFs) can be further modified and more rules can be incorporated into the system.

4. A PROBABILISTIC AND FUZZY LOGIC HYBRID APPROACH *

This section describes a fuzzy logic and probabilistic hybrid approach that was developed to determine the mean value and to quantify the uncertainty of frequency of an initiating event and the probabilities of failure on demand (PFD) of independent protection layers (IPLs). It is based on the available data and expert judgment. The method was applied to a distillation system with a capacity to distill 40 tons of flammable n-hexane.

4.1. Uncertainty Sources in Failure Rate

Layer of protection analysis (LOPA) provides a simplified and less precise method to assess the effectiveness of protection layers and the residual risk of an incident scenario. The outcome failure frequency and consequence of that residual risk are intended to be conservative. This makes the risk in a conservative approach usually overestimated.

The failure rate consists of the frequency of an initiating event and the probabilities of failure on demand (PFD) of independent protection layers (IPLs). They are related with the frequency part of the risk. Two aspects are investigated in this part. First aspect is the sources of uncertainty in failure rate. Second aspect is the representation of uncertainty in failure rate data.

* Part of this section is reprinted with permission from “A fuzzy logic and probabilistic hybrid approach to quantify the uncertainty in layer of protection analysis” by Yizhi Hong, Hans J. Pasman, Sonny Sachdeva, Adam S. Markowski, and M. Sam Mannan, 2016. *Journal of Loss Prevention in the Process Industries* 43, Copyright 2016 by Elsevier.

Uncertainty exists in the failure rate data. Generally speaking, if there are more data in the database, and all the data are scientifically collected and analyzed, the data will be more accurate, *i.e.*, there is less uncertainty in the database. Moreover, the sources of the data can also affect the amount of uncertainty. There are two types of database, including generic database and plant-specific database. Table 7 shows the definition, advantages and disadvantages of generic database and plant-specific data. Typical generic databases are available at the Center for Chemical Process Safety (CCPS) [49] and the Offshore Reliability Data Handbook (OREDA) [50]. Compared to generic database, plant-specific data are first-hand data, and it can better reflect the actual situations of the process and equipment. The ideal method to eliminate uncertainty is collecting enough plant-specific data. However, an extensive data collection system for a plant is much time and money consuming and in practice not realizable. Generic databases, which provide a much larger pool of data, are less specific and have less detail. The environmental conditions and operating conditions, the maintenance policy, and the definition and boundary of the investigating instruments can be different from those of the instruments in the generic databases. In these situations, using generic databases could increase the uncertainty. Moreover, expert knowledge is used in some situations when no data are available.

Table 7. Comparison of generic databases and plant-specific failure data.

	Generic databases	plant-specific failure data
Def.	Data from a variety of plants and industries	Failure data from the on-site plant
Pros	Provide a much larger pool of data	Reflect the plant's process, environment, maintenance practices, and operation of equipment
Cons	Less specific and detailed	Data collection is very difficult, and an extensive data collection system is expensive

In conventional LOPA, single point values or the upper bounds of intervals of failure rates are derived from historical data or literature, and there is no uncertainty information in a point value. The expression of the data in this way does not take the uncertainty into account.

4.2. Relevant Literature Review and Gap Identification

Markowski and Mannan [10] developed a fuzzy LOPA (fLOPA) approach for risk assessment of transportation of flammable substances in long pipelines. The risk value calculated by fLOPA shows a more accurate result than those given by conventional LOPA. Khalil *et al.* [51] developed a cascaded-fuzzy LOPA risk assessment model with

an application in the natural gas industry. Ouazraoui *et al.* [5] used fuzzy quantities to represent the data provided from reliability databases and expert judgments in LOPA. Although the result is a parameter value, no uncertainty information is preserved, which is considered a drawback of the method.

Freeman used observed data distributions on component failure where they are available (*e.g.*, a pressure relief valve). However, these are scarce. He also extended an available single data point of a component failure probability to a simple triangular distribution by simply adding a lower and upper limit, which are based on site operator experience [52, 53]. Given a triangular distribution, the mean value and variance can be calculated. As is known, variance is an indication of uncertainty. The convolution of different failure rate data is through the application of variance contribution analysis (VCA) and a simplified numerical approximation. The final frequency is also a distribution with uncertainty information.

Pasman and Rogers [54] applied Bayesian network in LOPA. The Bayesian network (BN) approach is based on existing data and knowledge including uncertainty. Distributions were developed based on data and expert knowledge to represent the failure rate. The final risk result is a distribution with uncertainty information. By the inference and diagnosis options BN improves understanding of complex systems.

As shown in Table 7, there are benefits and drawbacks in using generic database and plant-specific data solely. The basic elements of a good database include the source of data, failure mode, confidence and tolerance of the data, equipment definition and boundary diagrams, process severity, environment, maintenance, *etc.* [49] Considering

these aspects of data, the aggregation is not a simple process, thus expert knowledge and judgment is required. An expert needs to first assess the quality and relevance of a database, and then perform an aggregation process based on an investigation of the basic elements of the database.

Through fuzzy logic, expert knowledge can easily be incorporated in a LOPA model to reduce uncertainty. However, due to the defuzzification step in fuzzy logic modeling, only a crisp value can be obtained in the final result. This means that the fuzzy results are more accurate values of the mean but all the uncertainty information is lost in the modeling process.

Both of the distributions in Freeman's model and Pasman and Rogers's model are the combination of data and expert knowledge. Freeman used VCA for the failure rates aggregation, and Pasman and Rogers used Monte Carlo and dynamic discretization methods. The results of both methods are distributions, which maintain all the uncertainty information. However, experts can express their knowledge easier in linguistic terms on an ordinal scale which can be directly translated to fuzzy membership functions, an advantage of the fuzzy logic approach.

In this section, a fuzzy logic and probabilistic hybrid approach is developed to efficiently aggregate generic database and plant-specific data using expert judgment, and taking account of both uncertainties in the data and expert knowledge. The hybrid approach not only determines the mean value of failure rate, but also quantifies the uncertainty. This approach takes advantage of all available information, including generic databases, plant-specific data, and expert experience. Each frequency or probability is

expressed in a distribution. The final frequency, which is the multiplication of the frequency of the initiating event and all the PFD of IPLs, is accomplished by the Monte Carlo simulation.

4.3. Present Hybrid Approach

The structure of the fuzzy logic and probabilistic hybrid approach is illustrated in Figure 25. First, a distribution is generated from the generic database and available plant-specific data. For the distribution, different types of functions can be used. In this research, the log-normal distribution is used for its wide application in reliability and failure rate data due to its merits of non-negative values and a long tail. The probability density function for log-normal distribution is described in Eq. (4-1,2,3).

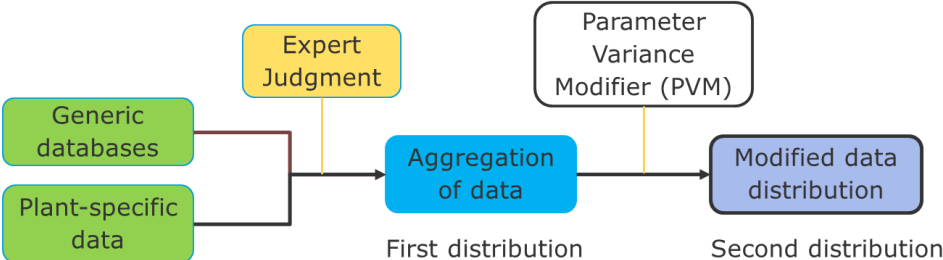

Figure 25. Structure of fuzzy logic and probabilistic hybrid approach.

$$\text{Eq. (4-1)} \quad f(x | m, v) = \frac{1}{\sigma\sqrt{2\pi}} \exp\left[-\frac{(\ln x - u)^2}{2\sigma^2}\right]$$

$$\text{Eq. (4-2)} \quad m = \exp\left(u + \frac{\sigma^2}{2}\right)$$

$$\text{Eq. (4-3)} \quad v = \exp(2u + \sigma^2)(\exp(\sigma^2) - 1)$$

- μ : the mean of the variable's normal logarithm
- σ : the standard deviation of the variable's normal logarithm
- m : the mean of the lognormal distribution
- v : the variance of the lognormal distribution

Here, m and v will be obtained by fitting a distribution function to the collected sets of data. Depending on the quantity and differences between data sets and between data proper of a set, different methods can be followed. A distribution can be fitted to each set and the distributions of the sets convoluted. One can also put all data together and fit a distribution to the whole collection. The data sets have different quality and background, so one could consider to give the most reliable ones a weighting factor (>1). The spread, as expressed in the standard deviation of a distribution, is only part of the uncertainty. Best way to proceed would be to have experts give their opinion about the reliability of the data and to include that in the uncertainty expressed in the standard deviation, while retaining the mean. By presenting a set of fixed qualifiers, experts can select from a correction on the v -value. This appears to be a simpler approach for expert elicitation than weighting factors for which no reference is available. Losing the uncertainty information on the

variance by deriving the crisp value is only a second order effect compared to the same on the mean.

To achieve the objective sketched above by means of fuzzy logic, a parameter variance modifier (PVM) is developed to further modify the distribution based on four factors: *database quality*, *database relevance*, *quantity of plant-specific data*, and *experience level of expert*. *Database quality* is to assess whether the database is established based on a scientific approach, and whether the data is scientifically collected and statistically analyzed. *Database relevance* is about whether the environmental condition and operation condition of the instrument for the database is close to those in the target facility. The larger *quantity of plant-specific data* indicates a more accurate distribution. The uncertainty of expert judgment is assessed based on the *experience level of expert*. The modeling structure of PVM is illustrated in Figure 26. It means that *database quality* and *database relevance* determine the parameter *database applicability*; while the latter together with the *quantity of plant-specific data* determine the *data confidence*. Finally, *data confidence* and *experience level of expert* determine the PVM. Type-1 fuzzy logic modeling is used in each step.

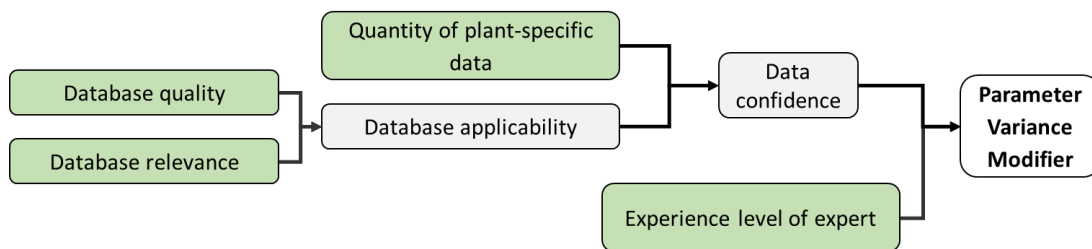

Figure 26. Fuzzy modeling of parameter variance modifier (PVM).

PVM is a value between 0 and 1. For a distribution modified by PVM, its mean value μ remains the same, while its variance is modified by Eq. (4-4):

$$\text{Eq. (4-4)} \quad v^* = \frac{v}{\sqrt{PVM}}$$

- v : the variance for the first derived log-normal distribution.
- v^* : the variance for the modified distribution

Because PVM is a value within [0, 1], v^* will be a number larger than v , or equal to it if all factors are assessed as highest. Thus, a smaller PVM value indicates that a larger uncertainty is remaining in the aggregation process of generic database and plant-specific data. The square root is chosen to make the effect of the PVM non-proportional, hence relatively less to weaken the influence at very low PVN values.

According to the fuzzy modeling process shown in Figure 17, the first step is fuzzification of all the inputs and output. Table 8 illustrates the universal discourse and description of each linguistic variable. The membership functions of all parameters were established and the final PVM values generated with the help of the Matlab Fuzzy Toolbox, as shown in Figure 27-33. The Quantity of plant-specific data is evaluated based on the available number[55], and experience level is evaluated based on the working time (year) of the expert. All other input parameters are also scaled from 0 to 1, while 0 means limited and 1 means good.

Table 8. Fuzzy linguistic variables description.

Linguistic variables	Universe of discourse	Descriptive linguistic terms
Parameter variance modifier	(0, 1)	{ <i>Marginal, Adequate, Good, Excellent</i> }
Database quality	(0, 1)	{ <i>Bad, Low, Medium, High</i> }
Database relevance	(0, 1)	{ <i>Irrelevant, Marginal, Applicable, Same</i> }
Database applicability	(0, 1)	{ <i>Doubtful, Possible, Practical, Wide</i> }
Quantity of plant-specific data	(0, 30) data points	{ <i>Few data, Limited, Proper, Sufficient</i> }
Data confidence	(0, 1)	{ <i>Bad, Average, Good, Superior</i> }
Experience level of expert	(0, 10) year	{ <i>Beginner, Intermediate, Senior, Advanced</i> }

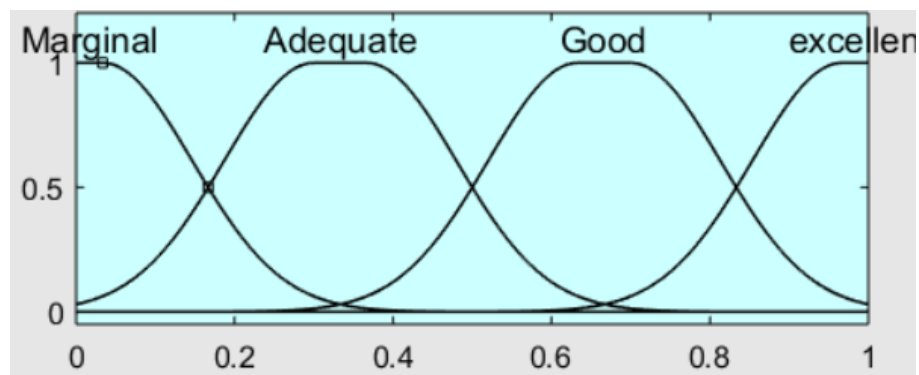

Figure 27. Parameter Variance Modifier (PVM) membership function.

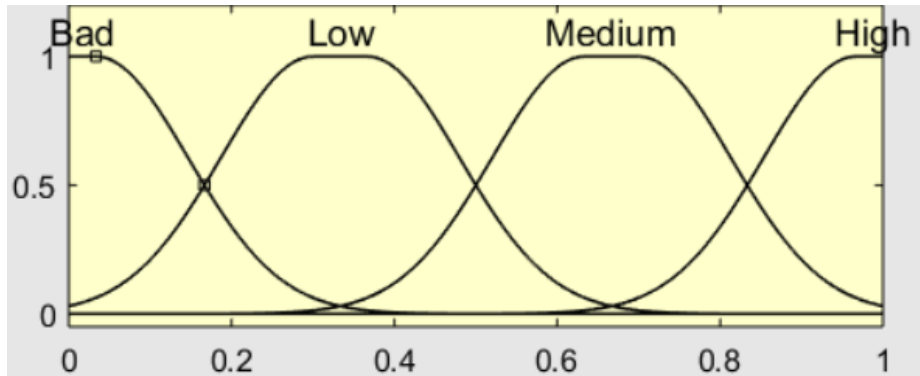

Figure 28. Database quality membership function.

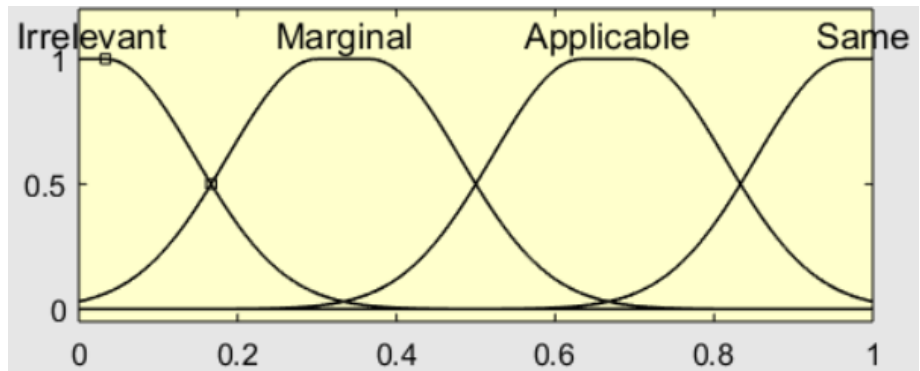

Figure 29. Database relevance membership function.

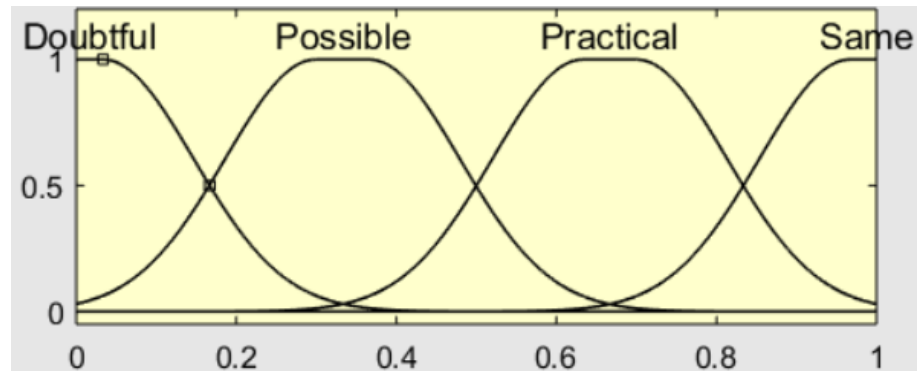

Figure 30. Database applicability membership function.

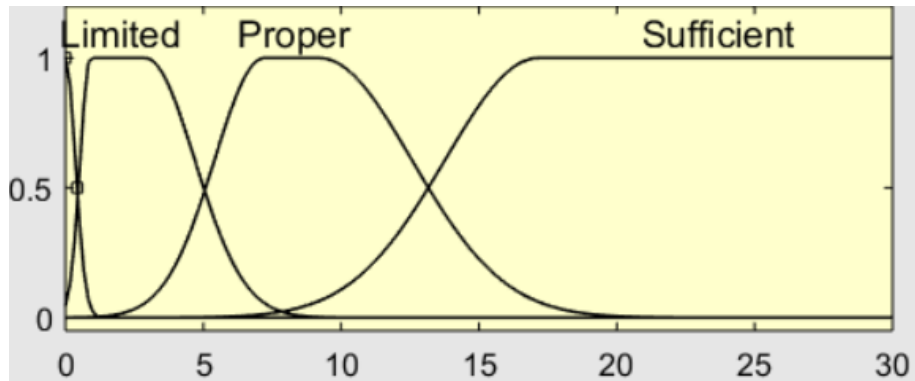

Figure 31. Quantity of plant-specific data membership function.

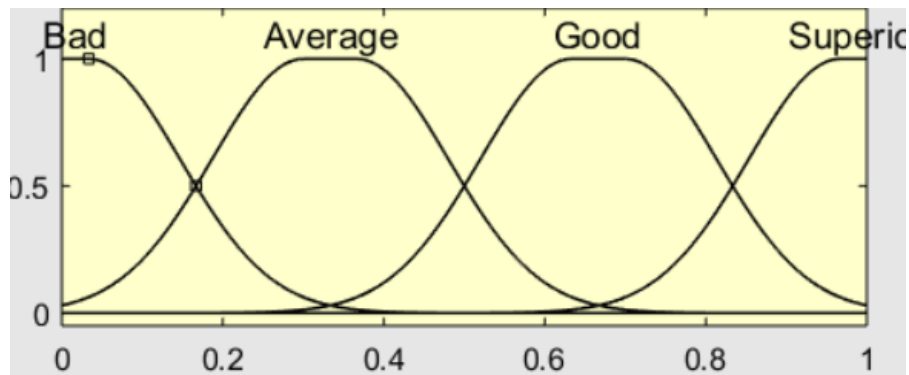

Figure 32. Data confidence membership function.

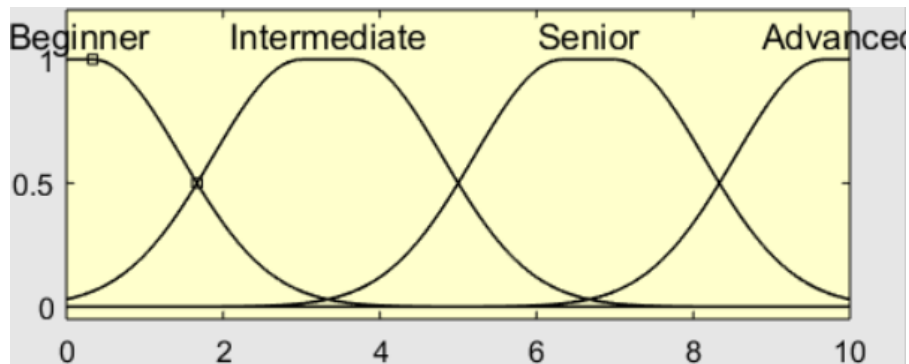

Figure 33. Experience level of expert (year of working experience).

Fuzzy rules are introduced according to the engineering and expert knowledge. Mamdani fuzzy inference is used for the fuzzy modeling. In order to keep the rules simple, only two antecedents (inputs) are used each time. Table 9 shows the fuzzy if-then rules of data relevance and database quality in determining database applicability, while Figure 34 shows the Matlab user interface for these fuzzy rules. Table 10 shows the fuzzy if-then rules of database applicability and quantity of plant-specific data in determining data confidence, while Figure 35 shows the Matlab user interface for these fuzzy rules. Table 11 shows the fuzzy if-then rules of data confidence and experience level of expert in determining PVM, while Figure 36 shows the Matlab user interface for these fuzzy rules. The following examples of rules from Table 9 are presented below:

Rule 1: IF “Database quality” = *bad* AND “Database relevance” = *irrelevant*, THEN “Database applicability”= *Doubtful*.

Rule 2: IF “Database quality” = *high* AND “Database relevance” = *marginal*, THEN “Database applicability”= *Practical*.

Table 9. Fuzzy IF-Then rules of data relevance and database quality.

Database applicability rules		Database quality			
		1	2	3	4
Database relevance		<i>Bad</i>	<i>Low</i>	<i>Medium</i>	<i>High</i>
1	<i>Irrelevant</i>	Doubtful	Doubtful	Possible	Possible
2	<i>Marginal</i>	Doubtful	Possible	Possible	Practical
3	<i>Applicable</i>	Possible	Possible	Practical	Wide
4	<i>Same</i>	Possible	Practical	Wide	Wide

1. If (Database-Relevance is Irrelevant) and (Database-Quality is Bad) then (Database-Applicability is Doughtful) (1)

2. If (Database-Relevance is Marginal) and (Database-Quality is Bad) then (Database-Applicability is Doughtful) (1)

3. If (Database-Relevance is Applicable) and (Database-Quality is Bad) then (Database-Applicability is Possible) (1)

4. If (Database-Relevance is Same) and (Database-Quality is Bad) then (Database-Applicability is Possible) (1)

5. If (Database-Relevance is Irrelevant) and (Database-Quality is Low) then (Database-Applicability is Doughtful) (1)

6. If (Database-Relevance is Marginal) and (Database-Quality is Low) then (Database-Applicability is Possible) (1)

7. If (Database-Relevance is Applicable) and (Database-Quality is Low) then (Database-Applicability is Possible) (1)

8. If (Database-Relevance is Same) and (Database-Quality is Low) then (Database-Applicability is Practical) (1)

9. If (Database-Relevance is Irrelevant) and (Database-Quality is Medium) then (Database-Applicability is Possible) (1)

10. If (Database-Relevance is Marginal) and (Database-Quality is Medium) then (Database-Applicability is Possible) (1)

11. If (Database-Relevance is Applicable) and (Database-Quality is Medium) then (Database-Applicability is Practical) (1)

12. If (Database-Relevance is Same) and (Database-Quality is Medium) then (Database-Applicability is Wide) (1)

13. If (Database-Relevance is Irrelevant) and (Database-Quality is High) then (Database-Applicability is Possible) (1)

14. If (Database-Relevance is Marginal) and (Database-Quality is High) then (Database-Applicability is Practical) (1)

15. If (Database-Relevance is Applicable) and (Database-Quality is High) then (Database-Applicability is Wide) (1)

16. If (Database-Relevance is Same) and (Database-Quality is High) then (Database-Applicability is Wide) (1)

Figure 34. Fuzzy IF-Then rules of data relevance and database quality.

Table 10. Fuzzy IF-Then rules of Data confidence.

Data confidence rules		Database applicability			
		1	2	3	4
Quantity of plant-specific data		<i>Doubtful</i>	<i>Possible</i>	<i>Practical</i>	<i>Wide</i>
1	<i>Few data</i>	Bad	Bad	Average	Good
2	<i>Limited</i>	Bad	Average	Good	Good
3	<i>Proper</i>	Average	Good	Superior	Superior
4	<i>Sufficient</i>	Superior	Superior	Superior	Superior

1. If (Plantdata-Quantity is Few) and (Database-Applicability is Doubtful) then (Data-Confidence is Bad) (1)
2. If (Plantdata-Quantity is Limited) and (Database-Applicability is Doubtful) then (Data-Confidence is Bad) (1)
3. If (Plantdata-Quantity is Proper) and (Database-Applicability is Doubtful) then (Data-Confidence is Average) (1)
4. If (Plantdata-Quantity is Sufficient) and (Database-Applicability is Doubtful) then (Data-Confidence is Superior) (1)
5. If (Plantdata-Quantity is Few) and (Database-Applicability is Possible) then (Data-Confidence is Bad) (1)
6. If (Plantdata-Quantity is Limited) and (Database-Applicability is Possible) then (Data-Confidence is Average) (1)
7. If (Plantdata-Quantity is Proper) and (Database-Applicability is Possible) then (Data-Confidence is Good) (1)
8. If (Plantdata-Quantity is Sufficient) and (Database-Applicability is Possible) then (Data-Confidence is Superior) (1)
9. If (Plantdata-Quantity is Few) and (Database-Applicability is Practical) then (Data-Confidence is Average) (1)
10. If (Plantdata-Quantity is Limited) and (Database-Applicability is Practical) then (Data-Confidence is Good) (1)
11. If (Plantdata-Quantity is Proper) and (Database-Applicability is Practical) then (Data-Confidence is Superior) (1)
12. If (Plantdata-Quantity is Sufficient) and (Database-Applicability is Practical) then (Data-Confidence is Superior) (1)
13. If (Plantdata-Quantity is Few) and (Database-Applicability is Same) then (Data-Confidence is Good) (1)
14. If (Plantdata-Quantity is Limited) and (Database-Applicability is Same) then (Data-Confidence is Good) (1)
15. If (Plantdata-Quantity is Proper) and (Database-Applicability is Same) then (Data-Confidence is Superior) (1)
16. If (Plantdata-Quantity is Sufficient) and (Database-Applicability is Same) then (Data-Confidence is Superior) (1)

Figure 35. Fuzzy IF-Then rules of Data confidence.

Table 11. Fuzzy IF-Then rules of PVM.

PVM rules		Experience level of expert			
		1	2	3	4
Data confidence		<i>Beginner</i>	<i>Intermediate</i>	<i>Senior</i>	<i>Advanced</i>
1	<i>Bad</i>	Marginal	Marginal	Adequate	Good
2	<i>Average</i>	Adequate	Adequate	Good	Excellent
3	<i>Good</i>	Good	Excellent	Excellent	Excellent
4	<i>Superior</i>	Excellent	Excellent	Excellent	Excellent

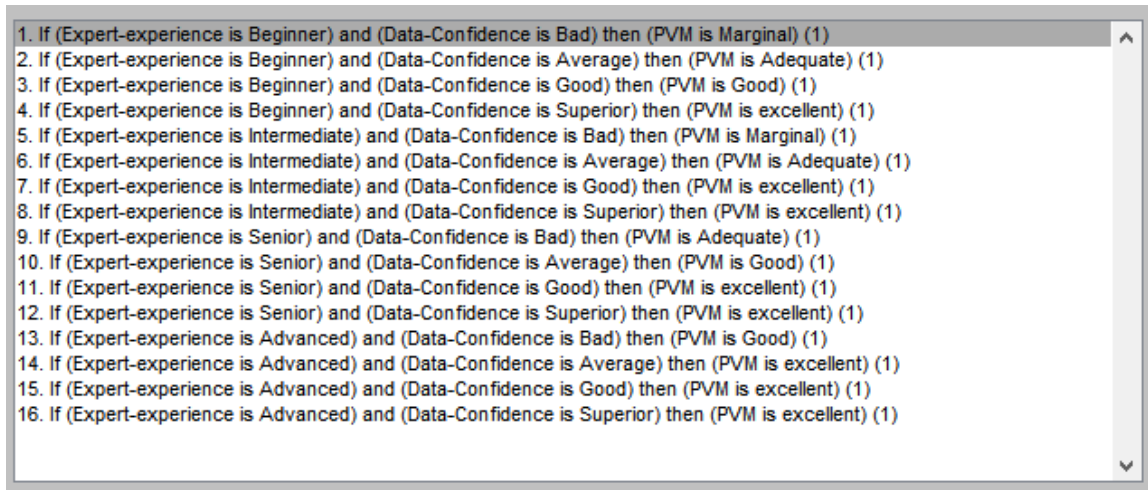

Figure 36. Fuzzy IF-Then rules of PVM.

A modified centroid approach (COA) is used for all three fuzzy models. The purpose is to make sure the maximum result of PVM is 1. The modified defuzzification process of the resulting PVM can be found in the following equation:

$$\text{Eq. (4-4)} \quad COA = \frac{\int x\mu_C(x)dx}{0.9 \int \mu_C(x)dx}$$

- $\mu_C(x)$: the resultant membership function of the output.

All the frequency of an initiating event and the PFD of IPLs are presented in distributions. The multiplication of frequency and failure rate distributions is achieved by a Monte Carlo algorithm.

The final results of the fuzzy logic modeling can be viewed through the rule-based graphics or a three-dimensional fuzzy surface. Figure 37 shows the final fuzzy surface of database applicability determined by database quality and database relevance. Figure 38 shows the final fuzzy surface of data confidence determined by quantity of plant-specific data and database applicability. Figure 39 shows the final fuzzy surface of PVM determined by data confidence and experience level of expert.

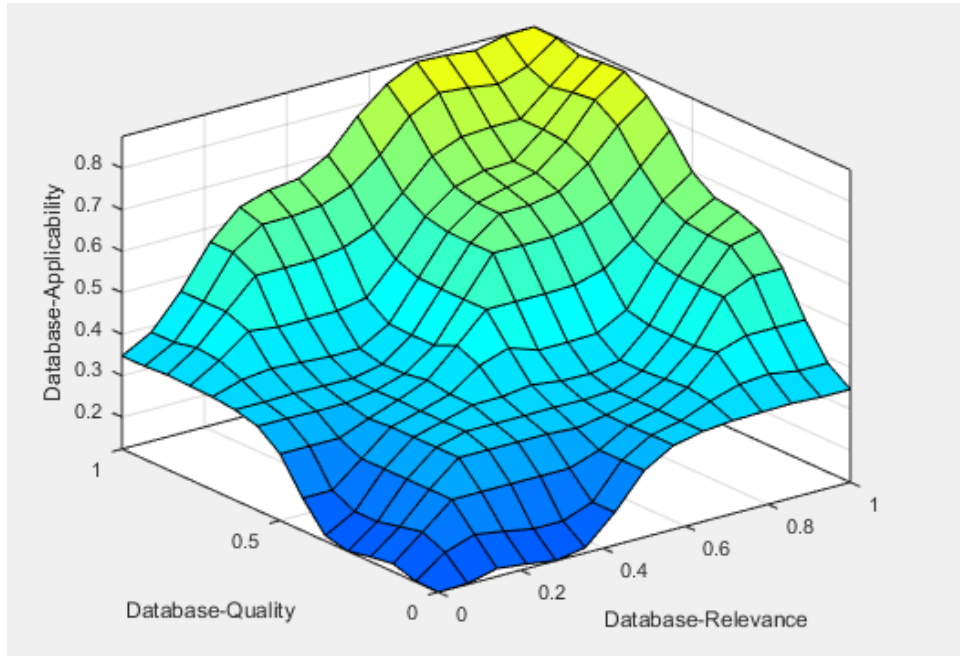

Figure 37. The resultant fuzzy surface of data applicability.

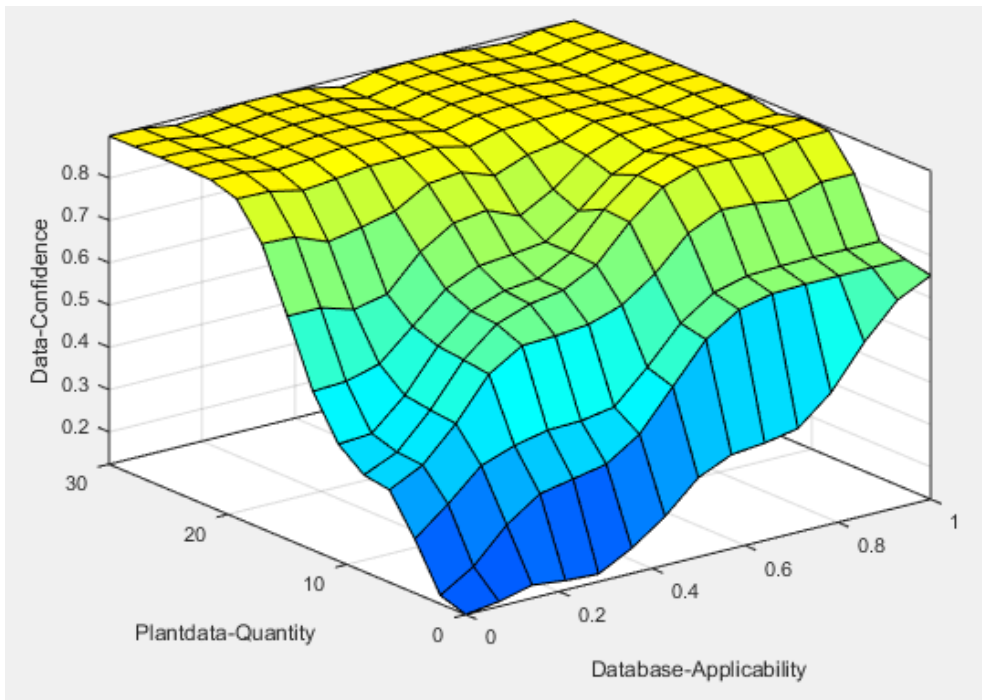

Figure 38. The resultant fuzzy surface of data confidence.

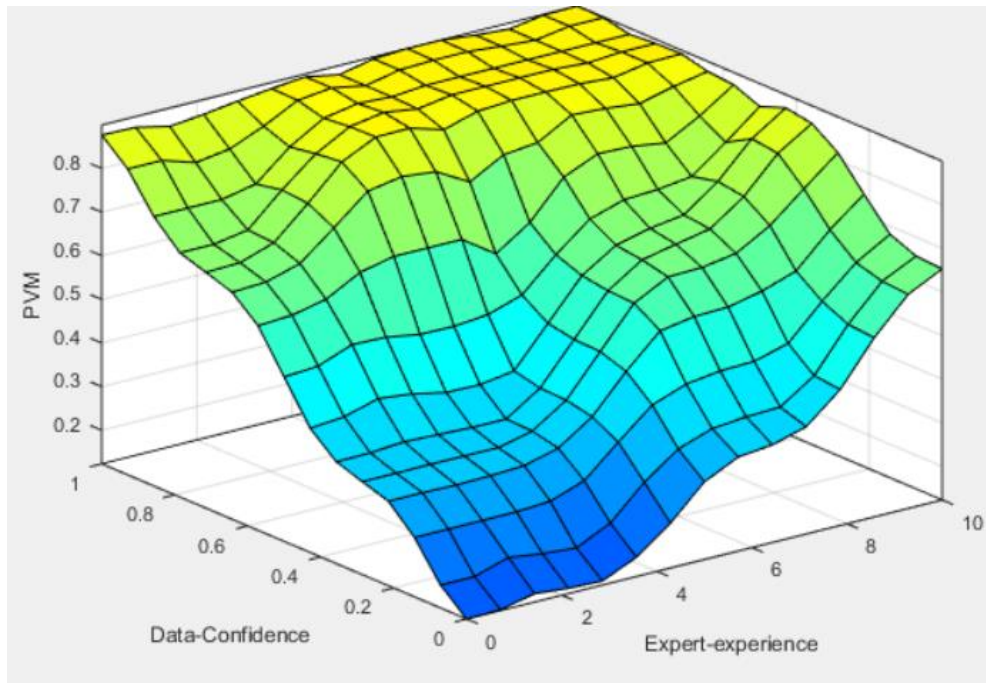

Figure 39. The resultant fuzzy surface of PVM.

4.4. Case Study

Table 12 shows some result samples of PVM modeling. In scenario 1, the database is in very high quality (database quality=1), it is from a related industry (database relevance = 0.7), there are 15 plant-specific data points, and it is assessed by a 5-year working experience expert, the PVM equals 0.99. This means the data aggregation process leads to an accurate distribution. In scenario 2, there is no plant-specific data, and a 5-year experience expert assesses the data only based a sound database (database quality = 1, database relevance =0.7). The PVM equals 0.65, which means the distribution developed by the expert is between average and good.

Table 12. Some result samples of PVM fuzzy modeling.

	Inputs				Output
Scenario	Database quality (0-1)	Database relevance (0-1)	Plant specific data (0-30 data)	Experience level of expert (0-10yr)	PVM (0-1)
1	1	0.7	15	5	0.99
2	1	0.7	0	5	0.65
3	1	0.7	6	10	1
4	1	1	0	10	0.97
5	0.8	0.6	2	5	0.80

A simplified distillation system [36] is used as a case study. As presented in Figure 40, the distillation system consists of four main units: the distillation column, reboiler system, condenser, cooling water tower, and distillate receiver system. The column has a diameter of about 2 meters, height of 15 meters, and the total contained mass of flammable n-hexane is about 40 tons (boiling point, BP = 69°C, flash point FP = -23°C). The working environment is at 120 °C and 0.39 MPa.

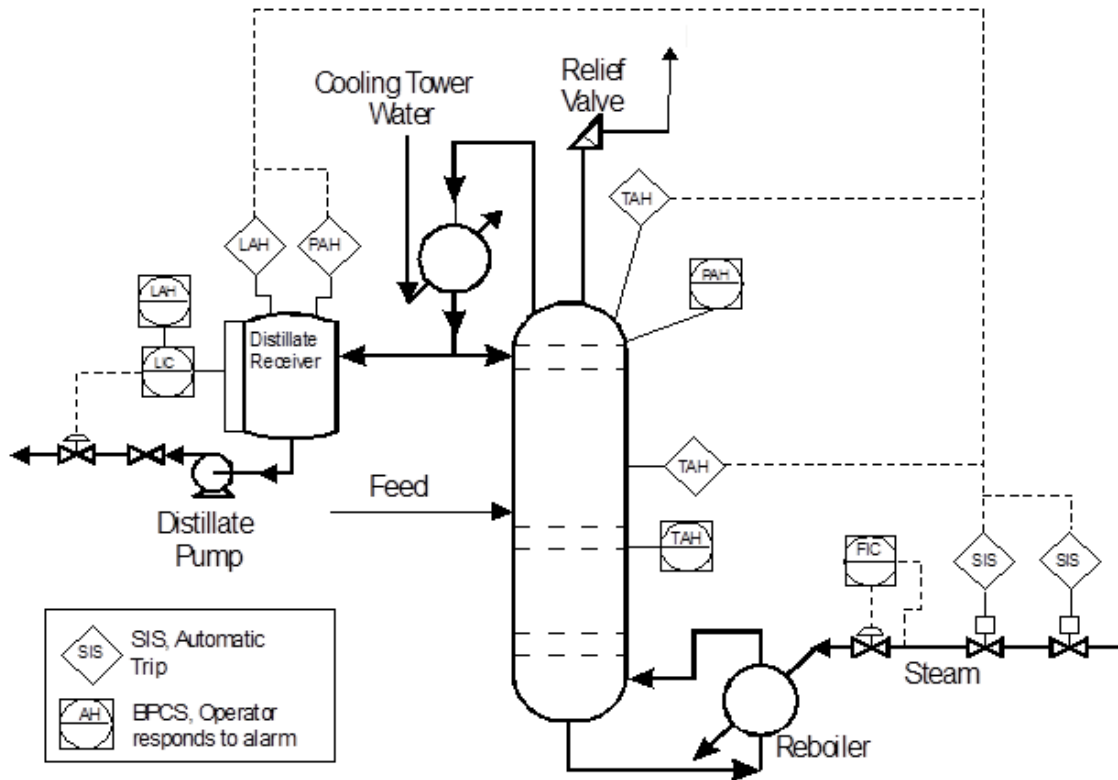

Figure 40. A simplified distillation column system [36].

The basic safety assurance principle is to keep energy balance in the column between reboiler and condenser. The distillation system was evaluated in a hazard and operability (HAZOP) study and the following initiating causes were identified:

- A. Loss of cooling tower water supply to the condenser
- B. Failure of the distillate pump
- C. Failure of the level loop control in the distillate tank (LIC) to high level
- D. Distillate manual valve left closed after shut-down
- E. Failure of the steam flow control (FIC) to high steam flow.

In this section, one cause-consequence pair (the loss of cooling water causing a release of a flammable cloud into the plant through a relief valve) is used as an example to illustrate the application of the hybrid approach.

Table 13. Frequency and probability of failure on demand (PFD) data.

Frequency [1/year]	PFD for each IPL		Frequency
Initiating event (IE)	Operator intervention (OP)	Safety instrumented system (SIS)	LOPA final frequency for a scenario /yr
Loss of cooling 10^{-1}	10^{-1}	Safety integrity level (SIL) 2	10^{-4}

As shown in Table 13, the frequency of loss of cooling water as an initiating event is 1 in 10 years, or 10^{-1} /year. The first IPL is high temperature and pressure alarms displayed on the distributed control system to alert the operator to shut off the valve. The PFD of an operator to respond to a high temperature alarm within half of the maximum allowed time of 10 minutes is 1 failure in 10 demands, or 10^{-1} [28]. The second IPL is a SIL 2 valve which will stop feeding fuel to the reboiler. The PFD for a SIL 2 instrument is $[10^{-3}, 10^{-2}]$, and 10^{-2} will be used by traditional LOPA in order to be conservative. As a result, the final frequency calculated by the traditional CCPS LOPA is 10^{-4} based on the equation (1).

The final results of the hybrid approach and traditional LOPA approach are shown in Table 14. The log-normal distributions for the initiating event and each IPL were developed considering generic databases, plant-specific data and expert experience. The PVM values were calculated separately based on the assessment of four factors, *i.e.*, *database quality, database relevance, quantity of plant-specific data, and experience level of expert*. The PVM values of 1, 0.80 and 0.65 of scenario 3, 5 and 2, respectively in Table 12 were used to illustrate the hybrid method. However, in the real situation, the PVM values for the initiating event and each IPL will be calculated separately.

Monte Carlo method was used for the distribution convolution. 10,000 numbers were randomly generated from each log-normal distribution. All the result values of the multiplication of the frequency of initiating event and the failure rates of each IPL were then presented in a histogram, as shown in Figure 41. The mean and 95 percentile values were calculated and recorded. It is concluded that a low PVM, indicating bad data and/or inexperienced knowledge, increases the standard deviation of the distributions dramatically. A risk analyst can make risk decisions based on both the mean value and the variance. For example, if the difference between the mean value and the 95 percentile value is greater than one order of magnitude, additional IPL can be applied to reduce the failure frequency of the specific scenario. In this case study, the difference between the mean and 95 percentile are less than one order of magnitude for all three scenarios.

Table 14. Log-normal distributions of frequency and probability expressed as $f(m, \sqrt{v})$.

IE or IPL	Probability density function (PDF)	Modified PDF with PVM =1	Modified PDF with PVM =0.80	Modified PDF with PVM =0.65	Traditional LOPA
IE (/yr)	$f(10^{-1}, 10^{-1})$	$f(10^{-1}, 10^{-1})$	$f(10^{-1}, 1.24 \times 10^{-1})$	$f(10^{-1}, 1.54 \times 10^{-1})$	10^{-1}
OP	$f(10^{-1}, 10^{-1})$	$f(10^{-1}, 10^{-1})$	$f(10^{-1}, 1.24 \times 10^{-1})$	$f(10^{-1}, 1.54 \times 10^{-1})$	10^{-1}
SIS	$f(5 \times 10^{-3}, 2 \times 10^{-3})$	$f(5 \times 10^{-3}, 2 \times 10^{-3})$	$f(5 \times 10^{-3}, 2.5 \times 10^{-3})$	$f(5 \times 10^{-3}, 3.1 \times 10^{-3})$	10^{-2}
Final mean	5×10^{-5}	5×10^{-5}	5×10^{-5}	5×10^{-5}	10^{-4}
95 percentiles	1.78×10^{-4}	1.78×10^{-4}	1.86×10^{-4}	1.99×10^{-4}	

Note: $f(m, \sqrt{v})$ is a lognormal probability density function, where m is the mean, v is the variance.

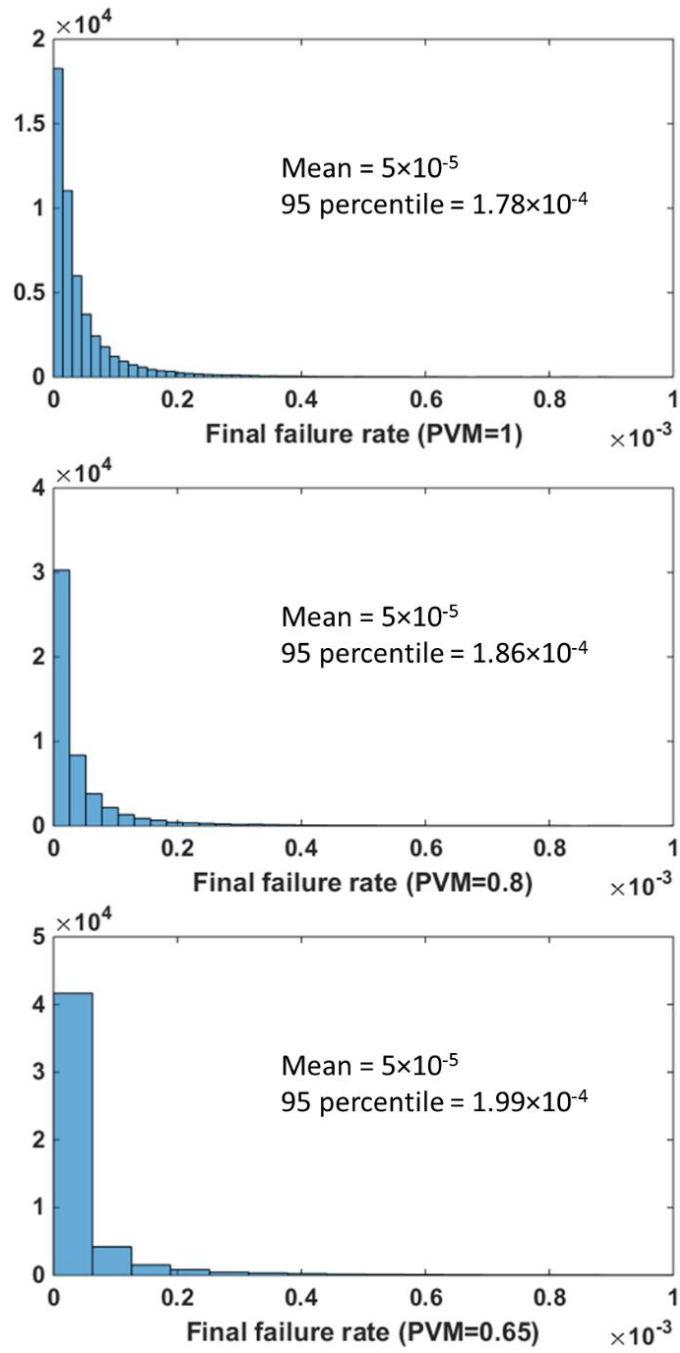

Figure 41. Final failure rates in histograms for three scenarios with parameter variance modifier (PVM) equals 1, 0.8, 0.65 respectively.

4.5. Conclusions

The hybrid approach adapts the advantages of both the probabilistic and fuzzy logic approaches. The failure rate is expressed as a distribution through the probabilistic approach, and expert knowledge is easily modeled in terms of fuzzy linguistic terms. The first benefit of the hybrid approach is that a more accurate failure rate can be achieved with the available data and expert judgment. The comparison shows that the convolution of distributions provides a lower value of scenario frequency than traditional LOPA. That is because in traditional LOPA data are selected conservatively. Moreover, uncertainty is quantified in terms of the distribution variance. Compared to a crisp value in traditional LOPA, a risk analyst can make a risk decision with more confidence. A new database reflecting a plant's processes, environments, maintenance practices, and equipment operation can be developed through this hybrid approach to facilitate a more accurate layer of protection analysis.

5. UNIVERSAL RISK MATRIX

In this section, an approach is proposed to aggregate a number of risk matrices into one universal risk matrix based on the weights. Interval type-2 fuzzy logic is adopted for the aggregation as well as to quantify the uncertainty. An example of a fuzzy universal risk matrix by aggregating three risk matrices is used to illustrate this method.

5.1. Uncertainty Sources in Risk Matrix

Risk matrices are widely used in the qualitative and semi-quantitative risk assessment and risk management. There are different types of risk matrix formats according to the function and risk acceptance criteria of the organization. Sometimes a universal or corporate-wide risk matrix format is developed in attempt to standardize risk management across the company.

Risk is interpreted as a measure of the severity and probability of occurrence of an event that causes consequences, such as human injury, environmental damage, or economic loss. As described in section 2.1, risk is defined as a function of consequence and frequency. Cox [33], and Levine [34] calculate risk as the multiplication of probability and consequence. However, in a risk matrix, the risk is defined as a mapping of categories of consequence and frequency to category of risk. The mapping is based on subject-matter experts (SME) and industrial standards.

A risk matrix uses discrete categories of risk, consequence, and frequency. It is a semi-quantitative way to represent risk, *i.e.*, there are uncertainty in the risk statement [36]. One disadvantage of a risk matrix is that it provides limited resolution of risk due to that fact that the risk is described in discrete categories. Limited resolution may lead to many combinations of frequency and consequence leading to the same risk category, thus the risk from different scenarios could not be prioritized.

In a risk matrix, the risk is defined as a mapping of categories of consequence and frequency to category of risk. The mapping is based on subject-matter experts (SME) and industrial standards. Some subjective bias can be encountered when a group of experts are doing risk assessment using the risk matrix [36]. Markowski [11] states that “the overall risk category (risk score) obtained in a traditional approach by categorization of frequency and severity of the consequence is quite imprecise and vague which produces the significant uncertainties concerning the risk category”.

In some situations, different risk matrices need to be combined to develop a new and universal risk matrix. Due to the fact that the development of each risk matrix involves interpretation, there are intra-personal and inter-personal uncertainties in the process. Intra-personal uncertainty refers to the uncertainty with which a person interprets a concept. Inter-personal uncertainty means the different understanding to a same concept of various people.

5.2. Literature Review and Gap Identification

Markowski and Mannan developed a fuzzy risk matrix using type-1 fuzzy logic modeling [11]. The first step is the fuzzification of frequency, consequence, and risk. Then all the information in the risk matrix is used as fuzzy rules for a Mamdani fuzzy inference system. Three risk matrices (low cost, standard and high cost) are transferred into three fuzzy risk matrices. Figure 42 shows the traditional risk matrix and its fuzzy risk matrix. This method has been applied to a case study, and the results show that the final risk as indicated at a fuzzy risk matrix is more reliable and precise.

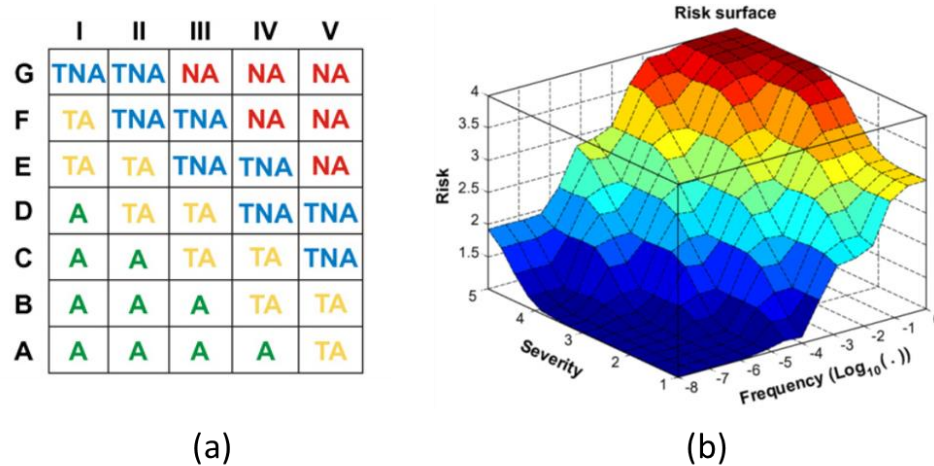

Figure 42. Standard risk matrix and its fuzzy risk matrix [11].

As described in Section 5.1, there are certain limitations of a traditional risk matrix, including poor resolutions, ambiguous input and output, *etc.* The new method focuses on increasing the precision of a risk matrix by quantifying the uncertainty. Interval type-2

fuzzy logic is used for the development of fuzzy risk matrix. The fuzzy risk developed by Markowski and Mannan is based on type-1 fuzzy logic modeling [11]. Type-1 fuzzy sets can be treated as a first-order approximation to the uncertainty in the real life, and type-2 fuzzy sets is a second-order approximation. Thus type-2 fuzzy logic works better in analyzing intra-personal and inter-personal uncertainties.

The development of a single risk matrix involves expert interpretation. There are more intra-personal and inter-personal uncertainties when a group of experts are aggregating several risk matrices into a single universal risk matrix. The new method provides an efficient way to aggregate several risk matrices and quantify the uncertainty. The final fuzzy risk matrix is in high resolution.

5.3. Relevant Methods

Two relevant methods, interval approach and linguistic weighted average, are introduced here. The interval approach (IA) is used to convert survey data into fuzzy sets. The linguistic weighted average is a unique type of weighted average with its sub-criteria or weight modeled as an interval type-2 fuzzy set.

5.3.1. *Interval Approach (IA)*

The interval approach (IA) is used to develop a type-2 fuzzy set for a linguistic term from a survey to experts [56]. It consists of two parts: collect data from experts and

develop interval type-2 fuzzy sets, as shown in Figure 43. In the data collection part, for each linguistic term, a group of n Subject Matter Experts will be asked the following question:

Use an interval to describe a term: on a scale of __, what are the endpoints of the interval that you think best describe the word__?

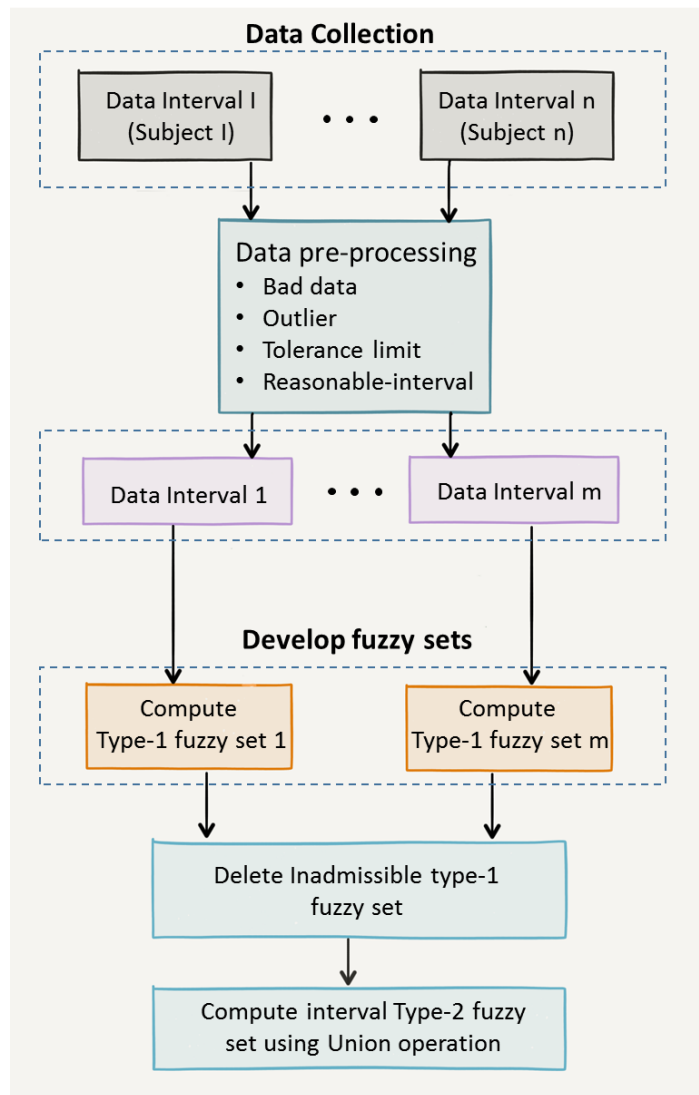

Figure 43. The flow diagram of Interval Approach.

For example, assume there are 8 linguistic terms for frequency, including Remote (A), Unlikely (B), Very Low (C), Low (D), Medium (E), High (F), very High (G). The scale of frequency is $[10^{-8}, 1]$. If we want to get the data for the High (F) frequency, the following questions will be asked to n experts:

On a scale of $[10^{-8}, 1]$, what are the endpoints of the interval that you think best describe the words High frequency (F)?

Experts can also draw the interval from a scale that they think best fit the linguistic term. Figure 44 shows an example of data interval in the scale of the frequency. It is absolutely acceptable that there are overlaps between the intervals of different linguistic terms. Table 15 shows the results of the survey from 4 experts.

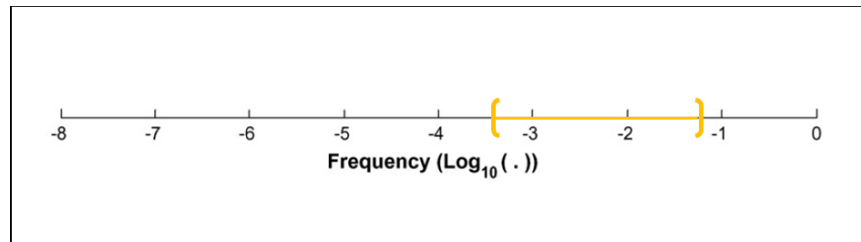

Figure 44. The scale of frequency and an example of data interval.

Table 15. The evaluation results for Risk Matrix I – Frequency B from 4 experts.

Expert	Range, in Log ₁₀ (.)	
1	-3.0	-1.0
2	-2.5	-1.0
3	-2.5	-1.5
4	-3.0	-1.5

After the survey, for each linguistic term, there will be n data intervals $[a^{(i)}, b^{(i)}]$. These data will go through four processes to get m data intervals $[a^{(i)}, b^{(i)}]$ to get rid of some outliers and bad data. Finally, a uniform distribution is assigned to each of the remaining m intervals $[a^{(i)}, b^{(i)}]$. Its mean and standard deviation are computed as follows:

$$\text{Eq. (3-46)} \quad m^{(i)} = \frac{a^{(i)} + b^{(i)}}{2}$$

$$\text{Eq. (3-47)} \quad \sigma^{(i)} = \frac{b^{(i)} - a^{(i)}}{\sqrt{12}}$$

The next step is to map each qualified data interval into a type-1 fuzzy set. Table 16 shows the transformation equations of the uniform distribution of data interval into a type-1 fuzzy set. There are three types of membership function, *i.e.*, left-shoulder membership function, right shoulder membership function, and symmetric triangle membership function. The smallest linguistic term is transformed into left shoulder membership function, the largest linguistic term is transformed into right shoulder membership function, and all the other linguistic terms is transformed into symmetric triangle membership function. In the frequency example, Remote (A) is described in a left

shoulder membership function, very High (G) is described in a right shoulder membership function, and the rest are described in symmetric triangle membership function. The logic is that mean and variance of the uniform distribution of data interval are the same with those of the type-1 fuzzy membership function.

Table 16. Transformation equations of the uniform distribution of data interval into the type-1 fuzzy set [56].

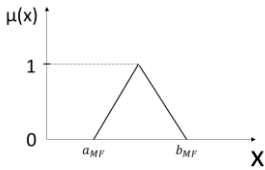
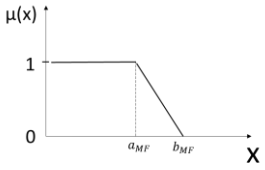
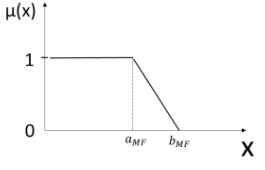
Membership function	m_{MF} and σ_{MF}	Transformation
Symmetric triangle (Interior MF) 	$m_{MF} = \frac{a_{MF} + b_{MF}}{2}$ $\sigma_{MF} = \frac{b_{MF} - a_{MF}}{2\sqrt{6}}$	$a_{MF} = \frac{a+b}{2} - \frac{b-a}{\sqrt{2}}$ $b_{MF} = \frac{a+b}{2} + \frac{b-a}{\sqrt{2}}$
Left shoulder 	$m_{MF} = \frac{2a_{MF} + b_{MF}}{3}$ $\sigma_{MF} = \frac{b_{MF} - a_{MF}}{3\sqrt{2}}$	$a_{MF} = \frac{a+b}{2} - \frac{b-a}{\sqrt{6}}$ $b_{MF} = \frac{a+b}{2} + \frac{\sqrt{6}(b-a)}{3}$
Right shoulder 	$m_{MF} = \frac{a_{MF} + 2b_{MF}}{3}$ $\sigma_{MF} = \frac{b_{MF} - a_{MF}}{3\sqrt{2}}$	$a_{MF} = \frac{a+b}{2} - \frac{\sqrt{6}(b-a)}{3}$ $b_{MF} = \frac{a+b}{2} + \frac{b-a}{\sqrt{6}}$

The last step is to compute an interval type-2 fuzzy set using union operation of all the type-1 fuzzy sets obtained in the previous step. The resultant interval type-2 fuzzy set will cover all the type-1 fuzzy sets. As an example, Figure 45 shows the final resultant interval type-2 fuzzy set for High Frequency (F) as a union of all the type-1 fuzzy sets obtained from 4 experts.

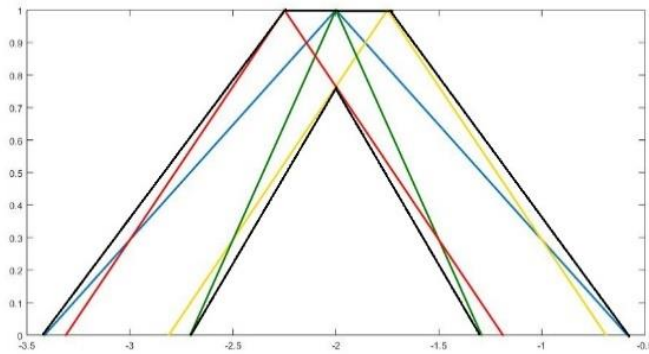

Figure 45. The resultant interval type-2 fuzzy set of Risk Matrix I – Frequency B.

5.3.2. Linguistic Weighted Average (LWA)

The weighted average is the most widely used form of aggregation. The most well-known formula for weighted average is the following function:

$$\text{Eq. (5-1)} \quad y = \frac{\sum_{i=1}^n x_i w_i}{\sum_{i=1}^n w_i}$$

- w_i : the weights;
- x_i : the sub-criteria.

In many situations, the crisp numbers for either the sub-criteria or the weights is not enough to describe complex problem. It is important that the sub-criteria and weights are intervals, type-1 fuzzy sets, and type-2 fuzzy sets.

Fuzzy weighted average (FWA) is a type of weighted average when at least one sub-criteria or weight is modeled as type-1 fuzzy set [57]. Fuzzy weighted average can be described through the following equation:

$$\text{Eq. (5-2)} \quad Y_{LWA} \equiv \frac{\sum_{i=1}^n X_i W_i}{\sum_{i=1}^n W_i}$$

- X_i : the sub-criteria. It is a type-1 fuzzy set.
- W_i : the weights. It is a type-1 fuzzy set.
- Y_{LWA} : the results of fuzzy weighted average. It is a type-1 fuzzy set.

α -cut is used to compute the FWA. All the fuzzy sets of sub-criteria, X, and weights, W, are discretized into m α -cuts, $\alpha_1, \alpha_2, \dots, \alpha_m$. According to the definition of α -cut given in Section 3.2.3, the corresponding intervals for x_i in X_i and w_i in W_i are found for each α_j are described in Eq. (5-3) and Eq. (5-4).

$$\text{Eq. (5-3)} \quad x_i \in [a_i(\alpha_j), b_i(\alpha_j)]$$

$$\text{Eq. (5-4)} \quad w_i \in [c_i(\alpha_j), d(\alpha_j)]$$

For a particular α -cut, α_j , the outcome of the FWA algorithm, $Y_{LWA}(\alpha_j)$, can be described through Eq. (5-5,6,7).

$$\text{Eq. (5-5)} \quad Y_{FWA}(\alpha_j) = \frac{\sum_{i=1}^n X_i(\alpha_j) W_i(\alpha_j)}{\sum_{i=1}^n W_i(\alpha_j)} = [f_L(\alpha_j), f_R(\alpha_j)]$$

$$\text{Eq. (5-6)} \quad f_L(\alpha_j) = \min_{\forall w_i \in [c_i(\alpha_j), d(\alpha_j)]} \frac{\sum_{i=1}^n X_i(\alpha_j) W_i(\alpha_j)}{\sum_{i=1}^n W_i(\alpha_j)}$$

$$\text{Eq. (5-7)} \quad f_R(\alpha_j) = \max_{\forall w_i \in [c_i(\alpha_j), d(\alpha_j)]} \frac{\sum_{i=1}^n X_i(\alpha_j) W_i(\alpha_j)}{\sum_{i=1}^n W_i(\alpha_j)}$$

KM Algorithm [48] can be used to calculate $f_L(\alpha_j)$ and $f_R(\alpha_j)$. When the intervals $[f_L(\alpha_j), f_R(\alpha_j)]$ of all m α -cuts are found, the membership function of Y_{LWA} , $\mu_{Y_{LWA}}(y)$, is computed as:

$$\text{Eq. (5-8)} \quad \mu_{Y_{FWA}}(y) = \sup_{\forall \alpha_j} \alpha_j I_{F_{LWA}}(y)$$

- $I_{Y_{LWA}}(y)$: the indicator function of $Y_{LWA}(\alpha_j)$, see Eq. (3-16)

Linguistic weighted average is a type of weighted average when at least one sub-criteria or weight is modeled as an interval type-2 fuzzy set [38]. Linguistic weighted average can be described through the following equation:

$$\text{Eq. (5-9)} \quad \tilde{Y}_{LWA} = \frac{\sum_{i=1}^n \tilde{X}_i \tilde{W}_i}{\sum_{i=1}^n \tilde{W}_i}$$

- \tilde{X}_i : the sub-criteria. It is an interval type-2 fuzzy set.
- \tilde{W}_i : the weights. It is an interval type-2 fuzzy set.
- \tilde{Y}_{LWA} : the results of linguistic weighted average. It is an interval type-2 fuzzy set.

According to the definition of interval type-2 fuzzy set, all the interval type-2 fuzzy set can be defined by its FOU. The following three equations are the representation of \tilde{Y}_{LWA} , \tilde{X}_i and \tilde{W}_i though their FOU.

$$\text{Eq. (5-10)} \quad \tilde{Y}_{LWA} = 1/FOU(\tilde{Y}_{LWA}) \equiv 1/[\underline{Y}_{LWA}, \bar{Y}_{LWA}]$$

$$\text{Eq. (5-11)} \quad \tilde{X}_i = 1/FOU(\tilde{X}_i) = 1/[\underline{X}_i, \bar{X}_i] = 1/\bigcup_{j_i=1}^{n_{X_i}} A_{e_i}^{j_i}$$

$$\text{Eq. (5-12)} \quad \tilde{W}_i = 1/FOU(\tilde{W}_i) = 1/[\underline{W}_i, \bar{W}_i] = 1/\bigcup_{k_i=1}^{n_{W_i}} W_{e_i}^{k_i}$$

Then the lower membership function, \underline{Y}_{LWA} , and upper membership function, \bar{Y}_{LWA} , can be calculated through the Eq. (5-13) and Eq. (5-14). An α -cut based approach [38] is used for the calculation.

$$\text{Eq. (5-13)} \quad \underline{Y}_{LWA} = \min_{\forall W_i \in [\underline{W}_i, \bar{W}_i]} \frac{\sum_{i=1}^n \underline{X}_i W_i}{\sum_{i=1}^n W_i}$$

$$\text{Eq. (5-14)} \quad \bar{Y}_{LWA} = \min_{\forall W_i \in [\underline{W}_i, \bar{W}_i]} \frac{\sum_{i=1}^n \bar{X}_i W_i}{\sum_{i=1}^n W_i}$$

5.4. Universal Risk Matrix Method

Figure 46 shows the flow of developing a universal risk matrix based on several risk matrices.

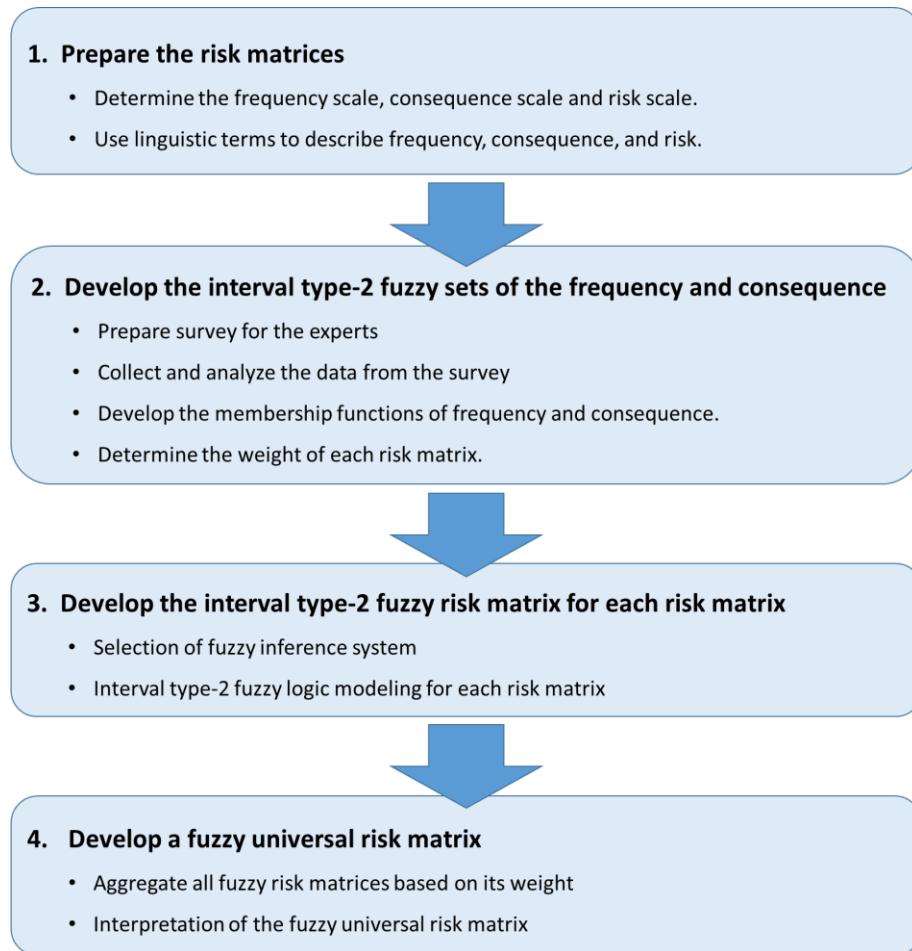

Figure 46. The flow to develop a fuzzy universal risk matrix.

Step 1: Prepare the risk matrices. There are different types of risk matrices, or risk from different sources that need to be combined into one risk matrices. Figure 47 shows an example of a risk matrix. The vertical side is the Frequency, and the horizontal side is the Consequence. As explained in Table 17, the categories of each risk matrix elements (frequency, consequence, and risk) are described in linguistic terms. Risk is divided into 4 categories, *i.e.*, Not acceptable (NA), Tolerable not acceptable (TNA), tolerable (TA), acceptable (A); frequency is divided into 7 categories, *i.e.*, Remote (A), Unlikely (B), Very

Low (C), Low (D), Medium (E), High (F), very High (G); consequence is divided into 5 categories, *i.e.*, Negligible (I), Low (II), Moderate (III), High (IV), Catastrophic (V). For each risk matrix elements, the total scales are defined either in numerical way or in descriptive methods.

		Consequence				
		I	II	III	IV	V
Frequency	G	TNA	NA	NA	NA	NA
	F	TNA	TNA	NA	NA	NA
	E	TA	TNA	TNA	NA	NA
	D	TA	TA	TNA	TNA	NA
	C	A	TA	TA	TNA	TNA
	B	A	A	TA	TA	TNA
	A	A	A	A	TA	TA

Figure 47. Risk matrix example I.

Table 17. Detail information of risk matrix example I.

Risk matrix elements	Scales	Categories
Frequency	$[10^{-8}, 1]$	{Remote (A), Unlikely (B), Very Low (C), Low (D), Medium (E), High (F), very High (G)}
Consequence	[1-5]	{Negligible (I), Low (II), Moderate (III), High (IV), Catastrophic (V)}
Risk	[1-4]	{Not acceptable (NA), Tolerable not acceptable (TNA), tolerable (TA), acceptable (A)}

Step 2: Determine the interval type-2 fuzzy set based on survey. All the linguistic terms, as well as the weight of each risk matrix, are represented into interval type-2 fuzzy sets using the Interval Approach, which is described in section 5.3.1. Figure 48 shows an example of frequency of risk matrix I represented in interval type-2 fuzzy set.

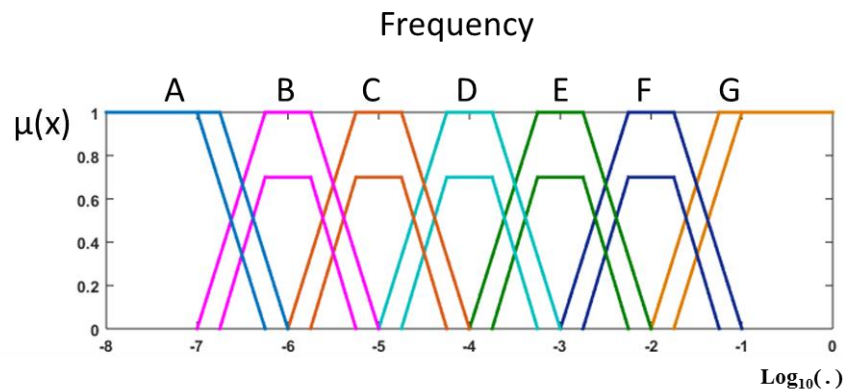

Figure 48. Frequency of risk matrix I in fuzzy sets.

Step 3: Develop an Interval type-2 fuzzy risk matrix for each risk matrix. Once the interval type-2 fuzzy sets for all the linguistic terms are developed. Type-2 fuzzy logic modeling, described in Section 3.3.5, is conducted to transfer each risk matrix into a fuzzy risk surface. The inputs of the type-2 fuzzy model are frequency and consequence, and the output is risk. For the ease of the model, Sugeno fuzzy inference system is used.

Step 4: Develop the universal risk matrix by aggregating all the interval type-2 fuzzy risk matrices. With all the fuzzy risk matrices been developed, the final universal risk matrix is then obtained by aggregating they fuzzy risk matrices based on the weights. Linguistic weighted average, described in Section 5.3.2, is used for this step.

5.5. Case Study

A case study of developing a universal risk matrix by aggregating three risk matrices is given in this section. Figure 49 shows these three risk matrices. The vertical side is the Frequency, and the horizontal side is the Consequence.

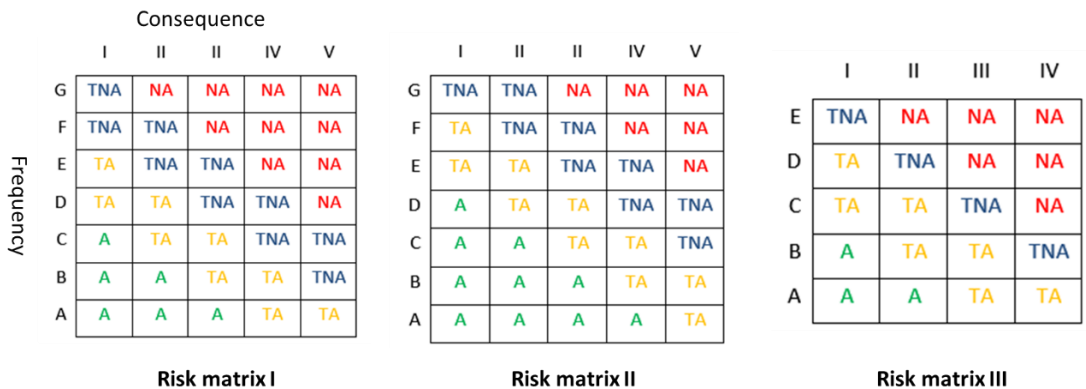

Figure 49. Three risk matrices.

With a scale for frequency, consequence, and risk separately, experts are asked to evaluate an interval for each linguistic terms. Here, the linguistic terms are the categories for frequency, consequence and risk. A group of n Subject Matter Experts will be asked the following question:

Use an interval to describe a term: on a scale of __, what are the endpoints of the interval that you think best describe the word__?

Using the Interval Approach, all the linguistic terms of frequency and consequence can be represented by interval type-2 fuzzy sets. A resultant risk matrix can be developed through type-2 fuzzy logic modeling. Sugeno fuzzy inference is used for the modeling. Figure 50 shows the resultant fuzzy risk matrix for risk matrix I, Figure 51 shows the resultant risk matrix for risk matrix II, and Figure 52 shows the resultant risk matrix for risk matrix III.

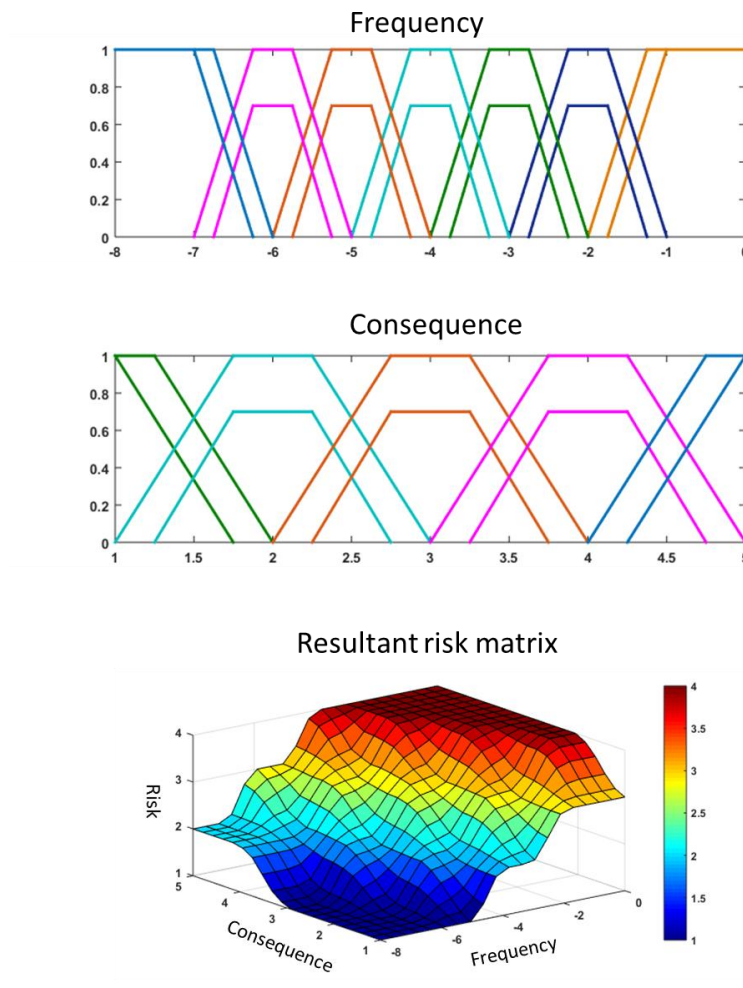

Figure 50. Type-2 fuzzy modeling and resultant risk matrix for risk matrix I.

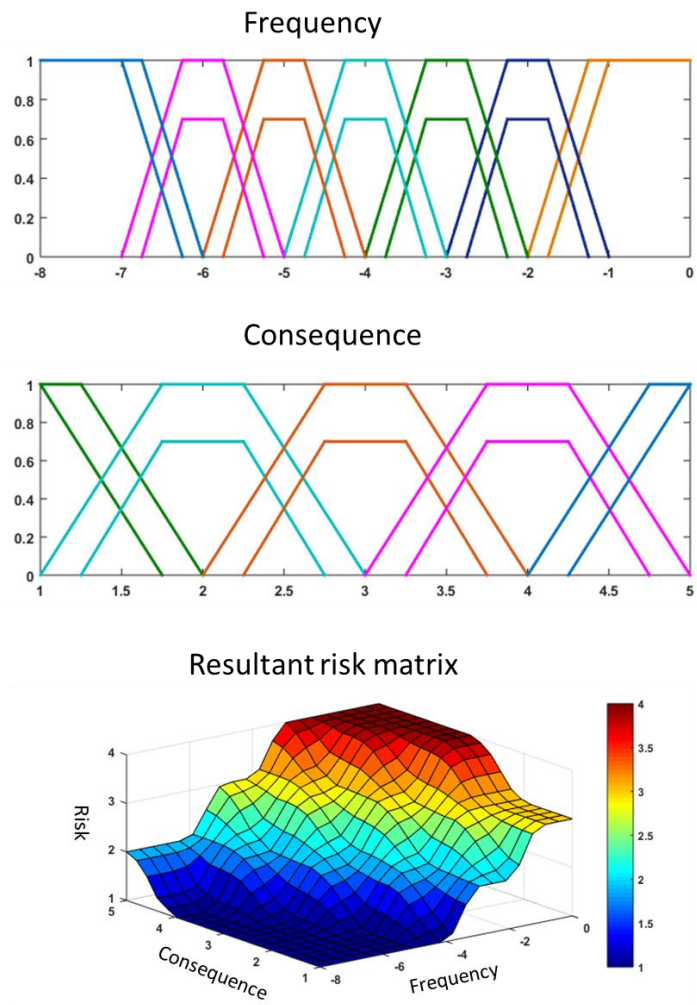

Figure 51. Type-2 fuzzy modeling and resultant risk matrix for risk matrix II.

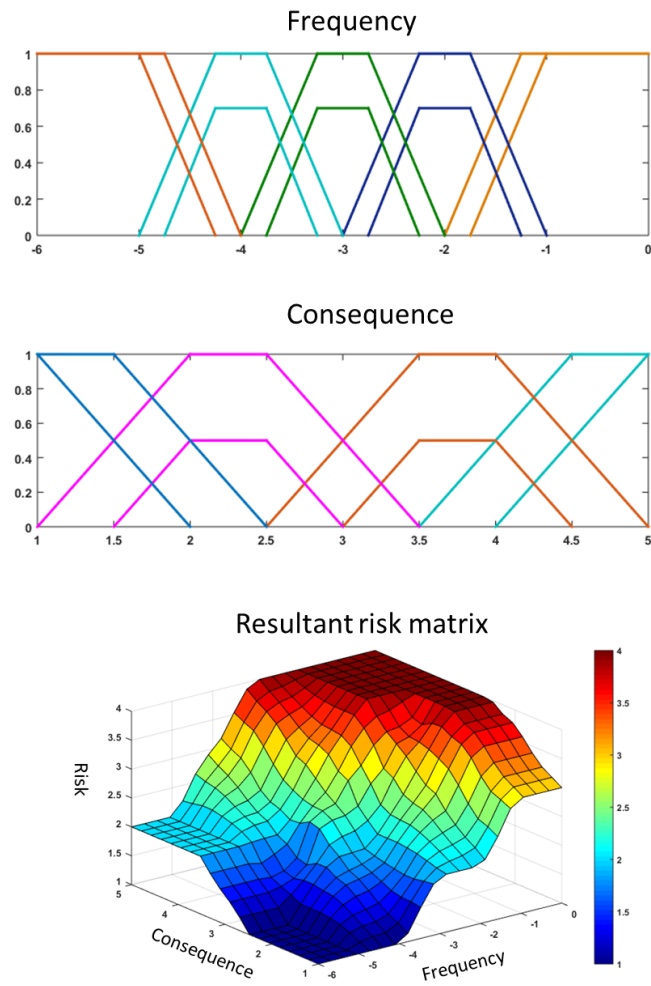

Figure 52. Type-2 fuzzy modeling and resultant risk matrix for risk matrix III.

The weight of these three risk matrices were also accessed by the expert using the Interval Approach. Assume the final weight of these three risk matrices are shown in Figure 53. The weight is also an interval type-2 fuzzy set.

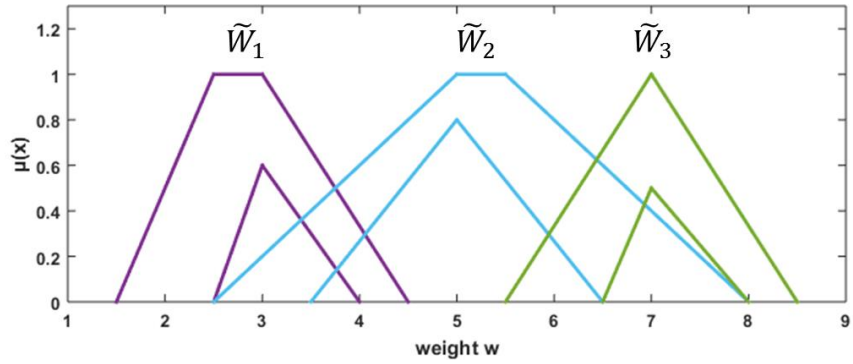

Figure 53. The weight of three risk matrices.

With three fuzzy risk matrices and their weights, a universal risk matrix is developed using the Fuzzy Weighted Average approach. Figure 54 shows the final universal risk matrix.

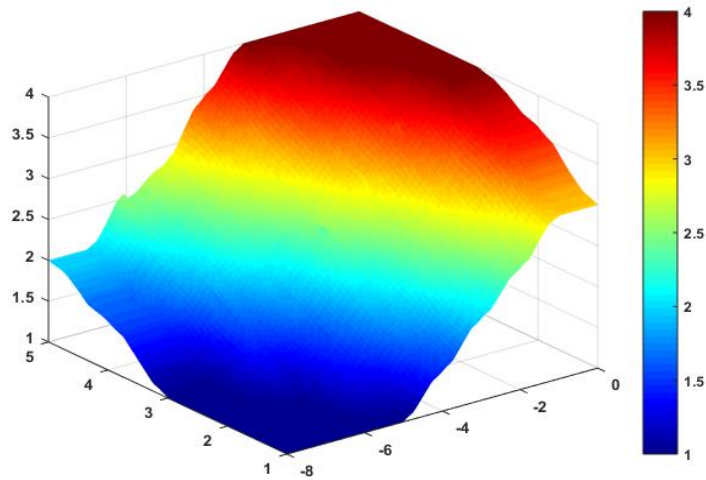

Figure 54. The universal fuzzy risk matrix by aggregating three example risk matrices.

5.6. Conclusions

- 1) Risk matrix is widely used in semi-quantitative risk assessment, and the development of a single risk matrix involves expert interpretation. There are significant uncertainties in traditional risk matrix, including poor resolutions, ambiguous input and output.
- 2) Through fuzzy logic, the uncertainty from expert knowledge can easily be modeled. The method proposed in this section is based on interval type-2 fuzzy logic. The new method proposed in this section focuses on increasing the precision of the risk matrix by quantifying the uncertainty. Type-2 fuzzy logic works better in analyzing intra-personal and inter-personal uncertainties.
- 3) Sometimes a universal or corporate-wide risk matrix is developed in attempt to standardize risk management across the company. The new method provides an efficient way to aggregate several risk matrices into one universal risk matrix. The resultant fuzzy risk matrix provides a high resolution.

6. CONCLUSIONS AND FUTURE WORK

This section summarizes the main findings of the work presented in this dissertation and it outlines the opportunities to continue this work.

6.1. Conclusions

Layer of protection analysis (LOPA) is a widely used semi-quantitative risk assessment method. It provides a simplified and less precise method to assess the effectiveness of protection layers and the residual risk of an incident scenario. The outcome failure frequency and consequence of that residual risk are intended to be conservative by prudently selecting input data, given that design specification and component manufacturer's data are often overly optimistic. There are many influences, including design deficiencies, lack of layer independence, availability, human factors, wear by testing and maintenance shortcomings, which are not quantified and are dependent on type of process and location. This makes the risk in a conservative approach usually overestimated. Therefore, to make decisions for a cost-effective protective system, different sources and types of uncertainty in the LOPA model need to be identified and quantified.

There are different approaches to deal with uncertainty in engineering problems including statistics [58], fuzzy logic [59], sensitivity analysis, and expert method [60]. In

this study, fuzzy logic along with statistics is used for the uncertainty quantification in LOPA.

As is known, risk is interpreted as a measure of the severity and probability of occurrence of an event. Besides the inherent uncertainty of risk, there is the possible spread in the derived values of both probability and consequence as a secondary source of uncertainty. A probabilistic and fuzzy logic hybrid approach is developed to deal with the uncertainty in frequency. An interval type-2 fuzzy logic based approach is developed to quantify the uncertainty in risk, and it also provides an efficient way to combine several risk matrices into one universal risk matrix.

6.1.1. Uncertainty in the Frequency

The hybrid approach (described in Section 4) adapts the advantages of both probabilistic and fuzzy logic approaches in quantifying the uncertainty in the frequency part of LOPA, including the frequency of initiating event, and probability of failure on demand (PFD) of independent protection layers (IPLs). A case study of the hybrid approach shows that a more accurate failure rate can be achieved with the available data and expert judgment. Uncertainty is quantified in terms of the distribution variance. Compared to a crisp value in traditional LOPA, a risk analyst can make a risk decision with more confidence. As shown in Figure 55, this method takes advantage of all available sources, *i.e.*, generic database, plant-specific data, and expert judgment. In this probabilistic and fuzzy logic hybrid approach, when there are more data (generic database

and/or plant-specific data) the probability part will be dominating, and when there are less and expert judgment is used the fuzzy logic part will be dominating. It focuses on developing a new database reflecting a plant's processes, environments, maintenance practices, and equipment operation to facilitate a more accurate layer of protection analysis.

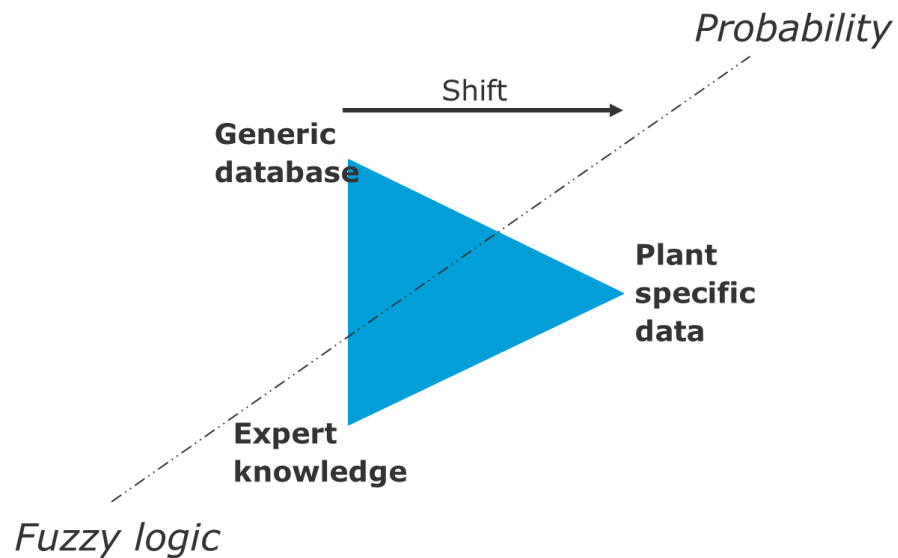

Figure 55. Overview of the fuzzy and probabilistic hybrid approach.

6.1.2. Uncertainty in the Risk

Risk matrix is widely used in LOPA. There are significant uncertainties in traditional risk matrix, including poor resolutions, ambiguous input and output, *etc.* A type-2 fuzzy logic fuzzy risk matrix (described Section 5) is developed to increase the precision of the risk matrix. Compared with type-1 fuzzy logic, a higher degree of

approximation can be achieved in modeling real world problems. The establishment of interval type-2 fuzzy sets is based on survey to multiple experts.

Sometimes a universal or corporate-wide risk matrix is developed in attempt to standardize risk management across the company. The new method provides an efficient way to aggregate several risk matrices into one universal risk matrix. Linguistic weighted average (described in Section 3.3.7) is in this method, and the aggregation is based on the weight of each risk matrix. The resultant fuzzy risk matrix provides a high resolution.

6.2. Future Work

Risk is interpreted as a measure of the severity and probability of occurrence of an event that causes consequences, and the uncertainty in risk and frequency are studied in this dissertation. The future work should focus on quantifying the uncertainty in consequence. There are many consequence indices, such as Dow F&EI, Edwards and Lawrence index, Heikkila and Hurme index, Khan and Amyotte index. For most indices, aggregations of different types of hazards (*e.g.*, flammability, toxicity, explosion hazards, *etc.*) are based on a simple weighting sum method. There are different types of uncertainty in these indices to take into account.

REFERENCES

1. Chemical Safety Board (CSB), *Investigation report: refinery explosion and fire*. 2007, U.S. Chemical Safety Board.
2. Health and Safety Executive (HSE), *Safety and environmental standards for fuel storage sites: Buncefield Standards Task Group (BSTG) Final report*. 2007, Health and Safety Executive.
3. Chemical Safety Board (CSB), *Investigation report: Formosa Plastics Vinyl Chloride Explosion*. 2007, U.S. Chemical Safety Board.
4. Markowski, A.S., M.S. Mannan, and D. Siuta, *Uncertainty aspects in process safety analysis*. Journal of Loss Prevention in the Process Industries, 2010. **23**(3): p. 446-454.
5. Ouazraoui, N., R. Nait-Said, M. Bourareche, and I. Sellami, *Layers of protection analysis in the framework of possibility theory*. Journal of Hazardous Materials, 2013. **262**: p. 168-178.
6. Zadeh, L.A., *Fuzzy sets*. Information and Control, 1965. **8**(3): p. 338-353.
7. Kenarangui, R., *Event-tree analysis by fuzzy probability*. IEEE Transactions on Reliability, 1991. **40**(1): p. 120-124.
8. Kim, C.E., Y.J. Ju, and M. Gens, *Multilevel fault tree analysis using fuzzy numbers*. Computers & Operations Research, 1996. **23**(7): p. 695-703.
9. Geymayr, J.A.B. and N.F.F. Ebecken, *Fault-tree analysis: a knowledge-engineering approach*. IEEE Transactions on Reliability, 1995. **44**(1): p. 37-45.
10. Markowski, A.S. and M.S. Mannan, *Fuzzy logic for piping risk assessment (pfLOPA)*. Journal of Loss Prevention in the Process Industries, 2009. **22**(6): p. 921-927.
11. Markowski, A.S. and M.S. Mannan, *Fuzzy risk matrix*. Journal of Hazardous Materials, 2008. **159**(1): p. 152-157.
12. Markowski, A.S., M.S. Mannan, and A. Bigoszevska, *Fuzzy logic for process safety analysis*. Journal of Loss Prevention in the Process Industries, 2009. **22**(6): p. 695-702.

13. Siuta, D., A.S. Markowski, and M.S. Mannan, *Uncertainty techniques in liquefied natural gas (LNG) dispersion calculations*. Journal of Loss Prevention in the Process Industries, 2013. **26**(3): p. 418-426.
14. Markowski, A.S. and D. Siuta, *Fuzzy logic approach to calculation of thermal hazard distances in process industries*. Process Safety and Environmental Protection, 2014. **92**(4): pp. 338-345.
15. Singer, D., *A fuzzy set approach to fault tree and reliability analysis*. Fuzzy Sets and Systems, 1990. **34**(2): p. 145-155.
16. Gentile, M., W.J. Rogers, and M.S. Mannan, *Development of an inherent safety index based on fuzzy logic*. AIChE Journal, 2003. **49**(4): p. 959-968.
17. Gentile, M., W.J. Rogers, and M.S. Mannan, *Development of a fuzzy logic-based inherent safety index*. Process Safety and Environmental Protection, 2003. **81**(6): p. 444-456.
18. Cozzani, V., G. Gubinelli, and E. Salzano, *Escalation thresholds in the assessment of domino accidental events*. Journal of Hazardous Materials, 2006. **129**(1): p. 1-21.
19. Najjaran, H., R. Sadiq, and B. Rajani, *Fuzzy expert system to assess corrosion of cast/ductile iron pipes from backfill properties*. Computer-Aided Civil and Infrastructure Engineering, 2006. **21**(1): p. 67-77.
20. Karwowski, W. and A. Mital, *Potential applications of fuzzy sets in industrial safety engineering*. Fuzzy Sets and Systems, 1986. **19**(2): p. 105-120.
21. Bowles, J.B. and C.E. Peláez, *Fuzzy logic prioritization of failures in a system failure mode, effects and criticality analysis*. Reliability Engineering & System Safety, 1995. **50**(2): p. 203-213.
22. Quelch, J. and I.T. Cameron, *Uncertainty representation and propagation in quantified risk assessment using fuzzy sets*. Journal of Loss Prevention in the Process Industries, 1994. **7**(6): p. 463-473.
23. Misra, K.B. and G.G. Weber, *Use of fuzzy set theory for level-I studies in probabilistic risk assessment*. Fuzzy Sets and Systems, 1990. **37**(2): p. 139-160.
24. Klir, G.J. and B. Yuan., *Fuzzy sets and fuzzy logic theory and application*. 2008.
25. Purdy, G., *ISO 31000: 2009—setting a new standard for risk management*. Risk Analysis, 2010. **30**(6): p. 881-886.

26. Crowl, D.A. and J.F. Louvar, *Chemical process safety fundamentals with applications*. Third Edition ed. 2011.
27. Paskan, H., *Risk analysis and control for industrial processes-gas, oil and chemicals: a system perspective for assessing and avoiding low-probability, high-consequence events-978-0-12-800057-1*. International Journal of Performability Engineering, 2015. **11**(6): p. 548.
28. Center for Chemical Process Safety (CCPS), *Layer of protection analysis: simplified process risk assessment*. 2001.
29. Gupta, J., *Application of DOW's fire and explosion index hazard classification guide to process plants in the developing countries*. Journal of Loss Prevention in the Process Industries, 1997. **10**(1): p. 7-15.
30. Ericson, C., *Fault tree analysis—A history from the proceeding of the 17th International System Safety Conference*. 1999, Orlando.
31. Det Norske Veritas (DNV), *Integrity management of submarine pipeline systems*. Recommended Practice DNV-RP-F116, 2009, Norway.
32. Carter, D., I. Hirst, T. Maddison, and S. Porter, *Appropriate risk assessment methods for major accident establishments*. Process Safety and Environmental Protection, 2003. **81**(1): p. 12-18.
33. Cox, L. A. T., *What's wrong with risk matrices?* Risk Analysis, 2008. **28**(2): p. 497-512.
34. Levine, E., *Improving risk matrices: The advantages of logarithmically scaled axes*. Journal of Risk Research, 2012. **15**(2): p. 209-222.
35. American National Standards Institute (ANSI), *Functional Safety: Safety Instrumented Systems for the Process Industry Sector*. 2003, ISA. American National Standards Institute: 61511 Standard.
36. Markowski, A. and M.S. Mannan, *Fuzzy logic application for LOPA*. 2006: na.
37. Ross, T.J., *Fuzzy logic with engineering applications*. 2009: John Wiley & Sons.
38. Wu, D. and J.M. Mendel, *Aggregation using the linguistic weighted average and interval type-2 fuzzy sets*. IEEE Transactions on Fuzzy Systems, 2007. **15**(6): p. 1145-1161.

39. Klir, G. and B. Yuan, *Fuzzy sets and fuzzy logic*. Vol. 4. 1995: Prentice hall New Jersey.
40. Mamdani, E.H. and S. Assilian, *An experiment in linguistic synthesis with a fuzzy logic controller*. International Journal of Human-Computer Studies, 1999. **51**(2): p. 135-147.
41. Takagi, T. and M. Sugeno, *Fuzzy identification of systems and its applications to modeling and control*. IEEE Transactions on Systems, Man, and Cybernetics, 1985(1): p. 116-132.
42. Tsukamoto, Y., *An approach to fuzzy reasoning method*. Advances in Fuzzy Set Theory and Applications, 1979. **137**: p. 149.
43. Zadeh, L.A., *The concept of a linguistic variable and its application to approximate reasoning-III*. Information Sciences, 1975. **9**(1): p. 43-80.
44. Castillo, O. and P. Melin, *A review on the design and optimization of interval type-2 fuzzy controllers*. Applied Soft Computing, 2012. **12**(4): p. 1267-1278.
45. Mendel, J.M. *On the importance of interval sets in type-2 fuzzy logic systems*. in IFSA World Congress and 20th NAFIPS International Conference, 2001. Joint 9th. 2001. IEEE.
46. Mendel, J.M. and R.B. John, *Type-2 fuzzy sets made simple*. IEEE Transactions on Fuzzy Systems, 2002. **10**(2): p. 117-127.
47. Mendel, J.M., *Uncertain rule-based fuzzy logic systems: introduction and new directions*. 2001.
48. Wu, D. and J.M. Mendel, *Enhanced karnik--mendel algorithms*. IEEE Transactions on Fuzzy Systems, 2009. **17**(4): p. 923-934.
49. Center for Chemical Process Safety (CCPS), *guidelines for process equipment reliability data with data tables*. 1989, Center for Chemical Process Safety/AIChE.
50. Offshore and Onshore Reliability Data (OREDA), *Offshore Reliability Data Handbook*. 2002.
51. Khalil, M., M.A. Abdou, M.S. Mansour, H.A. Farag, and M.E. Ossman, *A cascaded fuzzy-LOPA risk assessment model applied in natural gas industry*. Journal of Loss Prevention in the Process Industries, 2012. **25**(6): p. 877-882.

52. Freeman, R., *Quantifying LOPA uncertainty*. Process Safety Progress, 2012. **31**(3): p. 240-247.
53. Freeman, R., *Simplified uncertainty analysis of layer of protection analysis results*. Process Safety Progress, 2013. **32**(4): p. 351-360.
54. Paskan, H. and W. Rogers, *Bayesian networks make LOPA more effective, QRA more transparent and flexible, and thus safety more definable!* Journal of Loss Prevention in the Process Industries, 2013. **26**(3): p. 434-442.
55. Croarkin, C., P. Tobias, and C. Zey, *NIST: Engineering statistics handbook*. 2001: National Institute of Standards Technology.
56. Liu, F. and J.M. Mendel, *Encoding words into interval type-2 fuzzy sets using an interval approach*. IEEE Transactions on Fuzzy Systems, 2008. **16**(6): p. 1503-1521.
57. Dong, W. and F. Wong, *Fuzzy weighted averages and implementation of the extension principle*. Fuzzy Sets and Systems, 1987. **21**(2): p. 183-199.
58. Guyonnet, D., B. Come, P. Perrochet, and A. Parriaux, *Comparing two methods for addressing uncertainty in risk assessments*. Journal of Environmental Engineering, 1999. **125**(7): p. 660-666.
59. Siler, W. and J.J. Buckley, *Fuzzy expert systems and fuzzy reasoning*. 2005: John Wiley & Sons.
60. Paté-Cornell, M.E., *Uncertainties in risk analysis: Six levels of treatment*. Reliability Engineering & System Safety, 1996. **54**(2): p. 95-111.