

**OPTIMAL DESIGN AND INTEGRATION OF SOLAR SYSTEMS
AND FOSSIL FUELS FOR PROCESS COGENERATION**

A Thesis

by

EMAN A. TORA

Submitted to the Office of Graduate Studies of
Texas A&M University
in partial fulfillment of the requirements for the degree of

MASTER OF SCIENCE

August 2008

Major Subject: Chemical Engineering

**OPTIMAL DESIGN AND INTEGRATION OF SOLAR SYSTEMS
AND FOSSIL FUELS FOR PROCESS COGENERATION**

A Thesis

by

EMAN A. TORA

Submitted to the Office of Graduate Studies of
Texas A&M University
in partial fulfillment of the requirements for the degree of

MASTER OF SCIENCE

Approved by:

Chair of Committee,	Mahmoud M. El-Halwagi
Committee Members,	M. Sam Mannan
	Maria Barrufet
Head of Department,	Michael Pishko

August 2008

Major Subject: Chemical Engineering

ABSTRACT

Optimal Design and Integration of Solar Systems and Fossil Fuels
for Process Cogeneration. (August 2008)

Eman A. Tora, B.S., Elmenia University, Egypt;

M.S., Cairo University, Egypt

Chair of Advisory Committee: Dr. Mahmoud M. El-Halwagi

Because of the fluctuations in incident solar power, outlet power also changes over time (e.g., on an hourly basis or seasonally). If there is a need for a stable power outlet, there are options towards a steady state output of the system. This work is aimed at the development of systematic design procedures for two solar-based power generation strategies.

The first is integration of fossil-fuel with the solar system to provide a compensation effect (power backup to supplement the power main source from solar energy).

The second is the use of thermal energy storage (TES) systems to save solar energy in a thermal form and use it when solar input decreases. A common TES configuration is the two-tank system which allows the use of the collector heat transfer fluid (HTF) as a storing medium. For the two tanks, one tank has the hot medium (e.g., a molten salt) and the second has the cold storage media.

Specifically, the following design challenges are addressed:

1. What is the optimal mix of energy forms to be supplied to the process?

2. What are the optimal scenario and integration mode to deliver the selected energy forms? How should they be integrated among themselves and with the process?
3. What is the optimal design of the energy systems?
4. What is the optimal dynamic strategy for operating the various energy systems?
5. What is the feasibility of using thermal energy storage to this optimum fossil fuel system?

The developed procedure includes gathering and generation of relevant solar and climatic data, modeling of the various components of the solar, fossil, and power generation systems, and optimization of several aspects of the hybrid system. A case study is solved to demonstrate the effectiveness and applicability of the devised procedure.

ACKNOWLEDGEMENTS

I would like to thank God for his grace and for blessing my research and my life.

I want to express my warm gratitude to my research advisor, Professor Dr. Mahmoud El- Halwagi, for introducing me to the wonderful world of energy integration and optimization, and for his advice, patience, and kindness. He taught me much about technical matters and he changed much in my personality. He taught me to be very wise when dealing with both my scientific life and personal life.

I would like also to thank my committee members, Dr. Sam Mannan and Dr. Maria Barrufet, for their support of my research and help.

Also I would like to thank Dr. Juan-Carlos Baltazar.

Also, I would like to thank my entire research group mates for their assistance and kindness.

I would like to thank the Egyptian Ministry of High Education and Scientific Research for giving me a full scholarship to study at Texas A&M.

I would like to express my gratitude to the entire Chemical Engineering Department at Texas A&M University, where I enjoyed my studies and my research.

Finally, I would like to express my deepest gratitude to my dear mother for her love and trust in me and also many thanks to my dear sister, Amal, for her love and encouragement.

NOMENCLATURE

A	Collector's reflector area
A_{abs}	Collector's absorber "receiver" area
$A_{\text{C}_{\text{abs}}}$	Area of the collector's absorber
A_{CR}	Area of the collector's receiver
CA.	California
E-W	East-west
DNI	Direct normal irradiation
$\text{DNI}_{\text{incident}}$	Direct normal irradiation incident on the collector's reflector
DOE	Department of Energy
Elec.	Electricity
$e\text{FFs}_{\text{p}}$	Instantaneous Solar- electrical efficiency
FPC	Flat-plate collector
h_{in}	Enthalpy content input
h/d	Hour/day
HTF	Heat transfer fluid
I _{bm}	Monthly solar beam
Irr	Irradiation per square meter
KOH	Potassium hydroxide
kWh/m^3	kW hour thermal energy per cubic meter
LEC	Levelized energy cost
LS-1	Luz solar parabolic trough collector; 1 st . generation

LS-2	Luz solar parabolic trough collector; 2 nd . generation
LS-3	Luz solar parabolic trough collector; 3 rd . generation
MWt	Mega Wat thermal
MWe	Mega Wat electricity
NaNO ₃	Sodium Nitrates
NaNO ₂	Sodium Nitrite
No_Op	No optimization
N-S	North - South
O&M	Operation and maintenance
PDC	Parabolic dish collector
PTC	Parabolic trough collector
Q _{abs}	Absorbed solar radiation “Apertures solar radiation”
Q _{aux}	Auxiliary fuel supply “fossil fuel”
Q _{loss}	Heat loss for the collector’s absorber and piping
Q _u	Useful solar irradiation
Red.	Reduction
R	Ratio; “fossil power/ solar power” $\leq (1/3)$
SEGS	Solar electrical generating system “nine plants in CA, USA”
S_E eff	Monthly solar-electrical efficiency
T _{amb}	Ambient air temperature
Th_eff	Thermal efficiency
V _{wind}	Wind velocity

Greek letters

η_{op}	Optical efficiency of the collector's reflector
η_{Rankine}	Efficiency of Rankine cycle
θ	Angle of the incident radiation on the collector's reflector

TABLE OF CONTENTS

	Page
ABSTRACT	iii
ACKNOWLEDGEMENTS	v
NOMENCLATURE.....	vi
TABLE OF CONTENTS	ix
LIST OF FIGURES.....	xi
LIST OF TABLES	xiv
 CHAPTER	
I INTRODUCTION.....	1
I.1. Solar Energy and Cogeneration.....	1
I.2. Solar Collectors.....	3
I.3. Predicting the Performance of the Collectors.....	7
I.4. Thermal Energy Storage.....	9
I.5. Economic Aspects.....	14
II PROBLEM STATEMENT	20
III APPROACH.....	22
III.1. Solution Methodology.....	24
III.2. Equations and Optimization Formulation.....	28
III.3. Cost Estimation.....	36

	Page
CHAPTER	
IV CASE STUDY	39
V CONCLUSIONS AND RECOMMENDATIONS.....	84
V.1. Conclusions.....	84
V.2. Future Work.....	86
REFERENCES	87
APPENDIX A	90
VITA	334

LIST OF FIGURES

FIGURE		Page
1.1	Parabolic trough solar collector.....	6
1.2a	Two- tank molten salt storage system.....	13
1.2b	Thermocline storage system.....	13
2.1	Schematic representation of the problem statement.....	21
3.1	Overall elements of the approach.....	23
4.1	The predicted solar data for January.....	59
4.2	The predicted solar data for February.....	59
4.3	The predicted solar data for March.....	60
4.4	The predicted solar data for April.....	60
4.5	The predicted solar data for May.....	61
4.6	The predicted solar data for June.....	61
4.7	The predicted solar data for July.....	62
4.8	The predicted solar data for August.....	62
4.9	The predicted solar data for September.....	63
4.10	The predicted solar data for October.....	63
4.11	The predicted solar data for November.....	64
4.12	The predicted solar data for December.....	64
4.13	Solar- electric hourly efficiency.....	65

FIGURE	Page
4.14	Annually maximum predicted useful solar radiation, absorber thermal losses and power per square meter of collector surface area..... 65
4.15	Summer hourly maximum predicted power per square meter of collector 66
4.16	Comparison between the maximum predicted power in June and the minimum predicted power in December..... 67
4.17	The results of first level of integration (Solar Alone) at different modes of operation for a base design of 7 hrs/day..... 71
4.18	Results of solar-fossil integration at different modes of operation for plant run 7hrs/day 72
4.19	The optimization results of solar- fossil- TES integration at different modes of operation for plant run 7hrs/day..... 73
4.20	The optimization results of fourth case of integration (solar, fossil, TES) at different modes of operation for design base of all sunshine hours daily 74
4.21	Comparison between the LEC for all optimum integration levels (with no storage) 75
4.22	Effect of integrating TES to solar- fossil power supply on the LEC for the 7 hrs/day base design..... 76
4.23	Effect of integrating TES to solar- fossil power supply on the LEC for the sunshine hours base design..... 77

FIGURE	Page
4.24	Comparison between the best cases among the two base design. 78

LIST OF TABLES

TABLE	Page
1.1	Characteristics of the Luz three generation parabolic trough collectors..... 5
1.2	Liquid storage media suitable for SEGS..... 10
1.3	Latent heat storage medium suitable for SEGS..... 11
1.4	Predictions of LEC (\$/kWhe) for a solar electricity system..... 16
1.5	Predictions of capital cost of the main parts of PT solar power plant... 17
1.6	Cost of solar power plants with thermal storage..... 18
1.7	Storage unit cost..... 19
1.8	O&M costs (\$/kWhe) 19
3.1.a	The values used in LS-3 approximations..... 29
3.1.b	LS-3 approximation's constants values..... 29
3.2	Assumptions used to calculate the LEC..... 37
4.1	The dry pulp temperature ($^{\circ}\text{C}$) of Barstow, CA. 40
4.2	The average hourly beam solar radiation (Wh/m^2) of Barstow, CA. 41
4.3	Average monthly solar radiation in (Wh/m^2). 44
4.4	January available, absorbed, and useful solar radiation, and power per square meter of the collector. 45
4.5	February available, absorbed, and useful solar radiation, and power per square meter of the collector..... 46

TABLE	Page	
4.6	March available, absorbed, and useful solar radiation, and power per square meter of the collector.....	47
4.7	April available, absorbed, and useful solar radiation, and power per square meter of the collector.....	48
4.8	May available, absorbed, and useful solar radiation, and power per square meter of the collector.....	49
4.9	June available, absorbed, and useful solar radiation, and power per square meter of the collector.	50
4.10	July available, absorbed, and useful solar radiation, and power per square meter of the collector.	51
4.11	August available, absorbed, and useful solar radiation, and power per square meter of the collector.....	52
4.12	September available, absorbed, and useful solar radiation, and power per square meter of the collector.	53
4.13	October available, absorbed, and useful solar radiation, and power per square meter of the collector.	54
4.14	November available, absorbed, and useful solar radiation, and power per square meter of the collector.....	55
4.15	December available, absorbed, and useful solar radiation, and power per square meter of the collector.	56

TABLE	Page
4.16	Summary of the optimization results..... 67
4.18	Optimum solar-fossil fuel integration hourly schedule for 7Hrs/day design around noon time. 79
4.19	Optimum solar-fossil fuel integration hourly schedule for sunshine hours base design..... 81

CHAPTER I

INTRODUCTION

I.1. Solar Energy and Cogeneration

Solar energy is one of the most attractive sources of sustainable energies. Much attention of research work has been paid to the design of solar energy systems for providing thermal energy (e.g., solar collectors) or electric power (e.g., photovoltaic systems). However, much less attention has been directed to the use of solar energy for process cogeneration in industrial processes.

Process cogeneration involves the utilization of combined heat and power from certain sources. For instance, high pressure steam may be generated in process boilers and fed to steam turbines that generate electric power and deliver exhaust steam that is hot enough (usually low pressure steam) to be used for process heating purposes. The dual usage of steam lends the name “cogeneration” and typically leads to reduction in energy cost and reduction in greenhouse gas emissions. In this regard, it is possible to conceive of promising cogeneration systems that involve the partial usage of solar energy supplemented with the use of fossil fuels. Thus, the collected solar heat may be converted to electric energy using power cycles that use external heat source such as Rankine cycle.

This thesis follows the style of Clean Technology and Environmental Policy.

The solar-based Rankine power cycle consists of a series of heat exchangers (that work as a solar boiler to produce steam), a reheat turbine, generator, pumps and cooler “condenser”, and a steam turbine. Water is used as the working fluid due to its low price and to match the need to steam in the industrial processes. Rankine reheat cycles is designed to run a high pressure steam up to 100 bars to produce electricity with possibility to draw steam at middle stage or hot mixture water at the last stage. The steam produced at 100 bars is suitable to generate power also at temperature of 371°C to assure achieving cycle efficiency not less than the efficiency of the Rankine Organic cycle (Herrmann 2004).

Solar power plants have been typically driven by the need for small-scale (200kW - 10MW) power systems in rural areas. There are several factors that motivate the move to more and bigger solar systems. These factors include the dwindling fossil resources and their increasing prices, the need for clean and sustainable energy resources, the global warming problem, and the need for the privatization of the electricity sector in some countries (Hassani et al. 2001).

Another potential usage of solar systems in industrial facilities is intended to shave off peak demands. The basic idea is to provide power supply at the peak demand (peaking power system) that is needed primarily through the peaks load time. It may be operated during all the sunshine time alone or with a back-up fossil fuel system. Furthermore, its power yield can be extended beyond sundown by using solar energy storage.

I.2. Solar Collectors

The solar heat may be collected using various collection systems that include:

- (a) Flat plat collector (FPC) that are simple in design and operation,
- (b) Parabolic dish collectors (PDC) that are commonly used to produce electricity directly in rural/ isolated locations,
- (c) Central receiver towers that heat air to $\sim 1000^{\circ}\text{C}$ to run a gas turbine producing electricity.

Parabolic trough collectors (PTC) that produce high pressure superheated steam. PTC are among the most commonly used collectors used in power plants and has a proven track-record of providing high efficiency and ability to operate at high temperature (Bakos 2000).

As an illustration of a proven track-record, the Solar Electric Generating Systems (SEGS) which usually use PTC and produce a power range of 20 – 200 MW have been operational since the mid 1980's. For example, SEGS VI located in Kramer Junction, California is operational since 1989 and produces 30 MW using PTC over a 188,000 m² field area.

The PTC reflectors reflect the sunlight onto a central tube receiver which passes the heat to a heat transfer fluid which subsequently flows through heat exchangers that produce superheated steam at temperatures as high as 400°C and pressures as high as 100 atm.

The power plant is supplemented by the use of natural gas. This natural gas contribution cannot exceed 25 percent of total energy contribution so as to comply with federal laws providing incentives for solar power plants.

Between 1984 and 1990, the SEGS were designed and constructed by the same company (Luz). After that, these plants were sold to investor groups including KJC Company. The used PTCs evolved over three generations (referred to as LS-1, LS-2, LS-3). Each generation progressively provided larger collectors with higher concentration ratios. The description of this solar field is given in Table 1.1.

Figure 1.1 is a schematic description of the PTC solar system. The heat-transfer fluid (HTF) used in SEGS is the Monsanto Therminol VP-1 which is an aromatic hydrocarbon (biphenyl-diphenyl oxide).

Table 1.1 Characteristics of the Luz three generation parabolic trough collectors.

Collector	Luz LS-1	Luz LS-2		Luz LS-3
Year	1984	1985	1988	1989
Item				
Area (m ²)	128	235		545
Aperture (m)	2.5	5.0		5.7
Length (m)	50	48		99
Receiver diameter (m)	0.042	0.070		0.070
Concentration Ratio	61	71		82
Optical efficiency	0.734	0.737	0.764	0.800
Receiver Absorptivity	0.94	0.94	0.99	0.96
Mirror reflectivity	0.94	0.94	0.99	0.96
Receiver Emittance	0.3	0.24	0.19	0.19
at temperature (°C)	300	300	350	350
Operating temperature (°C)	307	349	390	390

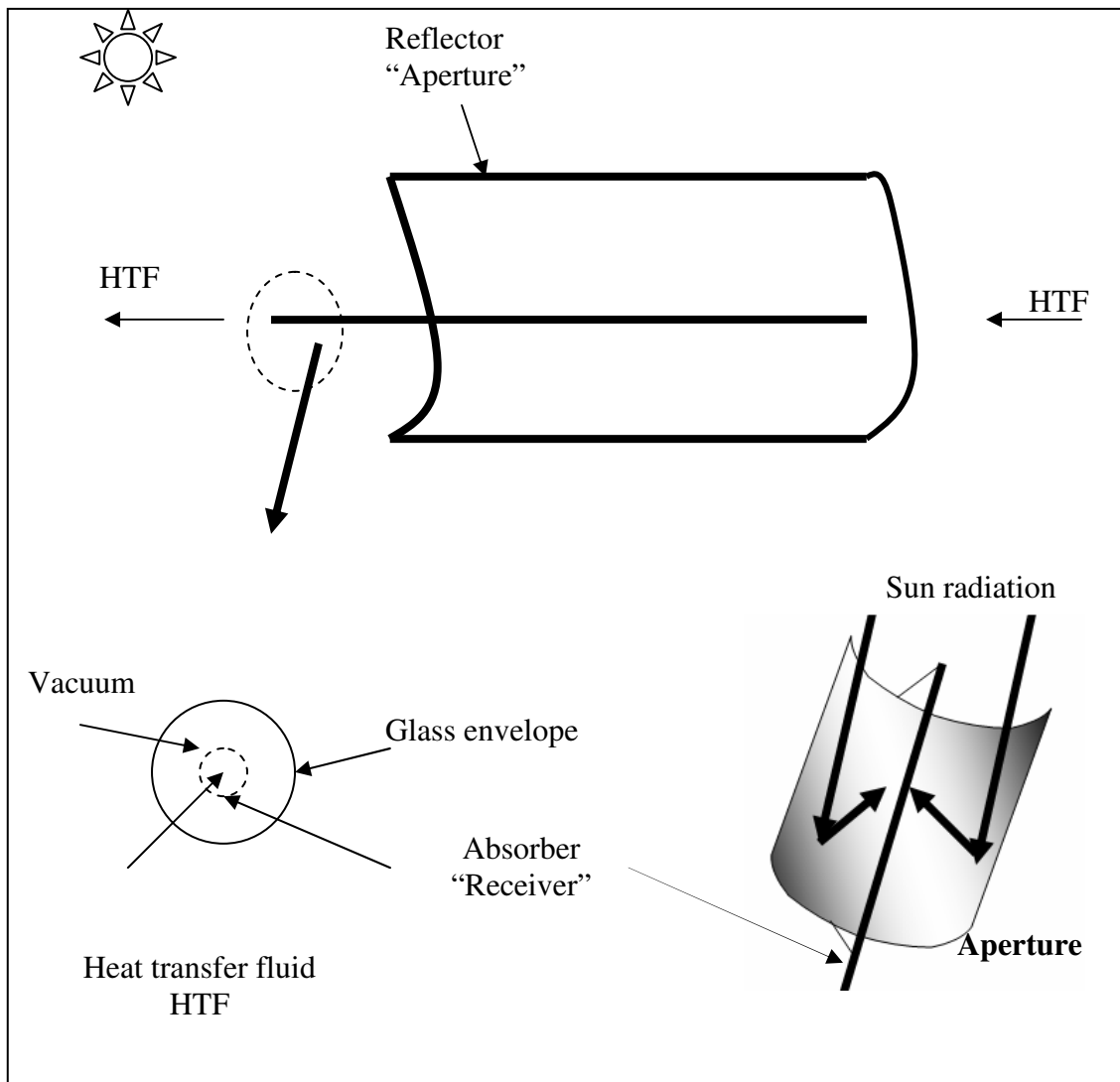

Fig 1.1 Parabolic trough solar collector.

Another way of classifying collectors is according to their type of motion. These include:

- a. Fixed collectors: This type has a certain position all the time and do not track the sun radiation, thus its concentration ratio (which is defined as the ratio between the

aperture area and the receiver area) of solar radiation is one in case of FPC and more than one in case of stationary PTC.

- b. Tracking collectors: These collectors have receivers and absorber surfaces. The receiver rotates continuously to track the sun radiation for high collection. The tracking modes are more suitable for power generation that requires high temperature.

The tracking collectors:

- i. E-W: horizontal East-West rotating collectors rotate about a horizontal East-West axis with adjustment to minimize the incident angle. This type of collectors' yields the maximum annually summer thermal output in case of using single axis tracking PTC.
- ii. N-S: horizontal North-South collectors have the axis fixed in the direction of North-South parallel to the earth axis. Thus, they are able to rotate from East to West following the sun motion. This kind of motion yields the maximum annual power output. Mainly the PTC used in the power plant uses this kind of motion to collect maximum solar radiation in summer (Duffie 2006).

I.3. Predicting the Performance of the Collectors

Several models have been developed to simulate the performance of solar power systems. These models include SOLERGY that was done by Stoddard et al. (1987), the FLAGSOL model that was done by Flachglas Solartechnik (1994), and the Easy Code that was done by Wahl (1992). The Easy Code model considers that the plant

performance depends not only on the conditions of the plant but also on the operating strategy. Easy Code may be used to simulate the solar-alone mode of a power plant (Lippke 1995).

A number of simplified models have also been developed to predict the power plant performance at different operating modes under steady state conditions; that was done by Archer (2006), Odeh and Morrison (1998), Zarza and Eck (2002) and Egbo (2008). Where the performance of the collection system depends on the solar radiation and the tracking mode, ambient air temperature, the type of the heat transfer fluid, the dimensions of the collector, and material of the receiver and the absorbing surface. The steady state performance can be modeled by doing energy balance around the collectors that divides the energy absorbed by the collectors to thermal losses due to temperature difference between the ambient and the receiver surface and useful thermal energy; that was done (Archer 2006).

These models all have some common equations such as the expressions for absorbed heat, lost heat, utilized heat, and generated power:

$$Q_{\text{abs}} = A * \text{DNI} * \eta_{\text{op}} \quad (1.1)$$

$$Q_{\text{u}} = Q_{\text{abs}} - Q_{\text{loss}} \quad (1.2)$$

$$\text{Power} = Q_{\text{u}} / \eta_{\text{Rankine}} \quad (1.3)$$

Where Q_{abs} is the solar radiation absorbed by the collector; A is the aperture area, η_{op} is the optical efficiency of the collector, Q_{u} is the useful solar radiation that is the net solar radiation after losses, Power is the predicted power from the useful solar radiation and η_{Rankine} is the efficiency of the Rankine cycle.

However they use different terms including the heat loss, parasitic power, the DNI value; where the values of these terms may change according to the sources, some determine them from the experiments, some from mathematical models and others assume them as ratios of each other. Some researches take a certain hour of a certain day and design the plant using its value and call this date the design base. Others use the most common solar radiation and others use very complicated software like TRANSYS to design the plant and predict its performance.

I.4. Thermal Energy Storage

In order to insure a steady-state power output of the solar power plant, thermal energy storage (TES) may be used. The TES stores energy during high-intensity periods and dispatches the stored thermal energy when the intensity of the solar power drops. As such, the plant works smoothly and insures that the steam turbine operates at a stable power output. A core unit in TES is the thermal storage tank. The objective is to have a large enough thermal capacity (which refers to the amount of energy that can be stored and dispatched). The thermal capacity of the TES depends on the system configuration, operating strategy, type and design of heat exchangers, levels of insulation, and the storage media. Each storage media is characterized by temperature limits (maximum-minimum), specific heat, mass, density, and cost. There are three main types of mechanisms used in storage media: sensible heat, latent heat, and reversible reactions. The following is an elaboration of the three types:

1. Sensible heat: the storage media remains in one phase (solid, liquid, or dual).

Traditionally, the liquid phase has been more commonly. Table 1.2 provides information on the candidates for the liquid storage media used in the SEGS “Solar electrical generating systems in CA”.

Table 1.2 Liquid storage media suitable for SEGS (Garg 1985).

Storage Medium	Average Heat Capacity kWht/m ³ *	Cost of the Medium US\$/kWht
Synthetic oil	57	43
Silicone oil	52	80
Nitrite salts**	76	24
Nitrate salt	83	16
Carbonate salts	108	44
Liquid sodium	31	55

*kWht is the storage size capacity in kWh thermal solar energy; kWht/m³ means the thermal energy stored in one cubic meter of the storage media

**Salt in a liquid form in certain temperature range; below that it freeze and become solid; like Hitec salt is molten salt in temperature range of 142 to 540°C and sodium liquid salt in the range of 100° to 760°C(Garg 1985).

2. Latent heat: in this mode, the thermal energy is stored in the form of latent heat associated with phase change. Examples of latent heat storage media are given in Table 1.3.

Table 1.3 Latent heat storage medium suitable for SEGS (Garg 1985).

Storage Medium	Average Heat Capacity kWht/m ³	Cost of the Medium US\$/kWht
NaNO ₃	125	4
KNO ₃	156	4
KOH	85	24

3. Chemical storage: in this mode, heat gathered by the collectors is used to activate a reversible endothermic chemical reaction. When dispatching the energy is needed, the reaction is reversed catalytically. In many cases, it is preferred to carry out the thermal storage near ambient temperature. While this mode enjoys the ability to store energy for an extended period of time, there are possible disadvantages in the form of uncertainty of thermodynamic and reactive behavior, relatively high cost, safety concerns (because of possible flammability and toxicity of the chemical compounds).

There are several possible configurations to implement TES. The most common configurations are the two-tank system and the thermocline. In the first configuration, the two- tanks, cold and hot salt tanks are used. Salt from the cold salt storage tanks (say at 300°C) is circulated in the heat exchanger until its temperature reaches a target temperature (say 385°C). The salt is then stored in the hot salt storage tank. When the stored energy is needed, the circulation direction is reversed. Thus, the hot salt is passed

through the heat exchanger giving its heat content to the HTF (cold now) that it is then circulated to boiler to produce the steam (Herrmann 2004).

Pacheco and Gilbert (1999) tested the near term storage systems using two tanks with molten salt that is given in Fig. 2.1 a,b. The second configuration is the thermocline where only one tank used as the storage media tank, where the thermocline oil is used as a storage media drawn from this tank and passed through the collectors where its temperature increases. Then, the oil is returned again to the same tank and the cycle continues.

Pacheco and Gilbert (1999) concluded that the cost of thermocline storage system is lower than the other systems (\$25/unit - \$35/unit). It also has the advantages of being compact, having a simple design, providing most of its energy at a fixed temperature.

With respect to the safety issues, Pacheco et al. (1999) investigated the reaction between the thermocline as a fuel and the nitrate salt as an oxidizing agent if a leakage in the heat exchanger occurs. They found that the thermocline boiled off rapidly, and that there is no indication of reaction with salt.

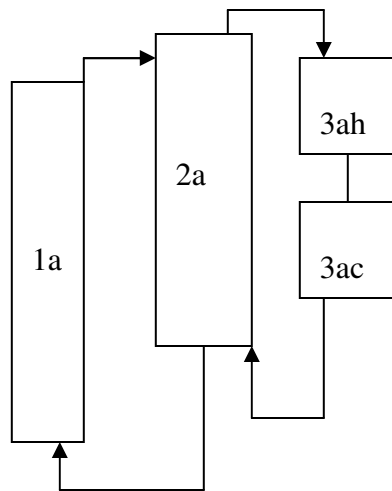

Fig. 1.2a Two-tank molten salt storage system.

1a Solar Field
 2a Heat exchanger
 3ah hot salt storage tank
 3ac cold salt storage tank

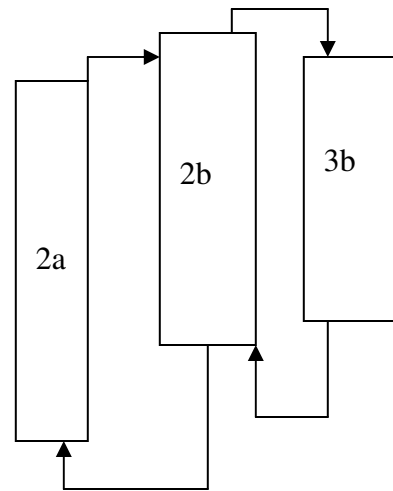

Fig. 1.2b Thermocline storage system.

2a Solar field
 2b Heat exchanger
 3b Thermocline

Kelly and Kearney (2006) studied a two-tank system. A molten salt mixture (60 wt.% sodium nitrate and 40 wt.% potassium nitrate) was used because of its relatively low cost, gentle chemical activity, small vapor pressure, prominent density and low vapor pressure. The hot tank salt operated at 385°C while the cold tank operated at 290°C. To charge the system, a stream of hot HTF (oil) was pumped from the solar field and passed through an oil-salt heat exchanger where the salt was pumped in the countercurrent direction until the temperature of the salt rose to the nominal value of 385°C. To discharge the storage tanks, the salt and the HTF flows were reversed in the same heat exchanger whereby the heat was transferred from the nitrate salt to the HTF.

The system was rated at 55 MWe and used Rankine power plants with high pressure at 100 bars entering the turbine. The solar collectors were LS-2 parabolic troughs. Depending on the desired goal, TES may be operated in different modes:

1. **Buffering:** in which the duration of the TES is limited to one hour and is used to supplement the solar input to the power cycle in case of passing clouds.
2. **Dispatchability:** in which the durability of the TES is in the range of 3 to 6 hours of full load operation (full load operation means that the plant works on its design load), thus it provide the design power completely not part or ratio of its design nominal power. This mode is used to shave off power peaks (from fossil fuel) or to address anticipated power increases.
3. **Increase of annual capacity factor:** in which the thermal energy is stored for 3-12 hours of full load. This mode extends the power production from solar energy and requires an increase in the area of the collectors.

I.5. Economic Aspects

The investment cost, the operation and maintenance (O&M) cost and the fuel cost all are combined in one term called the Levelized Energy Cost (LEC) defined as follows:

$$\text{Levelized Energy Cost (\$/kWhr)} = \frac{\text{Total Annualized Cost}}{\text{Total Electric Energy Produced Per Year}} \quad (1.4)$$

Where the total annualized cost is the sum of the fuel cost, the O&M cost, and the annualized fixed cost. Equivalently, the LEC may be expressed as Badran (2006):

$$\text{LEC} = [(a * \text{CC} + \text{O\&M})] / P_{el} \quad (1.5)$$

Where:

CC capital cost (\$)

a annuity factor (yr^{-1}) and is calculated through:

$$a = \frac{i(1+i)^n}{(1+i)^i - 1} \quad (1.6)$$

Where:

n is the useful-life period of the solar system or its depreciation or write-off time (years)

and i is the annual interest rate.

The values of the LEC of solar electricity vary depending on the application, the size, the design, and the economic factors. In one study conducted by S&L and SunLab, future values of the LEC of a solar system were estimated. These values are reported in Table 1.4.

Table 1.4 Predictions of LEC (\$/kWh) for a solar electricity system (Sargent 2003).

Type/Year	2004	2007	2010	2015	2020
SunLab	<i>0.0991</i>	<i>0.0681</i>	0.0566	0.0476	0.0428
S&L – S&L Efficiencies	<i>0.1037</i>	<i>0.0795</i>	0.0731	.0664	0.0621
S&L – SunLab Efficiencies	<i>0.1031</i>	<i>0.0763</i>	0.067	0.0624	0.0534
S&L – No Storage	0.1201	0.11	0.0989	0.091	0.0826

In order to promote the development and construction of solar energy systems in the US, the Energy Policy Act has increased the Investment Tax Credit (ITC) from 10% to 30% . Sotddard (2006) developed an economic study to predict the capital costs of solar power plants. Table 1.5 summarizes these predictions.

Table 1.5 Predictions of capital cost of the main parts of PT solar power plant (Stoddard 2006).

	Base line SEGS VI	Near term 50MW	Mid term 150MW	Long term 400MW
Year	1989	2004	2010	2020
Solar collection system (\$/m ²)	250	234	161	122
Support Structure \$/m ²	67	61	54	46
Heat collection elements, \$/unit	847	847	635	400
\$/m ²	43	43	28	18
Mirrors, \$/m ²	43	43	28	18
Power block, \$/kWe	527	367	293	197
Thermal storage, \$/kWe	NA	958	383	383
Total plant cost, \$/kWe	3,008	4856	3,416	2,225

SunLab conducted a study to predict the cost of solar power plants with thermal storage for capacities 100MW and larger; the results are given in Table 1.6.

Table 1.6 Cost of solar power plants with thermal storage (Sargent 2003).

	2004	2007	2010	2015	2020
Plant size, MWe	110	110	165	220	440
Storage, MWht	3525	3349	4894	6525	13050
Type	Indirect Two-tank	Direct Therminol	Direct Therminol	Direct Therminol	Direct Therminol
HTF Heat transfer fluid	VP- 1/Solar salt	HitecXL	HitecXL	HitecXL	HitecXL
HTF temperature, °C	400	450	500	500	500
SunLab estimates					
LEC \$/kWht	27.1	12.7	11.7	11.7	11.7
Capital cost \$/kWe	958	425	383	383	383

The foregoing results are considered to be conservative. Sargent (2003) reported lower costs estimated by Nexant (the developer of the two-tank storage technology) with the unit costs being \$36.4 and 31.0 per kWht for a 470 and 688 kWht systems, respectively. Herrmann (2004) evaluated the prices of the storage units for the two-tank

molten salt storage for parabolic trough solar power plants. The results are given in Table 1.7. Sargent (2003) estimated the O&M cost as reported in Table 1.8.

Table 1.7 Storage unit cost (Herrmann 2004).

Cost	Storage capacity					
	1	3	6	9	12	15
\$/kWh	65.63	38.79	32.33	30.88	31.18	31.00

Table 1.8 O&M costs (\$/kWh)(Sargent 2003).

	2004	2007	2010
SunLab estimate	0.0228	0.0171	0.0135
S&L- No storage	0.0377	0.0339	0.0278

CHAPTER II

PROBLEM STATEMENT

Because of the fluctuations in incident solar power, the outlet power will also change over time (e.g., on an hourly basis or seasonally). If there is a need for a stable power outlet, there are options towards a steady-state output of the system. In particular, two main strategies may be employed:

- 1) Integration of fossil-fuel with the solar system to provide a compensation effect (power backup to supplement the power main source from solar energy).
- 2) Thermal energy storage (TES) systems may be used to save solar energy in a thermal form and use it when solar input decreases. A common TES configuration is the two-tank system which allows the use of the collector heat transfer fluid (HTF) as a storing medium. For the two tanks, one tank has the hot medium (e.g., a molten salt) and the second has the cold storage media. These two alternatives are to be addressed in the work.

The problem may be stated as follows; given an industrial facility with known requirements for heating (thermal loads and temperatures), cooling (thermal loads and temperatures), and power. The following sources are considered as alternative candidates to provide the energy needs of the plant: solar energy, fossil fuel. The solar technologies may provide the energy in many forms including heat and power that is suitable to run cogeneration system in an industrial process. For the location of the

industrial facility, there is an available estimate of the dynamic profile of incident solar energy. Fig. 2.1 shows a simple representation of the problem.

The objective is to determine the optimal strategy to provide the power needed for the process. Specifically, the following design challenges should be answered:

- 1) What is the optimal mix of energy forms to be supplied to the process?
- 2) What are the optimal scenario and integration mode to deliver the selected energy forms?
- 3) How should they be integrated among themselves and with the process?
- 4) What is the optimal design of the energy systems?
- 5) What is the optimal dynamic strategy for operating the various energy systems?
- 6) What is the feasibility of using thermal energy storage to this optimum fossil fuel system?

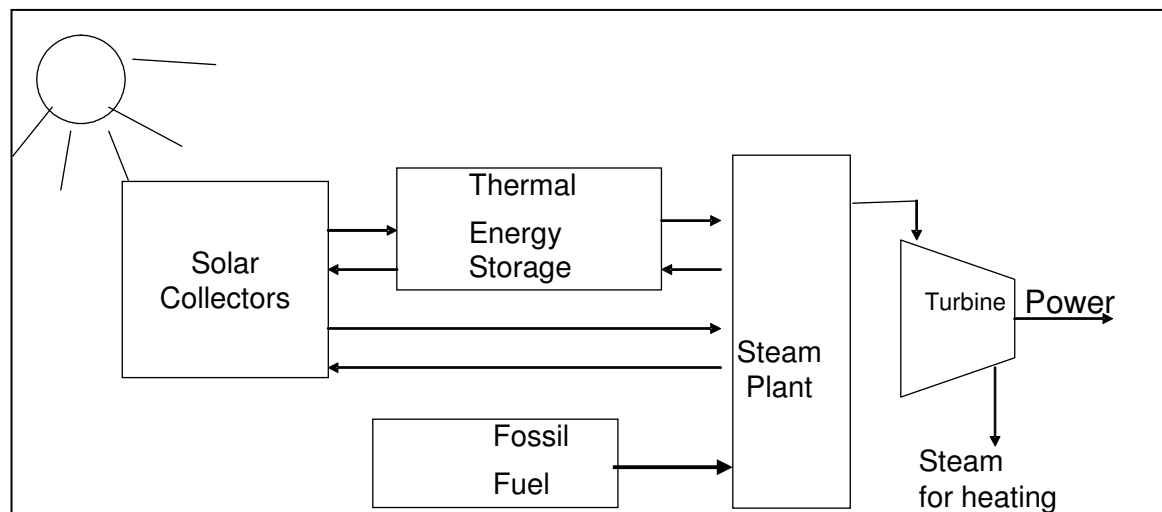

Fig. 2.1 Schematic representation of the problem statement.

CHAPTER III

APPROACH

This work introduces a hierarchical approach to addressing the stated problem. The approach is carried out through a sequence of steps. These steps include assessment and optimization of the following:

1. Energy alternatives: solar versus fossil fuel
2. Integration level: should solar energy be used alone or in conjunction with fossil fuel? To what extent? Should the solar energy be used directly or partially stored in a thermal energy storage system?
3. Operation mode: should the solar system be operated at full or partial load? During which periods of the year?
4. Optimization objectives: there are several factors to be considered in optimization such as fixed and operating costs, collector type and area, extent of CO₂ reduction (solar versus fuel which becomes important if there is a carbon credit), etc.

Fig. 3.1 shows a schematic representation of the elements addressed in the approach.

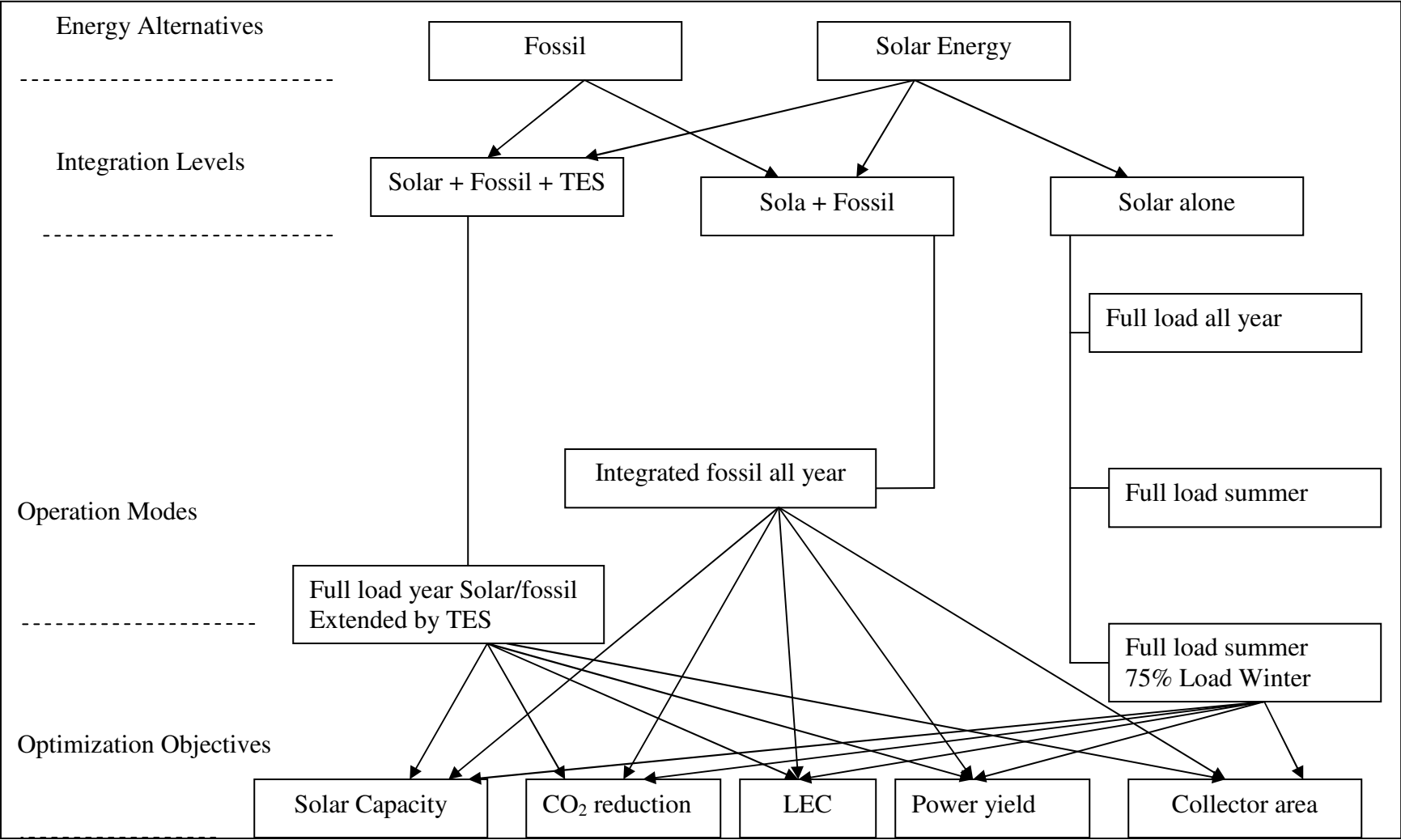

Fig. 3.1 Overall elements of the approach.

III.1. Solution Methodology

The following are the steps followed in solving the problem along with the associated equations and sources of information:

1. Determine the longitude and the latitude of the industrial location; there are some helpful sources at:

- Or pick a location graphically
- <http://eosweb.larc.nasa.gov>
- <http://nationalatlas.gov/natlas/Natlasstart.asp>.

2. Get the weather data of that location; the direct normal radiation ($\text{kWh/m}^2/\text{day}$); these data are available for a large number of towns at:

- <http://eosweb.larc.nasa.gov/cgi-bin/sse/sse.cg>
- http://www.eere.energy.gov/buildings/energyplus/cfm/weather_data.cfm

The weather data needed in these calculations include:

- average hourly statistical for dry bulb temperature
- average monthly statistical for dry bulb temperature
- monthly statistics for solar radiation (direct normal, diffuse, global horizontal) Wh/m^2
- average hourly statistics for direct normal solar radiation
- monthly statistics of wind speed

3. Determine the technical characteristics of the solar collector

These characteristics are available for solar collectors tested by ASHREA; unless it has to be calculated. These characteristics include the optical efficiency of the collector, the length, the aperture width, the inner and outer tube diameter and the concentration ratio.

4. Calculate the portion of the solar radiation that will actually hit the collectors since part of the incident solar radiation is lost due to the incident angle effect.
5. Calculate the absorbed solar intensity; that is the actual available solar intensity minus the losses due to the optical efficiency of the receiver of the collector.
6. Calculate the thermal losses of the absorber of the collectors.
7. Determine the net solar beam radiation “the useful radiation”; that is the absorbed radiation less the thermal losses of the collector’s absorber tube.
8. Determine the efficiency of the Rankine cycle; which refers to how much useful work “electricity” can be obtained from the solar net useful radiation.
9. Calculate the power per unit area of the collector receiver surface area. This is equal to the useful net solar radiation times the efficiency of the Rankine cycle.
10. Assume the different scenarios of operation and integration that include:

10.1. Solar Alone

- 10.1.1. All the year full load
- 10.1.2. Full load summer and variable part load winter
- 10.1.3. Full load summer and 75% load winter
- 10.1.4. Hybrid system (solar integrated with fossil)

10.2. Hybrid in winter only

10.2.1. Hybrid the entire year (without optimization)

10.2.2. Hybrid the entire year (with optimization)

10.3. Thermal energy storage integration (TES)

10.3.1. TES 1h/d

10.3.2. TES 3h/d

10.3.3. TES 6h/d

10.3.4. TES 9h/d

10.3.5. TES 12h/d

10.3.6. TES 15h/d

11. Now, we have the dynamic profile of solar radiation; that will work as the input data for the optimization program. Use the optimization formulas and software, LINGO, to find for each integration mode:

- the optimum design solar collectors area (minimum)
- the maximum annually power output
- the optimum schedule of power sources integration
- carbon dioxide emissions reduction
- the levelized energy cost (LEC)
- the effect of integrating TES at the different sizes on the design, operation and economic factors

12. Compare the optimum conditions, design, operation and economic criteria of all the integration modes.

13. Compare the levelized energy cost (LEC); LEC is the ratio between the cost and net power output; LEC is used to compare the different modes of integration; and study the improvement due to integration of each case.

III.2. Equations and Optimization Formulation

III.2.1. Equations

- Solar radiation that is actually available

$$\text{DNI} = \text{DNI}_{\text{incident}} * \text{Cos}(\theta) \quad (3-1)$$

Where:

DNI is the direct normal beam radiation

θ is the incident angle of the solar radiation incident on the collector's receiver surface area.; for North – South tracking parabolic trough collectors; the incident angle (θ) is

$$\text{given by } \text{Cos}(\theta) = (\text{Cos}^2(\theta_z) + \text{cos}^2(\delta) * \text{sin}^2(\omega))^{0.5} \quad (3-2)$$

θ_z is the zenith angle of the sun, which means the angle between the vertical and the line to the sun; $\text{Cos}(\theta_z) = \text{Cos}(\varnothing) \text{Cos}(\delta) \text{Cso}(\gamma) + \text{sin}(\varnothing) \text{Sin}(\delta)$ (3-3)

δ is the declination angle; that means the angular position of the sun at the noon time; its value between -23.45 and 23.45; $\delta = 23.45 * \text{Sin}(360 * (284 + n) / 365)$ (3-4)

ω is the hour angle, it is given by $\omega = (\text{Hr} - 12) * 15$; It is the same for the hours before and after noon time but with different sign (Duffie 2006).

- Absorbed Solar radiation

$$Q_{\text{abs}} = A_c * \text{DNI} * \eta_{\text{op}} \quad (3-5)$$

Where:

Q_{abs} is the absorbed solar radiation

A_c is the solar collectors surface area of the receivers.

η_{op} is the optical efficiency of the collectors (Peter, 2006)

Peak optical efficiency η_{opt} is the ratio between the absorbed heat low Q_{abs} and the solar power irradiated Q_{irr} onto the collector, at an angle of incidence of 0 degree and with no thermal loss (the working temperature similar to the ambient air temperature)

$$\eta_{\text{opt}} = Q_{\text{abs}} / Q_{\text{irr}} \quad (3-6)$$

$$Q_{\text{abs}} = m (h_{\text{out}} - h_{\text{in}}) = m C_p (T_{\text{out}} - T_{\text{in}}) \quad (3-7)$$

$$Q_{\text{irr}} = \text{Irr. } A \quad (3-8)$$

Q_{irr} is the power irradiated onto the solar collectors

A is the irradiated area.

$$A = A_{\text{mirror}} = \sum W P_{\text{module}} \cdot L_{\text{facet}} \quad (3-9)$$

$$h_{\text{in}} = f(T_{\text{in}}, P)$$

$$h_{\text{out}} = f(T_{\text{out}}, P)$$

Collector module mirror width W P_{module} , L facet length. (Zarza 2002)

- Absorber's thermal loss

$$Q_{\text{loss}} = U_L A_{\text{abs}} (T_{\text{av}} - T_{\text{amb}}) \quad (3-10)$$

A_{abs} is the area of the collector's absorber pipe; that equals $(2 * r * \pi * L)$.

Where r is the outer radius of the absorber pipe; L is the length of the absorber pipes U_L over all heat loss coefficient ; for collector LS3 its value is given by the approximation:

$$U_L = b_1 + b_2 (T_{av} - T_{amb}) + b_3 (T_{av} - T_{amb})^2 \quad (3-11)$$

: b_1 , b_2 and b_3 depend on the average temperature of the fluid in the absorber tubes. The value T_{av} is approximated for ranges of operating temperature by certain values. The data to calculate this parameter U_L is given in the table 3.1a,&b.

Table 3.1.a The values used in LS-3 approximations.

Pressure (bar)	Inlet temperature (°C)	Outlet Temperature (°C)	T_{av} °C
100	280	400	316

Table 3.1.b LS-3 approximation's constants values (Valenzuela 2004).

Fluid average temperature (°C)	b_1	b_2	b_3
$300 < T_{av}$	2.895474	-0.01640	0.000065

- **Useful Solar radiation**

$$Q_u = Q_{\text{abs}} - Q_{\text{loss}} \quad (3-12-a)$$

$$= A_c * \text{DNI} * \eta_{\text{op}} - U_L A_{\text{abs}} (T_{\text{av}} - T_{\text{amb}}) \quad \text{Eq}(3-12-b)$$

- **Power**

Power is the steam turbine output; it equals the useful thermal solar yield times the Rankine cycle efficiency.

$$P = Q_u * \eta_{\text{Rankine}} \quad (3-13)$$

- **Parasitic Power**

Parasitic power is the part of the steam power output that is needed to run the plant. It is assumed by 8.4% NREL/SR-550-34440 report (Sargent 2003).

That is also agree with the data of Edward, 1989; where he recorded that the parasitic power was in the range of 11-14%, but it decreased 1-2 percentage points (Edward 1989).

- **Net Electricity**

The net power output of the plant; it equals the power yield after eliminating the parasitic power.

$$\text{Net electricity} = \text{Power} - \text{Parasitic} \quad (3-14)$$

- **Storage capacity**

It is defined as the thermal energy equivalent to power output for certain number of hours. It is also called the storage size. That can be defined as the number of hours (1:15) Hrs/day times nominal power divided by Rankine cycle efficiency.

Nominal power is the power base design, like to design a power plant to produce 50MWh; that means 50MW is the nominal power.

- Thermal Storage Capacity is the nominal thermal capacity of the storage unit (J), it is given by:

$$\begin{aligned} \text{TSC} &= Q_s * t_f = \dot{m}_c \text{Cp} \Delta T t_f = \dot{m}_c \text{Cp} \Delta T t_f = \dot{m}_d \text{Cp} \Delta T t_d = \\ &= \text{Storage capacity} * \text{Nominal power} \end{aligned} \quad (3-15)$$

Where: \dot{m}_c is the mass flow rate of the charging

\dot{m}_d is the mass flow rate of discharging

- The effective charge capacity of the thermal storage device C_c (J) is determined from

$$C_c = TSC - \text{Loss} \quad (3-16)$$

- The charge coefficient or the performance factor is determined from the relation

$$\eta_c = C_c / TSC \quad (3-17)$$

- Also, the discharge coefficient or the performance factor is given by:

$$\eta_d = C_d / TSC \quad (3-18)$$

- The mass flow rate of the storage tank is given by:

$$m_c^o = TSC / (t_f C_p \Delta T) \quad (3-19)$$

$$m_d^o = TSC / (t_d C_p \Delta T) \quad (3-20)$$

(Garg 1985)

- The temperature of the storage changes with time; that can be expressed by:

$$T_{s(i+1)} = T_{s(i)} + [\Delta t / (m C_p)] [Q_u - L_s - (UA)_s (T_s - T_a)] \quad (3-21)$$

$T_{s(i+1)}$ is the temperature of the storage at hr (i+1)

$T_{s(i)}$ is the temperature of the storage at hr (i)

Q_u is energy gain from the solar collector

L_s is the energy removed from the tank

T_s is storage temperature

T_a is the ambient temperature

(Duffie 2006)

- In case of salt storage tanks, the thermal can be described by empirical relation:

$$q_{\text{loss}} = 0.00017 \cdot T_{\text{salt}} + 0.012 \text{ kW/m}^2 \quad (3-22)$$

Where T_{salt} is the temperature of the hot / cold salt respectively (Pacheco 2004).

- **Solar Efficiency**

$$\text{Solar efficiency} = (\text{Net power generation}) / (\text{incident beam radiation}) \quad (3-23)$$

- **Capacity Factor**

$$\text{Capacity factor} = (\text{Solar operating hours}) / (8,760 \text{ hours per year}) \quad (3-24)$$

(Muller 2004)

III.2.2. Optimization Formulation

Solar radiation changes from hour to hour reaching its maximum intensity at noon time. Also, the intensity of solar radiation varies from one season to another. Thus it is a challenge to determine the area of the solar field required to provide certain load throughout the year. Some of the questions include the required area and whether it will be based on certain hours and days of operation. Also, what fraction of the required load will come from solar energy versus fossil fuel. This problem is addressed via an optimization formulation. The objective function is intended to minimize the surface area of the solar collector. The optimization variables include the collected radiation, the power output, the space needed, the capital cost and the storage capacity. These variables are related to the area of the collector as shown in the following formulation.

Objective function: to minimize the area of the solar collector:

$$\text{Min} = A_{CR} \quad (3-25)$$

The absorbed solar radiation (aperture solar radiation) depends on the angle at which the solar radiation reaches the reflector, the optical efficiency of the reflector and the collectors area.

$$Q_{\text{abs}} = \sum_{d=1}^{365} \sum_{h=1}^{h2} (\text{DNI} \cdot \text{COS}(\theta) \cdot \eta_{\text{op}} \cdot A_{\text{CR}}) \quad (3-26)$$

Thermal losses of the absorber tube of the collector are attributed to heat transfer by conduction, convection and radiation. This depends on the ambient air temperature, the fluid average temperature and the tube surface area.

$$Q_{\text{Loss}} = \sum_{d=1}^{365} \sum_{h=1}^{h2} (U_L \cdot (T_{\text{av}} - T_{\text{amb}}) \cdot A_{\text{Cabs}}) \quad (3-27)$$

The net useful solar energy is the absorbed solar radiation less the thermal losses by the absorber tube.

$$Q_u = \sum_{d=1}^{365} \sum_{h=1}^{h2} (\text{DNI} \cdot \text{COS}(\theta) \cdot \eta_{\text{op}} \cdot A_{\text{CR}} - U_L \cdot (T_{\text{av}} - T_{\text{amb}}) \cdot A_{\text{Cabs}}) \quad (3-28)$$

To assure a stable power output, the fossil fuel is integrated with the solar energy. The amount of this auxiliary fossil fuel is limited to the difference between the available solar energy and the required load:

$$Q_{\text{aux}} = \sum_{d=1}^{365} \sum_{h=1}^{h2} (\text{Load} - \text{DNI} \cdot \text{COS}(\theta) \cdot \eta_{\text{op}} \cdot A_{\text{CR}} + U_L \cdot (T_{\text{av}} - T_{\text{amb}}) \cdot A_{\text{Cabs}}) - \text{PL} \quad (3-29)$$

$$\begin{aligned}
 Q_{\text{thermal}} &= \sum_{d=1}^{365} \sum_{h=1}^{h2} (\text{Load}) \\
 &= Q_u + Q_{\text{aux}}
 \end{aligned}
 \tag{3-30}$$

The power needed depends on the efficiency of the Rankine cycle and the thermal energy from both solar and fossil fuel to the power block:

$$P = \sum_{d=1}^{365} \sum_{h=1}^{h2} (Q_{\text{thermal}} \text{ Load. } \eta_{\text{Rankine}})
 \tag{3-31}$$

To evaluate reduction in CO₂ emissions compared to fossil fuel, a typical estimate is 300 kg CO₂/yr of reduction per m² of the area of the solar collector is used:

$$\text{CO}_2 \text{ reduction} = 300 * A_{\text{CR}}
 \tag{3-32}$$

$$\text{Fuel Saver} = \sum_{d=1}^{365} \sum_{h=1}^{h2} (\text{Load. } \eta_{\text{Rankine}}) / (P_{\text{V_fossil}})
 \tag{3-33}$$

Fuel Saver is the volume (ft³) of fossil fuel saved due to using solar energy. P_{V_fossil} is the power per unit volume of the fossil fuel, which equals (0.30179*10⁻⁶ GWh/ft³) in case of Natural gas; or (0.30179) to get the fuel save in Mft³/annulay. In all the previous formulas, h1 refers to the hour of starting steady state solar collection duration and h2 refers to the end of the period of useful solar collection.

III.3. Cost Estimation

The investment cost, the operation and maintenance (O&M) cost and the fuel cost all are combined in one term called the Levelized Energy Cost (LEC) defined as follows:

$$\text{Levelized Energy Cost (\$/kWhr)} = \frac{\text{Total Annualized Cost}}{\text{Total Electric Energy Produced Per Year}} \quad (3-34a)$$

Where the total annualized cost is the sum of the fuel cost, the O&M cost, and the annualized fixed cost.

Equivalently, the LEC may be expressed as (Badran, 2006):

$$\text{LEC} = [(a * \text{CC} + \text{O\&M})] / P_{el} \quad (3-34b)$$

Where:

CC capital cost (\$)

a annuity factor (yr^{-1}) and is calculated through:

$$a = \frac{i(1+i)^n}{(1+i)^i - 1} \quad (3-35)$$

where:

n is the useful-life period of the solar system or its depreciation or write-off time (years)

and

i is annual interest rate

- **Capital Cost (CC)**

The capital cost here is the sum of the direct capital cost including:

- 1.1 Structures and improvements ($57\$/m^2$)
- 1.2 Collector system “ receivers” ($\$34/m^2$ for 100MW in 2007)

In addition to the collectors, the collection system has other units like piping, control, control, electronic, HTF, etc. That the cost is $250\$/m^2$ in case of EGS 6 in 1999.

- 1.3 Thermal storage system
- 1.4 Steam Generator or HX system
- 1.5 EPGS “Ele. power generation system”

Steam turbine, generator, auxiliaries, feed water and condensate system are called the power block. The cost is $372.8\$/kWe$.

- 1.6 Balance of the plant

That includes (equipment, condenser, cooling tower system, water treatment system, fire protection, piping, compressed air system, cooling water system, plant control system, electrical equipment, and cranes and hoists). This cost is $219.73\$/kW$.

The next assumptions will be used in the calculation; these assumptions are based on the previous discussion.

Table 3.2 Assumptions used to calculate the LEC (Sargent 2003).

<i>Item</i>	Structure	Collection	Power block	Balance	Storage
Cost	$\$57/m^2$	$245\$/m^2$	$372.8\$/kWe$	$219.73\$/kW$	f(storage_Capacity)

Therefore, one may use the following expressions:

$$\text{Capital cost} = (245+57)*A_{\text{Collectors}} + (372.8+219.3)*N_{\text{P}} + \text{Storage Cost} \quad (3-36)$$

$$\text{Storage cost (\$)} = (\text{Storage_capacity}) * (N_{\text{P}} / \text{Efficiency}_{\text{Rankine}}) * (\text{Storage unit cost}) \quad (3-37)$$

- ***O&M Cost***

- In case of solar only “ No TES and no fuel”

$$\text{O\&M} = 0.024 \text{ \$/kWh} \quad (3-38a)$$

- In case of hybrid 25%

$$\text{O\&M} = 0.018 \text{ \$/kWh (Price 2003)} \quad (3-38b)$$

CHAPTER IV

CASE STUDY

Optimum design and integration of solar/fossil/TES cogeneration system for an industrial process
(50 MWe)

An industrial process is to be located at the city of Daggett which is located in San Bernardino County in California; it needs 50MWe, solar/fossil power supply is investigated considering different levels of integration; these levels include:

Two cases will be considered:

A- Batch industrial Process

B-Continuous Process

A. Batch industrial process (7hr/day)

Batch industrial process operates daily 7hrs batch during daylight. A solar power system is designed to provide the industrial process with an electric power supply of 50MWe. The following steps are followed:

A.1. Get the weather data of the town according to the procedure mentioned in Section III.1.2; these data include:

- The average hourly dry bulb temperature; the data are shown in Table 4.1.
- Average hourly beam solar radiation; the data are shown in Table 4.2.

Table 4.1 The dry pulp temperature (°C) of Barstow, CA.

hr	Jan	Feb	Mar	Apr	May	Jun	Jul	Aug	Sep	Oct	Dec
0.5	5.2	7.6	10.8	13.9	17.9	24	27.2	26.2	22	16.3	7
1.5	4.8	7.2	10.4	13.3	17.1	23.2	26.3	25.4	21.1	15.8	6.6
2.5	4.4	6.8	10	12.8	16.4	22.4	25.5	24.7	20.8	15.4	6.1
3.5	4	6.3	9.6	12.3	15.6	21.7	24.6	24	19.8	14.9	5.7
4.5	3.8	6.1	9.6	12.5	14.9	22.3	25.2	24.1	19	14.8	5.5
5.5	3.6	5.9	9.5	12.7	16	22.9	25.8	24.2	18.8	14.7	5.3
6.5	3.4	5.6	9.4	13	18.2	23.5	26.4	24.3	20.6	14.5	5.1
7.5	5.5	8.5	11.7	15.4	21	25.8	28.6	26.8	23.4	17.1	6.7
8.5	7.7	11.3	14	17.7	23.4	28.1	30.9	29.2	26.1	19.7	8.3
9.5	9.9	14.2	16.3	20.1	25.4	30.5	33.2	31.6	28.4	22.3	10
10.5	11.6	15.8	17.7	21.6	27.4	31.8	34.8	33	30.5	23.9	11.6
11.5	13.3	17.4	19.1	23	28.7	33.2	36.3	34.5	32.1	25.4	13.2
12.5	15	19	20.5	24.4	29.6	34.6	37.9	35.9	33.2	27	14.8
13.5	15.2	19.4	20.7	24.7	30.3	34.9	38.4	36.3	33.8	27.2	14.9
14.5	15.4	19.8	20.9	24.9	30.6	35.3	38.9	36.6	33.9	27.4	15
15.5	15.7	20.3	21.1	25.1	30.2	35.7	39.4	36.9	33.5	27.7	15.1
16.5	13.7	18	19.5	23.6	29	34.2	38	35.7	32.3	25.6	13.6
17.5	11.7	15.6	17.9	22	27.5	32.7	36.7	34.4	30.6	23.6	12.1
18.5	9.7	13.3	16.3	20.4	25.2	31.2	35.2	33.2	28.9	21.5	10.6
19.5	8.8	12.1	15.1	19.1	23.4	29.6	33.6	31.8	27.3	20.3	9.8
20.5	7.8	10.9	14	17.8	21.9	28.1	31.9	30.4	26	19.1	9
21.5	6.9	9.7	12.9	16.5	20.9	26.6	30.3	28.9	24.8	17.9	8.2
22.5	6.4	9	12.3	15.7	19.9	25.7	29.3	28	23.5	17.3	7.7
23.5	5.8	8.3	11.7	14.8	19.1	24.8	28.2	27	22.8	16.7	7.3

Table 4.2 The average hourly beam solar radiation (Wh/m^2) of Barstow, CA.

hr	Jan	Feb	Mar	Apr	May	Jun	Jul	Aug	Sep	Oct	Dec
0.5	0	0	0	0	0	0	0	0	0	0	0
1.5	0	0	0	0	0	0	0	0	0	0	0
2.5	0	0	0	0	0	0	0	0	0	0	0
3.5	0	0	0	0	0	0	0	0	0	0	0
4.5	0	0	0	0	15	41	13	0	0	0	0
5.5	0	0	12	155	297	409	297	179	81	9	0
6.5	3	71	273	511	550	642	543	505	487	325	24
7.5	264	387	557	681	676	750	667	669	684	581	348
8.5	518	545	692	798	736	812	732	746	785	704	551
9.5	655	629	737	847	770	837	782	809	848	763	650
10.5	692	665	780	871	806	854	798	807	850	807	690
11.5	723	684	768	890	829	859	807	829	852	777	683
12.5	724	668	769	846	823	826	821	799	820	753	681
13.5	717	677	744	834	802	842	802	785	777	757	661
14.5	653	646	701	814	756	777	797	743	734	699	568
15.5	523	581	624	722	717	748	749	663	604	596	409
16.5	240	426	511	653	643	670	659	570	518	343	109
17.5	3	84	205	429	457	528	519	403	238	19	0
18.5	0	0	1	37	108	217	197	74	2	0	0
19.5	0	0	0	0	0	0	0	0	0	0	0
20.5	0	0	0	0	0	0	0	0	0	0	0
21.5	0	0	0	0	0	0	0	0	0	0	0
22.5	0	0	0	0	0	0	0	0	0	0	0
23.5	0	0	0	0	0	0	0	0	0	0	0
SUM	5715	6063	7374	9088	8985	9812	9183	8581	8280	7133	5374

- Average monthly solar radiation; the data are given in Table 4.3.

- Average monthly dry bulb temperature; the data are given in Table 4.4.

A.2. Select the kind of the solar collector: in our case, we use SL-3. The data are given in Chapter I, table 1.1., from the reports of the NREL.

A.3. Use Excel sheet to calculate:

1. Aperture solar radiation using eq (3-1).
2. Absorber solar radiation using eq (3-2).
3. Thermal loss of the receiver “absorber tube” using eq(3-10, 3-11).
4. Net useful solar beam radiation using eq(3-12).
5. Maximum power per square meter of the collectors.

For these calculations, we take the power cycle efficiency equals 0.375, the piping loss equals 10W/m^2 and T_{abs} (average collector’s absorber pipe temperature in eq (3-10)) equals 400°C .

The results are given in tables 4.1 to 4.15 and figures 4.1 to 4.16.

A.4. from the Excel spread sheet choose the date of the noon time and three hours before and after; and use them as an input data for the optimization program Lingo.

Use the optimization formulation that is mentioned in section (III.3.) to calculate:

1. Minimum area achieving the required power requirement using optimization approach that is given in sec.3.3., equation 24-3:24-30).
2. Stable power output equals 50MWhe (Using eq 13-3).
3. Maximum annual power output (Using eq13-3).
4. The LEC (using eq 34-3, 34-3, 36-3, 37-3).

5. CO₂ reduction (using 32-3).
6. Fuel saver (using 33-3).
7. Solar factor (using 23-3).
8. Solar electricity efficiency (using 22-3).
9. Thermal efficiency (using 24-3, 5-3,12-3-a).
10. Effect of TES on the plant economic performance (using eq 34-3, 36-3, 37-3).

A.4. Repeat the step (5) for all the operation and integration modes.

A.5. Summarize the optimization results in an Excel sheet; the results are given in tables (4-16) to (4-19).

A.6. Compare the results of the different cases.

B. Continuous industrial process

In this case, the process needs power supply of 50MWe 24 hours a day. This requires extending the power supply from the sun all day long including the time after the sunset. Thus, Case (B) considers using the solar radiation available the entire sunshine hours, not only 7 hours/day around noon time as in case (A). The procedure to find the optimum output and optimum design area are carried out similar to case (A) except step number (A-4) because there is no selection of the specific hours for solar radiation hours. Results of the steps (A-1) to (A-3) are used as an input data for the optimization program, LINGO.

Table 4.3 Average monthly solar radiation in (Wh/m²).

January	February	March	April	May	June	July	August	September	October	November	December	Sum_av_month	Av. Annually
5716	6063	7374	9089	8984	9812	9184	8582	8280	7132	6116	5298	91630	2787.079

Sum_av_month: sum average monthly

Av. Annually: Average annually

Table 4.4 January available, absorbed, and useful solar radiation, and power per square meter of the collector.

hr	Ta °C	DNI Wh/m ²	V wind m/s	ω	δ	Cos(θ_z)	Cos(θ)	I _b wh/m ²	<u>U_l</u> (w/m ² .C)	Loss_Rec Wh/m ²	Qu Wh/m ²	Power (wh/m ²)	eFFs_p	Monthly eff
0.5	5.2	0	15.9	-172.5	-20.9	-0.966	0.974	0.000	4.077	112.676	0.000	0		
1.5	4.8	0	15.9	-157.5	-20.9	-0.914	0.981	0.000	4.087	113.056	0.000	0		
2.5	4.4	0	15.9	-142.5	-20.9	-0.813	0.992	0.000	4.096	113.437	0.000	0		
3.5	4	0	15.9	-127.5	-20.9	-0.671	1.000	0.000	4.106	113.819	0.000	0		
4.5	3.8	0	15.9	-112.5	-20.9	-0.496	0.996	0.000	4.111	114.011	0.000	0		
5.5	3.6	0	15.9	-97.5	-20.9	-0.302	0.974	0.000	4.116	114.203	0.000	0		
6.5	3.4	3	15.9	-82.5	-20.9	-0.100	0.932	2.795	4.121	114.395	0.000	0	eFFs_p	
7.5	5.5	264	15.9	-67.5	-20.9	0.094	0.868	229.210	4.070	112.391	60.98	22.87	0.088772	
8.5	7.7	518	15.9	-52.5	-20.9	0.269	0.788	408.364	4.018	110.325	206.37	77.39	0.145697	
9.5	9.9	655	15.9	-37.5	-20.9	0.411	0.702	459.640	3.966	108.293	249.42	93.53	0.138786	
10.5	11.6	692	15.9	-22.5	-20.9	0.512	0.624	432.033	3.926	106.745	228.88	85.83	0.120789	Th_eff
11.5	13.3	723	15.9	-7.5	-20.9	0.564	0.577	417.171	3.887	105.216	218.52	81.95	0.110521	0.6572
12.5	15	724	15.9	7.5	-20.9	0.564	0.577	417.748	3.848	103.707	220.49	82.68	0.111378	
13.5	15.2	717	15.9	22.5	-20.9	0.512	0.624	447.641	3.844	103.531	244.58	91.72	0.124487	
14.5	15.4	653	15.9	37.5	-20.9	0.411	0.702	458.237	3.839	103.355	253.23	94.96	0.141432	
15.5	15.7	523	15.9	52.5	-20.9	0.269	0.788	412.306	3.832	103.092	216.75	81.28	0.151648	S_E eff
16.5	13.7	240	15.9	67.5	-20.9	0.094	0.868	208.373	3.878	104.860	51.84	19.44	0.084576	0.12
17.5	11.7	3	15.9	82.5	-20.9	-0.100	0.932	2.795	3.924	106.654	0.000	0		
18.5	9.7	0	15.9	97.5	-20.9	-0.302	0.974	0.000	3.970	108.476	0.000	0		
19.5	8.8	0	15.9	112.5	-20.9	-0.496	0.996	0.000	3.992	109.305	0.000	0		
20.5	7.8	0	15.9	127.5	-20.9	-0.671	1.000	0.000	4.015	110.232	0.000	0		
21.5	6.9	0	15.9	142.5	-20.9	-0.813	0.992	0.000	4.037	111.073	0.000	0		

Table 4.5 February available, absorbed, and useful solar radiation, and power per square meter of the collector.

hr	Ta	DNI	ω	δ	$\text{Cos}(\theta_z)$	$\text{Cos}(\theta)$	I_b	$\underline{U}_l(\text{w/m}^2\cdot\text{C})$	$Loss_Coll$	qu	Power (w/m ²)	eFFs_p	
0.5	7.6	0	-172.5	-13	-0.925	0.933	0	4.020	110.419	0.000	0		
1.5	7.2	0	-157.5	-13	-0.870	0.947	0	4.029	110.792	0.000	0		
2.5	6.8	0	-142.5	-13	-0.765	0.968	0	4.039	111.167	0.000	0		
3.5	6.3	0	-127.5	-13	-0.617	0.989	0	4.051	111.636	0.000	0		
4.5	6.1	0	-112.5	-13	-0.435	1.000	0	4.056	111.825	0.000	0		
5.5	5.9	0	-97.5	-13	-0.232	0.993	0	4.060	112.013	0.000	0	eFFs_p	
6.5	5.6	71	-82.5	-13	-0.022	0.966	68.6058	4.068	112.297	0.000	0		
7.5	8.5	387	-67.5	-13	0.181	0.918	355.3649	3.999	109.582	164.709	61.766	0	
8.5	11.3	545	-52.5	-13	0.363	0.854	465.469	3.933	107.017	255.359	95.759	0.156551	
9.5	14.2	629	-37.5	-13	0.512	0.783	492.7487	3.866	104.415	279.784	104.919	0.170736	Th_eff
10.5	15.8	665	-22.5	-13	0.617	0.721	479.2791	3.830	103.004	270.419	101.407	0.161895	0.7047033
11.5	17.4	684	-7.5	-13	0.671	0.683	467.2335	3.794	101.610	262.177	98.316	0.148131	S_E eff
12.5	19	668	7.5	-13	0.671	0.683	456.3041	3.758	100.233	254.810	95.554	0.139742	0.13
13.5	19.4	677	22.5	-13	0.617	0.721	487.9278	3.749	99.891	280.451	105.169	0.139181	
14.5	19.8	646	37.5	-13	0.512	0.783	506.0662	3.741	99.551	295.302	110.738	0.150885	
15.5	20.3	581	52.5	-13	0.363	0.854	496.2156	3.729	99.126	287.846	107.942	0.166357	
16.5	18	426	67.5	-13	0.181	0.918	391.1769	3.781	101.091	201.850	75.694	0.180391	
17.5	15.6	84	82.5	-13	-0.022	0.966	81.16743	3.835	103.179	0.000	0	0.173747	
18.5	13.3	0	97.5	-13	-0.232	0.993	0	3.887	105.216	0.000	0		
19.5	12.1	0	112.5	-13	-0.435	1.000	0	3.915	106.293	0.000	0		
20.5	10.9	0	127.5	-13	-0.617	0.989	0	3.942	107.380	0.000	0		
21.5	9.7	0	142.5	-13	-0.765	0.968	0	3.970	108.476	0.000	0		
22.5	9	0	157.5	-13	-0.870	0.947	0	3.987	109.120	0.000	0		

Table 4.6 March available, absorbed, and useful solar radiation, and power per square meter of the collector.

hr	Ta	DNR	ω	δ	$\text{Cos}(\theta_z)$	$\text{Cos}(\theta)$	I_b	$U_l(\text{w/m}^2.\text{C})$	$Loss_Coll$	qu	Power (w/m^2)	S_eEFF	
0.5	10.8	0	-172.5	-2.4	-0.8418191	0.8518607	0	3.945	107.471	0.000	0		
1.5	10.4	0	-157.5	-2.4	-0.786	0.874	0	3.954	107.835	0.000	0		
2.5	10	0	-142.5	-2.4	-0.678	0.911	0	3.963	108.201	0.000	0		
3.5	9.6	0	-127.5	-2.4	-0.526	0.951	0	3.973	108.568	0.000	0		
4.5	9.6	0	-112.5	-2.4	-0.339	0.983	0	3.973	108.568	0.000	0		
5.5	9.5	12	-97.5	-2.4	-0.131	0.999	11.990908	3.975	108.660	0.000	0		S_E eff
6.5	9.4	273	-82.5	-2.4	0.084	0.994	271.40027	3.977	108.752	207.1	77.670	0.135064	0.18
7.5	11.7	557	-67.5	-2.4	0.292	0.968	539.29749	3.924	106.654	421.4	158.039	0.205226	
8.5	14	692	-52.5	-2.4	0.479	0.926	640.81866	3.871	104.593	502.7	188.496	0.208283	
9.5	16.3	737	-37.5	-2.4	0.631	0.877	645.98664	3.819	102.566	506.8	190.046	0.198603	
10.5	17.7	780	-22.5	-2.4	0.739	0.832	648.89745	3.787	101.350	509.1	190.919	0.189307	Th_eff
11.5	19.1	768	-7.5	-2.4	0.795	0.805	618.42545	3.756	100.147	484.7	181.778	0.1815	0.781521
12.5	20.5	769	7.5	-2.4	0.795	0.805	619.23069	3.725	98.957	485.4	182.019	0.182144	
13.5	20.7	744	22.5	-2.4	0.739	0.832	618.94834	3.721	98.788	485.2	181.935	0.188241	
14.5	20.9	701	37.5	-2.4	0.631	0.877	614.43234	3.716	98.619	481.5	180.580	0.198035	
15.5	21.1	624	52.5	-2.4	0.479	0.926	577.84804	3.712	98.451	452.3	169.604	0.205798	
16.5	19.5	511	67.5	-2.4	0.292	0.968	494.75946	3.747	99.806	385.8	144.678	0.203788	
17.5	17.9	205	82.5	-2.4	0.084	0.994	203.79874	3.783	101.178	153.0	57.390	0.099367	
18.5	16.3	1	97.5	-2.4	-0.131	0.999	0.9992423	3.819	102.566	0.000	0		
19.5	15.1	0	112.5	-2.4	-0.339	0.983	0	3.846	103.619	0.000	0		
20.5	14	0	127.5	-2.4	-0.526	0.951	0	3.871	104.593	0.000	0		
21.5	12.9	0	142.5	-2.4	-0.678	0.911	0	3.896	105.574	0.000	0		
22.5	12.3	0	157.5	-2.4	-0.786	0.874	0	3.910	106.113	0.000	0		
23.5	11.7	0	172.5	-2.4	-0.842	0.852	0	3.924	106.654	0.000	0		

Table 4.7 April available, absorbed, and useful solar radiation, and power per square meter of the collector.

hr	Ta	DNI	ω	δ	Cos(θ_z)	Cos(θ)	Ib	UL(w/m ² .C)	Loss_Coll	qu	Power (w/m ²)	eFFs_p	
0.5	13.9	0	-172.5	9.4	-0.71587	0.727365	0	3.873	104.682	0.000	0		
1.5	13.3	0	-157.5	9.4	-0.661	0.761	0	3.887	105.216	0.000	0		
2.5	12.8	0	-142.5	9.4	-0.554	0.817	0	3.898	105.664	0.000	0		
3.5	12.3	0	-127.5	9.4	-0.404	0.881	0	3.910	106.113	0.000	0		
4.5	12.5	0	-112.5	9.4	-0.220	0.938	0	3.905	105.933	0.000	0		
5.5	12.7	155	-97.5	9.4	-0.014	0.978	151.6267	3.901	105.754	5.548	2.08	0.024043	
6.5	13	511	-82.5	9.4	0.198	0.998	510.0067	3.894	105.485	292.521	109.70	0.208158	
7.5	15.4	681	-67.5	9.4	0.404	0.997	678.9304	3.839	103.355	429.789	161.17	0.228342	S_E eff
8.5	17.7	798	-52.5	9.4	0.588	0.979	781.2809	3.787	101.350	513.674	192.63	0.232503	0.2
9.5	20.1	847	-37.5	9.4	0.739	0.952	806.2951	3.734	99.296	535.740	200.90	0.228412	Th_eff
10.5	21.6	871	-22.5	9.4	0.845	0.925	806.0692	3.701	98.031	536.825	201.31	0.222589	0.833858
11.5	23	890	-7.5	9.4	0.900	0.909	809.1566	3.670	96.863	540.462	202.67	0.219322	
12.5	24.4	846	7.5	9.4	0.900	0.909	769.1534	3.640	95.709	509.614	191.11	0.217711	
13.5	24.7	834	22.5	9.4	0.845	0.925	771.8275	3.634	95.463	511.999	192.00	0.221871	
14.5	24.9	814	37.5	9.4	0.739	0.952	774.881	3.629	95.299	514.605	192.98	0.228466	
15.5	25.1	722	52.5	9.4	0.588	0.979	706.8732	3.625	95.136	460.363	172.64	0.230711	
16.5	23.6	653	67.5	9.4	0.404	0.997	651.0155	3.657	96.367	414.445	155.42	0.229908	
17.5	22	429	82.5	9.4	0.198	0.998	428.1661	3.692	97.696	234.837	88.06	0.20016	
18.5	20.4	37	97.5	9.4	-0.014	0.978	36.19475	3.727	99.042	0.000	0		
19.5	19.1	0	112.5	9.4	-0.220	0.938	0	3.756	100.147	0.000	0		
20.5	17.8	0	127.5	9.4	-0.404	0.881	0	3.785	101.264	0.000	0		
21.5	16.5	0	142.5	9.4	-0.554	0.817	0	3.814	102.392	0.000	0		
22.5	15.7	0	157.5	9.4	-0.661	0.761	0	3.832	103.092	0.000	0		
23.5	14.8	0	172.5	9.4	-0.716	0.727	0	3.853	103.884	0.000	0		

Table 4.8 May available, absorbed, and useful solar radiation, and power per square meter of the collector.

hr	Ta	DNI	ω	δ	$\text{Cos}(\theta_z)$	$\text{Cos}(\theta)$	I_b	$U_l(\text{w/m}^2\cdot\text{C})$	$Loss_Coll$	qu	Power (w/m^2)	eFFs_p	
0.5	17.9	0	-172.5	18.8	-0.59359	0.606315	0	3.783	101.178	0.000	0		
1.5	17.1	0	-157.5	18.8	-0.541	0.651	0	3.801	101.870	0.000	0		
2.5	16.4	0	-142.5	18.8	-0.439	0.724	0	3.816	102.479	0.000	0		
3.5	15.6	0	-127.5	18.8	-0.294	0.807	0	3.835	103.179	0.000	0		
4.5	14.9	15	-112.5	18.8	-0.118	0.882	13.23688	3.850	103.796	0.000	0		
5.5	16	297	-97.5	18.8	0.080	0.942	279.75	3.825	102.829	110.971	41.614	0.139658	
6.5	18.2	550	-82.5	18.8	0.284	0.980	539.2724	3.776	100.919	320.499	120.187	0.211728	
7.5	21	676	-67.5	18.8	0.481	0.998	674.6998	3.714	98.535	431.225	161.709	0.230914	S_E eff
8.5	23.4	736	-52.5	18.8	0.658	0.998	734.7334	3.662	96.532	481.255	180.470	0.236448	0.2
9.5	25.4	770	-37.5	18.8	0.802	0.988	760.4337	3.619	94.892	503.455	188.796	0.236357	
10.5	27.4	806	-22.5	18.8	0.904	0.974	784.9988	3.576	93.277	524.722	196.771	0.235272	Th_eff
11.5	28.7	829	-7.5	18.8	0.957	0.965	799.8515	3.549	92.240	537.641	201.615	0.234339	0.831612
12.5	29.6	823	7.5	18.8	0.957	0.965	794.0625	3.530	91.529	533.721	200.145	0.234359	
13.5	30.3	802	22.5	18.8	0.904	0.974	781.1031	3.516	90.980	523.903	196.463	0.236129	
14.5	30.6	756	37.5	18.8	0.802	0.988	746.6077	3.509	90.745	496.541	186.203	0.237558	
15.5	30.2	717	52.5	18.8	0.658	0.998	715.7661	3.518	91.058	471.555	176.833	0.238008	
16.5	29	643	67.5	18.8	0.481	0.998	641.7633	3.543	92.003	411.408	154.278	0.231918	
17.5	27.5	457	82.5	18.8	0.284	0.980	448.0863	3.574	93.196	238.693	89.510	0.20407	
18.5	25.2	108	97.5	18.8	0.080	0.942	101.7273	3.623	95.054	0.000	0	0	
19.5	23.4	0	112.5	18.8	-0.118	0.882	0	3.662	96.532	0.000	0		
20.5	21.9	0	127.5	18.8	-0.294	0.807	0	3.694	97.780	0.000	0		
21.5	20.9	0	142.5	18.8	-0.439	0.724	0	3.716	98.619	0.000	0		
22.5	19.9	0	157.5	18.8	-0.541	0.651	0	3.738	99.466	0.000	0		
23.5	19.1	0	172.5	18.8	-0.594	0.606	0	3.756	100.147	0.000	0		

Table 4.9 June available, absorbed, and useful solar radiation, and power per square meter of the collector.

hr	Ta	DNI	ω	δ	$\text{Cos}(\theta_z)$	$\text{Cos}(\theta)$	I_b	$U_l(\text{w/m}^2.\text{C})$	$Loss_Coll$	qu	Power (w/m^2)	eFFs_p	
0.5	24	0	-172.5	23.1	-0.532	0.5455	0	3.649	96.037	0.000	0		
1.5	23.2	0	-157.5	23.1	-0.481	0.596	0	3.666	96.698	0.000	0		
2.5	22.4	0	-142.5	23.1	-0.382	0.678	0	3.683	97.362	0.000	0		
3.5	21.7	0	-127.5	23.1	-0.241	0.769	0	3.699	97.947	0.000	0		
4.5	22.3	41	-112.5	23.1	-0.070	0.853	34.95865	3.686	97.446	0.000	0		
5.5	22.9	409	-97.5	23.1	0.122	0.920	376.3102	3.673	96.946	194.102	72.7882	0.174369	
6.5	23.5	642	-82.5	23.1	0.320	0.967	620.5392	3.660	96.450	389.982	146.243	0.220223	
7.5	25.8	750	-67.5	23.1	0.512	0.992	744.0552	3.610	94.567	490.678	184.004	0.236568	
8.5	28.1	812	-52.5	23.1	0.684	1.000	811.9711	3.562	92.717	546.860	205.072	0.243296	S_E eff
9.5	30.5	837	-37.5	23.1	0.824	0.996	833.807	3.511	90.823	566.222	212.333	0.244342	0.22
10.5	31.8	854	-22.5	23.1	0.923	0.988	843.6871	3.485	89.813	575.137	215.676	0.243232	
11.5	33.2	859	-7.5	23.1	0.974	0.982	843.3575	3.456	88.736	575.950	215.981	0.242177	
12.5	34.6	826	7.5	23.1	0.974	0.982	810.9585	3.428	87.671	551.096	206.661	0.241112	Th_eff
13.5	34.9	842	22.5	23.1	0.923	0.988	831.8321	3.422	87.445	568.021	213.008	0.243725	0.856735
14.5	35.3	777	37.5	23.1	0.824	0.996	774.0359	3.414	87.143	522.085	195.782	0.242976	
15.5	35.7	748	52.5	23.1	0.684	1.000	747.9733	3.405	86.843	501.536	188.076	0.242577	
16.5	34.2	670	67.5	23.1	0.512	0.992	664.6893	3.436	87.974	433.777	162.666	0.234618	
17.5	32.7	528	82.5	23.1	0.320	0.967	510.35	3.466	89.119	309.161	115.935	0.213266	
18.5	31.2	217	97.5	23.1	0.122	0.920	199.656	3.497	90.278	59.447	22.2926	0.107246	
19.5	29.6	0	112.5	23.1	-0.070	0.853	0	3.530	91.529	-91.529	-		
20.5	28.1	0	127.5	23.1	-0.241	0.769	0	3.562	92.717	-92.717	-34.769		
21.5	26.6	0	142.5	23.1	-0.382	0.678	0	3.593	93.920	-93.920	-		
											35.2198		

Table 4.10 July available, absorbed, and useful solar radiation, and power per square meter of the collector.

hr	Ta	DNI	ω	δ	$\text{Cos}(\theta_z)$	$\text{Cos}(\theta)$	I_b	$\underline{U}_L(\text{w/m}^2\cdot\text{C})$	$Loss_Coll$	qu	Power (w/m ²)	eFFs_p	
0.5	0	27.2	-172.5	21.2	-0.56	0.5728	0	4.204	117.704	0.000	0		
1.5	26.3	0	-157.5	21.2	-0.508	0.620	0	3.600	94.162	0.000	0		
2.5	25.5	0	-142.5	21.2	-0.407	0.698	0	3.617	94.810	0.000	0		
3.5	24.6	0	-127.5	21.2	-0.265	0.786	0	3.636	95.545	0.000	0		
4.5	25.2	13	-112.5	21.2	-0.091	0.866	11.25975	3.623	95.054	0.000	0		
5.5	25.8	297	-97.5	21.2	0.103	0.930	276.2409	3.610	94.567	116.426	43.65981	0.146724	S_E eff
6.5	26.4	543	-82.5	21.2	0.304	0.973	528.4287	3.597	94.081	318.662	119.4982869	0.213474	0.219
7.5	28.6	667	-67.5	21.2	0.499	0.995	663.816	3.551	92.320	428.733	160.7748949	0.232855	
8.5	30.9	732	-52.5	21.2	0.673	1.000	731.8352	3.503	90.511	484.957	181.8588453	0.239692	
9.5	33.2	782	-37.5	21.2	0.815	0.993	776.5158	3.456	88.736	522.477	195.9288094	0.241566	
10.5	34.8	798	-22.5	21.2	0.915	0.982	783.9508	3.424	87.520	529.641	198.6152121	0.23996	Th_eff
11.5	36.3	807	-7.5	21.2	0.967	0.975	786.8028	3.393	86.395	533.048	199.8928726	0.238818	0.84926
12.5	37.9	821	7.5	21.2	0.967	0.975	800.4524	3.362	85.209	545.153	204.4322726	0.240044	
13.5	38.4	802	22.5	21.2	0.915	0.982	787.8804	3.352	84.842	535.462	200.7983713	0.241417	
14.5	38.9	797	37.5	21.2	0.815	0.993	791.4106	3.342	84.476	538.652	201.994593	0.244371	
15.5	39.4	749	52.5	21.2	0.673	1.000	748.8314	3.332	84.112	504.953	189.3574092	0.243948	
16.5	38	659	67.5	21.2	0.499	0.995	655.8542	3.360	85.136	429.548	161.0803915	0.236313	
17.5	36.7	519	82.5	21.2	0.304	0.973	505.0728	3.386	86.097	307.961	115.4855307	0.216238	
18.5	35.2	197	97.5	21.2	0.103	0.930	183.2305	3.416	87.219	49.366	18.51216581	0.100101	
19.5	33.6	0	112.5	21.2	-0.091	0.866	0	3.448	88.430	-10.000	0		
20.5	31.9	0	127.5	21.2	-0.265	0.786	0	3.483	89.735	-10.000	0		
21.5	30.3	0	142.5	21.2	-0.407	0.698	0	3.516	90.980	-10.000	0		

Table 4.11 August available, absorbed, and useful solar radiation, and power per square meter of the collector.

hr	Ta	DNR	δ	$\text{Cos}(\theta_z)$	$\text{Cos}(\theta)$	I_b	$U_l(\text{w/m}^2\text{C})$	$Loss_{Coll}$	Abs. loss	qu	Power (w/m^2)	eFFs_p	
0.5	26.2	0	-172.5	13.5	-0.665	0.6767	0	3.602	94.243	0.000	0		
1.5	25.4	0	-157.5	13.5	-0.610	0.715	0	3.619	94.892	0.000	0		
2.5	24.7	0	-142.5	13.5	-0.506	0.778	0	3.634	95.463	0.000	0		
3.5	24	0	-127.5	13.5	-0.357	0.850	0	3.649	96.037	0.000	0		
4.5	24.1	0	-112.5	13.5	-0.176	0.915	0	3.647	95.955	0.000	0		
5.5	24.2	179	-97.5	13.5	0.027	0.964	172.6316	3.645	95.873	32.232	12.08715	0.07507	
6.5	24.3	505	-82.5	13.5	0.236	0.993	501.272	3.642	95.791	295.227	110.7101	0.212872	
7.5	26.8	669	-67.5	13.5	0.439	1.000	668.9042	3.589	93.758	431.365	161.7619	0.233522	S_E eff
8.5	29.2	746	-52.5	13.5	0.621	0.990	738.5648	3.538	91.845	489.007	183.3776	0.237105	0.2
9.5	31.6	809	-37.5	13.5	0.769	0.970	784.9519	3.489	89.967	527.994	197.9978	0.235917	
10.5	33	807	-22.5	13.5	0.874	0.950	766.3047	3.460	88.889	514.155	192.8081	0.230391	
11.5	34.5	829	-7.5	13.5	0.928	0.937	776.3853	3.430	87.747	523.361	196.2605	0.228273	Th_eff
12.5	35.9	799	7.5	13.5	0.928	0.937	748.2894	3.401	86.693	501.938	188.2268	0.227277	0.835735
13.5	36.3	785	22.5	13.5	0.874	0.950	745.4141	3.393	86.395	499.937	187.4763	0.230425	
14.5	36.6	743	37.5	13.5	0.769	0.970	720.9138	3.387	86.171	480.560	180.21	0.234128	
15.5	36.9	663	52.5	13.5	0.621	0.990	656.392	3.382	85.948	429.165	160.937	0.23466	
16.5	35.7	570	67.5	13.5	0.439	1.000	569.9184	3.405	86.843	359.092	134.6593	0.22895	
17.5	34.4	403	82.5	13.5	0.236	0.993	400.0249	3.432	87.823	222.197	83.32403	0.202292	
18.5	33.2	74	97.5	13.5	0.027	0.964	71.36724	3.456	88.736	0.000	0	0	
19.5	31.8	0	112.5	13.5	-0.176	0.915	0	3.485	89.813	0.000	0		
20.5	30.4	0	127.5	13.5	-0.357	0.850	0	3.514	90.902	0.000	0		

Table 4.12 September available, absorbed, and useful solar radiation, and power per square meter of the collector.

hr	Ta	DNR	δ	$\text{Cos}(\theta_z)$	$\text{Cos}(\theta)$	I_b	$U_l(\text{w/m}^2\cdot\text{C})$	$Loss_Coll$	Abs.loss	qu	Pi	eFFs_p	
0.5	22	0	-172.5	2.2	-0.7967	0.8073	0	3.692	97.696	0.000	0		
1.5	21.1	0	-157.5	2.2	-0.741	0.834	0	3.712	98.451	0.000	0		
2.5	20.8	0	-142.5	2.2	-0.633	0.878	0	3.718	98.704	0.000	0		
3.5	19.8	0	-127.5	2.2	-0.481	0.927	0	3.741	99.551	0.000	0		
4.5	19	0	-112.5	2.2	-0.294	0.969	0	3.758	100.233	0.000	0		
5.5	18.8	81	-97.5	2.2	-0.086	0.994	80.5502994	3.763	100.404	0.000	0	0	S_E eff
6.5	20.6	487	-82.5	2.2	0.129	0.999	486.574133	3.723	98.872	280.387	105.14505	0.209741	0.19
7.5	23.4	684	-67.5	2.2	0.338	0.983	672.342037	3.662	96.532	431.341	161.75304	0.228325	
8.5	26.1	785	-52.5	2.2	0.524	0.950	746.025673	3.604	94.323	492.497	184.68642	0.22686	
9.5	28.4	848	-37.5	2.2	0.676	0.910	771.469862	3.555	92.479	514.697	193.01148	0.219407	
10.5	30.5	850	-22.5	2.2	0.784	0.872	741.59782	3.511	90.823	492.455	184.67057	0.209566	Th_eff
11.5	32.1	852	-7.5	2.2	0.840	0.850	724.229033	3.478	89.581	479.802	179.92589	0.203788	0.8272001
12.5	33.2	820	7.5	2.2	0.840	0.850	697.027942	3.456	88.736	458.887	172.08244	0.202636	
13.5	33.8	777	22.5	2.2	0.784	0.872	677.907654	3.444	88.278	444.048	166.51802	0.20703	
14.5	33.9	734	37.5	2.2	0.676	0.910	667.758112	3.442	88.202	436.004	163.50168	0.215241	
15.5	33.5	604	52.5	2.2	0.524	0.950	574.01211	3.450	88.507	360.703	135.26363	0.216969	
16.5	32.3	518	67.5	2.2	0.338	0.983	509.171308	3.474	89.427	307.910	115.4664	0.216509	
17.5	30.6	238	82.5	2.2	0.129	0.999	237.791876	3.509	90.745	89.488	33.558085	0.142894	
18.5	28.9	2	97.5	2.2	-0.086	0.994	1.98889628	3.545	92.082	0.000	0		
19.5	27.3	0	112.5	2.2	-0.294	0.969	0	3.578	93.357	0.000	0		
20.5	26	0	127.5	2.2	-0.481	0.927	0	3.606	94.404	0.000	0		
21.5	24.8	0	142.5	2.2	-0.633	0.878	0	3.632	95.381	0.000	0		

Table 4.13 October available, absorbed, and useful solar radiation, and power per square meter of the collector.

hr	Ta	DNR	δ	$\text{Cos}(\theta_z)$	$\text{Cos}(\theta)$	I_b	$U_L(\text{w/m}^2\cdot\text{C})$	$Loss_{abs}$	qu	Power (w/m ²)	eFFs_p	
0.5	16.3	0	-172.5	-9.6	-0.901	0.9106	0	3.819	102.566	0.000		
1.5	15.8	0	-157.5	-9.6	-0.846	0.927	0	3.830	103.004	0.000		
2.5	15.4	0	-142.5	-9.6	-0.740	0.953	0	3.839	103.355	0.000		
3.5	14.9	0	-127.5	-9.6	-0.590	0.980	0	3.850	103.796	0.000		
4.5	14.8	0	-112.5	-9.6	-0.406	0.997	0	3.853	103.884	0.000		
5.5	14.7	9	-97.5	-9.6	-0.200	0.998	8.9808455	3.855	103.972	0.000		
6.5	14.5	325	-82.5	-9.6	0.012	0.978	317.73239	3.860	104.149	150.037	0.159555	
7.5	17.1	581	-67.5	-9.6	0.218	0.937	544.15654	3.801	101.870	333.455	0.20223	
8.5	19.7	704	-52.5	-9.6	0.402	0.879	619.09658	3.743	99.636	395.642	0.198545	S_E eff
9.5	22.3	763	-37.5	-9.6	0.552	0.816	622.26921	3.686	97.446	400.370	0.185458	0.17
10.5	23.9	807	-22.5	-9.6	0.658	0.759	612.42231	3.651	96.120	393.818	0.172471	
11.5	25.4	777	-7.5	-9.6	0.713	0.725	563.30731	3.619	94.892	355.754	0.161637	Th_eff
12.5	27	753	7.5	-9.6	0.713	0.725	545.90786	3.585	93.598	343.129	0.160822	0.806507
13.5	27.2	757	22.5	-9.6	0.658	0.759	574.47793	3.581	93.437	366.145	0.17085	
14.5	27.4	699	37.5	-9.6	0.552	0.816	570.07362	3.576	93.277	362.782	0.18331	
15.5	27.7	596	52.5	-9.6	0.402	0.879	524.12153	3.570	93.037	326.261	0.19308	
16.5	25.6	343	67.5	-9.6	0.218	0.937	321.24904	3.615	94.729	162.270	0.164414	
17.5	23.6	19	82.5	-9.6	0.012	0.978	18.575124	3.657	96.367	0.000		
18.5	21.5	0	97.5	-9.6	-0.200	0.998	0	3.703	98.115	0.000		
19.5	20.3	0	112.5	-9.6	-0.406	0.997	0	3.729	99.126	0.000		
20.5	19.1	0	127.5	-9.6	-0.590	0.980	0	3.756	100.147	0.000		
21.5	17.9	0	142.5	-9.6	-0.740	0.953	0	3.783	101.178	0.000		

Table 4.14 November available, absorbed, and useful solar radiation, and power per square meter of the collector.

hr	Ta	DNR	δ	Cos(θ_z)	Cos(θ)	I _b	$U_l(w/m^2.C)$	Loss_abs	qu	Power (w/m ²)	eFFs_p	
0.5	9.8	0	-172.5	-18.9	-0.95736	0.965295	0	3.968	108.384	0.000		
1.5	9.4	0	-157.5	-18.9	-0.905	0.974	0	3.977	108.752	0.000		
2.5	9	0	-142.5	-18.9	-0.803	0.988	0	3.987	109.120	0.000		
3.5	8.5	0	-127.5	-18.9	-0.658	0.998	0	3.999	109.582	0.000		
4.5	8.2	0	-112.5	-18.9	-0.482	0.998	0	4.006	109.861	0.000		
5.5	8	0	-97.5	-18.9	-0.285	0.980	0	4.010	110.046	0.000		
6.5	7.6	119	-82.5	-18.9	-0.081	0.941	112.03212	4.020	110.419	0.000		
7.5	10.1	496	-67.5	-18.9	0.116	0.882	437.37023	3.961	108.110	339.896	0.170567	
8.5	12.5	673	-52.5	-18.9	0.293	0.806	542.29926	3.905	105.933	423.839	0.171525	Th_eff
9.5	15	739	-37.5	-18.9	0.437	0.723	534.44714	3.848	103.707	417.558	0.154295	0.9914088
10.5	16.8	779	-22.5	-18.9	0.539	0.650	506.0692	3.807	102.131	394.855	0.136708	
11.5	18.6	775	-7.5	-18.9	0.592	0.605	468.82588	3.767	100.575	365.061	0.124416	S_E eff
12.5	20.4	732	7.5	-18.9	0.592	0.605	442.81361	3.727	99.042	344.251	0.122349	0.11
13.5	20.6	668	22.5	-18.9	0.539	0.650	433.95921	3.723	98.872	337.167	0.130373	
14.5	20.8	567	37.5	-18.9	0.437	0.723	410.05619	3.718	98.704	318.045	0.141646	
15.5	20.9	461	52.5	-18.9	0.293	0.806	371.47096	3.716	98.619	287.177	0.150336	
16.5	18.7	107	67.5	-18.9	0.116	0.882	94.352045	3.765	100.490	65.482		
17.5	16.5	0	82.5	-18.9	-0.081	0.941	0	3.814	102.392			
18.5	14.3	0	97.5	-18.9	-0.285	0.980	0	3.864	104.326	0.000		
19.5	13.2	0	112.5	-18.9	-0.482	0.998	0	3.889	105.306	0.000		
20.5	12.2	0	127.5	-18.9	-0.658	0.998	0	3.912	106.203	0.000		
21.5	11.1	0	142.5	-18.9	-0.803	0.988	0	3.938	107.198	0.000		

Table 4.15 December available, absorbed, and useful solar radiation, and power per square meter of the collector.

hr	Ta	DNR	δ	$\text{Cos}(\theta_z)$	$\text{Cos}(\theta)$	I_b	$U_l(\text{w/m}^2\cdot\text{C})$	$Loss_{abs}$	qu	Power (w/m^2)	eFFs_p	
0.5	7	0	-172.5	-23	-0.97408	0.981458	0	4.034	110.979	0.000		
1.5	6.6	0	-157.5	-23	-0.923	0.988	0	4.044	111.354	0.000		
2.5	6.1	0	-142.5	-23	-0.823	0.996	0	4.056	111.825	0.000		
3.5	5.7	0	-127.5	-23	-0.683	1.000	0	4.065	112.202	0.000		
4.5	5.5	0	-112.5	-23	-0.511	0.992	0	4.070	112.391	0.000		
5.5	5.3	0	-97.5	-23	-0.319	0.967	0	4.075	112.581	0.000		
6.5	5.1	24	-82.5	-23	-0.121	0.921	22.094787	4.080	112.771	0.000		
7.5	6.7	348	-67.5	-23	0.071	0.853	296.97324	4.041	111.260	116.318	0.124266	S_E eff
8.5	8.3	551	-52.5	-23	0.243	0.770	424.01291	4.003	109.768	219.443	0.145477	0.1075237
9.5	10	650	-37.5	-23	0.383	0.679	441.17715	3.963	108.201	234.741	0.131779	Th_eff
10.5	11.6	690	-22.5	-23	0.482	0.597	412.05249	3.926	106.745	212.897	0.112854	0.629822
11.5	13.2	683	-7.5	-23	0.534	0.547	373.56596	3.889	105.306	183.547	0.098678	
12.5	14.8	681	7.5	-23	0.534	0.547	372.47206	3.853	103.884	184.094	0.099291	
13.5	14.9	661	22.5	-23	0.482	0.597	394.73434	3.850	103.796	201.992	0.111982	
14.5	15	568	37.5	-23	0.383	0.679	385.52096	3.848	103.707	194.709	0.125734	
15.5	15.1	409	52.5	-23	0.243	0.770	314.73916	3.846	103.619	138.172	0.125177	
16.5	13.6	109	67.5	-23	0.071	0.853	93.01748	3.880	104.949	0.000		
17.5	12.1	0	82.5	-23	-0.121	0.921	0	3.915	106.293	0.000		
18.5	10.6	0	97.5	-23	-0.319	0.967	0	3.949	107.653	0.000		
19.5	9.8	0	112.5	-23	-0.511	0.992	0	3.968	108.384	0.000		
20.5	9	0	127.5	-23	-0.683	1.000	0	3.987	109.120	0.000		
21.5	8.2	0	142.5	-23	-0.823	0.996	0	4.006	109.861	0.000		

Appendix (A) provides a description of LINGO programs that were developed and values for the solar collector's area, and to assess the economic feasibility and also the environmental positive impact of integrating solar- fossil fuel at different levels. LINGO Programs are based on the optimization formula mentioned in section III.2. The results are summarized in table 4.16 and they are plotted in figures 4.1 to 4.24.

1. The optical losses of the collector's receiver represent 20% of the incident solar radiation; that is because the optical efficiency of the collector is 80% as it is given in Table 1.1. This is a significant loss. Future research efforts should seek to minimize this optical loss by finding other materials of construction for the collectors or better coating materials that have better absorption, lower emittance, and stable response to solar radiation. Also, those optical losses may be reduced by finding better arrangement for the collectors' field that minimize the shadow effect on the non first line.
2. Figure 4.14 shows that the thermal losses of the collectors range from 13% to 27% with the maximum losses as quantity in July and minimum ratio with respect to the absorbed radiation. These losses occur due to heat transfer by conduction through the absorber tubes wall, convection from the absorber's tube wall to the adjacent air, and radiation from the absorber wall to the atmosphere. However, convection losses are decreased by putting the absorber tube into evacuated glass envelopes.
3. Figure 4.17 shows that optimized solar alone power plant with no storage (run 7hrs/day around noon time) can give the required power out put with LEC in the range of 13.9¢/kWe; but that requires a very large area and great capital investment.

Also, there are uncertainties about the stability of power output because of weather changes.

4. Figure 4.18 shows that the best mode of integrating solar- fossil fuel among the different modes studied here is the hybrid all the year using fossil to solar ratio being 0.246; where the prices reached 9.6¢/kWh.
5. By integrating fossil fuel as a backup system (7hrs/day), the power output becomes more stable and reliable since at any time the solar radiation decreases the control system will turn the auxiliary conventional boiler and the fossil fuel boiler will make up this shortage yielding the required conditions
6. Table 4.17 and Fig. 4.19 shows that by integrating TES with the hybrid power supply (solar- fossil) increases the LEC; for 1 hr storage the LEC to increase from 9.6¢/kWh to 11.3¢/kWh then increases in case of 3hrs storage to 11.5 ¢/kWh; then by increasing the storage capacity the LEC increases till it becomes 12¢/kWh. This can be explained by LEC increase by TES since the plant does not operate except 7hrs/day which forces the plant to charge the TES system in only these 7 hrs. Thus, the required area increases considerably. Also the cost of running the storage medium and other pumps increases. Thus the capital cost and the operation cost increase; this increase in the area cost and the storage capital cost is higher than the revenue from the stored energy.

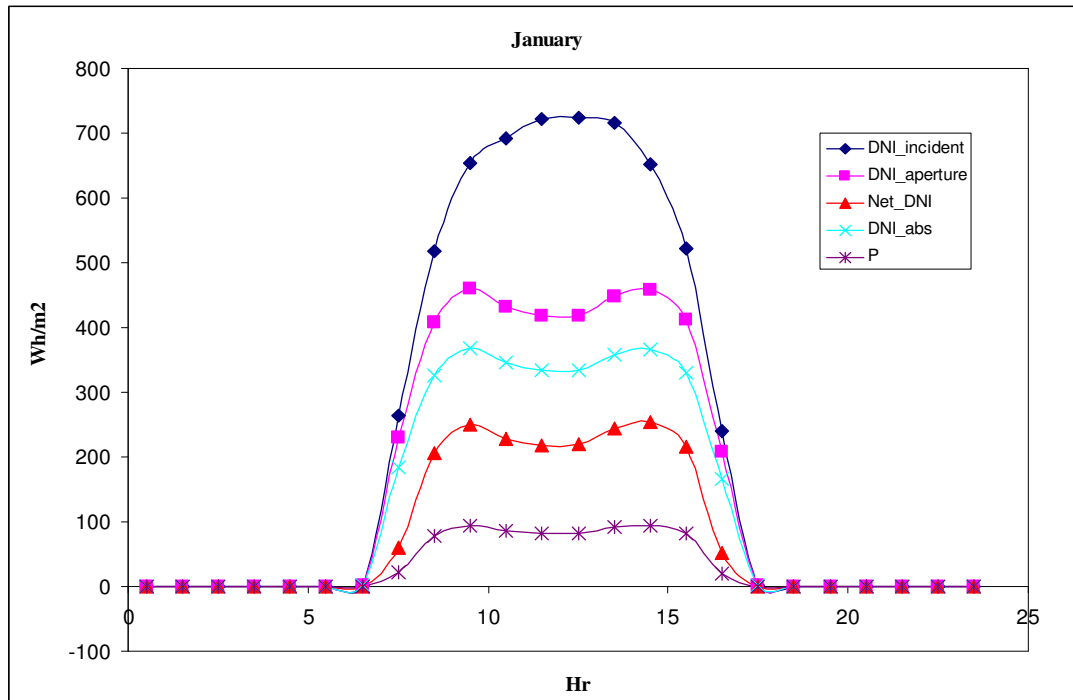

Fig. 4.1 The predicted solar data for January.

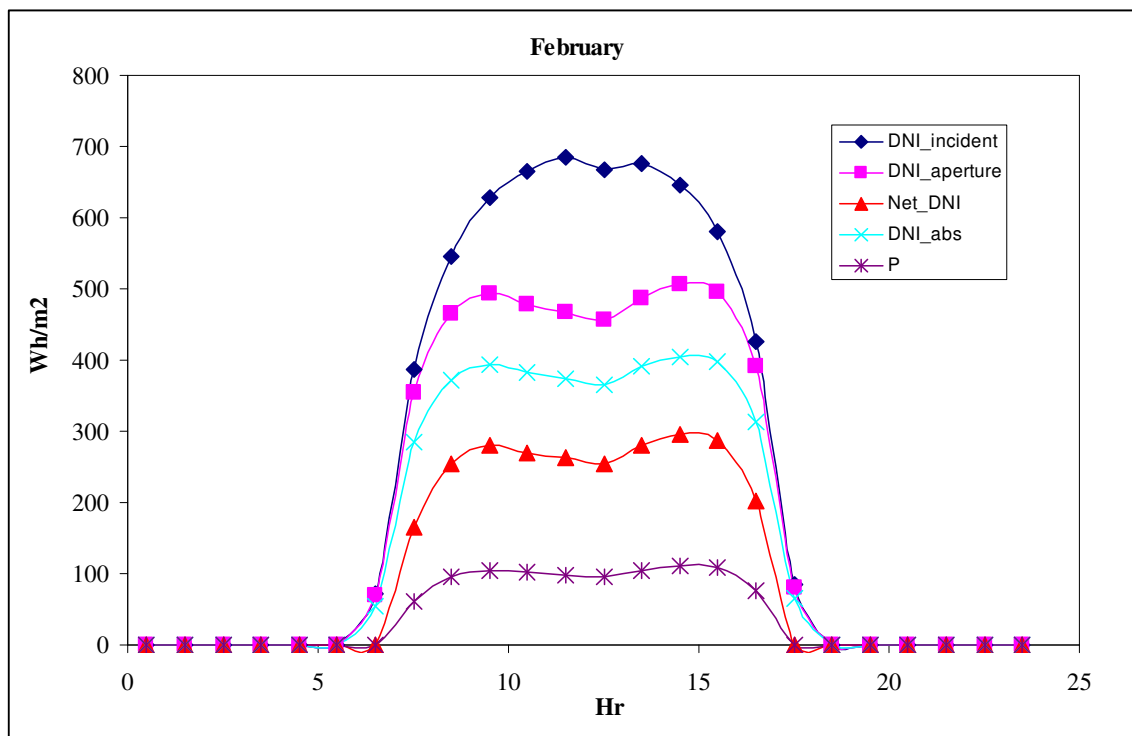

Fig. 4.2 The predicted solar data for February.

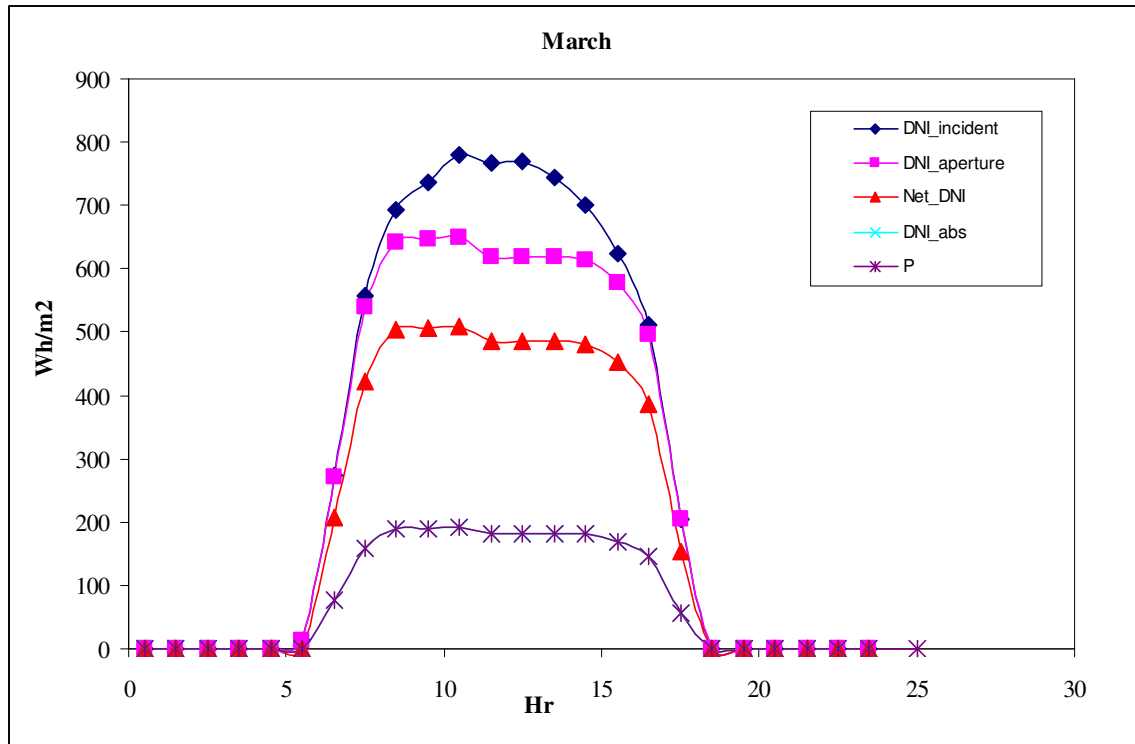

Fig. 4.3 The predicted solar data for March.

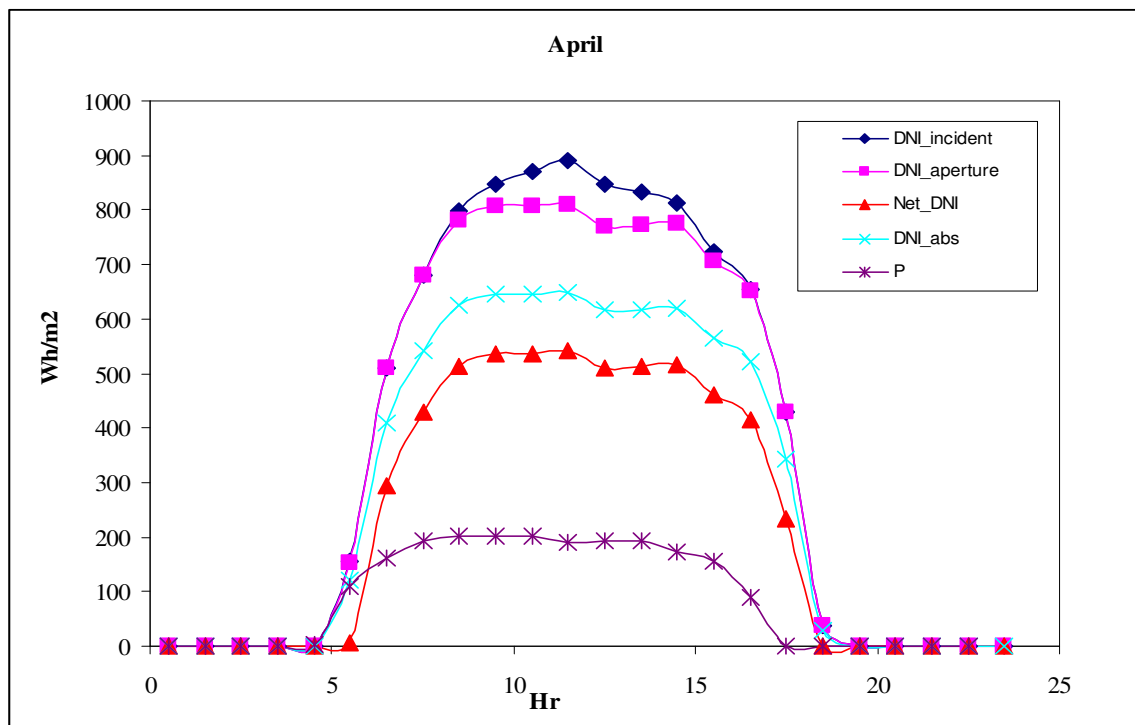

Fig. 4.4 The predicted solar data for April.

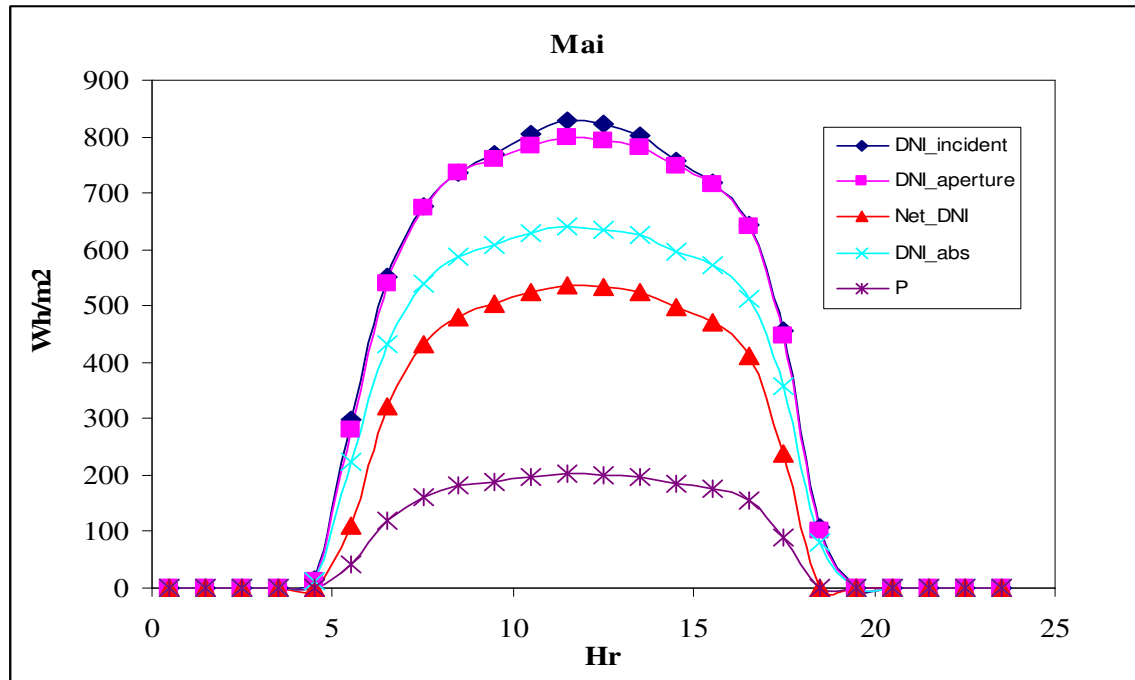

Fig. 4.5 The predicted solar data for May.

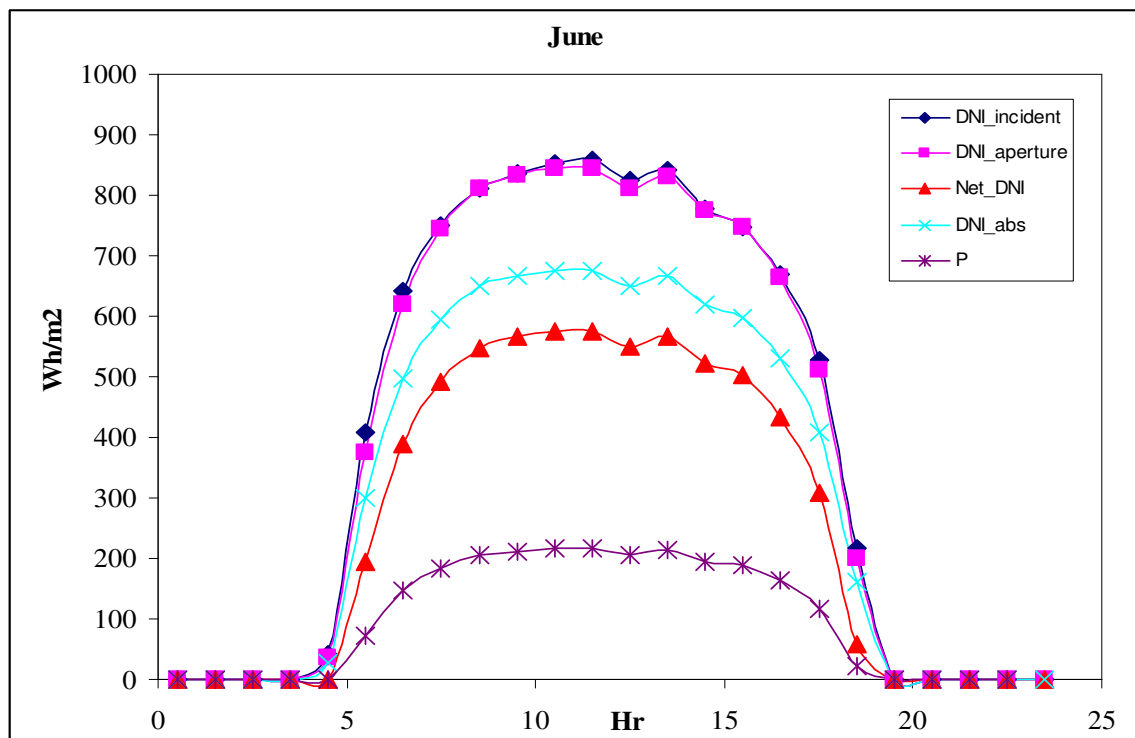

Fig. 4.6 The predicted solar data for June.

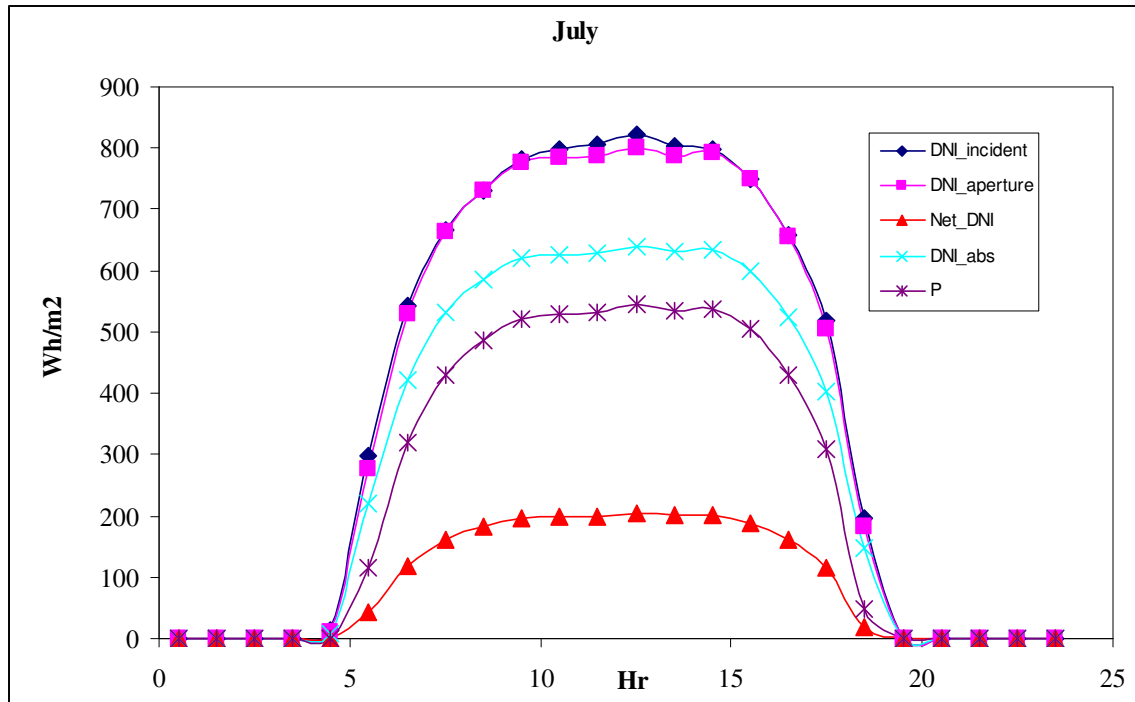

Fig. 4.7 The predicted solar data for July.

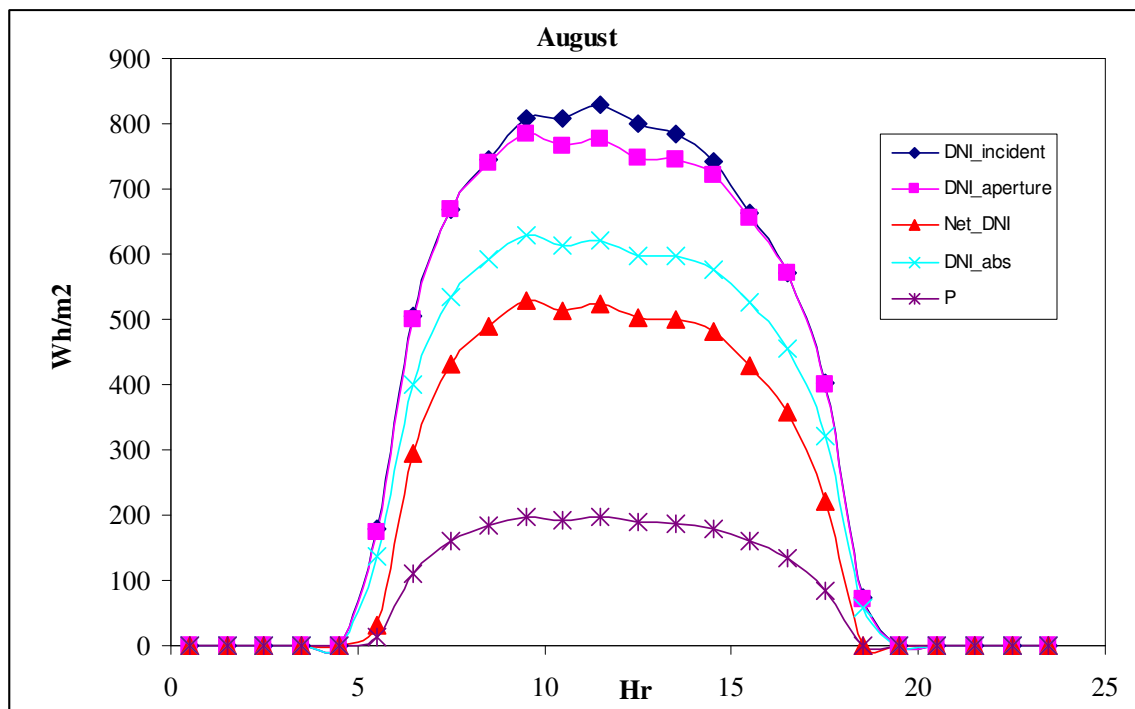

Fig. 4.8 The predicted solar data for August.

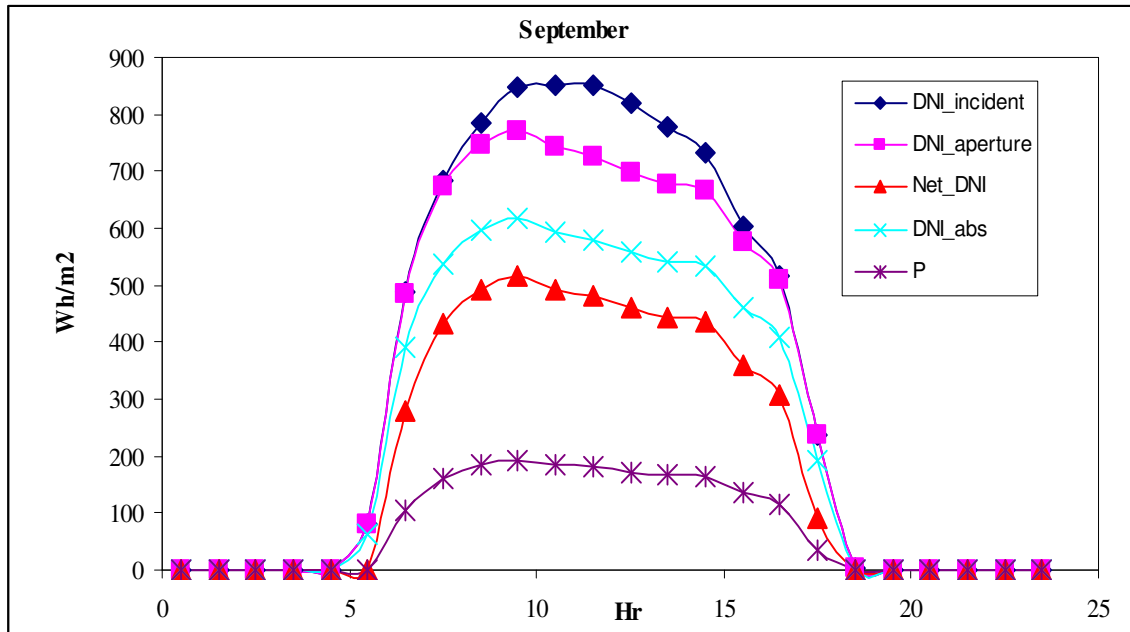

Fig. 4.9 The predicted solar data for September.

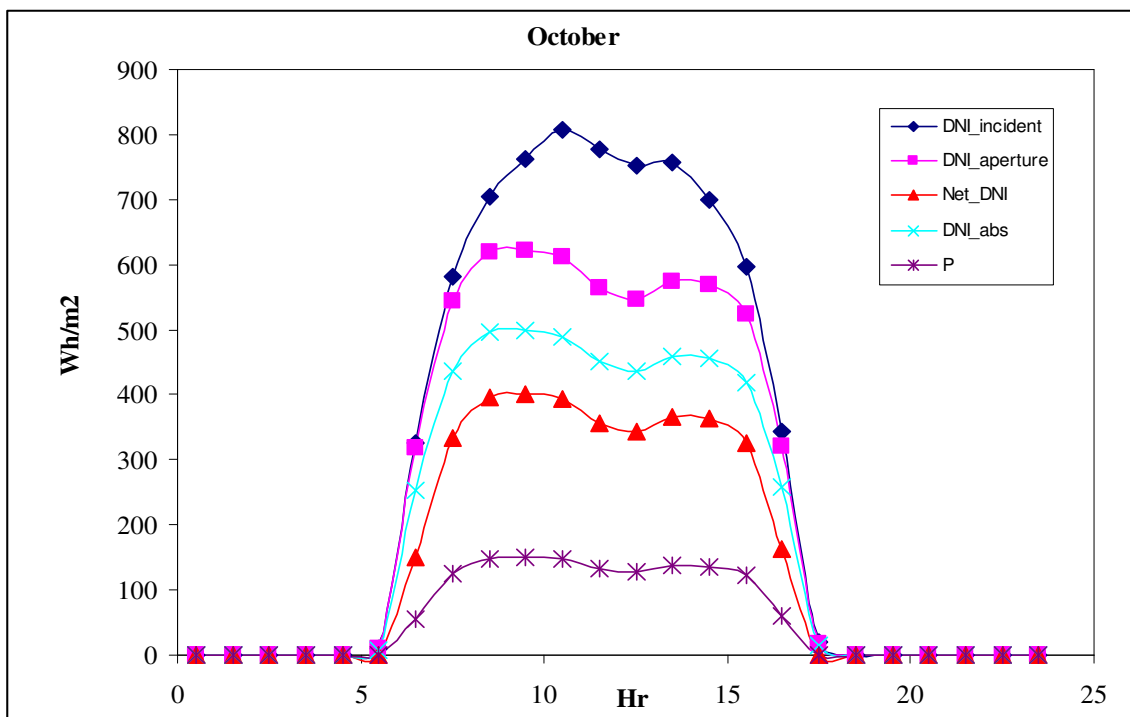

Fig. 4.10 The predicted solar data for October.

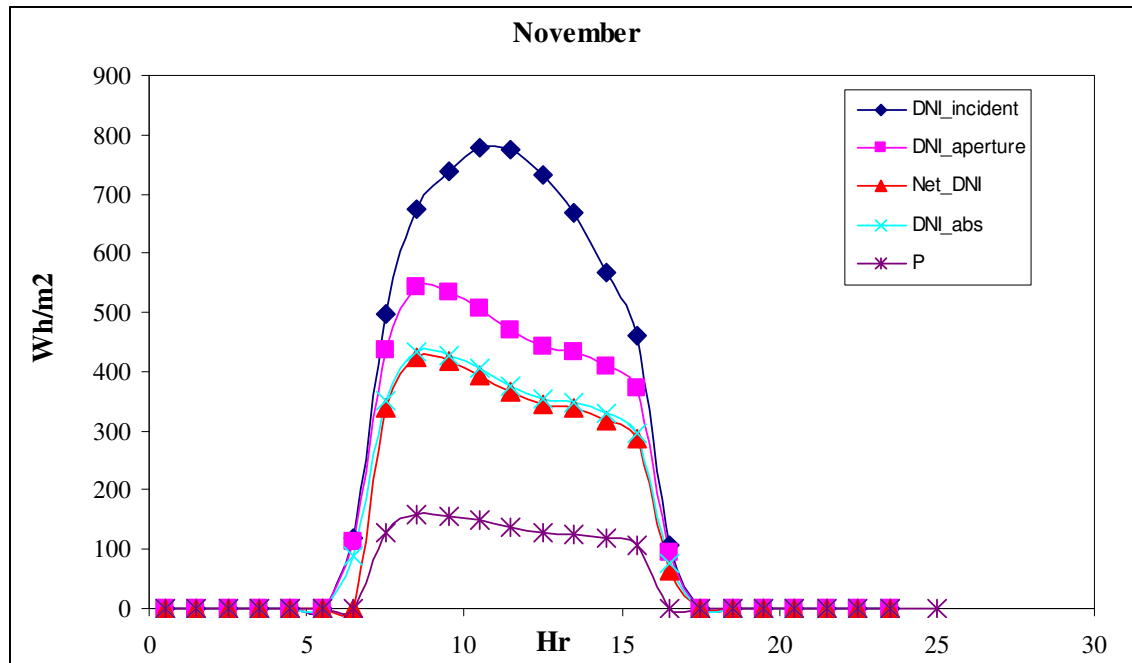

Fig. 4.11 The predicted solar data for November.

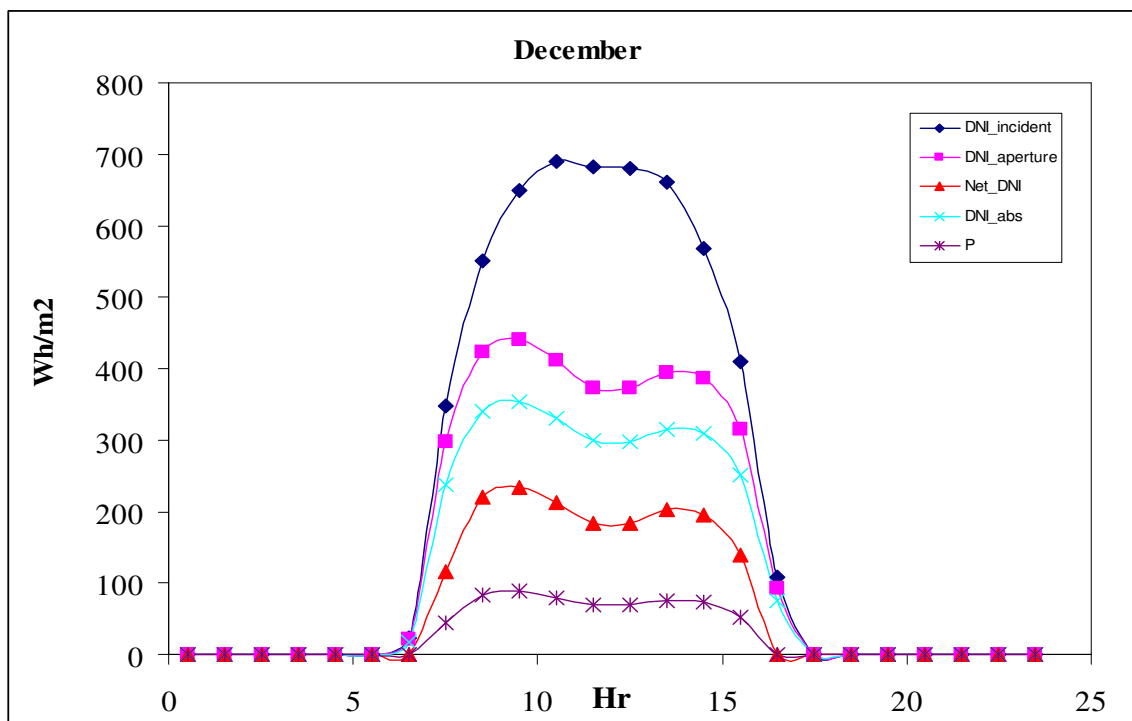

Fig. 4.12 The predicted solar data for December.

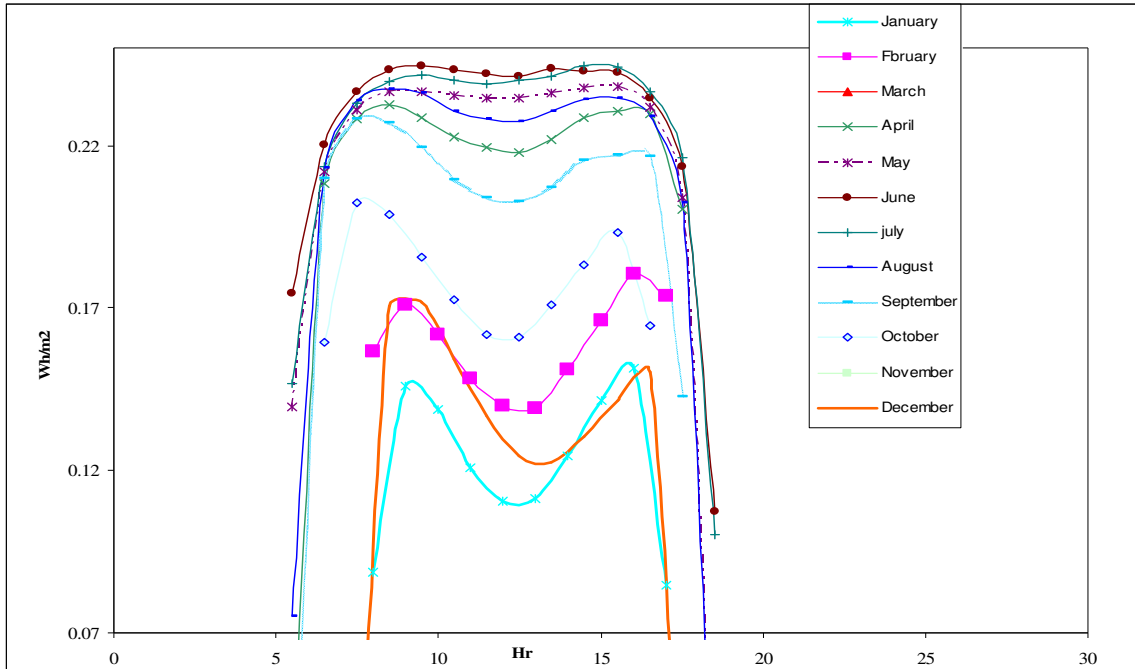

Fig. 4.13 Solar- electric hourly efficiency .

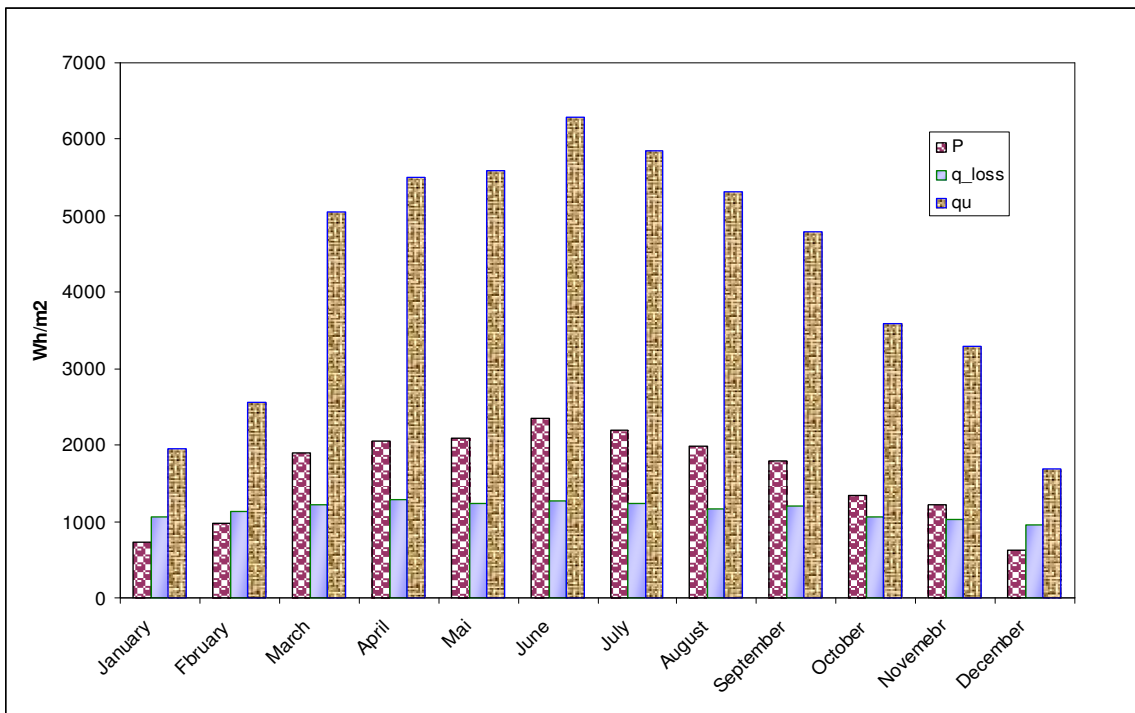

Fig. 4.14 Annually maximum predicted useful solar radiation, absorber thermal losses and power per square meter of collector surface area.

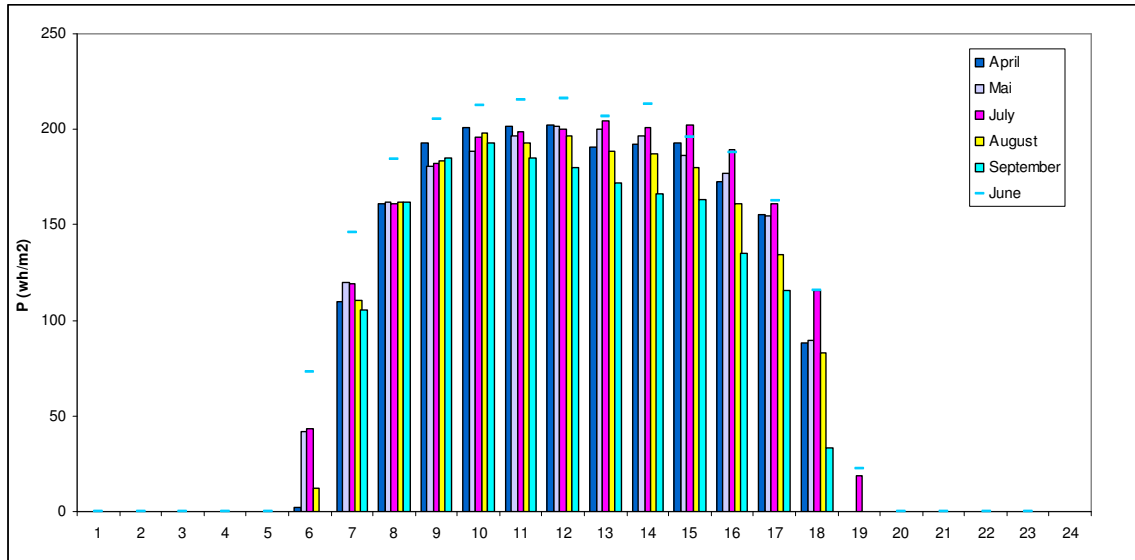

Fig. 4.15 Summer hourly maximum predicted power per square meter of collector.

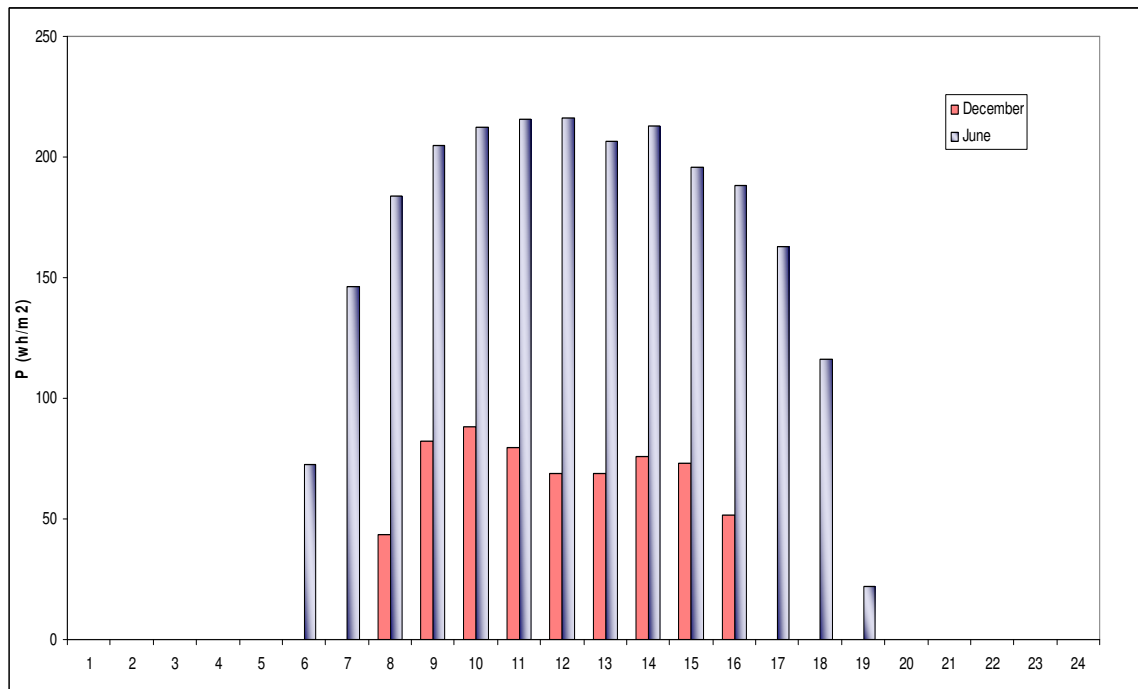

Fig. 4.16 Comparison between the maximum predicted power in June and the minimum predicted power in December.

Table 4.16 Summary of the optimization results.

Case	Area Km ²	Elec GWhe/y	LEC ¢/kWh	Fuel Saver ft ³ /y	CO2 Reduction	Full load Hours	Solar Capacity %	R
A - (7Hrs/day)								
Solar alone								
Full load all year	727	224	13.9	742.5	218	4481	51.15	0
Full load summer	307	94	15.2	313.4	92	1281		0
Full load summer 75% load winter	491	151	14.0	501	147			0
Solar + Fossil Fuel								
Fossil winter no_op	317	112.9	13.8	374.1	95	2258	26	0.2
Fossil Winter _A	307	110	13.7	366.8	92	2214	25.3	0.2

Table 4.16 Continued.

Case	Area Km²	Elec GWhe/y	LEC ¢/kWh	Fuel Saver ft³/y	CO₂ Reduction	Full load Hours	Solar Capacit y %	R
Fossil all year no_op	245	144	9.8	478	73	2885	33	0.2
Fossil all year _LEC	239	146	9.7	483.7	72	2920	33	0.2
Solar + Fossil Fuel + TES								
1 Hrs TES	304	129	11.3	426.4	91	2418		0.33
3 Hrs TES	336	142.4	11.5	471.9	101	2621		0.33
6 Hrs TES	391	165.4	11.7	548	117	3096		0.33
9 Hrs TES	449	190	11.9	134.6	140	3599.8		0.33
12 Hrs TES	511	216.1	12.0	716.1	153	4146		0.33

Table 4.16 Continued.

Case	Area Km²	Elec GWhe/y	LEC ¢/kWh	Fuel Saver ft³/y	CO₂ Reduction	Full load Hours	Solar Capacity %	R
15 Hrs TES	635	262.1	12.0	868.5	191	4737.3		0.30
(B) Plant Run All Sunshine Hours Daily								
Solar + Fossil Fuel								
TES	304	183	9.4	608	91.2	3670	41.9	0.33
Solar + Fossil Fuel + TES								
1 Hrs TES	377	227	7.3	753	113	4546	51.9	0.33
3 Hrs TES	387	233	7.3	774	116	4673	53.3	0.33
6 Hrs TES	416	251	7.2	833	124.9	5028	57.4	0.33
9 Hrs TES	457	275.6	7.1	913	137	5512	63	0.33
12 Hrs TES	500	301.5	7.0	999	149	6030	69	0.33
15 Hrs TES	574	346.3	6.8	1147	170	6926	79	0.33

7. Figures 4.20 and 4.21 show that integrating TES with a solar- fossil power plant running 7hrs/d has prices higher than those in the case of integration TES with solar-fossil with the power plant running during all the sunshine hours.
8. Figure 4.21 shows that by considering all the sun shine hours and running the power plant all the day hours, the LEC decreases. That may be explained by more revenue due to more power collected, since there are already collectors with certain area, which can collect solar radiation all the day or only 7hrs. It seems from the results that maximize the hours of collecting solar radiation lead to an increase in the power and decrease in the LEC.
9. Figure 4.23 shows that by integrating the thermal energy storage to this system running all the useful hours of day time, the LEC decreases much by increasing the storage capacity until it reached 6.8¢/kWe at 15hrs/day storage. This may be explained by maximizing the benefit of the units of the whole system; the operation cost of the solar system is much less than the capital cost; thus operating the solar collection system and the storage system are not much affected. However, the more power collected improve the cost decreasing the LEC.
10. Thermal energy storage for 15hrs/day may be more than what is actually needed to run the plant continuously. Thus, this energy can be used to heat the solar field at the night hours to reduce the start up time in the next day. Also, generally if there is unused energy in the storage it is because it is less than the required capacity to run the plant or it is higher than the needed. Therefore, it can be used to heat the solar field at night in the winter to prevent freezing.

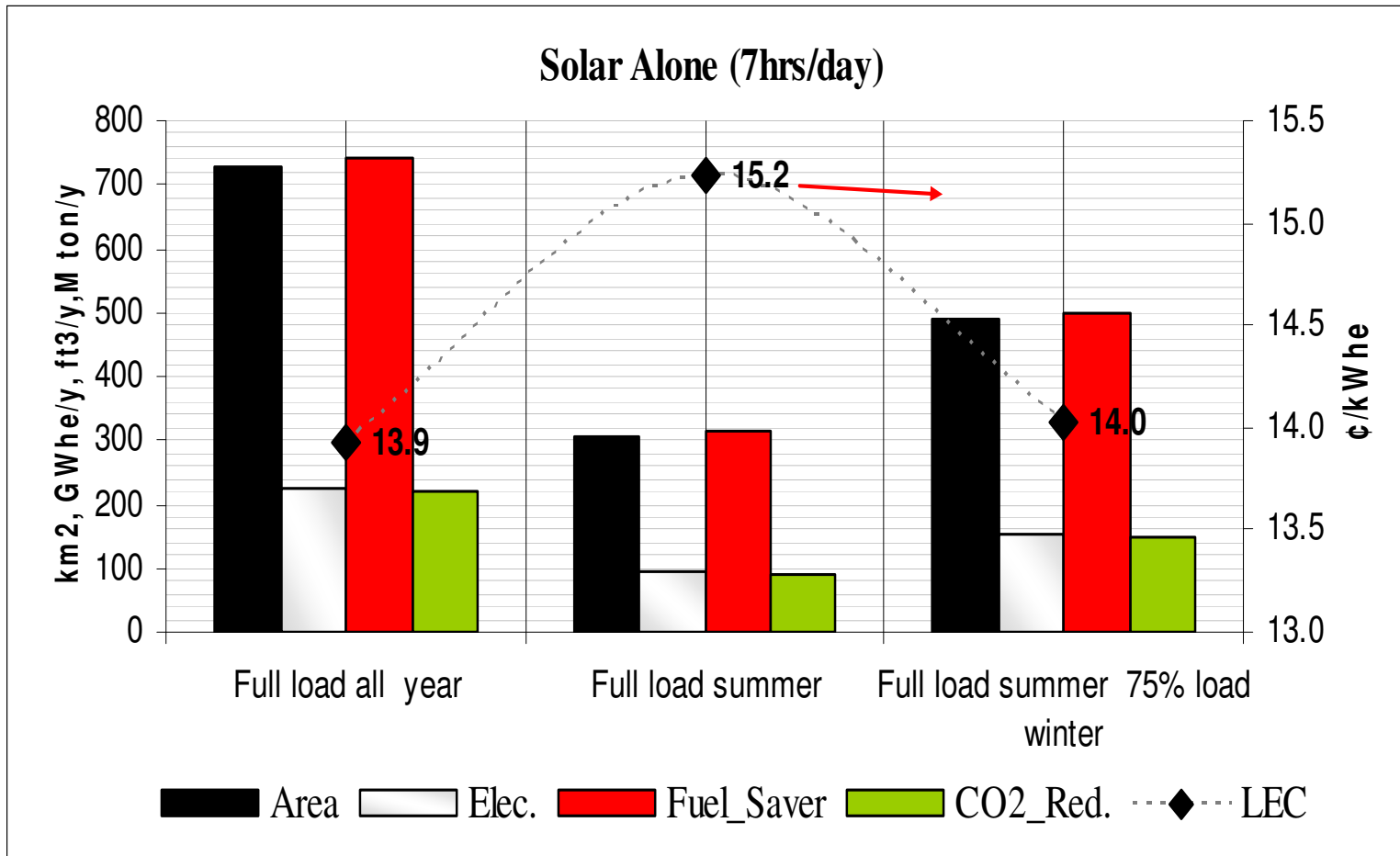

Fig. 4.17 The results of first level of integration (Solar Alone) at different modes of operation for a base design of 7 hrs/day.

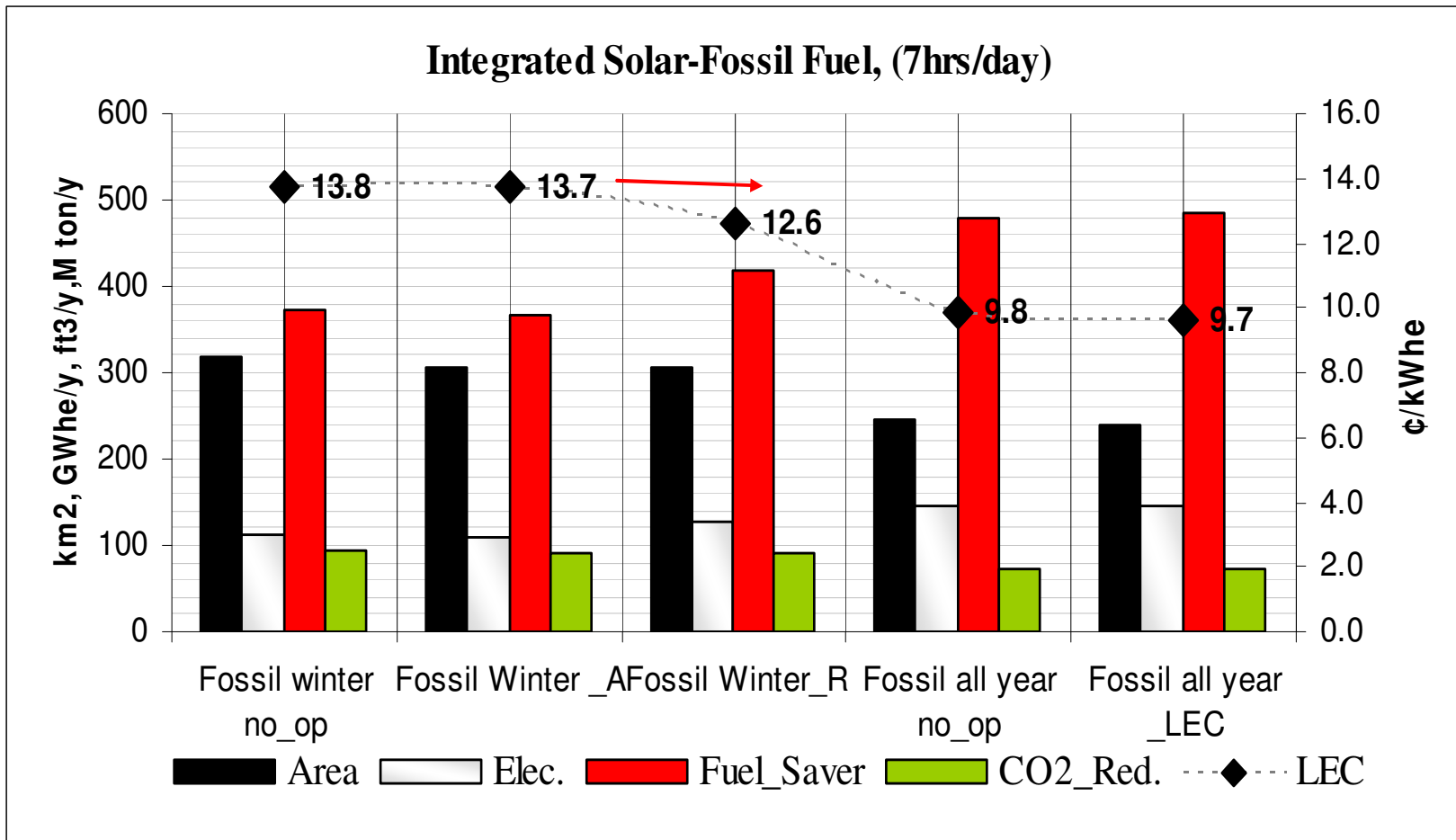

Fig. 4.18 Results of solar-fossil integration at different modes of operation for plant run 7hrs/day.

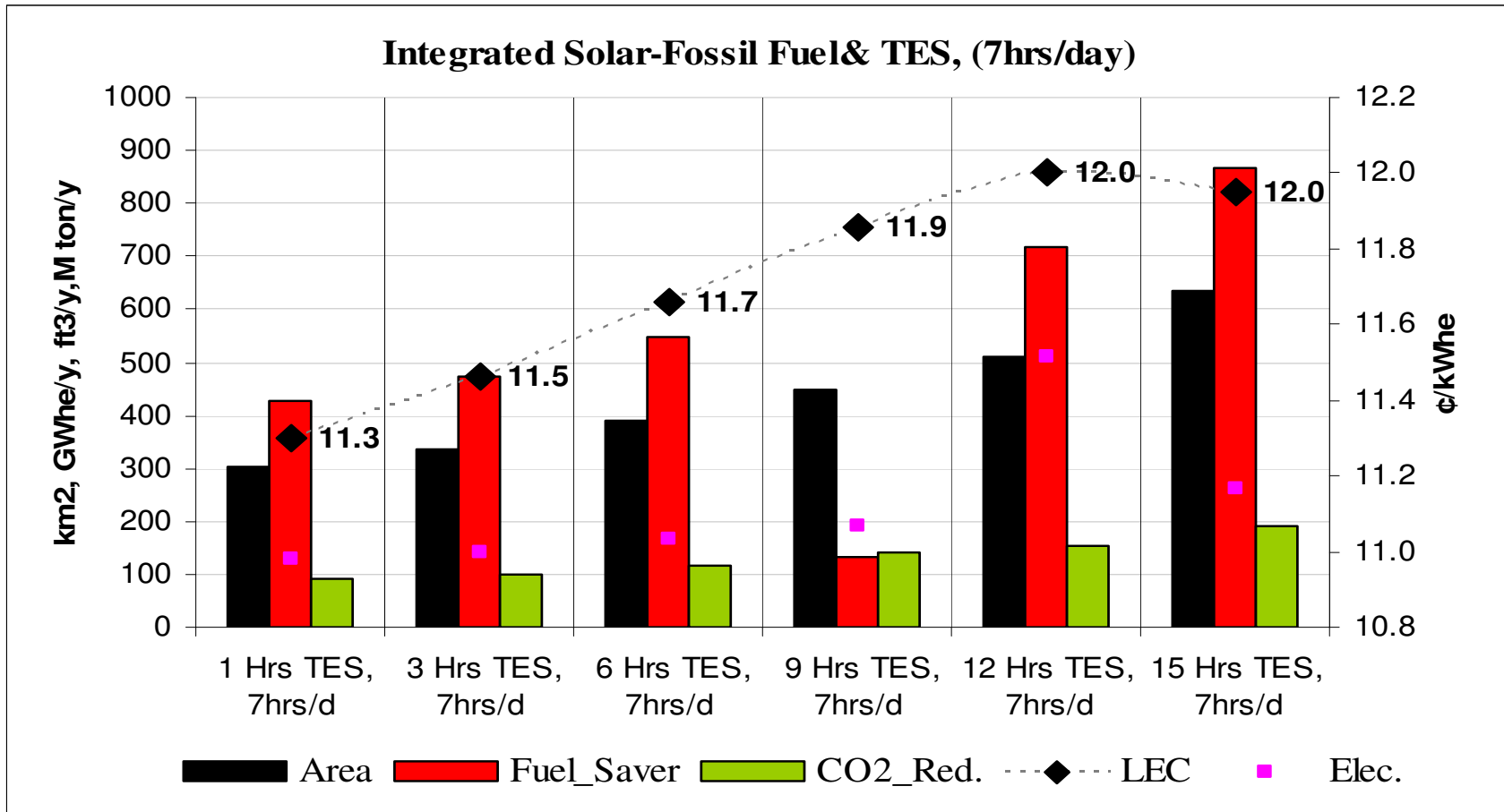

Fig. 4.19 The optimization results of solar- fossil- TES integration at different modes of operation for plant run 7hrs/day.

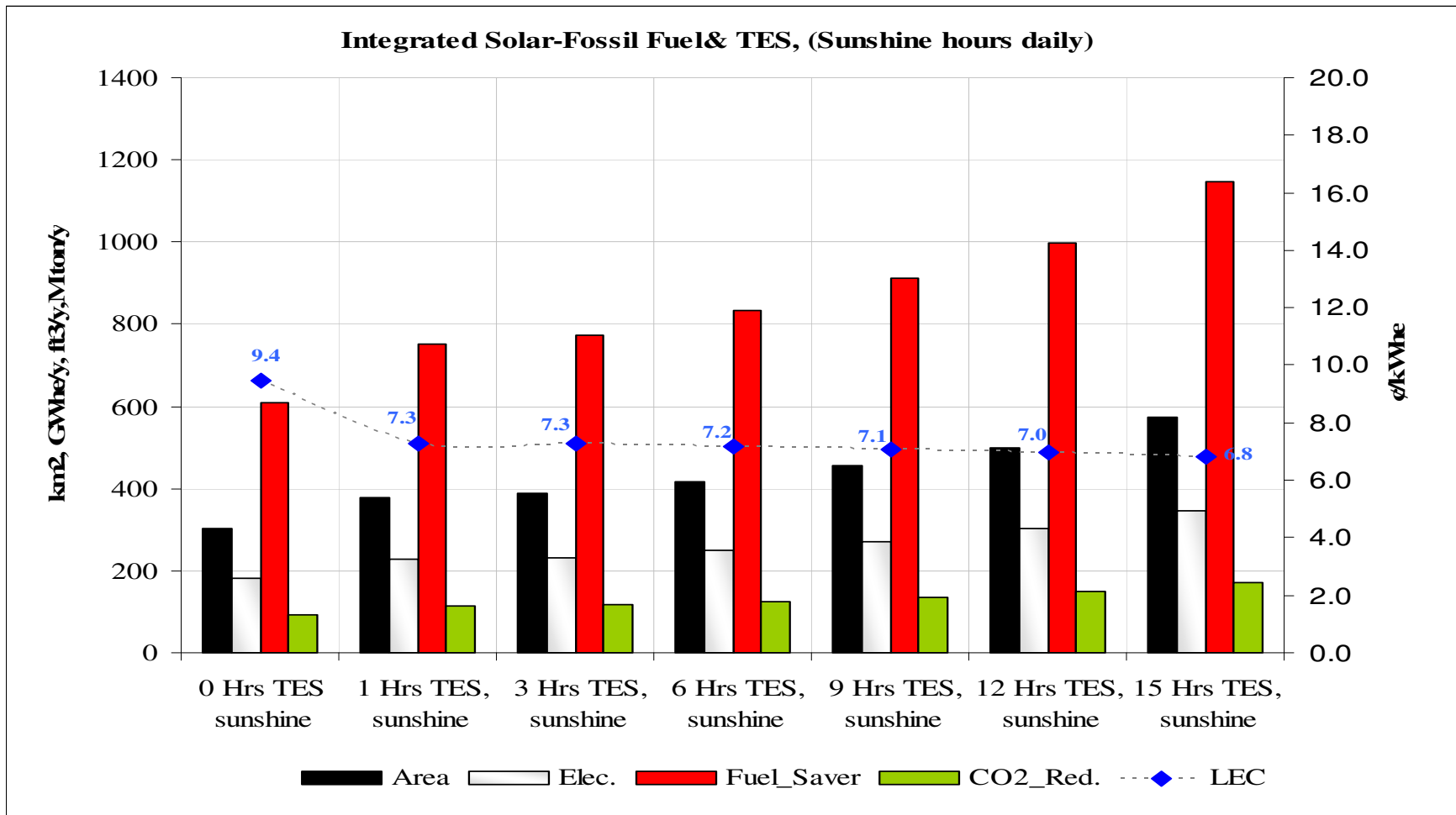

Fig. 4. 20 The optimization results of fourth case of integration (solar, fossil, TES) at different modes of operation for design base of all sunshine hours daily.

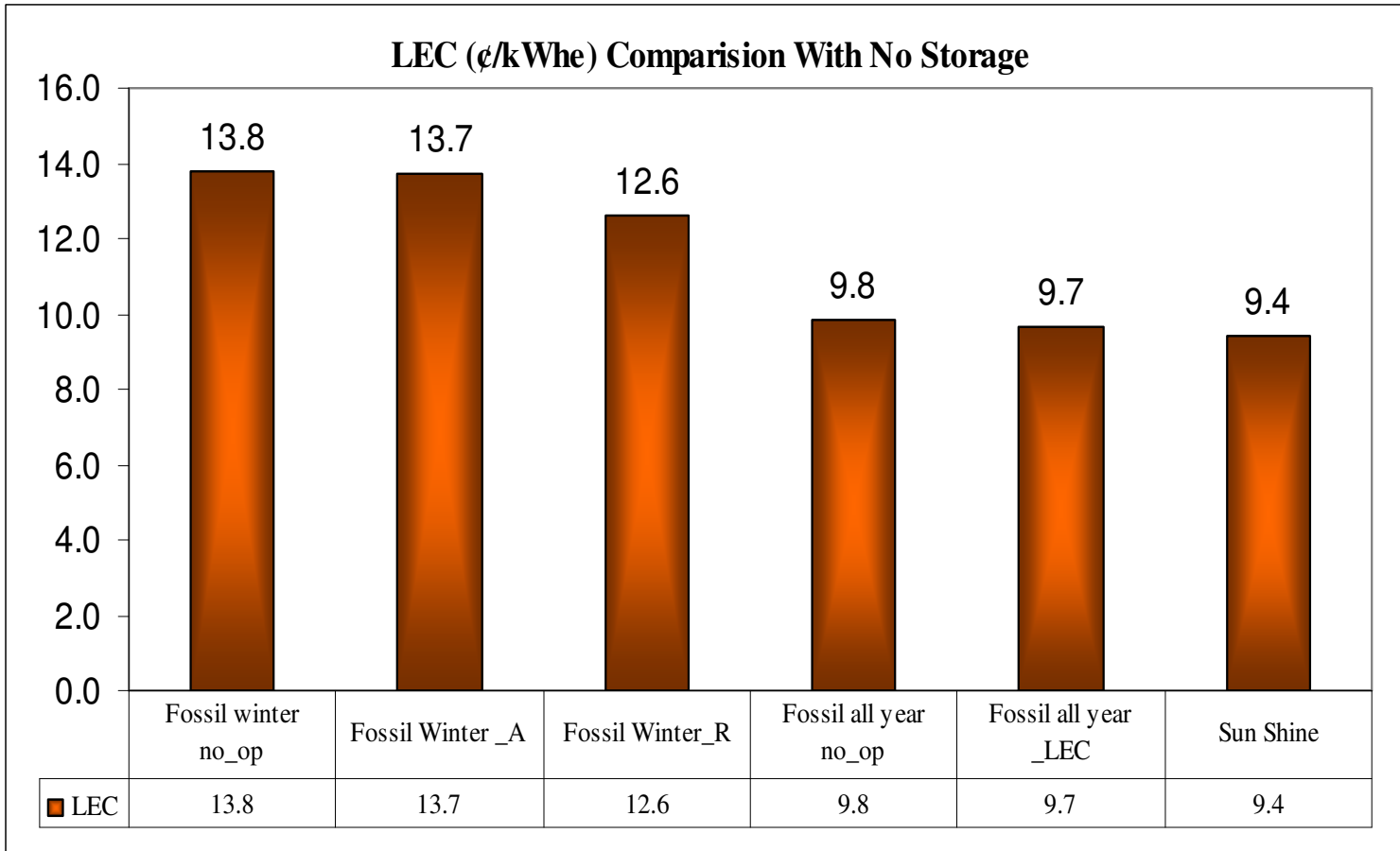

Fig. 4.21 Comparison between the LEC for all optimum integration levels (with no storage).

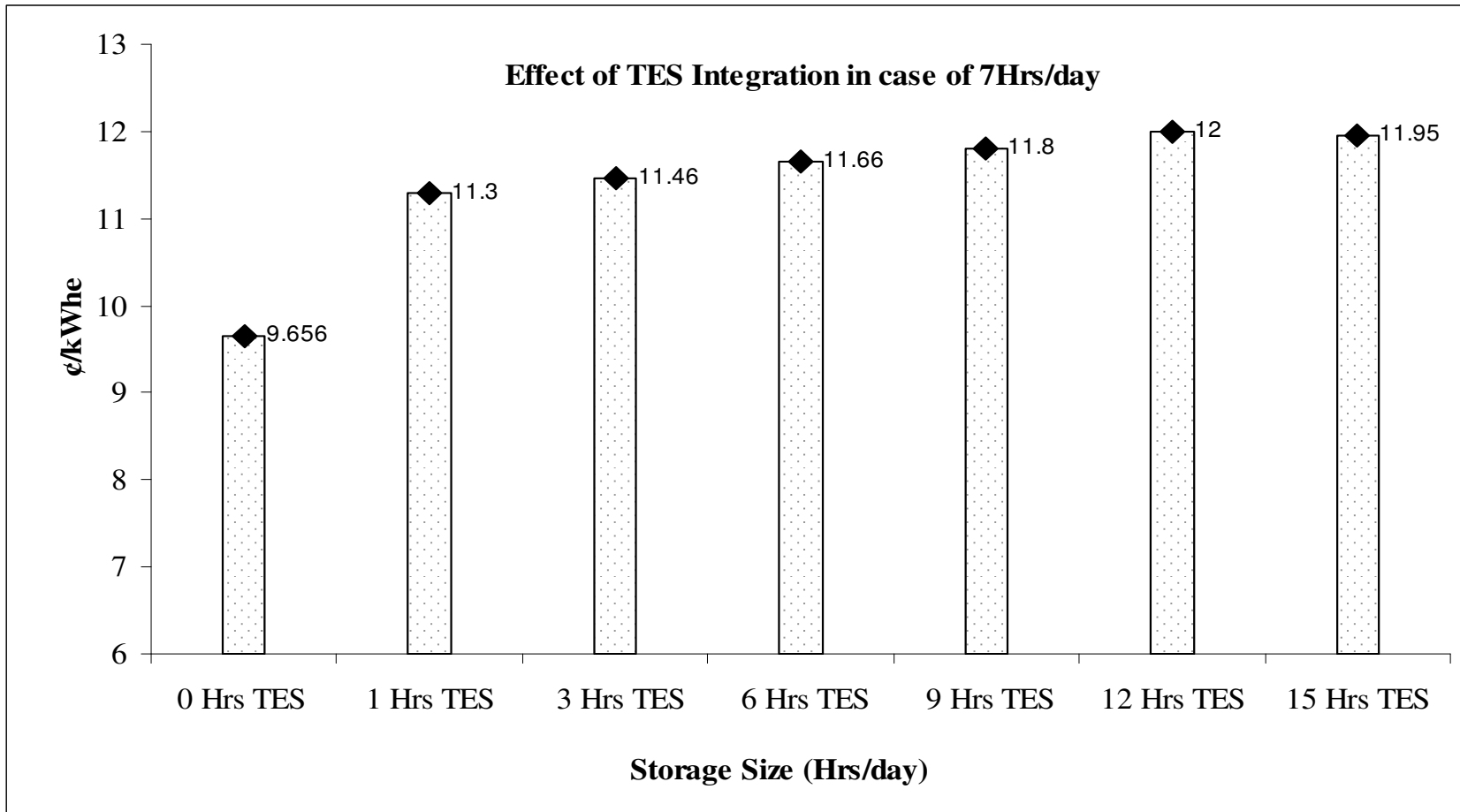

Fig. 4.22 Effect of integrating TES to solar- fossil power supply on the LEC for the 7hrs/day base design.

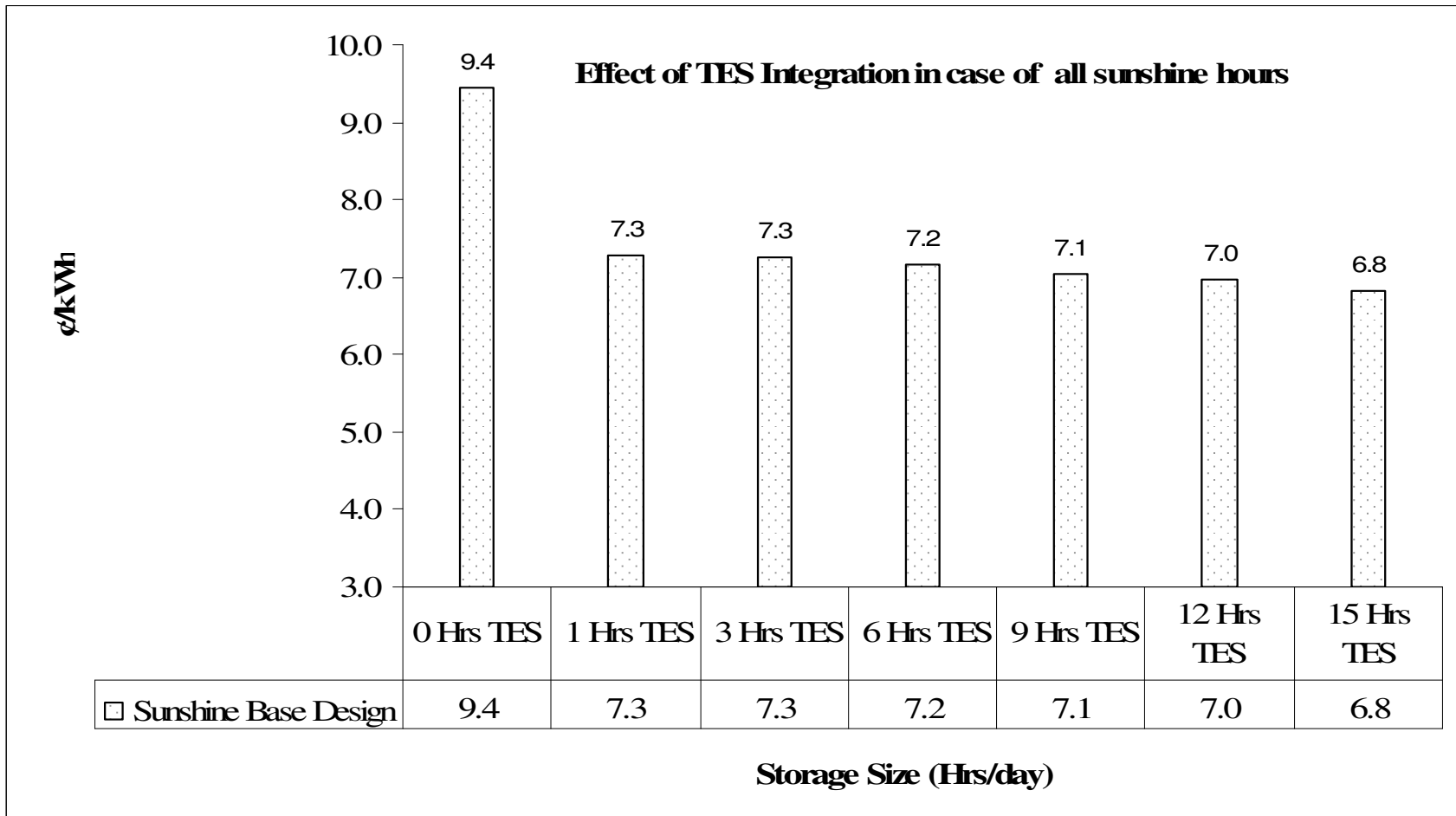

Fig. 4.23 Effect of integrating TES to solar- fossil power supply on the LEC for the sunshine hours base design.

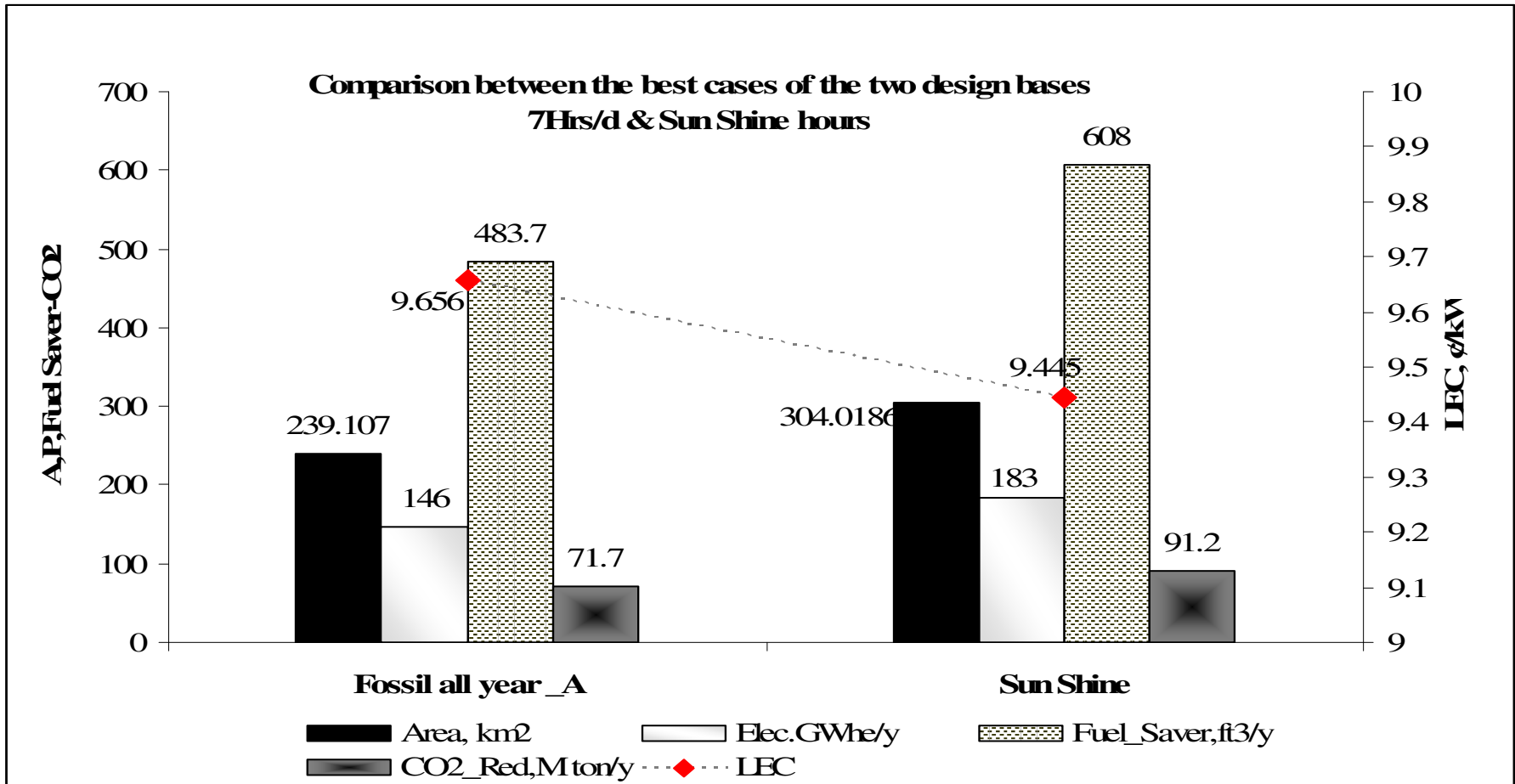

Fig. 4.24 Comparison between the best cases among the two base design.

Table 4.18 Optimum solar- fossil fuel integration hourly schedule for 7Hrs/day design around noon time.

January	Solar	Fossil	Sum	February	Solar	Fossil	Sum	March	Solar	Fossil	Sum	April	Solar	Fossil	Sum
	18502.1	31497.9	50000		22896.9	27103.1	50000		45069.3	4930.71	50000		45908.6	4091.45	50000
	22363.7	27636.3	50000		25082.3	24917.7	50000		45430.3	4569.66	50000		47821.4	2178.59	50000
	20522.6	29477.4	50000		24245.5	25754.6	50000		45430.3	4569.66	50000		48060.5	1939.48	50000
	19592.4	30407.6	50000		23504.2	26495.8	50000		45430.3	4569.66	50000		48299.6	1700.38	50000
	19769.4	30230.6	50000		22834.7	27165.3	50000		43278.4	6721.62	50000		45669.5	4330.55	50000
	21930.9	28069.1	50000		25144.5	24855.5	50000		43278.4	6721.62	50000		45908.6	4091.45	50000
	22705.6	27294.4	50000		26469.2	23530.9	50000						46123.8	3876.25	50000
May	Solar	Fossil	Sum	June	Solar	Fossil	Sum	July	Solar	Fossil	Sum	August	Solar	Fossil	Sum
	43039.3	6960.73	50000		49017	983.055	50000		43469.7	6530.34	50000		43756.6	6243.41	50000
	44952.1	5047.88	50000		50690.7	0	50690.7		46841.1	3158.93	50000		47104.1	2895.91	50000
	46865	3135.02	50000		51408	0	51408		47486.7	2513.34	50000		45908.6	4091.45	50000
	48060.5	1939.48	50000		51623.2	0	51623.2		47773.6	2226.41	50000		46865	3135.02	50000
	47821.4	2178.59	50000		49256.1	743.948	50000		48873.5	1126.52	50000		44952.1	5047.88	50000
	46865	3135.02	50000		50929.8	0	50929.8		47821.4	2178.59	50000		44713	5286.98	50000

Table 4.18 Continued.

	Solar	Fossil	Sum		Solar	Fossil	Sum		Solar	Fossil	Sum		Solar	Fossil	Sum
	44473.9	5526.09	50000		46625.9	3374.13	50000		48275.7	1724.29	50000		43039.3	6960.73	50000
September	Solar	Fossil	Sum	October	Solar	Fossil	Sum	November	Solar	Fossil	Sum	December	Solar	Fossil	Sum
	44856.5	5143.52	50000		35387.8	14612.2	50000		37778.9	12221.1	50000		19606.8	30393.2	50000
	46147.7	3852.34	50000		35866.1	14133.9	50000		37300.7	12699.3	50000		21041.4	28958.6	50000
	43995.7	6004.3	50000		35148.7	14851.3	50000		35387.8	14612.2	50000		18889.5	31110.5	50000
	42800.2	7199.84	50000		31801.2	18198.8	50000		32518.6	17481.4	50000		16450.6	33549.4	50000
	41126.4	8873.59	50000		30605.7	19394.3	50000		30844.8	19155.2	50000		16498.4	33501.6	50000
	39691.8	10308.2	50000		32757.7	17242.3	50000		30127.5	19872.5	50000		17933	32067	50000
	38974.5	11025.6	50000						28453.7	21546.3	50000		17454.8	32545.2	50000

Table 4.19 Optimum solar-fossil fuel integration hourly schedule for sunshine hours base design.

	Solar	Fossil	Sum		Solar	Fossil	Sum		Solar	Fossil	Sum
January	6688.41	43311.6	50000	February	18776.2	31223.8	50000	March	23613.1	26386.9	50000
	23525	26475	50000		29112.8	20887.2	50000		48034.9	1965.06	50000
	28434.9	21565.1	50000		31891.6	18108.5	50000		57304.5	0	57304.5
	26093.9	23906.1	50000		30827.5	19172.5	50000		57763.5	0	57763.5
	24911.3	25088.7	50000		29885	20115	50000		57763.5	0	57763.5
	25136.3	24863.7	50000		29033.8	20966.2	50000		55027.4	0	55027.4
	27884.6	22115.4	50000		31970.6	18029.4	50000		55027.4	0	55027.4
	28869.6	21130.4	50000		33654.9	16345.1	50000		55027.4	0	55027.4
	24710.6	25289.4	50000		32803.6	17196.4	50000		54723.4	0	54723.4
	5910.12	44089.9	50000		23011.2	26988.8	50000		51379.2	0	51379.2
									43778.7	6221.32	50000
									17447.6	32552.4	50000
	Solar	Fossil	Sum		Solar	Fossil	Sum		Solar	Fossil	Sum
April	608.037	49392	50000	May	12464.8	37535.2	50000	June	22102.2	27897.9	50000
	33138	16862	50000		36482.2	13517.8	50000		44386.7	5613.28	50000
	48947	1053	50000		48947	1053	50000		55939.4	0	55939.4
	58371.6	0	58371.6		54723.4	0	54723.4		62323.8	0	62323.8
	60803.7	0	60803.7		57155.5	0	57155.5		64452	0	64452
	61107.7	0	61107.7		59587.7	0	59587.7		65364	0	65364
	61411.8	0	61411.8		61107.7	0	61107.7		62627.8	0	62627.8

Table 4.19 Continued.

	Solar	Fossil	Sum						Fossil	Sum	Solar
	58067.6	0	58067.6		60803.7	0	60803.7		64756	0	64756
	58371.6	0	58371.6		59587.7	0	59587.7		59283.6	0	59283.6
	58669.5	0	58669.5		56547.5	0	56547.5		57155.5	0	57155.5
	Solar	Fossil	Sum		Solar	Fossil	Sum		Solar	Fossil	Sum
	52291.2	0	52291.2		53507.3	0	53507.3		49251	748.984	50000
	47244.5	2755.51	50000		46818.9	3181.13	50000		49251	748.984	50000
	26753.6	23246.4	50000		27209.7	22790.3	50000		35235.8	14764.2	50000
	Solar	Fossil	Sum		Solar	Fossil	Sum		Solar	Fossil	Sum
July	13255.2	36744.8	50000	August	3648.22	46351.8	50000	September	6776.58	43223.4	50000
	36299.8	13700.2	50000		33442.1	16558	50000		31922	18078.1	
	48855.8	1144.21	50000		48947	1053	50000		48947	1053	
	55270.6	0	55270.6		55635.4	0	55635.4		55939.4	0	
	59557.3	0	59557.3		59891.7	0	59891.7		58675.6	0	
	60378.1	0	60378.1		58371.6	0	58371.6		55939.4	0	
	60742.9	0	60742.9		59587.7	0	59587.7		54419.3	0	
	62141.4	0	62141.4		57155.5	0	57155.5		50467.1	0	
	60803.7	0	60803.7		56851.5	0	56851.5		49555	444.966	
	61381.4	0	61381.4		54723.4	0	54723.4		41042.5	8957.49	
	57550.7	0	57550.7		48643	1357.02	50000		34962.1	15037.9	
	48947	1053	50000		40738.5	9261.51	50000		10032.6	39967.4	
	34962.1	15037.9	50000		25233.6	24766.5	50000				
	5624.34	44375.7	50000								

Table 4.19 Continued.

	Solar	Fossil	Sum		Solar	Fossil	Sum		Solar	Fossil	Sum
October	17085.9	32914.2	50000	November	38610.4	11389.6	50000	December	13072.8	36927.2	50000
	38002.3	11997.7	50000		48034.9	1965.06	50000		24929.5	75070.5	100000
	44994.8	5005.25	50000		47426.9	2573.1	50000		26753.6	23246.4	50000
	45602.8	4397.21	50000		44994.8	5005.25	50000		24017.5	25982.5	50000
	44690.7	5309.26	50000		41346.5	8653.47	50000		20673.3	29326.7	50000
	40434.5	9565.52	50000		39218.4	10781.6	50000		20977.3	29022.7	50000
	38914.4	11085.6	50000		38306.4	11693.7	50000		23014.2	26985.8	50000
	Solar	Fossil	Sum		Solar	Fossil	Sum		Solar	Fossil	Sum
	41650.6	8349.45	50000		36178.2	13821.8	50000		22193.4	27806.6	50000
	41346.5	8653.47	50000		32530	17470	50000		15748.2	34251.8	50000
	37090.3	12909.7	50000								
	18241.1	31758.9	50000								

CHAPTER V

CONCLUSIONS AND RECOMMENDATIONS

V.1. Conclusions

A systematic procedure has been introduced for the design and integration of solar systems whereby the solar energy may be used directly, or stored via thermal storage systems, or used in conjunction with a fossil fuel. Different alternatives were modeled, assessed, and optimized. The developed procedure includes a combination of gathering and generation of certain required data, modeling the various components, analyzing different scenarios and configurations, optimizing system performance, and estimating the system economics. A case study has been solved to illustrate the applicability of the developed procedure and to evaluate the results. Findings from the case study point to the following conclusions:

- Solar energy is a promising technology and introducing integrated solar-fossil systems offers much potential for large-scale applicability with stable power supply.
- The LEC of the solar electricity is reduced by optimizing the extent of integrating solar energy with fossil fuels and optimizing the number of hours of solar collection and storage.
- The best mode of integrating solar/fossil fuel among the different modes studied here was found to be the hybrid all the year using fossil to solar ratio being 0.246; where the prices reached 9.6¢/kWh.

- Integrating TES with the hybrid power supply (solar/fossil) increases the LEC; for 1 hr storage the LEC to increase from (9.6¢/kWh) to (11.3¢/kWh) then increases in case of 3hrs storage to (11.46¢/kWh); then by increasing the storage capacity the LEC increases. This can be explained by LEC increase by TES size increase since the plant does not operate except 7hrs/day which forces the plant to charge the TES system in only these 7 hrs. Thus, the required area increases considerably. Also the cost of running the storage medium and other pumps increases.

- Although the power generated by the solar-fossil hybrid system is more expensive than that commercially generated by fossil fuels ((9.6¢/kWh for the hybrid versus 3.0-5.0 ¢/kWh for the fossil), there are significant environmental and sustainability merits for using the solar system. For instance, the operation of a solar system is virtually free of greenhouse gas emissions. As such, if there are carbon credits, the cost gap between the solar and the fossil energies can readily diminish.

- Integrating TES with hybrid system running all the useful sunshine hours reduce the LEC from 9.445¢/kWh to 7.259¢/kWh in case of 1hr storage, 7.259¢/kWh in case of 3hrs storage, 7.166 ¢/kWh in case of 6 hrs storage, 7.05 ¢/kWh in case of 9 hrs storage, 6.96 ¢/kWh and 6.83 ¢/kWh in case of 15 hrs storage. This reduction in LEC can be explained by that the cost of the storage system is covered by the revenue of the plant running like 10 to 12 hrs daily in summer also that that can be explained by that integrating TES system for a plant run all the useful sunshine hours daily will require a limited over sizing that cost is affordable by the revenue and also the storage charging occurs through long time decreasing the over sizing required. In addition to that as more solar energy collected through more hours, more fossil is used thus improve the price.

V.2. Future Work

1. Minimizing the optical losses of the collectors receiver.
2. Minimize the thermal losses of the collectors absorber.
3. Decreasing the pipeline losses by finding the optimum plant layout and insulation requirements that give minimum losses from the pipelines.
4. Studying the properties of integration and optimization of the material of solar collector especially the coating and the heat transfer fluid.
5. Development of design and optimization techniques for the use of solar energy in cooling applications. This will involve the development of cooling cycles that partially or completely use solar energy. As such, the research will move from co-generation to tri-generation.
6. Modification of process design and operation to be integrated with the solar system. For example, mass and energy integration tools can be used to make changes in process performance to optimize the energy uses of the process in conjunction with the design of the solar system.
7. Development of the impact of greenhouse gas policies on the optimal design and size of the solar systems and the ratios of fossil to solar energy uses.

REFERENCES

- Archer D, Qu M and Masson S (2006) A linear parabolic trough solar collector performance model. *Renewable Energy Resources and a Greener Future Journal* VIII-3-3.
- Badran O, Eck M (2006) The application of parabolic trough technology under Jordanian climate. *Renewable Energy* 31: 791-802.
- Cohen GE, Kearney DW and Price HWn (1999) Performance history and future costs of parabolic trough solar electricity systems. In: *Proceedings of the 9th International Symposium on Solar Thermal Concentrating Technologies*, Odeillo, France, 1998 *Journal of Physics IV*: 169- 179.
- Dersc J, Geyer M, Herrman U, Jones SA, Kelly B, Kistner R, Orthmanns W, Pitz- Paal R and Price H (2004) Trough integration into power plants- a study on the performance and economy of integrated solar combined cycle systems. *Energy* 29: 947-959.
- Duffie JA and Beckman WA (2006) *Solar Engineering of Thermal Processes*. Wiley & Sons, New York.
- Eck M, Zarza E (2006) Direct steam process with direct steam generating parabolic troughs. *Solar Energy* 80: 1424-1433.
- Edward C, Bertnolli EC, and Herrold W (1989) Solar electric generating stations (SEGS). *IEEE Power Engineering Review* 9(8): 4-8.
- Garg HP, Mullick SC. and Bhargava AK (1985) *Solar Thermal Energy Storage*. D. Reidel Publishing Company, Dordrecht.

- Hassani V, Price H (2001) Modular trough power plants. In: Proceedings of Solar Forum 2001, Solar Energy: The Power to Choose; April 21-25, 2001, Washington, DC.
- Herrmann U and Kearney D (2002) Survey of thermal energy storage for parabolic trough power plants. *Journal of Solar Energy Engineering* 24: 145-152.
- Herrmann U, Kelly B, Price H (2004) Two-tank molten salt storage for parabolic trough solar power plants. *Energy* 29: 883-893.
- Kelly B and Herrmann U (2000) Thermal Renewable Energy Laboratory USA through initiative: Thermal storage for Rankine cycle and combination cycle power plants, National Renewable Energy Laboratory USA, Parabolic Trough Technology Workshop, Golden, Colorado.
- Kelly B and Kearney D (2006) Thermal storage commercial plant design study for a two-tank indirect molten salt system. Final Report May 13, 2002- December 31, 2004, Subcontract Report NREL/SR-550-40166.
- Lippke F (1995) Simulation of the part-load behavior of a 30 MWe SEGS plant. SAND95-1293, Report prepared by Department of Energy, Sandia National Laboratories, Albuquerque, NM.
- Muller H (March 2004) Concentrating solar power. A review of the technology. *Energy* 18: 43-50.
- Pacheco JE (2000) SunLab molten-salt thermal storage tests. National Renewable Energy Laboratory USA, Parabolic Trough Technology Workshop. Available at www.nrel.gov/csp/trough/wkshp-2000html.
- Pacheco JE and Gilbert (1999) Overview of recent results of the solar two test and

- evaluations program. Paper number RAES99-7731. 1999 ASME International Solar Energy Conference, Maui, HI, April 11-14.
- Price H (2006) A parabolic trough solar power plant simulation model. ISES 2003: International Solar Energy Conference, Hawaii, March 16-18.
- Sargent & Lundy LLC Consulting Group (2003) Assessment of parabolic trough and power tower solar technology cost and performance forecasts. NREL/SR-550-34440. Available at www.nrel.gov/csp/trough/wkshp-2000.html.
- Schwarzbozl P and Zentrum D (November 2006) TRANSYS Model Library for Solar Thermal. Electric Components (STEC), Reference manual, Release 3.0. DLR, Germany.
- Stoddard L, Abiecunas J, and O'Connell R (2006) Economic, energy, and environmental benefits of concentrating solar power in California, Subcontract Report REL/SR-550-39291, Overland Park, Kansas.
- Valenzuela L, Zarza E, Manuel Berenguel M, and Camacho E F (April 2004) Direct steam generation in solar boilers. IEEE Control Systems Magazine 24 (2): 15-29.
- Zarza E, Rojas ME, González L, Caballero J, Fernando Rueda (2005) INDITEP: The first pre-commercial DSG solar power plant. Solar Energy 80:1270-1276.
- Zarza E, Valenzuela L, Leon J, Weyers D, Eickhoff M, Eck M and Hebbecke K (2002) The DISS Project: Direct steam generation in parabolic trough systems: Operation and maintenance experience and update on project status, Transactions of ASME, Journal of Solar Energy Engineering 124 (2): 126-133.

APPENDIX A

Appendix (A) contains eight LINGO programs:

- 1st. Solar alone all the year at full load (base design 7hrs/day)
- 2nd. Solar alone all the year at full load summer only (base design 7hrs/day)
- 3rd. Solar alone all the year at full load summer and 75% load winter (base design 7hrs/day)
- 4th. Solar and fossil winter and solar alone summer (base design 7hrs/day)
- 5th. Solar and fossil all the year (base design 7hrs/day)
- 6th. Solar and fossil all the year (base design 7hrs/day) with TES
- 7th. Solar and fossil all the year (base design sunshine hours daily)
- 8th. Solar and fossil all the year (base design sunshine hours daily base design 7hrs/day) with TES

1st . SOLAR ALONE ALL THE YEAR FULL LOAD (7HRS/DAY)

! This program is to find the minimum collectors area that absorb solar energy enough to run the solar power plant at full load, 7 hrs, a day all the summer months "April:August";

MIN=AREA;

SETS:

APRIL/1..7/:PP,XP,PPA;

MAI/1..7/:PM,XM,PMA;

JUNE/1..7/:PJN,XJN,PJNA;

JULY/1..7/:PJL,XJL,PJLA;

```

AUGUST/1..7/:PG,XG,PGA;

JANUARY/1..7/:PJ,XJ,PJA;

FEBRUARY/1..7/:PF,XF,PFA;

MARCH/1..7/:PR,XR,PRA;

SEPTEMBER/1..7/:PS,XS,PSA;

OCTOBER/1..7/:POC,XOC,POCA;

NOVMEBR/1..7/:PN,XN,PNA;

DECEMBER/1..7/:PD,XD,PDA;

ENDSETS

DATA:

PJ= 0.07738,0.09353,0.08583,0.08194,0.08268,0.09172,0.09496;

PF=0.09576,0.1049,0.1014,0.0983,0.0955,0.10516,0.1107;

PR=0.18849,0.19,0.19,0.19,0.181,0.181,0.18;

PP= 0.192,0.2,0.201,0.202,0.191,0.192,0.1929;

PM=0.18,0.188,0.196,0.201,0.2,0.196,0.186;

PJN=0.205,0.212,0.215,0.2159,0.206,0.213,0.195;

PJL=0.1818,0.1959,0.1986,0.1998,0.2044,0.2,0.2019;

PG=0.183,0.197,0.192,0.196,0.188,0.187,0.18;

PS=0.1876,0.193,0.184,0.179,0.172,0.166,0.163;

POC=0.148,0.15,0.147,0.133,0.128,0.137,0.136;

PN=0.158,0.156,0.148,0.136,0.129,0.126,0.119;

PD=0.082,0.088,0.079,0.0688,0.069,0.075,0.073;

ENDDATA

!APRIL (P);

@FOR (APRIL (i) :PPA (i) =AREA*PP (i) );

PPT=@SUM (APRIL (i) :PPA (i) );

@FOR (APRIL (i) :PPA (i) >=50000);

!MAI (M);

@FOR (MAI (i) :PMA (i) =AREA*PM (i) );

```

```

PMT=@SUM(MAI(i):PMA(i));

@FOR(MAI(i):PMA(i)>=50000);

!JUNE(JN);

@FOR(JUNE(i):PJNA(i)=AREA*PJN(i));

PJNT=@SUM(JUNE(i):PJNA(i));

@FOR(JUNE(i):PJNA(i)>=50000);

!JULY(JL);

@FOR(JULY(i):PJLA(i)=AREA*PJL(i));

PJLT=@SUM(JULY(i):PJLA(i));

@FOR(JULY(i):PJLA(i)>=50000);

!AUGUST(G);

@FOR(AUGUST(i):PGA(i)=AREA*PG(i));

PGT=@SUM(AUGUST(i):PGA(i));

@FOR(AUGUST(i):PGA(i)>=50000);

!SEPTEMBER;

@FOR(SEPTEMBER(i):PsA(i)=AREA*Ps(i));

PsT=@SUM(SEPTEMBER(i):PsA(i));

@FOR(SEPTEMBER(i):PSA(i)>=50000);

!october;

@FOR(OCTOBER(i):POCA(i)=AREA*POC(i));

POCT=@SUM(OCTOBER(i):POCA(i));

@FOR(OCTOBER(i):POCA(i)>=50000);

!NOVMEBR;

@FOR(NOVMEBR(i):PNA(i)=AREA*PN(i));

PNT=@SUM(NOVMEBR(i):PNA(i));

@FOR(NOVMEBR(i):PNA(i)>=50000);

!DECEMBER;

@FOR(DECEMBER(i):PDA(i)=AREA*PD(i));

PDT=@SUM(DECEMBER(i):PDA(i));

```

```

@FOR (DECEMBER (i) : PDA (i) >= 50000);

!JANUARY;

@FOR (JANUARY (i) : PJA (i) = AREA * PJ (i));

PJT = @SUM (JANUARY (i) : PJA (i));

@FOR (JANUARY (i) : PJA (i) >= 50000);

!FEBRUARY;

@FOR (FEBRUARY (i) : PFA (i) = AREA * PF (i));

PFT = @SUM (FEBRUARY (i) : PFA (i));

@FOR (FEBRUARY (i) : PFA (i) >= 50000);

!MARCH;

@FOR (MARCH (i) : PRA (i) = AREA * PR (i));

PRT = @SUM (MARCH (i) : PRA (i));

@FOR (MARCH (i) : PRA (i) >= 50000);

PT_SUMMER = 30 * PPT + 31 * PMT + 30 * PJNT + 31 * PJLT + 31 * PGT;

P_Annual = PT_Summer + PT_WINTER;

PT_WINTER = 31 * PRT + 31 * PJT + 28 * PFT + 31 * POCT + 31 * PDT;

PFUEL = 0;

Net_Ele = (1 - 0.084) * (P_Annual + PFUEL);

LEC = ((302 * AREA + 592 * N_P) * 0.104 + OM_SOLAR * Net_Ele) / Net_Ele;

N_P = 50000;

Full_HRS = Net_Ele / 50000;

OM_SOLAR = 0.024;

CO2_Reduction = Area * 300;

Fuel_Saver = Net_Ele / 301790;

```

- **Lingo output**

Local optimal solution found.

Objective value:

726744.2

Total solver iterations:

74

Variable	Value	Reduced Cost
AREA	726744.2	0.000000
PPT	996293.6	0.000000
PMT	978924.4	0.000000
PJNT	1062427.	0.000000
PJLT	1004651.	0.000000
PGT	961482.6	0.000000
PST	904505.8	0.000000
POCT	711482.6	0.000000
PNT	706395.3	0.000000
PDT	388662.8	0.000000
PJT	441889.5	0.000000
PFT	517238.4	0.000000
PRT	945123.5	0.000000
PT_SUMMER	0.1530584E+09	0.000000
P_ANNUAL	0.2446430E+09	0.000000
PT_WINTER	0.9158459E+08	0.000000
PFUEL	0.000000	0.000000
NET_ELE	0.2240930E+09	0.000000
LEC	0.1395948	0.000000
N_P	50000.00	0.000000
OM_SOLAR	0.2400000E-01	0.000000
FULL_HRS	4481.860	0.000000
CO2_REDUCTION	0.2180233E+09	0.000000
FUEL_SAVER	742.5462	0.000000
PP (1)	0.1920000	0.000000

PP (2)	0.2000000	0.0000000
PP (3)	0.2010000	0.0000000
PP (4)	0.2020000	0.0000000
PP (5)	0.1910000	0.0000000
PP (6)	0.1920000	0.0000000
PP (7)	0.1929000	0.0000000
XP (1)	0.0000000	0.0000000
XP (2)	0.0000000	0.0000000
XP (3)	0.0000000	0.0000000
XP (4)	0.0000000	0.0000000
XP (5)	0.0000000	0.0000000
XP (6)	0.0000000	0.0000000
XP (7)	0.0000000	0.0000000
PPA (1)	139534.9	0.0000000
PPA (2)	145348.8	0.0000000
PPA (3)	146075.6	0.0000000
PPA (4)	146802.3	0.0000000
PPA (5)	138808.1	0.0000000
PPA (6)	139534.9	0.0000000
PPA (7)	140189.0	0.0000000
PM (1)	0.1800000	0.0000000
PM (2)	0.1880000	0.0000000
PM (3)	0.1960000	0.0000000
PM (4)	0.2010000	0.0000000
PM (5)	0.2000000	0.0000000
PM (6)	0.1960000	0.0000000
PM (7)	0.1860000	0.0000000
XM (1)	0.0000000	0.0000000
XM (2)	0.0000000	0.0000000

XM (3)	0.000000	0.000000
XM (4)	0.000000	0.000000
XM (5)	0.000000	0.000000
XM (6)	0.000000	0.000000
XM (7)	0.000000	0.000000
PMA (1)	130814.0	0.000000
PMA (2)	136627.9	0.000000
PMA (3)	142441.9	0.000000
PMA (4)	146075.6	0.000000
PMA (5)	145348.8	0.000000
PMA (6)	142441.9	0.000000
PMA (7)	135174.4	0.000000
PJN (1)	0.2050000	0.000000
PJN (2)	0.2120000	0.000000
PJN (3)	0.2150000	0.000000
PJN (4)	0.2159000	0.000000
PJN (5)	0.2060000	0.000000
PJN (6)	0.2130000	0.000000
PJN (7)	0.1950000	0.000000
XJN (1)	0.000000	0.000000
XJN (2)	0.000000	0.000000
XJN (3)	0.000000	0.000000
XJN (4)	0.000000	0.000000
XJN (5)	0.000000	0.000000
XJN (6)	0.000000	0.000000
XJN (7)	0.000000	0.000000
PJNA (1)	148982.6	0.000000
PJNA (2)	154069.8	0.000000
PJNA (3)	156250.0	0.000000

PJNA (4)	156904.1	0.000000
PJNA (5)	149709.3	0.000000
PJNA (6)	154796.5	0.000000
PJNA (7)	141715.1	0.000000
PJL (1)	0.1818000	0.000000
PJL (2)	0.1959000	0.000000
PJL (3)	0.1986000	0.000000
PJL (4)	0.1998000	0.000000
PJL (5)	0.2044000	0.000000
PJL (6)	0.2000000	0.000000
PJL (7)	0.2019000	0.000000
XJL (1)	0.000000	0.000000
XJL (2)	0.000000	0.000000
XJL (3)	0.000000	0.000000
XJL (4)	0.000000	0.000000
XJL (5)	0.000000	0.000000
XJL (6)	0.000000	0.000000
XJL (7)	0.000000	0.000000
PJLA (1)	132122.1	0.000000
PJLA (2)	142369.2	0.000000
PJLA (3)	144331.4	0.000000
PJLA (4)	145203.5	0.000000
PJLA (5)	148546.5	0.000000
PJLA (6)	145348.8	0.000000
PJLA (7)	146729.7	0.000000
PG (1)	0.1830000	0.000000
PG (2)	0.1970000	0.000000
PG (3)	0.1920000	0.000000
PG (4)	0.1960000	0.000000

PG (5)	0.1880000	0.000000
PG (6)	0.1870000	0.000000
PG (7)	0.1800000	0.000000
XG (1)	0.000000	0.000000
XG (2)	0.000000	0.000000
XG (3)	0.000000	0.000000
XG (4)	0.000000	0.000000
XG (5)	0.000000	0.000000
XG (6)	0.000000	0.000000
XG (7)	0.000000	0.000000
PGA (1)	132994.2	0.000000
PGA (2)	143168.6	0.000000
PGA (3)	139534.9	0.000000
PGA (4)	142441.9	0.000000
PGA (5)	136627.9	0.000000
PGA (6)	135901.2	0.000000
PGA (7)	130814.0	0.000000
PJ (1)	0.7738000E-01	0.000000
PJ (2)	0.9353000E-01	0.000000
PJ (3)	0.8583000E-01	0.000000
PJ (4)	0.8194000E-01	0.000000
PJ (5)	0.8268000E-01	0.000000
PJ (6)	0.9172000E-01	0.000000
PJ (7)	0.9496000E-01	0.000000
XJ (1)	0.000000	0.000000
XJ (2)	0.000000	0.000000
XJ (3)	0.000000	0.000000
XJ (4)	0.000000	0.000000
XJ (5)	0.000000	0.000000

XJ (6)	0.000000	0.000000
XJ (7)	0.000000	0.000000
PJA (1)	56235.47	0.000000
PJA (2)	67972.38	0.000000
PJA (3)	62376.45	0.000000
PJA (4)	59549.42	0.000000
PJA (5)	60087.21	0.000000
PJA (6)	66656.98	0.000000
PJA (7)	69011.63	0.000000
PF (1)	0.9576000E-01	0.000000
PF (2)	0.1049000	0.000000
PF (3)	0.1014000	0.000000
PF (4)	0.9830000E-01	0.000000
PF (5)	0.9550000E-01	0.000000
PF (6)	0.1051600	0.000000
PF (7)	0.1107000	0.000000
XF (1)	0.000000	0.000000
XF (2)	0.000000	0.000000
XF (3)	0.000000	0.000000
XF (4)	0.000000	0.000000
XF (5)	0.000000	0.000000
XF (6)	0.000000	0.000000
XF (7)	0.000000	0.000000
PFA (1)	69593.02	0.000000
PFA (2)	76235.47	0.000000
PFA (3)	73691.86	0.000000
PFA (4)	71438.95	0.000000
PFA (5)	69404.07	0.000000
PFA (6)	76424.42	0.000000

PFA (7)	80450.58	0.000000
PR (1)	0.1884900	0.000000
PR (2)	0.1900000	0.000000
PR (3)	0.1900000	0.000000
PR (4)	0.1900000	0.000000
PR (5)	0.1810000	0.000000
PR (6)	0.1810000	0.000000
PR (7)	0.1800000	0.000000
XR (1)	0.000000	0.000000
XR (2)	0.000000	0.000000
XR (3)	0.000000	0.000000
XR (4)	0.000000	0.000000
XR (5)	0.000000	0.000000
XR (6)	0.000000	0.000000
XR (7)	0.000000	0.000000
PRA (1)	136984.0	0.000000
PRA (2)	138081.4	0.000000
PRA (3)	138081.4	0.000000
PRA (4)	138081.4	0.000000
PRA (5)	131540.7	0.000000
PRA (6)	131540.7	0.000000
PRA (7)	130814.0	0.000000
PS (1)	0.1876000	0.000000
PS (2)	0.1930000	0.000000
PS (3)	0.1840000	0.000000
PS (4)	0.1790000	0.000000
PS (5)	0.1720000	0.000000
PS (6)	0.1660000	0.000000
PS (7)	0.1630000	0.000000

XS (1)	0.000000	0.000000
XS (2)	0.000000	0.000000
XS (3)	0.000000	0.000000
XS (4)	0.000000	0.000000
XS (5)	0.000000	0.000000
XS (6)	0.000000	0.000000
XS (7)	0.000000	0.000000
PSA (1)	136337.2	0.000000
PSA (2)	140261.6	0.000000
PSA (3)	133720.9	0.000000
PSA (4)	130087.2	0.000000
PSA (5)	125000.0	0.000000
PSA (6)	120639.5	0.000000
PSA (7)	118459.3	0.000000
POC (1)	0.1480000	0.000000
POC (2)	0.1500000	0.000000
POC (3)	0.1470000	0.000000
POC (4)	0.1330000	0.000000
POC (5)	0.1280000	0.000000
POC (6)	0.1370000	0.000000
POC (7)	0.1360000	0.000000
XOC (1)	0.000000	0.000000
XOC (2)	0.000000	0.000000
XOC (3)	0.000000	0.000000
XOC (4)	0.000000	0.000000
XOC (5)	0.000000	0.000000
XOC (6)	0.000000	0.000000
XOC (7)	0.000000	0.000000
POCA (1)	107558.1	0.000000

POCA (2)	109011.6	0.000000
POCA (3)	106831.4	0.000000
POCA (4)	96656.98	0.000000
POCA (5)	93023.26	0.000000
POCA (6)	99563.95	0.000000
POCA (7)	98837.21	0.000000
PN (1)	0.1580000	0.000000
PN (2)	0.1560000	0.000000
PN (3)	0.1480000	0.000000
PN (4)	0.1360000	0.000000
PN (5)	0.1290000	0.000000
PN (6)	0.1260000	0.000000
PN (7)	0.1190000	0.000000
XN (1)	0.000000	0.000000
XN (2)	0.000000	0.000000
XN (3)	0.000000	0.000000
XN (4)	0.000000	0.000000
XN (5)	0.000000	0.000000
XN (6)	0.000000	0.000000
XN (7)	0.000000	0.000000
PNA (1)	114825.6	0.000000
PNA (2)	113372.1	0.000000
PNA (3)	107558.1	0.000000
PNA (4)	98837.21	0.000000
PNA (5)	93750.00	0.000000
PNA (6)	91569.77	0.000000
PNA (7)	86482.56	0.000000
PD (1)	0.8200000E-01	0.000000
PD (2)	0.8800000E-01	0.000000

PD (3)	0.7900000E-01	0.000000
PD (4)	0.6880000E-01	0.000000
PD (5)	0.6900000E-01	0.000000
PD (6)	0.7500000E-01	0.000000
PD (7)	0.7300000E-01	0.000000
XD (1)	0.000000	0.000000
XD (2)	0.000000	0.000000
XD (3)	0.000000	0.000000
XD (4)	0.000000	0.000000
XD (5)	0.000000	0.000000
XD (6)	0.000000	0.000000
XD (7)	0.000000	0.000000
PDA (1)	59593.02	0.000000
PDA (2)	63953.49	0.000000
PDA (3)	57412.79	0.000000
PDA (4)	50000.00	0.000000
PDA (5)	50145.35	0.000000
PDA (6)	54505.81	0.000000
PDA (7)	53052.33	0.000000

2nd. SOLAR ALONE FULL LOAD SUMMER

! This program is to find the minimum collectors area that aborb solar energy enough to run th e solar power plant at full load, 7 hrs, a day all the summer monthes "April:August";

MIN=AREA;

SETS:

APRIL/1..7/:PP,XP,PPA;

MAI/1..7/:PM,XM,PMA;

JUNE/1..7/:PJN,XJN,PJNA;

JULY/1..7/:PJL,XJL,PJLA;

AUGUST/1..7/:PG,XG,PGA;

JANUARY/1..7/:PJ,XJ,PJA,PFJ;

FEBRUARY/1..7/:PF,XF,PFA,PFJ;

MARCH/1..7/:PR,XR,PRA,PFR;

SEPTEMBER/1..7/:PS,XS,PSA;

OCTOBER/1..7/:POC,XOC,POCA,PFOC;

NOVMEBR/1..7/:PN,XN,PNA,PFN;

DECEMBER/1..7/:PD,XD,PDA,PDF;

ENDSETS

DATA:

PJ= 0.07738,0.09353,0.08583,0.08194,0.08268,0.09172,0.09496;

PF=0.09576,0.1049,0.1014,0.0983,0.0955,0.10516,0.1107;

PR=0.18849,0.19,0.19,0.19,0.181,0.181,0.18;

PP= 0.192,0.2,0.201,0.202,0.191,0.192,0.1929;

PM=0.18,0.188,0.196,0.201,0.2,0.196,0.186;

PJN=0.205,0.212,0.215,0.2159,0.206,0.213,0.195;

PJL=0.1818,0.1959,0.1986,0.1998,0.2044,0.2,0.2019;

```

PG=0.183,0.197,0.192,0.196,0.188,0.187,0.18;
PS=0.1876,0.193,0.184,0.179,0.172,0.166,0.163;
POC=0.148,0.15,0.147,0.133,0.128,0.137,0.136;
PN=0.158,0.156,0.148,0.136,0.129,0.126,0.119;
PD=0.082,0.088,0.079,0.0688,0.069,0.075,0.073;
ENDDATA

!APRIL (P) ;

@FOR (APRIL (i) :PPA (i) =AREA*PP (i) ) ;
PPT=@SUM (APRIL (i) :PPA (i) ) ;
@FOR (APRIL (i) :PPA (i) >=50000) ;

!MAI (M) ;

@FOR (MAI (i) :PMA (i) =AREA*PM (i) ) ;
PMT=@SUM (MAI (i) :PMA (i) ) ;
@FOR (MAI (i) :PMA (i) >=50000) ;

!JUNE (JN) ;

@FOR (JUNE (i) :PJNA (i) =AREA*PJN (i) ) ;
PJNT=@SUM (JUNE (i) :PJNA (i) ) ;
@FOR (JUNE (i) :PJNA (i) >=50000) ;

!JULY (JL) ;

@FOR (JULY (i) :PJLA (i) =AREA*PJL (i) ) ;
PJLT=@SUM (JULY (i) :PJLA (i) ) ;
@FOR (JULY (i) :PJLA (i) >=50000) ;

!AUGUST (G) ;

@FOR (AUGUST (i) :PGA (i) =AREA*PG (i) ) ;
PGT=@SUM (AUGUST (i) :PGA (i) ) ;
@FOR (AUGUST (i) :PGA (i) >=50000) ;

!SEPTEMBER;

@FOR (SEPTEMBER (i) :PsA (i) =AREA*Ps (i) ) ;
PsT=@SUM (SEPTEMBER (i) :PsA (i) ) ;

```

```

@FOR (SEPTEMBER (i) : PSA (i) >= 50000);

!!!!!!!!!!!!!!!!!!!!!!!!!!!!!!!!!!!!!!!!!!!!!!!!!!!!;

!THE WINTER WILL RUN USING FUEL & SOLAR TOGETHER TO GET FULL LOAD;

!october;

@FOR (OCTOBER (i) : POCA (i) = AREA * POC (i));

POCT = @SUM (OCTOBER (i) : POCA (i));

!NOVMEBR;

@FOR (NOVMEBR (i) : PNA (i) = AREA * PN (i));

PNT = @SUM (NOVMEBR (i) : PNA (i));

!DECEMBER;

@FOR (DECEMBER (i) : PDA (i) = AREA * PD (i));

PDT = @SUM (DECEMBER (i) : PDA (i));

!JANUARY;

@FOR (JANUARY (i) : PJA (i) = AREA * PJ (i));

PJT = @SUM (JANUARY (i) : PJA (i));

!FEBRUARY;

@FOR (FEBRUARY (i) : PFA (i) = AREA * PF (i));

PFT = @SUM (FEBRUARY (i) : PFA (i));

!MARCH;

@FOR (MARCH (i) : PRA (i) = AREA * PR (i));

PRT = @SUM (MARCH (i) : PRA (i));

PT_SUMMER = 30 * PPT + 31 * PMT + 30 * PJNT + 31 * PJLT + 31 * PGT;

P_Annual = PT_Summer + PT_WINTER;

PT_WINTER = 31 * PRT + 31 * PJT + 28 * PFT + 31 * POCT + 31 * PDT;

RATIO = PFUEL / P_Annual;

RATIO <= 0.25;

Net_Ele = (1 - 0.084) * (P_Annual);

Fuel_saver = Net_Ele / 301790;

CO2-Reduction = 300 * Area;

```

LEC= ((302*AREA+592*N_P)*0.104+OM_SOLAR*Net_Ele)/Net_Ele ;

N_P=50000;

OM_SOLAR=0.018;

▪ Lingo output

Local optimal solution found.

Objective value: 306748.5

Total solver iterations: 44

Variable	Value	Reduced Cost
AREA	306748.5	0.000000
PPT	420521.5	0.000000
PMT	413190.2	0.000000
PJNT	448435.6	0.000000
PJLT	424049.1	0.000000
PGT	405828.2	0.000000
PST	381779.1	0.000000
POCT	300306.7	0.000000
PNT	298159.5	0.000000
PDT	164049.1	0.000000
PJT	186515.3	0.000000
PFT	218319.0	0.000000
PRT	398923.3	0.000000
PT_SUMMER	0.6460380E+08	0.000000
P_ANNUAL	0.1032604E+09	0.000000
PT_WINTER	0.3865656E+08	0.000000
RATIO	0.000000	0.000000

PFUEL	0.000000	0.000000
NET_ELE	0.9458649E+08	0.000000
FUEL_SAVER	313.4183	0.000000
CO2	0.9202454E+08	0.000000
REDUCTION	0.000000	0.000000
LEC	0.1524035	0.000000
N_P	50000.00	0.000000
OM_SOLAR	0.1800000E-01	0.000000
PP (1)	0.1920000	0.000000
PP (2)	0.2000000	0.000000
PP (3)	0.2010000	0.000000
PP (4)	0.2020000	0.000000
PP (5)	0.1910000	0.000000
PP (6)	0.1920000	0.000000
PP (7)	0.1929000	0.000000
XP (1)	0.000000	0.000000
XP (2)	0.000000	0.000000
XP (3)	0.000000	0.000000
XP (4)	0.000000	0.000000
XP (5)	0.000000	0.000000
XP (6)	0.000000	0.000000
XP (7)	0.000000	0.000000
PPA (1)	58895.71	0.000000
PPA (2)	61349.69	0.000000
PPA (3)	61656.44	0.000000
PPA (4)	61963.19	0.000000
PPA (5)	58588.96	0.000000
PPA (6)	58895.71	0.000000
PPA (7)	59171.78	0.000000

PM(1)	0.1800000	0.000000
PM(2)	0.1880000	0.000000
PM(3)	0.1960000	0.000000
PM(4)	0.2010000	0.000000
PM(5)	0.2000000	0.000000
PM(6)	0.1960000	0.000000
PM(7)	0.1860000	0.000000
XM(1)	0.000000	0.000000
XM(2)	0.000000	0.000000
XM(3)	0.000000	0.000000
XM(4)	0.000000	0.000000
XM(5)	0.000000	0.000000
XM(6)	0.000000	0.000000
XM(7)	0.000000	0.000000
PMA(1)	55214.72	0.000000
PMA(2)	57668.71	0.000000
PMA(3)	60122.70	0.000000
PMA(4)	61656.44	0.000000
PMA(5)	61349.69	0.000000
PMA(6)	60122.70	0.000000
PMA(7)	57055.21	0.000000
PJN(1)	0.2050000	0.000000
PJN(2)	0.2120000	0.000000
PJN(3)	0.2150000	0.000000
PJN(4)	0.2159000	0.000000
PJN(5)	0.2060000	0.000000
PJN(6)	0.2130000	0.000000
PJN(7)	0.1950000	0.000000
XJN(1)	0.000000	0.000000

XJN (2)	0.000000	0.000000
XJN (3)	0.000000	0.000000
XJN (4)	0.000000	0.000000
XJN (5)	0.000000	0.000000
XJN (6)	0.000000	0.000000
XJN (7)	0.000000	0.000000
PJNA (1)	62883.44	0.000000
PJNA (2)	65030.67	0.000000
PJNA (3)	65950.92	0.000000
PJNA (4)	66226.99	0.000000
PJNA (5)	63190.18	0.000000
PJNA (6)	65337.42	0.000000
PJNA (7)	59815.95	0.000000
PJL (1)	0.1818000	0.000000
PJL (2)	0.1959000	0.000000
PJL (3)	0.1986000	0.000000
PJL (4)	0.1998000	0.000000
PJL (5)	0.2044000	0.000000
PJL (6)	0.2000000	0.000000
PJL (7)	0.2019000	0.000000
XJL (1)	0.000000	0.000000
XJL (2)	0.000000	0.000000
XJL (3)	0.000000	0.000000
XJL (4)	0.000000	0.000000
XJL (5)	0.000000	0.000000
XJL (6)	0.000000	0.000000
XJL (7)	0.000000	0.000000
PJLA (1)	55766.87	0.000000
PJLA (2)	60092.02	0.000000

PJLA (3)	60920.25	0.000000
PJLA (4)	61288.34	0.000000
PJLA (5)	62699.39	0.000000
PJLA (6)	61349.69	0.000000
PJLA (7)	61932.52	0.000000
PG (1)	0.1830000	0.000000
PG (2)	0.1970000	0.000000
PG (3)	0.1920000	0.000000
PG (4)	0.1960000	0.000000
PG (5)	0.1880000	0.000000
PG (6)	0.1870000	0.000000
PG (7)	0.1800000	0.000000
XG (1)	0.000000	0.000000
XG (2)	0.000000	0.000000
XG (3)	0.000000	0.000000
XG (4)	0.000000	0.000000
XG (5)	0.000000	0.000000
XG (6)	0.000000	0.000000
XG (7)	0.000000	0.000000
PGA (1)	56134.97	0.000000
PGA (2)	60429.45	0.000000
PGA (3)	58895.71	0.000000
PGA (4)	60122.70	0.000000
PGA (5)	57668.71	0.000000
PGA (6)	57361.96	0.000000
PGA (7)	55214.72	0.000000
PJ (1)	0.7738000E-01	0.000000
PJ (2)	0.9353000E-01	0.000000
PJ (3)	0.8583000E-01	0.000000

PJ(4)	0.8194000E-01	0.000000
PJ(5)	0.8268000E-01	0.000000
PJ(6)	0.9172000E-01	0.000000
PJ(7)	0.9496000E-01	0.000000
XJ(1)	0.000000	0.000000
XJ(2)	0.000000	0.000000
XJ(3)	0.000000	0.000000
XJ(4)	0.000000	0.000000
XJ(5)	0.000000	0.000000
XJ(6)	0.000000	0.000000
XJ(7)	0.000000	0.000000
PJA(1)	23736.20	0.000000
PJA(2)	28690.18	0.000000
PJA(3)	26328.22	0.000000
PJA(4)	25134.97	0.000000
PJA(5)	25361.96	0.000000
PJA(6)	28134.97	0.000000
PJA(7)	29128.83	0.000000
PFJ(1)	0.000000	0.000000
PFJ(2)	0.000000	0.000000
PFJ(3)	0.000000	0.000000
PFJ(4)	0.000000	0.000000
PFJ(5)	0.000000	0.000000
PFJ(6)	0.000000	0.000000
PFJ(7)	0.000000	0.000000
PF(1)	0.9576000E-01	0.000000
PF(2)	0.1049000	0.000000
PF(3)	0.1014000	0.000000
PF(4)	0.9830000E-01	0.000000

PF (5)	0.9550000E-01	0.000000
PF (6)	0.1051600	0.000000
PF (7)	0.1107000	0.000000
XF (1)	0.000000	0.000000
XF (2)	0.000000	0.000000
XF (3)	0.000000	0.000000
XF (4)	0.000000	0.000000
XF (5)	0.000000	0.000000
XF (6)	0.000000	0.000000
XF (7)	0.000000	0.000000
PFA (1)	29374.23	0.000000
PFA (2)	32177.91	0.000000
PFA (3)	31104.29	0.000000
PFA (4)	30153.37	0.000000
PFA (5)	29294.48	0.000000
PFA (6)	32257.67	0.000000
PFA (7)	33957.06	0.000000
PFF (1)	0.000000	0.000000
PFF (2)	0.000000	0.000000
PFF (3)	0.000000	0.000000
PFF (4)	0.000000	0.000000
PFF (5)	0.000000	0.000000
PFF (6)	0.000000	0.000000
PFF (7)	0.000000	0.000000
PR (1)	0.1884900	0.000000
PR (2)	0.1900000	0.000000
PR (3)	0.1900000	0.000000
PR (4)	0.1900000	0.000000
PR (5)	0.1810000	0.000000

PR (6)	0.1810000	0.000000
PR (7)	0.1800000	0.000000
XR (1)	0.000000	0.000000
XR (2)	0.000000	0.000000
XR (3)	0.000000	0.000000
XR (4)	0.000000	0.000000
XR (5)	0.000000	0.000000
XR (6)	0.000000	0.000000
XR (7)	0.000000	0.000000
PRA (1)	57819.02	0.000000
PRA (2)	58282.21	0.000000
PRA (3)	58282.21	0.000000
PRA (4)	58282.21	0.000000
PRA (5)	55521.47	0.000000
PRA (6)	55521.47	0.000000
PRA (7)	55214.72	0.000000
PFR (1)	0.000000	0.000000
PFR (2)	0.000000	0.000000
PFR (3)	0.000000	0.000000
PFR (4)	0.000000	0.000000
PFR (5)	0.000000	0.000000
PFR (6)	0.000000	0.000000
PFR (7)	0.000000	0.000000
PS (1)	0.1876000	0.000000
PS (2)	0.1930000	0.000000
PS (3)	0.1840000	0.000000
PS (4)	0.1790000	0.000000
PS (5)	0.1720000	0.000000
PS (6)	0.1660000	0.000000

PS (7)	0.1630000	0.000000
XS (1)	0.000000	0.000000
XS (2)	0.000000	0.000000
XS (3)	0.000000	0.000000
XS (4)	0.000000	0.000000
XS (5)	0.000000	0.000000
XS (6)	0.000000	0.000000
XS (7)	0.000000	0.000000
PSA (1)	57546.01	0.000000
PSA (2)	59202.45	0.000000
PSA (3)	56441.72	0.000000
PSA (4)	54907.98	0.000000
PSA (5)	52760.74	0.000000
PSA (6)	50920.25	0.000000
PSA (7)	50000.00	0.000000
POC (1)	0.1480000	0.000000
POC (2)	0.1500000	0.000000
POC (3)	0.1470000	0.000000
POC (4)	0.1330000	0.000000
POC (5)	0.1280000	0.000000
POC (6)	0.1370000	0.000000
POC (7)	0.1360000	0.000000
XOC (1)	0.000000	0.000000
XOC (2)	0.000000	0.000000
XOC (3)	0.000000	0.000000
XOC (4)	0.000000	0.000000
XOC (5)	0.000000	0.000000
XOC (6)	0.000000	0.000000
XOC (7)	0.000000	0.000000

POCA (1)	45398.77	0.000000
POCA (2)	46012.27	0.000000
POCA (3)	45092.02	0.000000
POCA (4)	40797.55	0.000000
POCA (5)	39263.80	0.000000
POCA (6)	42024.54	0.000000
POCA (7)	41717.79	0.000000
PFOC (1)	0.000000	0.000000
PFOC (2)	0.000000	0.000000
PFOC (3)	0.000000	0.000000
PFOC (4)	0.000000	0.000000
PFOC (5)	0.000000	0.000000
PFOC (6)	0.000000	0.000000
PFOC (7)	0.000000	0.000000
PN (1)	0.1580000	0.000000
PN (2)	0.1560000	0.000000
PN (3)	0.1480000	0.000000
PN (4)	0.1360000	0.000000
PN (5)	0.1290000	0.000000
PN (6)	0.1260000	0.000000
PN (7)	0.1190000	0.000000
XN (1)	0.000000	0.000000
XN (2)	0.000000	0.000000
XN (3)	0.000000	0.000000
XN (4)	0.000000	0.000000
XN (5)	0.000000	0.000000
XN (6)	0.000000	0.000000
XN (7)	0.000000	0.000000
PNA (1)	48466.26	0.000000

PNA (2)	47852.76	0.000000
PNA (3)	45398.77	0.000000
PNA (4)	41717.79	0.000000
PNA (5)	39570.55	0.000000
PNA (6)	38650.31	0.000000
PNA (7)	36503.07	0.000000
PFN (1)	0.000000	0.000000
PFN (2)	0.000000	0.000000
PFN (3)	0.000000	0.000000
PFN (4)	0.000000	0.000000
PFN (5)	0.000000	0.000000
PFN (6)	0.000000	0.000000
PFN (7)	0.000000	0.000000
PD (1)	0.8200000E-01	0.000000
PD (2)	0.8800000E-01	0.000000
PD (3)	0.7900000E-01	0.000000
PD (4)	0.6880000E-01	0.000000
PD (5)	0.6900000E-01	0.000000
PD (6)	0.7500000E-01	0.000000
PD (7)	0.7300000E-01	0.000000
XD (1)	0.000000	0.000000
XD (2)	0.000000	0.000000
XD (3)	0.000000	0.000000
XD (4)	0.000000	0.000000
XD (5)	0.000000	0.000000
XD (6)	0.000000	0.000000
XD (7)	0.000000	0.000000
PDA (1)	25153.37	0.000000
PDA (2)	26993.87	0.000000

PDA (3)	24233.13	0.000000
PDA (4)	21104.29	0.000000
PDA (5)	21165.64	0.000000
PDA (6)	23006.13	0.000000
PDA (7)	22392.64	0.000000
PFD (1)	0.000000	0.000000
PFD (2)	0.000000	0.000000
PFD (3)	0.000000	0.000000
PFD (4)	0.000000	0.000000
PFD (5)	0.000000	0.000000
PFD (6)	0.000000	0.000000
PFD (7)	0.000000	0.000000

3rd. SOLAR ALONE FULL LOAD SUMMER AND 75% LOAD IN WINTER

! This program is to find the minimum collectors area that absorb solar energy enough to run the solar power plant at full load, 7 hrs, a day all the summer months "April:August";

!Mode of integration and operation is (solar alone full load summer & 75%load solar alone winter);

SETS:

APRIL/1..7/:PP,XP,PPA;

MAI/1..7/:PM,XM,PMA;

JUNE/1..7/:PJN,XJN,PJNA;

JULY/1..7/:PJL,XJL,PJLA;

AUGUST/1..7/:PG,XG,PGA;

JANUARY/1..7/:PJ,XJ,PJA;

FEBRUARY/1..7/:PF,XF,PFA;

MARCH/1..7/:PR,XR,PRA;

SEPTEMBER/1..7/:PS,XS,PSA;

OCTOBER/1..7/:POC,XOC,POCA;

NOVMEBR/1..7/:PN,XN,PNA;

DECEMBER/1..7/:PD,XD,PDA;

ENDSETS

DATA:

PJ= 0.07738,0.09353,0.08583,0.08194,0.08268,0.09172,0.09496;

PF=0.09576,0.1049,0.1014,0.0983,0.0955,0.10516,0.1107;

PR=0.18849,0.19,0.19,0.19,0.181,0.181,0.18;

PP= 0.192,0.2,0.201,0.202,0.191,0.192,0.1929;

PM=0.18,0.188,0.196,0.201,0.2,0.196,0.186;

PJN=0.205,0.212,0.215,0.2159,0.206,0.213,0.195;

```
PJL=0.1818,0.1959,0.1986,0.1998,0.2044,0.2,0.2019;
PG=0.183,0.197,0.192,0.196,0.188,0.187,0.18;
PS=0.1876,0.193,0.184,0.179,0.172,0.166,0.163;
POC=0.148,0.15,0.147,0.133,0.128,0.137,0.136;
PN=0.158,0.156,0.148,0.136,0.129,0.126,0.119;
PD=0.082,0.088,0.079,0.0688,0.069,0.075,0.073;
ENDDATA

!APRIL(P);

@FOR(APRIL(i):PPA(i)=AREA*PP(i));

PPT=@SUM(APRIL(i):PPA(i));

@FOR(APRIL(i):PPA(i)>=50000);

!MAI(M);

@FOR(MAI(i):PMA(i)=AREA*PM(i));

PMT=@SUM(MAI(i):PMA(i));

@FOR(MAI(i):PMA(i)>=50000);

!JUNE(JN);

@FOR(JUNE(i):PJNA(i)=AREA*PJN(i));

PJNT=@SUM(JUNE(i):PJNA(i));

@FOR(JUNE(i):PJNA(i)>=50000);

!JULY(JL);

@FOR(JULY(i):PJLA(i)=AREA*PJL(i));

PJLT=@SUM(JULY(i):PJLA(i));

@FOR(JULY(i):PJLA(i)>=50000);

!AUGUST(G);

@FOR(AUGUST(i):PGA(i)=AREA*PG(i));

PGT=@SUM(AUGUST(i):PGA(i));

@FOR(AUGUST(i):PGA(i)>=50000);

!SEPTEMBER;

@FOR(SEPTEMBER(i):PsA(i)=AREA*Ps(i));
```



```

PsT=@SUM(SEPTEMBER(i):PsA(i));

@FOR(SEPTEMBER(i):PSA(i)>=50000);

!october;

@FOR(OCTOBER(i):POCA(i)=AREA*POC(i));

POCT=@SUM(OCTOBER(i):POCA(i));

POCT>=0.75*50000*7;

!NOVMEBR;

@FOR(NOVMEBR(i):PNA(i)=AREA*PN(i));

PNT=@SUM(NOVMEBR(i):PNA(i));

PNT>=0.75*50000*7;

!DECEMBER;

@FOR(DECEMBER(i):PDA(i)=AREA*PD(i));

PDT=@SUM(DECEMBER(i):PDA(i));

PDT>=0.75*50000*7;

!JANUARY;

@FOR(JANUARY(i):PJA(i)=AREA*PJ(i));

PJT=@SUM(JANUARY(i):PJA(i));

PJT>=0.75*50000*7;

!FEBRUARY;

@FOR(FEBRUARY(i):PFA(i)=AREA*PF(i));

PFT=@SUM(FEBRUARY(i):PFA(i));

PFT>=0.75*50000*7;

!MARCH;

@FOR(MARCH(i):PRA(i)=AREA*PR(i));

PRT=@SUM(MARCH(i):PRA(i));

PRT>=0.75*50000*7;

PT_SUMMER=30*PPT+31*PMT+30*PJNT+31*PJLT+31*PGT;

P_Annual=PT_Summer+PT_WINTER;

PT_WINTER=31*PRT+31*PJT+28*PFT+31*POCT+31*PDT;

```

```

Net_Ele =(1-0.084)*(P_Annual);
LEC=((302*AREA+592*N_P)*0.104+OM_SOLAR*Net_Ele )/Net_Ele ;
N_P=50000;
OM_SOLAR=0.018;
fuel_saver=Net_Ele /301790;
CO2=300*Area;

```

- **Lingo output**

Feasible solution found.

Total solver iterations: 49

Variable	Value
AREA	490837.7
PPT	672889.4
PMT	661158.4
PJNT	717555.6
PJLT	678534.0
PGT	649378.3
PST	610896.6
POCT	480530.1
PNT	477094.2
PDT	262500.0
PJT	298449.0
PFT	349339.0
PRT	638329.5
PT_SUMMER	0.1033745E+09
P_ANNUAL	0.1652301E+09

PT_WINTER	0.6185556E+08
NET_ELE	0.1513508E+09
LEC	0.1401971
N_P	50000.00
OM_SOLAR	0.1800000E-01
FUEL_SAVER	501.5102
CO2	0.1472513E+09
PP (1)	0.1920000
PP (2)	0.2000000
PP (3)	0.2010000
PP (4)	0.2020000
PP (5)	0.1910000
PP (6)	0.1920000
PP (7)	0.1929000
XP (1)	0.000000
XP (2)	0.000000
XP (3)	0.000000
XP (4)	0.000000
XP (5)	0.000000
XP (6)	0.000000
XP (7)	0.000000
PPA (1)	94240.84
PPA (2)	98167.54
PPA (3)	98658.38
PPA (4)	99149.21
PPA (5)	93750.00
PPA (6)	94240.84
PPA (7)	94682.59
PM (1)	0.1800000

PM(2)	0.1880000
PM(3)	0.1960000
PM(4)	0.2010000
PM(5)	0.2000000
PM(6)	0.1960000
PM(7)	0.1860000
XM(1)	0.0000000
XM(2)	0.0000000
XM(3)	0.0000000
XM(4)	0.0000000
XM(5)	0.0000000
XM(6)	0.0000000
XM(7)	0.0000000
PMA(1)	88350.79
PMA(2)	92277.49
PMA(3)	96204.19
PMA(4)	98658.38
PMA(5)	98167.54
PMA(6)	96204.19
PMA(7)	91295.81
PJN(1)	0.2050000
PJN(2)	0.2120000
PJN(3)	0.2150000
PJN(4)	0.2159000
PJN(5)	0.2060000
PJN(6)	0.2130000
PJN(7)	0.1950000
XJN(1)	0.0000000
XJN(2)	0.0000000

XJN (3)	0.000000
XJN (4)	0.000000
XJN (5)	0.000000
XJN (6)	0.000000
XJN (7)	0.000000
PJNA (1)	100621.7
PJNA (2)	104057.6
PJNA (3)	105530.1
PJNA (4)	105971.9
PJNA (5)	101112.6
PJNA (6)	104548.4
PJNA (7)	95713.35
PJL (1)	0.1818000
PJL (2)	0.1959000
PJL (3)	0.1986000
PJL (4)	0.1998000
PJL (5)	0.2044000
PJL (6)	0.2000000
PJL (7)	0.2019000
XJL (1)	0.000000
XJL (2)	0.000000
XJL (3)	0.000000
XJL (4)	0.000000
XJL (5)	0.000000
XJL (6)	0.000000
XJL (7)	0.000000
PJLA (1)	89234.29
PJLA (2)	96155.10
PJLA (3)	97480.37

PJLA (4)	98069.37
PJLA (5)	100327.2
PJLA (6)	98167.54
PJLA (7)	99100.13
PG (1)	0.1830000
PG (2)	0.1970000
PG (3)	0.1920000
PG (4)	0.1960000
PG (5)	0.1880000
PG (6)	0.1870000
PG (7)	0.1800000
XG (1)	0.000000
XG (2)	0.000000
XG (3)	0.000000
XG (4)	0.000000
XG (5)	0.000000
XG (6)	0.000000
XG (7)	0.000000
PGA (1)	89823.30
PGA (2)	96695.03
PGA (3)	94240.84
PGA (4)	96204.19
PGA (5)	92277.49
PGA (6)	91786.65
PGA (7)	88350.79
PJ (1)	0.7738000E-01
PJ (2)	0.9353000E-01
PJ (3)	0.8583000E-01
PJ (4)	0.8194000E-01

PJ(5)	0.8268000E-01
PJ(6)	0.9172000E-01
PJ(7)	0.9496000E-01
XJ(1)	0.000000
XJ(2)	0.000000
XJ(3)	0.000000
XJ(4)	0.000000
XJ(5)	0.000000
XJ(6)	0.000000
XJ(7)	0.000000
PJA(1)	37981.02
PJA(2)	45908.05
PJA(3)	42128.60
PJA(4)	40219.24
PJA(5)	40582.46
PJA(6)	45019.63
PJA(7)	46609.95
PF(1)	0.9576000E-01
PF(2)	0.1049000
PF(3)	0.1014000
PF(4)	0.9830000E-01
PF(5)	0.9550000E-01
PF(6)	0.1051600
PF(7)	0.1107000
XF(1)	0.000000
XF(2)	0.000000
XF(3)	0.000000
XF(4)	0.000000
XF(5)	0.000000

XF (6)	0.000000
XF (7)	0.000000
PFA (1)	47002.62
PFA (2)	51488.87
PFA (3)	49770.94
PFA (4)	48249.35
PFA (5)	46875.00
PFA (6)	51616.49
PFA (7)	54335.73
PR (1)	0.1884900
PR (2)	0.1900000
PR (3)	0.1900000
PR (4)	0.1900000
PR (5)	0.1810000
PR (6)	0.1810000
PR (7)	0.1800000
XR (1)	0.000000
XR (2)	0.000000
XR (3)	0.000000
XR (4)	0.000000
XR (5)	0.000000
XR (6)	0.000000
XR (7)	0.000000
PRA (1)	92518.00
PRA (2)	93259.16
PRA (3)	93259.16
PRA (4)	93259.16
PRA (5)	88841.62
PRA (6)	88841.62

PRA (7)	88350.79
PS (1)	0.1876000
PS (2)	0.1930000
PS (3)	0.1840000
PS (4)	0.1790000
PS (5)	0.1720000
PS (6)	0.1660000
PS (7)	0.1630000
XS (1)	0.000000
XS (2)	0.000000
XS (3)	0.000000
XS (4)	0.000000
XS (5)	0.000000
XS (6)	0.000000
XS (7)	0.000000
PSA (1)	92081.15
PSA (2)	94731.68
PSA (3)	90314.14
PSA (4)	87859.95
PSA (5)	84424.08
PSA (6)	81479.06
PSA (7)	80006.54
POC (1)	0.1480000
POC (2)	0.1500000
POC (3)	0.1470000
POC (4)	0.1330000
POC (5)	0.1280000
POC (6)	0.1370000
POC (7)	0.1360000

XOC (1)	0.000000
XOC (2)	0.000000
XOC (3)	0.000000
XOC (4)	0.000000
XOC (5)	0.000000
XOC (6)	0.000000
XOC (7)	0.000000
POCA (1)	72643.98
POCA (2)	73625.65
POCA (3)	72153.14
POCA (4)	65281.41
POCA (5)	62827.23
POCA (6)	67244.76
POCA (7)	66753.93
PN (1)	0.1580000
PN (2)	0.1560000
PN (3)	0.1480000
PN (4)	0.1360000
PN (5)	0.1290000
PN (6)	0.1260000
PN (7)	0.1190000
XN (1)	0.000000
XN (2)	0.000000
XN (3)	0.000000
XN (4)	0.000000
XN (5)	0.000000
XN (6)	0.000000
XN (7)	0.000000
PNA (1)	77552.36

PNA (2)	76570.68
PNA (3)	72643.98
PNA (4)	66753.93
PNA (5)	63318.06
PNA (6)	61845.55
PNA (7)	58409.69
PD (1)	0.8200000E-01
PD (2)	0.8800000E-01
PD (3)	0.7900000E-01
PD (4)	0.6880000E-01
PD (5)	0.6900000E-01
PD (6)	0.7500000E-01
PD (7)	0.7300000E-01
XD (1)	0.000000
XD (2)	0.000000
XD (3)	0.000000
XD (4)	0.000000
XD (5)	0.000000
XD (6)	0.000000
XD (7)	0.000000
PDA (1)	40248.69
PDA (2)	43193.72
PDA (3)	38776.18
PDA (4)	33769.63
PDA (5)	33867.80
PDA (6)	36812.83
PDA (7)	35831.15

4th. SOLAR FOSSIL FUEL INTEGRATED IN WINTER ONLY

4.1. NO OPTIMIZATION

! This program is to find the minimum collectors area that absorb solar energy enough to run the solar power plant at full load, 7 hrs, a day all the summer months "April:August";

SETS:

APRIL/1..7/:PP,XP,PPA;

MAI/1..7/:PM,XM,PMA;

JUNE/1..7/:PJN,XJN,PJNA;

JULY/1..7/:PJL,XJL,PJLA;

AUGUST/1..7/:PG,XG,PGA;

JANUARY/1..7/:PJ,XJ,PJA,PFJ;

FEBRUARY/1..7/:PF,XF,PFA,PFF;

MARCH/1..7/:PR,XR,PRA,PFR;

SEPTEMBER/1..7/:PS,XS,PSA;

OCTOBER/1..7/:POC,XOC,POCA,PFOC;

NOVMEBR/1..7/:PN,XN,PNA,PFN;

DECEMBER/1..7/:PD,XD,PDA,PFD;

ENDSETS

DATA:

PJ= 0.07738,0.09353,0.08583,0.08194,0.08268,0.09172,0.09496;

PF=0.09576,0.1049,0.1014,0.0983,0.0955,0.10516,0.1107;

PR=0.18849,0.19,0.19,0.19,0.181,0.181,0.18;

PP= 0.192,0.2,0.201,0.202,0.191,0.192,0.1929;

PM=0.18,0.188,0.196,0.201,0.2,0.196,0.186;

PJN=0.205,0.212,0.215,0.2159,0.206,0.213,0.195;

PJL=0.1818,0.1959,0.1986,0.1998,0.2044,0.2,0.2019;

```

PG=0.183,0.197,0.192,0.196,0.188,0.187,0.18;
PS=0.1876,0.193,0.184,0.179,0.172,0.166,0.163;
POC=0.148,0.15,0.147,0.133,0.128,0.137,0.136;
PN=0.158,0.156,0.148,0.136,0.129,0.126,0.119;
PD=0.082,0.088,0.079,0.0688,0.069,0.075,0.073;
ENDDATA

!APRIL (P) ;

@FOR (APRIL (i) :PPA (i) =AREA*PP (i) ) ;
PPT=@SUM (APRIL (i) :PPA (i) ) ;
@FOR (APRIL (i) :PPA (i) >=50000) ;

!MAI (M) ;

@FOR (MAI (i) :PMA (i) =AREA*PM (i) ) ;
PMT=@SUM (MAI (i) :PMA (i) ) ;
@FOR (MAI (i) :PMA (i) >=50000) ;

!JUNE (JN) ;

@FOR (JUNE (i) :PJNA (i) =AREA*PJN (i) ) ;
PJNT=@SUM (JUNE (i) :PJNA (i) ) ;
@FOR (JUNE (i) :PJNA (i) >=50000) ;

!JULY (JL) ;

@FOR (JULY (i) :PJLA (i) =AREA*PJL (i) ) ;
PJLT=@SUM (JULY (i) :PJLA (i) ) ;
@FOR (JULY (i) :PJLA (i) >=50000) ;

!AUGUST (G) ;

@FOR (AUGUST (i) :PGA (i) =AREA*PG (i) ) ;
PGT=@SUM (AUGUST (i) :PGA (i) ) ;
@FOR (AUGUST (i) :PGA (i) >=50000) ;

!SEPTEMBER;

@FOR (SEPTEMBER (i) :PsA (i) =AREA*Ps (i) ) ;
PsT=@SUM (SEPTEMBER (i) :PsA (i) ) ;

```

```

@FOR (SEPTEMBER (i) : PSA (i) >= 50000);

!!!!!!!!!!!!!!!!!!!!!!!!!!!!!!!!!!!!!!!!!!!!!!!!!!!!!!;

!THE WINTER WILL RUN USING FUEL & SOLAR TOGETHER TO GET FULL LOAD;

!october;

@FOR (OCTOBER (i) : POCA (i) = AREA * POC (i));

@FOR (OCTOBER (i) : (POCA (i) + PFOC (i)) >= 50000);

POCT = @SUM (OCTOBER (i) : POCA (i));

PFOCT = @SUM (OCTOBER (i) : PFOC (i));

PTOC = @SUM (OCTOBER (i) : (POCA (i) + PFOC (i)));

!NOVMEBR;

@FOR (NOVMEBR (i) : PNA (i) = AREA * PN (i));

@FOR (NOVMEBR (i) : (PNA (i) + PFN (i)) >= 50000);

PNT = @SUM (NOVMEBR (i) : PNA (i));

PFNT = @SUM (NOVMEBR (i) : PFN (i));

PTN = @SUM (NOVMEBR (i) : (PNA (i) + PFN (i)));

!DECEMBER;

@FOR (DECEMBER (i) : PDA (i) = AREA * PD (i));

@FOR (DECEMBER (i) : (PDA (i) + PFD (i)) >= 50000);

PDT = @SUM (DECEMBER (i) : PDA (i));

PFDT = @SUM (DECEMBER (i) : PFD (i));

PTD = @SUM (DECEMBER (i) : (PDA (i) + PFD (i)));

!JANUARY;

@FOR (JANUARY (i) : PJA (i) = AREA * PJ (i));

@FOR (JANUARY (i) : (PJA (i) + PFJ (i)) >= 50000);

PJT = @SUM (JANUARY (i) : PJA (i));

PFJT = @SUM (JANUARY (i) : PFJ (i));

PTJ = @SUM (JANUARY (i) : (PJA (i) + PFJ (i)));

!FEBRUARY;

@FOR (FEBRUARY (i) : PFA (i) = AREA * PF (i));

```

```

@FOR (FEBRUARY (i) : (PFA (i) + PFF (i)) >= 50000);

PFT=@SUM (FEBRUARY (i) : PFA (i));

PFFT=@SUM (FEBRUARY (i) : PFF (i));

PTD=@SUM (FEBRUARY (i) : (PFA (i) + PFF (i)));

!MARCH;

@FOR (MARCH (i) : PRA (i) = AREA * PR (i));

@FOR (MARCH (i) : (PRA (i) + PFR (i)) >= 50000);

PRT=@SUM (MARCH (i) : PRA (i));

PFRT=@SUM (MARCH (i) : PFR (i));

PTR=@SUM (MARCH (i) : (PRA (i) + PFR (i)));

PT_SUMMER=30 * PPT + 31 * PMT + 30 * PJNT + 31 * PJLT + 31 * PGT;

P_Annual=PT_Summer+PT_WINTER;

PT_WINTER=31 * PRT + 31 * PJT + 28 * PFT + 31 * POCT + 31 * PDT;

PFUEL=31 * PFOCT + 30 * PFNT + 31 * PFDT + 31 * PFJT + 28 * PFFT + 31 * PFRT;

RATIO=PFUEL/P_Annual;

RATIO<=(1/3);

Net_Ele =(1-0.084) * (P_Annual+PFUEL);

CO_Reduction=300*Area;

Fuel_saver=Net_Ele /301790;

Full_HRS=Net_Ele /50000;

Net_Ele =(1-0.084) * (P_Annual+PFUEL);

LEC=( (302*AREA+592*N_P) * 0.104+OM_HYBRID*Net_Ele+FUEL_COST )/Net_Ele ;

N_P=50000;

OM_HYBRID=0.018;

FUEL_COST =0.028*PFUEL;

```

- Lingo output

Feasible solution found.

Total solver iterations:

4

Variable	Value
AREA	317280.7
PPT	434960.2
PMT	427377.1
PJNT	463832.7
PJLT	438608.9
PGT	419762.4
PST	394887.6
POCT	310617.8
PFOCT	39382.16
PTOC	350000.0
PNT	308396.9
PFNT	43265.56
PTN	351662.4
PDT	169681.7
PFDT	180318.3
PTD	350000.0
PJT	192919.4
PFJT	157080.6
PTJ	350000.0
PFT	225815.0
PFFT	124185.0
PRT	412620.4
PFRT	0.000000
PTR	412620.4
PT_SUMMER	0.6682199E+08

P_ANNUAL	0.1068058E+09
PT_WINTER	0.3998384E+08
PFUEL	0.1645536E+08
RATIO	0.1540680
NET_ELE	0.1129072E+09
CO_REDUCTION	0.9518422E+08
FUEL_SAVER	374.1252
FULL_HRS	2258.145
LEC	0.1376053
N_P	50000.00
OM_HYBRID	0.1800000E-01
FUEL_COST	460750.0
PP (1)	0.1920000
PP (2)	0.2000000
PP (3)	0.2010000
PP (4)	0.2020000
PP (5)	0.1910000
PP (6)	0.1920000
PP (7)	0.1929000
XP (1)	0.000000
XP (2)	0.000000
XP (3)	0.000000
XP (4)	0.000000
XP (5)	0.000000
XP (6)	0.000000
XP (7)	0.000000
PPA (1)	60917.90
PPA (2)	63456.15
PPA (3)	63773.43

PPA (4)	64090.71
PPA (5)	60600.62
PPA (6)	60917.90
PPA (7)	61203.45
PM (1)	0.1800000
PM (2)	0.1880000
PM (3)	0.1960000
PM (4)	0.2010000
PM (5)	0.2000000
PM (6)	0.1960000
PM (7)	0.1860000
XM (1)	0.0000000
XM (2)	0.0000000
XM (3)	0.0000000
XM (4)	0.0000000
XM (5)	0.0000000
XM (6)	0.0000000
XM (7)	0.0000000
PMA (1)	57110.53
PMA (2)	59648.78
PMA (3)	62187.02
PMA (4)	63773.43
PMA (5)	63456.15
PMA (6)	62187.02
PMA (7)	59014.22
PJN (1)	0.2050000
PJN (2)	0.2120000
PJN (3)	0.2150000
PJN (4)	0.2159000

PJN (5)	0.2060000
PJN (6)	0.2130000
PJN (7)	0.1950000
XJN (1)	0.0000000
XJN (2)	0.0000000
XJN (3)	0.0000000
XJN (4)	0.0000000
XJN (5)	0.0000000
XJN (6)	0.0000000
XJN (7)	0.0000000
PJNA (1)	65042.55
PJNA (2)	67263.52
PJNA (3)	68215.36
PJNA (4)	68500.91
PJNA (5)	65359.83
PJNA (6)	67580.80
PJNA (7)	61869.74
PJL (1)	0.1818000
PJL (2)	0.1959000
PJL (3)	0.1986000
PJL (4)	0.1998000
PJL (5)	0.2044000
PJL (6)	0.2000000
PJL (7)	0.2019000
XJL (1)	0.0000000
XJL (2)	0.0000000
XJL (3)	0.0000000
XJL (4)	0.0000000
XJL (5)	0.0000000

XJL (6)	0.000000
XJL (7)	0.000000
PJLA (1)	57681.64
PJLA (2)	62155.30
PJLA (3)	63011.95
PJLA (4)	63392.69
PJLA (5)	64852.18
PJLA (6)	63456.15
PJLA (7)	64058.98
PG (1)	0.1830000
PG (2)	0.1970000
PG (3)	0.1920000
PG (4)	0.1960000
PG (5)	0.1880000
PG (6)	0.1870000
PG (7)	0.1800000
XG (1)	0.000000
XG (2)	0.000000
XG (3)	0.000000
XG (4)	0.000000
XG (5)	0.000000
XG (6)	0.000000
XG (7)	0.000000
PGA (1)	58062.37
PGA (2)	62504.30
PGA (3)	60917.90
PGA (4)	62187.02
PGA (5)	59648.78
PGA (6)	59331.50

PGA (7)	57110.53
PJ (1)	0.7738000E-01
PJ (2)	0.9353000E-01
PJ (3)	0.8583000E-01
PJ (4)	0.8194000E-01
PJ (5)	0.8268000E-01
PJ (6)	0.9172000E-01
PJ (7)	0.9496000E-01
XJ (1)	0.000000
XJ (2)	0.000000
XJ (3)	0.000000
XJ (4)	0.000000
XJ (5)	0.000000
XJ (6)	0.000000
XJ (7)	0.000000
PJA (1)	24551.18
PJA (2)	29675.27
PJA (3)	27232.21
PJA (4)	25997.98
PJA (5)	26232.77
PJA (6)	29100.99
PJA (7)	30128.98
PFJ (1)	25448.82
PFJ (2)	20324.73
PFJ (3)	22767.79
PFJ (4)	24002.02
PFJ (5)	23767.23
PFJ (6)	20899.01
PFJ (7)	19871.02

PF (1)	0.9576000E-01
PF (2)	0.1049000
PF (3)	0.1014000
PF (4)	0.9830000E-01
PF (5)	0.9550000E-01
PF (6)	0.1051600
PF (7)	0.1107000
XF (1)	0.000000
XF (2)	0.000000
XF (3)	0.000000
XF (4)	0.000000
XF (5)	0.000000
XF (6)	0.000000
XF (7)	0.000000
PFA (1)	30382.80
PFA (2)	33282.75
PFA (3)	32172.27
PFA (4)	31188.70
PFA (5)	30300.31
PFA (6)	33365.24
PFA (7)	35122.98
PFF (1)	19617.20
PFF (2)	16717.25
PFF (3)	17827.73
PFF (4)	18811.30
PFF (5)	19699.69
PFF (6)	16634.76
PFF (7)	14877.02
PR (1)	0.1884900

PR(2)	0.1900000
PR(3)	0.1900000
PR(4)	0.1900000
PR(5)	0.1810000
PR(6)	0.1810000
PR(7)	0.1800000
XR(1)	0.000000
XR(2)	0.000000
XR(3)	0.000000
XR(4)	0.000000
XR(5)	0.000000
XR(6)	0.000000
XR(7)	0.000000
PRA(1)	59804.25
PRA(2)	60283.34
PRA(3)	60283.34
PRA(4)	60283.34
PRA(5)	57427.81
PRA(6)	57427.81
PRA(7)	57110.53
PFR(1)	0.000000
PFR(2)	0.000000
PFR(3)	0.000000
PFR(4)	0.000000
PFR(5)	0.000000
PFR(6)	0.000000
PFR(7)	0.000000
PS(1)	0.1876000
PS(2)	0.1930000

PS (3)	0.1840000
PS (4)	0.1790000
PS (5)	0.1720000
PS (6)	0.1660000
PS (7)	0.1630000
XS (1)	0.000000
XS (2)	0.000000
XS (3)	0.000000
XS (4)	0.000000
XS (5)	0.000000
XS (6)	0.000000
XS (7)	0.000000
PSA (1)	59521.87
PSA (2)	61235.18
PSA (3)	58379.65
PSA (4)	56793.25
PSA (5)	54572.29
PSA (6)	52668.60
PSA (7)	51716.76
POC (1)	0.1480000
POC (2)	0.1500000
POC (3)	0.1470000
POC (4)	0.1330000
POC (5)	0.1280000
POC (6)	0.1370000
POC (7)	0.1360000
XOC (1)	0.000000
XOC (2)	0.000000
XOC (3)	0.000000

XOC (4)	0.000000
XOC (5)	0.000000
XOC (6)	0.000000
XOC (7)	0.000000
POCA (1)	46957.55
POCA (2)	47592.11
POCA (3)	46640.27
POCA (4)	42198.34
POCA (5)	40611.93
POCA (6)	43467.46
POCA (7)	43150.18
PFOC (1)	3042.452
PFOC (2)	2407.890
PFOC (3)	3359.732
PFOC (4)	7801.663
PFOC (5)	9388.066
PFOC (6)	6532.540
PFOC (7)	6849.820
PN (1)	0.1580000
PN (2)	0.1560000
PN (3)	0.1480000
PN (4)	0.1360000
PN (5)	0.1290000
PN (6)	0.1260000
PN (7)	0.1190000
XN (1)	0.000000
XN (2)	0.000000
XN (3)	0.000000
XN (4)	0.000000

XN (5)	0.000000
XN (6)	0.000000
XN (7)	0.000000
PNA (1)	50130.36
PNA (2)	49495.79
PNA (3)	46957.55
PNA (4)	43150.18
PNA (5)	40929.21
PNA (6)	39977.37
PNA (7)	37756.41
PFN (1)	1532.075
PFN (2)	504.2057
PFN (3)	3042.452
PFN (4)	6849.820
PFN (5)	9070.786
PFN (6)	10022.63
PFN (7)	12243.59
PD (1)	0.8200000E-01
PD (2)	0.8800000E-01
PD (3)	0.7900000E-01
PD (4)	0.6880000E-01
PD (5)	0.6900000E-01
PD (6)	0.7500000E-01
PD (7)	0.7300000E-01
XD (1)	0.000000
XD (2)	0.000000
XD (3)	0.000000
XD (4)	0.000000
XD (5)	0.000000

XD (6)	0.000000
XD (7)	0.000000
PDA (1)	26017.02
PDA (2)	27920.70
PDA (3)	25065.18
PDA (4)	21828.91
PDA (5)	21892.37
PDA (6)	23796.05
PDA (7)	23161.49
PFD (1)	23982.98
PFD (2)	22079.30
PFD (3)	24934.82
PFD (4)	28171.09
PFD (5)	28107.63
PFD (6)	26203.95
PFD (7)	26838.51

4.2. MAXIMIZE SOLAR TO FOSSIL FUEL RATIO

- Lingo input

! This program is to find the minimum collectors area that absorb solar energy enough to run the solar power plant at full load, 7 hrs, a day all the summer months "April:August";

max=ratio;

SETS:

APRIL/1..7/:PP,XP,PPA;

MAI/1..7/:PM,XM,PMA;

```

JUNE/1..7/:PJN,XJN,PJNA;
JULY/1..7/:PJL,XJL,PJLA;
AUGUST/1..7/:PG,XG,PGA;
JANUARY/1..7/:PJ,XJ,PJA,PFJ;
FEBRUARY/1..7/:PF,XF,PFA,PPF;
MARCH/1..7/:PR,XR,PRA,PFR;
SEPTEMBER/1..7/:PS,XS,PSA;
OCTOBER/1..7/:POC,XOC,POCA,PFOC;
NOVMEBR/1..7/:PN,XN,PNA,PFN;
DECEMBER/1..7/:PD,XD,PDA,PDF;

ENDSETS

DATA:
PJ= 0.07738,0.09353,0.08583,0.08194,0.08268,0.09172,0.09496;
PF=0.09576,0.1049,0.1014,0.0983,0.0955,0.10516,0.1107;
PR=0.18849,0.19,0.19,0.19,0.181,0.181,0.18;
PP= 0.192,0.2,0.201,0.202,0.191,0.192,0.1929;
PM=0.18,0.188,0.196,0.201,0.2,0.196,0.186;
PJN=0.205,0.212,0.215,0.2159,0.206,0.213,0.195;
PJL=0.1818,0.1959,0.1986,0.1998,0.2044,0.2,0.2019;
PG=0.183,0.197,0.192,0.196,0.188,0.187,0.18;
PS=0.1876,0.193,0.184,0.179,0.172,0.166,0.163;
POC=0.148,0.15,0.147,0.133,0.128,0.137,0.136;
PN=0.158,0.156,0.148,0.136,0.129,0.126,0.119;
PD=0.082,0.088,0.079,0.0688,0.069,0.075,0.073;

ENDDATA

!APRIL(P);

@FOR(APRIL(i):PPA(i)=AREA*PP(i));

PPT=@SUM(APRIL(i):PPA(i));

@FOR(APRIL(i):PPA(i)>=50000);

```

```

!MAI (M) ;

@FOR (MAI (i) :PMA (i) =AREA*PM (i) ) ;

PMT=@SUM (MAI (i) :PMA (i) ) ;

@FOR (MAI (i) :PMA (i) >=50000) ;

! JUNE (JN) ;

@FOR (JUNE (i) :PJNA (i) =AREA*PJN (i) ) ;

PJNT=@SUM (JUNE (i) :PJNA (i) ) ;

@FOR (JUNE (i) :PJNA (i) >=50000) ;

! JULY (JL) ;

@FOR (JULY (i) :PJLA (i) =AREA*PJL (i) ) ;

PJLT=@SUM (JULY (i) :PJLA (i) ) ;

@FOR (JULY (i) :PJLA (i) >=50000) ;

! AUGUST (G) ;

@FOR (AUGUST (i) :PGA (i) =AREA*PG (i) ) ;

PGT=@SUM (AUGUST (i) :PGA (i) ) ;

@FOR (AUGUST (i) :PGA (i) >=50000) ;

! SEPTEMBER ;

@FOR (SEPTEMBER (i) :PsA (i) =AREA*Ps (i) ) ;

PsT=@SUM (SEPTEMBER (i) :PsA (i) ) ;

@FOR (SEPTEMBER (i) :PSA (i) >=50000) ;

!!!!!!!!!!!!!!!!!!!!!!!!!!!!!!!!!!!!!!!!!!!!!!!!!!!!!!;

!THE WINTER WILL RUN USING FUEL & SOLAR TOGETHER TO GET FULL LOAD;

!october;

@FOR (OCTOBER (i) :POCA (i) =AREA*POC (i) ) ;

@FOR (OCTOBER (i) : (POCA (i) +PFOC (i) ) >=50000) ;

POCT=@SUM (OCTOBER (i) :POCA (i) ) ;

PFOCT=@SUM (OCTOBER (i) :PFOC (i) ) ;

PTOC=@SUM (OCTOBER (i) : (POCA (i) +PFOC (i) ) ) ;

!NOVMEBR;

```

```

@FOR (NOVMEBR (i) : PNA (i) = AREA * PN (i) );
@FOR (NOVMEBR (i) : (PNA (i) + PFN (i) ) >= 50000 );
PNT = @SUM (NOVMEBR (i) : PNA (i) );
PFNT = @SUM (NOVMEBR (i) : PFN (i) );
PTN = @SUM (NOVMEBR (i) : (PNA (i) + PFN (i) ) );
!DECEMBER;
@FOR (DECEMBER (i) : PDA (i) = AREA * PD (i) );
@FOR (DECEMBER (i) : (PDA (i) + PFD (i) ) >= 50000 );
PDT = @SUM (DECEMBER (i) : PDA (i) );
PFDT = @SUM (DECEMBER (i) : PFD (i) );
PTD = @SUM (DECEMBER (i) : (PDA (i) + PFD (i) ) );
!JANUARY;
@FOR (JANUARY (i) : PJA (i) = AREA * PJ (i) );
@FOR (JANUARY (i) : (PJA (i) + PFJ (i) ) >= 50000 );
PJT = @SUM (JANUARY (i) : PJA (i) );
PFJT = @SUM (JANUARY (i) : PFJ (i) );
PTJ = @SUM (JANUARY (i) : (PJA (i) + PFJ (i) ) );
!FEBRUARY;
@FOR (FEBRUARY (i) : PFA (i) = AREA * PF (i) );
@FOR (FEBRUARY (i) : (PFA (i) + PFF (i) ) >= 50000 );
PFT = @SUM (FEBRUARY (i) : PFA (i) );
PFFT = @SUM (FEBRUARY (i) : PFF (i) );
PTD = @SUM (FEBRUARY (i) : (PFA (i) + PFF (i) ) );
!MARCH;
@FOR (MARCH (i) : PRA (i) = AREA * PR (i) );
@FOR (MARCH (i) : (PRA (i) + PFR (i) ) >= 50000 );
PRT = @SUM (MARCH (i) : PRA (i) );
PFRT = @SUM (MARCH (i) : PFR (i) );
PTR = @SUM (MARCH (i) : (PRA (i) + PFR (i) ) );

```

```

PT_SUMMER=30*PPT+31*PMT+30*PJNT+31*PJLT+31*PGT;
P_Annual=PT_Summer+PT_WINTER;
PT_WINTER=31*PRT+31*PJT+28*PFT+31*POCT+31*PDT;
PFUEL=31*PFOCT+30*PFNT+31*PFDT+31*PFJT+28*PFFT+31*PFRT;
RATIO=PFUEL/P_Annual;
RATIO<=(1/3);
Net_Ele =(1-0.084)*(P_Annual+PFUEL);
CO_Reduction=300*Area;
Fuel_saver=Net_Ele /301790;
Full_HRS=Net_Ele /50000;
Net_Ele =(1-0.084)*(P_Annual+PFUEL);
LEC=((302*AREA+592*N_P)*0.104+OM_HYBRID*Net_Ele+FUEL_COST )/Net_Ele ;
N_P=50000;
OM_HYBRID=0.018;
FUEL_COST =0.028*PFUEL;

```

Local optimal solution found.

```

Objective value:                0.3333333
Total solver iterations:        126

```

Variable	Value	Reduced Cost
RATIO	0.3333333	0.000000
AREA	306748.5	0.000000
PPT	420521.5	0.000000
PMT	413190.2	0.000000
PJNT	448435.6	0.000000
PJLT	424049.1	0.000000
PGT	405828.2	0.000000

PST	381779.1	0.000000
POCT	300306.7	0.000000
PFOCT	49693.25	0.000000
PTOC	350000.0	0.000000
PNT	298159.5	0.000000
PFNT	51840.49	0.000000
PTN	350000.0	0.000000
PDT	164049.1	0.000000
PFDT	470791.5	0.000000
PTD	634840.6	0.000000
PJT	186515.3	0.000000
PFJT	163484.7	0.000000
PTJ	350000.0	0.000000
PFT	218319.0	0.000000
PFFT	416521.6	0.000000
PRT	398923.3	0.000000
PFRT	0.000000	0.000000
PTR	398923.3	0.000000
PT_SUMMER	0.6460380E+08	0.000000
P_ANNUAL	0.1032604E+09	0.000000
PT_WINTER	0.3865656E+08	0.000000
PFUEL	0.3442087E+08	0.000000
NET_ELE	0.1261160E+09	0.000000
CO_REDUCTION	0.9202454E+08	0.000000
FUEL_SAVER	417.8933	0.000000
FULL_HRS	2522.320	0.000000
LEC	0.1264406	0.000000
N_P	50000.00	0.000000
OM_HYBRID	0.1800000E-01	0.000000

FUEL_COST	963784.4	0.000000
PP (1)	0.1920000	0.000000
PP (2)	0.2000000	0.000000
PP (3)	0.2010000	0.000000
PP (4)	0.2020000	0.000000
PP (5)	0.1910000	0.000000
PP (6)	0.1920000	0.000000
PP (7)	0.1929000	0.000000
XP (1)	0.000000	0.000000
XP (2)	0.000000	0.000000
XP (3)	0.000000	0.000000
XP (4)	0.000000	0.000000
XP (5)	0.000000	0.000000
XP (6)	0.000000	0.000000
XP (7)	0.000000	0.000000
PPA (1)	58895.71	0.000000
PPA (2)	61349.69	0.000000
PPA (3)	61656.44	0.000000
PPA (4)	61963.19	0.000000
PPA (5)	58588.96	0.000000
PPA (6)	58895.71	0.000000
PPA (7)	59171.78	0.000000
PM (1)	0.1800000	0.000000
PM (2)	0.1880000	0.000000
PM (3)	0.1960000	0.000000
PM (4)	0.2010000	0.000000
PM (5)	0.2000000	0.000000
PM (6)	0.1960000	0.000000
PM (7)	0.1860000	0.000000

XM (1)	0.000000	0.000000
XM (2)	0.000000	0.000000
XM (3)	0.000000	0.000000
XM (4)	0.000000	0.000000
XM (5)	0.000000	0.000000
XM (6)	0.000000	0.000000
XM (7)	0.000000	0.000000
PMA (1)	55214.72	0.000000
PMA (2)	57668.71	0.000000
PMA (3)	60122.70	0.000000
PMA (4)	61656.44	0.000000
PMA (5)	61349.69	0.000000
PMA (6)	60122.70	0.000000
PMA (7)	57055.21	0.000000
PJN (1)	0.2050000	0.000000
PJN (2)	0.2120000	0.000000
PJN (3)	0.2150000	0.000000
PJN (4)	0.2159000	0.000000
PJN (5)	0.2060000	0.000000
PJN (6)	0.2130000	0.000000
PJN (7)	0.1950000	0.000000
XJN (1)	0.000000	0.000000
XJN (2)	0.000000	0.000000
XJN (3)	0.000000	0.000000
XJN (4)	0.000000	0.000000
XJN (5)	0.000000	0.000000
XJN (6)	0.000000	0.000000
XJN (7)	0.000000	0.000000
PJNA (1)	62883.44	0.000000

PJNA (2)	65030.67	0.000000
PJNA (3)	65950.92	0.000000
PJNA (4)	66226.99	0.000000
PJNA (5)	63190.18	0.000000
PJNA (6)	65337.42	0.000000
PJNA (7)	59815.95	0.000000
PJL (1)	0.1818000	0.000000
PJL (2)	0.1959000	0.000000
PJL (3)	0.1986000	0.000000
PJL (4)	0.1998000	0.000000
PJL (5)	0.2044000	0.000000
PJL (6)	0.2000000	0.000000
PJL (7)	0.2019000	0.000000
XJL (1)	0.000000	0.000000
XJL (2)	0.000000	0.000000
XJL (3)	0.000000	0.000000
XJL (4)	0.000000	0.000000
XJL (5)	0.000000	0.000000
XJL (6)	0.000000	0.000000
XJL (7)	0.000000	0.000000
PJLA (1)	55766.87	0.000000
PJLA (2)	60092.02	0.000000
PJLA (3)	60920.25	0.000000
PJLA (4)	61288.34	0.000000
PJLA (5)	62699.39	0.000000
PJLA (6)	61349.69	0.000000
PJLA (7)	61932.52	0.000000
PG (1)	0.1830000	0.000000
PG (2)	0.1970000	0.000000

PG (3)	0.1920000	0.000000
PG (4)	0.1960000	0.000000
PG (5)	0.1880000	0.000000
PG (6)	0.1870000	0.000000
PG (7)	0.1800000	0.000000
XG (1)	0.000000	0.000000
XG (2)	0.000000	0.000000
XG (3)	0.000000	0.000000
XG (4)	0.000000	0.000000
XG (5)	0.000000	0.000000
XG (6)	0.000000	0.000000
XG (7)	0.000000	0.000000
PGA (1)	56134.97	0.000000
PGA (2)	60429.45	0.000000
PGA (3)	58895.71	0.000000
PGA (4)	60122.70	0.000000
PGA (5)	57668.71	0.000000
PGA (6)	57361.96	0.000000
PGA (7)	55214.72	0.000000
PJ (1)	0.7738000E-01	0.000000
PJ (2)	0.9353000E-01	0.000000
PJ (3)	0.8583000E-01	0.000000
PJ (4)	0.8194000E-01	0.000000
PJ (5)	0.8268000E-01	0.000000
PJ (6)	0.9172000E-01	0.000000
PJ (7)	0.9496000E-01	0.000000
XJ (1)	0.000000	0.000000
XJ (2)	0.000000	0.000000
XJ (3)	0.000000	0.000000

XJ (4)	0.000000	0.000000
XJ (5)	0.000000	0.000000
XJ (6)	0.000000	0.000000
XJ (7)	0.000000	0.000000
PJA (1)	23736.20	0.000000
PJA (2)	28690.18	0.000000
PJA (3)	26328.22	0.000000
PJA (4)	25134.97	0.000000
PJA (5)	25361.96	0.000000
PJA (6)	28134.97	0.000000
PJA (7)	29128.83	0.000000
PFJ (1)	26263.80	0.000000
PFJ (2)	21309.82	0.000000
PFJ (3)	23671.78	0.000000
PFJ (4)	24865.03	0.000000
PFJ (5)	24638.04	0.000000
PFJ (6)	21865.03	0.000000
PFJ (7)	20871.17	0.000000
PF (1)	0.9576000E-01	0.000000
PF (2)	0.1049000	0.000000
PF (3)	0.1014000	0.000000
PF (4)	0.9830000E-01	0.000000
PF (5)	0.9550000E-01	0.000000
PF (6)	0.1051600	0.000000
PF (7)	0.1107000	0.000000
XF (1)	0.000000	0.000000
XF (2)	0.000000	0.000000
XF (3)	0.000000	0.000000
XF (4)	0.000000	0.000000

XF (5)	0.000000	0.000000
XF (6)	0.000000	0.000000
XF (7)	0.000000	0.000000
PFA (1)	29374.23	0.000000
PFA (2)	32177.91	0.000000
PFA (3)	31104.29	0.000000
PFA (4)	30153.37	0.000000
PFA (5)	29294.48	0.000000
PFA (6)	32257.67	0.000000
PFA (7)	33957.06	0.000000
PFF (1)	305466.4	0.000000
PFF (2)	17822.09	0.000000
PFF (3)	18895.71	0.000000
PFF (4)	19846.63	0.000000
PFF (5)	20705.52	0.000000
PFF (6)	17742.33	0.000000
PFF (7)	16042.94	0.000000
PR (1)	0.1884900	0.000000
PR (2)	0.1900000	0.000000
PR (3)	0.1900000	0.000000
PR (4)	0.1900000	0.000000
PR (5)	0.1810000	0.000000
PR (6)	0.1810000	0.000000
PR (7)	0.1800000	0.000000
XR (1)	0.000000	0.000000
XR (2)	0.000000	0.000000
XR (3)	0.000000	0.000000
XR (4)	0.000000	0.000000
XR (5)	0.000000	0.000000

XR (6)	0.000000	0.000000
XR (7)	0.000000	0.000000
PRA (1)	57819.02	0.000000
PRA (2)	58282.21	0.000000
PRA (3)	58282.21	0.000000
PRA (4)	58282.21	0.000000
PRA (5)	55521.47	0.000000
PRA (6)	55521.47	0.000000
PRA (7)	55214.72	0.000000
PFR (1)	0.000000	0.000000
PFR (2)	0.000000	0.000000
PFR (3)	0.000000	0.000000
PFR (4)	0.000000	0.000000
PFR (5)	0.000000	0.000000
PFR (6)	0.000000	0.000000
PFR (7)	0.000000	0.000000
PS (1)	0.1876000	0.000000
PS (2)	0.1930000	0.000000
PS (3)	0.1840000	0.000000
PS (4)	0.1790000	0.000000
PS (5)	0.1720000	0.000000
PS (6)	0.1660000	0.000000
PS (7)	0.1630000	0.000000
XS (1)	0.000000	0.000000
XS (2)	0.000000	0.000000
XS (3)	0.000000	0.000000
XS (4)	0.000000	0.000000
XS (5)	0.000000	0.000000
XS (6)	0.000000	0.000000

XS (7)	0.000000	0.000000
PSA (1)	57546.01	0.000000
PSA (2)	59202.45	0.000000
PSA (3)	56441.72	0.000000
PSA (4)	54907.98	0.000000
PSA (5)	52760.74	0.000000
PSA (6)	50920.25	0.000000
PSA (7)	50000.00	0.000000
POC (1)	0.1480000	0.000000
POC (2)	0.1500000	0.000000
POC (3)	0.1470000	0.000000
POC (4)	0.1330000	0.000000
POC (5)	0.1280000	0.000000
POC (6)	0.1370000	0.000000
POC (7)	0.1360000	0.000000
XOC (1)	0.000000	0.000000
XOC (2)	0.000000	0.000000
XOC (3)	0.000000	0.000000
XOC (4)	0.000000	0.000000
XOC (5)	0.000000	0.000000
XOC (6)	0.000000	0.000000
XOC (7)	0.000000	0.000000
POCA (1)	45398.77	0.000000
POCA (2)	46012.27	0.000000
POCA (3)	45092.02	0.000000
POCA (4)	40797.55	0.000000
POCA (5)	39263.80	0.000000
POCA (6)	42024.54	0.000000
POCA (7)	41717.79	0.000000

PFOC (1)	4601.227	0.000000
PFOC (2)	3987.730	0.000000
PFOC (3)	4907.975	0.000000
PFOC (4)	9202.454	0.000000
PFOC (5)	10736.20	0.000000
PFOC (6)	7975.460	0.000000
PFOC (7)	8282.209	0.000000
PN (1)	0.1580000	0.000000
PN (2)	0.1560000	0.000000
PN (3)	0.1480000	0.000000
PN (4)	0.1360000	0.000000
PN (5)	0.1290000	0.000000
PN (6)	0.1260000	0.000000
PN (7)	0.1190000	0.000000
XN (1)	0.000000	0.000000
XN (2)	0.000000	0.000000
XN (3)	0.000000	0.000000
XN (4)	0.000000	0.000000
XN (5)	0.000000	0.000000
XN (6)	0.000000	0.000000
XN (7)	0.000000	0.000000
PNA (1)	48466.26	0.000000
PNA (2)	47852.76	0.000000
PNA (3)	45398.77	0.000000
PNA (4)	41717.79	0.000000
PNA (5)	39570.55	0.000000
PNA (6)	38650.31	0.000000
PNA (7)	36503.07	0.000000
PFN (1)	1533.742	0.000000

PFN (2)	2147.239	0.000000
PFN (3)	4601.227	0.000000
PFN (4)	8282.209	0.000000
PFN (5)	10429.45	0.000000
PFN (6)	11349.69	0.000000
PFN (7)	13496.93	0.000000
PD (1)	0.8200000E-01	0.000000
PD (2)	0.8800000E-01	0.000000
PD (3)	0.7900000E-01	0.000000
PD (4)	0.6880000E-01	0.000000
PD (5)	0.6900000E-01	0.000000
PD (6)	0.7500000E-01	0.000000
PD (7)	0.7300000E-01	0.000000
XD (1)	0.000000	0.000000
XD (2)	0.000000	0.000000
XD (3)	0.000000	0.000000
XD (4)	0.000000	0.000000
XD (5)	0.000000	0.000000
XD (6)	0.000000	0.000000
XD (7)	0.000000	0.000000
PDA (1)	25153.37	0.000000
PDA (2)	26993.87	0.000000
PDA (3)	24233.13	0.000000
PDA (4)	21104.29	0.000000
PDA (5)	21165.64	0.000000
PDA (6)	23006.13	0.000000
PDA (7)	22392.64	0.000000
PFD (1)	24846.63	0.000000
PFD (2)	23006.13	0.000000

PFD (3)	25766.87	0.000000
PFD (4)	313736.3	0.000000
PFD (5)	28834.36	0.000000
PFD (6)	26993.87	0.000000
PFD (7)	27607.36	0.000000

5th. SOLAR FOSSIL FUEL ALL THE YEAR

5.1. INTEGRATION WITH NO OPTIMIZATION

- Lingo input

! This program is to find the minimum collectors area that absorb solar energy enough to run the solar power plant at full load (SOalr+fossil), 7 hrs, a day all the summer months "April:August";

SETS:

APRIL/1..7/:PP,XP,PPA,PFAP;

MAI/1..7/:PM,XM,PMA,PFM;

JUNE/1..7/:PJN,XJN,PJNA,PFJN;

JULY/1..7/:PJL,XJL,PJLA,PFJL;

AUGUST/1..7/:PG,XG,PGA,PGF;

SEPTEMBER/1..7/:PS,XS,PSA,PFS;

JANUARY/1..7/:PJ,XJ,PJA,PFJ;

FEBRUARY/1..7/:PF,XF,PFA,PFJ;

MARCH/1..7/:PR,XR,PRA,PRF;

OCTOBER/1..7/:POC,XOC,POCA,PFOC;

NOVMEBR/1..7/:PN,XN,PNA,PFN;

DECEMBER/1..7/:PD,XD,PDA,PDF;

ENDSETS

DATA:

PJ= 0.07738,0.09353,0.08583,0.08194,0.08268,0.09172,0.09496;

PF=0.09576,0.1049,0.1014,0.0983,0.0955,0.10516,0.1107;

PR=0.18849,0.19,0.19,0.19,0.181,0.181,0.18;

PP= 0.192,0.2,0.201,0.202,0.191,0.192,0.1929;

PM=0.18,0.188,0.196,0.201,0.2,0.196,0.186;

PJN=0.205,0.212,0.215,0.2159,0.206,0.213,0.195;

PJL=0.1818,0.1959,0.1986,0.1998,0.2044,0.2,0.2019;

PG=0.183,0.197,0.192,0.196,0.188,0.187,0.18;

PS=0.1876,0.193,0.184,0.179,0.172,0.166,0.163;

POC=0.148,0.15,0.147,0.133,0.128,0.137,0.136;

PN=0.158,0.156,0.148,0.136,0.129,0.126,0.119;

PD=0.082,0.088,0.079,0.0688,0.069,0.075,0.073;

ENDDATA

!APRIL (P) ;

@FOR (APRIL (i) : PPA (i) = AREA * PP (i)) ;

PPT=@SUM (APRIL (i) : PPA (i)) ;

@FOR (APRIL (i) : (PPA (i) + PFAP (i)) >= 50000) ;

PFAPT=@SUM (APRIL (i) : PFAP (i)) ;

P4=@SUM (APRIL (i) : PPA (i) + PFAP (i)) ;

!MAI (M) ;

@FOR (MAI (i) : PMA (i) = AREA * PM (i)) ;

PMT=@SUM (MAI (i) : PMA (i)) ;

@FOR (MAI (i) : (PMA (i) + PFM (i)) >= 50000) ;

PFMT=@SUM (MAI (i) : PFM (i)) ;

P5=@SUM (MAI (i) : PMA (i) + PFM (i)) ;

!JUNE (JN) ;

@FOR (JUNE (i) : PJNA (i) = AREA * PJN (i)) ;

```

PJNT=@SUM(JUNE(i):PJNA(i));
@FOR(JUNE(i):(PJNA(i)+PFJN(i))>=50000);
PFJNT=@SUM(JUNE(i):PFJN(i));
P6=@SUM(JUNE(i):PJNA(i)+PFJN(i));
!JULY(JL);
@FOR(JULY(i):PJLA(i)=AREA*PJL(i));
PJLT=@SUM(JULY(i):PJLA(i));
@FOR(JULY(i):(PJLA(i)+PFJL(i))>=50000);
PFJLT=@SUM(JULY(i):PFJL(i));
P7=@SUM(JULY(i):PJLA(i)+PFJL(i));
!AUGUST(G);
@FOR(AUGUST(i):PGA(i)=AREA*PG(i));
PGT=@SUM(AUGUST(i):PGA(i));
@FOR(AUGUST(i):(PGA(i)+PFG(i))>=50000);
PFGT=@SUM(AUGUST(i):PFG(i));
P8=@SUM(AUGUST(i):PGA(i)+PFG(i));
!SEPTEMBER;
@FOR(SEPTEMBER(i):PsA(i)=AREA*Ps(i));
PsT=@SUM(SEPTEMBER(i):PsA(i));
@FOR(SEPTEMBER(i):(PSA(i)+PFS(i))>=50000);
PFST=@SUM(SEPTEMBER(i):PFs(i));
P9=@SUM(SEPTEMBER(i):PSA(i)+PFS(i));
!!!!!!!!!!!!!!!!!!!!!!!!!!!!!!!!!!!!!!!!!!!!!!;
!THE WINTER WILL RUN USING FUEL & SOLAR TOGETHER TO GET FULL LOAD;
!october;
@FOR(OCTOBER(i):POCA(i)=AREA*POC(i));
@FOR(OCTOBER(i):(POCA(i)+PFOC(i))>=50000);
POCT=@SUM(OCTOBER(i):POCA(i));
PFOCT=@SUM(OCTOBER(i):PFOC(i));

```

```

PTOC=@SUM(OCTOBER(i):(POCA(i)+PFOC(i)));
P10=@SUM(OCTOBER(i):POCA(i)+PFOC(i));
!NOVMEBR;
@FOR(NOVMEBR(i):PNA(i)=AREA*PN(i));
@FOR(NOVMEBR(i):(PNA(i)+PFN(i))>=50000);
PNT=@SUM(NOVMEBR(i):PNA(i));
PFNT=@SUM(NOVMEBR(i):PFN(i));
PTN=@SUM(NOVMEBR(i):(PNA(i)+PFN(i)));
P11=@SUM(NOVMEBR(i):PNA(i)+PFN(i));
!DECEMBER;
@FOR(DECEMBER(i):PDA(i)=AREA*PD(i));
@FOR(DECEMBER(i):(PDA(i)+PFD(i))>=50000);
PDT=@SUM(DECEMBER(i):PDA(i));
PFDT=@SUM(DECEMBER(i):PFD(i));
PTD=@SUM(DECEMBER(i):(PDA(i)+PFD(i)));
P12=@SUM(DECEMBER(i):PDA(i)+PFD(i));
@FOR(JANUARY(i):PJA(i)=AREA*PJ(i));
@FOR(JANUARY(i):(PJA(i)+PFJ(i))>=50000);
PJT=@SUM(JANUARY(i):PJA(i));
PFJT=@SUM(JANUARY(i):PFJ(i));
PTJ=@SUM(JANUARY(i):(PJA(i)+PFJ(i)));
P1=@SUM(JANUARY(i):PJA(i)+PFJ(i));
!FEBRUARY;
@FOR(FEBRUARY(i):PFA(i)=AREA*PF(i));
@FOR(FEBRUARY(i):(PFA(i)+PFF(i))>=50000);
PFT=@SUM(FEBRUARY(i):PFA(i));
PFFT=@SUM(FEBRUARY(i):PFF(i));
PTD=@SUM(FEBRUARY(i):(PFA(i)+PFF(i)));
P2=@SUM(FEBRUARY(i):PFA(i)+PFF(i));

```

```

!MARCH;

@FOR (MARCH (i) : PRA (i) = AREA * PR (i) );

@FOR (MARCH (i) : (PRA (i) + PFR (i) ) >= 50000 );

PRT = @SUM (MARCH (i) : PRA (i) );

PFRT = @SUM (MARCH (i) : PFR (i) );

PTR = @SUM (MARCH (i) : (PRA (i) + PFR (i) ) );

P3 = @SUM (MARCH (i) : PMA (i) + PFM (i) );

P_ANNUAL = 31 * P1 + 28 * P2 + 31 * P3 + 30 * P4 + P5 * 31 + P6 * 30 + P7 * 31 + P8 * 31 + P9 * 30 + P10 * 31 + P
11 * 30 + P12 * 31;

PFUEL = 31 * PFOCT + 30 * PFNT + 31 * PFDT + 31 * PFJT + 28 * PFFT + 31 * PFRT + 30 * PFAPT + 31 * PFMT
+ 30 * PFJNT + 31 * PFJLT + 31 * PFGT + 30 * PFST;

RATIO = PFUEL / (P_Annual + PFUEL);

RATIO <= (0.25);

Net_Ele = (1 - 0.084) * (P_Annual + PFUEL);

LEC = ( (302 * AREA + 592 * N_P) * 0.104 + OM_HYBRID * Net_Ele + FUEL_COST ) / Net_Ele ;

N_P = 50000;

OM_HYBRID = 0.018;

FUEL_COST = 0.028 * PFUEL;

!FUEL_COST IS 0.028$/KWhe, THAT EQUAL 8$/MBTU;

```

- Lingo output

Feasible solution found.

Total solver iterations: 186

Variable	Value
AREA	250000.0
PPT	342725.0

PFAPT	8025.000
P4	350750.0
PMT	336750.0
PFMT	13500.00
P5	350250.0
PJNT	365475.0
PFJNT	1250.000
P6	366725.0
PJLT	345600.0
PFJLT	5975.000
P7	351575.0
PGT	330750.0
PFGT	19250.00
P8	350000.0
PST	311150.0
PFST	38850.00
P9	350000.0
POCT	244750.0
PFOCT	105250.0
PTOC	350000.0
P10	350000.0
PNT	243000.0
PFNT	107000.0
PTN	350000.0
P11	350000.0
PDT	133700.0
PFDT	216300.0
PTD	350000.0
P12	350000.0

PJT	152010.0
PFJT	197990.0
PTJ	350000.0
P1	350000.0
PFT	177930.0
PFFT	172070.0
P2	350000.0
PRT	325122.5
PFRT	24877.50
PTR	350000.0
P3	350250.0
P_ANNUAL	0.1283386E+09
PFUEL	0.2754913E+08
RATIO	0.1767289
NET_ELE	0.1427931E+09
LEC	0.9994840E-01
N_P	50000.00
OM_HYBRID	0.1800000E-01
FUEL_COST	771375.6
PP (1)	0.1920000
PP (2)	0.2000000
PP (3)	0.2010000
PP (4)	0.2020000
PP (5)	0.1910000
PP (6)	0.1920000
PP (7)	0.1929000
XP (1)	0.000000
XP (2)	0.000000
XP (3)	0.000000

XP (4)	0.000000
XP (5)	0.000000
XP (6)	0.000000
XP (7)	0.000000
PPA (1)	48000.00
PPA (2)	50000.00
PPA (3)	50250.00
PPA (4)	50500.00
PPA (5)	47750.00
PPA (6)	48000.00
PPA (7)	48225.00
PFAP (1)	2000.000
PFAP (2)	0.000000
PFAP (3)	0.000000
PFAP (4)	0.000000
PFAP (5)	2250.000
PFAP (6)	2000.000
PFAP (7)	1775.000
PM (1)	0.1800000
PM (2)	0.1880000
PM (3)	0.1960000
PM (4)	0.2010000
PM (5)	0.2000000
PM (6)	0.1960000
PM (7)	0.1860000
XM (1)	0.000000
XM (2)	0.000000
XM (3)	0.000000
XM (4)	0.000000

XM (5)	0.000000
XM (6)	0.000000
XM (7)	0.000000
PMA (1)	45000.00
PMA (2)	47000.00
PMA (3)	49000.00
PMA (4)	50250.00
PMA (5)	50000.00
PMA (6)	49000.00
PMA (7)	46500.00
PFM (1)	5000.000
PFM (2)	3000.000
PFM (3)	1000.000
PFM (4)	0.000000
PFM (5)	0.000000
PFM (6)	1000.000
PFM (7)	3500.000
PJN (1)	0.2050000
PJN (2)	0.2120000
PJN (3)	0.2150000
PJN (4)	0.2159000
PJN (5)	0.2060000
PJN (6)	0.2130000
PJN (7)	0.1950000
XJN (1)	0.000000
XJN (2)	0.000000
XJN (3)	0.000000
XJN (4)	0.000000
XJN (5)	0.000000

XJN (6)	0.000000
XJN (7)	0.000000
PJNA (1)	51250.00
PJNA (2)	53000.00
PJNA (3)	53750.00
PJNA (4)	53975.00
PJNA (5)	51500.00
PJNA (6)	53250.00
PJNA (7)	48750.00
PFJN (1)	0.000000
PFJN (2)	0.000000
PFJN (3)	0.000000
PFJN (4)	0.000000
PFJN (5)	0.000000
PFJN (6)	0.000000
PFJN (7)	1250.000
PJL (1)	0.1818000
PJL (2)	0.1959000
PJL (3)	0.1986000
PJL (4)	0.1998000
PJL (5)	0.2044000
PJL (6)	0.2000000
PJL (7)	0.2019000
XJL (1)	0.000000
XJL (2)	0.000000
XJL (3)	0.000000
XJL (4)	0.000000
XJL (5)	0.000000
XJL (6)	0.000000

XJL (7)	0.000000
PJLA (1)	45450.00
PJLA (2)	48975.00
PJLA (3)	49650.00
PJLA (4)	49950.00
PJLA (5)	51100.00
PJLA (6)	50000.00
PJLA (7)	50475.00
PFJL (1)	4550.000
PFJL (2)	1025.000
PFJL (3)	350.0000
PFJL (4)	50.00000
PFJL (5)	0.000000
PFJL (6)	0.000000
PFJL (7)	0.000000
PG (1)	0.1830000
PG (2)	0.1970000
PG (3)	0.1920000
PG (4)	0.1960000
PG (5)	0.1880000
PG (6)	0.1870000
PG (7)	0.1800000
XG (1)	0.000000
XG (2)	0.000000
XG (3)	0.000000
XG (4)	0.000000
XG (5)	0.000000
XG (6)	0.000000
XG (7)	0.000000

PGA (1)	45750.00
PGA (2)	49250.00
PGA (3)	48000.00
PGA (4)	49000.00
PGA (5)	47000.00
PGA (6)	46750.00
PGA (7)	45000.00
PFG (1)	4250.000
PFG (2)	750.0000
PFG (3)	2000.000
PFG (4)	1000.000
PFG (5)	3000.000
PFG (6)	3250.000
PFG (7)	5000.000
PS (1)	0.1876000
PS (2)	0.1930000
PS (3)	0.1840000
PS (4)	0.1790000
PS (5)	0.1720000
PS (6)	0.1660000
PS (7)	0.1630000
XS (1)	0.000000
XS (2)	0.000000
XS (3)	0.000000
XS (4)	0.000000
XS (5)	0.000000
XS (6)	0.000000
XS (7)	0.000000
PSA (1)	46900.00

PSA (2)	48250.00
PSA (3)	46000.00
PSA (4)	44750.00
PSA (5)	43000.00
PSA (6)	41500.00
PSA (7)	40750.00
PFS (1)	3100.000
PFS (2)	1750.000
PFS (3)	4000.000
PFS (4)	5250.000
PFS (5)	7000.000
PFS (6)	8500.000
PFS (7)	9250.000
PJ (1)	0.7738000E-01
PJ (2)	0.9353000E-01
PJ (3)	0.8583000E-01
PJ (4)	0.8194000E-01
PJ (5)	0.8268000E-01
PJ (6)	0.9172000E-01
PJ (7)	0.9496000E-01
XJ (1)	0.000000
XJ (2)	0.000000
XJ (3)	0.000000
XJ (4)	0.000000
XJ (5)	0.000000
XJ (6)	0.000000
XJ (7)	0.000000
PJA (1)	19345.00
PJA (2)	23382.50

PJA (3)	21457.50
PJA (4)	20485.00
PJA (5)	20670.00
PJA (6)	22930.00
PJA (7)	23740.00
PFJ (1)	30655.00
PFJ (2)	26617.50
PFJ (3)	28542.50
PFJ (4)	29515.00
PFJ (5)	29330.00
PFJ (6)	27070.00
PFJ (7)	26260.00
PF (1)	0.9576000E-01
PF (2)	0.1049000
PF (3)	0.1014000
PF (4)	0.9830000E-01
PF (5)	0.9550000E-01
PF (6)	0.1051600
PF (7)	0.1107000
XF (1)	0.000000
XF (2)	0.000000
XF (3)	0.000000
XF (4)	0.000000
XF (5)	0.000000
XF (6)	0.000000
XF (7)	0.000000
PFA (1)	23940.00
PFA (2)	26225.00
PFA (3)	25350.00

PFA (4)	24575.00
PFA (5)	23875.00
PFA (6)	26290.00
PFA (7)	27675.00
PFF (1)	26060.00
PFF (2)	23775.00
PFF (3)	24650.00
PFF (4)	25425.00
PFF (5)	26125.00
PFF (6)	23710.00
PFF (7)	22325.00
PR (1)	0.1884900
PR (2)	0.1900000
PR (3)	0.1900000
PR (4)	0.1900000
PR (5)	0.1810000
PR (6)	0.1810000
PR (7)	0.1800000
XR (1)	0.000000
XR (2)	0.000000
XR (3)	0.000000
XR (4)	0.000000
XR (5)	0.000000
XR (6)	0.000000
XR (7)	0.000000
PRA (1)	47122.50
PRA (2)	47500.00
PRA (3)	47500.00
PRA (4)	47500.00

PRA (5)	45250.00
PRA (6)	45250.00
PRA (7)	45000.00
PFR (1)	2877.500
PFR (2)	2500.000
PFR (3)	2500.000
PFR (4)	2500.000
PFR (5)	4750.000
PFR (6)	4750.000
PFR (7)	5000.000
POC (1)	0.1480000
POC (2)	0.1500000
POC (3)	0.1470000
POC (4)	0.1330000
POC (5)	0.1280000
POC (6)	0.1370000
POC (7)	0.1360000
XOC (1)	0.000000
XOC (2)	0.000000
XOC (3)	0.000000
XOC (4)	0.000000
XOC (5)	0.000000
XOC (6)	0.000000
XOC (7)	0.000000
POCA (1)	37000.00
POCA (2)	37500.00
POCA (3)	36750.00
POCA (4)	33250.00
POCA (5)	32000.00

POCA (6)	34250.00
POCA (7)	34000.00
PFOC (1)	13000.00
PFOC (2)	12500.00
PFOC (3)	13250.00
PFOC (4)	16750.00
PFOC (5)	18000.00
PFOC (6)	15750.00
PFOC (7)	16000.00
PN (1)	0.1580000
PN (2)	0.1560000
PN (3)	0.1480000
PN (4)	0.1360000
PN (5)	0.1290000
PN (6)	0.1260000
PN (7)	0.1190000
XN (1)	0.000000
XN (2)	0.000000
XN (3)	0.000000
XN (4)	0.000000
XN (5)	0.000000
XN (6)	0.000000
XN (7)	0.000000
PNA (1)	39500.00
PNA (2)	39000.00
PNA (3)	37000.00
PNA (4)	34000.00
PNA (5)	32250.00
PNA (6)	31500.00

PNA (7)	29750.00
PFN (1)	10500.00
PFN (2)	11000.00
PFN (3)	13000.00
PFN (4)	16000.00
PFN (5)	17750.00
PFN (6)	18500.00
PFN (7)	20250.00
PD (1)	0.8200000E-01
PD (2)	0.8800000E-01
PD (3)	0.7900000E-01
PD (4)	0.6880000E-01
PD (5)	0.6900000E-01
PD (6)	0.7500000E-01
PD (7)	0.7300000E-01
XD (1)	0.000000
XD (2)	0.000000
XD (3)	0.000000
XD (4)	0.000000
XD (5)	0.000000
XD (6)	0.000000
XD (7)	0.000000
PDA (1)	20500.00
PDA (2)	22000.00
PDA (3)	19750.00
PDA (4)	17200.00
PDA (5)	17250.00
PDA (6)	18750.00
PDA (7)	18250.00

PFD (1)	29500.00
PFD (2)	28000.00
PFD (3)	30250.00
PFD (4)	32800.00
PFD (5)	32750.00
PFD (6)	31250.00
PFD (7)	31750.00

5.2.1. MINIMIZE LEC

- Lingo input

! This program is to find the minimum collectors area that absorb solar energy enough to run the solar power plant at full load, 7 hrs, a day all the summer months "April:August";

```
min=LEC;
```

```
Net_Ele >=7*365*50000;
```

```
Net_Ele <=8*365*50000;
```

```
SETS:
```

```
APRIL/1..7/:PP,XP,PPA,PFAP;
```

```
MAI/1..7/:PM,XM,PMA,PFM;
```

```
JUNE/1..7/:PJN,XJN,PJNA,PFJN;
```

```
JULY/1..7/:PJL,XJL,PJLA,PFJL;
```

```
AUGUST/1..7/:PG,XG,PGA,PGF;
```

```
SEPTEMBER/1..7/:PS,XS,PSA,PFS;
```

```
JANUARY/1..7/:PJ,XJ,PJA,PFJ;
```

```
FEBRUARY/1..7/:PF,XF,PFA,PFJ;
```

```
MARCH/1..7/:PR,XR,PRA,PRF;
```

```
OCTOBER/1..7/:POC,XOC,POCA,PFOC;
```

```

NOVMEBR/1..7/:PN,XN,PNA,PFN;

DECEMBER/1..7/:PD,XD,PDA,PDF;

ENDSETS

DATA:

PJ= 0.07738,0.09353,0.08583,0.08194,0.08268,0.09172,0.09496;

PF=0.09576,0.1049,0.1014,0.0983,0.0955,0.10516,0.1107;

PR=0.18849,0.19,0.19,0.19,0.181,0.181,0.18;

PP= 0.192,0.2,0.201,0.202,0.191,0.192,0.1929;

PM=0.18,0.188,0.196,0.201,0.2,0.196,0.186;

PJN=0.205,0.212,0.215,0.2159,0.206,0.213,0.195;

PJL=0.1818,0.1959,0.1986,0.1998,0.2044,0.2,0.2019;

PG=0.183,0.197,0.192,0.196,0.188,0.187,0.18;

PS=0.1876,0.193,0.184,0.179,0.172,0.166,0.163;

POC=0.148,0.15,0.147,0.133,0.128,0.137,0.136;

PN=0.158,0.156,0.148,0.136,0.129,0.126,0.119;

PD=0.082,0.088,0.079,0.0688,0.069,0.075,0.073;

ENDDATA

CO2_Reduction=300*Area;

Fuel_Saver=Net_Ele /301790;

Full_HRS=Net_Ele /50000;

!APRIL(P);

@FOR(APRIL(i):PPA(i)=AREA*PP(i));

PPT=@SUM(APRIL(i):PPA(i));

@FOR(APRIL(i):(PPA(i)+PFAP(i))>=50000);

PFAPT=@SUM(APRIL(i):PFAP(i));

P4=@SUM(APRIL(i):PPA(i)+PFAP(i));

!MAI(M);

@FOR(MAI(i):PMA(i)=AREA*PM(i));

PMT=@SUM(MAI(i):PMA(i));

```

```

@FOR(MAI(i):(PMA(i)+PFM(i))>=50000);

PFMT=@SUM(MAI(i):PFM(i));

P5=@SUM(MAI(i):PMA(i)+PFM(i));

!JUNE(JN);

@FOR(JUNE(i):PJNA(i)=AREA*PJN(i));

PJNT=@SUM(JUNE(i):PJNA(i));

@FOR(JUNE(i):(PJNA(i)+PFJN(i))>=50000);

PFJNT=@SUM(JUNE(i):PFJN(i));

P6=@SUM(JUNE(i):PJNA(i)+PFJN(i));

!JULY(JL);

@FOR(JULY(i):PJLA(i)=AREA*PJL(i));

PJLT=@SUM(JULY(i):PJLA(i));

@FOR(JULY(i):(PJLA(i)+PFJL(i))>=50000);

PFJLT=@SUM(JULY(i):PFJL(i));

P7=@SUM(JULY(i):PJLA(i)+PFJL(i));

!AUGUST(G);

@FOR(AUGUST(i):PGA(i)=AREA*PG(i));

PGT=@SUM(AUGUST(i):PGA(i));

@FOR(AUGUST(i):(PGA(i)+PFG(i))>=50000);

PFGT=@SUM(AUGUST(i):PFG(i));

P8=@SUM(AUGUST(i):PGA(i)+PFG(i));

!SEPTEMBER;

@FOR(SEPTEMBER(i):PsA(i)=AREA*Ps(i));

PsT=@SUM(SEPTEMBER(i):PsA(i));

@FOR(SEPTEMBER(i):(PSA(i)+PFS(i))>=50000);

PFST=@SUM(SEPTEMBER(i):PFs(i));

P9=@SUM(SEPTEMBER(i):PSA(i)+PFS(i));

!!!!!!!!!!!!!!!!!!!!!!!!!!!!!!!!!!!!!!!!!!!!;

!THE WINTER WILL RUN USING FUEL & SOLAR TOGETHER TO GET FULL LOAD;

```

```

!october;

@FOR (OCTOBER (i) : POCA (i) = AREA * POC (i) );

@FOR (OCTOBER (i) : (POCA (i) + PFOC (i) ) >= 50000 );

POCT = @SUM (OCTOBER (i) : POCA (i) );

PFOCT = @SUM (OCTOBER (i) : PFOC (i) );

PTOC = @SUM (OCTOBER (i) : (POCA (i) + PFOC (i) ) );

P10 = @SUM (OCTOBER (i) : POCA (i) + PFOC (i) );

!NOVMEBR;

@FOR (NOVMEBR (i) : PNA (i) = AREA * PN (i) );

@FOR (NOVMEBR (i) : (PNA (i) + PFN (i) ) >= 50000 );

PNT = @SUM (NOVMEBR (i) : PNA (i) );

PFNT = @SUM (NOVMEBR (i) : PFN (i) );

PTN = @SUM (NOVMEBR (i) : (PNA (i) + PFN (i) ) );

P11 = @SUM (NOVMEBR (i) : PNA (i) + PFN (i) );

!DECEMBER;

@FOR (DECEMBER (i) : PDA (i) = AREA * PD (i) );

@FOR (DECEMBER (i) : (PDA (i) + PFD (i) ) >= 50000 );

PDT = @SUM (DECEMBER (i) : PDA (i) );

PFDT = @SUM (DECEMBER (i) : PFD (i) );

PTD = @SUM (DECEMBER (i) : (PDA (i) + PFD (i) ) );

P12 = @SUM (DECEMBER (i) : PDA (i) + PFD (i) );

@FOR (JANUARY (i) : PJA (i) = AREA * PJ (i) );

@FOR (JANUARY (i) : (PJA (i) + PFJ (i) ) >= 50000 );

PJT = @SUM (JANUARY (i) : PJA (i) );

PFJT = @SUM (JANUARY (i) : PFJ (i) );

PTJ = @SUM (JANUARY (i) : (PJA (i) + PFJ (i) ) );

P1 = @SUM (JANUARY (i) : PJA (i) + PFJ (i) );

!FEBRUARY;

@FOR (FEBRUARY (i) : PFA (i) = AREA * PF (i) );

```



```

@FOR (FEBRUARY (i) : (PFA (i) + PFF (i)) >= 50000);

PFT=@SUM (FEBRUARY (i) : PFA (i));

PFFT=@SUM (FEBRUARY (i) : PFF (i));

PTD=@SUM (FEBRUARY (i) : (PFA (i) + PFF (i)));

P2=@SUM (FEBRUARY (i) : PFA (i) + PFF (i));

!MARCH;

@FOR (MARCH (i) : PRA (i) = AREA * PR (i));

@FOR (MARCH (i) : (PRA (i) + PFR (i)) >= 50000);

PRT=@SUM (MARCH (i) : PRA (i));

PFRT=@SUM (MARCH (i) : PFR (i));

PTR=@SUM (MARCH (i) : (PRA (i) + PFR (i)));

P3=@SUM (MARCH (i) : PMA (i) + PFM (i));

P_ANNUAL=31 * P1 + 28 * P2 + 31 * P3 + 30 * P4 + P5 * 31 + P6 * 30 + P7 * 31 + P8 * 31 + P9 * 30 + P10 * 31 + P
11 * 30 + P12 * 31;

PFUEL=31 * PFOCT + 30 * PFNT + 31 * PFDT + 31 * PFJT + 28 * PFFT + 31 * PFRT + 30 * PFAPT + 31 * PFMT
+ 30 * PFJNT + 31 * PFJLT + 31 * PFGT + 30 * PFST;

RATIO=PFUEL / (P_Annual);

RATIO <= (1 / 3);

Net_Ele = (1 - 0.084) * (P_Annual + PFUEL);

LEC = ( (302 * AREA + 592 * N_P) * 0.104 + OM_HYBRID * Net_Ele + FUEL_COST ) / Net_Ele ;

N_P = 50000;

OM_HYBRID = 0.018;

FUEL_COST = 0.028 * PFUEL;

!FUEL_COST IS 0.028$/KWhe, THAT EQUAL 8$/MBTU;

```

- Lingo output

Local optimal solution found.

Objective value:

0.9656335E-01

Total solver iterations:

157

Variable	Value	Reduced Cost
LEC	0.9656335E-01	0.000000
NET_ELE	0.1460000E+09	0.000000
CO2_REDUCTION	0.7173211E+08	0.000000
AREA	239107.0	0.000000
FUEL_SAVER	483.7801	0.000000
FULL_HRS	2920.000	0.000000
PPT	327791.9	0.000000
PFAPT	22208.15	0.000000
P4	350000.0	0.000000
PMT	322077.2	0.000000
PFMT	27922.81	0.000000
P5	350000.0	0.000000
PJNT	349550.6	0.000000
PFJNT	5101.128	0.000000
P6	354651.7	0.000000
PJLT	330541.6	0.000000
PFJLT	19458.42	0.000000
P7	350000.0	0.000000
PGT	316338.6	0.000000
PFGT	33661.37	0.000000
P8	350000.0	0.000000
PST	297592.6	0.000000
PFST	52407.37	0.000000
P9	350000.0	0.000000
POCT	234085.8	0.000000

PFOCT	115914.2	0.000000
PTOC	350000.0	0.000000
P10	350000.0	0.000000
PNT	232412.1	0.000000
PFNT	117587.9	0.000000
PTN	350000.0	0.000000
P11	350000.0	0.000000
PDT	127874.4	0.000000
PFDT	222125.6	0.000000
PTD	350000.0	0.000000
P12	350000.0	0.000000
PJT	145386.7	0.000000
PFJT	204613.3	0.000000
PTJ	350000.0	0.000000
P1	350000.0	0.000000
PFT	170177.3	0.000000
PFFT	179822.7	0.000000
P2	350000.0	0.000000
PRT	310956.3	0.000000
PFRT	39043.67	0.000000
PTR	350000.0	0.000000
P3	350000.0	0.000000
P_ANNUAL	0.1278896E+09	0.000000
PFUEL	0.3149909E+08	0.000000
RATIO	0.2462992	0.000000
N_P	50000.00	0.000000
OM_HYBRID	0.1800000E-01	0.000000
FUEL_COST	881974.6	0.000000
PP (1)	0.1920000	0.000000

PP (2)	0.2000000	0.000000
PP (3)	0.2010000	0.000000
PP (4)	0.2020000	0.000000
PP (5)	0.1910000	0.000000
PP (6)	0.1920000	0.000000
PP (7)	0.1929000	0.000000
XP (1)	0.000000	0.000000
XP (2)	0.000000	0.000000
XP (3)	0.000000	0.000000
XP (4)	0.000000	0.000000
XP (5)	0.000000	0.000000
XP (6)	0.000000	0.000000
XP (7)	0.000000	0.000000
PPA (1)	45908.55	0.000000
PPA (2)	47821.41	0.000000
PPA (3)	48060.52	0.000000
PPA (4)	48299.62	0.000000
PPA (5)	45669.45	0.000000
PPA (6)	45908.55	0.000000
PPA (7)	46123.75	0.000000
PFAP (1)	4091.447	0.000000
PFAP (2)	2178.590	0.000000
PFAP (3)	1939.483	0.000000
PFAP (4)	1700.376	0.000000
PFAP (5)	4330.554	0.000000
PFAP (6)	4091.447	0.000000
PFAP (7)	3876.250	0.000000
PM (1)	0.1800000	0.000000
PM (2)	0.1880000	0.000000

PM(3)	0.1960000	0.000000
PM(4)	0.2010000	0.000000
PM(5)	0.2000000	0.000000
PM(6)	0.1960000	0.000000
PM(7)	0.1860000	0.000000
XM(1)	0.000000	0.000000
XM(2)	0.000000	0.000000
XM(3)	0.000000	0.000000
XM(4)	0.000000	0.000000
XM(5)	0.000000	0.000000
XM(6)	0.000000	0.000000
XM(7)	0.000000	0.000000
PMA(1)	43039.27	0.000000
PMA(2)	44952.13	0.000000
PMA(3)	46864.98	0.000000
PMA(4)	48060.52	0.000000
PMA(5)	47821.41	0.000000
PMA(6)	46864.98	0.000000
PMA(7)	44473.91	0.000000
PFM(1)	6960.731	0.000000
PFM(2)	5047.875	0.000000
PFM(3)	3135.018	0.000000
PFM(4)	1939.483	0.000000
PFM(5)	2178.590	0.000000
PFM(6)	3135.018	0.000000
PFM(7)	5526.089	0.000000
PJN(1)	0.2050000	0.000000
PJN(2)	0.2120000	0.000000
PJN(3)	0.2150000	0.000000

PJN (4)	0.2159000	0.000000
PJN (5)	0.2060000	0.000000
PJN (6)	0.2130000	0.000000
PJN (7)	0.1950000	0.000000
XJN (1)	0.000000	0.000000
XJN (2)	0.000000	0.000000
XJN (3)	0.000000	0.000000
XJN (4)	0.000000	0.000000
XJN (5)	0.000000	0.000000
XJN (6)	0.000000	0.000000
XJN (7)	0.000000	0.000000
PJNA (1)	49016.95	0.000000
PJNA (2)	50690.69	0.000000
PJNA (3)	51408.02	0.000000
PJNA (4)	51623.21	0.000000
PJNA (5)	49256.05	0.000000
PJNA (6)	50929.80	0.000000
PJNA (7)	46625.87	0.000000
PFJN (1)	983.0550	0.000000
PFJN (2)	0.000000	0.000000
PFJN (3)	0.000000	0.000000
PFJN (4)	0.000000	0.000000
PFJN (5)	743.9479	0.000000
PFJN (6)	0.000000	0.000000
PFJN (7)	3374.125	0.000000
PJL (1)	0.1818000	0.000000
PJL (2)	0.1959000	0.000000
PJL (3)	0.1986000	0.000000
PJL (4)	0.1998000	0.000000

PJL (5)	0.2044000	0.000000
PJL (6)	0.2000000	0.000000
PJL (7)	0.2019000	0.000000
XJL (1)	0.000000	0.000000
XJL (2)	0.000000	0.000000
XJL (3)	0.000000	0.000000
XJL (4)	0.000000	0.000000
XJL (5)	0.000000	0.000000
XJL (6)	0.000000	0.000000
XJL (7)	0.000000	0.000000
PJLA (1)	43469.66	0.000000
PJLA (2)	46841.07	0.000000
PJLA (3)	47486.66	0.000000
PJLA (4)	47773.59	0.000000
PJLA (5)	48873.48	0.000000
PJLA (6)	47821.41	0.000000
PJLA (7)	48275.71	0.000000
PFJL (1)	6530.339	0.000000
PFJL (2)	3158.929	0.000000
PFJL (3)	2513.340	0.000000
PFJL (4)	2226.412	0.000000
PFJL (5)	1126.519	0.000000
PFJL (6)	2178.590	0.000000
PFJL (7)	1724.287	0.000000
PG (1)	0.1830000	0.000000
PG (2)	0.1970000	0.000000
PG (3)	0.1920000	0.000000
PG (4)	0.1960000	0.000000
PG (5)	0.1880000	0.000000

PG (6)	0.1870000	0.000000
PG (7)	0.1800000	0.000000
XG (1)	0.000000	0.000000
XG (2)	0.000000	0.000000
XG (3)	0.000000	0.000000
XG (4)	0.000000	0.000000
XG (5)	0.000000	0.000000
XG (6)	0.000000	0.000000
XG (7)	0.000000	0.000000
PGA (1)	43756.59	0.000000
PGA (2)	47104.09	0.000000
PGA (3)	45908.55	0.000000
PGA (4)	46864.98	0.000000
PGA (5)	44952.13	0.000000
PGA (6)	44713.02	0.000000
PGA (7)	43039.27	0.000000
PFG (1)	6243.410	0.000000
PFG (2)	2895.911	0.000000
PFG (3)	4091.447	0.000000
PFG (4)	3135.018	0.000000
PFG (5)	5047.875	0.000000
PFG (6)	5286.982	0.000000
PFG (7)	6960.731	0.000000
PS (1)	0.1876000	0.000000
PS (2)	0.1930000	0.000000
PS (3)	0.1840000	0.000000
PS (4)	0.1790000	0.000000
PS (5)	0.1720000	0.000000
PS (6)	0.1660000	0.000000

PS (7)	0.1630000	0.000000
XS (1)	0.000000	0.000000
XS (2)	0.000000	0.000000
XS (3)	0.000000	0.000000
XS (4)	0.000000	0.000000
XS (5)	0.000000	0.000000
XS (6)	0.000000	0.000000
XS (7)	0.000000	0.000000
PSA (1)	44856.48	0.000000
PSA (2)	46147.66	0.000000
PSA (3)	43995.70	0.000000
PSA (4)	42800.16	0.000000
PSA (5)	41126.41	0.000000
PSA (6)	39691.77	0.000000
PSA (7)	38974.45	0.000000
PFS (1)	5143.518	0.000000
PFS (2)	3852.340	0.000000
PFS (3)	6004.303	0.000000
PFS (4)	7199.838	0.000000
PFS (5)	8873.588	0.000000
PFS (6)	10308.23	0.000000
PFS (7)	11025.55	0.000000
PJ (1)	0.7738000E-01	0.000000
PJ (2)	0.9353000E-01	0.000000
PJ (3)	0.8583000E-01	0.000000
PJ (4)	0.8194000E-01	0.000000
PJ (5)	0.8268000E-01	0.000000
PJ (6)	0.9172000E-01	0.000000
PJ (7)	0.9496000E-01	0.000000

XJ (1)	0.000000	0.000000
XJ (2)	0.000000	0.000000
XJ (3)	0.000000	0.000000
XJ (4)	0.000000	0.000000
XJ (5)	0.000000	0.000000
XJ (6)	0.000000	0.000000
XJ (7)	0.000000	0.000000
PJA (1)	18502.10	0.000000
PJA (2)	22363.68	0.000000
PJA (3)	20522.56	0.000000
PJA (4)	19592.43	0.000000
PJA (5)	19769.37	0.000000
PJA (6)	21930.90	0.000000
PJA (7)	22705.61	0.000000
PFJ (1)	31497.90	0.000000
PFJ (2)	27636.32	0.000000
PFJ (3)	29477.44	0.000000
PFJ (4)	30407.57	0.000000
PFJ (5)	30230.63	0.000000
PFJ (6)	28069.10	0.000000
PFJ (7)	27294.39	0.000000
PF (1)	0.9576000E-01	0.000000
PF (2)	0.1049000	0.000000
PF (3)	0.1014000	0.000000
PF (4)	0.9830000E-01	0.000000
PF (5)	0.9550000E-01	0.000000
PF (6)	0.1051600	0.000000
PF (7)	0.1107000	0.000000
XF (1)	0.000000	0.000000

XF (2)	0.000000	0.000000
XF (3)	0.000000	0.000000
XF (4)	0.000000	0.000000
XF (5)	0.000000	0.000000
XF (6)	0.000000	0.000000
XF (7)	0.000000	0.000000
PFA (1)	22896.89	0.000000
PFA (2)	25082.33	0.000000
PFA (3)	24245.45	0.000000
PFA (4)	23504.22	0.000000
PFA (5)	22834.72	0.000000
PFA (6)	25144.50	0.000000
PFA (7)	26469.15	0.000000
PFF (1)	27103.11	0.000000
PFF (2)	24917.67	0.000000
PFF (3)	25754.55	0.000000
PFF (4)	26495.78	0.000000
PFF (5)	27165.28	0.000000
PFF (6)	24855.50	0.000000
PFF (7)	23530.85	0.000000
PR (1)	0.1884900	0.000000
PR (2)	0.1900000	0.000000
PR (3)	0.1900000	0.000000
PR (4)	0.1900000	0.000000
PR (5)	0.1810000	0.000000
PR (6)	0.1810000	0.000000
PR (7)	0.1800000	0.000000
XR (1)	0.000000	0.000000
XR (2)	0.000000	0.000000

XR (3)	0.000000	0.000000
XR (4)	0.000000	0.000000
XR (5)	0.000000	0.000000
XR (6)	0.000000	0.000000
XR (7)	0.000000	0.000000
PRA (1)	45069.29	0.000000
PRA (2)	45430.34	0.000000
PRA (3)	45430.34	0.000000
PRA (4)	45430.34	0.000000
PRA (5)	43278.38	0.000000
PRA (6)	43278.38	0.000000
PRA (7)	43039.27	0.000000
PFR (1)	4930.712	0.000000
PFR (2)	4569.661	0.000000
PFR (3)	4569.661	0.000000
PFR (4)	4569.661	0.000000
PFR (5)	6721.624	0.000000
PFR (6)	6721.624	0.000000
PFR (7)	6960.731	0.000000
POC (1)	0.1480000	0.000000
POC (2)	0.1500000	0.000000
POC (3)	0.1470000	0.000000
POC (4)	0.1330000	0.000000
POC (5)	0.1280000	0.000000
POC (6)	0.1370000	0.000000
POC (7)	0.1360000	0.000000
XOC (1)	0.000000	0.000000
XOC (2)	0.000000	0.000000
XOC (3)	0.000000	0.000000

XOC (4)	0.000000	0.000000
XOC (5)	0.000000	0.000000
XOC (6)	0.000000	0.000000
XOC (7)	0.000000	0.000000
POCA (1)	35387.84	0.000000
POCA (2)	35866.06	0.000000
POCA (3)	35148.74	0.000000
POCA (4)	31801.24	0.000000
POCA (5)	30605.70	0.000000
POCA (6)	32757.67	0.000000
POCA (7)	32518.56	0.000000
PFOC (1)	14612.16	0.000000
PFOC (2)	14133.94	0.000000
PFOC (3)	14851.26	0.000000
PFOC (4)	18198.76	0.000000
PFOC (5)	19394.30	0.000000
PFOC (6)	17242.33	0.000000
PFOC (7)	17481.44	0.000000
PN (1)	0.1580000	0.000000
PN (2)	0.1560000	0.000000
PN (3)	0.1480000	0.000000
PN (4)	0.1360000	0.000000
PN (5)	0.1290000	0.000000
PN (6)	0.1260000	0.000000
PN (7)	0.1190000	0.000000
XN (1)	0.000000	0.000000
XN (2)	0.000000	0.000000
XN (3)	0.000000	0.000000
XN (4)	0.000000	0.000000

XN (5)	0.000000	0.000000
XN (6)	0.000000	0.000000
XN (7)	0.000000	0.000000
PNA (1)	37778.91	0.000000
PNA (2)	37300.70	0.000000
PNA (3)	35387.84	0.000000
PNA (4)	32518.56	0.000000
PNA (5)	30844.81	0.000000
PNA (6)	30127.49	0.000000
PNA (7)	28453.74	0.000000
PFN (1)	12221.09	0.000000
PFN (2)	12699.30	0.000000
PFN (3)	14612.16	0.000000
PFN (4)	17481.44	0.000000
PFN (5)	19155.19	0.000000
PFN (6)	19872.51	0.000000
PFN (7)	21546.26	0.000000
PD (1)	0.8200000E-01	0.000000
PD (2)	0.8800000E-01	0.000000
PD (3)	0.7900000E-01	0.000000
PD (4)	0.6880000E-01	0.000000
PD (5)	0.6900000E-01	0.000000
PD (6)	0.7500000E-01	0.000000
PD (7)	0.7300000E-01	0.000000
XD (1)	0.000000	0.000000
XD (2)	0.000000	0.000000
XD (3)	0.000000	0.000000
XD (4)	0.000000	0.000000
XD (5)	0.000000	0.000000

XD (6)	0.000000	0.000000
XD (7)	0.000000	0.000000
PDA (1)	19606.78	0.000000
PDA (2)	21041.42	0.000000
PDA (3)	18889.46	0.000000
PDA (4)	16450.56	0.000000
PDA (5)	16498.39	0.000000
PDA (6)	17933.03	0.000000
PDA (7)	17454.81	0.000000
PFD (1)	30393.22	0.000000
PFD (2)	28958.58	0.000000
PFD (3)	31110.54	0.000000
PFD (4)	33549.44	0.000000
PFD (5)	33501.61	0.000000
PFD (6)	32066.97	0.000000
PFD (7)	32545.19	0.000000

6th. SOLAR FOSSIL FUEL ALL THE YEAR (7 HRS/DAY) WITH TES

! This program is to find the minimum collectors area that absorb solar energy enough to run the solar power plant at full load, 7 hrs, a day all the summer months "April:August";

!Solar+Fossil+TES;

SETS:

APRIL/1..7/:PP,XP,PPA,PPF,PPA_D,PPA_ST,PPA_T,PHR;

MAI/1..7/:PM,XM,PMA,PFM,PFA_D,PMA_D,PMA_ST,PMA_T,MHR;

JUNE/1..7/:PJN,XJN,PJNA,PFJN,JNFA_D,PJNA_D,PJNA_ST,PJNA_T,JNHR;

```

JULY/1..7/:PJL,XJL,PJLA,PFJL,JLFA_D,PJLA_D,PJLA_ST,PJLA_T,JLHR;
AUGUST/1..7/:PG,XG,PGA,PGF,GFA_D,PGA_ST,PGA_D,PGA_T,GHR;
SEPTEMBER/1..7/:PS,XS,PSA,PFS,SFA_D,PSA_ST,PSA_T,PSA_D,SHR;
ENDSETS
DATA:
PP= 0.192,0.2,0.201,0.202,0.191,0.192,0.1929;
PM=0.18,0.188,0.196,0.201,0.2,0.196,0.186;
PJN=0.205,0.212,0.215,0.2159,0.206,0.213,0.195;
PJL=0.1818,0.1959,0.1986,0.1998,0.2044,0.2,0.2019;
PG=0.183,0.197,0.192,0.196,0.188,0.187,0.18;
PS=0.1876,0.193,0.184,0.179,0.172,0.166,0.163;
ENDDATA
CO2_Reduction=300*Area;
Fuel_Saver=NET_ELECT/301790;
Full_HRS=NET_ELECT/50000;
!APRIL(P);
@FOR(APRIL(i):PPA_T(i)=AREA*PP(i));
@FOR(APRIL(i):(PPA_D(i)+PFP(i))>=50000);
@FOR(APRIL(i):PPA_ST(i)=PPA_T(i)-PPA_D(i));
PFT4=@SUM(APRIL(i):PFP(i));
PPA_D_T=@SUM(APRIL(i):PPA_D(i));
PPA_ST_T=@SUM(APRIL(i):PPA_ST(i));
@FOR(APRIL(i):PPA_ST_T>=(N_P*Storage_Capacity));
@FOR(APRIL(i):PHR(i)=PPA_D(i)+PFP(i));
PT=@SUM(APRIL(i):PHR(i));
!MAI;
@FOR(MAI(i):PMA_T(i)=AREA*PM(i));
@FOR(MAI(i):(PMA_D(i)+PFM(i))>=50000);

```



```

@FOR (MAI (i) : PMA_ST (i) = PMA_T (i) - PMA_D (i) );
PFT5 = @SUM (MAI (i) : PFM (i) );
PMA_D_T = @SUM (MAI (i) : PMA_D (i) );
PMA_ST_T = @SUM (MAI (i) : PMA_ST (i) );
@FOR (MAI (i) : PMA_ST_T >= (N_P * Storage_Capacity) );
@FOR (MAI (i) : MHR (i) = PMA_D (i) + PFM (i) );
PT5 = @SUM (MAI (i) : MHR (i) );
! JUNE;
@FOR (JUNE (i) : PJNA_T (i) = AREA * PJN (i) );
@FOR (JUNE (i) : (PJNA_D (i) + PFJN (i)) >= 50000 );
@FOR (JUNE (i) : PJNA_ST (i) = PJNA_T (i) - PJNA_D (i) );
PFT6 = @SUM (JUNE (i) : PFJN (i) );
PJNA_D_T = @SUM (JUNE (i) : PJNA_D (i) );
PJNA_ST_T = @SUM (JUNE (i) : PJNA_ST (i) );
@FOR (JUNE (i) : PJNA_ST_T >= (N_P * Storage_Capacity) );
@FOR (JUNE (i) : JNHR (i) = PJNA_D (i) + PFJN (i) );
PT6 = @SUM (JUNE (i) : JNHR (i) );
! JULY;
@FOR (JULY (i) : PJLA_T (i) = AREA * PJL (i) );
@FOR (JULY (i) : (PJLA_D (i) + PFJL (i)) >= 50000 );
@FOR (JULY (i) : PJLA_ST (i) = PJLA_T (i) - PJLA_D (i) );
PFT7 = @SUM (JULY (i) : PFJL (i) );
PJLA_D_T = @SUM (JULY (i) : PJLA_D (i) );
PJLA_ST_T = @SUM (JULY (i) : PJLA_ST (i) );
@FOR (JULY (i) : PJLA_ST_T >= (N_P * Storage_Capacity) );
@FOR (JULY (i) : JLHR (i) = PJLA_D (i) + PFJL (i) );
PT7 = @SUM (JULY (i) : JLHR (i) );
! AUGUST;

```

```

@FOR (AUGUST (i) : PGA_T (i) = AREA * PG (i) );
@FOR (AUGUST (i) : (PGA_D (i) + PFG (i)) >= 50000);
@FOR (AUGUST (i) : PGA_ST (i) = PGA_T (i) - PGA_D (i) );
PFT8 = @SUM (AUGUST (i) : PFG (i) );
PGA_D_T = @SUM (AUGUST (i) : PGA_D (i) );
PGA_ST_T = @SUM (AUGUST (i) : PGA_ST (i) );
@FOR (AUGUST (i) : PGA_ST_T >= (N_P * Storage_Capacity) );
@FOR (AUGUST (i) : GHR (i) = PGA_D (i) + PFG (i) );
PT8 = @SUM (AUGUST (i) : GHR (i) );
! SEPTEMBER;
@FOR (SEPTEMBER (i) : PSA_T (i) = AREA * PS (i) );
@FOR (SEPTEMBER (i) : (PSA_D (i) + PFS (i)) >= 50000);
@FOR (SEPTEMBER (i) : PSA_ST (i) = PSA_T (i) - PSA_D (i) );
PFT9 = @SUM (SEPTEMBER (i) : PFS (i) );
PSA_D_T = @SUM (SEPTEMBER (i) : PSA_D (i) );
PSA_ST_T = @SUM (SEPTEMBER (i) : PSA_ST (i) );
@FOR (SEPTEMBER (i) : PSA_ST_T >= N_P * Storage_Capacity );
@FOR (SEPTEMBER (i) : SHR (i) = PSA_D (i) + PFS (i) );
PT9 = @SUM (SEPTEMBER (i) : SHR (i) );
F = 30 * PFT9 + 31 * PFT8 + 31 * PFT7 + 30 * PFT6 + 31 * PFT5 + 30 * PFT4;
SOLAR = 30 * PSA_D_T + 30 * PSA_ST_T + 31 * PGA_D_T + 31 * PGA_ST_T + 30 * PJLA_D_T + 31 * PJLA
_ST_T + 30 * PJNA_D_T + 30 * PJNA_ST_T + 31 * PMA_D_T + 31 * PMA_ST_T + 30 * PPA_D_T + 30 * PPA
_ST_T;
STORAGE = 30 * PSA_ST_T + 31 * PGA_ST_T + 31 * PJLA_ST_T + 30 * PJNA_ST_T + 31 * PMA_ST_T;
STORAGE >= (N_P * Storage_Capacity);
RATIO <= 0.25;
RATIO = F / SOLAR;
N_P = 50000;

```

```

MIN=AREA;
N_P=50*1000;
Capital_Cost=302*AREA+592.1*N_P +
Storage_Capacity*(N_P/Effpst)*Cost_unit_storage;
OM_COST=93.32*storage_capacity+3567.6;
Effpst=0.371;
CF=0.08;
!Cost_unit_storage=(65.63-38.79-32.23-30.88-31.18-31), Storage_Capacity=(1-3-6-9-12-
15);
Storage_Capacity=1;
Cost_unit_storage=65.63;
LEC=(Capital_Cost*0.104+OM_COST+CF*F)/(NET_ELECT);
NET_ELECT=(F+SOLAR+STORAGE)-PARASITIC;
PARASITIC=1.3274*Storage_Capacity+7.99;

```

- Lingo output

Local optimal solution found.

```

Objective value:                236403.4
Total solver iterations:        653

```

Variable	Value	Reduced Cost
CO2_REDUCTION	0.7092101E+08	0.000000
AREA	236403.4	0.000000
FUEL_SAVER	266.9843	0.000000
NET_ELECT	0.8057319E+08	0.000000

FULL_HRS	1611.464	0.000000
PFT4	75914.64	0.000000
PPA_D_T	274085.4	0.000000
PPA_ST_T	50000.00	0.000000
N_P	50000.00	0.000000
STORAGE_CAPACITY	1.000000	0.000000
PT	350000.0	0.000000
PFT5	81564.68	0.000000
PMA_D_T	268435.3	0.000000
PMA_ST_T	50000.00	0.000000
PT5	350000.0	0.000000
PFT6	54401.94	0.000000
PJNA_D_T	295598.1	0.000000
PJNA_ST_T	50000.00	0.000000
PT6	350000.0	0.000000
PFT7	73196.00	0.000000
PJLA_D_T	276804.0	0.000000
PJLA_ST_T	50000.00	0.000000
PT7	350000.0	0.000000
PFT8	87238.36	0.000000
PGA_D_T	262761.6	0.000000
PGA_ST_T	50000.00	0.000000
PT8	350000.0	0.000000
PFT9	105772.4	0.000000
PSA_D_T	244227.6	0.000000
PSA_ST_T	50000.00	0.000000
PT9	350000.0	0.000000
F	0.1458464E+08	0.000000
SOLAR	0.5833856E+08	0.000000

STORAGE	7650000.	0.000000
RATIO	0.2500000	0.000000
CAPITAL_COST	0.1098438E+09	0.000000
EFFPST	0.3710000	0.000000
COST_UNIT_STORAGE	65.63000	0.000000
OM_COST	3660.920	0.000000
CF	0.8000000E-01	0.000000
LEC	0.1563075	0.000000
PARASITIC	9.317400	0.000000
PP (1)	0.1920000	0.000000
PP (2)	0.2000000	0.000000
PP (3)	0.2010000	0.000000
PP (4)	0.2020000	0.000000
PP (5)	0.1910000	0.000000
PP (6)	0.1920000	0.000000
PP (7)	0.1929000	0.000000
XP (1)	0.000000	0.000000
XP (2)	0.000000	0.000000
XP (3)	0.000000	0.000000
XP (4)	0.000000	0.000000
XP (5)	0.000000	0.000000
XP (6)	0.000000	0.000000
XP (7)	0.000000	0.000000
PPA (1)	0.000000	0.000000
PPA (2)	0.000000	0.000000
PPA (3)	0.000000	0.000000
PPA (4)	0.000000	0.000000
PPA (5)	0.000000	0.000000
PPA (6)	0.000000	0.000000

PPA (7)	0.000000	0.000000
PFP (1)	11730.71	0.000000
PFP (2)	11730.71	0.000000
PFP (3)	2482.926	0.000000
PFP (4)	14778.15	0.000000
PFP (5)	11730.71	0.000000
PFP (6)	11730.71	0.000000
PFP (7)	11730.71	0.000000
PPA_D (1)	38269.29	0.000000
PPA_D (2)	38269.29	0.000000
PPA_D (3)	47517.07	0.000000
PPA_D (4)	35221.85	0.000000
PPA_D (5)	38269.29	0.000000
PPA_D (6)	38269.29	0.000000
PPA_D (7)	38269.29	0.000000
PPA_ST (1)	7120.158	0.000000
PPA_ST (2)	9011.384	0.000000
PPA_ST (3)	0.000000	0.000000
PPA_ST (4)	12531.63	0.000000
PPA_ST (5)	6883.754	0.000000
PPA_ST (6)	7120.158	0.000000
PPA_ST (7)	7332.921	0.000000
PPA_T (1)	45389.44	0.000000
PPA_T (2)	47280.67	0.000000
PPA_T (3)	47517.07	0.000000
PPA_T (4)	47753.48	0.000000
PPA_T (5)	45153.04	0.000000
PPA_T (6)	45389.44	0.000000
PPA_T (7)	45602.21	0.000000

PHR (1)	50000.00	0.000000
PHR (2)	50000.00	0.000000
PHR (3)	50000.00	0.000000
PHR (4)	50000.00	0.000000
PHR (5)	50000.00	0.000000
PHR (6)	50000.00	0.000000
PHR (7)	50000.00	0.000000
PM (1)	0.1800000	0.000000
PM (2)	0.1880000	0.000000
PM (3)	0.1960000	0.000000
PM (4)	0.2010000	0.000000
PM (5)	0.2000000	0.000000
PM (6)	0.1960000	0.000000
PM (7)	0.1860000	0.000000
XM (1)	0.000000	0.000000
XM (2)	0.000000	0.000000
XM (3)	0.000000	0.000000
XM (4)	0.000000	0.000000
XM (5)	0.000000	0.000000
XM (6)	0.000000	0.000000
XM (7)	0.000000	0.000000
PMA (1)	0.000000	0.000000
PMA (2)	0.000000	0.000000
PMA (3)	0.000000	0.000000
PMA (4)	0.000000	0.000000
PMA (5)	0.000000	0.000000
PMA (6)	0.000000	0.000000
PMA (7)	0.000000	0.000000
PFM (1)	7447.396	0.000000

PFM(2)	38824.75	0.000000
PFM(3)	20396.36	0.000000
PFM(4)	2482.926	0.000000
PFM(5)	2719.329	0.000000
PFM(6)	3664.942	0.000000
PFM(7)	6028.976	0.000000
PFA_D(1)	0.000000	0.000000
PFA_D(2)	0.000000	0.000000
PFA_D(3)	0.000000	0.000000
PFA_D(4)	0.000000	0.000000
PFA_D(5)	0.000000	0.000000
PFA_D(6)	0.000000	0.000000
PFA_D(7)	0.000000	0.000000
PMA_D(1)	42552.60	0.000000
PMA_D(2)	11175.25	0.000000
PMA_D(3)	29603.64	0.000000
PMA_D(4)	47517.07	0.000000
PMA_D(5)	47280.67	0.000000
PMA_D(6)	46335.06	0.000000
PMA_D(7)	43971.02	0.000000
PMA_ST(1)	0.000000	0.000000
PMA_ST(2)	33268.58	0.000000
PMA_ST(3)	16731.42	0.000000
PMA_ST(4)	0.000000	0.000000
PMA_ST(5)	0.000000	0.000000
PMA_ST(6)	0.000000	0.000000
PMA_ST(7)	0.000000	0.000000
PMA_T(1)	42552.60	0.000000
PMA_T(2)	44443.83	0.000000

PMA_T (3)	46335.06	0.000000
PMA_T (4)	47517.07	0.000000
PMA_T (5)	47280.67	0.000000
PMA_T (6)	46335.06	0.000000
PMA_T (7)	43971.02	0.000000
MHR (1)	50000.00	0.000000
MHR (2)	50000.00	0.000000
MHR (3)	50000.00	0.000000
MHR (4)	50000.00	0.000000
MHR (5)	50000.00	0.000000
MHR (6)	50000.00	0.000000
MHR (7)	50000.00	0.000000
PJN (1)	0.2050000	0.000000
PJN (2)	0.2120000	0.000000
PJN (3)	0.2150000	0.000000
PJN (4)	0.2159000	0.000000
PJN (5)	0.2060000	0.000000
PJN (6)	0.2130000	0.000000
PJN (7)	0.1950000	0.000000
XJN (1)	0.000000	0.000000
XJN (2)	0.000000	0.000000
XJN (3)	0.000000	0.000000
XJN (4)	0.000000	0.000000
XJN (5)	0.000000	0.000000
XJN (6)	0.000000	0.000000
XJN (7)	0.000000	0.000000
PJNA (1)	0.000000	0.000000
PJNA (2)	0.000000	0.000000
PJNA (3)	0.000000	0.000000

PJNA (4)	0.000000	0.000000
PJNA (5)	0.000000	0.000000
PJNA (6)	0.000000	0.000000
PJNA (7)	0.000000	0.000000
PFJN (1)	1537.312	0.000000
PFJN (2)	0.000000	0.000000
PFJN (3)	47662.37	0.000000
PFJN (4)	0.000000	0.000000
PFJN (5)	1300.909	0.000000
PFJN (6)	0.000000	0.000000
PFJN (7)	3901.346	0.000000
JNFA_D (1)	0.000000	0.000000
JNFA_D (2)	0.000000	0.000000
JNFA_D (3)	0.000000	0.000000
JNFA_D (4)	0.000000	0.000000
JNFA_D (5)	0.000000	0.000000
JNFA_D (6)	0.000000	0.000000
JNFA_D (7)	0.000000	0.000000
PJNA_D (1)	48462.69	0.000000
PJNA_D (2)	50000.00	0.000000
PJNA_D (3)	2337.631	0.000000
PJNA_D (4)	50000.00	0.000000
PJNA_D (5)	48699.09	0.000000
PJNA_D (6)	50000.00	0.000000
PJNA_D (7)	46098.65	0.000000
PJNA_ST (1)	0.000000	0.000000
PJNA_ST (2)	117.5112	0.000000
PJNA_ST (3)	48489.09	0.000000
PJNA_ST (4)	1039.484	0.000000

PJNA_ST (5)	0.000000	0.000000
PJNA_ST (6)	353.9146	0.000000
PJNA_ST (7)	0.000000	0.000000
PJNA_T (1)	48462.69	0.000000
PJNA_T (2)	50117.51	0.000000
PJNA_T (3)	50826.72	0.000000
PJNA_T (4)	51039.48	0.000000
PJNA_T (5)	48699.09	0.000000
PJNA_T (6)	50353.91	0.000000
PJNA_T (7)	46098.65	0.000000
JNHR (1)	50000.00	0.000000
JNHR (2)	50000.00	0.000000
JNHR (3)	50000.00	0.000000
JNHR (4)	50000.00	0.000000
JNHR (5)	50000.00	0.000000
JNHR (6)	50000.00	0.000000
JNHR (7)	50000.00	0.000000
PJL (1)	0.1818000	0.000000
PJL (2)	0.1959000	0.000000
PJL (3)	0.1986000	0.000000
PJL (4)	0.1998000	0.000000
PJL (5)	0.2044000	0.000000
PJL (6)	0.2000000	0.000000
PJL (7)	0.2019000	0.000000
XJL (1)	0.000000	0.000000
XJL (2)	0.000000	0.000000
XJL (3)	0.000000	0.000000
XJL (4)	0.000000	0.000000
XJL (5)	0.000000	0.000000

XJL (6)	0.000000	0.000000
XJL (7)	0.000000	0.000000
PJLA (1)	0.000000	0.000000
PJLA (2)	0.000000	0.000000
PJLA (3)	0.000000	0.000000
PJLA (4)	0.000000	0.000000
PJLA (5)	0.000000	0.000000
PJLA (6)	0.000000	0.000000
PJLA (7)	0.000000	0.000000
PFJL (1)	50000.00	0.000000
PFJL (2)	10710.45	0.000000
PFJL (3)	3050.294	0.000000
PFJL (4)	2766.610	0.000000
PFJL (5)	1679.154	0.000000
PFJL (6)	2719.329	0.000000
PFJL (7)	2270.163	0.000000
JLFA_D (1)	0.000000	0.000000
JLFA_D (2)	0.000000	0.000000
JLFA_D (3)	0.000000	0.000000
JLFA_D (4)	0.000000	0.000000
JLFA_D (5)	0.000000	0.000000
JLFA_D (6)	0.000000	0.000000
JLFA_D (7)	0.000000	0.000000
PJLA_D (1)	0.000000	0.000000
PJLA_D (2)	39289.55	0.000000
PJLA_D (3)	46949.71	0.000000
PJLA_D (4)	47233.39	0.000000
PJLA_D (5)	48320.85	0.000000
PJLA_D (6)	47280.67	0.000000

PJLA_D (7)	47729.84	0.000000
PJLA_ST (1)	42978.13	0.000000
PJLA_ST (2)	7021.870	0.000000
PJLA_ST (3)	0.000000	0.000000
PJLA_ST (4)	0.000000	0.000000
PJLA_ST (5)	0.000000	0.000000
PJLA_ST (6)	0.000000	0.000000
PJLA_ST (7)	0.000000	0.000000
PJLA_T (1)	42978.13	0.000000
PJLA_T (2)	46311.42	0.000000
PJLA_T (3)	46949.71	0.000000
PJLA_T (4)	47233.39	0.000000
PJLA_T (5)	48320.85	0.000000
PJLA_T (6)	47280.67	0.000000
PJLA_T (7)	47729.84	0.000000
JLHR (1)	50000.00	0.000000
JLHR (2)	50000.00	0.000000
JLHR (3)	50000.00	0.000000
JLHR (4)	50000.00	0.000000
JLHR (5)	50000.00	0.000000
JLHR (6)	50000.00	0.000000
JLHR (7)	50000.00	0.000000
PG (1)	0.1830000	0.000000
PG (2)	0.1970000	0.000000
PG (3)	0.1920000	0.000000
PG (4)	0.1960000	0.000000
PG (5)	0.1880000	0.000000
PG (6)	0.1870000	0.000000
PG (7)	0.1800000	0.000000

XG (1)	0.000000	0.000000
XG (2)	0.000000	0.000000
XG (3)	0.000000	0.000000
XG (4)	0.000000	0.000000
XG (5)	0.000000	0.000000
XG (6)	0.000000	0.000000
XG (7)	0.000000	0.000000
PGA (1)	0.000000	0.000000
PGA (2)	0.000000	0.000000
PGA (3)	0.000000	0.000000
PGA (4)	0.000000	0.000000
PGA (5)	0.000000	0.000000
PGA (6)	0.000000	0.000000
PGA (7)	0.000000	0.000000
PFG (1)	50000.00	0.000000
PFG (2)	10166.73	0.000000
PFG (3)	4610.556	0.000000
PFG (4)	3664.942	0.000000
PFG (5)	5556.169	0.000000
PFG (6)	5792.573	0.000000
PFG (7)	7447.396	0.000000
GFA_D (1)	0.000000	0.000000
GFA_D (2)	0.000000	0.000000
GFA_D (3)	0.000000	0.000000
GFA_D (4)	0.000000	0.000000
GFA_D (5)	0.000000	0.000000
GFA_D (6)	0.000000	0.000000
GFA_D (7)	0.000000	0.000000
PGA_ST (1)	43261.81	0.000000

PGA_ST (2)	6738.186	0.000000
PGA_ST (3)	0.000000	0.000000
PGA_ST (4)	0.000000	0.000000
PGA_ST (5)	0.000000	0.000000
PGA_ST (6)	0.000000	0.000000
PGA_ST (7)	0.000000	0.000000
PGA_D (1)	0.000000	0.000000
PGA_D (2)	39833.27	0.000000
PGA_D (3)	45389.44	0.000000
PGA_D (4)	46335.06	0.000000
PGA_D (5)	44443.83	0.000000
PGA_D (6)	44207.43	0.000000
PGA_D (7)	42552.60	0.000000
PGA_T (1)	43261.81	0.000000
PGA_T (2)	46571.46	0.000000
PGA_T (3)	45389.44	0.000000
PGA_T (4)	46335.06	0.000000
PGA_T (5)	44443.83	0.000000
PGA_T (6)	44207.43	0.000000
PGA_T (7)	42552.60	0.000000
GHR (1)	50000.00	0.000000
GHR (2)	50000.00	0.000000
GHR (3)	50000.00	0.000000
GHR (4)	50000.00	0.000000
GHR (5)	50000.00	0.000000
GHR (6)	50000.00	0.000000
GHR (7)	50000.00	0.000000
PS (1)	0.1876000	0.000000
PS (2)	0.1930000	0.000000

PS (3)	0.1840000	0.000000
PS (4)	0.1790000	0.000000
PS (5)	0.1720000	0.000000
PS (6)	0.1660000	0.000000
PS (7)	0.1630000	0.000000
XS (1)	0.000000	0.000000
XS (2)	0.000000	0.000000
XS (3)	0.000000	0.000000
XS (4)	0.000000	0.000000
XS (5)	0.000000	0.000000
XS (6)	0.000000	0.000000
XS (7)	0.000000	0.000000
PSA (1)	0.000000	0.000000
PSA (2)	0.000000	0.000000
PSA (3)	0.000000	0.000000
PSA (4)	0.000000	0.000000
PSA (5)	0.000000	0.000000
PSA (6)	0.000000	0.000000
PSA (7)	0.000000	0.000000
PFS (1)	5650.731	0.000000
PFS (2)	4374.153	0.000000
PFS (3)	6501.783	0.000000
PFS (4)	25926.49	0.000000
PFS (5)	25926.49	0.000000
PFS (6)	25926.49	0.000000
PFS (7)	11466.25	0.000000
SFA_D (1)	0.000000	0.000000
SFA_D (2)	0.000000	0.000000

SFA_D (3)	0.000000	0.000000
SFA_D (4)	0.000000	0.000000
SFA_D (5)	0.000000	0.000000
SFA_D (6)	0.000000	0.000000
SFA_D (7)	0.000000	0.000000
PSA_ST (1)	0.000000	0.000000
PSA_ST (2)	0.000000	0.000000
PSA_ST (3)	0.000000	0.000000
PSA_ST (4)	18242.69	0.000000
PSA_ST (5)	16587.87	0.000000
PSA_ST (6)	15169.45	0.000000
PSA_ST (7)	0.000000	0.000000
PSA_T (1)	44349.27	0.000000
PSA_T (2)	45625.85	0.000000
PSA_T (3)	43498.22	0.000000
PSA_T (4)	42316.20	0.000000
PSA_T (5)	40661.38	0.000000
PSA_T (6)	39242.96	0.000000
PSA_T (7)	38533.75	0.000000
PSA_D (1)	44349.27	0.000000
PSA_D (2)	45625.85	0.000000
PSA_D (3)	43498.22	0.000000
PSA_D (4)	24073.51	0.000000
PSA_D (5)	24073.51	0.000000
PSA_D (6)	24073.51	0.000000
PSA_D (7)	38533.75	0.000000
SHR (1)	50000.00	0.000000
SHR (2)	50000.00	0.000000
SHR (3)	50000.00	0.000000

SHR(4)	50000.00	0.000000
SHR(5)	50000.00	0.000000
SHR(6)	50000.00	0.000000
SHR(7)	50000.00	0.000000

**7th. SOLAR FOSSIL FUEL LOAD ALL THE YEAR AT FULL LOAD
CAPACITY (SUNSHINE HOURS DAILY)**

! This program is to find the minimum collectors area that absorb solar energy enough to run the solar power plant at full load ALL THE SUNSHINE TIME;

SETS:

APRIL/1..13/:PP,XP,PPA,PFAP,HRP;

MAI/1..13/:PM,XM,PMA,PFM,HRM;

JUNE/1..14/:PJN,XJN,PJNA,PFJN,HRJN;

JULY/1..14/:PJL,XJL,PJLA,PFJL,HRJL;

AUGUST/1..13/:PG,XG,PGA,PGF,HRG;

SEPTEMBER/1..11/:PS,XS,PSA,PFS,HRS;

JANUARY/1..10/:PJ,XJ,PJA,PFJ,HRJ;

FEBRUARY/1..10/:PF,XF,PFA,PFH,HRF;

MARCH/1..12/:PR,XR,PRA,PFH,HRR;

OCTOBER/1..11/:POC,XOC,POCA,PFH,HROC;

```

NOVMEBR/1..9/:PN,XN,PNA,PFN,HRN;

DECEMBER/1..9/:PD,XD,PDA,PF,D,HRD;

ENDSETS

DATA:

PJ=

0.022,0.07738,0.09353,0.08583,0.08194,0.08268,0.09172,0.09496,0.08128,0.
.01944;

PF=0.06176,0.09576,0.1049,0.1014,0.0983,0.0955,0.10516,0.1107,0.1079,0.
07569;

PR=0.07767,0.158,0.18849,0.19,0.19,0.181,0.181,0.181,0.180,0.169,0.144,
0.05739;

PP=

0.002,0.109,0.161,0.192,0.2,0.201,0.202,0.191,0.192,0.19298,0.172,0.155
4,0.088;

PM=0.041,0.12,0.161,0.18,0.188,0.196,0.201,0.2,0.196,0.186,0.176,0.154,
0.0895;

PJN=0.0727,0.146,0.184,0.205,0.212,0.215,0.206,0.213,0.195,0.188,0.162,
0.162,0.1159,0.02229;

PJL=0.0436,0.1194,0.1607,0.1818,0.1959,0.1986,0.1998,0.2044,0.2,0.2019,
0.1893,0.161,0.115,0.0185;

PG=0.012,0.11,0.161,0.183,0.197,0.192,0.196,0.188,0.187,0.18,0.16,0.134
,0.083;

PS=0.105,0.161,0.184,0.193,0.184,0.179,0.166,0.163,0.135,0.115,0.033;

POC=0.0562,0.125,0.148,0.15,0.147,0.133,0.128,0.137,0.136,0.122,0.06;

PN=0.127,0.158,0.156,0.148,0.136,0.129,0.126,0.119,0.107;

PD=0.043,0.082,0.088,0.079,0.068,0.069,0.0757,0.073,0.0518;

ENDDATA

!APRIL(P);

@FOR(APRIL(i):PPA(i)=AREA*PP(i));

```

```

PPT=@SUM(APRIL(i):PPA(i));

@FOR(APRIL(i):(PPA(i)+PFAP(i))>=50000);

PFAPT=@SUM(APRIL(i):PFAP(i));

@FOR(APRIL(i):HRP(i)=PPA(i)+PFAP(i));

!MAI(M);

@FOR(MAI(i):PMA(i)=AREA*PM(i));

PMT=@SUM(MAI(i):PMA(i));

@FOR(MAI(i):(PMA(i)+PFM(i))>=50000);

PFMT=@SUM(MAI(i):PFM(i));

@FOR(MAI(i):HRM(i)=PMA(i)+PFM(i));

!JUNE(JN);

@FOR(JUNE(i):PJNA(i)=AREA*PJN(i));

PJNT=@SUM(JUNE(i):PJNA(i));

@FOR(JUNE(i):(PJNA(i)+PFJN(i))>=50000);

PFJNT=@SUM(JUNE(i):PFJN(i));

@FOR(JUNE(i):HRJN(i)=PJNA(i)+PFJN(i));

!JULY(JL);

@FOR(JULY(i):PJLA(i)=AREA*PJL(i));

PJLT=@SUM(JULY(i):PJLA(i));

@FOR(JULY(i):(PJLA(i)+PFJL(i))>=50000);

PFJLT=@SUM(JULY(i):PFJL(i));

@FOR(JULY(i):HRJL(i)=PJLA(i)+PFJL(i));

!AUGUST(G);

@FOR(AUGUST(i):PGA(i)=AREA*PG(i));

PGT=@SUM(AUGUST(i):PGA(i));

@FOR(AUGUST(i):(PGA(i)+PFG(i))>=50000);

PFGT=@SUM(AUGUST(i):PFG(i));

@FOR(AUGUST(i):HRG(i)=PGA(i)+PFG(i));

!SEPTEMBER;

```

```

@FOR (SEPTEMBER (i) : PsA (i) = AREA * Ps (i) );
PsT = @SUM (SEPTEMBER (i) : PsA (i) );
@FOR (SEPTEMBER (i) : (PSA (i) + PFS (i) ) >= 50000 );
PFST = @SUM (SEPTEMBER (i) : PFs (i) );
@FOR (SEPTEMBER (i) : HRS (i) = PSA (i) + PFS (i) );
!!!!!!!!!!!!!!!!!!!!!!!!!!!!!!!!!!!!!!!!!!!!!!!!!!!!!!;
!THE WINTER WILL RUN USING FUEL & SOLAR TOGETHER TO GET FULL LOAD;
!october;
@FOR (OCTOBER (i) : POCA (i) = AREA * POC (i) );
@FOR (OCTOBER (i) : (POCA (i) + PFOC (i) ) >= 50000 );
POCT = @SUM (OCTOBER (i) : POCA (i) );
PFOCT = @SUM (OCTOBER (i) : PFOC (i) );
PTOC = @SUM (OCTOBER (i) : (POCA (i) + PFOC (i) ) );
@FOR (OCTOBER (i) : HROC (i) = POCA (i) + PFOC (i) );
!NOVMEBR;
@FOR (NOVMEBR (i) : PNA (i) = AREA * PN (i) );
@FOR (NOVMEBR (i) : (PNA (i) + PFN (i) ) >= 50000 );
PNT = @SUM (NOVMEBR (i) : PNA (i) );
PFNT = @SUM (NOVMEBR (i) : PFN (i) );
PTN = @SUM (NOVMEBR (i) : (PNA (i) + PFN (i) ) );
@FOR (NOVMEBR (i) : HRN (i) = PNA (i) + PFN (i) );
!DECEMBER;
@FOR (DECEMBER (i) : PDA (i) = AREA * PD (i) );
@FOR (DECEMBER (i) : (PDA (i) + PFD (i) ) >= 50000 );
PDT = @SUM (DECEMBER (i) : PDA (i) );
PFDT = @SUM (DECEMBER (i) : PFD (i) );
PTD = @SUM (DECEMBER (i) : (PDA (i) + PFD (i) ) );
@FOR (DECEMBER (i) : HRD (i) = PDA (i) + PFD (i) );
!JANUARY;

```

```

@FOR (JANUARY (i) : PJA (i) = AREA * PJ (i) );
@FOR (JANUARY (i) : (PJA (i) + PFJ (i)) >= 50000);
PJT = @SUM (JANUARY (i) : PJA (i) );
PFJT = @SUM (JANUARY (i) : PFJ (i) );
PTJ = @SUM (JANUARY (i) : (PJA (i) + PFJ (i)) );
@FOR (JANUARY (i) : HRJ (i) = PJA (i) + PFJ (i) );
!FEBRUARY;
@FOR (FEBRUARY (i) : PFA (i) = AREA * PF (i) );
@FOR (FEBRUARY (i) : (PFA (i) + PFF (i)) >= 50000);
PFT = @SUM (FEBRUARY (i) : PFA (i) );
PFFT = @SUM (FEBRUARY (i) : PFF (i) );
PTD = @SUM (FEBRUARY (i) : (PFA (i) + PFF (i)) );
@FOR (FEBRUARY (i) : HRF (i) = PFA (i) + PFF (i) );
!MARCH;
@FOR (MARCH (i) : PRA (i) = AREA * PR (i) );
@FOR (MARCH (i) : (PRA (i) + PFR (i)) >= 50000);
PRT = @SUM (MARCH (i) : PRA (i) );
PFRT = @SUM (MARCH (i) : PFR (i) );
PTR = @SUM (MARCH (i) : (PRA (i) + PFR (i)) );
@FOR (MARCH (i) : HRR (i) = PRA (i) + PFR (i) );
PT_SUMMER = 30 * PPT + 31 * PMT + 30 * PJNT + 31 * PJLT + 31 * PGT;
P_Annual = PT_Summer + PT_WINTER;
PT_WINTER = 31 * PRT + 31 * PJT + 28 * PFT + 31 * POCT + 31 * PDT;
PFUEL = 31 * PFOCT + 30 * PFNT + 31 * PFDT + 31 * PFJT + 28 * PFFT + 31 * PFRT + 30 * PFAPT + 31 * PFMT
+ 30 * PFJNT + 31 * PFJLT + 31 * PFGT + 30 * PFST;
RATIO = PFUEL / P_Annual;
CO2_reduction = 300 * Area;
RATIO <= (1/3);
Net_Ele = (1 - 0.084) * (P_Annual + PFUEL);

```

```

Fuel_saver=Net_Ele /301790;

Full_HRS=Net_Ele /50000;

LEC=((302*AREA+592*N_P)*0.104+OM_HYBRID*Net_Ele+FUEL_COST )/Net_Ele ;

N_P=50000;

OM_HYBRID=0.018;

FUEL_COST =0.028*PFUEL;

!FUEL_COST IS 0.028$/KWhe, THAT EQUAL 8$/MBTU;

```

- **Output results**

Feasible solution found.

Total solver iterations: 634

Variable	Value
AREA	304018.6
PPT	625785.8
PFAPT	93308.81
PMT	634942.9
PFMT	78077.47
PJNT	698905.4
PFJNT	92996.77
PJLT	665770.4
PFJLT	112055.7
PGT	602868.9
PFGT	99347.71
PST	491902.1
PFST	83538.75
POCT	408053.8

PFOCT	141946.2
PTOC	550000.0
PNT	366646.4
PFNT	83353.55
PTN	450000.0
PDT	191379.7
PFDT	308620.3
PTD	500000.0
PJT	222164.6
PFJT	277835.4
PTJ	500000.0
PFT	290967.1
PFFT	209032.9
PRT	576890.5
PFRT	67125.62
PTR	644016.1
PT_SUMMER	0.9875178E+08
P_ANNUAL	0.1502520E+09
PT_WINTER	0.5150023E+08
PFUEL	0.5008412E+08
RATIO	0.3333333
CO2_REDUCTION	0.9120558E+08
NET_ELE	0.1835079E+09
FUEL_SAVER	608.0649
FULL_HRS	3670.158
LEC	0.9445105E-01
N_P	50000.00
OM_HYBRID	0.1800000E-01
FUEL_COST	1402355.

PP (1)	0.2000000E-02
PP (2)	0.1090000
PP (3)	0.1610000
PP (4)	0.1920000
PP (5)	0.2000000
PP (6)	0.2010000
PP (7)	0.2020000
PP (8)	0.1910000
PP (9)	0.1920000
PP (10)	0.1929800
PP (11)	0.1720000
PP (12)	0.1554000
PP (13)	0.8800000E-01
XP (1)	0.000000
XP (2)	0.000000
XP (3)	0.000000
XP (4)	0.000000
XP (5)	0.000000
XP (6)	0.000000
XP (7)	0.000000
XP (8)	0.000000
XP (9)	0.000000
XP (10)	0.000000
XP (11)	0.000000
XP (12)	0.000000
XP (13)	0.000000
PPA (1)	608.0372
PPA (2)	33138.03
PPA (3)	48947.00

PPA (4)	58371.57
PPA (5)	60803.72
PPA (6)	61107.74
PPA (7)	61411.76
PPA (8)	58067.56
PPA (9)	58371.57
PPA (10)	58669.51
PPA (11)	52291.20
PPA (12)	47244.49
PPA (13)	26753.64
PFAP (1)	49391.96
PFAP (2)	16861.97
PFAP (3)	1053.003
PFAP (4)	0.000000
PFAP (5)	0.000000
PFAP (6)	0.000000
PFAP (7)	0.000000
PFAP (8)	0.000000
PFAP (9)	0.000000
PFAP (10)	0.000000
PFAP (11)	0.000000
PFAP (12)	2755.507
PFAP (13)	23246.36
HRP (1)	50000.00
HRP (2)	50000.00
HRP (3)	50000.00
HRP (4)	58371.57
HRP (5)	60803.72
HRP (6)	61107.74

HRP (7)	61411.76
HRP (8)	58067.56
HRP (9)	58371.57
HRP (10)	58669.51
HRP (11)	52291.20
HRP (12)	50000.00
HRP (13)	50000.00
PM (1)	0.4100000E-01
PM (2)	0.1200000
PM (3)	0.1610000
PM (4)	0.1800000
PM (5)	0.1880000
PM (6)	0.1960000
PM (7)	0.2010000
PM (8)	0.2000000
PM (9)	0.1960000
PM (10)	0.1860000
PM (11)	0.1760000
PM (12)	0.1540000
PM (13)	0.8950000E-01
XM (1)	0.000000
XM (2)	0.000000
XM (3)	0.000000
XM (4)	0.000000
XM (5)	0.000000
XM (6)	0.000000
XM (7)	0.000000
XM (8)	0.000000
XM (9)	0.000000

XM(10)	0.000000
XM(11)	0.000000
XM(12)	0.000000
XM(13)	0.000000
PMA(1)	12464.76
PMA(2)	36482.23
PMA(3)	48947.00
PMA(4)	54723.35
PMA(5)	57155.50
PMA(6)	59587.65
PMA(7)	61107.74
PMA(8)	60803.72
PMA(9)	59587.65
PMA(10)	56547.46
PMA(11)	53507.28
PMA(12)	46818.87
PMA(13)	27209.67
PFM(1)	37535.24
PFM(2)	13517.77
PFM(3)	1053.003
PFM(4)	0.000000
PFM(5)	0.000000
PFM(6)	0.000000
PFM(7)	0.000000
PFM(8)	0.000000
PFM(9)	0.000000
PFM(10)	0.000000
PFM(11)	0.000000
PFM(12)	3181.133

PFM(13)	22790.33
HRM(1)	50000.00
HRM(2)	50000.00
HRM(3)	50000.00
HRM(4)	54723.35
HRM(5)	57155.50
HRM(6)	59587.65
HRM(7)	61107.74
HRM(8)	60803.72
HRM(9)	59587.65
HRM(10)	56547.46
HRM(11)	53507.28
HRM(12)	50000.00
HRM(13)	50000.00
PJN(1)	0.7270000E-01
PJN(2)	0.1460000
PJN(3)	0.1840000
PJN(4)	0.2050000
PJN(5)	0.2120000
PJN(6)	0.2150000
PJN(7)	0.2060000
PJN(8)	0.2130000
PJN(9)	0.1950000
PJN(10)	0.1880000
PJN(11)	0.1620000
PJN(12)	0.1620000
PJN(13)	0.1159000
PJN(14)	0.2229000E-01
XJN(1)	0.000000

XJN (2)	0.000000
XJN (3)	0.000000
XJN (4)	0.000000
XJN (5)	0.000000
XJN (6)	0.000000
XJN (7)	0.000000
XJN (8)	0.000000
XJN (9)	0.000000
XJN (10)	0.000000
XJN (11)	0.000000
XJN (12)	0.000000
XJN (13)	0.000000
XJN (14)	0.000000
PJNA (1)	22102.15
PJNA (2)	44386.72
PJNA (3)	55939.43
PJNA (4)	62323.82
PJNA (5)	64451.95
PJNA (6)	65364.00
PJNA (7)	62627.83
PJNA (8)	64755.96
PJNA (9)	59283.63
PJNA (10)	57155.50
PJNA (11)	49251.02
PJNA (12)	49251.02
PJNA (13)	35235.76
PJNA (14)	6776.575
PFJN (1)	27897.85
PFJN (2)	5613.282

PFJN (3)	0.000000
PFJN (4)	0.000000
PFJN (5)	0.000000
PFJN (6)	0.000000
PFJN (7)	0.000000
PFJN (8)	0.000000
PFJN (9)	0.000000
PFJN (10)	0.000000
PFJN (11)	748.9844
PFJN (12)	748.9844
PFJN (13)	14764.24
PFJN (14)	43223.43
HRJN (1)	50000.00
HRJN (2)	50000.00
HRJN (3)	55939.43
HRJN (4)	62323.82
HRJN (5)	64451.95
HRJN (6)	65364.00
HRJN (7)	62627.83
HRJN (8)	64755.96
HRJN (9)	59283.63
HRJN (10)	57155.50
HRJN (11)	50000.00
HRJN (12)	50000.00
HRJN (13)	50000.00
HRJN (14)	50000.00
PJL (1)	0.4360000E-01
PJL (2)	0.1194000
PJL (3)	0.1607000

PJL(4)	0.1818000
PJL(5)	0.1959000
PJL(6)	0.1986000
PJL(7)	0.1998000
PJL(8)	0.2044000
PJL(9)	0.2000000
PJL(10)	0.2019000
PJL(11)	0.1893000
PJL(12)	0.1610000
PJL(13)	0.1150000
PJL(14)	0.1850000E-01
XJL(1)	0.000000
XJL(2)	0.000000
XJL(3)	0.000000
XJL(4)	0.000000
XJL(5)	0.000000
XJL(6)	0.000000
XJL(7)	0.000000
XJL(8)	0.000000
XJL(9)	0.000000
XJL(10)	0.000000
XJL(11)	0.000000
XJL(12)	0.000000
XJL(13)	0.000000
XJL(14)	0.000000
PJLA(1)	13255.21
PJLA(2)	36299.82
PJLA(3)	48855.79
PJLA(4)	55270.58

PJLA (5)	59557.25
PJLA (6)	60378.10
PJLA (7)	60742.92
PJLA (8)	62141.40
PJLA (9)	60803.72
PJLA (10)	61381.36
PJLA (11)	57550.72
PJLA (12)	48947.00
PJLA (13)	34962.14
PJLA (14)	5624.344
PFJL (1)	36744.79
PFJL (2)	13700.18
PFJL (3)	1144.209
PFJL (4)	0.000000
PFJL (5)	0.000000
PFJL (6)	0.000000
PFJL (7)	0.000000
PFJL (8)	0.000000
PFJL (9)	0.000000
PFJL (10)	0.000000
PFJL (11)	0.000000
PFJL (12)	1053.003
PFJL (13)	15037.86
PFJL (14)	44375.66
HRJL (1)	50000.00
HRJL (2)	50000.00
HRJL (3)	50000.00
HRJL (4)	55270.58
HRJL (5)	59557.25

HRJL (6)	60378.10
HRJL (7)	60742.92
HRJL (8)	62141.40
HRJL (9)	60803.72
HRJL (10)	61381.36
HRJL (11)	57550.72
HRJL (12)	50000.00
HRJL (13)	50000.00
HRJL (14)	50000.00
PG (1)	0.1200000E-01
PG (2)	0.1100000
PG (3)	0.1610000
PG (4)	0.1830000
PG (5)	0.1970000
PG (6)	0.1920000
PG (7)	0.1960000
PG (8)	0.1880000
PG (9)	0.1870000
PG (10)	0.1800000
PG (11)	0.1600000
PG (12)	0.1340000
PG (13)	0.8300000E-01
XG (1)	0.000000
XG (2)	0.000000
XG (3)	0.000000
XG (4)	0.000000
XG (5)	0.000000
XG (6)	0.000000
XG (7)	0.000000

XG(8)	0.000000
XG(9)	0.000000
XG(10)	0.000000
XG(11)	0.000000
XG(12)	0.000000
XG(13)	0.000000
PGA(1)	3648.223
PGA(2)	33442.05
PGA(3)	48947.00
PGA(4)	55635.41
PGA(5)	59891.67
PGA(6)	58371.57
PGA(7)	59587.65
PGA(8)	57155.50
PGA(9)	56851.48
PGA(10)	54723.35
PGA(11)	48642.98
PGA(12)	40738.49
PGA(13)	25233.55
PFG(1)	46351.78
PFG(2)	16557.95
PFG(3)	1053.003
PFG(4)	0.000000
PFG(5)	0.000000
PFG(6)	0.000000
PFG(7)	0.000000
PFG(8)	0.000000
PFG(9)	0.000000
PFG(10)	0.000000

PFG (11)	1357.022
PFG (12)	9261.506
PFG (13)	24766.45
HRG (1)	50000.00
HRG (2)	50000.00
HRG (3)	50000.00
HRG (4)	55635.41
HRG (5)	59891.67
HRG (6)	58371.57
HRG (7)	59587.65
HRG (8)	57155.50
HRG (9)	56851.48
HRG (10)	54723.35
HRG (11)	50000.00
HRG (12)	50000.00
HRG (13)	50000.00
PS (1)	0.1050000
PS (2)	0.1610000
PS (3)	0.1840000
PS (4)	0.1930000
PS (5)	0.1840000
PS (6)	0.1790000
PS (7)	0.1660000
PS (8)	0.1630000
PS (9)	0.1350000
PS (10)	0.1150000
PS (11)	0.3300000E-01
XS (1)	0.000000
XS (2)	0.000000

XS (3)	0.000000
XS (4)	0.000000
XS (5)	0.000000
XS (6)	0.000000
XS (7)	0.000000
XS (8)	0.000000
XS (9)	0.000000
XS (10)	0.000000
XS (11)	0.000000
PSA (1)	31921.95
PSA (2)	48947.00
PSA (3)	55939.43
PSA (4)	58675.59
PSA (5)	55939.43
PSA (6)	54419.33
PSA (7)	50467.09
PSA (8)	49555.03
PSA (9)	41042.51
PSA (10)	34962.14
PSA (11)	10032.61
PFS (1)	18078.05
PFS (2)	1053.003
PFS (3)	0.000000
PFS (4)	0.000000
PFS (5)	0.000000
PFS (6)	0.000000
PFS (7)	0.000000
PFS (8)	444.9658
PFS (9)	8957.487

PFS (10)	15037.86
PFS (11)	39967.39
HRS (1)	50000.00
HRS (2)	50000.00
HRS (3)	55939.43
HRS (4)	58675.59
HRS (5)	55939.43
HRS (6)	54419.33
HRS (7)	50467.09
HRS (8)	50000.00
HRS (9)	50000.00
HRS (10)	50000.00
HRS (11)	50000.00
PJ (1)	0.2200000E-01
PJ (2)	0.7738000E-01
PJ (3)	0.9353000E-01
PJ (4)	0.8583000E-01
PJ (5)	0.8194000E-01
PJ (6)	0.8268000E-01
PJ (7)	0.9172000E-01
PJ (8)	0.9496000E-01
PJ (9)	0.8128000E-01
PJ (10)	0.1944000E-01
XJ (1)	0.000000
XJ (2)	0.000000
XJ (3)	0.000000
XJ (4)	0.000000
XJ (5)	0.000000
XJ (6)	0.000000

XJ(7)	0.000000
XJ(8)	0.000000
XJ(9)	0.000000
XJ(10)	0.000000
PJA(1)	6688.410
PJA(2)	23524.96
PJA(3)	28434.86
PJA(4)	26093.92
PJA(5)	24911.29
PJA(6)	25136.26
PJA(7)	27884.59
PJA(8)	28869.61
PJA(9)	24710.63
PJA(10)	5910.122
PFJ(1)	43311.59
PFJ(2)	26475.04
PFJ(3)	21565.14
PFJ(4)	23906.08
PFJ(5)	25088.71
PFJ(6)	24863.74
PFJ(7)	22115.41
PFJ(8)	21130.39
PFJ(9)	25289.37
PFJ(10)	44089.88
HRJ(1)	50000.00
HRJ(2)	50000.00
HRJ(3)	50000.00
HRJ(4)	50000.00
HRJ(5)	50000.00

HRJ (6)	50000.00
HRJ (7)	50000.00
HRJ (8)	50000.00
HRJ (9)	50000.00
HRJ (10)	50000.00
PF (1)	0.6176000E-01
PF (2)	0.9576000E-01
PF (3)	0.1049000
PF (4)	0.1014000
PF (5)	0.9830000E-01
PF (6)	0.9550000E-01
PF (7)	0.1051600
PF (8)	0.1107000
PF (9)	0.1079000
PF (10)	0.7569000E-01
XF (1)	0.000000
XF (2)	0.000000
XF (3)	0.000000
XF (4)	0.000000
XF (5)	0.000000
XF (6)	0.000000
XF (7)	0.000000
XF (8)	0.000000
XF (9)	0.000000
XF (10)	0.000000
PFA (1)	18776.19
PFA (2)	29112.82
PFA (3)	31891.55
PFA (4)	30827.49

PFA (5)	29885.03
PFA (6)	29033.78
PFA (7)	31970.60
PFA (8)	33654.86
PFA (9)	32803.61
PFA (10)	23011.17
PFF (1)	31223.81
PFF (2)	20887.18
PFF (3)	18108.45
PFF (4)	19172.51
PFF (5)	20114.97
PFF (6)	20966.22
PFF (7)	18029.40
PFF (8)	16345.14
PFF (9)	17196.39
PFF (10)	26988.83
HRF (1)	50000.00
HRF (2)	50000.00
HRF (3)	50000.00
HRF (4)	50000.00
HRF (5)	50000.00
HRF (6)	50000.00
HRF (7)	50000.00
HRF (8)	50000.00
HRF (9)	50000.00
HRF (10)	50000.00
PR (1)	0.7767000E-01
PR (2)	0.1580000
PR (3)	0.1884900

PR(4)	0.1900000
PR(5)	0.1900000
PR(6)	0.1810000
PR(7)	0.1810000
PR(8)	0.1810000
PR(9)	0.1800000
PR(10)	0.1690000
PR(11)	0.1440000
PR(12)	0.5739000E-01
XR(1)	0.000000
XR(2)	0.000000
XR(3)	0.000000
XR(4)	0.000000
XR(5)	0.000000
XR(6)	0.000000
XR(7)	0.000000
XR(8)	0.000000
XR(9)	0.000000
XR(10)	0.000000
XR(11)	0.000000
XR(12)	0.000000
PRA(1)	23613.13
PRA(2)	48034.94
PRA(3)	57304.47
PRA(4)	57763.54
PRA(5)	57763.54
PRA(6)	55027.37
PRA(7)	55027.37
PRA(8)	55027.37

PRA(9)	54723.35
PRA(10)	51379.15
PRA(11)	43778.68
PRA(12)	17447.63
PFR(1)	26386.87
PFR(2)	1965.059
PFR(3)	0.000000
PFR(4)	0.000000
PFR(5)	0.000000
PFR(6)	0.000000
PFR(7)	0.000000
PFR(8)	0.000000
PFR(9)	0.000000
PFR(10)	0.000000
PFR(11)	6221.319
PFR(12)	32552.37
HRR(1)	50000.00
HRR(2)	50000.00
HRR(3)	57304.47
HRR(4)	57763.54
HRR(5)	57763.54
HRR(6)	55027.37
HRR(7)	55027.37
HRR(8)	55027.37
HRR(9)	54723.35
HRR(10)	51379.15
HRR(11)	50000.00
HRR(12)	50000.00
POC(1)	0.5620000E-01

POC (2)	0.1250000
POC (3)	0.1480000
POC (4)	0.1500000
POC (5)	0.1470000
POC (6)	0.1330000
POC (7)	0.1280000
POC (8)	0.1370000
POC (9)	0.1360000
POC (10)	0.1220000
POC (11)	0.6000000E-01
XOC (1)	0.000000
XOC (2)	0.000000
XOC (3)	0.000000
XOC (4)	0.000000
XOC (5)	0.000000
XOC (6)	0.000000
XOC (7)	0.000000
XOC (8)	0.000000
XOC (9)	0.000000
XOC (10)	0.000000
XOC (11)	0.000000
POCA (1)	17085.85
POCA (2)	38002.33
POCA (3)	44994.75
POCA (4)	45602.79
POCA (5)	44690.74
POCA (6)	40434.48
POCA (7)	38914.38
POCA (8)	41650.55

POCA (9)	41346.53
POCA (10)	37090.27
POCA (11)	18241.12
PFOC (1)	32914.15
PFOC (2)	11997.67
PFOC (3)	5005.245
PFOC (4)	4397.208
PFOC (5)	5309.264
PFOC (6)	9565.524
PFOC (7)	11085.62
PFOC (8)	8349.450
PFOC (9)	8653.468
PFOC (10)	12909.73
PFOC (11)	31758.88
HROC (1)	50000.00
HROC (2)	50000.00
HROC (3)	50000.00
HROC (4)	50000.00
HROC (5)	50000.00
HROC (6)	50000.00
HROC (7)	50000.00
HROC (8)	50000.00
HROC (9)	50000.00
HROC (10)	50000.00
HROC (11)	50000.00
PN (1)	0.1270000
PN (2)	0.1580000
PN (3)	0.1560000
PN (4)	0.1480000

PN (5)	0.1360000
PN (6)	0.1290000
PN (7)	0.1260000
PN (8)	0.1190000
PN (9)	0.1070000
XN (1)	0.0000000
XN (2)	0.0000000
XN (3)	0.0000000
XN (4)	0.0000000
XN (5)	0.0000000
XN (6)	0.0000000
XN (7)	0.0000000
XN (8)	0.0000000
XN (9)	0.0000000
PNA (1)	38610.36
PNA (2)	48034.94
PNA (3)	47426.90
PNA (4)	44994.75
PNA (5)	41346.53
PNA (6)	39218.40
PNA (7)	38306.35
PNA (8)	36178.22
PNA (9)	32529.99
PFN (1)	11389.64
PFN (2)	1965.059
PFN (3)	2573.096
PFN (4)	5005.245
PFN (5)	8653.468
PFN (6)	10781.60

PFN (7)	11693.65
PFN (8)	13821.78
PFN (9)	17470.01
HRN (1)	50000.00
HRN (2)	50000.00
HRN (3)	50000.00
HRN (4)	50000.00
HRN (5)	50000.00
HRN (6)	50000.00
HRN (7)	50000.00
HRN (8)	50000.00
HRN (9)	50000.00
PD (1)	0.4300000E-01
PD (2)	0.8200000E-01
PD (3)	0.8800000E-01
PD (4)	0.7900000E-01
PD (5)	0.6800000E-01
PD (6)	0.6900000E-01
PD (7)	0.7570000E-01
PD (8)	0.7300000E-01
PD (9)	0.5180000E-01
XD (1)	0.000000
XD (2)	0.000000
XD (3)	0.000000
XD (4)	0.000000
XD (5)	0.000000
XD (6)	0.000000
XD (7)	0.000000
XD (8)	0.000000

XD (9)	0.000000
PDA (1)	13072.80
PDA (2)	24929.53
PDA (3)	26753.64
PDA (4)	24017.47
PDA (5)	20673.27
PDA (6)	20977.28
PDA (7)	23014.21
PDA (8)	22193.36
PDA (9)	15748.16
PFD (1)	36927.20
PFD (2)	75070.47
PFD (3)	23246.36
PFD (4)	25982.53
PFD (5)	29326.73
PFD (6)	29022.72
PFD (7)	26985.79
PFD (8)	27806.64
PFD (9)	34251.84
HRD (1)	50000.00
HRD (2)	100000.0
HRD (3)	50000.00
HRD (4)	50000.00
HRD (5)	50000.00
HRD (6)	50000.00
HRD (7)	50000.00
HRD (8)	50000.00
HRD (9)	50000.00

8th. SOLAR FOSSIL FUEL ALL THE YEAR (SUNSHINE HOURS DAILY) WITH 1 HR

- Lingo input

! This program is to find the minimum collectors area that aborb solar energy enough to run th e solar power plant at full load ALL THE SUNSHINE TIME;

SETS:

APRIL/1..13/:PP,XP,PPA,PPAU,PFAP,HRPU,PST;

MAI/1..13/:PM,XM,PMA,PMAU,PFM,HRMU,MST;

JUNE/1..14/:PJN,XJN,PJNA,PJNAU,PFJN,HRJNU,JNST;

JULY/1..14/:PJL,XJL,PJLA,PJLAU,PFJL,HRJLU,JLST;

AUGUST/1..13/:PG,XG,PGA,PGAU,PGF,HRGU,GST;

SEPTEMBER/1..11/:PS,XS,PSA,PSAU,PFS,HRSU,SST;

JANUARY/1..10/:PJ,XJ,PJA,PJAU,PFJ,HRJU,JST;

FEBRUARY/1..10/:PF,XF,PFA,PFAU,PFJ,HRFU,FST;

MARCH/1..12/:PR,XR,PRA,PRAU,PFR,HRRU,RST;

OCTOBER/1..11/:POC,XOC,POCA,POCAU,POC,HRUCU,OCST;

NOVMEBR/1..9/:PN,XN,PNA,PNAU,PFN,HRNU,NST;

DECEMBER/1..9/:PD,XD,PDA,PDAU,PDF,HRDU,DST;

ENDSETS

DATA:

PJ=

0.022,0.07738,0.09353,0.08583,0.08194,0.08268,0.09172,0.09496,0.08128,0.01944;

PF=0.06176,0.09576,0.1049,0.1014,0.0983,0.0955,0.10516,0.1107,0.1079,0.07569;

```

PR=0.07767,0.158,0.18849,0.19,0.19,0.181,0.181,0.181,0.180,0.169,0.144,
0.05739;
PP=
0.002,0.109,0.161,0.192,0.2,0.201,0.202,0.191,0.192,0.19298,0.172,0.155
4,0.088;
PM=0.041,0.12,0.161,0.18,0.188,0.196,0.201,0.2,0.196,0.186,0.176,0.154,
0.0895;
PJN=0.0727,0.146,0.184,0.205,0.212,0.215,0.206,0.213,0.195,0.188,0.162,
0.162,0.1159,0.02229;
PJL=0.0436,0.1194,0.1607,0.1818,0.1959,0.1986,0.1998,0.2044,0.2,0.2019,
0.1893,0.161,0.115,0.0185;
PG=0.012,0.11,0.161,0.183,0.197,0.192,0.196,0.188,0.187,0.18,0.16,0.134
,0.083;
PS=0.105,0.161,0.184,0.193,0.184,0.179,0.166,0.163,0.135,0.115,0.033;
POC=0.0562,0.125,0.148,0.15,0.147,0.133,0.128,0.137,0.136,0.122,0.06;
PN=0.127,0.158,0.156,0.148,0.136,0.129,0.126,0.119,0.107;
PD=0.043,0.082,0.088,0.079,0.068,0.069,0.0757,0.073,0.0518;
! WE REPRESENT SOLAR USED AT THE TIME OF COLLECTION (U);
!WE REPRESENT THE SOLAR STORED BY (ST);
ENDDATA
!APRIL(P);
@FOR(APRIL(i):PPA(i)=AREA*PP(i));
PPT=@SUM(APRIL(i):PPA(i));
@FOR(APRIL(i):(PPAU(i)+PFAP(i))>=50000);
PFAPT=@SUM(APRIL(i):PFAP(i));
@FOR(APRIL(i):HRPU(i)=PPAU(i)+PFAP(i));
@FOR(APRIL(i):PST(i)=PPA(i)-PPAU(i));
@FOR(APRIL(i):PST(i)>=0);
PST_T=@SUM(APRIL(i):PST(i));

```

```

PST_T>=(ST_CAP*N_P);

!MAI (M);

@FOR (MAI (i) :PMA (i) =AREA*PM (i));

PMT=@SUM (MAI (i) :PMA (i));

@FOR (MAI (i) : (PMAU (i) +PFM (i)) >=50000);

PFMT=@SUM (MAI (i) :PFM (i));

@FOR (MAI (i) :HRMU (i) =PMAU (i) +PFM (i));

@FOR (MAI (i) :MST (i) =PMA (i) -PMAU (i));

@FOR (MAI (i) :MST (i) >=0);

PST_T=@SUM (MAI (i) :MST (i));

MST_T>=(ST_CAP*N_P);

!JUNE (JN);

@FOR (JUNE (i) :PJNA (i) =AREA*PJN (i));

PJNT=@SUM (JUNE (i) :PJNA (i));

@FOR (JUNE (i) : (PJNAU (i) +PFJN (i)) >=50000);

PFJNT=@SUM (JUNE (i) :PFJN (i));

@FOR (JUNE (i) :HRJNU (i) =PJNA (i) +PFJN (i));

@FOR (JUNE (i) :JNST (i) =PJNA (i) -PJNAU (i));

@FOR (JUNE (i) :JNST (i) >=0);

JNST_T=@SUM (JUNE (i) :JNST (i));

JNST_T>=(ST_CAP*N_P);

!JULY (JL);

@FOR (JULY (i) :PJLA (i) =AREA*PJL (i));

PJLT=@SUM (JULY (i) :PJLA (i));

@FOR (JULY (i) : (PJLAU (i) +PFJL (i)) >=50000);

PFJLT=@SUM (JULY (i) :PFJL (i));

@FOR (JULY (i) :HRJLU (i) =PJLA (i) +PFJL (i));

@FOR (JULY (i) :JLST (i) =PJLA (i) -PJLAU (i));

@FOR (JULY (i) :JLST (i) >=0);

```

```

JLST_T=@SUM(JULY(i):JLST(i));

JLST_T>=(ST_CAP*N_P);

!AUGUST(G);

@FOR(AUGUST(i):PGA(i)=AREA*PG(i));

PGT=@SUM(AUGUST(i):PGA(i));

@FOR(AUGUST(i):(PGAU(i)+PFG(i))>=50000);

PFGT=@SUM(AUGUST(i):PFG(i));

@FOR(AUGUST(i):HRGU(i)=PGA(i)+PFG(i));

@FOR(AUGUST(i):GST(i)=PGA(i)-PGAU(i));

@FOR(AUGUST(i):GST(i)>=0);

GST_T=@SUM(AUGUST(i):GST(i));

GST_T>=(ST_CAP*N_P);

!SEPTEMBER;

@FOR(SEPTEMBER(i):PsA(i)=AREA*Ps(i));

PsT_T=@SUM(SEPTEMBER(i):PsA(i));

@FOR(SEPTEMBER(i):(PSAU(i)+PFS(i))>=50000);

PFST=@SUM(SEPTEMBER(i):PFs(i));

@FOR(SEPTEMBER(i):HRSU(i)=PSA(i)+PFS(i));

@FOR(SEPTEMBER(i):SST(i)=PSA(i)-PSAU(i));

@FOR(SEPTEMBER(i):SST(i)>=0);

SST_T=@SUM(SEPTEMBER(i):SST(i));

SST_T>=(ST_CAP*N_P);

!!!!!!!!!!!!!!!!!!!!!!!!!!!!!!!!!!!!!!!!!!!!!!;

!THE WINTER WILL RUN USING FUEL & SOLAR TOGETHER TO GET FULL LOAD;

!october;

@FOR(OCTOBER(i):POCA(i)=AREA*POC(i));

@FOR(OCTOBER(i):(POCAU(i)+PFOC(i))=50000);

POCT=@SUM(OCTOBER(i):POCA(i));

PFOCT=@SUM(OCTOBER(i):PFOC(i));

```

```

PTOC=@SUM(OCTOBER(i):(POCA(i)+PFOC(i)));
@FOR(OCTOBER(i):HROCU(i)=POCA(i)+PFOC(i));
@FOR(OCTOBER(i):SST(i)=POCA(i)-POCAU(i));
SST_T=@SUM(OCTOBER(i):OCST(i));
!NOVMEBR;
@FOR(NOVMEBR(i):PNA(i)=AREA*PN(i));
@FOR(NOVMEBR(i):(PNAU(i)+PFN(i))>=50000);
PNT=@SUM(NOVMEBR(i):PNA(i));
PFNT=@SUM(NOVMEBR(i):PFN(i));
PTN=@SUM(NOVMEBR(i):(PNA(i)+PFN(i)));
@FOR(NOVMEBR(i):HRNU(i)=PNA(i)+PFN(i));
@FOR(NOVMEBR(i):NST(i)=PNA(i)-PNAU(i));
NST_T=@SUM(NOVMEBR(i):NST(i));
!DECEMBER;
@FOR(DECEMBER(i):PDA(i)=AREA*PD(i));
@FOR(DECEMBER(i):(PDAU(i)+PFD(i))>=50000);
PDT=@SUM(DECEMBER(i):PDA(i));
PFDT=@SUM(DECEMBER(i):PFD(i));
PTD=@SUM(DECEMBER(i):(PDA(i)+PFD(i)));
@FOR(DECEMBER(i):HRDU(i)=PDA(i)+PFD(i));
@FOR(DECEMBER(i):DST(i)=PDA(i)-PDAU(i));
DST_T=@SUM(DECEMBER(i):DST(i));
!JANUARY;
@FOR(JANUARY(i):PJA(i)=AREA*PJ(i));
@FOR(JANUARY(i):(PJAU(i)+PFJ(i))>=50000);
PJT=@SUM(JANUARY(i):PJA(i));
PFJT=@SUM(JANUARY(i):PFJ(i));
PTJ=@SUM(JANUARY(i):(PJA(i)+PFJ(i)));
@FOR(JANUARY(i):HRJU(i)=PJA(i)+PFJ(i));

```

```

@FOR (JANUARY (i) : JST (i) = PJA (i) - PJAU (i) );
JST_T = @SUM (JANUARY (i) : JST (i) );
!FEBRUARY;
@FOR (FEBRUARY (i) : PFA (i) = AREA * PF (i) );
@FOR (FEBRUARY (i) : (PFAU (i) + PFF (i)) = 50000 );
PFT = @SUM (FEBRUARY (i) : PFA (i) );
PFFT = @SUM (FEBRUARY (i) : PFF (i) );
PTD = @SUM (FEBRUARY (i) : (PFA (i) + PFF (i)) );
@FOR (FEBRUARY (i) : HRFU (i) = PFA (i) + PFF (i) );
@FOR (FEBRUARY (i) : FST (i) = PFA (i) - PFAU (i) );
FST_T = @SUM (FEBRUARY (i) : FST (i) );
!MARCH;
@FOR (MARCH (i) : PRA (i) = AREA * PR (i) );
@FOR (MARCH (i) : (PRAU (i) + PFR (i)) >= 50000 );
PRT = @SUM (MARCH (i) : PRA (i) );
PFRT = @SUM (MARCH (i) : PFR (i) );
PTR = @SUM (MARCH (i) : (PRA (i) + PFR (i)) );
@FOR (MARCH (i) : HRRU (i) = PRA (i) + PFR (i) );
@FOR (MARCH (i) : RST (i) = PRA (i) - PRAU (i) );
RST_T = @SUM (MARCH (i) : RST (i) );
MIN = AREA;
PT_SUMMER = 30 * PPT + 31 * PMT + 30 * PJNT + 31 * PJLT + 31 * PGT;
P_Annual = PT_Summer + PT_WINTER;
PT_WINTER = 31 * PRT + 31 * PJT + 28 * PFT + 31 * POCT + 31 * PDT;
PFUEL = 31 * PFOCT + 30 * PFNT + 31 * PFDT + 31 * PFJT + 28 * PFFT + 31 * PFRT + 30 * PFAPT + 31 * PFMT
+ 30 * PFJNT + 31 * PFJLT + 31 * PFGT + 30 * PFST;
RATIO = PFUEL / P_Annual;
RATIO <= (1/3);
Net_Ele = (1 - 0.084) * (P_annual + PFUEL);

```

```

Full_HRS=Net_Ele /50000;
Fuel_Saver=Net_Ele /301790;
Capital_Cost=302*AREA+592.1*N_P +
Storage_Capacity*(N_P/Effpst)*Cost_unit_storage;
OM_COST=93.32*storage_capacity+3567.6;
Effpst=0.371;
CF=0.027;
!Cost_unit_storage=(65.63-38.79-32.23-30.88-31.18-31), Storage_Capacity=(1-3-6-9-12-
15);
ST_CAP=1;
N_P=50000;
Cost_unit_storage=65.63;
LEC=(Capital_Cost*0.104+OM_COST+CF*PFUEL)/(NET_ELE);
CO2_Reduction=300*Area;

```

- Lingo output

Local optimal solution found.

```

Objective value:                376650.4
Total solver iterations:        1297

```

Variable	Value	Reduced Cost
AREA	376650.4	0.000000
PPT	775289.6	0.000000
PFAPT	484130.7	0.000000
PST_T	609420.3	0.000000

ST_CAP	1.000000	0.000000
N_P	50000.00	0.000000
PMT	786634.3	0.000000
PFMT	472786.0	0.000000
MST_T	50000.00	0.000000
PJNT	865877.8	0.000000
PFJNT	70568.20	0.000000
JNST_T	125176.0	0.000000
PJLT	824826.7	0.000000
PFJLT	88323.16	0.000000
JLST_T	213149.8	0.000000
PGT	746897.7	0.000000
PFGT	72786.67	0.000000
GST_T	139920.7	0.000000
PFST	55084.10	0.000000
SST_T	50000.00	0.000000
POCT	505540.1	0.000000
PFOCT	94459.86	0.000000
PTOC	600000.0	0.000000
PNT	454240.4	0.000000
PFNT	20996.57	0.000000
PTN	475236.9	0.000000
NST_T	0.000000	0.000000
PDT	237101.4	0.000000
PFDT	262898.6	0.000000
PTD	500000.0	0.000000
DST_T	50000.00	0.000000
PJT	275241.0	0.000000
PFJT	224759.0	0.000000

PTJ	500000.0	0.000000
JST_T	0.000000	0.8733105E-01
PFT	360480.8	0.000000
PFFT	139519.2	0.000000
FST_T	0.000000	0.000000
PRT	714712.9	0.000000
PFRT	49129.60	0.000000
PTR	763842.5	0.000000
RST_T	0.000000	0.000000
PT_SUMMER	0.1223441E+09	0.000000
P_ANNUAL	0.1861481E+09	0.000000
PT_WINTER	0.6380392E+08	0.000000
PFUEL	0.6204935E+08	0.000000
RATIO	0.3333333	0.000000
NET_ELE	0.2273488E+09	0.000000
FULL_HRS	4546.977	0.000000
FUEL_SAVER	753.3346	0.000000
CAPITAL_COST	0.1433534E+09	0.000000
STORAGE_CAPACITY	0.000000	0.000000
EFFPST	0.3710000	0.000000
COST_UNIT_STORAGE	65.63000	0.000000
OM_COST	3567.600	0.000000
CF	0.2700000E-01	0.000000
LEC	0.7296110E-01	0.000000
CO2_REDUCTION	0.1129951E+09	0.000000
PP (1)	0.2000000E-02	0.000000
PP (2)	0.1090000	0.000000
PP (3)	0.1610000	0.000000
PP (4)	0.1920000	0.000000

PP (5)	0.2000000	0.000000
PP (6)	0.2010000	0.000000
PP (7)	0.2020000	0.000000
PP (8)	0.1910000	0.000000
PP (9)	0.1920000	0.000000
PP (10)	0.1929800	0.000000
PP (11)	0.1720000	0.000000
PP (12)	0.1554000	0.000000
PP (13)	0.8800000E-01	0.000000
XP (1)	0.000000	0.000000
XP (2)	0.000000	0.000000
XP (3)	0.000000	0.000000
XP (4)	0.000000	0.000000
XP (5)	0.000000	0.000000
XP (6)	0.000000	0.000000
XP (7)	0.000000	0.000000
XP (8)	0.000000	0.000000
XP (9)	0.000000	0.000000
XP (10)	0.000000	0.000000
XP (11)	0.000000	0.000000
XP (12)	0.000000	0.000000
XP (13)	0.000000	0.000000
PPA (1)	753.3008	0.000000
PPA (2)	41054.89	0.000000
PPA (3)	60640.71	0.000000
PPA (4)	72316.87	0.000000
PPA (5)	75330.08	0.000000
PPA (6)	75706.73	0.000000
PPA (7)	76083.38	0.000000

PPA (8)	71940.22	0.000000
PPA (9)	72316.87	0.000000
PPA (10)	72685.99	0.000000
PPA (11)	64783.86	0.000000
PPA (12)	58531.47	0.000000
PPA (13)	33145.23	0.000000
PPAU (1)	753.3008	0.000000
PPAU (2)	2362.071	0.000000
PPAU (3)	2362.071	0.000000
PPAU (4)	2362.071	0.000000
PPAU (5)	0.000000	0.000000
PPAU (6)	6925.769	0.000000
PPAU (7)	0.000000	0.000000
PPAU (8)	1104.011	0.000000
PPAU (9)	50000.00	0.000000
PPAU (10)	50000.00	0.000000
PPAU (11)	50000.00	0.000000
PPAU (12)	0.000000	0.000000
PPAU (13)	0.000000	0.000000
PFAP (1)	49246.70	0.000000
PFAP (2)	47637.93	0.000000
PFAP (3)	47637.93	0.000000
PFAP (4)	47637.93	0.000000
PFAP (5)	50000.00	0.000000
PFAP (6)	43074.23	0.000000
PFAP (7)	50000.00	0.000000
PFAP (8)	48895.99	0.000000
PFAP (9)	0.000000	0.000000
PFAP (10)	0.000000	0.000000

PFAP (11)	0.000000	0.000000
PFAP (12)	50000.00	0.000000
PFAP (13)	50000.00	0.000000
HRPU (1)	50000.00	0.000000
HRPU (2)	50000.00	0.000000
HRPU (3)	50000.00	0.000000
HRPU (4)	50000.00	0.000000
HRPU (5)	50000.00	0.000000
HRPU (6)	50000.00	0.000000
HRPU (7)	50000.00	0.000000
HRPU (8)	50000.00	0.000000
HRPU (9)	50000.00	0.000000
HRPU (10)	50000.00	0.000000
HRPU (11)	50000.00	0.000000
HRPU (12)	50000.00	0.000000
HRPU (13)	50000.00	0.000000
PST (1)	0.000000	0.000000
PST (2)	38692.82	0.000000
PST (3)	58278.64	0.000000
PST (4)	69954.80	0.000000
PST (5)	75330.08	0.000000
PST (6)	68780.96	0.000000
PST (7)	76083.38	0.000000
PST (8)	70836.21	0.000000
PST (9)	22316.87	0.000000
PST (10)	22685.99	0.000000
PST (11)	14783.86	0.000000
PST (12)	58531.47	0.000000
PST (13)	33145.23	0.000000

PM(1)	0.4100000E-01	0.000000
PM(2)	0.1200000	0.000000
PM(3)	0.1610000	0.000000
PM(4)	0.1800000	0.000000
PM(5)	0.1880000	0.000000
PM(6)	0.1960000	0.000000
PM(7)	0.2010000	0.000000
PM(8)	0.2000000	0.000000
PM(9)	0.1960000	0.000000
PM(10)	0.1860000	0.000000
PM(11)	0.1760000	0.000000
PM(12)	0.1540000	0.000000
PM(13)	0.8950000E-01	0.000000
XM(1)	0.000000	0.000000
XM(2)	0.000000	0.000000
XM(3)	0.000000	0.000000
XM(4)	0.000000	0.000000
XM(5)	0.000000	0.000000
XM(6)	0.000000	0.000000
XM(7)	0.000000	0.000000
XM(8)	0.000000	0.000000
XM(9)	0.000000	0.000000
XM(10)	0.000000	0.000000
XM(11)	0.000000	0.000000
XM(12)	0.000000	0.000000
XM(13)	0.000000	0.000000
PMA(1)	15442.67	0.000000
PMA(2)	45198.05	0.000000
PMA(3)	60640.71	0.000000

PMA (4)	67797.07	0.000000
PMA (5)	70810.27	0.000000
PMA (6)	73823.47	0.000000
PMA (7)	75706.73	0.000000
PMA (8)	75330.08	0.000000
PMA (9)	73823.47	0.000000
PMA (10)	70056.97	0.000000
PMA (11)	66290.47	0.000000
PMA (12)	58004.16	0.000000
PMA (13)	33710.21	0.000000
PMAU (1)	15442.67	0.000000
PMAU (2)	0.000000	0.000000
PMAU (3)	0.000000	0.000000
PMAU (4)	0.000000	0.000000
PMAU (5)	2461.058	0.000000
PMAU (6)	50000.00	0.000000
PMAU (7)	2461.058	0.000000
PMAU (8)	1927.106	0.000000
PMAU (9)	50000.00	0.000000
PMAU (10)	2461.058	0.000000
PMAU (11)	2461.058	0.000000
PMAU (12)	50000.00	0.000000
PMAU (13)	0.000000	0.000000
PFM (1)	34557.33	0.000000
PFM (2)	50000.00	0.000000
PFM (3)	50000.00	0.000000
PFM (4)	50000.00	0.000000
PFM (5)	47538.94	0.000000
PFM (6)	0.000000	0.000000

PFM(7)	47538.94	0.000000
PFM(8)	48072.89	0.000000
PFM(9)	0.000000	0.000000
PFM(10)	47538.94	0.000000
PFM(11)	47538.94	0.000000
PFM(12)	0.000000	0.000000
PFM(13)	50000.00	0.000000
HRMU(1)	50000.00	0.000000
HRMU(2)	50000.00	0.000000
HRMU(3)	50000.00	0.000000
HRMU(4)	50000.00	0.000000
HRMU(5)	50000.00	0.000000
HRMU(6)	50000.00	0.000000
HRMU(7)	50000.00	0.000000
HRMU(8)	50000.00	0.000000
HRMU(9)	50000.00	0.000000
HRMU(10)	50000.00	0.000000
HRMU(11)	50000.00	0.000000
HRMU(12)	50000.00	0.000000
HRMU(13)	50000.00	0.000000
MST(1)	0.000000	0.000000
MST(2)	45198.05	0.000000
MST(3)	60640.71	0.000000
MST(4)	67797.07	0.000000
MST(5)	68349.21	0.000000
MST(6)	23823.47	0.000000
MST(7)	73245.67	0.000000
MST(8)	73402.97	0.000000
MST(9)	23823.47	0.000000

MST (10)	67595.91	0.000000
MST (11)	63829.41	0.000000
MST (12)	8004.158	0.000000
MST (13)	33710.21	0.000000
PJN (1)	0.7270000E-01	0.000000
PJN (2)	0.1460000	0.000000
PJN (3)	0.1840000	0.000000
PJN (4)	0.2050000	0.000000
PJN (5)	0.2120000	0.000000
PJN (6)	0.2150000	0.000000
PJN (7)	0.2060000	0.000000
PJN (8)	0.2130000	0.000000
PJN (9)	0.1950000	0.000000
PJN (10)	0.1880000	0.000000
PJN (11)	0.1620000	0.000000
PJN (12)	0.1620000	0.000000
PJN (13)	0.1159000	0.000000
PJN (14)	0.2229000E-01	0.000000
XJN (1)	0.000000	0.000000
XJN (2)	0.000000	0.000000
XJN (3)	0.000000	0.000000
XJN (4)	0.000000	0.000000
XJN (5)	0.000000	0.000000
XJN (6)	0.000000	0.000000
XJN (7)	0.000000	0.000000
XJN (8)	0.000000	0.000000
XJN (9)	0.000000	0.000000
XJN (10)	0.000000	0.000000
XJN (11)	0.000000	0.000000

XJN (12)	0.000000	0.000000
XJN (13)	0.000000	0.000000
XJN (14)	0.000000	0.000000
PJNA (1)	27382.48	0.000000
PJNA (2)	54990.96	0.000000
PJNA (3)	69303.67	0.000000
PJNA (4)	77213.33	0.000000
PJNA (5)	79849.88	0.000000
PJNA (6)	80979.83	0.000000
PJNA (7)	77589.98	0.000000
PJNA (8)	80226.53	0.000000
PJNA (9)	73446.82	0.000000
PJNA (10)	70810.27	0.000000
PJNA (11)	61017.36	0.000000
PJNA (12)	61017.36	0.000000
PJNA (13)	43653.78	0.000000
PJNA (14)	8395.537	0.000000
PJNAU (1)	27382.48	0.000000
PJNAU (2)	54990.96	0.000000
PJNAU (3)	69303.67	0.000000
PJNAU (4)	77213.33	0.000000
PJNAU (5)	79849.88	0.000000
PJNAU (6)	79912.15	0.000000
PJNAU (7)	50000.00	0.000000
PJNAU (8)	50000.00	0.000000
PJNAU (9)	50000.00	0.000000
PJNAU (10)	50000.00	0.000000
PJNAU (11)	50000.00	0.000000
PJNAU (12)	50000.00	0.000000

PJNAU (13)	43653.78	0.000000
PJNAU (14)	8395.537	0.000000
PFJN (1)	22617.52	0.000000
PFJN (2)	0.000000	0.8451392E-01
PFJN (3)	0.000000	0.8451392E-01
PFJN (4)	0.000000	0.8451392E-01
PFJN (5)	0.000000	0.8451392E-01
PFJN (6)	0.000000	0.8451392E-01
PFJN (7)	0.000000	0.8451392E-01
PFJN (8)	0.000000	0.8451392E-01
PFJN (9)	0.000000	0.8451392E-01
PFJN (10)	0.000000	0.8451392E-01
PFJN (11)	0.000000	0.8451392E-01
PFJN (12)	0.000000	0.8451392E-01
PFJN (13)	6346.221	0.000000
PFJN (14)	41604.46	0.000000
HRJNU (1)	50000.00	0.000000
HRJNU (2)	54990.96	0.000000
HRJNU (3)	69303.67	0.000000
HRJNU (4)	77213.33	0.000000
HRJNU (5)	79849.88	0.000000
HRJNU (6)	80979.83	0.000000
HRJNU (7)	77589.98	0.000000
HRJNU (8)	80226.53	0.000000
HRJNU (9)	73446.82	0.000000
HRJNU (10)	70810.27	0.000000
HRJNU (11)	61017.36	0.000000
HRJNU (12)	61017.36	0.000000
HRJNU (13)	50000.00	0.000000

HRJNU (14)	50000.00	0.000000
JNST (1)	0.000000	0.000000
JNST (2)	0.000000	0.000000
JNST (3)	0.000000	0.000000
JNST (4)	0.000000	0.000000
JNST (5)	0.000000	0.000000
JNST (6)	1067.678	0.000000
JNST (7)	27589.98	0.000000
JNST (8)	30226.53	0.000000
JNST (9)	23446.82	0.000000
JNST (10)	20810.27	0.000000
JNST (11)	11017.36	0.000000
JNST (12)	11017.36	0.000000
JNST (13)	0.000000	0.000000
JNST (14)	0.000000	0.000000
PJL (1)	0.4360000E-01	0.000000
PJL (2)	0.1194000	0.000000
PJL (3)	0.1607000	0.000000
PJL (4)	0.1818000	0.000000
PJL (5)	0.1959000	0.000000
PJL (6)	0.1986000	0.000000
PJL (7)	0.1998000	0.000000
PJL (8)	0.2044000	0.000000
PJL (9)	0.2000000	0.000000
PJL (10)	0.2019000	0.000000
PJL (11)	0.1893000	0.000000
PJL (12)	0.1610000	0.000000
PJL (13)	0.1150000	0.000000
PJL (14)	0.1850000E-01	0.000000

XJL (1)	0.000000	0.000000
XJL (2)	0.000000	0.000000
XJL (3)	0.000000	0.000000
XJL (4)	0.000000	0.000000
XJL (5)	0.000000	0.000000
XJL (6)	0.000000	0.000000
XJL (7)	0.000000	0.000000
XJL (8)	0.000000	0.000000
XJL (9)	0.000000	0.000000
XJL (10)	0.000000	0.000000
XJL (11)	0.000000	0.000000
XJL (12)	0.000000	0.000000
XJL (13)	0.000000	0.000000
XJL (14)	0.000000	0.000000
PJLA (1)	16421.96	0.000000
PJLA (2)	44972.06	0.000000
PJLA (3)	60527.72	0.000000
PJLA (4)	68475.04	0.000000
PJLA (5)	73785.81	0.000000
PJLA (6)	74802.76	0.000000
PJLA (7)	75254.75	0.000000
PJLA (8)	76987.34	0.000000
PJLA (9)	75330.08	0.000000
PJLA (10)	76045.71	0.000000
PJLA (11)	71299.92	0.000000
PJLA (12)	60640.71	0.000000
PJLA (13)	43314.79	0.000000
PJLA (14)	6968.032	0.000000
PJLAU (1)	16421.96	0.000000

PJLAU (2)	44972.06	0.000000
PJLAU (3)	50000.00	0.000000
PJLAU (4)	50000.00	0.000000
PJLAU (5)	50000.00	0.000000
PJLAU (6)	50000.00	0.000000
PJLAU (7)	50000.00	0.000000
PJLAU (8)	50000.00	0.000000
PJLAU (9)	50000.00	0.000000
PJLAU (10)	50000.00	0.000000
PJLAU (11)	50000.00	0.000000
PJLAU (12)	50000.00	0.000000
PJLAU (13)	43314.79	0.000000
PJLAU (14)	6968.032	0.000000
PFJL (1)	33578.04	0.000000
PFJL (2)	5027.945	0.000000
PFJL (3)	0.000000	0.8733105E-01
PFJL (4)	0.000000	0.8733105E-01
PFJL (5)	0.000000	0.8733105E-01
PFJL (6)	0.000000	0.8733105E-01
PFJL (7)	0.000000	0.8733105E-01
PFJL (8)	0.000000	0.8733105E-01
PFJL (9)	0.000000	0.8733105E-01
PFJL (10)	0.000000	0.8733105E-01
PFJL (11)	0.000000	0.8733105E-01
PFJL (12)	0.000000	0.8733105E-01
PFJL (13)	6685.207	0.000000
PFJL (14)	43031.97	0.000000
HRJLU (1)	50000.00	0.000000
HRJLU (2)	50000.00	0.000000

HRJLU (3)	60527.72	0.000000
HRJLU (4)	68475.04	0.000000
HRJLU (5)	73785.81	0.000000
HRJLU (6)	74802.76	0.000000
HRJLU (7)	75254.75	0.000000
HRJLU (8)	76987.34	0.000000
HRJLU (9)	75330.08	0.000000
HRJLU (10)	76045.71	0.000000
HRJLU (11)	71299.92	0.000000
HRJLU (12)	60640.71	0.000000
HRJLU (13)	50000.00	0.000000
HRJLU (14)	50000.00	0.000000
JLST (1)	0.000000	0.000000
JLST (2)	0.000000	0.000000
JLST (3)	10527.72	0.000000
JLST (4)	18475.04	0.000000
JLST (5)	23785.81	0.000000
JLST (6)	24802.76	0.000000
JLST (7)	25254.75	0.000000
JLST (8)	26987.34	0.000000
JLST (9)	25330.08	0.000000
JLST (10)	26045.71	0.000000
JLST (11)	21299.92	0.000000
JLST (12)	10640.71	0.000000
JLST (13)	0.000000	0.000000
JLST (14)	0.000000	0.000000
PG (1)	0.1200000E-01	0.000000
PG (2)	0.1100000	0.000000
PG (3)	0.1610000	0.000000

PG (4)	0.1830000	0.000000
PG (5)	0.1970000	0.000000
PG (6)	0.1920000	0.000000
PG (7)	0.1960000	0.000000
PG (8)	0.1880000	0.000000
PG (9)	0.1870000	0.000000
PG (10)	0.1800000	0.000000
PG (11)	0.1600000	0.000000
PG (12)	0.1340000	0.000000
PG (13)	0.8300000E-01	0.000000
XG (1)	0.000000	0.000000
XG (2)	0.000000	0.000000
XG (3)	0.000000	0.000000
XG (4)	0.000000	0.000000
XG (5)	0.000000	0.000000
XG (6)	0.000000	0.000000
XG (7)	0.000000	0.000000
XG (8)	0.000000	0.000000
XG (9)	0.000000	0.000000
XG (10)	0.000000	0.000000
XG (11)	0.000000	0.000000
XG (12)	0.000000	0.000000
XG (13)	0.000000	0.000000
PGA (1)	4519.805	0.000000
PGA (2)	41431.54	0.000000
PGA (3)	60640.71	0.000000
PGA (4)	68927.02	0.000000
PGA (5)	74200.12	0.000000
PGA (6)	72316.87	0.000000

PGA (7)	73823.47	0.000000
PGA (8)	70810.27	0.000000
PGA (9)	70433.62	0.000000
PGA (10)	67797.07	0.000000
PGA (11)	60264.06	0.000000
PGA (12)	50471.15	0.000000
PGA (13)	31261.98	0.000000
PGAU (1)	4519.805	0.000000
PGAU (2)	41431.54	0.000000
PGAU (3)	60640.71	0.000000
PGAU (4)	68651.78	0.000000
PGAU (5)	50000.00	0.000000
PGAU (6)	50000.00	0.000000
PGAU (7)	50000.00	0.000000
PGAU (8)	50000.00	0.000000
PGAU (9)	50000.00	0.000000
PGAU (10)	50000.00	0.000000
PGAU (11)	50000.00	0.000000
PGAU (12)	50471.15	0.000000
PGAU (13)	31261.98	0.000000
PFG (1)	45480.20	0.000000
PFG (2)	8568.459	0.000000
PFG (3)	0.000000	0.8733105E-01
PFG (4)	0.000000	0.8733105E-01
PFG (5)	0.000000	0.8733105E-01
PFG (6)	0.000000	0.8733105E-01
PFG (7)	0.000000	0.8733105E-01
PFG (8)	0.000000	0.8733105E-01
PFG (9)	0.000000	0.8733105E-01

PFG (10)	0.000000	0.8733105E-01
PFG (11)	0.000000	0.8733105E-01
PFG (12)	0.000000	0.8733105E-01
PFG (13)	18738.02	0.000000
HRGU (1)	50000.00	0.000000
HRGU (2)	50000.00	0.000000
HRGU (3)	60640.71	0.000000
HRGU (4)	68927.02	0.000000
HRGU (5)	74200.12	0.000000
HRGU (6)	72316.87	0.000000
HRGU (7)	73823.47	0.000000
HRGU (8)	70810.27	0.000000
HRGU (9)	70433.62	0.000000
HRGU (10)	67797.07	0.000000
HRGU (11)	60264.06	0.000000
HRGU (12)	50471.15	0.000000
HRGU (13)	50000.00	0.000000
GST (1)	0.000000	0.000000
GST (2)	0.000000	0.000000
GST (3)	0.000000	0.000000
GST (4)	275.2377	0.000000
GST (5)	24200.12	0.000000
GST (6)	22316.87	0.000000
GST (7)	23823.47	0.000000
GST (8)	20810.27	0.000000
GST (9)	20433.62	0.000000
GST (10)	17797.07	0.000000
GST (11)	10264.06	0.000000
GST (12)	0.000000	0.000000

GST (13)	0.000000	0.000000
PS (1)	0.1050000	0.000000
PS (2)	0.1610000	0.000000
PS (3)	0.1840000	0.000000
PS (4)	0.1930000	0.000000
PS (5)	0.1840000	0.000000
PS (6)	0.1790000	0.000000
PS (7)	0.1660000	0.000000
PS (8)	0.1630000	0.000000
PS (9)	0.1350000	0.000000
PS (10)	0.1150000	0.000000
PS (11)	0.3300000E-01	0.000000
XS (1)	0.000000	0.000000
XS (2)	0.000000	0.000000
XS (3)	0.000000	0.000000
XS (4)	0.000000	0.000000
XS (5)	0.000000	0.000000
XS (6)	0.000000	0.000000
XS (7)	0.000000	0.000000
XS (8)	0.000000	0.000000
XS (9)	0.000000	0.000000
XS (10)	0.000000	0.000000
XS (11)	0.000000	0.000000
PSA (1)	39548.29	0.000000
PSA (2)	60640.71	0.000000
PSA (3)	69303.67	0.000000
PSA (4)	72693.52	0.000000
PSA (5)	69303.67	0.000000
PSA (6)	67420.42	0.000000

PSA (7)	62523.96	0.000000
PSA (8)	61394.01	0.000000
PSA (9)	50847.80	0.000000
PSA (10)	43314.79	0.000000
PSA (11)	12429.46	0.000000
PSAU (1)	39548.29	0.000000
PSAU (2)	50000.00	0.000000
PSAU (3)	58155.61	0.000000
PSAU (4)	65970.45	0.000000
PSAU (5)	63710.55	0.000000
PSAU (6)	67100.41	0.000000
PSAU (7)	50000.00	0.000000
PSAU (8)	59567.40	0.000000
PSAU (9)	49623.35	0.000000
PSAU (10)	43314.79	0.000000
PSAU (11)	12429.46	0.000000
PFS (1)	10451.71	0.000000
PFS (2)	0.000000	0.8451392E-01
PFS (3)	0.000000	0.8451392E-01
PFS (4)	0.000000	0.8451392E-01
PFS (5)	0.000000	0.8451392E-01
PFS (6)	0.000000	0.8451392E-01
PFS (7)	0.000000	0.8451392E-01
PFS (8)	0.000000	0.8451392E-01
PFS (9)	376.6504	0.000000
PFS (10)	6685.207	0.000000
PFS (11)	37570.54	0.000000
HRSU (1)	50000.00	0.000000
HRSU (2)	60640.71	0.000000

HRSU (3)	69303.67	0.000000
HRSU (4)	72693.52	0.000000
HRSU (5)	69303.67	0.000000
HRSU (6)	67420.42	0.000000
HRSU (7)	62523.96	0.000000
HRSU (8)	61394.01	0.000000
HRSU (9)	51224.45	0.000000
HRSU (10)	50000.00	0.000000
HRSU (11)	50000.00	0.000000
SST (1)	0.000000	0.8451392E-01
SST (2)	10640.71	0.000000
SST (3)	11148.06	0.000000
SST (4)	6723.069	0.000000
SST (5)	5593.118	0.000000
SST (6)	320.0124	0.000000
SST (7)	12523.96	0.000000
SST (8)	1826.614	0.000000
SST (9)	1224.451	0.000000
SST (10)	0.000000	0.000000
SST (11)	0.000000	0.000000
PJ (1)	0.2200000E-01	0.000000
PJ (2)	0.7738000E-01	0.000000
PJ (3)	0.9353000E-01	0.000000
PJ (4)	0.8583000E-01	0.000000
PJ (5)	0.8194000E-01	0.000000
PJ (6)	0.8268000E-01	0.000000
PJ (7)	0.9172000E-01	0.000000
PJ (8)	0.9496000E-01	0.000000
PJ (9)	0.8128000E-01	0.000000

PJ(10)	0.1944000E-01	0.000000
XJ(1)	0.000000	0.000000
XJ(2)	0.000000	0.000000
XJ(3)	0.000000	0.000000
XJ(4)	0.000000	0.000000
XJ(5)	0.000000	0.000000
XJ(6)	0.000000	0.000000
XJ(7)	0.000000	0.000000
XJ(8)	0.000000	0.000000
XJ(9)	0.000000	0.000000
XJ(10)	0.000000	0.000000
PJA(1)	8286.308	0.000000
PJA(2)	29145.21	0.000000
PJA(3)	35228.11	0.000000
PJA(4)	32327.90	0.000000
PJA(5)	30862.73	0.000000
PJA(6)	31141.45	0.000000
PJA(7)	34546.37	0.000000
PJA(8)	35766.72	0.000000
PJA(9)	30614.14	0.000000
PJA(10)	7322.083	0.000000
PJAU(1)	8286.308	0.000000
PJAU(2)	29145.21	0.000000
PJAU(3)	35228.11	0.000000
PJAU(4)	32327.90	0.000000
PJAU(5)	30862.73	0.000000
PJAU(6)	31141.45	0.000000
PJAU(7)	34546.37	0.000000
PJAU(8)	35766.72	0.000000

PJAU (9)	30614.14	0.000000
PJAU (10)	7322.083	0.000000
PFJ (1)	41713.69	0.000000
PFJ (2)	20854.79	0.000000
PFJ (3)	14771.89	0.000000
PFJ (4)	17672.10	0.000000
PFJ (5)	19137.27	0.000000
PFJ (6)	18858.55	0.000000
PFJ (7)	15453.63	0.000000
PFJ (8)	14233.28	0.000000
PFJ (9)	19385.86	0.000000
PFJ (10)	42677.92	0.000000
HRJU (1)	50000.00	0.000000
HRJU (2)	50000.00	0.000000
HRJU (3)	50000.00	0.000000
HRJU (4)	50000.00	0.000000
HRJU (5)	50000.00	0.000000
HRJU (6)	50000.00	0.000000
HRJU (7)	50000.00	0.000000
HRJU (8)	50000.00	0.000000
HRJU (9)	50000.00	0.000000
HRJU (10)	50000.00	0.000000
JST (1)	0.000000	0.000000
JST (2)	0.000000	0.000000
JST (3)	0.000000	0.000000
JST (4)	0.000000	0.000000
JST (5)	0.000000	0.000000
JST (6)	0.000000	0.000000
JST (7)	0.000000	0.000000

JST (8)	0.000000	0.000000
JST (9)	0.000000	0.000000
JST (10)	0.000000	0.000000
PF (1)	0.6176000E-01	0.000000
PF (2)	0.9576000E-01	0.000000
PF (3)	0.1049000	0.000000
PF (4)	0.1014000	0.000000
PF (5)	0.9830000E-01	0.000000
PF (6)	0.9550000E-01	0.000000
PF (7)	0.1051600	0.000000
PF (8)	0.1107000	0.000000
PF (9)	0.1079000	0.000000
PF (10)	0.7569000E-01	0.000000
XF (1)	0.000000	0.000000
XF (2)	0.000000	0.000000
XF (3)	0.000000	0.000000
XF (4)	0.000000	0.000000
XF (5)	0.000000	0.000000
XF (6)	0.000000	0.000000
XF (7)	0.000000	0.000000
XF (8)	0.000000	0.000000
XF (9)	0.000000	0.000000
XF (10)	0.000000	0.000000
PFA (1)	23261.93	0.000000
PFA (2)	36068.04	0.000000
PFA (3)	39510.62	0.000000
PFA (4)	38192.35	0.000000
PFA (5)	37024.73	0.000000
PFA (6)	35970.11	0.000000

PFA (7)	39608.55	0.000000
PFA (8)	41695.20	0.000000
PFA (9)	40640.58	0.000000
PFA (10)	28508.67	0.000000
PFAU (1)	23261.93	0.000000
PFAU (2)	36068.04	0.000000
PFAU (3)	39510.62	0.000000
PFAU (4)	38192.35	0.000000
PFAU (5)	37024.73	0.000000
PFAU (6)	35970.11	0.000000
PFAU (7)	39608.55	0.000000
PFAU (8)	41695.20	0.000000
PFAU (9)	40640.58	0.000000
PFAU (10)	28508.67	0.000000
PFF (1)	26738.07	0.000000
PFF (2)	13931.96	0.000000
PFF (3)	10489.38	0.000000
PFF (4)	11807.65	0.000000
PFF (5)	12975.27	0.000000
PFF (6)	14029.89	0.000000
PFF (7)	10391.45	0.000000
PFF (8)	8304.803	0.000000
PFF (9)	9359.424	0.000000
PFF (10)	21491.33	0.000000
HRFU (1)	50000.00	0.000000
HRFU (2)	50000.00	0.000000
HRFU (3)	50000.00	0.000000
HRFU (4)	50000.00	0.000000
HRFU (5)	50000.00	0.000000

HRFU (6)	50000.00	0.000000
HRFU (7)	50000.00	0.000000
HRFU (8)	50000.00	0.000000
HRFU (9)	50000.00	0.000000
HRFU (10)	50000.00	0.000000
FST (1)	0.000000	0.1662107
FST (2)	0.000000	0.1662107
FST (3)	0.000000	0.1662107
FST (4)	0.000000	0.1662107
FST (5)	0.000000	0.1662107
FST (6)	0.000000	0.1662107
FST (7)	0.000000	0.1662107
FST (8)	0.000000	0.1662107
FST (9)	0.000000	0.1662107
FST (10)	0.000000	0.1662107
PR (1)	0.7767000E-01	0.000000
PR (2)	0.1580000	0.000000
PR (3)	0.1884900	0.000000
PR (4)	0.1900000	0.000000
PR (5)	0.1900000	0.000000
PR (6)	0.1810000	0.000000
PR (7)	0.1810000	0.000000
PR (8)	0.1810000	0.000000
PR (9)	0.1800000	0.000000
PR (10)	0.1690000	0.000000
PR (11)	0.1440000	0.000000
PR (12)	0.5739000E-01	0.000000
XR (1)	0.000000	0.000000
XR (2)	0.000000	0.000000

XR (3)	0.000000	0.000000
XR (4)	0.000000	0.000000
XR (5)	0.000000	0.000000
XR (6)	0.000000	0.000000
XR (7)	0.000000	0.000000
XR (8)	0.000000	0.000000
XR (9)	0.000000	0.000000
XR (10)	0.000000	0.000000
XR (11)	0.000000	0.000000
XR (12)	0.000000	0.000000
PRA (1)	29254.43	0.000000
PRA (2)	59510.76	0.000000
PRA (3)	70994.83	0.000000
PRA (4)	71563.57	0.000000
PRA (5)	71563.57	0.000000
PRA (6)	68173.72	0.000000
PRA (7)	68173.72	0.000000
PRA (8)	68173.72	0.000000
PRA (9)	67797.07	0.000000
PRA (10)	63653.91	0.000000
PRA (11)	54237.65	0.000000
PRA (12)	21615.97	0.000000
PRAU (1)	29254.43	0.000000
PRAU (2)	59510.76	0.000000
PRAU (3)	70994.83	0.000000
PRAU (4)	71563.57	0.000000
PRAU (5)	71563.57	0.000000
PRAU (6)	68173.72	0.000000
PRAU (7)	68173.72	0.000000

PRAU (8)	68173.72	0.000000
PRAU (9)	67797.07	0.000000
PRAU (10)	63653.91	0.000000
PRAU (11)	54237.65	0.000000
PRAU (12)	21615.97	0.000000
PFR (1)	20745.57	0.000000
PFR (2)	0.000000	0.8733105E-01
PFR (3)	0.000000	0.8733105E-01
PFR (4)	0.000000	0.8733105E-01
PFR (5)	0.000000	0.8733105E-01
PFR (6)	0.000000	0.8733105E-01
PFR (7)	0.000000	0.8733105E-01
PFR (8)	0.000000	0.8733105E-01
PFR (9)	0.000000	0.8733105E-01
PFR (10)	0.000000	0.8733105E-01
PFR (11)	0.000000	0.8733105E-01
PFR (12)	28384.03	0.000000
HRRU (1)	50000.00	0.000000
HRRU (2)	59510.76	0.000000
HRRU (3)	70994.83	0.000000
HRRU (4)	71563.57	0.000000
HRRU (5)	71563.57	0.000000
HRRU (6)	68173.72	0.000000
HRRU (7)	68173.72	0.000000
HRRU (8)	68173.72	0.000000
HRRU (9)	67797.07	0.000000
HRRU (10)	63653.91	0.000000
HRRU (11)	54237.65	0.000000
HRRU (12)	50000.00	0.000000

RST (1)	0.000000	0.8733105E-01
RST (2)	0.000000	0.000000
RST (3)	0.000000	0.000000
RST (4)	0.000000	0.000000
RST (5)	0.000000	0.000000
RST (6)	0.000000	0.000000
RST (7)	0.000000	0.000000
RST (8)	0.000000	0.000000
RST (9)	0.000000	0.000000
RST (10)	0.000000	0.000000
RST (11)	0.000000	0.000000
RST (12)	0.000000	0.8733105E-01
POC (1)	0.5620000E-01	0.000000
POC (2)	0.1250000	0.000000
POC (3)	0.1480000	0.000000
POC (4)	0.1500000	0.000000
POC (5)	0.1470000	0.000000
POC (6)	0.1330000	0.000000
POC (7)	0.1280000	0.000000
POC (8)	0.1370000	0.000000
POC (9)	0.1360000	0.000000
POC (10)	0.1220000	0.000000
POC (11)	0.6000000E-01	0.000000
XOC (1)	0.000000	0.000000
XOC (2)	0.000000	0.000000
XOC (3)	0.000000	0.000000
XOC (4)	0.000000	0.000000
XOC (5)	0.000000	0.000000
XOC (6)	0.000000	0.000000

XOC (7)	0.000000	0.000000
XOC (8)	0.000000	0.000000
XOC (9)	0.000000	0.000000
XOC (10)	0.000000	0.000000
XOC (11)	0.000000	0.000000
POCA (1)	21167.75	0.000000
POCA (2)	47081.30	0.000000
POCA (3)	55744.26	0.000000
POCA (4)	56497.56	0.000000
POCA (5)	55367.61	0.000000
POCA (6)	50094.50	0.000000
POCA (7)	48211.25	0.000000
POCA (8)	51601.10	0.000000
POCA (9)	51224.45	0.000000
POCA (10)	45951.35	0.000000
POCA (11)	22599.02	0.000000
POCAU (1)	21167.75	0.000000
POCAU (2)	36440.59	0.000000
POCAU (3)	44596.19	0.000000
POCAU (4)	49774.49	0.000000
POCAU (5)	49774.49	0.000000
POCAU (6)	49774.49	0.000000
POCAU (7)	35687.29	0.000000
POCAU (8)	49774.49	0.000000
POCAU (9)	50000.00	0.000000
POCAU (10)	45951.35	0.000000
POCAU (11)	22599.02	0.000000
PFOC (1)	28832.25	0.000000
PFOC (2)	13559.41	0.000000

PFOC (3)	5403.807	0.000000
PFOC (4)	225.5123	0.000000
PFOC (5)	225.5123	0.000000
PFOC (6)	225.5123	0.000000
PFOC (7)	14312.71	0.000000
PFOC (8)	225.5123	0.000000
PFOC (9)	0.000000	0.8451392E-01
PFOC (10)	4048.654	0.000000
PFOC (11)	27400.98	0.000000
HROCU (1)	50000.00	0.000000
HROCU (2)	60640.71	0.000000
HROCU (3)	61148.06	0.000000
HROCU (4)	56723.07	0.000000
HROCU (5)	55593.12	0.000000
HROCU (6)	50320.01	0.000000
HROCU (7)	62523.96	0.000000
HROCU (8)	51826.61	0.000000
HROCU (9)	51224.45	0.000000
HROCU (10)	50000.00	0.000000
HROCU (11)	50000.00	0.000000
OCST (1)	50000.00	0.000000
OCST (2)	0.000000	0.000000
OCST (3)	0.000000	0.000000
OCST (4)	0.000000	0.000000
OCST (5)	0.000000	0.000000
OCST (6)	0.000000	0.000000
OCST (7)	0.000000	0.000000
OCST (8)	0.000000	0.000000
OCST (9)	0.000000	0.000000

OCST (10)	0.000000	0.000000
OCST (11)	0.000000	0.000000
PN (1)	0.1270000	0.000000
PN (2)	0.1580000	0.000000
PN (3)	0.1560000	0.000000
PN (4)	0.1480000	0.000000
PN (5)	0.1360000	0.000000
PN (6)	0.1290000	0.000000
PN (7)	0.1260000	0.000000
PN (8)	0.1190000	0.000000
PN (9)	0.1070000	0.000000
XN (1)	0.000000	0.000000
XN (2)	0.000000	0.000000
XN (3)	0.000000	0.000000
XN (4)	0.000000	0.000000
XN (5)	0.000000	0.000000
XN (6)	0.000000	0.000000
XN (7)	0.000000	0.000000
XN (8)	0.000000	0.000000
XN (9)	0.000000	0.000000
PNA (1)	47834.60	0.000000
PNA (2)	59510.76	0.000000
PNA (3)	58757.46	0.000000
PNA (4)	55744.26	0.000000
PNA (5)	51224.45	0.000000
PNA (6)	48587.90	0.000000
PNA (7)	47457.95	0.000000
PNA (8)	44821.39	0.000000
PNA (9)	40301.59	0.000000

PNAU (1)	47834.60	0.000000
PNAU (2)	59510.76	0.000000
PNAU (3)	58757.46	0.000000
PNAU (4)	55744.26	0.000000
PNAU (5)	51224.45	0.000000
PNAU (6)	48587.90	0.000000
PNAU (7)	47457.95	0.000000
PNAU (8)	44821.39	0.000000
PNAU (9)	40301.59	0.000000
PFN (1)	2165.402	0.000000
PFN (2)	0.000000	0.8451392E-01
PFN (3)	0.000000	0.8451392E-01
PFN (4)	0.000000	0.8451392E-01
PFN (5)	0.000000	0.8451392E-01
PFN (6)	1412.101	0.000000
PFN (7)	2542.052	0.000000
PFN (8)	5178.605	0.000000
PFN (9)	9698.410	0.000000
HRNU (1)	50000.00	0.000000
HRNU (2)	59510.76	0.000000
HRNU (3)	58757.46	0.000000
HRNU (4)	55744.26	0.000000
HRNU (5)	51224.45	0.000000
HRNU (6)	50000.00	0.000000
HRNU (7)	50000.00	0.000000
HRNU (8)	50000.00	0.000000
HRNU (9)	50000.00	0.000000
NST (1)	0.000000	0.8451392E-01
NST (2)	0.000000	0.000000

NST (3)	0.000000	0.000000
NST (4)	0.000000	0.000000
NST (5)	0.000000	0.000000
NST (6)	0.000000	0.8451392E-01
NST (7)	0.000000	0.8451392E-01
NST (8)	0.000000	0.8451392E-01
NST (9)	0.000000	0.8451392E-01
PD (1)	0.4300000E-01	0.000000
PD (2)	0.8200000E-01	0.000000
PD (3)	0.8800000E-01	0.000000
PD (4)	0.7900000E-01	0.000000
PD (5)	0.6800000E-01	0.000000
PD (6)	0.6900000E-01	0.000000
PD (7)	0.7570000E-01	0.000000
PD (8)	0.7300000E-01	0.000000
PD (9)	0.5180000E-01	0.000000
XD (1)	0.000000	0.000000
XD (2)	0.000000	0.000000
XD (3)	0.000000	0.000000
XD (4)	0.000000	0.000000
XD (5)	0.000000	0.000000
XD (6)	0.000000	0.000000
XD (7)	0.000000	0.000000
XD (8)	0.000000	0.000000
XD (9)	0.000000	0.000000
PDA (1)	16195.97	0.000000
PDA (2)	30885.33	0.000000
PDA (3)	33145.23	0.000000
PDA (4)	29755.38	0.000000

PDA (5)	25612.23	0.000000
PDA (6)	25988.88	0.000000
PDA (7)	28512.43	0.000000
PDA (8)	27495.48	0.000000
PDA (9)	19510.49	0.000000
PDAU (1)	16195.97	0.000000
PDAU (2)	30885.33	0.000000
PDAU (3)	33145.23	0.000000
PDAU (4)	29755.38	0.000000
PDAU (5)	0.000000	0.000000
PDAU (6)	15596.03	0.000000
PDAU (7)	17014.00	0.000000
PDAU (8)	27495.48	0.000000
PDAU (9)	17014.00	0.000000
PFD (1)	33804.03	0.000000
PFD (2)	19114.67	0.000000
PFD (3)	16854.77	0.000000
PFD (4)	20244.62	0.000000
PFD (5)	50000.00	0.000000
PFD (6)	34403.97	0.000000
PFD (7)	32986.00	0.000000
PFD (8)	22504.52	0.000000
PFD (9)	32986.00	0.000000
HRDU (1)	50000.00	0.000000
HRDU (2)	50000.00	0.000000
HRDU (3)	50000.00	0.000000
HRDU (4)	50000.00	0.000000
HRDU (5)	75612.23	0.000000
HRDU (6)	60392.84	0.000000

HRDU (7)	61498.44	0.000000
HRDU (8)	50000.00	0.000000
HRDU (9)	52496.49	0.000000
DST (1)	0.000000	0.000000
DST (2)	0.000000	0.000000
DST (3)	0.000000	0.000000
DST (4)	0.000000	0.000000
DST (5)	25612.23	0.000000
DST (6)	10392.84	0.000000
DST (7)	11498.44	0.000000
DST (8)	0.000000	0.000000
DST (9)	2496.493	0.000000

8.2. 15HRS/DAY TES

! This program is to find the minimum collectors area that absorb solar energy enough to run the solar power plant at full load ALL THE SUN SHINE TIME;

SETS:

APRIL/1..13/:PP,XP,PPA,PPAU,PFAP,HRPU,PST;

MAI/1..13/:PM,XM,PMA,PMAU,PFM,HRMU,MST;

JUNE/1..14/:PJN,XJN,PJNA,PJNAU,PFJN,HRJNU,JNST;

JULY/1..14/:PJL,XJL,PJLA,PJLAU,PFJL,HRJLU,JLST;

AUGUST/1..13/:PG,XG,PGA,PGAU,PGF,HRGU,GST;

SEPTEMBER/1..11/:PS,XS,PSA,PSAU,PFS,HRSU,SST;

JANUARY/1..10/:PJ,XJ,PJA,PJAU,PFJ,HRJU,JST;

FEBRUARY/1..10/:PF,XF,PFA,PFAU,PFJ,HRFU,FST;

MARCH/1..12/:PR,XR,PRA,PRAU,PFR,HRRU,RST;

OCTOBER/1..11/:POC,XOC,POCA,POCAU,PFOC,HROCU,OCST;
NOVMEBR/1..9/:PN,XN,PNA,PNAU,PFN,HRNU,NST;
DECEMBER/1..9/:PD,XD,PDA,PDAU,PF,HRDU,DST;
ENDSETS
DATA:
PJ=
0.022,0.07738,0.09353,0.08583,0.08194,0.08268,0.09172,0.09496,0.08128,0.
.01944;
PF=0.06176,0.09576,0.1049,0.1014,0.0983,0.0955,0.10516,0.1107,0.1079,0.
07569;
PR=0.07767,0.158,0.18849,0.19,0.19,0.181,0.181,0.181,0.180,0.169,0.144,
0.05739;
PP=
0.002,0.109,0.161,0.192,0.2,0.201,0.202,0.191,0.192,0.19298,0.172,0.155
4,0.088;
PM=0.041,0.12,0.161,0.18,0.188,0.196,0.201,0.2,0.196,0.186,0.176,0.154,
0.0895;
PJN=0.0727,0.146,0.184,0.205,0.212,0.215,0.206,0.213,0.195,0.188,0.162,
0.162,0.1159,0.02229;
PJL=0.0436,0.1194,0.1607,0.1818,0.1959,0.1986,0.1998,0.2044,0.2,0.2019,
0.1893,0.161,0.115,0.0185;
PG=0.012,0.11,0.161,0.183,0.197,0.192,0.196,0.188,0.187,0.18,0.16,0.134
,0.083;
PS=0.105,0.161,0.184,0.193,0.184,0.179,0.166,0.163,0.135,0.115,0.033;
POC=0.0562,0.125,0.148,0.15,0.147,0.133,0.128,0.137,0.136,0.122,0.06;
PN=0.127,0.158,0.156,0.148,0.136,0.129,0.126,0.119,0.107;
PD=0.043,0.082,0.088,0.079,0.068,0.069,0.0757,0.073,0.0518;
! WE REPRESNT SOLAR USED AT THE TIME OF COLLECTON (U);
!WE REPRESENT THE SOLAR STORED BY (ST);

```

ENDDATA

Full_HRS=Net_Ele /50000;!APRIL(P);!APRIL(P);

!APRIL(P);

@FOR(APRIL(i):PPA(i)=AREA*PP(i));

PPT=@SUM(APRIL(i):PPA(i));

@FOR(APRIL(i):(PPAU(i)+PFAP(i))>=50000);

PFAPT=@SUM(APRIL(i):PFAP(i));

@FOR(APRIL(i):HRPU(i)=PPAU(i)+PFAP(i));

@FOR(APRIL(i):PST(i)=PPA(i)-PPAU(i));

@FOR(APRIL(i):PST(i)>=0);

PST_T=@SUM(APRIL(i):PST(i));

PST_T>=(ST_CAP*N_P);

!MAI(M);

@FOR(MAI(i):PMA(i)=AREA*PM(i));

PMT=@SUM(MAI(i):PMA(i));

@FOR(MAI(i):(PMAU(i)+PFM(i))>=50000);

PFMT=@SUM(MAI(i):PFM(i));

@FOR(MAI(i):HRMU(i)=PMAU(i)+PFM(i));

@FOR(MAI(i):MST(i)=PMA(i)-PMAU(i));

@FOR(MAI(i):MST(i)>=0);

PST_T=@SUM(MAI(i):MST(i));

MST_T>=(ST_CAP*N_P);

!JUNE(JN);

@FOR(JUNE(i):PJNA(i)=AREA*PJN(i));

PJNT=@SUM(JUNE(i):PJNA(i));

@FOR(JUNE(i):(PJNAU(i)+PFJN(i))>=50000);

PFJNT=@SUM(JUNE(i):PFJN(i));

@FOR(JUNE(i):HRJNU(i)=PJNA(i)+PFJN(i));

@FOR(JUNE(i):JNST(i)=PJNA(i)-PJNAU(i));

```

```

@FOR (JUNE (i) : JNST (i) >= 0);

JNST_T = @SUM (JUNE (i) : JNST (i));

JNST_T >= (ST_CAP * N_P);

! JULY (JL);

@FOR (JULY (i) : PJLA (i) = AREA * PJL (i));

PJLT = @SUM (JULY (i) : PJLA (i));

@FOR (JULY (i) : (PJLAU (i) + PFJL (i)) >= 50000);

PFJLT = @SUM (JULY (i) : PFJL (i));

@FOR (JULY (i) : HRJLU (i) = PJLA (i) + PFJL (i));

@FOR (JULY (i) : JLST (i) = PJLA (i) - PJLAU (i));

@FOR (JULY (i) : JLST (i) >= 0);

JLST_T = @SUM (JULY (i) : JLST (i));

JLST_T >= (ST_CAP * N_P);

! AUGUST (G);

@FOR (AUGUST (i) : PGA (i) = AREA * PG (i));

PGT = @SUM (AUGUST (i) : PGA (i));

@FOR (AUGUST (i) : (PGAU (i) + PFG (i)) >= 50000);

PFGT = @SUM (AUGUST (i) : PFG (i));

@FOR (AUGUST (i) : HRGU (i) = PGA (i) + PFG (i));

@FOR (AUGUST (i) : GST (i) = PGA (i) - PGAU (i));

@FOR (AUGUST (i) : GST (i) >= 0);

GST_T = @SUM (AUGUST (i) : GST (i));

GST_T >= (ST_CAP * N_P);

! SEPTEMBER;

@FOR (SEPTEMBER (i) : PsA (i) = AREA * Ps (i));

PsT_T = @SUM (SEPTEMBER (i) : PsA (i));

@FOR (SEPTEMBER (i) : (PSAU (i) + PFS (i)) >= 50000);

PFST = @SUM (SEPTEMBER (i) : PFS (i));

@FOR (SEPTEMBER (i) : HRSU (i) = PSA (i) + PFS (i));

```

```

@FOR (SEPTEMBER (i) : SST (i) = PSA (i) - PSAU (i) );
@FOR (SEPTEMBER (i) : SST (i) >= 0 );
SST_T = @SUM (SEPTEMBER (i) : SST (i) );
SST_T >= (ST_CAP * N_P );
!!!!!!!!!!!!!!!!!!!!!!!!!!!!!!!!!!!!!!!!!!!!!!!!!!!!;
!THE WINTER WILL RUN USING FUEL & SOLAR TOGETHER TO GET FULL LOAD;
!october;
@FOR (OCTOBER (i) : POCA (i) = AREA * POC (i) );
@FOR (OCTOBER (i) : (POCAU (i) + PFOC (i)) = 50000 );
POCT = @SUM (OCTOBER (i) : POCA (i) );
PFOCT = @SUM (OCTOBER (i) : PFOC (i) );
PTOC = @SUM (OCTOBER (i) : (POCA (i) + PFOC (i)) );
@FOR (OCTOBER (i) : HROCU (i) = POCA (i) + PFOC (i) );
@FOR (OCTOBER (i) : SST (i) = POCA (i) - POCAU (i) );
SST_T = @SUM (OCTOBER (i) : OCST (i) );
!NOVMEBR;
@FOR (NOVMEBR (i) : PNA (i) = AREA * PN (i) );
@FOR (NOVMEBR (i) : (PNAU (i) + PFN (i)) >= 50000 );
PNT = @SUM (NOVMEBR (i) : PNA (i) );
PFNT = @SUM (NOVMEBR (i) : PFN (i) );
PTN = @SUM (NOVMEBR (i) : (PNA (i) + PFN (i)) );
@FOR (NOVMEBR (i) : HRNU (i) = PNA (i) + PFN (i) );
@FOR (NOVMEBR (i) : NST (i) = PNA (i) - PNAU (i) );
NST_T = @SUM (NOVMEBR (i) : NST (i) );
!DECEMBER;
@FOR (DECEMBER (i) : PDA (i) = AREA * PD (i) );
@FOR (DECEMBER (i) : (PDAU (i) + PFD (i)) >= 50000 );
PDT = @SUM (DECEMBER (i) : PDA (i) );
PFDT = @SUM (DECEMBER (i) : PFD (i) );

```

```

PTD=@SUM(DECEMBER(i):(PDA(i)+PFD(i)));
@FOR(DECEMBER(i):HRDU(i)=PDA(i)+PFD(i));
@FOR(DECEMBER(i):DST(i)=PDA(i)-PDAU(i));
DST_T=@SUM(DECEMBER(i):DST(i));
!JANUARY;
@FOR(JANUARY(i):PJA(i)=AREA*PJ(i));
@FOR(JANUARY(i):(PJAU(i)+PFJ(i))>=50000);
PJT=@SUM(JANUARY(i):PJA(i));
PFJT=@SUM(JANUARY(i):PFJ(i));
PTJ=@SUM(JANUARY(i):(PJA(i)+PFJ(i)));
@FOR(JANUARY(i):HRJU(i)=PJA(i)+PFJ(i));
@FOR(JANUARY(i):JST(i)=PJA(i)-PJAU(i));
JST_T=@SUM(JANUARY(i):JST(i));
!FEBRUARY;
@FOR(FEBRUARY(i):PFA(i)=AREA*PF(i));
@FOR(FEBRUARY(i):(PFAU(i)+PFF(i))=50000);
PFT=@SUM(FEBRUARY(i):PFA(i));
PFFT=@SUM(FEBRUARY(i):PFF(i));
PTD=@SUM(FEBRUARY(i):(PFA(i)+PFF(i)));
@FOR(FEBRUARY(i):HRFU(i)=PFA(i)+PFF(i));
@FOR(FEBRUARY(i):FST(i)=PFA(i)-PFAU(i));
FST_T=@SUM(FEBRUARY(i):FST(i));
!MARCH;
@FOR(MARCH(i):PRA(i)=AREA*PR(i));
@FOR(MARCH(i):(PRAU(i)+PFR(i))>=50000);
PRT=@SUM(MARCH(i):PRA(i));
PFRT=@SUM(MARCH(i):PFR(i));
PTR=@SUM(MARCH(i):(PRA(i)+PFR(i)));
@FOR(MARCH(i):HRRU(i)=PRA(i)+PFR(i));

```



```

@FOR (MARCH (i) : RST (i) = PRA (i) - PRAU (i) );
RST_T=@SUM (MARCH (i) : RST (i) );
MIN=AREA;
PT_SUMMER=30*PPT+31*PMT+30*PJNT+31*PJLT+31*PGT;
P_Annual=PT_Summer+PT_WINTER;
PT_WINTER=31*PRT+31*PJT+28*PFT+31*POCT+31*PDT;
PFUEL=31*PFOCT+30*PFNT+31*PFDT+31*PFJT+28*PFFT+31*PFRT+30*PFAPT+31*PFMT
+30*PFJNT+31*PFJLT+31*PFGT+30*PFST;
RATIO=PFUEL/P_Annual;
RATIO<=(1/3);
Net_Ele =(1-0.084)*(P_annual+PFUEL);
Capital_Cost=302*AREA+592.1*N_P +
Storage_Capacity*(N_P/Effpst)*Cost_unit_storage;
OM_COST=93.32*storage_capacity+3567.6;
Fuel_Saver=Net_Ele /301790;
CO2_Reduction=300*Area;
Fuu_HRS=Net_Ele /50000;
Effpst=0.371;
CF=0.027;
!Cost_unit_storage=(65.63-38.79-32.23-30.88-31.18-31), Storage_Capacity=(1-3-6-9-12-
15);
ST_CAP=15;
N_P=50000;
Cost_unit_storage=31;
LEC=(Capital_Cost*0.104+OM_COST+CF*PFUEL)/(NET_ELE);

```

- Longo output

Local optimal solution found.

Objective value: 573745.4

Total solver iterations: 600

Variable	Value	Reduced Cost
FULL_HRS	6926.336	0.000000
NET_ELE	0.3463168E+09	0.000000
AREA	573745.4	0.000000
PPT	1180986.	0.000000
PFAPT	397334.0	0.000000
PST_T	928320.1	0.000000
ST_CAP	15.00000	0.000000
N_P	50000.00	0.000000
PMT	1198267.	0.000000
PFMT	433881.6	0.000000
MST_T	750000.0	0.000000
PJNT	1318978.	0.000000
PFJNT	313583.8	0.000000
JNST_T	750000.0	0.000000
PJLT	1256445.	0.000000
PFJLT	392008.4	0.000000
JLST_T	948453.4	0.000000
PGT	1137737.	0.000000
PFGT	303326.2	0.000000
GST_T	750000.0	0.000000

PFST	371679.9	0.000000
SST_T	750000.0	0.000000
POCT	770081.1	0.000000
PFOCT	529918.9	0.000000
PTOC	1300000.	0.000000
PNT	691937.0	0.000000
PFNT	0.000000	0.000000
PTN	691937.0	0.000000
NST_T	241937.0	0.000000
PDT	361172.7	0.000000
PFDT	209080.5	0.000000
PTD	570253.2	0.000000
DST_T	489.6434	0.000000
PJT	419270.2	0.000000
PFJT	91499.01	0.000000
PTJ	510769.2	0.000000
JST_T	10769.20	0.000000
PFT	549114.5	0.000000
PFFT	21138.69	0.000000
FST_T	70253.21	0.000000
PRT	1088711.	0.000000
PFRT	22509.94	0.000000
PTR	1111221.	0.000000
RST_T	511220.5	0.000000
PT_SUMMER	0.1863648E+09	0.000000
P_ANNUAL	0.2835563E+09	0.000000
PT_WINTER	0.9719148E+08	0.000000
PFUEL	0.9451877E+08	0.000000
RATIO	0.3333333	0.000000

CAPITAL_COST	0.2028761E+09	0.000000
STORAGE_CAPACITY	0.000000	0.000000
EFFPST	0.3710000	0.000000
COST_UNIT_STORAGE	31.00000	0.000000
OM_COST	3567.600	0.000000
FUEL_SAVER	1147.542	0.000000
CO2_REDUCTION	0.1721236E+09	0.000000
FUU_HRS	6926.336	0.000000
CF	0.2700000E-01	0.000000
LEC	0.6830362E-01	0.000000
PP (1)	0.2000000E-02	0.000000
PP (2)	0.1090000	0.000000
PP (3)	0.1610000	0.000000
PP (4)	0.1920000	0.000000
PP (5)	0.2000000	0.000000
PP (6)	0.2010000	0.000000
PP (7)	0.2020000	0.000000
PP (8)	0.1910000	0.000000
PP (9)	0.1920000	0.000000
PP (10)	0.1929800	0.000000
PP (11)	0.1720000	0.000000
PP (12)	0.1554000	0.000000
PP (13)	0.8800000E-01	0.000000
XP (1)	0.000000	0.000000
XP (2)	0.000000	0.000000
XP (3)	0.000000	0.000000
XP (4)	0.000000	0.000000
XP (5)	0.000000	0.000000
XP (6)	0.000000	0.000000

XP (7)	0.000000	0.000000
XP (8)	0.000000	0.000000
XP (9)	0.000000	0.000000
XP (10)	0.000000	0.000000
XP (11)	0.000000	0.000000
XP (12)	0.000000	0.000000
XP (13)	0.000000	0.000000
PPA (1)	1147.491	0.000000
PPA (2)	62538.25	0.000000
PPA (3)	92373.01	0.000000
PPA (4)	110159.1	0.000000
PPA (5)	114749.1	0.000000
PPA (6)	115322.8	0.000000
PPA (7)	115896.6	0.000000
PPA (8)	109585.4	0.000000
PPA (9)	110159.1	0.000000
PPA (10)	110721.4	0.000000
PPA (11)	98684.21	0.000000
PPA (12)	89160.04	0.000000
PPA (13)	50489.60	0.000000
PPAU (1)	0.000000	0.000000
PPAU (2)	49770.20	0.000000
PPAU (3)	49770.20	0.000000
PPAU (4)	49770.20	0.000000
PPAU (5)	116.2277	0.000000
PPAU (6)	116.2277	0.000000
PPAU (7)	0.000000	0.000000
PPAU (8)	0.000000	0.000000
PPAU (9)	116.2277	0.000000

PPAU (10)	3350.088	0.000000
PPAU (11)	49770.20	0.000000
PPAU (12)	49770.20	0.000000
PPAU (13)	116.2277	0.000000
PFAP (1)	50000.00	0.000000
PFAP (2)	229.7990	0.000000
PFAP (3)	229.7990	0.000000
PFAP (4)	229.7990	0.000000
PFAP (5)	49883.77	0.000000
PFAP (6)	49883.77	0.000000
PFAP (7)	50000.00	0.000000
PFAP (8)	50000.00	0.000000
PFAP (9)	49883.77	0.000000
PFAP (10)	46649.91	0.000000
PFAP (11)	229.7990	0.000000
PFAP (12)	229.7990	0.000000
PFAP (13)	49883.77	0.000000
HRPU (1)	50000.00	0.000000
HRPU (2)	50000.00	0.000000
HRPU (3)	50000.00	0.000000
HRPU (4)	50000.00	0.000000
HRPU (5)	50000.00	0.000000
HRPU (6)	50000.00	0.000000
HRPU (7)	50000.00	0.000000
HRPU (8)	50000.00	0.000000
HRPU (9)	50000.00	0.000000
HRPU (10)	50000.00	0.000000
HRPU (11)	50000.00	0.000000
HRPU (12)	50000.00	0.000000

HRPU (13)	50000.00	0.000000
PST (1)	1147.491	0.000000
PST (2)	12768.05	0.000000
PST (3)	42602.81	0.000000
PST (4)	60388.92	0.000000
PST (5)	114632.9	0.000000
PST (6)	115206.6	0.000000
PST (7)	115896.6	0.000000
PST (8)	109585.4	0.000000
PST (9)	110042.9	0.000000
PST (10)	107371.3	0.000000
PST (11)	48914.01	0.000000
PST (12)	39389.84	0.000000
PST (13)	50373.37	0.000000
PM (1)	0.4100000E-01	0.000000
PM (2)	0.1200000	0.000000
PM (3)	0.1610000	0.000000
PM (4)	0.1800000	0.000000
PM (5)	0.1880000	0.000000
PM (6)	0.1960000	0.000000
PM (7)	0.2010000	0.000000
PM (8)	0.2000000	0.000000
PM (9)	0.1960000	0.000000
PM (10)	0.1860000	0.000000
PM (11)	0.1760000	0.000000
PM (12)	0.1540000	0.000000
PM (13)	0.8950000E-01	0.000000
XM (1)	0.000000	0.000000
XM (2)	0.000000	0.000000

XM(3)	0.000000	0.000000
XM(4)	0.000000	0.000000
XM(5)	0.000000	0.000000
XM(6)	0.000000	0.000000
XM(7)	0.000000	0.000000
XM(8)	0.000000	0.000000
XM(9)	0.000000	0.000000
XM(10)	0.000000	0.000000
XM(11)	0.000000	0.000000
XM(12)	0.000000	0.000000
XM(13)	0.000000	0.000000
PMA(1)	23523.56	0.000000
PMA(2)	68849.45	0.000000
PMA(3)	92373.01	0.000000
PMA(4)	103274.2	0.000000
PMA(5)	107864.1	0.000000
PMA(6)	112454.1	0.000000
PMA(7)	115322.8	0.000000
PMA(8)	114749.1	0.000000
PMA(9)	112454.1	0.000000
PMA(10)	106716.6	0.000000
PMA(11)	100979.2	0.000000
PMA(12)	88356.79	0.000000
PMA(13)	51350.21	0.000000
PMAU(1)	23523.56	0.000000
PMAU(2)	42594.82	0.000000
PMAU(3)	71463.83	0.000000
PMAU(4)	82365.00	0.000000
PMAU(5)	0.000000	0.000000

PMAU (6)	0.000000	0.000000
PMAU (7)	0.000000	0.000000
PMAU (8)	0.000000	0.000000
PMAU (9)	0.000000	0.000000
PMAU (10)	0.000000	0.000000
PMAU (11)	50000.00	0.000000
PMAU (12)	0.000000	0.000000
PMAU (13)	0.000000	0.000000
PFM (1)	26476.44	0.000000
PFM (2)	7405.178	0.000000
PFM (3)	0.000000	0.000000
PFM (4)	0.000000	0.000000
PFM (5)	50000.00	0.000000
PFM (6)	50000.00	0.000000
PFM (7)	50000.00	0.000000
PFM (8)	50000.00	0.000000
PFM (9)	50000.00	0.000000
PFM (10)	50000.00	0.000000
PFM (11)	0.000000	0.000000
PFM (12)	50000.00	0.000000
PFM (13)	50000.00	0.000000
HRMU (1)	50000.00	0.000000
HRMU (2)	50000.00	0.000000
HRMU (3)	71463.83	0.000000
HRMU (4)	82365.00	0.000000
HRMU (5)	50000.00	0.000000
HRMU (6)	50000.00	0.000000
HRMU (7)	50000.00	0.000000
HRMU (8)	50000.00	0.000000

HRMU (9)	50000.00	0.000000
HRMU (10)	50000.00	0.000000
HRMU (11)	50000.00	0.000000
HRMU (12)	50000.00	0.000000
HRMU (13)	50000.00	0.000000
MST (1)	0.000000	0.000000
MST (2)	26254.63	0.000000
MST (3)	20909.18	0.000000
MST (4)	20909.18	0.000000
MST (5)	107864.1	0.000000
MST (6)	112454.1	0.000000
MST (7)	115322.8	0.000000
MST (8)	114749.1	0.000000
MST (9)	112454.1	0.000000
MST (10)	106716.6	0.000000
MST (11)	50979.19	0.000000
MST (12)	88356.79	0.000000
MST (13)	51350.21	0.000000
PJN (1)	0.7270000E-01	0.000000
PJN (2)	0.1460000	0.000000
PJN (3)	0.1840000	0.000000
PJN (4)	0.2050000	0.000000
PJN (5)	0.2120000	0.000000
PJN (6)	0.2150000	0.000000
PJN (7)	0.2060000	0.000000
PJN (8)	0.2130000	0.000000
PJN (9)	0.1950000	0.000000
PJN (10)	0.1880000	0.000000
PJN (11)	0.1620000	0.000000

PJN (12)	0.1620000	0.000000
PJN (13)	0.1159000	0.000000
PJN (14)	0.2229000E-01	0.000000
XJN (1)	0.000000	0.000000
XJN (2)	0.000000	0.000000
XJN (3)	0.000000	0.000000
XJN (4)	0.000000	0.000000
XJN (5)	0.000000	0.000000
XJN (6)	0.000000	0.000000
XJN (7)	0.000000	0.000000
XJN (8)	0.000000	0.000000
XJN (9)	0.000000	0.000000
XJN (10)	0.000000	0.000000
XJN (11)	0.000000	0.000000
XJN (12)	0.000000	0.000000
XJN (13)	0.000000	0.000000
XJN (14)	0.000000	0.000000
PJNA (1)	41711.29	0.000000
PJNA (2)	83766.83	0.000000
PJNA (3)	105569.2	0.000000
PJNA (4)	117617.8	0.000000
PJNA (5)	121634.0	0.000000
PJNA (6)	123355.3	0.000000
PJNA (7)	118191.6	0.000000
PJNA (8)	122207.8	0.000000
PJNA (9)	111880.4	0.000000
PJNA (10)	107864.1	0.000000
PJNA (11)	92946.76	0.000000
PJNA (12)	92946.76	0.000000

PJNA (13)	66497.09	0.000000
PJNA (14)	12788.79	0.000000
PJNAU (1)	41711.29	0.000000
PJNAU (2)	50000.00	0.000000
PJNAU (3)	100908.9	0.000000
PJNAU (4)	112957.5	0.000000
PJNAU (5)	50000.00	0.000000
PJNAU (6)	118695.0	0.000000
PJNAU (7)	3776.386	0.000000
PJNAU (8)	13023.30	0.000000
PJNAU (9)	13023.30	0.000000
PJNAU (10)	13023.30	0.000000
PJNAU (11)	13023.30	0.000000
PJNAU (12)	13023.30	0.000000
PJNAU (13)	13023.30	0.000000
PJNAU (14)	12788.79	0.000000
PFJN (1)	8288.709	0.000000
PFJN (2)	0.000000	0.000000
PFJN (3)	0.000000	0.000000
PFJN (4)	0.000000	0.000000
PFJN (5)	0.000000	0.000000
PFJN (6)	0.000000	0.000000
PFJN (7)	46223.61	0.000000
PFJN (8)	36976.70	0.000000
PFJN (9)	36976.70	0.000000
PFJN (10)	36976.70	0.000000
PFJN (11)	36976.70	0.000000
PFJN (12)	36976.70	0.000000
PFJN (13)	36976.70	0.000000

PFJN (14)	37211.21	0.000000
HRJNU (1)	50000.00	0.000000
HRJNU (2)	83766.83	0.000000
HRJNU (3)	105569.2	0.000000
HRJNU (4)	117617.8	0.000000
HRJNU (5)	121634.0	0.000000
HRJNU (6)	123355.3	0.000000
HRJNU (7)	164415.2	0.000000
HRJNU (8)	159184.5	0.000000
HRJNU (9)	148857.1	0.000000
HRJNU (10)	144840.8	0.000000
HRJNU (11)	129923.5	0.000000
HRJNU (12)	129923.5	0.000000
HRJNU (13)	103473.8	0.000000
HRJNU (14)	50000.00	0.000000
JNST (1)	0.000000	0.000000
JNST (2)	33766.83	0.000000
JNST (3)	4660.297	0.000000
JNST (4)	4660.297	0.000000
JNST (5)	71634.03	0.000000
JNST (6)	4660.297	0.000000
JNST (7)	114415.2	0.000000
JNST (8)	109184.5	0.000000
JNST (9)	98857.06	0.000000
JNST (10)	94840.84	0.000000
JNST (11)	79923.46	0.000000
JNST (12)	79923.46	0.000000
JNST (13)	53473.80	0.000000
JNST (14)	0.000000	0.000000

PJL(1)	0.4360000E-01	0.000000
PJL(2)	0.1194000	0.000000
PJL(3)	0.1607000	0.000000
PJL(4)	0.1818000	0.000000
PJL(5)	0.1959000	0.000000
PJL(6)	0.1986000	0.000000
PJL(7)	0.1998000	0.000000
PJL(8)	0.2044000	0.000000
PJL(9)	0.2000000	0.000000
PJL(10)	0.2019000	0.000000
PJL(11)	0.1893000	0.000000
PJL(12)	0.1610000	0.000000
PJL(13)	0.1150000	0.000000
PJL(14)	0.1850000E-01	0.000000
XJL(1)	0.000000	0.000000
XJL(2)	0.000000	0.000000
XJL(3)	0.000000	0.000000
XJL(4)	0.000000	0.000000
XJL(5)	0.000000	0.000000
XJL(6)	0.000000	0.000000
XJL(7)	0.000000	0.000000
XJL(8)	0.000000	0.000000
XJL(9)	0.000000	0.000000
XJL(10)	0.000000	0.000000
XJL(11)	0.000000	0.000000
XJL(12)	0.000000	0.000000
XJL(13)	0.000000	0.000000
XJL(14)	0.000000	0.000000
PJLA(1)	25015.30	0.000000

PJLA (2)	68505.20	0.000000
PJLA (3)	92200.89	0.000000
PJLA (4)	104306.9	0.000000
PJLA (5)	112396.7	0.000000
PJLA (6)	113945.8	0.000000
PJLA (7)	114634.3	0.000000
PJLA (8)	117273.6	0.000000
PJLA (9)	114749.1	0.000000
PJLA (10)	115839.2	0.000000
PJLA (11)	108610.0	0.000000
PJLA (12)	92373.01	0.000000
PJLA (13)	65980.72	0.000000
PJLA (14)	10614.29	0.000000
PJLAU (1)	25015.30	0.000000
PJLAU (2)	28059.82	0.000000
PJLAU (3)	28059.82	0.000000
PJLAU (4)	28059.82	0.000000
PJLAU (5)	20909.18	0.000000
PJLAU (6)	20909.18	0.000000
PJLAU (7)	20909.18	0.000000
PJLAU (8)	20909.18	0.000000
PJLAU (9)	20909.18	0.000000
PJLAU (10)	20909.18	0.000000
PJLAU (11)	20909.18	0.000000
PJLAU (12)	20909.18	0.000000
PJLAU (13)	20909.18	0.000000
PJLAU (14)	10614.29	0.000000
PFJL (1)	24984.70	0.000000
PFJL (2)	21940.18	0.000000

PFJL (3)	21940.18	0.000000
PFJL (4)	21940.18	0.000000
PFJL (5)	29090.82	0.000000
PFJL (6)	29090.82	0.000000
PFJL (7)	29090.82	0.000000
PFJL (8)	29090.82	0.000000
PFJL (9)	29090.82	0.000000
PFJL (10)	29090.82	0.000000
PFJL (11)	29090.82	0.000000
PFJL (12)	29090.82	0.000000
PFJL (13)	29090.82	0.000000
PFJL (14)	39385.71	0.000000
HRJLU (1)	50000.00	0.000000
HRJLU (2)	90445.38	0.000000
HRJLU (3)	114141.1	0.000000
HRJLU (4)	126247.1	0.000000
HRJLU (5)	141487.5	0.000000
HRJLU (6)	143036.7	0.000000
HRJLU (7)	143725.2	0.000000
HRJLU (8)	146364.4	0.000000
HRJLU (9)	143839.9	0.000000
HRJLU (10)	144930.0	0.000000
HRJLU (11)	137700.8	0.000000
HRJLU (12)	121463.8	0.000000
HRJLU (13)	95071.55	0.000000
HRJLU (14)	50000.00	0.000000
JLST (1)	0.000000	0.000000
JLST (2)	40445.38	0.000000
JLST (3)	64141.07	0.000000

JLST (4)	76247.10	0.000000
JLST (5)	91487.55	0.000000
JLST (6)	93036.66	0.000000
JLST (7)	93725.16	0.000000
JLST (8)	96364.39	0.000000
JLST (9)	93839.91	0.000000
JLST (10)	94930.02	0.000000
JLST (11)	87700.83	0.000000
JLST (12)	71463.83	0.000000
JLST (13)	45071.55	0.000000
JLST (14)	0.000000	0.000000
PG (1)	0.1200000E-01	0.000000
PG (2)	0.1100000	0.000000
PG (3)	0.1610000	0.000000
PG (4)	0.1830000	0.000000
PG (5)	0.1970000	0.000000
PG (6)	0.1920000	0.000000
PG (7)	0.1960000	0.000000
PG (8)	0.1880000	0.000000
PG (9)	0.1870000	0.000000
PG (10)	0.1800000	0.000000
PG (11)	0.1600000	0.000000
PG (12)	0.1340000	0.000000
PG (13)	0.8300000E-01	0.000000
XG (1)	0.000000	0.000000
XG (2)	0.000000	0.000000
XG (3)	0.000000	0.000000
XG (4)	0.000000	0.000000
XG (5)	0.000000	0.000000

XG (6)	0.000000	0.000000
XG (7)	0.000000	0.000000
XG (8)	0.000000	0.000000
XG (9)	0.000000	0.000000
XG (10)	0.000000	0.000000
XG (11)	0.000000	0.000000
XG (12)	0.000000	0.000000
XG (13)	0.000000	0.000000
PGA (1)	6884.945	0.000000
PGA (2)	63112.00	0.000000
PGA (3)	92373.01	0.000000
PGA (4)	104995.4	0.000000
PGA (5)	113027.8	0.000000
PGA (6)	110159.1	0.000000
PGA (7)	112454.1	0.000000
PGA (8)	107864.1	0.000000
PGA (9)	107290.4	0.000000
PGA (10)	103274.2	0.000000
PGA (11)	91799.27	0.000000
PGA (12)	76881.88	0.000000
PGA (13)	47620.87	0.000000
PGAU (1)	6589.332	0.000000
PGAU (2)	50000.00	0.000000
PGAU (3)	49704.39	0.000000
PGAU (4)	91063.39	0.000000
PGAU (5)	49704.39	0.000000
PGAU (6)	49704.39	0.000000
PGAU (7)	49704.39	0.000000
PGAU (8)	0.000000	0.000000

PGAU (9)	0.000000	0.000000
PGAU (10)	0.000000	0.000000
PGAU (11)	13011.43	0.000000
PGAU (12)	14127.73	0.000000
PGAU (13)	14127.73	0.000000
PFG (1)	43410.67	0.000000
PFG (2)	0.000000	0.000000
PFG (3)	295.6134	0.000000
PFG (4)	0.000000	0.000000
PFG (5)	295.6134	0.000000
PFG (6)	295.6134	0.000000
PFG (7)	295.6134	0.000000
PFG (8)	50000.00	0.000000
PFG (9)	50000.00	0.000000
PFG (10)	50000.00	0.000000
PFG (11)	36988.57	0.000000
PFG (12)	35872.27	0.000000
PFG (13)	35872.27	0.000000
HRGU (1)	50295.61	0.000000
HRGU (2)	63112.00	0.000000
HRGU (3)	92668.62	0.000000
HRGU (4)	104995.4	0.000000
HRGU (5)	113323.5	0.000000
HRGU (6)	110454.7	0.000000
HRGU (7)	112749.7	0.000000
HRGU (8)	157864.1	0.000000
HRGU (9)	157290.4	0.000000
HRGU (10)	153274.2	0.000000
HRGU (11)	128787.8	0.000000

HRGU (12)	112754.2	0.000000
HRGU (13)	83493.14	0.000000
GST (1)	295.6134	0.000000
GST (2)	13112.00	0.000000
GST (3)	42668.62	0.000000
GST (4)	13932.02	0.000000
GST (5)	63323.46	0.000000
GST (6)	60454.73	0.000000
GST (7)	62749.71	0.000000
GST (8)	107864.1	0.000000
GST (9)	107290.4	0.000000
GST (10)	103274.2	0.000000
GST (11)	78787.84	0.000000
GST (12)	62754.16	0.000000
GST (13)	33493.14	0.000000
PS (1)	0.1050000	0.000000
PS (2)	0.1610000	0.000000
PS (3)	0.1840000	0.000000
PS (4)	0.1930000	0.000000
PS (5)	0.1840000	0.000000
PS (6)	0.1790000	0.000000
PS (7)	0.1660000	0.000000
PS (8)	0.1630000	0.000000
PS (9)	0.1350000	0.000000
PS (10)	0.1150000	0.000000
PS (11)	0.3300000E-01	0.000000
XS (1)	0.000000	0.000000
XS (2)	0.000000	0.000000
XS (3)	0.000000	0.000000

XS (4)	0.000000	0.000000
XS (5)	0.000000	0.000000
XS (6)	0.000000	0.000000
XS (7)	0.000000	0.000000
XS (8)	0.000000	0.000000
XS (9)	0.000000	0.000000
XS (10)	0.000000	0.000000
XS (11)	0.000000	0.000000
PSA (1)	60243.27	0.000000
PSA (2)	92373.01	0.000000
PSA (3)	105569.2	0.000000
PSA (4)	110732.9	0.000000
PSA (5)	105569.2	0.000000
PSA (6)	102700.4	0.000000
PSA (7)	95241.74	0.000000
PSA (8)	93520.50	0.000000
PSA (9)	77455.63	0.000000
PSA (10)	65980.72	0.000000
PSA (11)	18933.60	0.000000
PSAU (1)	27998.78	0.000000
PSAU (2)	20654.83	0.000000
PSAU (3)	20654.83	0.000000
PSAU (4)	24671.05	0.000000
PSAU (5)	21228.58	0.000000
PSAU (6)	26392.29	0.000000
PSAU (7)	21802.33	0.000000
PSAU (8)	14917.38	0.000000
PSAU (9)	0.000000	0.7649939
PSAU (10)	0.000000	0.7649939

PSAU (11)	0.000000	0.7649939
PFS (1)	22001.22	0.000000
PFS (2)	29345.17	0.000000
PFS (3)	29345.17	0.000000
PFS (4)	25328.95	0.000000
PFS (5)	28771.42	0.000000
PFS (6)	23607.71	0.000000
PFS (7)	28197.67	0.000000
PFS (8)	35082.62	0.000000
PFS (9)	50000.00	0.000000
PFS (10)	50000.00	0.000000
PFS (11)	50000.00	0.000000
HRSU (1)	82244.49	0.000000
HRSU (2)	121718.2	0.000000
HRSU (3)	134914.3	0.000000
HRSU (4)	136061.8	0.000000
HRSU (5)	134340.6	0.000000
HRSU (6)	126308.1	0.000000
HRSU (7)	123439.4	0.000000
HRSU (8)	128603.1	0.000000
HRSU (9)	127455.6	0.000000
HRSU (10)	115980.7	0.000000
HRSU (11)	68933.60	0.000000
SST (1)	32244.49	0.000000
SST (2)	71718.18	0.000000
SST (3)	84914.32	0.000000
SST (4)	86061.81	0.000000
SST (5)	84340.58	0.000000
SST (6)	76308.14	0.000000

SST(7)	73439.41	0.000000
SST(8)	78603.12	0.000000
SST(9)	77455.63	0.000000
SST(10)	65980.72	0.000000
SST(11)	18933.60	0.000000
PJ(1)	0.2200000E-01	0.000000
PJ(2)	0.7738000E-01	0.000000
PJ(3)	0.9353000E-01	0.000000
PJ(4)	0.8583000E-01	0.000000
PJ(5)	0.8194000E-01	0.000000
PJ(6)	0.8268000E-01	0.000000
PJ(7)	0.9172000E-01	0.000000
PJ(8)	0.9496000E-01	0.000000
PJ(9)	0.8128000E-01	0.000000
PJ(10)	0.1944000E-01	0.000000
XJ(1)	0.000000	0.000000
XJ(2)	0.000000	0.000000
XJ(3)	0.000000	0.000000
XJ(4)	0.000000	0.000000
XJ(5)	0.000000	0.000000
XJ(6)	0.000000	0.000000
XJ(7)	0.000000	0.000000
XJ(8)	0.000000	0.000000
XJ(9)	0.000000	0.000000
XJ(10)	0.000000	0.000000
PJA(1)	12622.40	0.000000
PJA(2)	44396.42	0.000000
PJA(3)	53662.41	0.000000
PJA(4)	49244.57	0.000000

PJA (5)	47012.70	0.000000
PJA (6)	47437.27	0.000000
PJA (7)	52623.93	0.000000
PJA (8)	54482.86	0.000000
PJA (9)	46634.03	0.000000
PJA (10)	11153.61	0.000000
PJAU (1)	12622.40	0.000000
PJAU (2)	44396.42	0.000000
PJAU (3)	50000.00	0.000000
PJAU (4)	49244.57	0.000000
PJAU (5)	47012.70	0.000000
PJAU (6)	47437.27	0.000000
PJAU (7)	50000.00	0.000000
PJAU (8)	50000.00	0.000000
PJAU (9)	46634.03	0.000000
PJAU (10)	11153.61	0.000000
PFJ (1)	37377.60	0.000000
PFJ (2)	5603.580	0.000000
PFJ (3)	0.000000	0.000000
PFJ (4)	755.4315	0.000000
PFJ (5)	2987.301	0.000000
PFJ (6)	2562.729	0.000000
PFJ (7)	0.000000	0.000000
PFJ (8)	0.000000	0.000000
PFJ (9)	3365.973	0.000000
PFJ (10)	38846.39	0.000000
HRJU (1)	50000.00	0.000000
HRJU (2)	50000.00	0.000000
HRJU (3)	53662.41	0.000000

HRJU (4)	50000.00	0.000000
HRJU (5)	50000.00	0.000000
HRJU (6)	50000.00	0.000000
HRJU (7)	52623.93	0.000000
HRJU (8)	54482.86	0.000000
HRJU (9)	50000.00	0.000000
HRJU (10)	50000.00	0.000000
JST (1)	0.000000	0.000000
JST (2)	0.000000	0.000000
JST (3)	3662.408	0.000000
JST (4)	0.000000	0.000000
JST (5)	0.000000	0.000000
JST (6)	0.000000	0.000000
JST (7)	2623.929	0.000000
JST (8)	4482.864	0.000000
JST (9)	0.000000	0.000000
JST (10)	0.000000	0.000000
PF (1)	0.6176000E-01	0.000000
PF (2)	0.9576000E-01	0.000000
PF (3)	0.1049000	0.000000
PF (4)	0.1014000	0.000000
PF (5)	0.9830000E-01	0.000000
PF (6)	0.9550000E-01	0.000000
PF (7)	0.1051600	0.000000
PF (8)	0.1107000	0.000000
PF (9)	0.1079000	0.000000
PF (10)	0.7569000E-01	0.000000
XF (1)	0.000000	0.000000
XF (2)	0.000000	0.000000

XF (3)	0.000000	0.000000
XF (4)	0.000000	0.000000
XF (5)	0.000000	0.000000
XF (6)	0.000000	0.000000
XF (7)	0.000000	0.000000
XF (8)	0.000000	0.000000
XF (9)	0.000000	0.000000
XF (10)	0.000000	0.000000
PFA (1)	35434.52	0.000000
PFA (2)	54941.86	0.000000
PFA (3)	60185.89	0.000000
PFA (4)	58177.78	0.000000
PFA (5)	56399.17	0.000000
PFA (6)	54792.69	0.000000
PFA (7)	60335.07	0.000000
PFA (8)	63513.62	0.000000
PFA (9)	61907.13	0.000000
PFA (10)	43426.79	0.000000
PFAU (1)	35434.52	0.000000
PFAU (2)	50000.00	0.000000
PFAU (3)	50000.00	0.000000
PFAU (4)	50000.00	0.000000
PFAU (5)	50000.00	0.000000
PFAU (6)	50000.00	0.000000
PFAU (7)	50000.00	0.000000
PFAU (8)	50000.00	0.000000
PFAU (9)	50000.00	0.000000
PFAU (10)	43426.79	0.000000
PFF (1)	14565.48	0.000000

PFF (2)	0.000000	0.000000
PFF (3)	0.000000	0.000000
PFF (4)	0.000000	0.000000
PFF (5)	0.000000	0.000000
PFF (6)	0.000000	0.000000
PFF (7)	0.000000	0.000000
PFF (8)	0.000000	0.000000
PFF (9)	0.000000	0.000000
PFF (10)	6573.210	0.000000
HRFU (1)	50000.00	0.000000
HRFU (2)	54941.86	0.000000
HRFU (3)	60185.89	0.000000
HRFU (4)	58177.78	0.000000
HRFU (5)	56399.17	0.000000
HRFU (6)	54792.69	0.000000
HRFU (7)	60335.07	0.000000
HRFU (8)	63513.62	0.000000
HRFU (9)	61907.13	0.000000
HRFU (10)	50000.00	0.000000
FST (1)	0.000000	0.000000
FST (2)	4941.860	0.000000
FST (3)	10185.89	0.000000
FST (4)	8177.785	0.000000
FST (5)	6399.174	0.000000
FST (6)	4792.687	0.000000
FST (7)	10335.07	0.000000
FST (8)	13513.62	0.000000
FST (9)	11907.13	0.000000
FST (10)	0.000000	0.000000

PR(1)	0.7767000E-01	0.000000
PR(2)	0.1580000	0.000000
PR(3)	0.1884900	0.000000
PR(4)	0.1900000	0.000000
PR(5)	0.1900000	0.000000
PR(6)	0.1810000	0.000000
PR(7)	0.1810000	0.000000
PR(8)	0.1810000	0.000000
PR(9)	0.1800000	0.000000
PR(10)	0.1690000	0.000000
PR(11)	0.1440000	0.000000
PR(12)	0.5739000E-01	0.000000
XR(1)	0.000000	0.000000
XR(2)	0.000000	0.000000
XR(3)	0.000000	0.000000
XR(4)	0.000000	0.000000
XR(5)	0.000000	0.000000
XR(6)	0.000000	0.000000
XR(7)	0.000000	0.000000
XR(8)	0.000000	0.000000
XR(9)	0.000000	0.000000
XR(10)	0.000000	0.000000
XR(11)	0.000000	0.000000
XR(12)	0.000000	0.000000
PRA(1)	44562.81	0.000000
PRA(2)	90651.77	0.000000
PRA(3)	108145.3	0.000000
PRA(4)	109011.6	0.000000
PRA(5)	109011.6	0.000000

PRA (6)	103847.9	0.000000
PRA (7)	103847.9	0.000000
PRA (8)	103847.9	0.000000
PRA (9)	103274.2	0.000000
PRA (10)	96962.97	0.000000
PRA (11)	82619.34	0.000000
PRA (12)	32927.25	0.000000
PRAU (1)	44562.81	0.000000
PRAU (2)	50000.00	0.000000
PRAU (3)	50000.00	0.000000
PRAU (4)	50000.00	0.000000
PRAU (5)	50000.00	0.000000
PRAU (6)	50000.00	0.000000
PRAU (7)	50000.00	0.000000
PRAU (8)	50000.00	0.000000
PRAU (9)	50000.00	0.000000
PRAU (10)	50000.00	0.000000
PRAU (11)	50000.00	0.000000
PRAU (12)	32927.25	0.000000
PFR (1)	5437.194	0.000000
PFR (2)	0.000000	0.000000
PFR (3)	0.000000	0.000000
PFR (4)	0.000000	0.000000
PFR (5)	0.000000	0.000000
PFR (6)	0.000000	0.000000
PFR (7)	0.000000	0.000000
PFR (8)	0.000000	0.000000
PFR (9)	0.000000	0.000000
PFR (10)	0.000000	0.000000

PFR (11)	0.000000	0.000000
PFR (12)	17072.75	0.000000
HRRU (1)	50000.00	0.000000
HRRU (2)	90651.77	0.000000
HRRU (3)	108145.3	0.000000
HRRU (4)	109011.6	0.000000
HRRU (5)	109011.6	0.000000
HRRU (6)	103847.9	0.000000
HRRU (7)	103847.9	0.000000
HRRU (8)	103847.9	0.000000
HRRU (9)	103274.2	0.000000
HRRU (10)	96962.97	0.000000
HRRU (11)	82619.34	0.000000
HRRU (12)	50000.00	0.000000
RST (1)	0.000000	0.000000
RST (2)	40651.77	0.000000
RST (3)	58145.27	0.000000
RST (4)	59011.63	0.000000
RST (5)	59011.63	0.000000
RST (6)	53847.92	0.000000
RST (7)	53847.92	0.000000
RST (8)	53847.92	0.000000
RST (9)	53274.17	0.000000
RST (10)	46962.97	0.000000
RST (11)	32619.34	0.000000
RST (12)	0.000000	0.000000
POC (1)	0.5620000E-01	0.000000
POC (2)	0.1250000	0.000000
POC (3)	0.1480000	0.000000

POC (4)	0.1500000	0.000000
POC (5)	0.1470000	0.000000
POC (6)	0.1330000	0.000000
POC (7)	0.1280000	0.000000
POC (8)	0.1370000	0.000000
POC (9)	0.1360000	0.000000
POC (10)	0.1220000	0.000000
POC (11)	0.6000000E-01	0.000000
XOC (1)	0.000000	0.000000
XOC (2)	0.000000	0.000000
XOC (3)	0.000000	0.000000
XOC (4)	0.000000	0.000000
XOC (5)	0.000000	0.000000
XOC (6)	0.000000	0.000000
XOC (7)	0.000000	0.000000
XOC (8)	0.000000	0.000000
XOC (9)	0.000000	0.000000
XOC (10)	0.000000	0.000000
XOC (11)	0.000000	0.000000
POCA (1)	32244.49	0.000000
POCA (2)	71718.18	0.000000
POCA (3)	84914.32	0.000000
POCA (4)	86061.81	0.000000
POCA (5)	84340.58	0.000000
POCA (6)	76308.14	0.000000
POCA (7)	73439.41	0.000000
POCA (8)	78603.12	0.000000
POCA (9)	78029.38	0.000000
POCA (10)	69996.94	0.000000

POCA (11)	34424.72	0.000000
POCAU (1)	0.000000	0.7649939
POCAU (2)	0.000000	0.7649939
POCAU (3)	0.000000	0.7649939
POCAU (4)	0.000000	0.7649939
POCAU (5)	0.000000	0.7649939
POCAU (6)	0.000000	0.7649939
POCAU (7)	0.000000	0.7649939
POCAU (8)	0.000000	0.7649939
POCAU (9)	573.7454	0.000000
POCAU (10)	4016.218	0.000000
POCAU (11)	15491.13	0.000000
PFOC (1)	50000.00	0.000000
PFOC (2)	50000.00	0.000000
PFOC (3)	50000.00	0.000000
PFOC (4)	50000.00	0.000000
PFOC (5)	50000.00	0.000000
PFOC (6)	50000.00	0.000000
PFOC (7)	50000.00	0.000000
PFOC (8)	50000.00	0.000000
PFOC (9)	49426.25	0.000000
PFOC (10)	45983.78	0.000000
PFOC (11)	34508.87	0.000000
HROCU (1)	82244.49	0.000000
HROCU (2)	121718.2	0.000000
HROCU (3)	134914.3	0.000000
HROCU (4)	136061.8	0.000000
HROCU (5)	134340.6	0.000000
HROCU (6)	126308.1	0.000000

HROCU (7)	123439.4	0.000000
HROCU (8)	128603.1	0.000000
HROCU (9)	127455.6	0.000000
HROCU (10)	115980.7	0.000000
HROCU (11)	68933.60	0.000000
OCST (1)	750000.0	0.000000
OCST (2)	0.000000	0.000000
OCST (3)	0.000000	0.000000
OCST (4)	0.000000	0.000000
OCST (5)	0.000000	0.000000
OCST (6)	0.000000	0.000000
OCST (7)	0.000000	0.000000
OCST (8)	0.000000	0.000000
OCST (9)	0.000000	0.000000
OCST (10)	0.000000	0.000000
OCST (11)	0.000000	0.000000
PN (1)	0.1270000	0.000000
PN (2)	0.1580000	0.000000
PN (3)	0.1560000	0.000000
PN (4)	0.1480000	0.000000
PN (5)	0.1360000	0.000000
PN (6)	0.1290000	0.000000
PN (7)	0.1260000	0.000000
PN (8)	0.1190000	0.000000
PN (9)	0.1070000	0.000000
XN (1)	0.000000	0.000000
XN (2)	0.000000	0.000000
XN (3)	0.000000	0.000000
XN (4)	0.000000	0.000000

XN (5)	0.000000	0.000000
XN (6)	0.000000	0.000000
XN (7)	0.000000	0.000000
XN (8)	0.000000	0.000000
XN (9)	0.000000	0.000000
PNA (1)	72865.67	0.000000
PNA (2)	90651.77	0.000000
PNA (3)	89504.28	0.000000
PNA (4)	84914.32	0.000000
PNA (5)	78029.38	0.000000
PNA (6)	74013.16	0.000000
PNA (7)	72291.92	0.000000
PNA (8)	68275.70	0.000000
PNA (9)	61390.76	0.000000
PNAU (1)	50000.00	0.000000
PNAU (2)	50000.00	0.000000
PNAU (3)	50000.00	0.000000
PNAU (4)	50000.00	0.000000
PNAU (5)	50000.00	0.000000
PNAU (6)	50000.00	0.000000
PNAU (7)	50000.00	0.000000
PNAU (8)	50000.00	0.000000
PNAU (9)	50000.00	0.000000
PFN (1)	0.000000	0.000000
PFN (2)	0.000000	0.000000
PFN (3)	0.000000	0.000000
PFN (4)	0.000000	0.000000
PFN (5)	0.000000	0.000000
PFN (6)	0.000000	0.000000

PFN (7)	0.000000	0.000000
PFN (8)	0.000000	0.000000
PFN (9)	0.000000	0.000000
HRNU (1)	72865.67	0.000000
HRNU (2)	90651.77	0.000000
HRNU (3)	89504.28	0.000000
HRNU (4)	84914.32	0.000000
HRNU (5)	78029.38	0.000000
HRNU (6)	74013.16	0.000000
HRNU (7)	72291.92	0.000000
HRNU (8)	68275.70	0.000000
HRNU (9)	61390.76	0.000000
NST (1)	22865.67	0.000000
NST (2)	40651.77	0.000000
NST (3)	39504.28	0.000000
NST (4)	34914.32	0.000000
NST (5)	28029.38	0.000000
NST (6)	24013.16	0.000000
NST (7)	22291.92	0.000000
NST (8)	18275.70	0.000000
NST (9)	11390.76	0.000000
PD (1)	0.4300000E-01	0.000000
PD (2)	0.8200000E-01	0.000000
PD (3)	0.8800000E-01	0.000000
PD (4)	0.7900000E-01	0.000000
PD (5)	0.6800000E-01	0.000000
PD (6)	0.6900000E-01	0.000000
PD (7)	0.7570000E-01	0.000000
PD (8)	0.7300000E-01	0.000000

PD (9)	0.5180000E-01	0.000000
XD (1)	0.000000	0.000000
XD (2)	0.000000	0.000000
XD (3)	0.000000	0.000000
XD (4)	0.000000	0.000000
XD (5)	0.000000	0.000000
XD (6)	0.000000	0.000000
XD (7)	0.000000	0.000000
XD (8)	0.000000	0.000000
XD (9)	0.000000	0.000000
PDA (1)	24671.05	0.000000
PDA (2)	47047.12	0.000000
PDA (3)	50489.60	0.000000
PDA (4)	45325.89	0.000000
PDA (5)	39014.69	0.000000
PDA (6)	39588.43	0.000000
PDA (7)	43432.53	0.000000
PDA (8)	41883.41	0.000000
PDA (9)	29720.01	0.000000
PDAU (1)	24671.05	0.000000
PDAU (2)	47047.12	0.000000
PDAU (3)	49999.95	0.000000
PDAU (4)	45325.89	0.000000
PDAU (5)	39014.69	0.000000
PDAU (6)	39588.43	0.000000
PDAU (7)	43432.53	0.000000
PDAU (8)	41883.41	0.000000
PDAU (9)	29720.01	0.000000
PFD (1)	25328.95	0.000000

PFD (2)	122716.5	0.000000
PFD (3)	0.000000	0.000000
PFD (4)	4674.113	0.000000
PFD (5)	10985.31	0.000000
PFD (6)	10411.57	0.000000
PFD (7)	6567.472	0.000000
PFD (8)	8116.585	0.000000
PFD (9)	20279.99	0.000000
HRDU (1)	50000.00	0.000000
HRDU (2)	169763.6	0.000000
HRDU (3)	50489.60	0.000000
HRDU (4)	50000.00	0.000000
HRDU (5)	50000.00	0.000000
HRDU (6)	50000.00	0.000000
HRDU (7)	50000.00	0.000000
HRDU (8)	50000.00	0.000000
HRDU (9)	50000.00	0.000000
DST (1)	0.000000	0.000000
DST (2)	0.000000	0.000000
DST (3)	489.6434	0.000000
DST (4)	0.000000	0.000000
DST (5)	0.000000	0.000000
DST (6)	0.000000	0.000000
DST (7)	0.000000	0.000000
DST (8)	0.000000	0.000000
DST (9)	0.000000	0.000000

VITA

Eman A. Tora received her Bachelor of Science degree in chemical engineering from Elmenia University in Egypt in 2000. She also received her Master of Science in chemical engineering from Cairo University in 2005. Eman has worked as a researcher at the Egyptian National Research Center until she joined Texas A&M University in the fall of 2006. She did research in process and energy simulation and optimization. Her address in U.S.A. is Apt U1G- 1100 Hensel Dr- College Station- TX, her e-mail address is emanmag@yahoo.com; and her address in Egypt is chemical engineering department- National Research Center- El Doki- Cairo- Egypt.