

A CONTROL SCHEME OF ENHANCED RELIABILITY FOR MULTIPLE CHILLER PLANTS USING MERGED BUILDING COOLING LOAD MEASUREMENT

Shengwei Wang Yongjun Sun Gongsheng Huang Na Zhu
 Professor PhD Student Research Fellow PhD Student

Department of Building Services Engineering, Hong Kong Polytechnic University, Kowloon, Hong Kong

ABSTRACT: This paper presents a control scheme which utilizes the enhanced instantaneous cooling load measurements to improve the reliability of chiller sequencing control. The enhanced measurement is obtained by merging two different measurements of building cooling load using data fusion technique. One is the direct cooling load measurement, which is obtained directly using the differential water temperature and water flow rate measurements. The other is the indirect cooling load measurement, which estimates the cooling load using chiller models based on the instantaneous chiller electrical power input and condition measured variables. The control performance of the proposed scheme is validated in this paper.

Keywords: Data Fusion, Chiller Control, Measurement, Reliability

1. INTRODUCTION

Centralized chilling systems with multiple centrifugal chillers are commonly used in large commercial buildings for providing cooling to occupied spaces. When multiple chillers are employed, it becomes important to properly sequence their operation in order to make the operating chillers achieve an overall COP as high as possible while fulfill the demanded cooling load. In principle, chiller sequencing control aims to determine how many and which chillers are to be put into operation. Since chilling plants consume a large amount of energy in the total energy consumed by buildings, chiller sequencing control plays a significant role in the overall performance of the whole air-conditioning system.

There are various methods of chiller sequencing control used in various buildings. The differences in these methods lie mainly in how the instantaneous

building cooling load is measured (Honeywell 1997). Total cooling load sequencing control is often adopted nowadays, in which a direct way of measuring building cooling load is used. The direct way determines building cooling load by measuring the total flow rate of chilled water and the difference between the chilled water supply and return temperature. Total cooling load sequencing control is in principle the best approach for sequencing the operation of chillers (Honeywell 1997). However, according to the surveys in Hong Kong and elsewhere, the direct measurement of building cooling load cannot always provide reliable measurements of building cooling load in practice due to the noises, outliers and systematic errors in measuring the water temperature and flow rate (Chan 2001). A site study was made in a number of 'normally' maintained chilling systems in Hong Kong using one redundant set of sensors to measure the differential temperatures (Chan 2001). The results showed that the difference between the measured cooling loads using the two set of sensors were over thirty percent in a large proportion of the chilling systems investigated.

The building cooling load computed by the direct measurement is actually the cooling load of chillers. Because the power consumption is an indicator of the chiller cooling load, the power measurement can also be used to estimate the building cooling load, which measures the building cooling load in an indirect way. There are several benefits of measuring building cooling load based on the power consumption for chiller sequencing control. Firstly, the power measurement is now getting to be low cost in the regular instrumentation of Building Automation Systems (BAS). Secondly, electrical variables can be measured accurately and reliably compared with measuring thermo-physical variables. However, correlating the power consumption to building cooling load is complicated due to the influence of the operating conditions. A chiller model is therefore required to be developed for precisely describing the relationship of building cooling load with the power consumption. An obvious disadvantage of the indirect measurement is that the measurement quality depends

much on the accuracy of the chiller model.

Measurement accuracy and reliability are essential for the accuracy and reliability of chiller sequencing control as well as for building air-conditioning system performance monitoring and optimization (Wang and Cui, 2005; Chang Y.C. et al, 2005). To improve the building cooling load estimation will certainly improve the performance of the chiller sequencing control. Data fusion is one of the methods which can be used to improve the measurement accuracy and reliability (Yager, 2004; Esteban et al, 2005; Ruhm, 2007). Current fusion methods are mainly based on statistical theory and always lead to a weighted average of the observations from different sources (Grewal, 2001; Soderstrom et al, 2001).

In this paper, the data fusion concept is adopted to improve the building cooling load measurement by removing the noises, outliers and systematic errors in the direct measurement. The accuracy and reliability of the fused measurement is then increased by combining the complementary advantages of the two different measurement methods. The enhanced measurement is used instead of the direct or indirect measurement in the chiller sequencing control. The reliability of the chiller sequencing control is improved because the merged measurements suffer little from measurement noises, outliers, systematic errors and model errors. In the mean time, the confidence degree is evaluated as quality indicator of the merged measurements.

2. ENHANCED BUILDING COOLING LOAD MEASUREMENT BASED ON DATA FUSION TECHNIQUE

2.1 Outline of The Measurement Enhancement Scheme

Data fusion is implemented to improve the accuracy and reliability of the building cooling load measurement by merging the direct and indirect measurement. The general framework of using data fusion to calculate building instantaneous cooling load of a typical central chilling plant is shown in Figure 1.

The direct measurement of building cooling load at time k is obtained by:

$$Q_{dm,k} = c_{pw} \rho_w M_{w,k} (T_{w,rtm,k} - T_{w,sup,k}) \quad (1)$$

where c_{pw} is the water specific thermal capacity (kW/kg.K) and ρ_w is the water density (kg/L). In practice, M_w is usually measured by water flow meters and $T_{w,rtm}$ and $T_{w,sup}$ are measured by temperature sensors. It is known that these measurements are easily corrupted by measurement noises, outliers or systematic errors. These measurement uncertainties, especially associated with $T_{w,rtm}$ and $T_{w,sup}$, have significant effects on the accuracy of the building cooling load measurement. This is because the differential temperature of the chilled water loop is generally small.

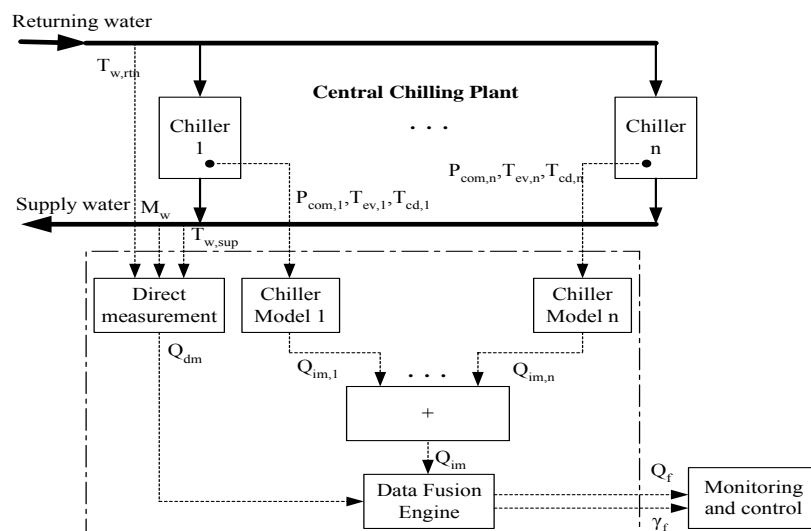

Figure 1. Framework of enhancing building cooling load measurements using data fusion

The indirect measurement of building cooling load based on the instantaneous power consumption can be written as

$$Q_{im,k} = \sum_{i=1}^n f_i(\mathbf{P}_{com,i,k}, T_{cd,i,k}, T_{ev,i,k}) \quad (2)$$

where $f(\cdot)$ denotes the chiller model. Here a simple inverse chiller model is adopted (Wang et al, 2000)

$$f_i(\mathbf{P}_{com,i,k}, T_{cd,i,k}, T_{ev,i,k}) = \frac{P_{com,i,k} - \beta_i}{\alpha_i \times c_{pg} \times (T_{ev,i,k} - T_{cd,i,k})} \times (c_{pl} \times T_{cd,i,k} - h_{fg} - c_{pg} \times T_{ev,i,k}) \quad (3)$$

Where, α is the loss factor of variable part of electromechanical losses and β is constant part of the electromechanical losses (kW). They can be identified using experimental data during commissioning. h_{fg} is the latent heat at reference state pressure (kJ/kg). c_{pg} is the gaseous refrigerant specific heat at a constant pressure (kJ/K·kg). c_{pl} is the liquid refrigerant specific heat at constant pressure (kJ/K·kg). h_{fg} , c_{pg} and c_{pl} are constants. P_{com} is the measured electrical power input to chillers. T_{cd} and T_{ev} can be derived according to the condensing pressure P_{cd} and evaporating pressure P_{ev} . Given a chiller, the relationships between the temperatures and the pressures are determined by the refrigerant in use. Data fusion is completed in the data fusion engine, which gives the fused measurement, denoted as Q_f , and the associated confidence degree, denoted as γ_f . The confidence degree indicates the quality of the fused measurements.

2.2 Merged Building Cooling Load Measurement

It is commonly understood that the direct measurement mainly suffers from measurement noises, outliers as well as systematic errors. It may be inappropriate to use traditional filtering methods to smooth the direct measurement since measurement noises have great influence on the accuracy of the measurements. Assuming the measurement noises follow a normal distribution with zero mean, the sum of a sequence of continuous direct measurements is more reliable than that of the indirect measurements if the direct measurements are free of outliers and systematic errors. This is because the indirect

measurement may suffer from model errors or biases. In contrast, the indirect measurement can provide more reliable cooling load variations than the direct measurement when the building cooling load does not vary significantly. The major reason is that the model errors or biases will keep relatively constant. With capitalizing the complementary advantages of direct and indirect measurement, the fusion algorithm reconstructs the cooling load measurements in the following way and details are referred to (Huang et al. 2008):

- i). When direct measurement only suffers from noise, the fused algorithm uses the sum of the direct measurements and the variations of the indirect measurements to remove the effects of noise.
- ii). When outliers are detected in the direct measurements, the current building cooling load is computed by calibrating the previous fused cooling load using the increment of the indirect measurement.
- iii). When systematic errors are detected in the direct measurements, the data fusion algorithm calibrates the current indirect measurement to reduce the influence of the systematic errors.

The associated confidence degree γ_f , locating in the range (0, 1), is developed to evaluate the quality of the fused measurement. A larger value of the confidence degree indicates the higher quality of the merged measurement. Its value decreases quickly to around zero when outliers or systematic errors occur in direct measurement. When the degree is low enough for a certain period, the BAS need to send out a warning signal for the requirement of necessary actions.

3. CONTROL SCHEME WITH ENHANCED ROBUSTNESS USING FUSED COOLING LOAD

3.1 Robust Chiller Sequencing Control Strategy

The chiller sequencing control strategy of enhanced robustness is illustrated in Figure 2. The fused measurement is used to replace the direct measurement used in the traditional chiller sequencing control. The maximum cooling capacity Q_{max} of individual chillers takes the value of chiller rated capacity. When outliers or systematic error happens which can be detected by low confidence degree, the maximum cooling capacity will be calibrated accordingly. Chiller sequencing control determines the chiller operating number based on the calibrated maximum cooling load QC_{max} and the fused measurement Q_f .

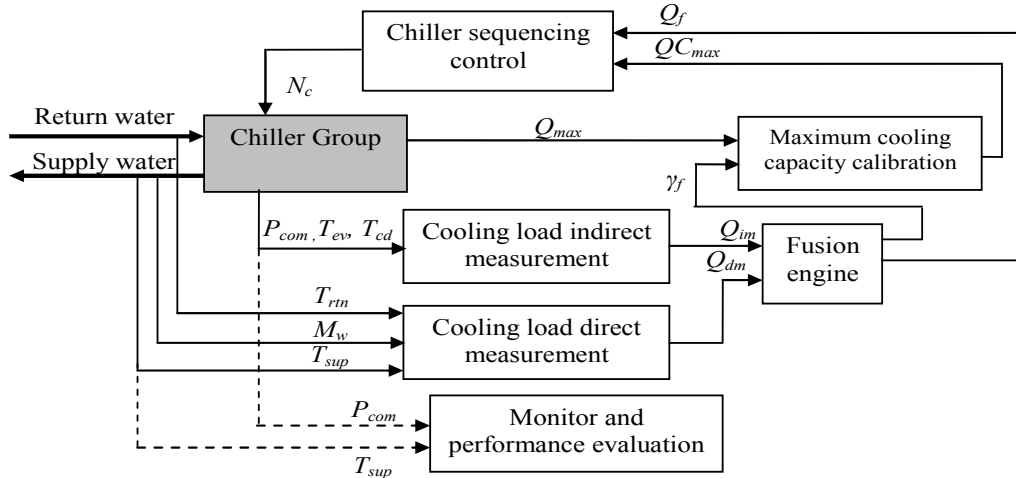

Figure 2. Robust chiller sequencing control strategy practice (Chang Y. 2005).

3.2 Calibration of Chiller Maximum Cooling Capacity

Low confidence degree indicates the poor quality of the fused building cooling load that may be caused by outliers or systematic error. In this case, the fused measurement might be much larger or smaller than the actual building cooling load. Concerning about the energy efficiency, it is necessary to calibrate the maximum cooling capacity in order to maintain a proper number of the operating chillers. The strategy of online calibrating the maximum cooling capacity is described by equation (4), where ε is the threshold showing whether a systematic error is detected. ζ is the calibrating factor, satisfying $\zeta > 1$.

$$QC_{\max} = \begin{cases} Q_{\max}, & \text{when } \gamma_f > \varepsilon \\ \zeta Q_{\max}, & \text{otherwise} \end{cases} \quad (4)$$

With the user-defined calibrating factor ζ , the estimated chiller cooling supplied capacity will be enlarged. This enlargement aims to keep the number of the operating chillers as small as possible and hence benefit the energy performance. When the fused building cooling load is much larger than the actual one, this strategy can provide enough cooling. However, if the fused measurement is less than the actual cooling load significantly, it will result in insufficient cooling. Therefore, an additional scheme is needed, which monitors the supply chilled water temperature and switches on one more chillers if the supply chilled water temperature is significantly above its set-point for long enough periods.

3.3 Chiller Sequencing Control Algorithm

In chiller sequencing control, the following operational constraints are widely adopted in the

- i) Switch on/off threshold constraint: To prevent chillers from frequent switching, a dead band is introduced. Assume the current operating chiller number is N_0 and the switch on and off thresholds, ST_{on} and ST_{off} are separately defined by equation (5), where d is a user defined dead band.

$$\begin{aligned} ST_{on} &= N_0(QC_{\max} + d) \\ ST_{off} &= (N_0 - 1)(QC_{\max} - d) \end{aligned} \quad (5)$$

- ii) Minimum up/down time constraints T_{mu}/T_{md} : a chiller should not be switched off/on immediately after it is switched on.

Robust chiller sequencing control algorithm

- Step 1: Compute the fused measurement of the building cooling load and the confidence degree using the algorithm referred to (Huang et al. 2008);
- Step 2: Calibrate the maximum cooling capacity by Equation (4);
- Step 3: Compute the switch on/off thresholds by Equation (5);
- Step 4: Check the satisfaction of the minimum up/down time constraints. If the constraints are satisfied, switch on/off one more chillers; otherwise, no action is taken;
- Step 5: Go back to step 1 at the next time instant.

4. APPLICATION CASE STUDIES

4.1 Simulation Platform of A Multiple Chiller Plant

The robust chiller sequencing control scheme, illustrated in Figure 2, was verified using a dynamic simulation of a central chiller plant. Six identical centrifugal chillers with rated capacity of 7230 kW are installed in the high rise building named

International Commerce Center (ICC) in Hong Kong (Wang et al. 2006). The schematic diagram of the central chiller plant is shown as figure 3. Each chiller was interlocked with a chilled water distribution pump and a cooling water distribution pump. Both of them are constant speed with volumetric flow rate of 345L/s and 410L/s respectively.

For simplicity, all the air handling units (AHUs) have been replaced by a global one. The thermal building was cooled down using the cooled supply air provided by the global AHU. After the chilled water flowing through the AHU for heat exchange, it was distributed evenly to the operating chillers. In the cooling water loop, eleven identical cross-flow cooling towers with design water flow rate of 250kg/s were used for the heat rejection. The cooling return water, droved by the cooling water distribution pumps, was distributed evenly to the operating cooling towers. The central chiller plant was simulated using the models developed on the simulation software platform, TRNSYS 16 (2004). The sequencing control strategy was programmed in MATLAB and embedded in TRNSYS 16 using the interface provided by TRNSYS 16. A typical one week cooling load profile of a complex building in Hong Kong was used in the simulation. The variations of the building cooling load are shown in Figure 4. The chiller sequencing control algorithm was used in the case study with the following parameters:

- The calibrating factor $\gamma = 1.02$ (in Equation 4);
- The calibrating threshold $\varepsilon = 0.08$ (in Equation 4);
- The minimum up time constant $T_{mu} = 30$ minutes;
- The minimum down time constant $T_{md} = 30$ minutes

To evaluate the robustness of the robust control scheme, the traditional control scheme based on the direct building cooling load measurement was also implemented for comparison. The robustness of two control schemes mainly can be compared by the total chiller switching number N_s . Other two performance indicators, the total energy consumption P_{total} and the integrated time T_{over} of average building indoor temperature being 0.4 over its set-point, are also presented. The total energy consumption P_{total} consists of the energy consumed by the chillers $P_{chiller}$, the pumps P_{pump} and the cooling towers P_{ct} .

4.2 Performance of The Chiller Sequencing

Control Strategy

In the tests, the noise with zero mean normal distribution and 0.25°C standard deviation, outliers with magnitude of 1°C and systematic errors lasting four hours with magnitude of 0.9°C have been added to the chilled water temperature measurement. It can be seen from Figure 5 (upper) that the noise, outliers and systematic errors influenced the direct measurement greatly. The largest error was close to 2.0×10^4 kW. In contrast to the direct cooling load measurement, the fused cooling load measurement effectively eliminated the corruptions from the noise, outliers and the systematic errors. The 95% of the difference between the fused cooling load and the real one located in a much smaller range, i.e. $[-1.2 \times 10^3$ kW, 1.2×10^3 kW] with an average value of 338 kW. The confidence degree can quickly drop down to a low value and keep being low to indicate the existence of systematic error. It will be helpful to inform the operator to check out the problems to avoid the low performance of control system.

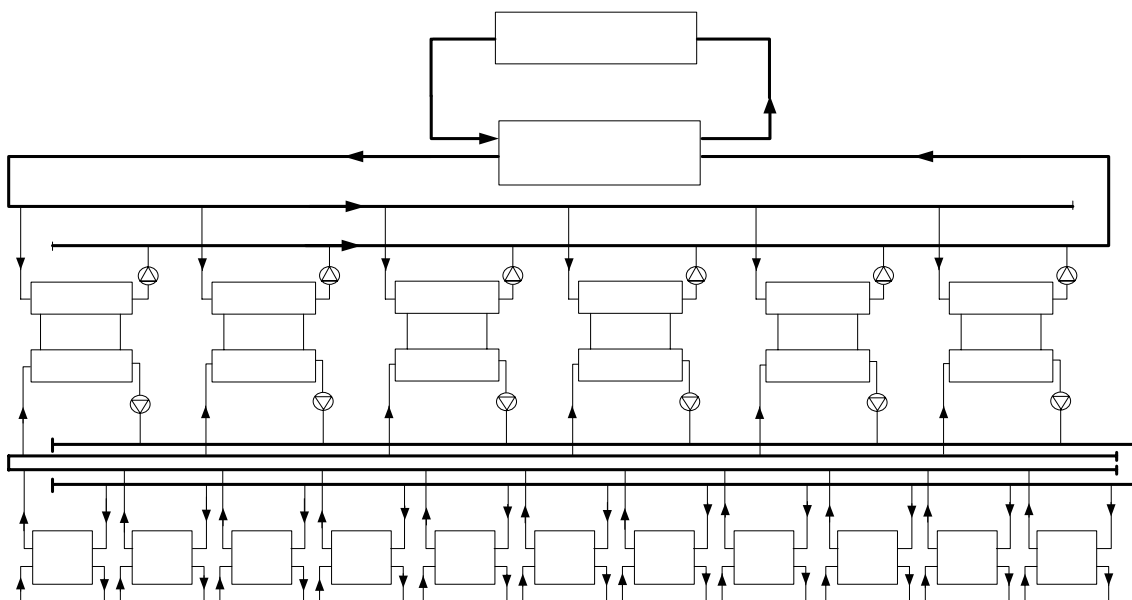

Figure 3. Schematic diagram of the chiller plant

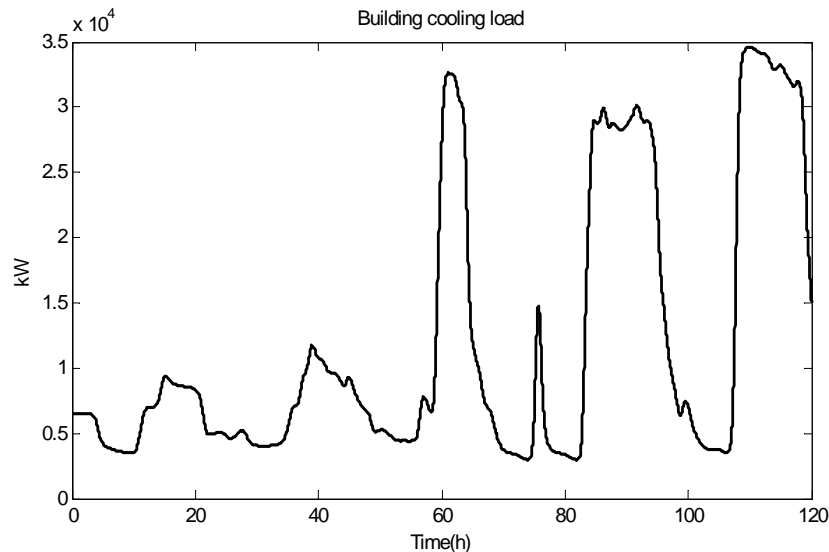

Figure 4. Profile of the building cooling load

It should be noted that there was a transient period when a chiller was switched on. During transients, the chiller cannot reach a stable operating condition and the power consumption might not be able to accurately reflect the cooling supplied. Therefore, during this period the fused measurement was set to be equivalent to the direct cooling load. This can explain why great deviations of the fused measurement from the actual one occurred at certain times in the fused measurement, especially when systematic errors were detected during transients, see Figure 5 (middle). However, this kind of inaccurate fused measurement will not affect much on the chiller sequencing control due to the minimum up time constraint.

The traditional chiller sequencing control based on the direct cooling load was observed misbehaving, i.e. unnecessary switch on/off, due to measurement inaccuracy. The unnecessary switch-on actions certainly waste energy. On the other hand, the unnecessary switch-off action may cause the supplied cooling severely insufficient. In this case, the building

indoor average temperature cannot be maintained at the set-point which may result in thermal discomfort for the occupants. Examples of these unnecessary switching in the chiller sequence were given in Figure 6. As summarised in Table 1, T_{over} (the total time of the chiller water supply temperature over its set point by 0.4 °C) was 41.2 hours, much larger than that in the case of using fused measurement (5.9 hours).

The performance of the robust chiller sequencing control scheme is shown in Figure 7. The robustness of the control scheme has been enhanced largely from removing the effects of the noise, outliers and the systematic errors. It should be noted that systematic errors can still slightly cause the chiller sequencing controller misbehaving (see Figure 7, the dotted box) since the indirect measurement was calibrated using a constant value (Huang et al. 2008). It is also worth noting that with the improved robustness and the better maintained average indoor temperature, the energy consumption of the robust chiller sequencing control scheme even decreases by 1.14% compared with the conventional control.

Table 1. Control performance comparison between robust strategy and conventional strategy

Variables \ Strategy	T_{over} (h)	$P_{chiller}$ (kWh)	P_{pump} (kWh)	P_{ct} (kWh)	P_{total} (kWh)	N_s
conventional chiller sequencing control	41.2	332354.5	75510.1	77065.7	484930.4	70
Robust chiller sequencing control	5.9	329093.1	73235.5	75621.3	477949.9	36

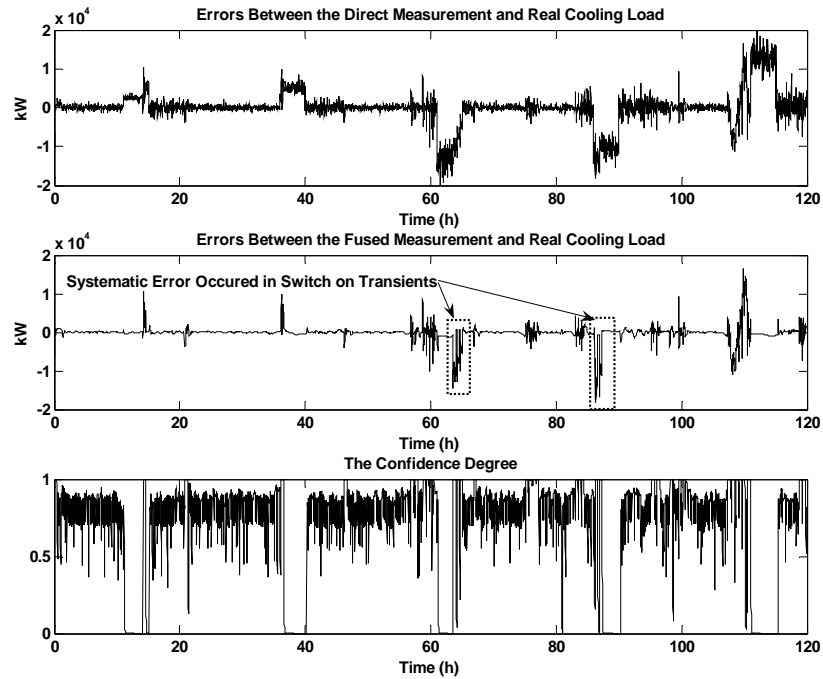

Figure 5. Deviations of the direct measurement (upper) and of the fused measurement (middle) from the real values of cooling load; and the confidence degree (bottom)

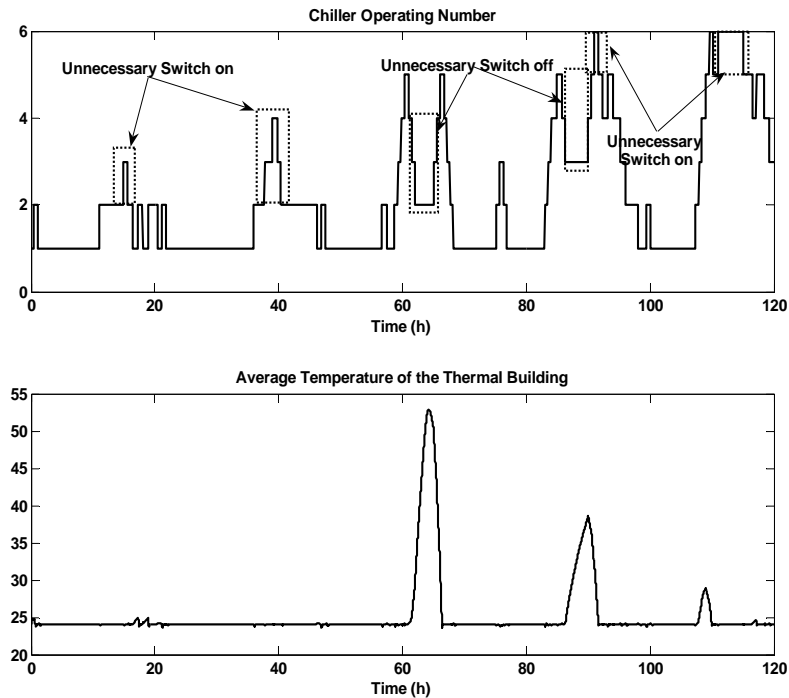

Figure 6. Control performance of the conventional chiller sequencing control

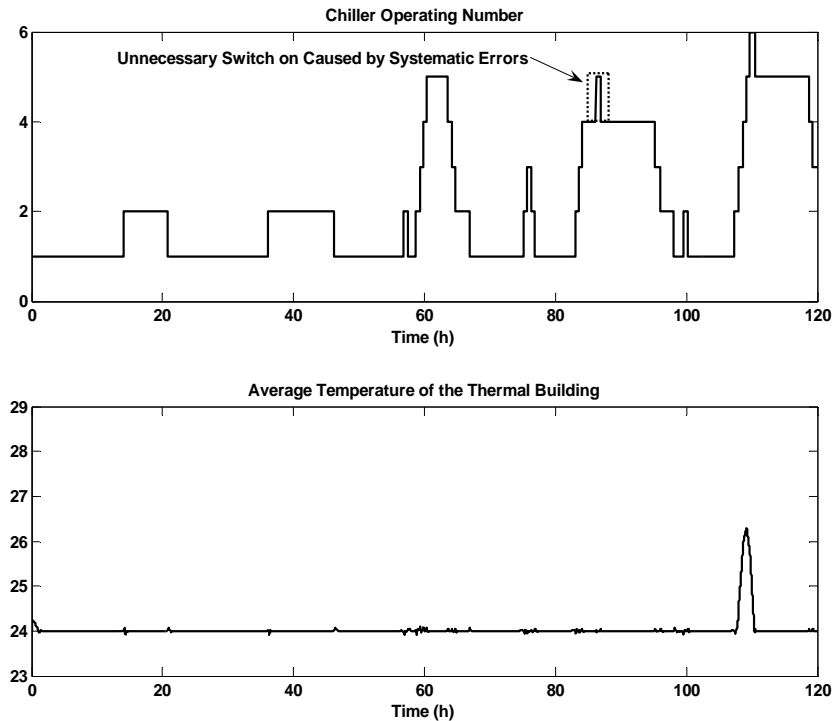

Figure 7. The control performance of the robust chiller sequencing control

5. CONCLUSIONS

A control scheme utilizing fused measurement of building cooling load was developed to improve the robustness of chiller sequencing control in building automation systems. It has been shown that the fused measurement, which has the complementary advantages of the direct and indirect measurement of building cooling load, can effectively reduce the negative influence of the measurement noises, outliers and systematic errors. The rapid decrease of the confidence degree being remained at a low value indicates the occurrence of systematic error. Application case studies demonstrated that the robust control scheme based on the fused cooling load was able to greatly reduce the total switching number of chillers with about 1.4% energy consumption savings as well as better indoor temperature control compared with the chiller sequencing control using direct cooling load measurement. The in-situ implementation and validation of the strategy are being conducted in a high-rise building.

6. ACKNOWLEDGEMENT

The research work presented in this paper is financially supported by a grant (PolyU5298/06E) of the Research Grants Council (RGC) of the Hong Kong SAR and the support of Sun Hung Kai Real Properties Limited.

REFERENCES

1. Chang, Y., F. Lin and C. Lin. 2005. Optimal chiller sequencing by branch and bound method for saving energy. *Energy conversion and management*, 46(13-14): 2158-2172.
2. Chang, Y.C., J.K. Lin and M.H. Chuang. 2005. Optimal chiller loading by genetic algorithm for reducing energy consumption. *Energy and Buildings*, 37(2): 147-155.
3. Esteban, J., A. Starr, R. Willetts, P. Hannah, P. Bryanston-Cross. 2005. A review of data fusion models and architectures: towards engineering guidelines. *Neural Computing and Applications*, 14(4): 273-281.
4. Grewal, M.S. 2001. *Kalman Filtering: Theory and Practice using Matlab*. New York, Chichester, Wiley.
5. Honeywell. 1997. *Engineering manual of automatic control for commercial buildings*. Honeywell SI Edition.
6. Huang, G.S., S.W. Wang and Y.J. Sun. 2008. Enhancing the reliability of chiller sequencing control using fused measurement of building cooling load. *HVAC&R Research* (In Press).
7. Ruhm, K.H. 2007. Sensor fusion and data fusion-mapping and reconstruction. *Measurement*, 40(2): 145-157.
8. Soderstrom, T.A., D.M. Himmelblau and T.F. Edgar. 2001. A mixed integer optimization approach for simultaneous data reconciliation and identification of measurement bias.

- Control Engineering Practice, 9: 869-876.
9. TRANSYS. 2004. TRANSYS 16 documentation. <http://sel.me.wisc.edu/trnsys>.
 10. Wang S.W. and J.T. Cui. 2005. Sensor-fault detection, diagnosis and estimation for centrifugal chiller systems using principal-component analysis method. *Applied Energy*, 82(3):197-213.
 11. Wang, S.W., J.B. Wang and J. Burnett. 2000. Mechanistic model of centrifugal chillers for HVAC system dynamics Simulation. *Building Service Engineering Research and Technology*, 21(2): 73-83.
 12. Wang S.W., Xu X.H. and Ma Z.J. 2006. Energy performance evaluation and development of control strategies for the air-conditioning systems of a new building at construction stage. IEA ECBCS Annex 47, Trondheim, Norway.
 13. Yager, R.R. 2004. A framework for multi-source data fusion. *Information Science*, 163(1-3): 175-200.