

A STEAM TURBINE EFFICIENCY IMPROVEMENT APPLICATION AND CONVERSION

by

Bruce Weathersby

Senior Maintenance Engineer

Celanese Chemical Company

Pasadena, Texas

Andrew P. Mahon

Manager-Reliability and Maintenance Engineering

and

Stephen Chesmejef

Senior Fluid Flow Development Engineer

General Electric Company

Mechanical Drive Turbine and Compressor Department

Fitchburg, Massachusetts

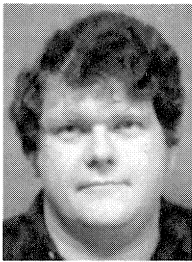

Bruce Weathersby is a 1974 graduate of Lamar University. Presently he is a Senior Maintenance Engineer specializing in rotating equipment at the Celanese Chemical Company, Clear Lake Plant in Pasadena, Texas. During his first five years with Celanese, he was a Project Engineer involved in the installation of various types of rotating equipment in the chemical and textile division. He has spend the last five years as a

Rotating Equipment Engineer involved in all phases of machinery analysis and repair. He is a past chairman of the Houston chapter of the Vibration Institute.



Andrew P. Mahon is manager of Reliability and Maintenance Engineering, Mechanical Drive Turbine and Compressor Department, General Electric Company, Fitchburg, Massachusetts. Mr. Mahon holds degrees in both Mechanical and Industrial Engineering and has over fifteen years experience in steam turbine design and maintenance.



Stephen Chesmejef is a Senior Engineer in Fluid Flow Development with the General Electric Company in the Mechanical Drive Turbine and Compressor Department in Fitchburg, Massachusetts. He is responsible for development and aerodynamic research of turbine flow path components.

Mr. Chesmejef joined the General Electric Company in 1956. His experience has been primarily in the areas of thermodynamic and aerodynamic research and development of new and improved flow path components. He holds a M.S. degree in Mechanical Engineering from the Technical University in Munich, West Germany. He is a member of ASME.

ABSTRACT

This paper presents some recent technical innovations to improve mechanical drive steam turbine efficiency and presents a case study of a recent retrofit application of these features to a compressor driver. Various external and internal factors for consideration of the balance of plant efficiency gains are discussed. Descriptions of the turbine steam path improvements, testing, and results of the steam turbine conversion are also presented.

INTRODUCTION

Over the past several years, the realities of the worldwide depressed petrochemical market have made careful consideration of all opportunities to improve plant performance a fundamental necessity. In the area of turbomachinery, efficiency benefits can be obtained first by consideration of external factors involving the optimum balance of plant operation and by consideration of internal factors to the machinery itself. The first element requires leadership by the plant, while the second element requires analysis by the original equipment manufacturer.

A plant efficiency improvement in which a balance of plant improvements and steam turbine upgrading was accomplished using this two-element approach is presented. Careful and continuous contact between the two parties during all phases of the conversion from design, manufacture, installation, and testing was ensured and a tight schedule of three and one-half months, including installation, was met without incident.

First addressed, in a general way, are the external and internal factors affecting the design improvements necessary for steam turbine efficiency improvements. The balance of plant factors affecting the process performance improvement and field conversion itself will also be presented.

The conversion of an existing 650 psig to condensing steam turbine to handle 15 psig admission steam is covered. The process advantage of using low pressure steam for admission is explained. The various phases involved in the conversion from original proposal through hardware manufacture and machine conversion are covered from a user viewpoint. Key items of importance that helped the conversion take place in a timely manner are discussed. Predicted savings of 650 psig inlet steam are compared to results measured after the conversion completion.

It is hoped that this information will be food for thought for plants in their considerations of projects to improve balance of plant performance upgrades and will illustrate items and methodology which resulted in the very effective completion of this program.

EXTERNAL FACTORS TO TURBINE IMPROVEMENTS

Process Changes

Over the past several years, many changes have taken place in process design and product mix as a result of feedstock costs and product demand. Consequently, reassessment and redesign of process streams and energy use has been crucial.

The use of pressure reducing stations to throttle steam without generating any useful work is less and less desirable. Dumping or condensing relatively low level energy steam streams is being given more careful scrutiny. In some cases, high energy-consuming sections of the process or processes that are no longer cost effective are being eliminated. This, then, requires a reassessment of the energy balance of the unaffected areas and performance effects on the machinery involved. In some cases, process changes and process eliminations have reduced steam turbine power requirements by as much as fifty percent. Obviously, running a steam turbine at half of its rated capacity results in very serious efficiency debits.

Initial Inlet Steam Conditions

Occasionally, steam turbines are specified by the process contractor with a wide range of potential inlet conditions. After startup and some operating experience, it is sometimes found that the minimum steam conditions specified are not necessary. However, design compromises were made to enlarge the steam flow passing area to accommodate that possible inlet condition. Consequently, increased flow separation at normal inlet stream conditions are possible with lost performance. Decreasing the flow passing areas will then minimize this separation and improve efficiency.

Velocity Ratio Effects

As a general rule, steam turbines are developed to optimize performance by achieving peak stage efficiency based upon the stage velocity ratio. A typical high pressure section performance curve as a function of steam velocity divided by wheel velocity is shown in Figure 1. Point A is the optimum operation point for best efficiency. If the steam velocity or wheel speed is significantly different from the original guarantee point or nameplate point, the stages can all be undersped or oversped with a resultant loss in performance. Redesign of the steam path can improve the efficiency for the new situation.

INTERNAL FACTORS TO TURBINE PERFORMANCE IMPROVEMENTS

Technology improvements in turbine steam path design require several key ingredients. Accurate and predictable models must be developed to enable a thorough understanding of the turbine steam path behavior. Many times, significant and costly machine tool investments must be made to manufacture the new design elements. The elements must then undergo sufficient accurate and representative tests to show that the benefits predicted were achieved.

Some of the technological advancements which have been developed over the past several years are increased efficiency cylindrical and vortex blades, improved conical sidewall dia-

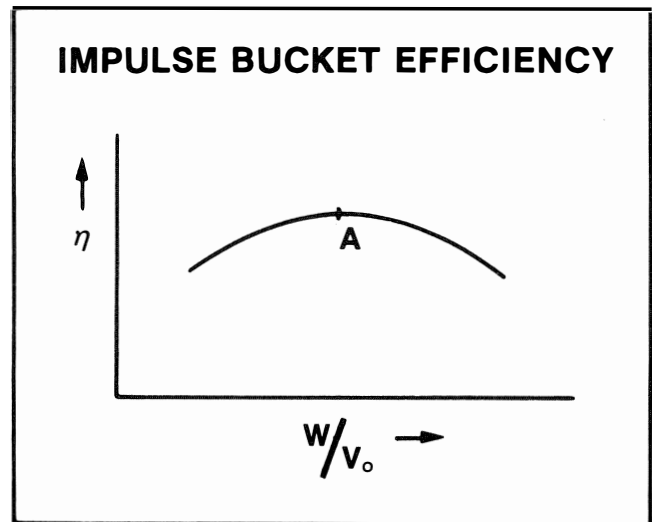

Figure 1. Impulse Bucket Efficiency.

phragms, improved blade tip and root sealing systems, improved quality and clearance labyrinth packing, and improved efficiency diaphragm partitions. In each case, substantial investment in computer aided design equipment, numerical control machine tools and specialty machine tools was necessary.

SCHLICT Cylindrical Blade Design

A typical cylindrical blade section for the old two-radius blade design and the new more efficient blade profile is shown in Figure 2. This profile geometry was developed at General Electric Company's Turbine Technology Aerodynamic Development Laboratory and is based on the Swartz Christofel Holographic Laminar Incompressible Conformal Transform

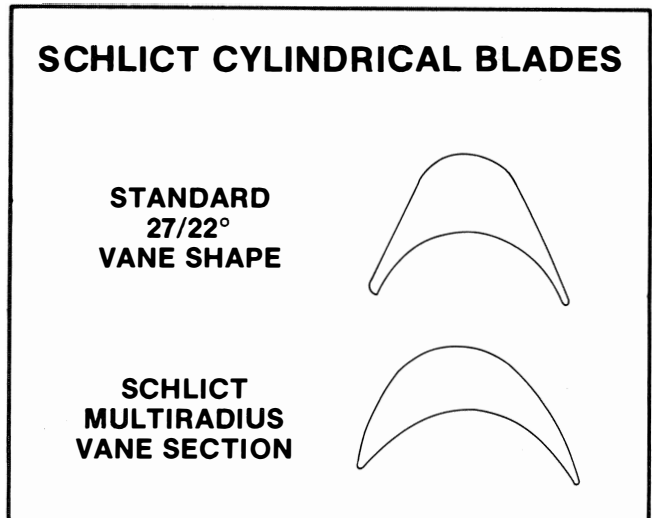

Figure 2. SCHLICT Cylindrical Blades.

(SCHLICT). A typical velocity ratio versus efficiency chart showing the old blade performance and the new blade performance is featured in Figure 3. As can be seen in Figure 4, the reduced flow separation effect is shown by comparing the degree of turbulence as indicated by the dye injected on the left side of the model. The turbulence is made more pro-

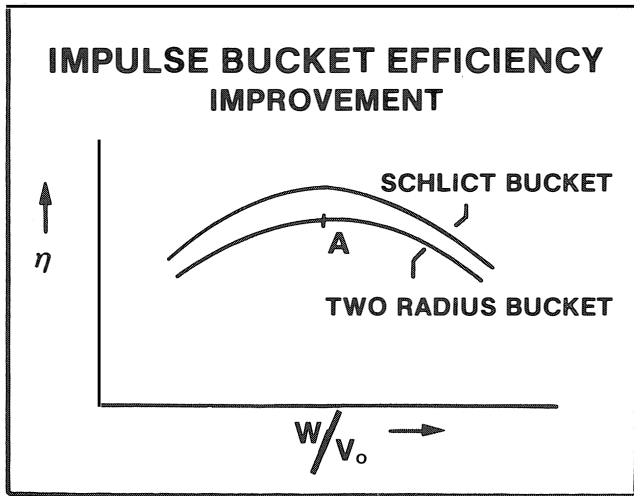

Figure 3. Impulse Bucket Efficiency Improvement.

nounced on the two-radius blade design than the SCHLICT cylindrical blade design. As shown in Figure 5, a complete family of SCHLICT blades has been developed. A comparable family of blades was also developed for the vortex design as well, as shown in Figure 6.

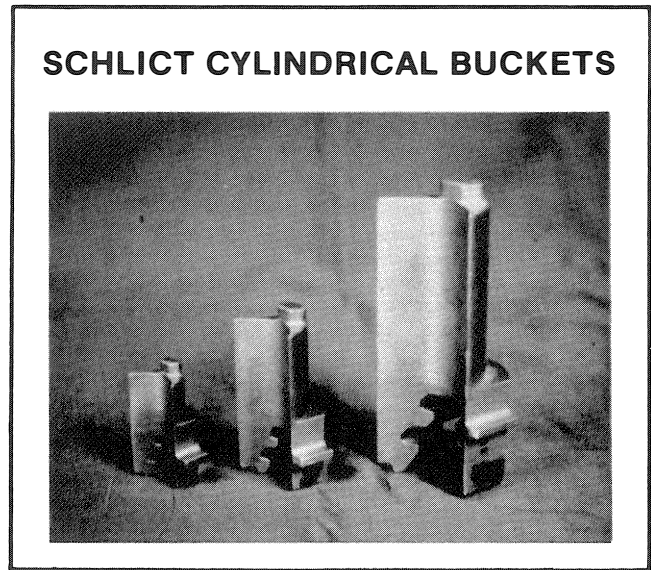

Figure 5. SCHLICT Cylindrical Buckets.

SCHLICT Vortex Blade Design

The family of new vortex blade designs which were developed is depicted in Figure 6. Using theoretical models and

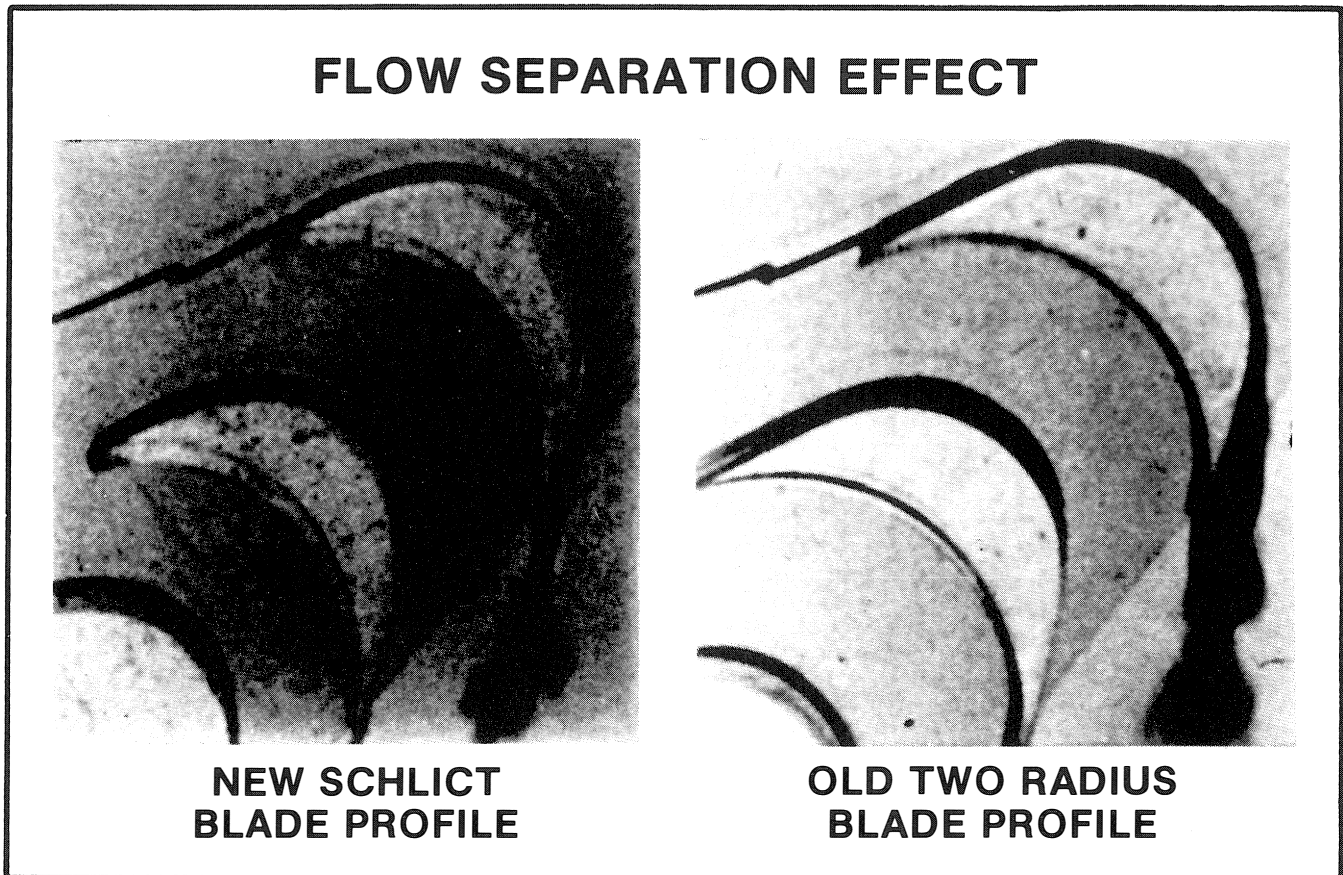

Figure 4. Flow Separation Effect.

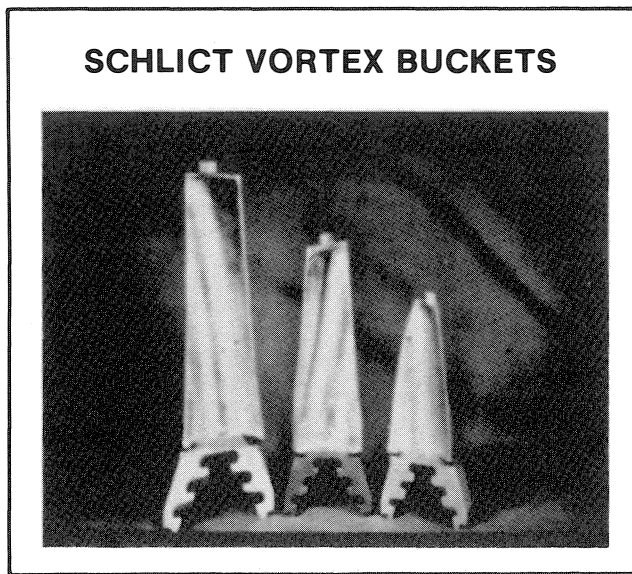

Figure 6. SCHLICHT Vortex Buckets.

comprehensive testing, radial steam flow losses were minimized. This was achieved by balancing the pressure reaction distribution radially along the vane height against the centrifugal force on the steam through the blade passage. In addition, flow separation in the blade passage was minimized by the design of the airfoil. The pressure coefficient around the blade comparing the older double-tapered design and newer vortex design is shown in Figure 7. Sudden changes in the pressure coefficient indicate sudden changes in flow velocity which will result in flow separation.

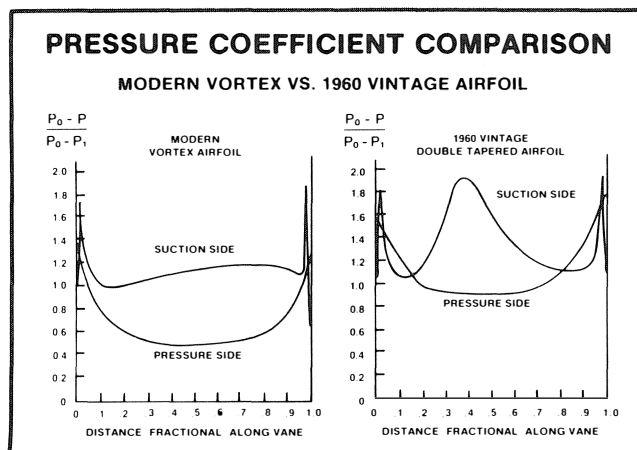

Figure 7. Pressure Coefficient Comparison between Modern Vortex and 1960 Vintage Airfoil.

An added benefit in the vortex blade design was increased blade reliability due to added damping from decreased blade pitching. Typical blade pitch and tip spacing for the old double-tapered design and the new vortex design is shown in Figure 8. The vortex design (Figure 9) showed a dramatic reduction in vibratory stress compared to the original design.

Diaphragm Nozzle Partition Redesign

As with blade development, diaphragm nozzle partition development to improve efficiency was a key area of concentra-

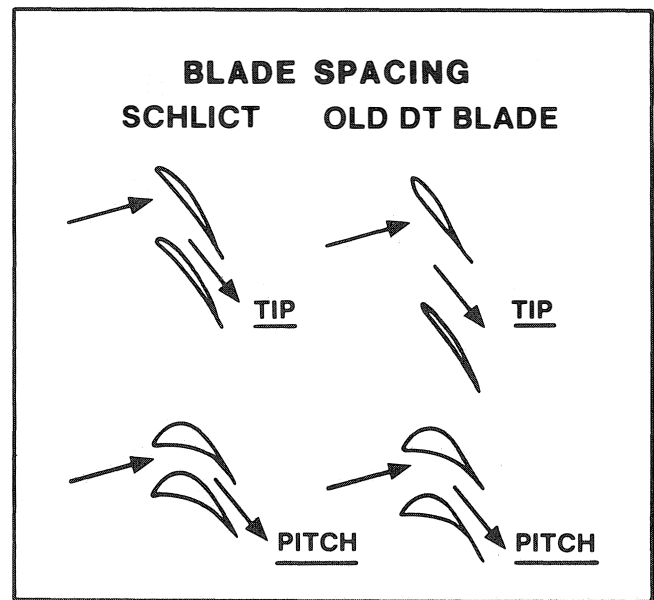

Figure 8. Blade Spacing.

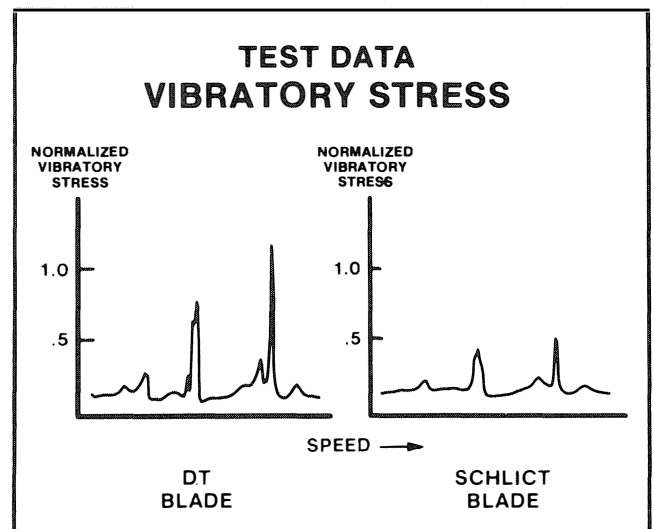

Figure 9. Test Data for Vibratory Stress.

tion. New nozzle partitions were developed and tested using a single cascade incompressible flow test with water as the flow medium. Tests were then performed with air as the flow medium. Finally, stage tests using either air or steam were performed to verify the efficiency benefit. Simultaneously, mechanical integrity was also verified for both steady state and vibratory stress efforts.

The progress made in diaphragm nozzle partition design is illustrated in Figure 10. The resultant pressure coefficient distribution along the pressure and suction sides of the partition as a function of the axial distance along the metal section is illustrated in Figure 11. As with blade designs, sudden sharp changes in the pressure coefficient are indicative of flow separations and lost efficiency.

An added benefit of this redesign was the reduction of the downstream blade stimulus, due to the reduced separation. Therefore, long term blade reliability was also enhanced with the new partition design.

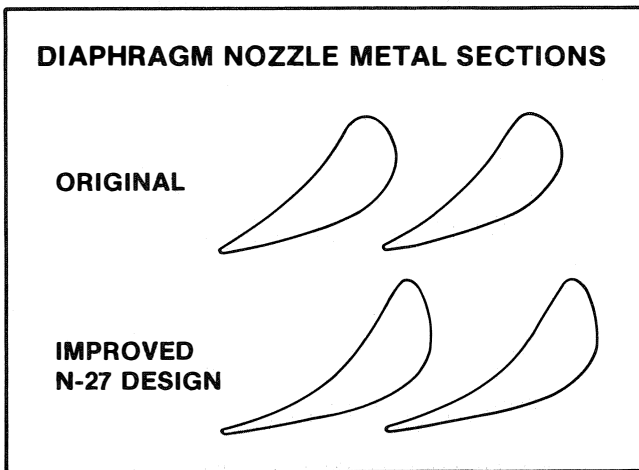

Figure 10. Diaphragm Nozzle Metal Sections.

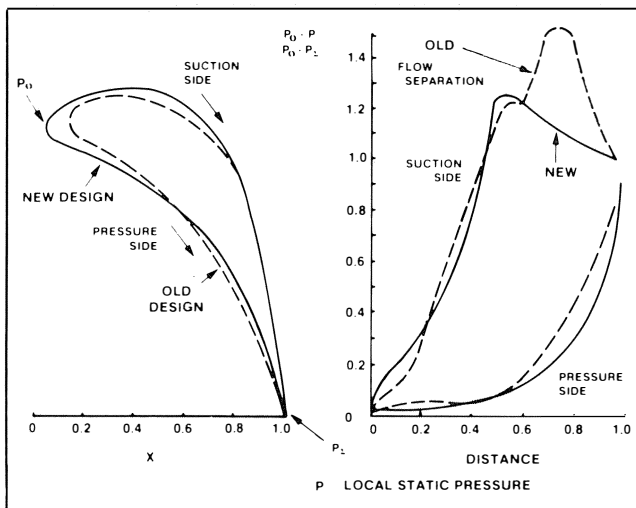

Figure 11. Flow Separation.

Conical Sidewall Diaphragm Design

Since the early 1970s, a comprehensive ongoing program to upgrade diaphragm quality and reliability has been followed. One area of significant hardware improvement occurred with the capability to manufacture inner and outer diaphragm spacer bands by electric discharge machining (EDM).

With EDM, diaphragm spacer bands are formed into a conical shape, and holes for the nozzle partition are pierced by the action of precision-machined carbon electrodes. In the machining process, metal is electrolytically removed by the action of a highly charged carbon electrode operating submerged in a conductive oil bath. The resulting hole accurately reproduces the complex contour of the carbon electrode, which has been precision machined to duplicate the shape of the diaphragm nozzle. The use of EDM techniques result in the dual benefit of providing a more controlled nozzle/spacer interface at the outer ring of the diaphragm and a more precise method of locating the diaphragm nozzle partition for improved nozzle area control. This, in turn, results in a less obstructed steam path exhibiting reduced bucket stimulus characteristics. Components manufactured with the EDM process represent a significant advance over previous diaphragm construction methods.

Steam expansion through the taller height exhaust end stages results in large step increases in bucket height, as shown in Figure 12. On earlier turbine designs, built without the benefit of extended spacer bands or conical sidewalls, steam was allowed to expand through the large open area between the diaphragm and the casing with little or no channeling or guidance. In these designs, steam leaving the exit side of the upstream buckets would decelerate while transversing the axial distance between successive open stacked stages. This deceleration had the effect of increasing the stage shell stagnation pressure, resulting in a reduction in the energy available to the upstream stages and a reduced stage pressure ratio. As a result of EDM advances, the extended conical sidewall diaphragm (Figure 12) can now be used to more effectively direct steam flow and expansion, resulting in reduced nozzle exit losses and improved performance levels. The smooth, conical sidewall results in more effective steam guidance for maximum residual energy recovery and reduced boundary layer flow separation in the vicinity of the diaphragm outer ring.

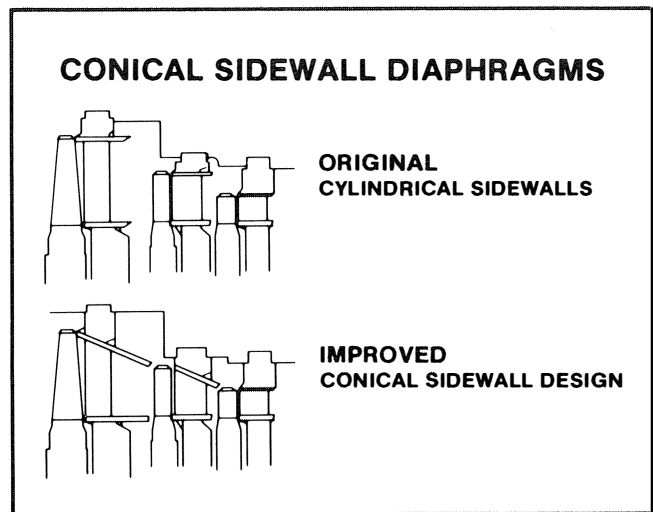

Figure 12. Conical Sidewall Diaphragms.

The beneficial effects of EDM conical sidewall diaphragms are more pronounced in the last stage where inefficiencies result in energy not extracted from the last stage being lost to the cycle in the condenser, and on tall height latter stages that do not benefit as significantly as head-end stages from turbine reheat.

Improved Leakage Control Methods—High-Low Packing

In impulse turbines, the entire stage pressure drop is taken across the stationary diaphragm nozzles. As a result, a percentage of the diaphragm stage flow can pass through the interstage packing as leakage at the diaphragm bore. The bulk of turbines manufactured prior to 1968 were fitted with straight tooth diaphragm packing, typically operating at a running clearance of 0.001 to 0.002 in, per inch of shaft diameter.

Sizable reductions in leakage flow were obtained through the use of improved, double, high-low tooth, interstage packing. In this design, the machined packing sections contain staggered rows of high and low teeth custom designed to fit into matching machined grooves in the turbine rotor shaft. As shown in Figure 13, the use of double high-low teeth resulted in a significant reduction in interstage diaphragm leakage flow, due to the repeated obstructions and increased restriction of the seal path.

In the case of retrofits, high-low packing teeth can be added by machining grooves into the previously smooth section of the rotor shaft. Leakage flow through multiple restriction double high-low packing can be up to 50 percent less than that obtainable with straight tooth designs.

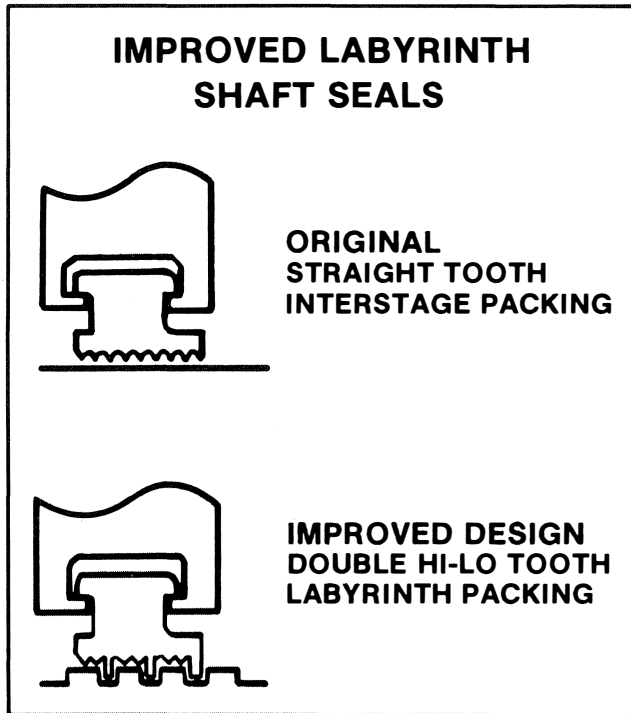

Figure 13. Improved Labyrinth Shaft Seals.

Spill Strips

Interstage packing leakage flow can either pass through the stage steam balance hole, or enter the main steam flow at the bucket root. As shown in Figure 14, under certain opera-

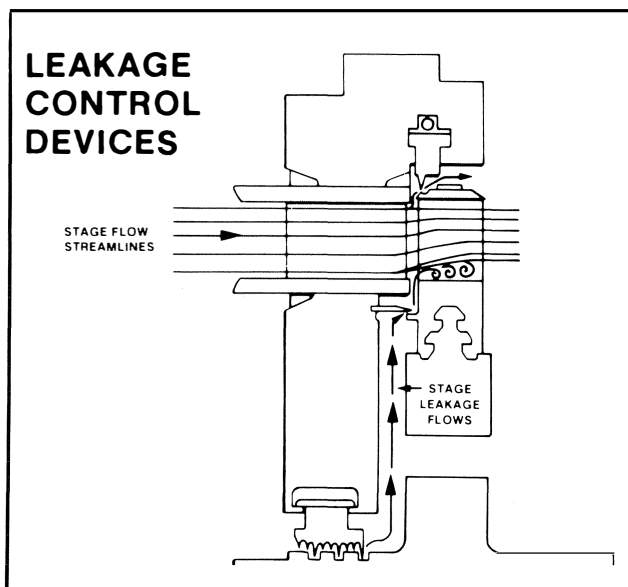

Figure 14. Leakage Control Devices.

ting conditions, stage leakage flows can be supplemented by steam drawn upstream through the rotor steam balance holes. This combined leakage, having a reduced available energy resulting from the dissipating action of the high-low teeth and an extremely small axial component of velocity, must, upon re-entering the steam path, be accelerated by extracting energy from the high velocity main stream jet. Low energy leakage steam re-entering the steam path had the compounding effect of aggravating the total leakage loss by disrupting the normal velocity distribution of the main flow path in the vicinity of the blade root. This flow disruption could result in losses up to 50 percent greater than the energy originally lost to leakage flow.

In order to reduce these losses, selected stages were fitted with improved design spill strips to prevent steam flow from bypassing the flow path. As illustrated in Figure 14, the double hook tip spill band reduced leakage flow by providing a close clearance seal between the bucket band and spill strip sealing surface. Spill strips offer the most significant benefits on short height, high pressure stage leakage control.

PERFORMANCE IMPROVEMENT HARDWARE ASSESSMENT AND VERIFICATION

Performance improvements arising from the development of the new features described herein, or the optimization of steam path design based on a more precise understanding of loss mechanisms, should be substantiated by tests conducted in the laboratory and by factory or field tests on production units. Laboratory tests are generally the first step in the development of a new concept and have the advantage of being carried out under carefully controlled conditions on hardware which can be modified in a stepwise fashion. On the other hand, factory or field performance tests provide an opportunity to determine the total contribution of a number of performance features, at rated steam conditions. Therefore, both steps are considered essential to the establishment of reliable performance quotations.

Laboratory Tests

The aerodynamic tests performed encompassed a wide range of activities. Individual component testing was normally done in stationary test cells, although similar results could also be obtained in rotating single stage rigs by isolating the efficiency impact of a flow path design feature through subsequent stage modifications. Base stage efficiency and incremental efficiency gains were established in the single stage facilities.

Aerodynamic testing offered some very significant advantages. Research programs provided detailed performance and design parameters and other information for a wide range of conditions. Such projects normally have relatively short time cycles. The efficient handling of model construction, coupled with a modern (computer aided) data acquisition and reduction system produced quick results. The accuracy and repeatability of the test data was very good. A simple power supply and working fluid system assured the effective maintaining of steady state conditions. Since the working fluid (air) had low thermodynamic inertia, quick changeover to other test parameters was possible in all cases.

The data developed from aerodynamic tests can be converted to steam application. Dynamic similarity exists, if several conditions are satisfied. Velocity ratio, Mach number, ratio of specific heats and Reynolds number for the prototype and the model have to be equivalent. The size of the model, rotational speed and other test conditions are controlled very carefully in order to adhere to the specified requirements.

The experimental data was then introduced into the design process. Performance of new design features was carefully evaluated and presented as a function of the pertinent design and operational parameters. The main body of the analyzed data was normally incorporated in the method developed to predict stage and overall turbine efficiency.

The primary objective of the aerodynamic test program was the verification of component and turbine stage performance gain due to design optimization and development of new efficiency features. Prior to the actual testing, a detailed analysis was made in order to establish the incremental efficiency gain attributable to a specific flow path component and/or stage design optimization. Recent advances in developing three dimensional codes provided the means for modelling a flow process around a specific design feature quite accurately. Improvements in stage analysis codes allowed for a very comprehensive evaluation of stage efficiency vibration due to design features and parameters.

Verification of the performance level of new nozzle and bucket profiles, as well as stage leakage control features and flow guidance and distribution components, was carried out in pressure test cells. Overall stage efficiency was established on special single stage rigs.

Test Facilities and Instrumentation

The two test programs under consideration were carried out in a transonic turbine facility (Figure 15). Compressed air was supplied by two compressors which could be run in parallel or in series. The latter mode allowed for a wide range of pressure ratios (up to 5.0:1, approximately). Air flow was measured by calibrated flow nozzles in a selective mode in order to enhance accuracy. High precision resistive temperature detectors (RTDs) and pressure transducers connected to total and static pressure sensors measured temperatures and pressures upstream and downstream of the flow nozzles and the test stage. Additional measurements of static pressure were taken at the nozzles trailing edge plane (root and tip), at the downstream face of the test diaphragm (root and tip) and in the space between the diaphragm and the test wheel. Radial traversing downstream of the test stage, in order to measure total pressure, static pressure and flow angle in the flow field at the stage exit plane, was conducted frequently.

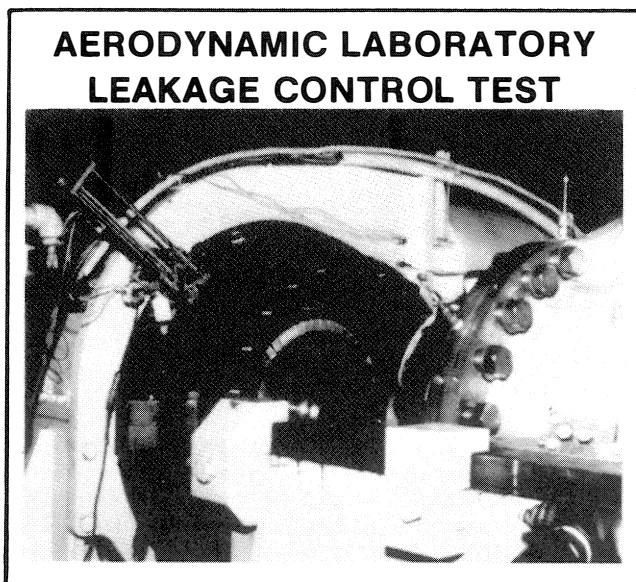

Figure 15. Aerodynamic Leakage Control Test.

Stage output was measured by utilizing the output of a torque meter. In order to improve the accuracy and consistency of the key parameter, alternative acquisition of the power generated by the test stage was carried out. RTDs installed in the exhaust pipe measured the stage exhaust temperature which, in conjunction with the other stage pressure and temperature measurements, provided the information needed to acquire the enthalpy drop efficiency. The third method of establishing stage output was through measurements of the cooling flow and inlet and outlet temperatures of the water-brake dynamometer which is used to dissipate the energy generated by the stage. The data produced the heat rejected to the cooling water in the brake. To this value the mechanical loss of the stage was added in order to get the total output. The mechanical loss was established through special tests conducted in the facilities prior to the performance test series.

Calibration of all key instrumentation was carried out prior to and after each major test series. This helped in achieving high overall stage efficiency accuracy. Repeatability of the efficiency test results were also within strict tolerance limits.

Factory Performance Tests

Performance tests of turbines and compressors at the manufacturer's facility can be beneficial. A turbine unit on a factory test stand is shown in Figure 16. The purposes of such tests are twofold: to provide final verification of the performance improvement of the new features, and to calibrate the thermodynamic calculation system used for performance prediction of new and uprated or re-rated units. In addition, performance tests are conducted to establish performance levels guaranteed by contract to customers.

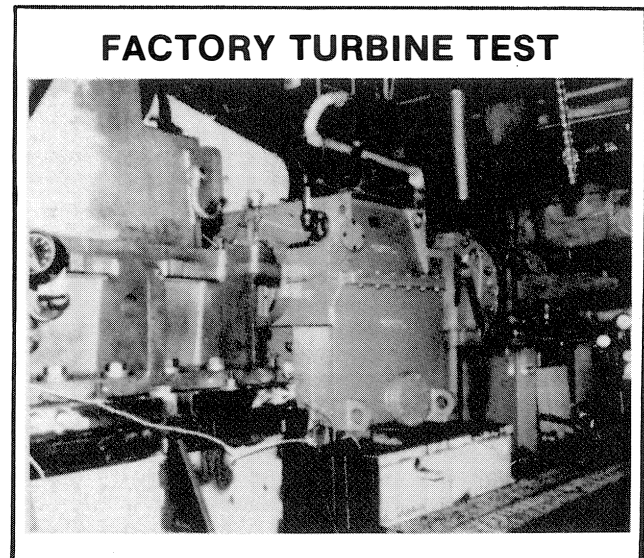

Figure 16. Factory Turbine Test.

The type of factory test conducted depends on whether the unit is condensing or non-condensing. The latter types are the least complex, because a reliable measure of steam path performance may be obtained from temperature and pressure measurements at the inlet and the exhaust which defines the theoretical and actual energy utilized by the turbine. The enthalpy drop efficiency thus obtained must be adjusted for bearing and end packing leakage losses in order to obtain the overall unit efficiency. A more elaborate method is required for

condensing turbines in which direct measurement is made of load and flow. Both test procedures require careful attention to detail in order to minimize uncertainties and error. A necessary step in ensuring the accuracy of the result is the comparison of data which relates to the same critical measurements, e.g., flow. In order to have confidence that the throttle flow used in the computation of the steam rate for condensing turbines is accurate, the flow measurement must be compared with correlations involving the first stage shell pressure and the control valve lift. Reasonable agreement between the three direct and indirect flow indicators can be expected in an accurate test.

Recent Test Experience

A variety of production units, including condensing and non-condensing types for both mechanical drive and turbine generator sets, have been shop tested in recent years. A brief description of each unit, the type of test and the test margin relative to predicted or guaranteed performance is given in Table 1. In all cases the performance test result met or exceeded expectations.

A test schematic for a factory performance test of an automatic extraction, condensing turbine is depicted in Figure 17. Such tests are necessarily complex, particularly in the data handling requirement, but well justified from the perspective of accurate performance prediction. In order to effectively handle large quantities of data, a computer dedicated to test data acquisition and reduction should be part of the facility.

ONSITE RETROFIT

All of the original equipment manufacturer's (OEM) efforts to design, manufacture, and test new efficiency features are meaningless without careful consideration to the needs of the users. Success in the retrofit of a turbine can be achieved by a close examination of the needs of the user and the

capabilities of the manufacturer. In the conversion described herein, several iterations were made between the manufacturer and the user, to arrive at the best improvement possible to the steam turbine and to meet the balance of plant operations requirements.

The turbine is a 650 psig, 700°F steam inlet condensing design which was modified to a 15 psig admission design with several of the improved efficiency features which have been described.

Balance of Plant Considerations

The entire basis for this conversion project was an abundance of low pressure steam that was not being used efficiently. This steam varied in pressure slightly but averaged 15 psig. The amount of steam varied with process changes from 0 to 20,000 lb/hr.

Power recovery by admission into a condensing steam turbine was decided to be the most effective use of this low pressure steam. The major benefit of admission was the total flexibility it offered. The turbine could use all the low pressure steam available, at any time, regardless of variations in the flow.

Many other ideas were considered for using the 15 psig excess steam, but the other devices considered used constant steam flows and could not accommodate the variations in the amount of 15 psig steam available. Their lack of flexibility was the main reason the turbine conversion to admission was selected.

The turbine selected for the conversion (9 stage condensing turbine shown in Figure 18) was purchased and installed in 1969 to drive a single stage overhung centrifugal compressor. Originally it was rated to deliver 7950 hp at 5925 rpm using 62,500 lb/hr of 650 psig inlet steam exhausting into a condenser at 4 in Hg absolute. Although provision was made in the original design for extraction at approximately 15 psig by placing an extraction nozzle in the turbine casing, the ex-

Table 1. Recent Shop Performance Testing

Turbine Application	Max Rating HP	RPM	Turbine Type	Test Methods	Margin Above Guarantee	Comments
Syn Fuels-Air Blower	8650	11760	Non-Condensing 2 Stages	Enthalpy Drop	+ 1.0%	Simulated Conditions at Valve Points
Ethylene-Ethylene Compressor	7857	8170	Non-Condensing 2 Stages	Enthalpy Drop	+ 0.2%	Simulated Conditions at Valve Points
Power Station-Boiler Feed Pump	8150	5240	Condensing 7 Stages	Load Flow Load by Torquemeter Flow by Weigh Tanks	+ 0.3%	Approx. Design Conditions at Guarantee Load
Marine-Geared Generator	3353	10059/1200	Condensing 7 Stages	Load Flow Electrical Load Weigh Tanks	+ 5.1%	Approx. Design Conditions at Guarantee Load
Ethylene-Cracked Gas Compressor	36883	5434	Condensing Extraction 10 Stages	Enthalpy Drop Torquemeter	+ 1.1%	Simulated Conditions Flow at Guarantee Point Valve Position

traction feature was not used when the turbine was installed. Initial discussions between the manufacturer and the user to retrofit this turbine began in December 1982.

Steam Path Design Alternatives

The original manufacturer's proposal was solely to improve turbine efficiency by the installation of new blade designs on several stages and other steam path improvements. This proposal could not be economically justified by itself. It was recalled that the turbine had a 15 psig extraction nozzle that was not being used. A new proposal to convert the turbine to an uncontrolled admission design to further increase the

possible savings of 650 psig inlet steam was requested. The second proposal was evaluated and found to be economically viable.

The acceptable proposal was complicated by a problem that existed with the turbine and compressor at the time the proposals were made. Careful measurement of steam flow rates showed the turbine to be using approximately 15 percent more steam than it was designed to use. The 15 percent number was obtained by calculating compressor horsepower using flow, pressure rise and temperature rise across the compressor. Because of the inherently small temperature rise across the compressor, approximately 50°F, the calculated horsepower

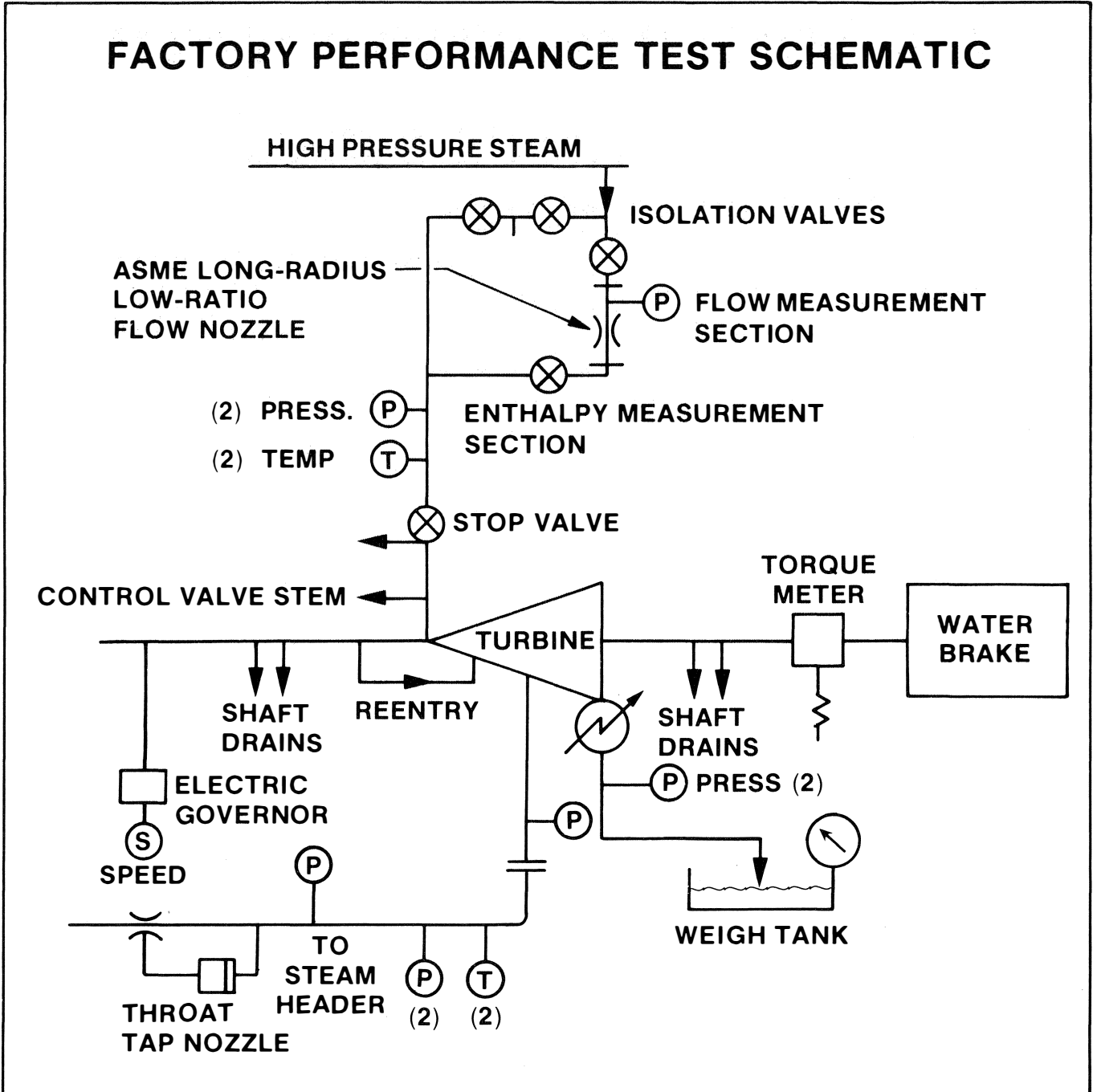

Figure 17. Factory Performance Test Schematic.

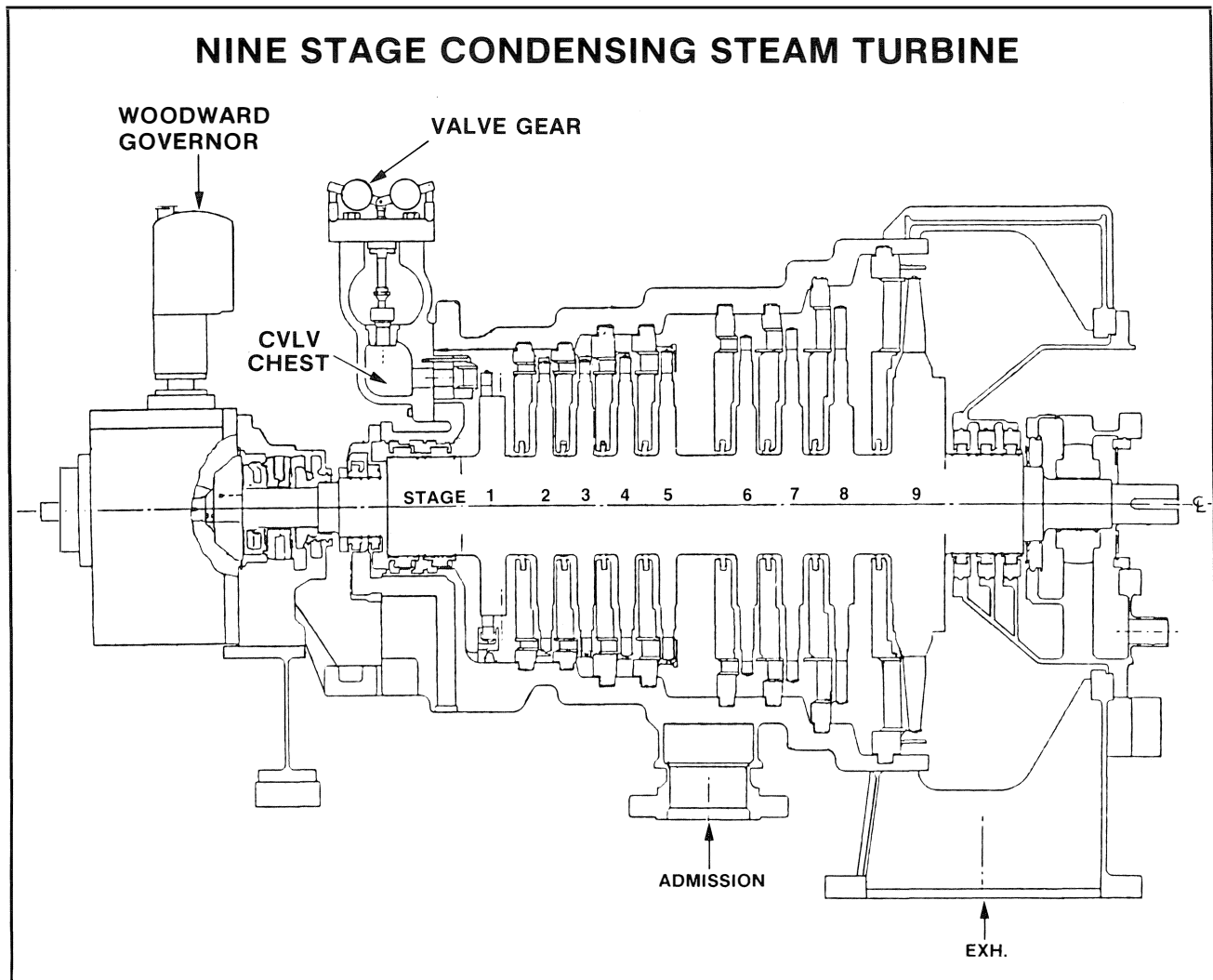

Figure 18. Nine Stage Condensing Steam Turbine.

was extremely sensitive to small variations in the measured differential temperatures. Small errors in temperature measurement, 2°F to 3°F, translated into a significant error in horsepower calculated. Measurement accuracy was not good enough to determine if the turbine was using 15 percent extra steam, or if the compressor was actually requiring 15 percent more horsepower than it was originally designed to use, or some combination of both.

To be safe, the decision was made to have the turbine sized for the worst case, an actual increase in driver horsepower of 15 percent. This resulted in new design conditions of 9500 hp at 6000 rpm by using 20,000 lb/hr of 15 psig admission steam. A savings of 8000 lb/hr or 650 psig inlet steam brought about by using 20,000 lb/hr of 15 psig admission steam was predicted.

All of the rotor modifications were to be done to the spare rotor. This is a key point, since the modified rotor would be completed and ready to install before the shutdown of the unit for maintenance. All other pieces supplied by the OEM were to be on-site before the machine was shut down.

The final proposal addressed several areas of the turbine. The condensing end did not have enough flow area to accommodate an additional 20,000 lb/hr. It would be modified by installing new blades on the seventh stage and by installing

new seventh and eighth stage diaphragms. Additionally, the sixth row of blades would be removed along with the sixth stage diaphragm. These conversions would allow room for efficient utilization of the additional 20,000 lb/hr of 15 psig steam.

The new mode of operation would be with continuous admission. The front section of the turbine would be operating with less 650 psig steam than before. One stipulation of the conversion was that full horsepower of the original 1969 design would have to be achieved *without* admission even though this was not the forecasted mode of operation. The front section of the steam path of the turbine was optimized in order to improve efficiency.

Due to the lower 650 psig steam flow rates, new smaller third stage blades as well as a new smaller nozzle plate were used. New second and third stage diaphragms were also specified. These modifications were to improve efficiency with the new reduced flow rates of 650 psig steam. These changes point out the importance of looking at the *expected* operating conditions, in addition to the design point or maximum operating conditions.

Control System Modifications

While the major changes were in blades and diaphragms,

several other changes and modifications were required to make the conversion a success.

The control scheme was very important because it allowed the turbine to use whatever excess steam was available and still maintain constant speed. Basically, an uncontrolled 15 psig admission was utilized. The inlet controls made up for whatever contribution the 15 psig steam had on speed. For example, if the admission steam suddenly increased in flow, the inlet control rack would close off proportionally to reduce the flow-rate of the 650 psig steam into the turbine, thus maintaining constant speed. Conversely, if the quantity of 15 psig admission steam decreased, the inlet control rack would open to pass more 650 psig steam, thus maintaining constant speed.

The speed control on the turbine is a governor that actuates a remote actuator which is assisted by a hydraulic operating cylinder on a bar lift valve system. The main modification to the existing control system was to change the inlet valves in order to obtain the proper size and opening sequence required for accurate speed control. All five valves (plugs and seats) necessary for conversion were provided.

Although the speed control system changed very little, with the exception of the valves, there were major modifications made to the overspeed trip protection system (Figure 19). Two levels of protection for the trip system on the new 15 psig admission line were recommended. After some internal discussion, it was agreed that utilizing two levels of protection was a good idea. This was analogous to the trip valve and governor rack on the 650 psig inlet steam. Since the 15 psig steam was not being controlled, two trip valves were installed in the 15 psig admission line, at the turbine casing. Naturally, both steam supply sources (650 psig and 15 psig) have to be shut off simultaneously on a trip signal. This brought about the requirement for additional hydraulic piping to tie all trip valves together so they could be tripped from one common signal.

Before the conversion, the tachometer signal to the control room was taken from a gear inside the governor. A 60 tooth gear was machined so that it was integral with the mechanical trip assembly mounted on the shaft of the rotor being modified. This 60 tooth gear was designed for use with an electronic tachometer, which was connected to the new electronic overspeed system installed during the shutdown. With the new electronic system, there were two independent ways (mechanical and electronic) to actuate the trip sequence.

Other maintenance type work was performed, due to problems existing on the spare rotor that was used. Damage to the low pressure journal was repaired by machining the journal undersize. New bearings were also made for both high and low pressure journals.

Delivery Considerations

The technical modifications were agreed upon and both parties were confident the conversion could be successfully achieved. On the user's part, there was great concern about the manufacturer's ability to fabricate the necessary hardware and modify the spare rotor in the short time available. The shutdown during the month of November 1983 would be the absolute last opportunity to make this conversion a profitable one. After much discussion, a contract was placed with the manufacturer in September 1983 for delivery of the converted rotor and all associated hardware by the first of November 1983, one week prior to the planned shutdown.

Both companies realized the importance of communication and team work in order to make the delivery dates required. Weekly trips were scheduled to check the progress and to assure that all questions were being answered promptly. Inspection trips were also made to check on the progress of the other major equipment being manufactured for this con-

version. Communication and project status were given top priority by all parties.

Conversion Planning

A project engineer was assigned to the job of obtaining funds approval, organizing the scope of work involved with the conversion activities, and merging this work into the planned maintenance activity already known to be required on the turbine and compressor. This engineer then formed a quality action team made up of knowledgeable individuals who would be involved with the job. The individuals selected were from project engineering, maintenance engineering, maintenance supervision, and instrument maintenance.

The first action of the combined team was to completely review the planned scope of maintenance activity required on the turbine and compressor, which was quite extensive. This happened to be a major inspection which required turbine disassembly for such things as magnetic particle inspection, etc.

The team identified their goals and the output needed to attain them. Agreement was reached on the level of detailed planning needed to accomplish a successful conversion. The various planning schedules that could be generated and the timing for issuing these schedules were decided.

The scope of modifications required for the 15 psig steam admission conversion was discussed until all members were familiar with the work required. The next step was to merge the planned maintenance activity with the conversion work. In order to do this, the overall job was analyzed in a chronological fashion.

A brainstorming session focused on anything that would conceivably delay the conversion. From this lengthy list, a condensed list was assimilated. The condensed list contained many items that historically have prolonged shutdown and caused inferior work to be performed. An action plan for each of the potential problems on the list was developed along with the timing needed to complete the action list. Among the most important items were conflicts with other work during the shutdown, possible transit damage to the modified turbine rotor and diaphragms, acceptability of the modified spare rotor and associated parts, and readiness of compressor and turbine spare rotors.

After all the work had been planned, an estimate of the time required to do the job was made. A critical path schedule was made and issues to everyone associated with the shutdown. Another schedule was made for team use showing the various action plans and necessary completion dates. These two schedules were the control documents used to assure timely completion of the job.

Shutdown and Conversion Results

The actual shutdown began on November 14, 1983. All of the parts purchased from the manufacturer were on site, including the completely modified spare rotor. Pre-shutdown planning also accounted for all foreseeable safety permits being obtained as well as all tags for tagging out of equipment being made.

A manufacturer's field service representative was used on this job because of the scope of the modifications involved. From the very outset, the job went as planned with only minor schedule modifications required.

When the turbine casing top half was lifted, the reason for the 15 percent excess steam usage was discovered. There were deposits on the blades of wheels five, six and seven, with especially heavy deposits on the sixth and seventh stage diaphragms. Considerable steam flow area was lost due to the

OVERSPEED TRIP SYSTEM MODIFICATIONS

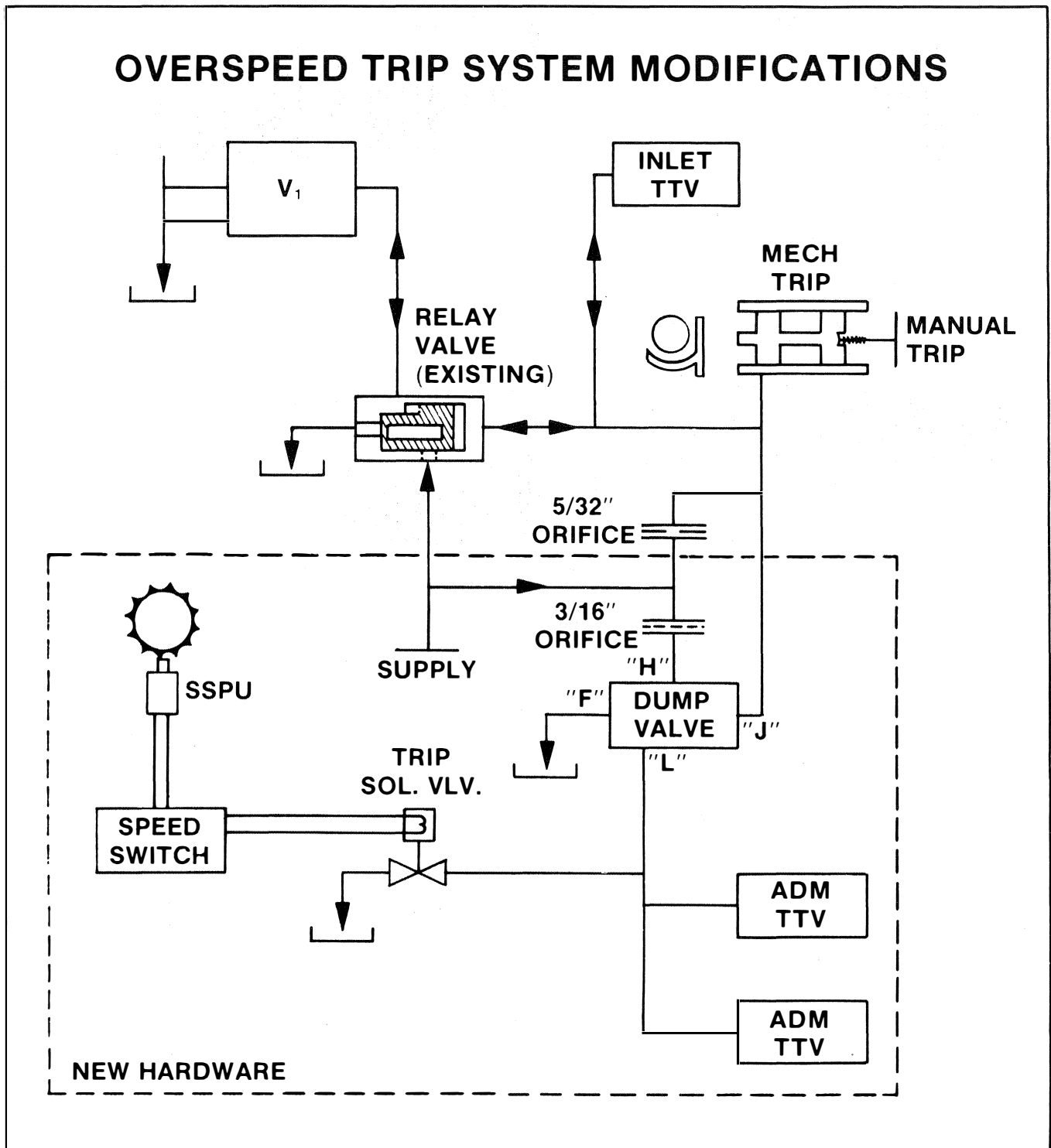

Figure 19. Overspeed Trip System Modifications.

steam flow path area being covered by the deposits. The surface roughness of the deposits also contributed to flow disturbances and efficiency losses. Nothing was found in the compressor that would indicate an efficiency problem. From this it was concluded that the entire problem of excessive steam usage resulted from deposits on the turbine blades and diaphragms.

As the shutdown progressed, two major areas of maintenance work became apparent. The top half of the turbine

casing at the exhaust hood had severe erosion in a very localized area. Instead of sending the turbine casing out of the plant, weld repairs were made and the welds were hand filed and dressed down to the surrounding metal. Solving this problem in the plant saved considerable time.

The second problem was more serious. The buildup of the material previously mentioned that affected turbine efficiency was iron oxide. Severe corrosion (iron oxide) had occurred and the by-products of corrosion had packed themselves tightly

behind the sealing surface of the back side of the eighth stage diaphragm. After sandblasting the lower and upper halves of the casing, the damage to the casing at the number eight diaphragm fit became apparent. A field machining crew was called to machine the case back to solid metal in the corroded area. Approximately 0.060 in was removed from the original surface of the casing (both top and bottom halves). The eighth stage diaphragm was built by weld metal on the sealing surface of the diaphragm and machined so that a total of 0.060 in was added to its original thickness. This repositioned the diaphragm for proper blade clearance of this stage.

Other minor delays resulted from problems with setting the mechanical overspeed trip at the proper speed. Basically, the conversion was finished in the planned amount of time which included the major unforeseen work on the casing and diaphragm.

Startup

The startup was very smooth. The vibration recorded by the proximity probes at the operating speed was less than 0.5 mils when the slow roll runout was subtracted. Data collected after the conversion shows that significant gains were realized in steam savings. The source of the 15 percent excess steam usage was eliminated by removal of the deposits on the rotor and diaphragms. In addition, the modifications for efficiency to the nozzle block, second and third stage diaphragms and third stage wheel have accounted for 3600 lb/hr savings of 650 psig steam at normal operating conditions. Average consumption of 15 psig admission steam was found to be 14,000 lb/hr. As a result, a savings of approximately 6000 lb/hr of 650 psig steam was realized.

Since the conversion, the actual savings during normal operating conditions have exceeded the anticipated results. Less admission steam is being used than was anticipated, but savings due to efficiency upgrades in the first, second and third stages are more than anticipated. Payback on the capital invested should be quicker than expected.

CONCLUSION

The conversion is estimated to be a complete success. Not only was the large amount of conversion work accomplished within very short time constraints, but the steam savings have exceeded expectations. Several important steps were taken that helped ensure this success. These included buying quality equipment, good communication between vendor and supplier, and concise planning. From an installation standpoint, the quality action team that involved *everyone* in the planning stages was very helpful in educating people about the conversion before it actually took place.

Based on the success of this conversion and the flexibility afforded in the steam balancing throughout the plant, other applications, where admission turbines would allow the effective use of other sources of excess low pressure steam, are being pursued.

ACKNOWLEDGEMENT

We would like to thank Ron Bedard of General Electric Company and Ken Fisher of Celanese Chemical Company and the entire Celanese quality action team involved in this conversion for a true team effort in completing this conversion successfully.

