

SUBSYNCHRONOUS VIBRATION PROBLEM AND SOLUTION IN MULTISTAGE CENTRIFUGAL COMPRESSOR

by

Paul E. Allaire

Professor

Mechanical and Aerospace Engineering Department

University of Virginia

Charlottesville, Virginia

Carroll G. (Chet) Stroh

Mechanical Consultant

Engineering Services Division

E. I. duPont de Nemours and Company, Incorporated

Newark, Delaware

Ronald D. Flack

Professor

John A. Kocur Jr.

and

Lloyd E. Barrett

Associate Professor

Mechanical and Aerospace Engineering Department

University of Virginia

Charlottesville, Virginia



Paul E. Allaire is Professor of Mechanical Engineering at the University of Virginia. He received his B.E. and M.E. degrees from Yale, in Mechanical Engineering.

After two years in the Peace Corps, teaching at the Telecommunications Institute in Addis Ababa, Ethiopia, he earned his Ph.D. in Mechanical Engineering at Northwestern University. He is the founder of the Rotating Machinery and Controls (ROMAC) Industrial Research Program at

the University, which now has over 50 corporate members. In addition to writing one textbook on finite elements and editing three books, Dr. Allaire has presented over 80 papers at technical conferences and in journals.



Lloyd E. Barrett is an Associate Professor of Mechanical Engineering at the University of Virginia. He received an M.S. degree in 1975 and a Ph.D. degree in 1978, both from the University of Virginia. He has worked in the areas of turbomachine vibration and lubrication for 16 years. Special areas of interest include bearing design and optimization to reduce rotor vibrations and the effects of structures and foundations on turbomachinery vibration. He has

written over 40 papers in these areas and has been a consultant to industry on a wide variety of turbomachine vibration problems.

Dr. Barrett is currently the Director of the Rotating Machinery and Controls Industrial Research Program at the University of Virginia.



R. D. Flack received his B.S.M.E., M.S.M.E. and Ph.D. degrees from Purdue University, in 1970, 1973, and 1975, respectively. He was an Analytical Design Engineer for Pratt & Whitney Aircraft for two years, and is currently a Professor of Mechanical and Aerospace Engineering at the University of Virginia.

Dr. Flack performs research in experimental fluid film bearings and internal turbomachinery flows and is active in several professional societies, including ASME, ASLE, and ASEE.

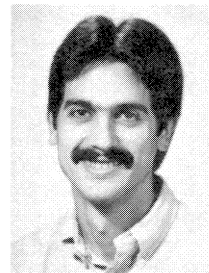

John A. Kocur, Jr., is a Research Engineer at the Amoco Corporation Research Center in Naperville, Illinois. In this capacity, he conducts applied research in the areas of machinery vibration analysis, rotor bearing system dynamics and computational fluids. He also acts as a consultant to the refineries, chemical plants and production facilities of the Amoco subsidiaries, both domestic and foreign.

Mr. Kocur has B.S.M.E. and M.S.M.E. degrees from the University of Virginia and an MBA from Tulane

University. He is currently finishing requirements for a Ph.D., from the University of Virginia. The dissertation research involves a finite element analysis of three dimensional viscous fluid flow in bounded regions. He has co-authored papers on hydrostatic bearing analysis, oil seal/rotor interactions, and numerical methods for accurately evaluating dynamic coefficients for hydrodynamic bearings. He is a member of ASME.

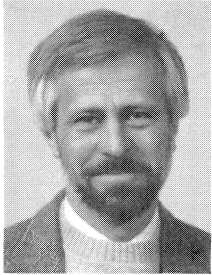

Carroll G. (Chet) Stroh is a Consultant with E.I. du Pont de Nemours and Company, Incorporated. He is assigned to the Mechanical Engineering Consultants of the Engineering Service Division. His consulting service involves turbomachinery and reciprocating compressor analysis, repair, and specification. He has 13 years with Du Pont, during which he spent five years in a regional engineering office at Beaumont, Texas, consulting on turbomachinery problems for Du Pont plants along the Gulf Coast, three years in turbomachinery rotordynamics research at the Experimental Station in Wilmington, Delaware, and five years at his present position in Newark, Delaware.

Prior to joining Du Pont, Mr. Stroh worked four years for the Westinghouse Large Steam Turbine Division in Lester, Pennsylvania, where he was involved with the design of rotors and blades. He earned a B.S. degree, M.S. degree, and did three years of post graduate work in Mechanical Engineering at the University of Pennsylvania. He also has a B.A. degree in Mathematics from Lebanon Valley College. He is a member of Tau Beta Pi.

ABSTRACT

The investigation of a subsynchronous vibration problem encountered in a six stage centrifugal compressor is discussed. At a running speed of approximately 9000 rpm, a subsynchronous vibration (at 4200 rpm) of nearly two times the synchronous vibration level was encountered. A systematic program was undertaken to identify the problem and correct it. A detailed analysis of the floating ring annular oil seals, balance piston labyrinth seals and impeller aerodynamic cross coupling was conducted. The oil seals were identified as the primary cause of the subsynchronous vibration due to lock up, and a modified seal design incorporating circumferential grooves was developed. This radically reduced the seal cross coupled stiffness. Further, a modified bearing design was investigated to increase the rotor logarithmic decrement. Changes were implemented in the compressor with the result of no subsynchronous vibrations for the operating conditions of the compressor thus far.

INTRODUCTION

High speed multistage compressors are often subject to unwanted vibrations. Particularly undesirable are subsynchronous vibrations, which may increase suddenly, or over a long period of time. Often the subsynchronous vibration is larger than the synchronous component and may limit machine safe running speeds. In addition, compressors have failed as a result of subsynchronous vibrations. It is best to remove these vibrations, if possible.

Often the cause of the subsynchronous vibration is not well understood at the onset of the problem [1]. Several possible

causes have been identified in recent years: 1) fixed pad bearings, 2) annular oil seals, 3) balance piston labyrinth seals, and 4) impeller aerodynamic effects. In many cases, two or more of these are present.

A systematic rotordynamics analysis was undertaken to identify and correct the problem in a particular compressor. The compressor (Figure 1) was a six stage centrifugal compressor with an average shaft diameter of approximately 6.25 in, bearing span of 67.8 in, rotor weight of 1600 lb, and design speed of 9600 rpm. The compressor rotor and the key components are illustrated in Figure 2.

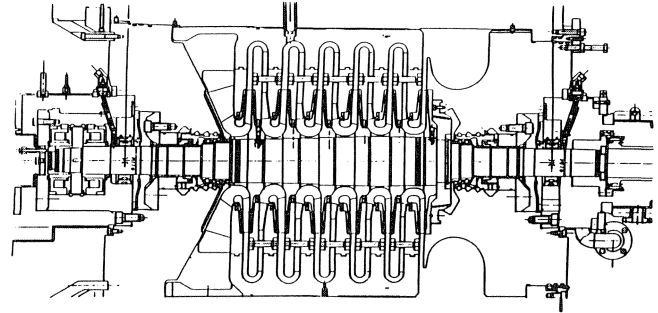

Figure 1. Geometry of Six-Stage Centrifugal Compressor.

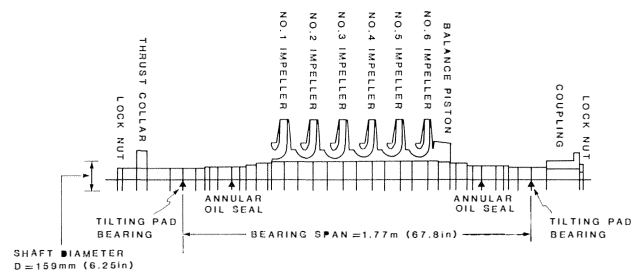

Figure 2. Shaft Parameters and Geometry for Six-Stage Compressor.

The rotor was supported on five-pad tilting pad bearings with load-on-pad orientation. The bearing clearance was 3.0 mils (radial) and the bearings had a preload of 0.5. The length to diameter ratio was 0.45. The bearing stiffness and damping coefficients at 9000 rpm [2] are given in Table 1. It is well known that tilting pad bearings will not cause subsynchronous vibrations by themselves but may or may not have the damping required to suppress other causes of instability [3].

Table 1. Tilting Pad Bearing Properties at 9000 RMP.

K_{xx} (lb/in)	798877
K_{yy} (lb/in)	1043827
C_{xx} (lb-sec/in)	979
C_{yy} (lb-sec/in)	1134
e/C_b	0.235
Load (lb)	809

At a running speed of approximately 9000 rpm, a large subsynchronous vibration (at 4200 rpm) of nearly two times the synchronous vibration level was encountered [4]. The vibration pattern is shown in Figure 3 at a continuous running speed of 9210 rpm. The subsynchronous vibration persisted at modest levels when operating below 9200 rpm, but would suddenly spike when operating at or above this speed, requiring im-

mediate operational changes. Service was limited to below 9200 rpm for fear of larger vibration spikes at higher speeds.

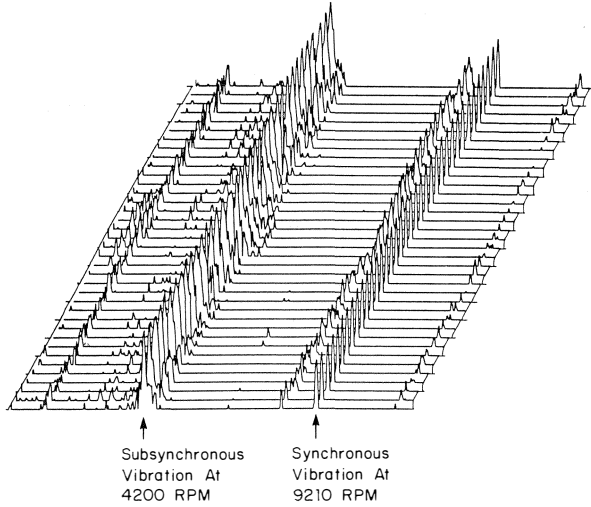

Figure 3. Vibration Pattern at 9210 RPM.

With the plant running, it was not considered economically feasible to shut the compressor down for investigation of possible fixes. Thus a rotordynamics analysis was performed to determine the problem and its solution. The compressor shaft and impellers, bearings, floating annular oil seals, balance piston labyrinth seals, and impeller aerodynamics were included in the computer model. A logarithmic decrement was evaluated for possible mechanisms causing the subsynchronous vibration, on a relative basis. On this basis, the oil seals were identified as the primary cause. The seals were modified to reduce excitation, and the bearings were also modified to increase the rotor damping properties. After installation, the compressor had no subsynchronous vibration up to the operating pressures attained so far. These levels are not quite up to the peak pressures possible with this compressor.

UNDAMPED CRITICAL SPEEDS

The rotor was modelled using standard transfer matrix methods. Undamped critical speeds were obtained and are shown in Figure 4. Four critical speeds are shown on the figure. The horizontal and vertical tilting pad bearing stiffnesses are shown on the critical speed map as well. It can be seen from

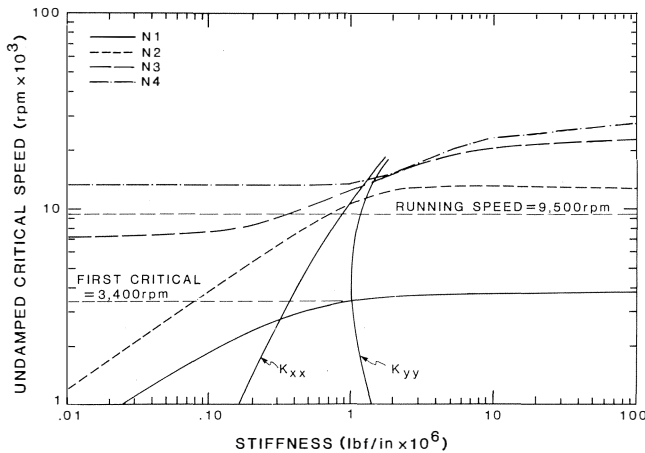

Figure 4. Undamped Critical Speed Map.

Figure 4 that the rotor is running above the first critical speed but just below the second, third and fourth. There was some worry that softening the bearings to improve machine stability might lower the second or third critical speed too near the operating speed of 9600 rpm. The measured rotor response at one of the bearings for probe horizontal and probe vertical is shown in Figure 5. The predicted vertical critical speed of 3400 rpm (from Figure 4) is about nine percent below the measured values of 3700 and 3800 rpm.

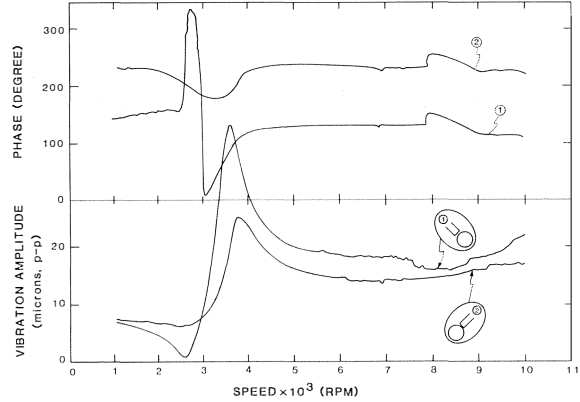
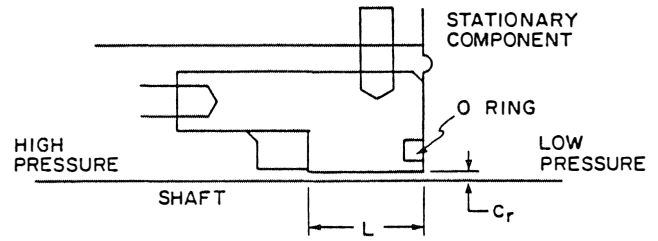

Figure 5. Measured First Critical Speed.

OIL SEAL ANALYSIS

A summary of the oil seal analysis by Allaire, Kocur, and Stroh [4] follows. The oil seal in this compressor has a seal ring around the shaft, as shown in Figure 6. The seal ring minimizes the leakage of the process gas into the atmosphere.



(a) Seal Ring Geometry

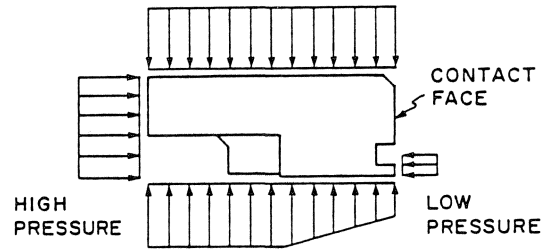

(b) Pressure Forces Acting On Seal Ring

Figure 6. Seal Ring Geometry and Pressure Forces.

The ring is a nonrotating component normally designed to float (move radially) with the shaft to prevent unbalanced forces in the seal ring annulus. To seal, such seal rings must have a contact face (Figure 6b), which inhibits this floating motion. High pressure, also shown in Figure 6b, creates a normal force acting on the contact face. This is related to the friction force

acting along the contact face by the coefficient of friction times the normal force. If the friction force is large enough, the ring will not move radially. The oil film between the shaft and locked-up seal ring then acts as a fixed plain journal bearing.

A plain journal bearing produces cross coupled stiffness terms, K_{yx} and K_{xy} , which can cause rotor instability [3]. Ordinarily, the axial pressure drop across the seal suppresses any possible cavitation in the oil film for the seal. It may be considered as a noncavitating plain journal bearing which further increases the destabiling effects.

Two papers by Kirk, et al. [5, 6], discuss the properties of locked-up oil seal rings. These works are extended by Kirk's 1986 paper [7] which includes plots of seal ring stiffness and damping coefficients vs eccentricity for short seals. The cross coupled stiffness coefficient of the seal ring can grow by over a factor of ten in magnitude, with increasing lockup eccentricity. Kirk also shows some results for compressor modifications to the oil seals, but does not give details of the modifications.

Several other authors discuss oil seal effects on compressors. Doyle [8] and Wachel [9] presented papers at workshops. A paper by Emerick [10] describes a seal lockup problem caused by wear of a taper on one of the seal components. A redesigned seal removed the subsynchronous vibration problem from the multistage compressor. In that case, the seal ring was redesigned to be better balanced, thus reducing the friction forces tending to lock the ring against the stationary seal component.

A different effect of seal ring lockup was reported by Cerwinski, Nelson, and Salamone [11]. In this case, synchronous vibrations were the problem. A rotordynamic analysis indicated that seal ring lockup may have carried most or all of the shaft load. Because the seals are closer together than the bearings, a significant shift in critical speeds can be encountered. Elimination of radial looseness under the bearings ensured that the bearings carried the load and successful running was reported.

Allaire, et al. [4], presented a quasi-static method for estimating the lockup eccentricity of the seal ring. The steps are:

- At zero shaft speed, the shaft rests in the bottom of the bearings and the oil seal ring rests on the shaft. The geometry for the compressor seal is illustrated in Figure 7.

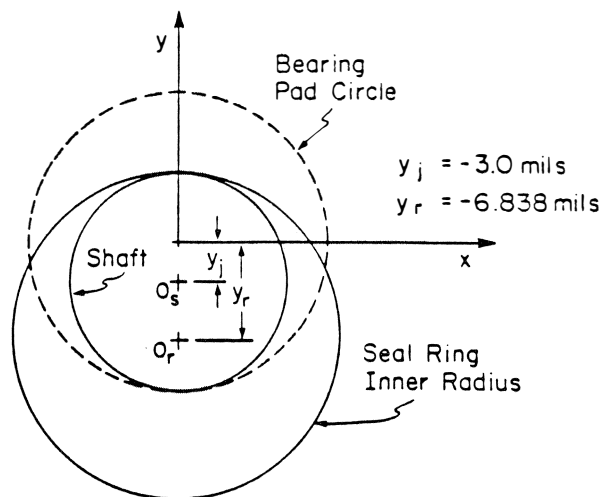

Figure 7. Bearing and Seal Ring Clearance Circle Plots at Zero Speed.

As the shaft speed increases, the oil film force lifts the seal ring so that the force must exactly equal the ring weight (if dynamic forces are small). The radial friction force on the ring contact face increases with speed as pressure builds. The point of interest is whether the friction force becomes large enough to

prevent further motion of the seal ring (lockup). The geometry for this seal is presented in Figure 8. If the ring locks, up it stays at the same position in space.

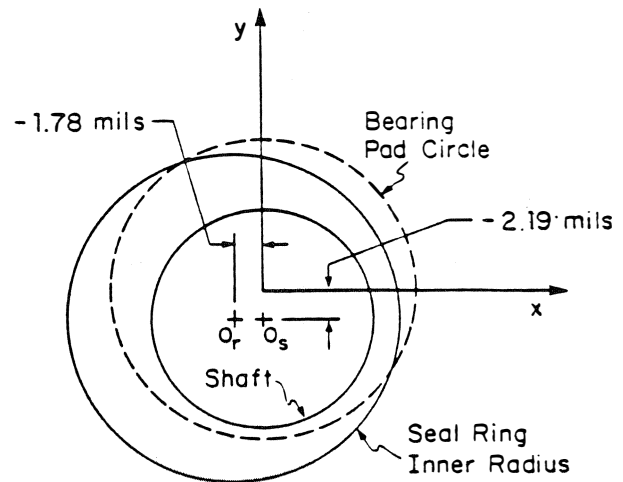

Figure 8. Bearing and Seal Ring Clearance Circle Plots at Lockup Speed (611 RPM).

- If the seal ring is locked up, continuing increases in shaft speed provide bearing forces which lift the shaft upward. This produces an oil seal ring eccentricity of the shaft within the oil seal ring (Figure 9). Generally, increasing the eccentricity causes higher oil seal ring cross coupled stiffness coefficients.

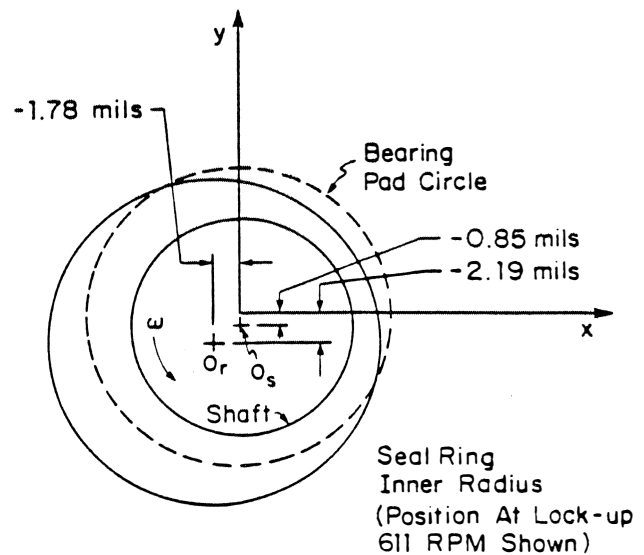

Figure 9. Bearing and Seal Ring Clearance Circle Plots at Instability Threshold Speed (9,000 RPM).

- Dynamic forces due to unbalance are always present on shafts and generally increase with speed. If the dynamic forces are large enough, a locked-up seal ring may break free and move with the shaft. This possibility must be explored to determine if the oil seal ring will stay locked-up. These steps can be investigated for a given seal design.

A lockup speed equation was developed in [4] as

$$N_{\text{lock}} = N_d \left(\frac{w_r}{\mu_s P_d A} \right)^{\frac{1}{n}} \quad (1)$$

The exact lockup speed is not very important. What is important is the likelihood of seal ring lockup below running speed. If it is likely to lock up well below running speed, then a stability analysis including the seal cross coupled effect, should be completed. If lockup is unlikely due to good seal ring balancing, then there will be no cross coupled stiffness terms and the seal is not going to cause subsynchronous vibration.

The reported seal ring analysis [4] indicated that the seal ring would be locked up at 611 rpm, which was far below the shaft running speed. Numerical values for the seal stiffness and damping coefficients at 9800 rpm are given in Table 2. The method used to calculate the seal dynamic coefficients is a finite element approach [12] which includes the effects of an axial pressure drop and turbulence. The axial pressure drop effects produce principal stiffness terms which may be important in the rotordynamics analysis.

Table 2. Summary of Seal Properties at 9,800 RPM with Attitude Angle -135° and Eccentricity 0.5

Seal Design	Load (lb)	Flow Rate (gal/min)	Stiffness (lb/in)				Damping (lbf-sec/in)			
			K_{xx}	K_{xy}	K_{yx}	K_{yy}	C_{xx}	C_{xy}	C_{yx}	C_{yy}
Existing	186	13.5	88200	109300	-109600	26000	213	61	61	215
Two Groove (1A)	92	12.8	46300	6680	-13910	41400	20	5	5	20
Three Groove (1B)	84	12.1	40500	1750	-9930	37900	11	3	3	11
Two Groove Large Clearance (1C)	46	21.6	50300	-360	-11800	48100	11	2	2	11

The cross coupled stiffness values are 109,300 lb/in. The calculated value of the oil leakage through the seal, 13.5 gal/min, was rather close to the average measured leakage, approximately 12 gal/min. This was one indication that a good model of the oil film was used.

Some information can be gained by comparing stiffness and damping numbers for the bearings and seals. In nearly all compressors, the bearings and oil seals are in close proximity. Principal stiffness terms of the original bearings, K_{xx} and K_{yy} , are on the order of 1,000,000 lb/in. The corresponding principal stiffness terms of the seals are only about 100,000 lb/in, so the bearing stiffnesses dominate. Conversely, the tilting pad bearings have no cross coupling stiffness terms, K_{yx} and K_{xy} , so here the oil seal terms dominate. The cross coupled stiffness terms cause subsynchronous vibration, so the seals are very important.

Also, the bearing principal damping terms, C_{xx} and C_{yy} , are much larger than the oil seal terms so the bearing damping terms dominate. This led to modifying the bearings to improve overall system damping properties after the seals were improved.

CAUSE OF INSTABILITY

Initially, the cause of the subsynchronous vibration was unclear. Suspected components were the oil seals, the balance piston labyrinth seals, and aerodynamic cross coupling at the compressor impellers. A systematic rotordynamics stability analysis was carried out to determine the cause. The objective was to evaluate the sensitivity of the compressor to each possible cause. This involved calculating the logarithmic decrement of the least stable eigenvalue for a series of analyses. The largest destabilizing change would indicate the primary cause.

First, a baseline run was made with the free-free shaft. The log decrement of 0.0, as it should be, is given in Table 3. The whirl speed of the least stable mode was 3070 rpm. Next, the tilting pad bearings were added and the log decrement improved to 0.19. The balance piston labyrinth seal cross coupling stiffness was calculated as 19,800 lb/in [13]. It was added to the model and the log decrement dropped to 0.14. Removing the balance piston and adding the locked up oil seal dynamic coefficients gave a log decrement of 0.09. Thus, the oil seal reduced the stability by 0.10, while the balance piston only reduced it by 0.05.

Table 3. Sensitivity of Current Design to Different Destabilizing Mechanisms at 9000 RPM.

	Logarithmic Decrement	
	δ	Whirl Speed (rpm)
Shaft Only (0.5×10^6 lb/in Supports)	0.00	3070
Shaft, Bearings	0.19	3555
Shaft, Bearings, Balance Piston (19.8 Klbf/in)	0.14	3550
Shaft, Bearings, Seals	0.09	3770
Shaft, Bearings, Seals, Balance Piston	0.006	3770
Shaft, Bearings, Seals, Balance Piston, Aerodynamic Cross Coupling at Wheels (10 Klbf/in)	-0.06	3780

The analysis was continued to include shaft, bearings, oil seals and balance piston. The log decrement was 0.006, or very close to zero. One should recall that the onset of the subsynchronous vibration, shown in Figure 3, must occur at a log decrement value of zero.

Finally, aerodynamic cross coupling was added at the compressor impellers. At the time the analysis was done, industrial experience indicated that a value of about 2,000 lb/in per wheel of cross coupling would be representative. In this case, a value of 2,000 lb/in was chosen for each of the four central impellers and 1,000 lb/in taken for the end impellers. The resulting log decrement was -0.06 for a decrease of 0.066 over the previous case. Again, this change was less than the oil seals. It was judged that the oil seal was the major cause of the subsynchronous vibration. The calculated whirl speed, indicated in Table 3, was 3780 rpm. This compares fairly well with the observed critical speed of 4200 rpm. The calculated whirl speed is low by 10 percent.

Currently, there are several methods for better evaluation of the compressor labyrinth seal effects, which seem to be primarily responsible for impeller aerodynamic cross coupling. That particular possible cause of instability did not turn out to be the major cause for this problem so no further efforts were made to better model them.

One particularly encouraging feature of the analysis was that the stability analysis yielded a logarithmic decrement very close to zero when all possible causes were included. This implies that the theoretical model created for this problem was a very accurate one. Component modelling for the shaft, bearings, oil seals and balance piston was obtained from the basic equations of engineering, rather than empirical field data. A few years ago, the computer modelling and solution of subsynchronous vibration problems in compressors was much more empirical in nature.

OIL SEAL MODIFICATIONS

Two possible objectives could be considered in modifying the seals. They were:

- Reduce seal cross coupling while maintaining present leakage rate.
- Ensure that the seal ring moves with the seal.

Initially, it was decided to investigate the first option. Design options with circumferential grooves cut in the seal are shown in Figure 10 (a) and (b). A pressure balancing arrangement for the three groove seal is also given in Figure 10 (c).

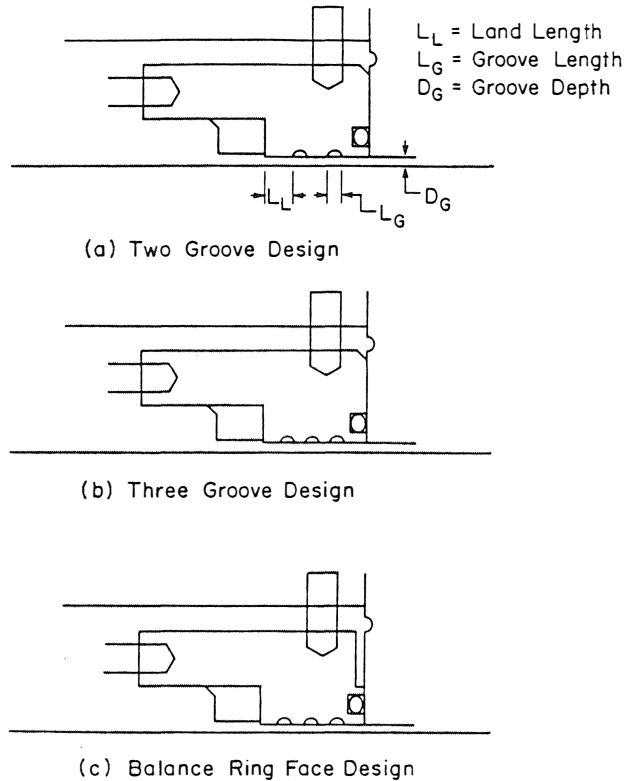

Figure 10. Geometry for Circumferential Groove and Balancing Seal Modifications.

Cutting circumferential grooves in the seal land region reduces the cross coupled stiffness. Generally, the cross coupled stiffness is proportional to the length, cubed. Introducing two grooves, as indicated in Figure 10 (a), reduces the length by a factor of 3, but triples the number of lands, so the net reduction in cross coupled stiffness is a factor of 9. In a similar fashion, the three groove design of Figure 10b yields a reduction factor of 16. The calculated values of locked up seal ring stiffness and damping are given in Table 1. A larger clearance case also reduced the cross coupled stiffness but the oil leakage rate nearly doubled. This was considered unacceptable.

Modifying the seals to improve the pressure balancing, and thus reduce the friction force acting on the seal contact face, was also considered. This would not affect the cross coupled stiffness directly, but would ensure that the seal ring could not lock up at a large eccentricity. The dynamic forces acting on the seal ring would move it toward the centered position. Thus, the very large cross coupled stiffness which occurs at high eccentricity would be avoided. This design feature was not adopted due to wear considerations.

The three groove seal design was adopted for the seal modifications. With all of the other components kept the same, the

log decrement at 9800 rpm was calculated as 0.12 (stable). This value, given the inaccuracies of computer modelling, was good, but judged not to be as large as desired.

The second objective of ensuring that the seal ring moves with the seal was not pursued, because the first modification appeared to be sufficient to remove the subsynchronous vibration. Also, the first modification introduced the least number of seal changes. From a leakage point of view, the seal performed well, so there was no desire for major changes.

BEARING MODIFICATIONS

The tilting pad bearings used in this compressor were modified to further improve stability. Two parameters were chosen for modification: the bearing preload, m , and clearance C_b . These are related to the bearing ground in pad clearance of C_p by the equation

$$m = 1 - \frac{C_b}{C_p} \quad (2)$$

Note that all values of clearance in this paper are radial rather than diametral values.

The original bearings had a pad clearance of $C_p = 6$ mils and a preload of $m = 0.5$. First, the pad clearance was held constant and the preload varied. The original seal dynamic coefficients at 9000 rpm were employed here. The results are depicted in Figure 11. A decrease in the bearing preload gives a significant increase in the system log decrement. Second, the bearing clearance was held constant and the preload varied. This produced an even larger improvement in stability, as seen in Figure 11.

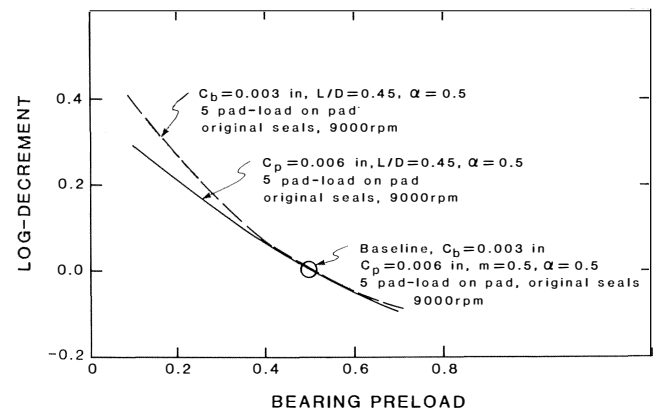

Figure 11. Log Decrement vs Bearing Preload for Original Seals for Constant Values of C_b and C_p at 9000 RPM.

This type of study was repeated for the rotor with the three groove seal design and at 9800 rpm. Figure 12 depicts the results. Again, holding the bearing clearance constant and varying the preload produced the largest increase in log decrement. Also, the balance piston was removed for one set of runs, to determine whether the reduction of cross coupled stiffness would greatly increase the log decrement. As seen in Figure 12, the improvement is marginal.

Finally, the optimum bearing design was chosen to have a preload factor of 0.1 and the bearing clearance varied. The results, including the three groove seals and a running speed of 9800 rpm, are presented in Figure 13. The bearing design modification was fixed at a bearing clearance of 3.5 mils (radial) and a preload factor of 0.1. The final stiffness and damping coefficients at 9800 rpm are given in Table 4. Note, the pre-

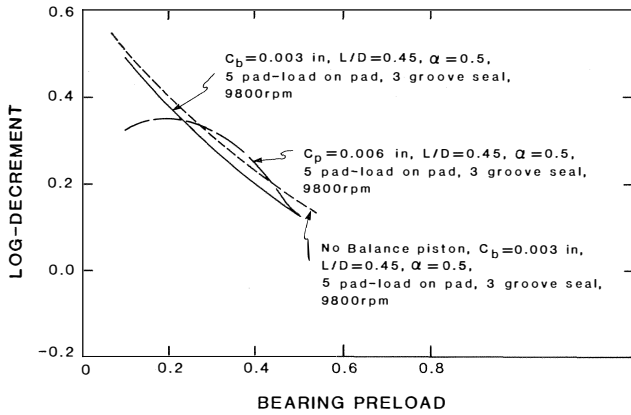

Figure 12. Log Decrement vs Bearing Preload for Three-Groove Seals for Constant Values of C_b and C_p at 9800 RPM.

Table 4. Dynamic Coefficients for Modified Bearing at 9800 RPM.

K_{xx}	= 216104lb/in
K_{yy}	= 677795 lb/in
C_{xx}	= 789 lb-sec/in
C_{yy}	= 1184 lb-sec/in

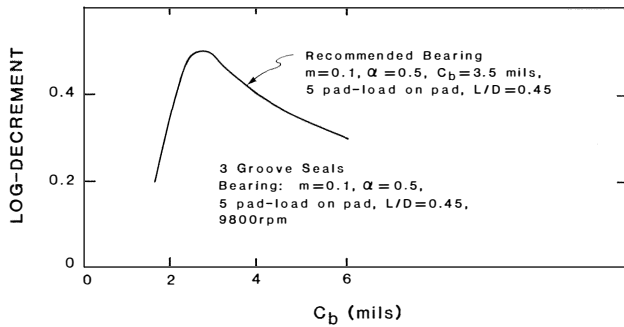

Figure 13. Log Decrement vs Radial Bearing Seals for $m = 0.1$ at 9800 RPM.

dicted log decrement is now about 0.5, as compared to the value of 0.12, with just the modified seals. This is a major improvement.

CRITICAL SPEEDS AND MODE SHAPES IN MODIFIED ROTOR

It is important with any rotordynamics redesign that the changes introduced to remove one problem do not introduce other problems. One should recall from the critical speed map in Figure 4 that the compressor operated at just below the second and third critical speeds. There was some concern that reducing the bearing stiffness, as done by the above bearing modification, would possibly drop one of these critical speeds into the operating speed range. This was investigated by looking at the mode shapes for the modified rotor.

The calculated damped mode shapes for the modified rotor running at 9800 rpm are shown in Figure 14. All were overdamped. The first mode is at 3563 rpm and is a standard first shaft bending mode. The second mode is at 5465 rpm and represents a conical mode, with large predicted amplitudes at the bearings. Bearing damping will damp this mode out. The

third mode is at 9193 rpm, which is in the operating speed range. However, it too has large predicted motion in the bearing locations, and thus will be damped out. It is not a matter for concern. The next mode is at 13,150 rpm, well above the running speed range.

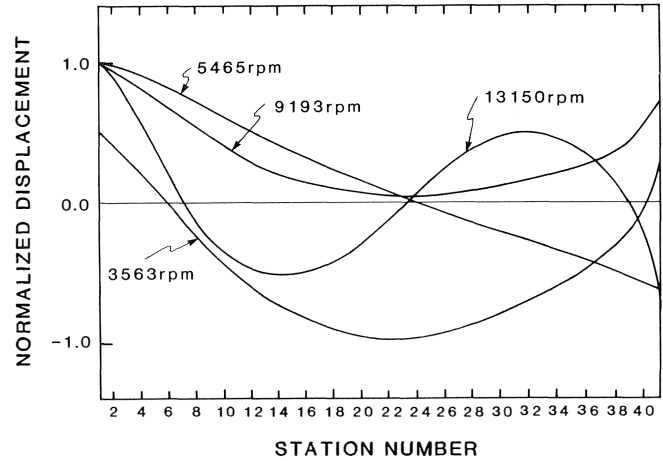

Figure 14. Mode Shapes for First Four Damped Eigenvalues.

UNBALANCE RESPONSE IN MODIFIED ROTOR

Unbalance response has not been a problem with this compressor. Again, however, it was desired to verify that no new problems were introduced with the design modifications. Unbalance response calculations were carried out for the modified rotor.

The first unbalance case was chosen to simulate a typical unbalance in the rotor center. This would excite both the first mode at 3563 and the third mode at 9193 rpm. Two 0.5 oz-in unbalances were placed in the center impellers, and two similar unbalances were placed in the two outer impellers at 180 degrees out of phase with the first two. The response vs speed at several locations is given in Figure 15. There is a first critical speed peak at the midspan, with another very broad peak at the bearings at the third critical speed. It is easily seen that there are no strong vibration peaks in the running speed range of 9,000 to 10,000 rpm.

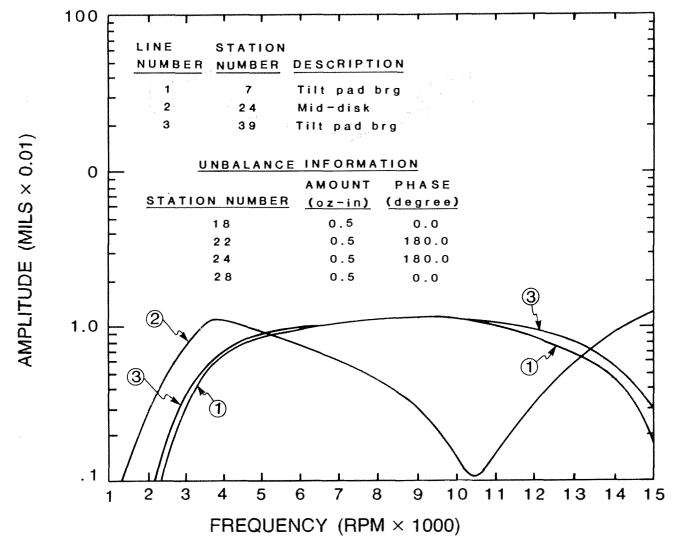

Figure 15. Unbalance Response for Compressor—Interior Distributed Unbalance (Case 1).

Another unbalance case was chosen to excite the second mode at 5465 rpm and the fourth mode at 13,159 rpm. Two unbalances of 0.5 oz-in were placed 180 degrees out of phase at the two impellers nearest the bearings. The unbalance response is shown in Figure 16. There is no peak near 5465 rpm indicating that the second mode is very well damped. There is a large peak at 13,000 rpm, well above running speed. The rotor modifications do not appear to have created any vibration problems, due to turbulence.

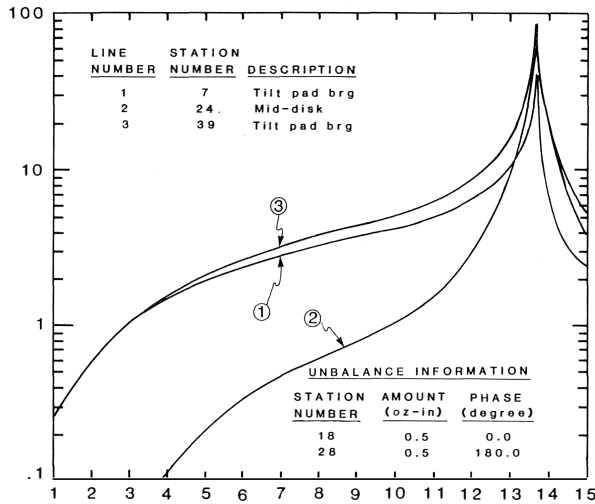

Figure 16. Unbalance Response for Out of Phase Unbalance Distribution (Case 2).

VIBRATIONS AFTER INSTALLATION OF MODIFICATIONS

During plant downtime, the modifications to the oil seals and bearings were made and installed. The plant was restarted and vibration data were recorded.

The initial startup data taken at 8600 rpm are shown in Figure 17. There was a synchronous vibration component at 8600 rpm as expected, plus a very low frequency component, as indicated

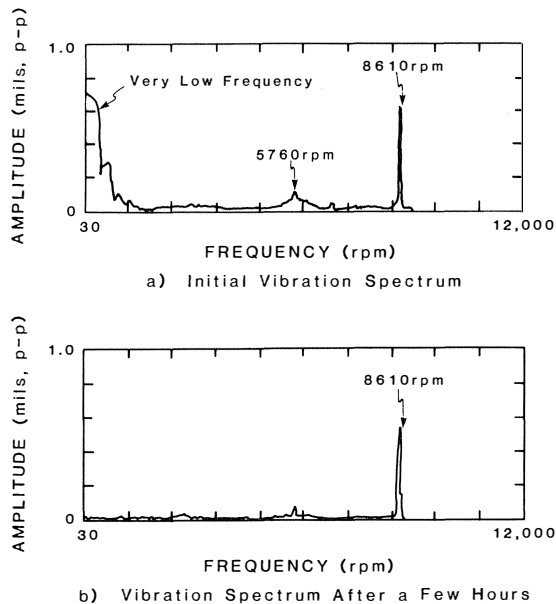

Figure 17. Vibration Spectrum Just after Startup Following Modified Seals and Bearings at 8600 RPM.

in Figure 17 (a). It started at 460 rpm, then dropped to 180 rpm, and finally disappeared. This occurred over a period of hours. The vibration spectrum after the low frequency was gone is shown in Figure 17 (b). Kirk observed a similar vibrational behavior on a compressor test stand. He attributes the low frequency vibrations to an unstable motion of the seal ring [14]. The low frequency did not reappear. Perhaps the cause was a rubbing component which wore in during startup.

The compressor was finally run up to 9621 rpm and the vibration spectra recorded (Figure 18). There was no subsynchronous vibration present. The objective of the redesign was to remove the subsynchronous vibration so it has been successful to date.

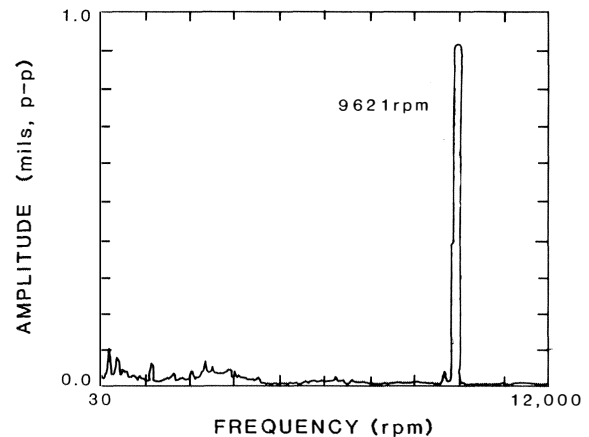

Figure 18. Final Spectrum Following Modification of Seals and Bearings.

NOMENCLATURE

- A Unbalanced Seal Ring Area
- C_b Bearing Clearance
- C_p Pad Clearance
- m Bearing Preload
- n Pressure Power Law
- N_d Shaft Speed at Design
- N_{lock} Lock Up Speed for Seal Ring
- P_d Seal Pressure Drop at Design
- μ_s Coefficient of Static Friction

REFERENCES

1. Stroh, C. G., "Rotordynamic Stability—A Simplified Approach," *Proceedings of 14th Turbomachinery Symposium*, Turbomachinery Laboratories, Department of Mechanical Engineering, Texas A&M University, College Station, Texas, pp. 3-10 (1985).
2. Nicholas, J. C., Gunter, E. J., and Allaire, P. E., "Stiffness and Damping Coefficients for the Five-Pad Tilting Pad Bearing," *Transactions of the American Society of Lubrication Engineers*, 22 (2), pp. 113-124 (April 1979).
3. Allaire, P. E., and Flack, R. D., "Design of Journal bearings for Rotating Machinery," *Proceedings of 10th Turbomachinery Symposium*, Turbomachinery Laboratories, Department of Mechanical Engineering, Texas A&M University, College Station, Texas, pp. 25-45 (1981).
4. Allaire, P. E., Kocur, J. A., and Stroh, C. G., "Oil Seal Effects and Subsynchronous Vibrations in High Speed Compressors," Presented at Instability in Rotating Machin-

- ery Symposium, Bently Nevada, Carson City, Nevada, June 1985, NASA CP 2409 (1986).
5. Kirk, R. G., and Miller, W. H., "The Influence of High Pressure Oil Seals on Turbo-Rotor Stability," *ASLE Transactions*, 22 (1), pp. 14-24 (January 1979).
 6. Kirk, R. G., and Nicholas, J. C., "Analysis of High Pressure Oil Seals for Optimum Turbocompressor Dynamic Performance," *Vibrations in Rotating Machinery Second International Conference*, Institution of Mechanical Engineers, Cambridge, pp. 125-134 (September 1980).
 7. Kirk, R. G., "Oil Seal Dynamics: Considerations for Analysis of Centrifugal Compressors," *Proceedings of 15th Turbomachinery Symposium*, Turbomachinery Laboratory, Department of Mechanical Engineering, Texas A&M University, College Station, Texas, pp. 25-34 (1986).
 8. Doyle, H. E., "Field Experiences With Rotor Dynamic Instability in High-Performance Turbomachinery," *Rotordynamic Instability Problems in High-Performance Turbomachinery Conference*, Texas A&M University, pp. 3-14 (1980).
 9. Wachel, J. C., "Rotordynamic Instability Field Problems," *Rotordynamic Instability Problems in High-Performance Turbomachinery Conference*, Texas A&M University, pp. 1-19 (1982).
 10. Emerick, M. F., "Vibration and Destabilizing Effects of Floating Ring Seals in Compressors," *Proceedings of Rotordynamic Instability Problems in High-Performance Turbomachinery Conference*, Texas A&M University, pp. 187-204 (1980).
 11. Cerwinski, T. J., Nelson, W. E., and Salamone, D. J., "Effects of High Pressure Oil Seals on the Rotordynamic Response of a Centrifugal Compressor," *Proceedings of 15th Turbomachinery Symposium*, Turbomachinery Laboratory, Department of Mechanical Engineering, Texas A&M University, College Station, Texas, pp. 35-52 (1986).
 12. Schmaus, R. H., "Static and Dynamic Properties of Finite Length Turbulent Annular Flow Seals," M. S. Thesis, University of Virginia (1981).
 13. Iwatsubo, T., Motooka, N., and Kawai, R. "Flow Induced Force of Labyrinth Seal," *Proceeding of Rotordynamic Instability Problems in High Performance Turbomachinery Conference*, Texas A&M University, pp. 205-222 (1982).
 14. Kirk, G. R., and Simpson, M., "Full Load Shop Testing of 18,000 HP Gas Turbine Centrifugal Compressor for Off-shore Platform Service: Evaluation of Rotordynamics Performance," *Proceedings of an Instability in Rotating Machinery Symposium*, sponsored by Bently Rotordynamics Research Corporation, (1985), NASA CP 2409 (1986).

