

Evidence-based calibration of a building energy simulation model: Application to an office building in Belgium



Stéphane Bertagnolio
Thermodynamics Laboratory
Faculty of Applied Sciences
University of Liège

ICEBO Conference
Manchester, October 2012



BES models & Energy Services Process

Benefits

Limitations

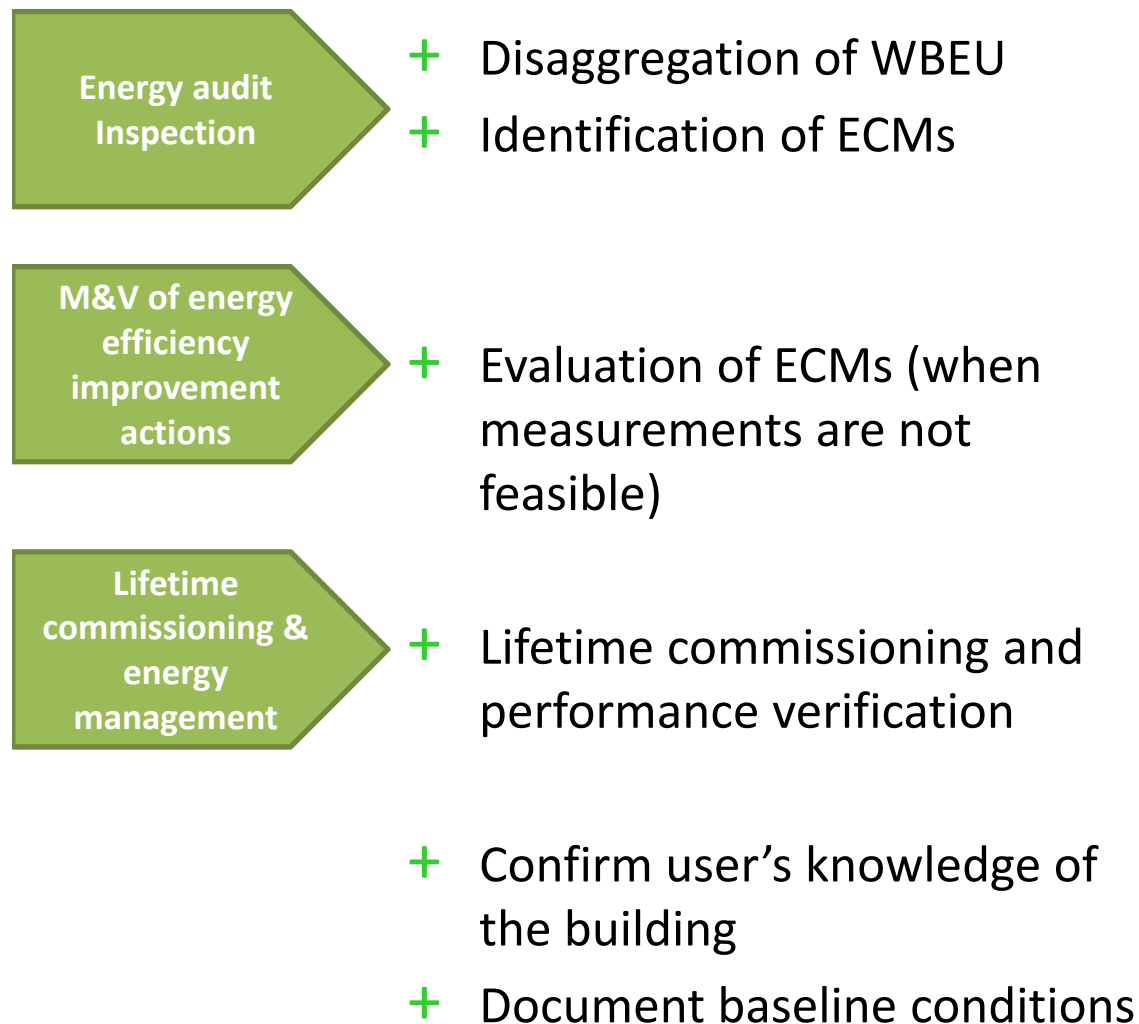

- The model remains an abstraction of the reality
- The use of a BES model to study an existing situation may be tricky
- A compromise has to be found:
Accuracy-simplicity-flexibility
- Availability and uncertainty on data used to check the validity of the model



Modeling an existing situation is a complex task

- BES model required to be able to closely **represent the actual behavior** of the building under study
- Use of non-adjusted models → discrepancies between **30%** (total energy use) and **90%** (individual components such as hot water use...)

→ **Impossible to trust uncalibrated models when trying to analyze an existing situation**



What is model calibration ?

Model calibration = fitting of a building energy simulation model to an existing situation

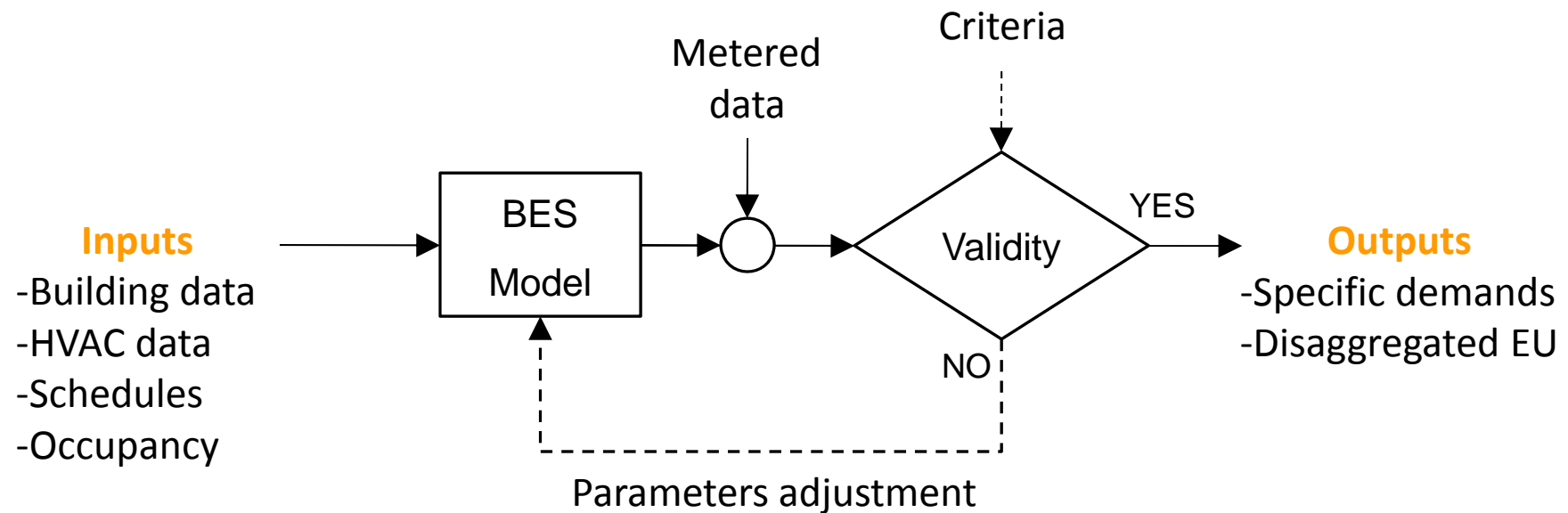

→ Highly undetermined problem



Objectives of this work

- Development of a new **simplified building energy simulation model** dedicated to existing buildings and adapted to calibration
- Development of an **evidence-based calibration procedure** including **sensitivity, measurement and uncertainty issues**

→ To support **energy use analysis**



Evidence-based calibration for energy use analysis

Simple BES model

Evidence-based calibration

Case Study

Conclusion and perspectives



Required outputs for energy use analysis

- Specific energy demands (per zone, per use...)
- Specific final energy consumptions (per zone, per use...)
- Disaggregation of final energy use

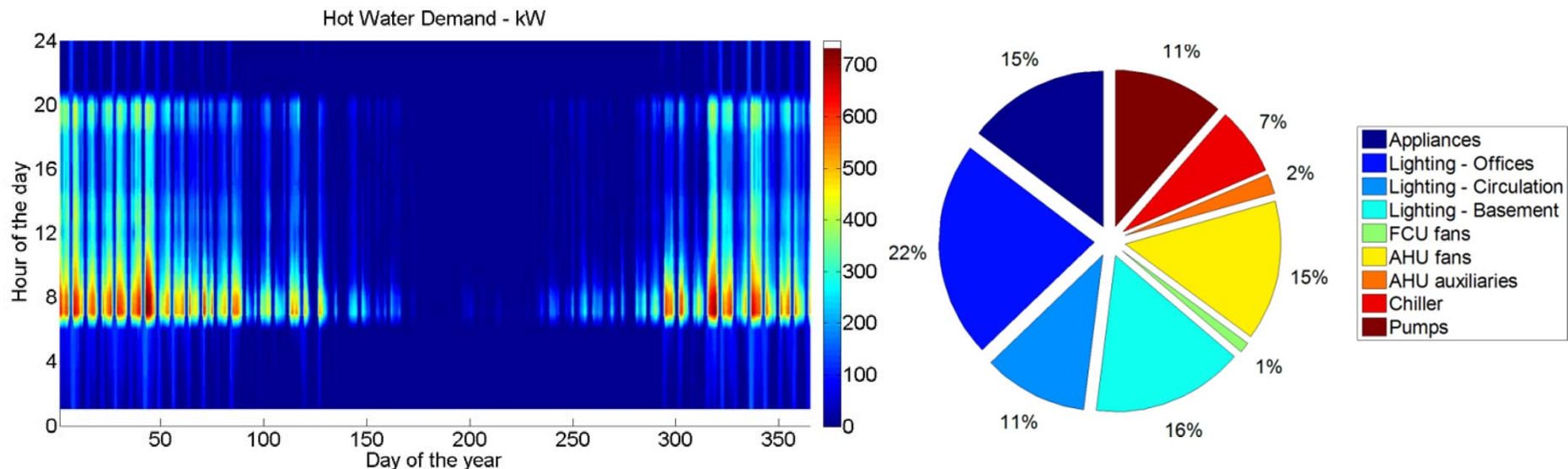

Simplified BES model

- Simple multizone building model (simple hourly method ISO/EN 13790)
- Moisture balance: Water capacitance method
- Secondary HVAC system
 - All Air (CAV+RH/VAV+RH)
 - Air / Water (CAV+TU)
 - All Water (TU)
- Primary HVAC system
 - Hot water boiler
 - Air or water cooled chillers
 - Heat rejection devices

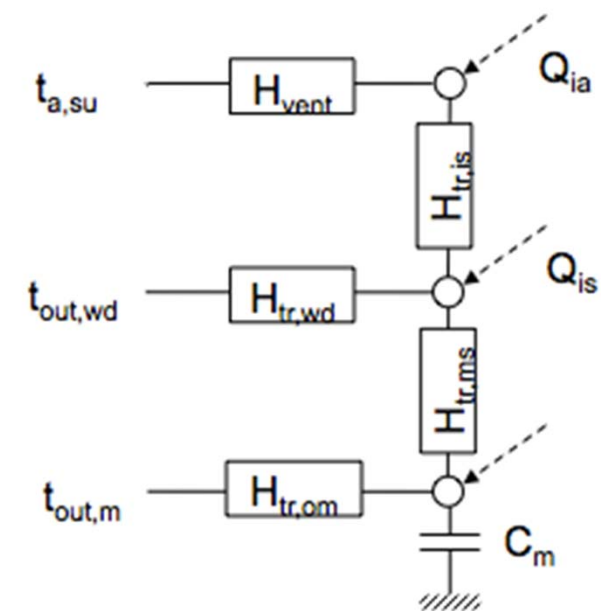

Sensible thermal zone model



Evidence-based calibration for energy use analysis

Simple BES model

Evidence-based calibration

Case Study

Conclusion and perspectives

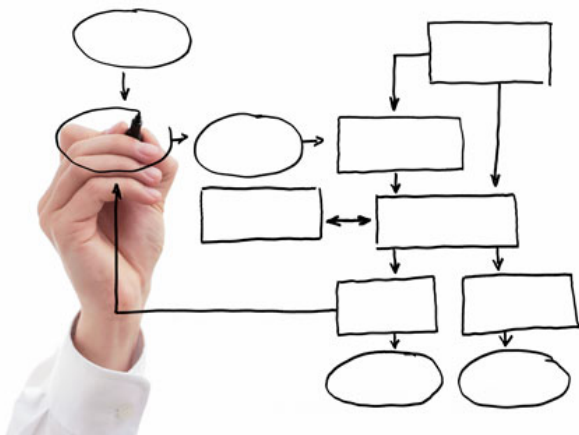

Problems encountered in practice

- The **adjustment** of the parameters is generally **not systematic** but is related to data availability and skills of the user
- Final **quality** of the “calibrated” model is generally **not (or badly) controlled**
- **Sensitivity and uncertainty** are crucial issues but generally not studied
- Automated methods are not commonly used and the available **too global billing data** do not generally allow proper application of optimization methods

→ **non-realistic and bad representation of the behavior of the system**



Evidence-based calibration process

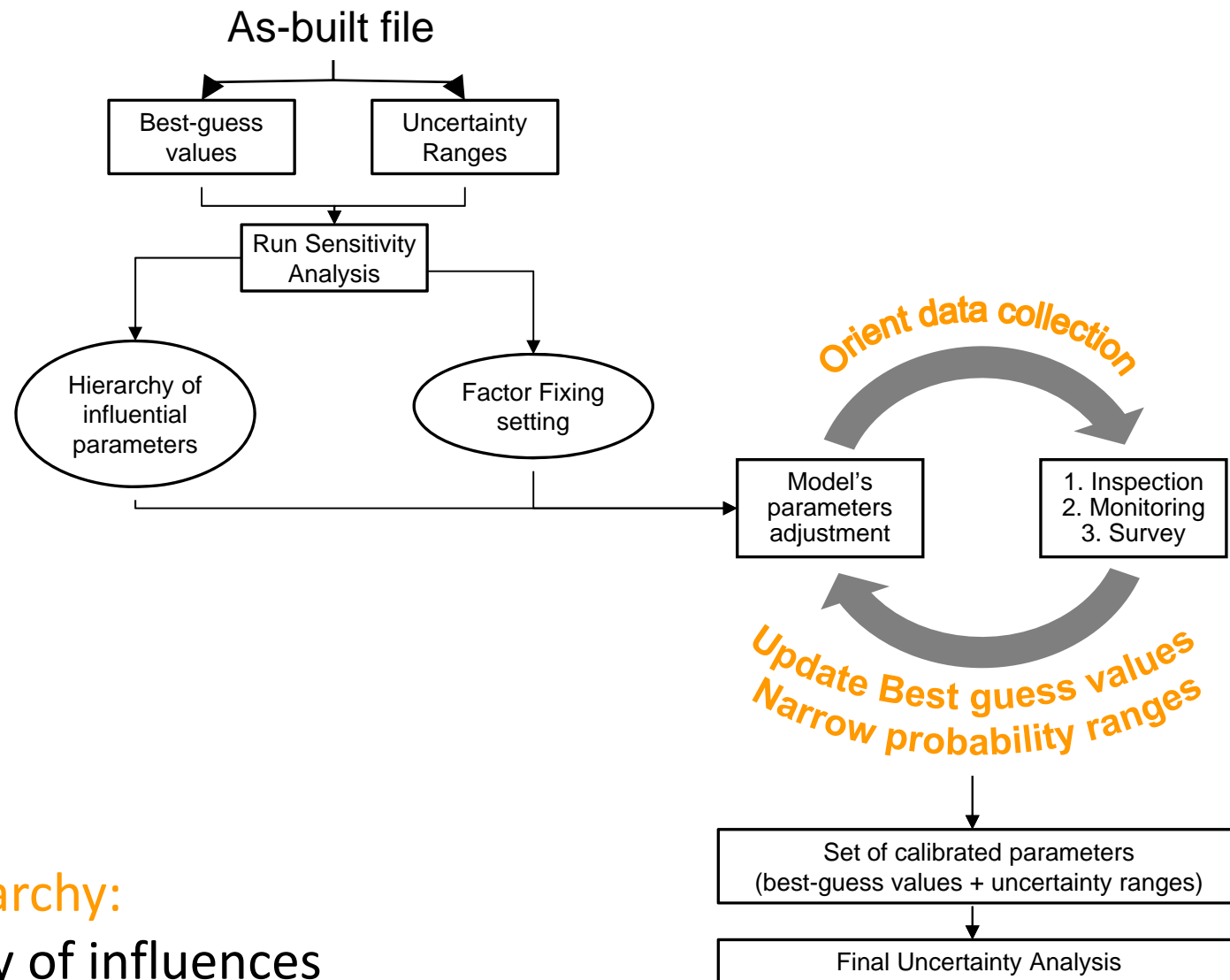

2 types of hierarchy:

- Hierarchy of influences
- Quality of information (monitoring > observation > estimation)

Validity of the calibrated model

Validity checked by means of:

- Visual verification (plots)
- Statistical criteria

$$MBE = \frac{\sum_{i=1}^n (Q_{pred,i} - Q_{data,i})}{n Q_{data}}$$

$$CV(RMSE) = \frac{RMSE}{Q_{data}} = \frac{\frac{\sqrt{\sum (Q_{pred,i} - Q_{data,i})^2}}{n}}{Q_{data}}$$

Criteria for estimation of energy and demand savings

Index	Waltz (2000) (%)	ASHRAE 14 (%)	IPMVP (%)	FEMP (%)
MBE _{year}	+/- 5			
MBE _{month}		+/- 5	+/- 20	+/- 5
CV(RMSE) _{month}		+/- 15	+/- 5	+/- 15
MBE _{hour}		+/- 10		
CV(RMSE) _{hour}		+/- 30		



SA: Morris method for factor fixing

- Morris method = Screening Method (adapted to Factor Fixing)
- Global (\neq Local) method
- Definition of trajectories covering the parametric space
- Computation of the « Elementary Effect »

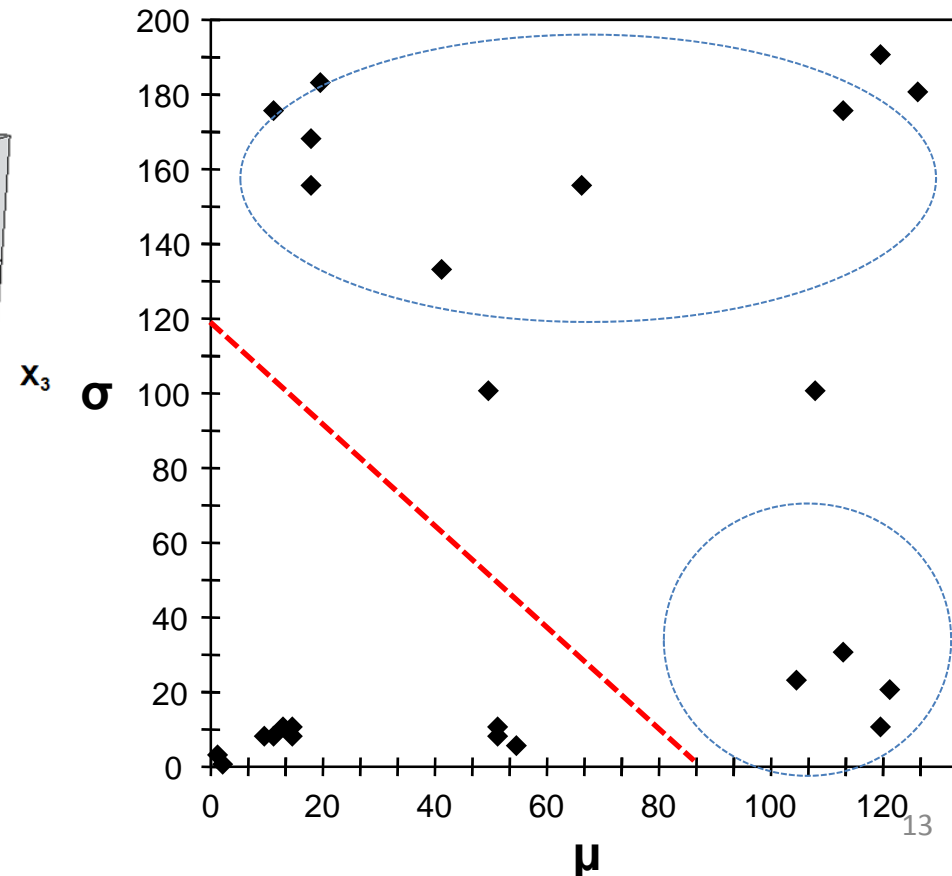
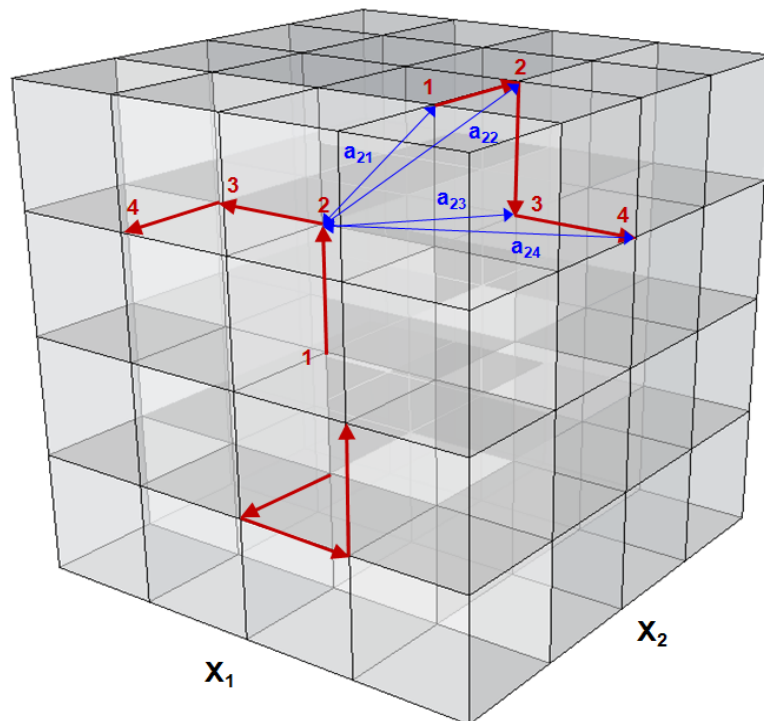

UA: Uncertainty on the outputs

- Use of the LHMC method
- Final uncertainty (probability) ranges are used to generate a sample ($p = 100$ runs)
- Uniform or Normal PDF can be used

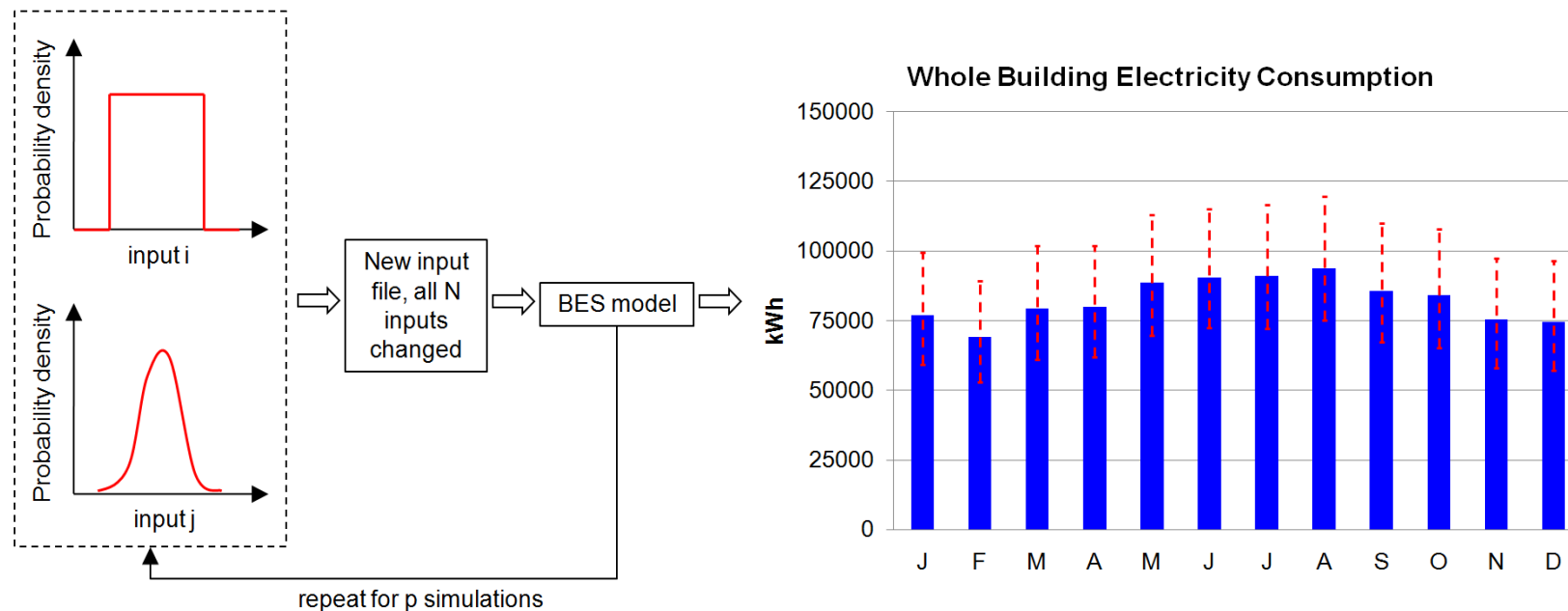

Evidence-based calibration for energy use analysis

Simple BES model

Evidence-based calibration

Case Study

Conclusion and perspectives



Case study

- Typical office building located in Brussels (D+ energy rating; Avg : D)
- 10100 m² of usable floor area
- CAV (Adiab. Humidification)+ FCU
- Basement parking heaters (141 kW)
- 3 x Natural Gas Boilers
- 2 x Water cooled chillers
- 2 x IC Cooling Towers
- 3 years of consumption data: 2008 to 2010

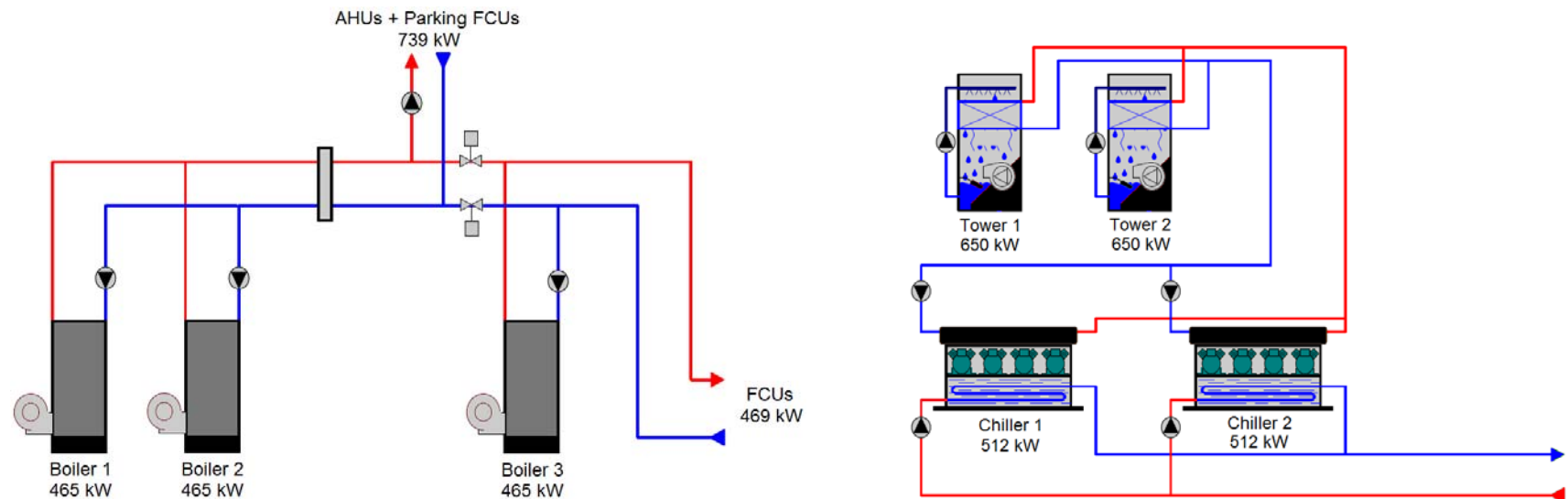

Step 0 – As-built input file

Complete description of building and HVAC system (nominal perf.)
 No information about occupancy and operating conditions/schedules

- Acceptable representation of gas & WBE cons.
- Bad representation of peak/off-peak split
- Large uncertainties on energy end-use

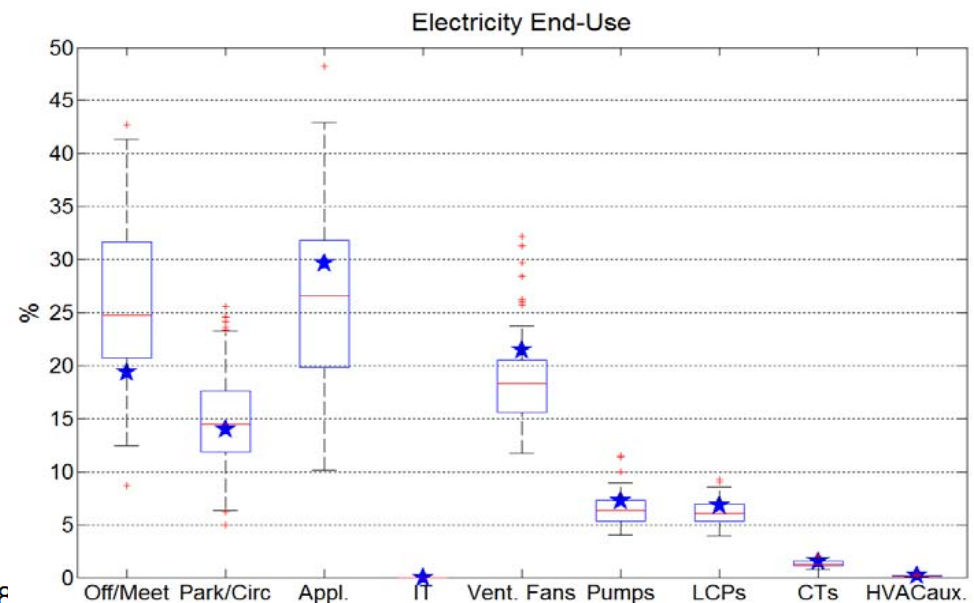
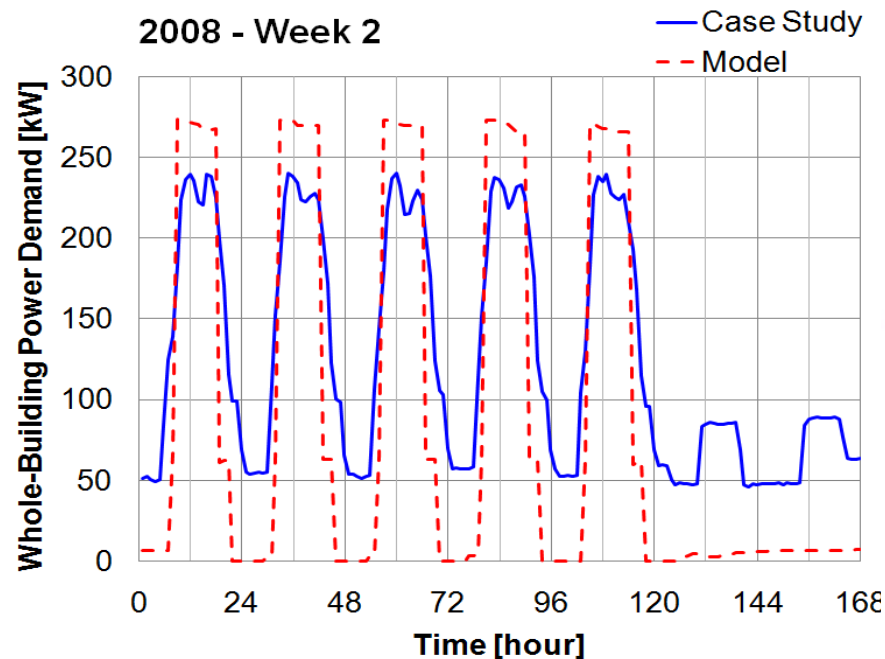

Preliminary sensitivity analysis

Focus on:

1. Internal loads (power and schedules)
2. HVAC system operation (setpoints and schedules)
3. HVAC components efficiencies

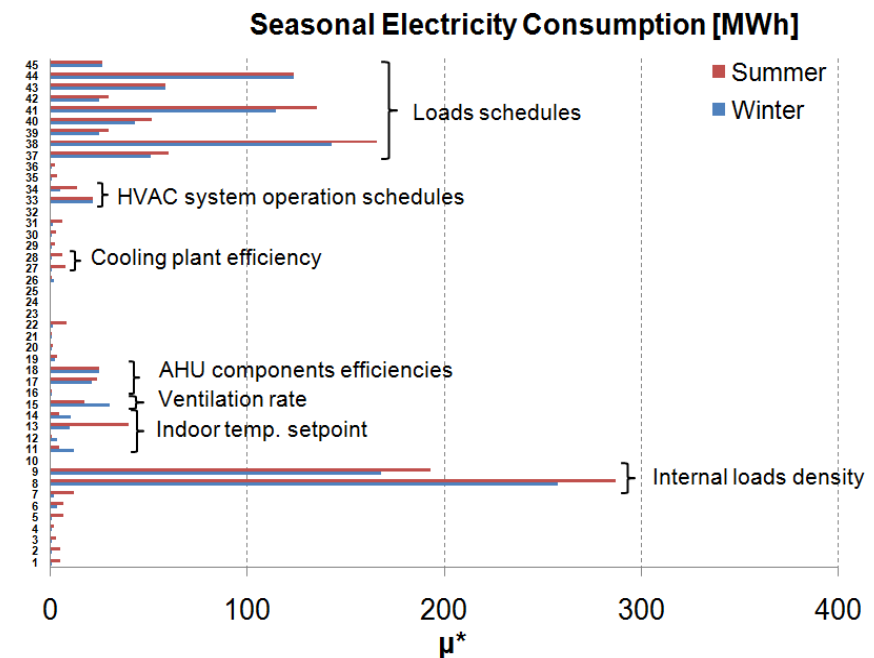
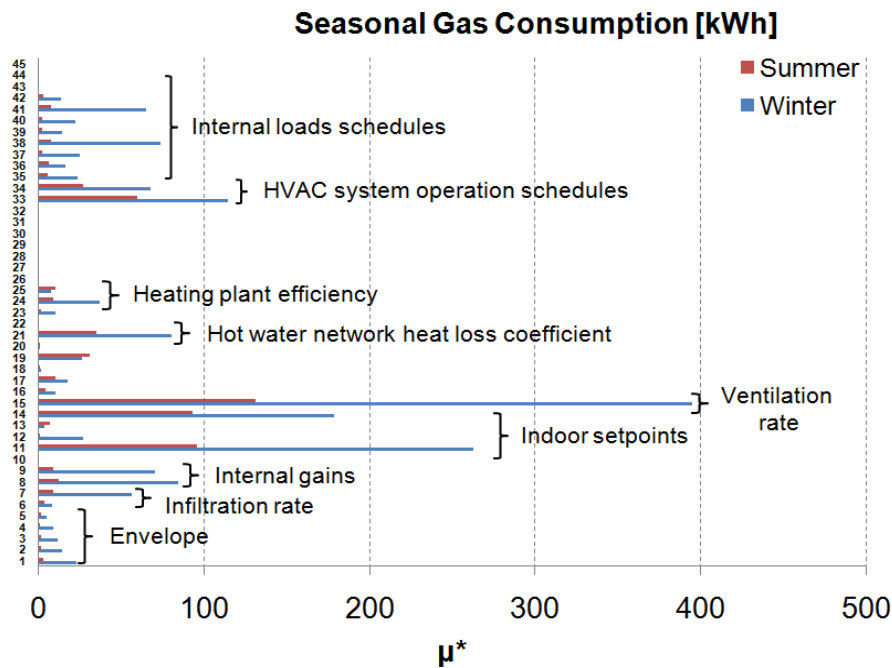

Step 1– Inspection

Analysis of the BEMS (system schedules and theoretical setpoints)
 Survey of installed internal loads densities & IT power

→ Update of concerned parameters & narrowing of the uncertainty ranges

- Acceptable representation of gas cons.
- Good representation of offpeak cons.
- Overestimation of peak cons. (hyp: 100% occupancy/use)

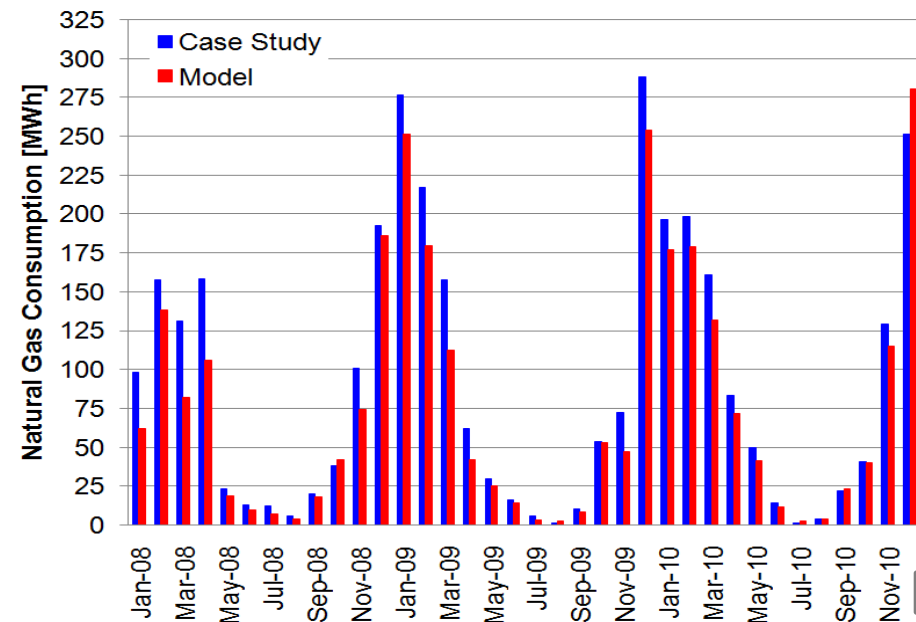
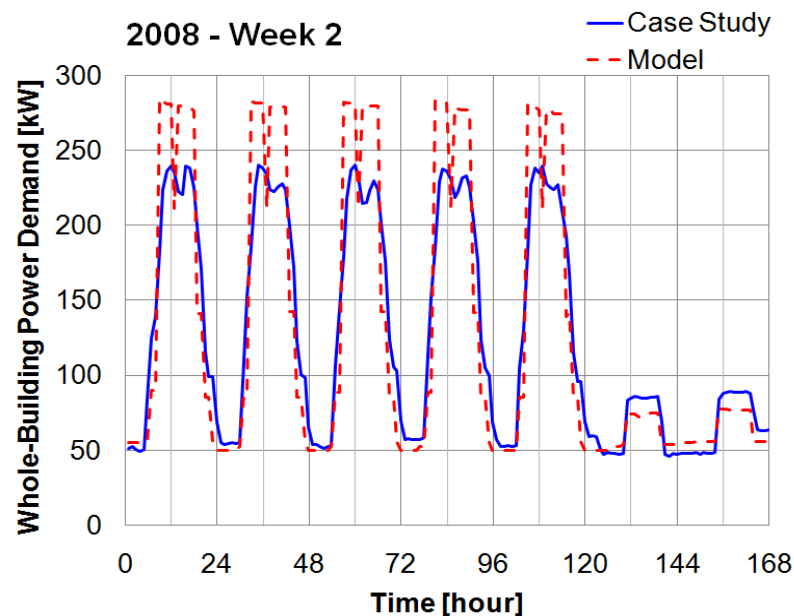

Step 2– Monitoring phase

- Analysis of floor-level power demand → **hourly operation profiles** (max. 85% use rate)
- Achieved temperature: **1.6°C over BEMS recording**
- Achieved humidity level: **42% (avg) instead of 50%**
- Fan cons.: **82% of nominal absorbed power (as-built)**
- Pump power and operation: ok

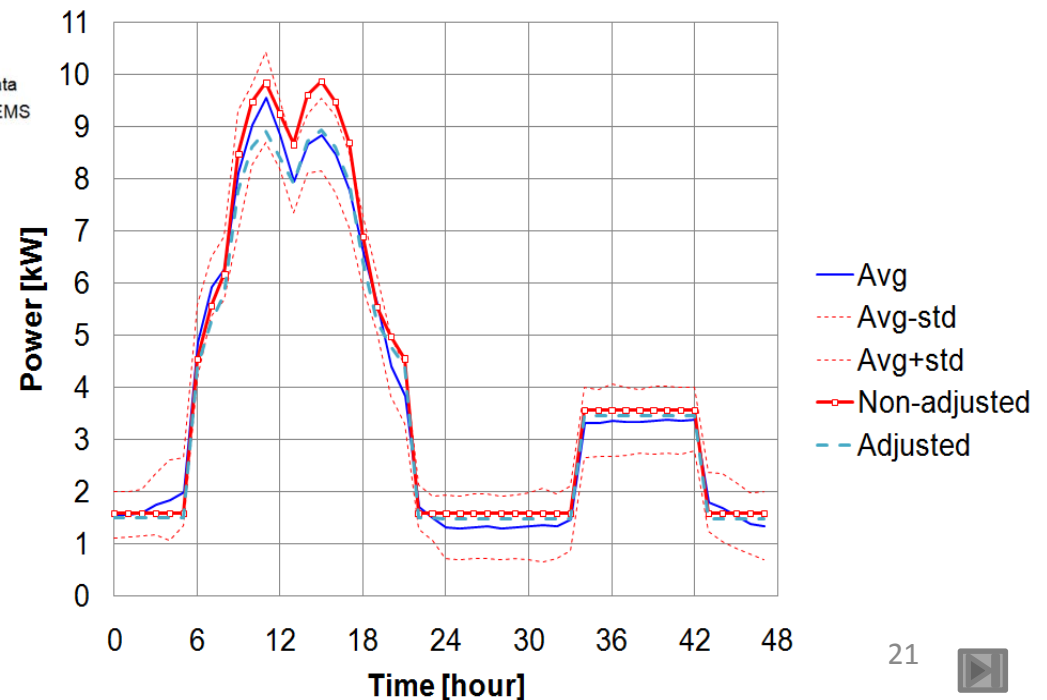
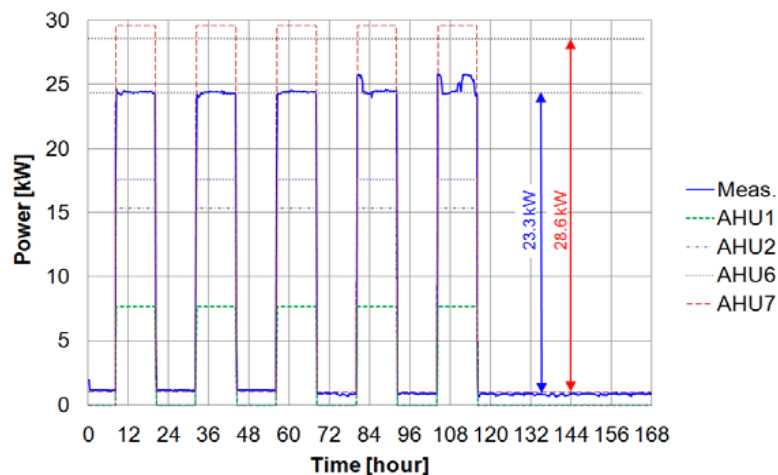
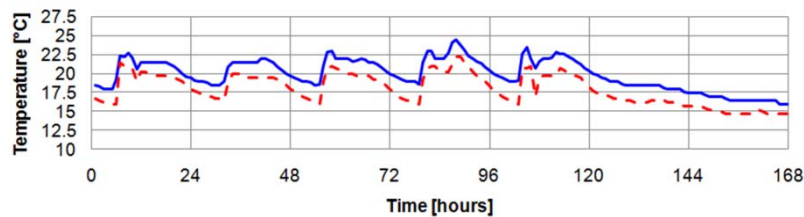

Step 2– Monitoring phase

→ Update of concerned parameters & narrowing of the uncertainty ranges

- Good representations of both gas and peak/offpeak electricity cons. (MBE & CV(RMSE) < 6%)
- Good representation of winter power demand
- Overestimation of summer power demand (combined effect of less intensive lighting use and holidays ?)

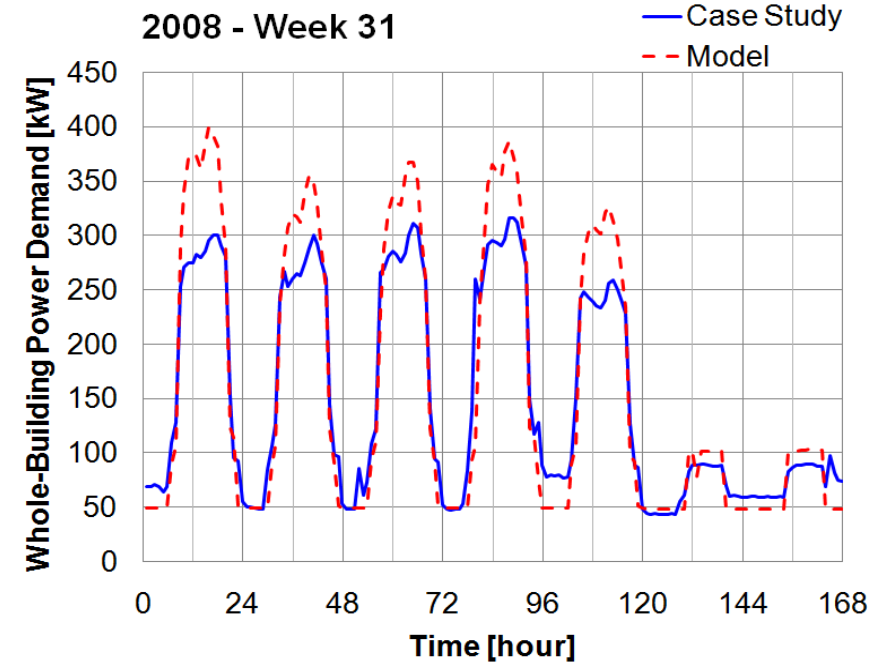
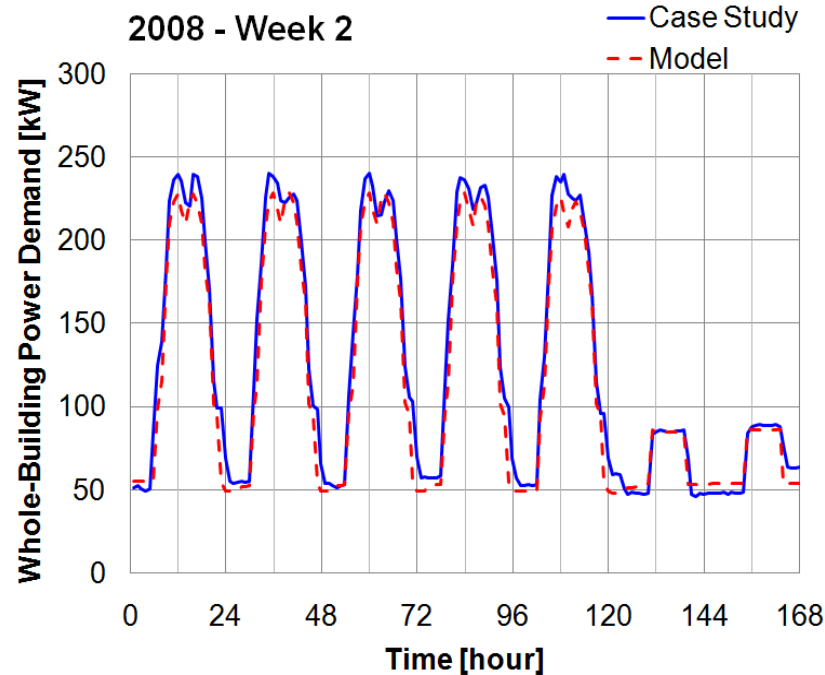

Step 3 – Occupants survey

Identification and estimation of summer holidays period

→ Update of concerned parameters & narrowing of the uncertainty ranges

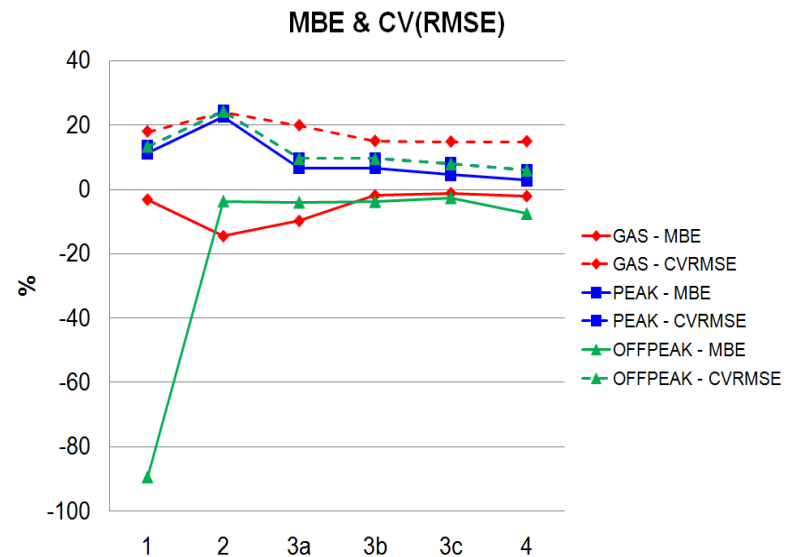
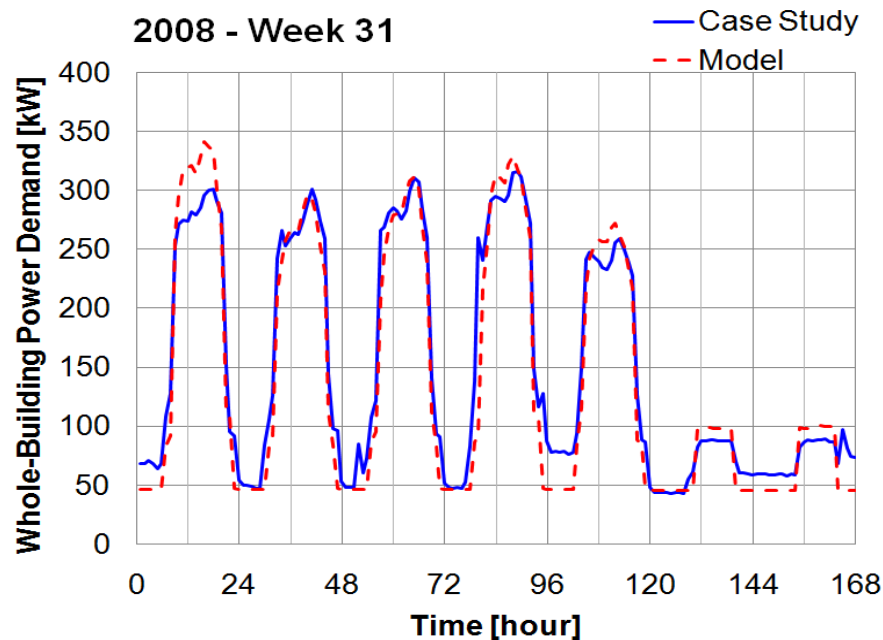

ASHRAE G14 – 2002 criteria

- Monthly consumptions: ✓
- Hourly WBE demand : ✓



Step 3 – Energy end-use analysis

- Uncertainty is drastically reduced
- Main electricity consumers:
 - IT
 - Lighting in non-occupancy zones
 - Offices appliances & lighting

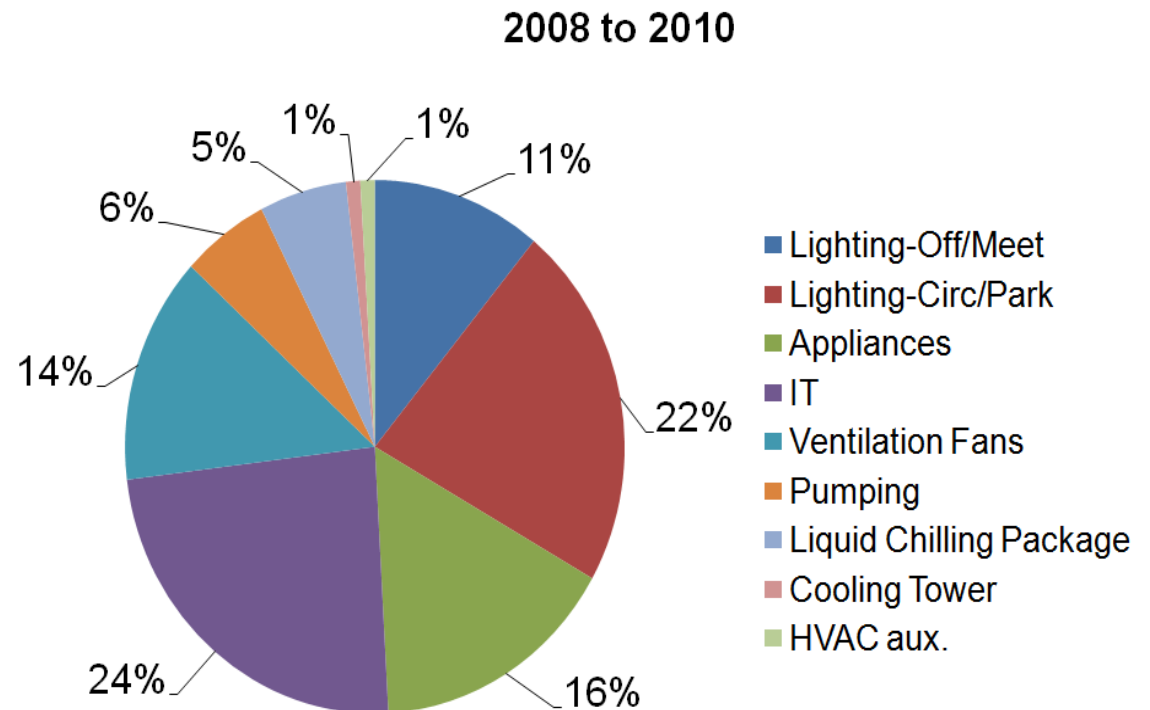

Step 3 – Energy end-use analysis

- Parking heaters: 16% of heat demand
- AHU reheat: 37% of heat demand (high setpoints: 20 to 25°C)
- Offices FCUs: 23% of heat demand (high avg setpoint: 22.6°C)
- Inverse conclusions for cooling demand (FCUs > AHU)

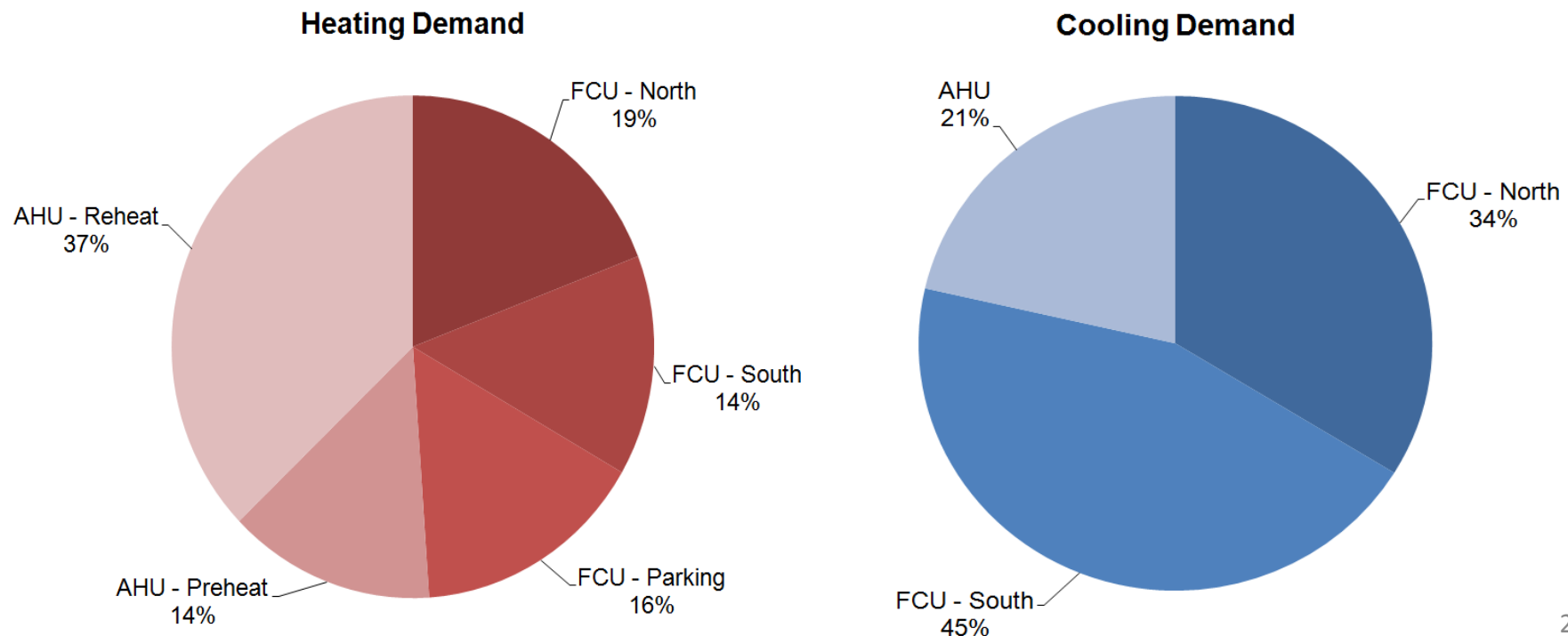

Final uncertainty

- Monthly **gas** consumption: **11% (December)** to **22% (July)** **stddev**
- Monthly **electricity** consumption: **2 to 3% stddev**
- Uncertainty on predicted gas consumption is significant
- Possible improvement: measurement of ventilation flow rate

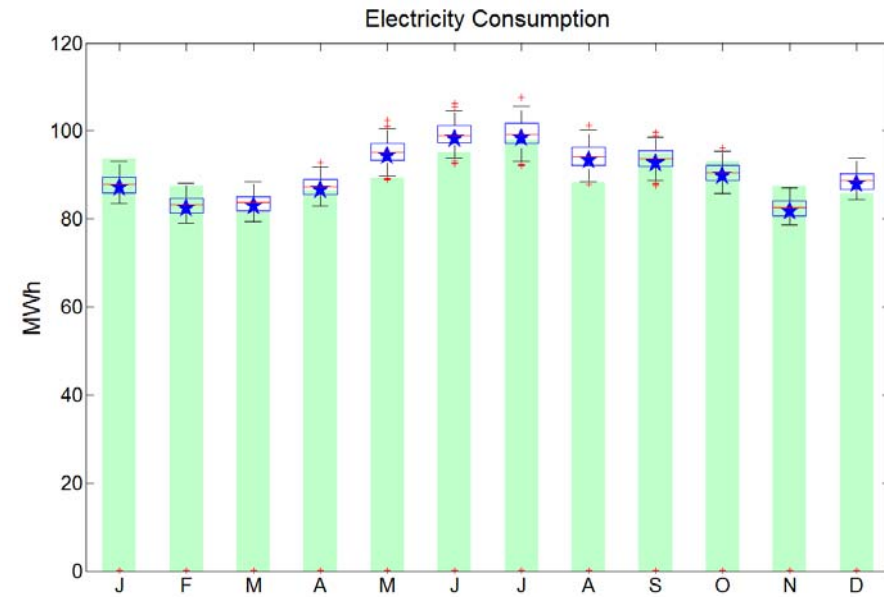
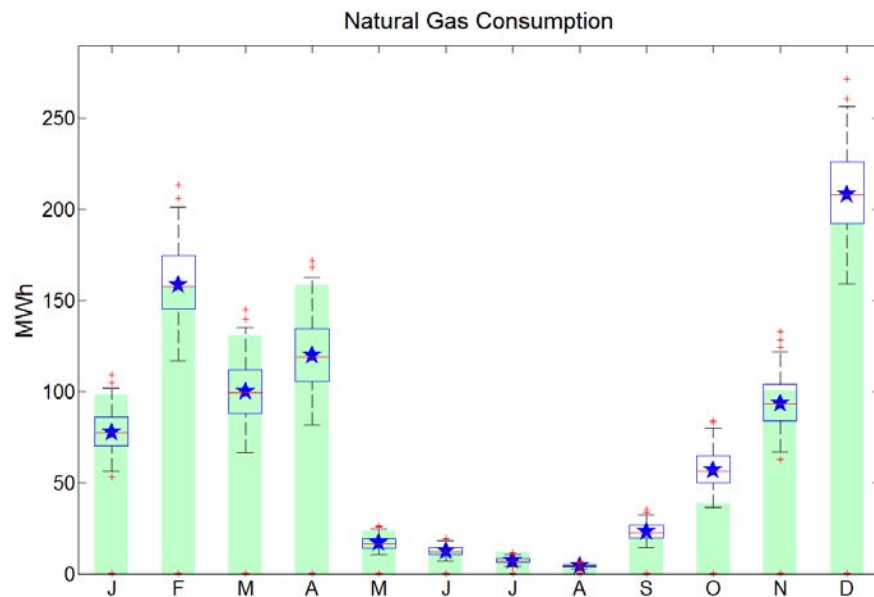

Evidence-based calibration for energy use analysis

Simple BES model

Evidence-based calibration

Case Study

Conclusion and perspectives



The developed tool and methodology provide encouraging results

- Calibration = Highly undetermined problem + complex interactions + very limited information
 - Perfect automated calibration method is not likely to appear
- Development of a **systematic & flexible evidence based method**
 1. **Hierarchy** among influential parameters (screening and factor fixing)
 2. **Hierarchy** among quality of information (narrowing of uncertainty ranges)
- The methodology integrates sensitivity (Morris) and uncertainty (LHMC) issues
- Validity of the calibration model has to be evaluated by means of:
 - Visual verification
 - Statistical indexes



The developed tool and methodology provide encouraging results

- Calibration levels have been defined and characterized
 - **Step 0**: bad representation of energy use
 - **Step 1**: improvement of the model but uncertainties >>
 - **Step 2 & 3**: acceptable representation of energy end use (but uncertainties on heating and cooling needs may remain significant)
- Future of **BES model calibration** is directly related to more **common use of energy metering**



Perspectives and future research

- Use of the calibrated model to orient **future data collection**, support **commissioning**, continuous **perf. verification**...
- Use of more **advanced uncertainty analysis** methods to study **interactions** between parameters (variance based methods...)
- Envisage **automated adjustment** to **refine** calibration
- Second **monitoring campaign**: cooling operation, cooling system performance, ventilation rate
- Evaluation of **ECMs** on case study building

