

**COST-EFFECTIVE ENERGY EFFICIENCY MEASURES
FOR ABOVE CODE (ASHRAE 90.1-2001 and 2007):
FOR RESTAURANT BUILDINGS IN THE CITY OF ARLINGTON**

A Research Project for the City of Arlington

**Jaya Mukhopadhyay
Hyojin Kim
Sung Lok Do
Kee Han Kim
Juan-Carlos Baltazar, Ph.D.
Jeff S. Haberl, Ph.D., P.E.
Cynthia Lewis**

**October 2011
Revised December 2011**

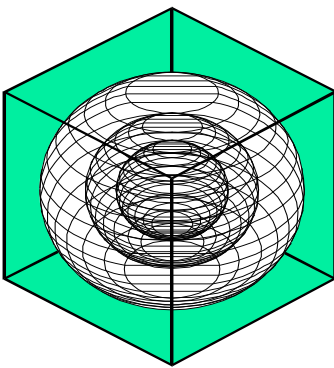

ENERGY SYSTEMS LABORATORY

**Texas Engineering Experiment Station
The Texas A&M University System**

Disclaimer

This report is provided by the Texas Engineering Experiment Station (TEES). The information provided in this report is intended to be the best available information at the time of publication. TEES makes no claim or warranty, express or implied that the report or data herein is necessarily error-free. Reference herein to any specific commercial product, process, or service by trade name, trademark, manufacturer, or otherwise, does not constitute or imply its endorsement, recommendation, or favoring by the Energy Systems Laboratory or any of its employees. The views and opinions of authors expressed herein do not necessarily state or reflect those of the Texas Engineering Experiment Station or the Energy Systems Laboratory.

EXECUTIVE SUMMARY

The Energy Systems Laboratory was requested to develop cost-effective recommendations to maximize energy savings for residential and commercial buildings in the City of Arlington (CoA). This report presents the analysis results for restaurant buildings in the CoA.

Based on an analysis of several individual above-code measures, certain recommendations were developed to achieve over a 15% above-code energy performance based on both the ASHRAE 90.1-2001 and 2007 standard reference buildings, for restaurant buildings in the CoA.

The deliverables for the CoA in this report are:

- Recommendations of 18 energy efficiency measures (EEMs) to maximize energy savings for small retail buildings in the CoA with estimated cost of the improvement, simple payback calculations, and emissions savings for ASHRAE 2001 base-case.
- Recommendations of 16 energy efficiency measures (EEMs) to maximize energy savings for small retail buildings in the CoA with estimated cost of the improvement, simple payback calculations, and emissions savings for ASHRAE 2007 base-case.

The recommendations include strategies for building envelope and fenestration, HVAC system, service hot water (SHW) system, lighting, and renewable options. The implementation costs of each individual measure were also calculated along with simple payback calculations. Figures 1 and 2 present a description of the individual measures and combinations of these measures which achieve 15% source energy savings above the ASHRAE 90.1-2001 and 2007 code-compliant building. Annual energy savings, estimated costs, simple payback, and NO_x-lbs/yr, SO₂-lbs/yr, and CO₂-lbs/yr emissions reduction are provided.

[ASHRAE 90.1-2001 Code-Compliant Restaurant Building - Dining Space Only]

Description of Individual Measures

Individual Measures	Annual Energy Savings (%) ¹		Annual Energy Savings (\$/year) ²	Annual Demand Savings (%)	Annual Demand Savings (\$/year) ³	Combined Savings (Energy+Demand) (\$/year)	Estimated Cost (\$)		Simple Estimated Payback (yrs)
	Site	Source					Marginal Cost ⁴	New System Cost ⁵	
A Envelope and Fenestration Measures									
1 Improved Wall Insulation (From R-13 to R-13 + 7.5 c.i.)	1.0%	0.7%	\$144	0.5%	\$13	\$157	\$2,655 - \$3,983		16.9 - 25.3
2 Improved Roof Insulation (From R-15 to R-25)	1.0%	0.8%	\$180	1.1%	\$27	\$207	\$3,856 - \$5,784		18.7 - 28.0
3 Reduced Roof Absorptance (From 0.7 to 0.36)	0.2%	0.5%	\$154	1.0%	\$23	\$177	\$1,760 - \$2,640		9.9 - 14.9
4 Improved Window U-value (From 1.22 to 0.35)	2.7%	1.2%	\$178	0.1%	\$2	\$180	\$5,818 - \$8,728		32.3 - 48.4
5 Window Re-Distribution (East & West: 10%, South: 55.1%)	0.3%	0.3%	\$65	0.2%	\$4	\$69	\$0 - \$0		0.0 - 0.0
6 Window Shading (From None to 10 ft)	-0.1%	0.7%	\$233	1.9%	\$46	\$279	\$38,107 - \$57,160		136.6 - 204.9
7 Window Shading & Redistribution (East & West: 10%, South: 55.1% Shading on South only: 10ft)	0.0%	0.4%	\$123	1.0%	\$24	\$147	\$10,851 - \$16,276		73.6 - 110.4
8 Air Barrier (From 0.322 to 0.05)	0.9%	0.6%	\$134	0.6%	\$14	\$148	\$5,885 - \$8,827		39.8 - 59.8
B Interior Lighting Measures									
9 Reduced Lighting Power Density (From 1.9 W/sqft to 0.89 W/sqft)	5.6%	11.3%	\$3,118	13.2%	\$317	\$3,435	\$8,000 - \$12,000		2.3 - 3.5
10 Reduced 24 Hour Lighting	0.1%	0.3%	\$72	0.0%	\$1	\$73	\$0 - \$0		-
11 Daylighting Control	4.6%	8.3%	\$2,265	8.8%	\$210	\$2,475		\$6,663 - \$9,994	2.7 - 4.0
C Exterior Lighting Measures									
12 Exterior Lighting Power Reduction (From 3.61 kW to 2 kW & reduction in usage to 25% of current usage from 12:00 AM to 6:00 AM)	2.7%	3.9%	\$1,030	1.0%	\$23	\$1,053	\$480 - \$720		0.5 - 0.7
D HVAC System Measures									
13 Improved HVAC System Efficiency (From 9.3 EER to 10.5 EER)	1.9%	2.7%	\$713	5.8%	\$139	\$852	\$1,366 - \$2,050		1.6 - 2.4
14 Improved Fan Efficiency (From 55% to 65%)	0.6%	1.4%	\$379	1.6%	\$37	\$417	\$928 - \$1,392		2.2 - 3.3
15 Economizer	0.0%	0.0%	\$7	0.0%	\$0	\$7	\$2,244 - \$3,367		344.9 - 517.4
16 Improved Furnace Efficiency (From 80% to 90%)	3.4%	1.7%	\$283	0.0%	\$0	\$283	\$1,360 - \$2,040		4.8 - 7.2
17 Demand Control Ventilation System	25.6%	14.3%	\$2,593	1.8%	\$43	\$2,637		\$737 - \$1,105	0.3 - 0.4
E Service Hot Water Heater Measures									
18 Improved Efficiency for Service Water Heaters (From Et 80% to Et 95%)	2.7%	1.3%	\$225	0.0%	\$0	\$225	\$342 - \$513		1.5 - 2.3

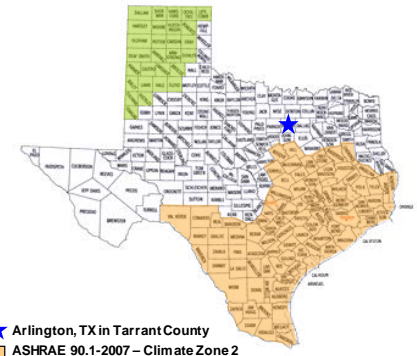

- ★ Arlington, TX in Tarrant County
- ASHRAE 90.1-2007 – Climate Zone 2
- ASHRAE 90.1-2007 – Climate Zone 3
- ASHRAE 90.1-2007 – Climate Zone 4

Description of Combined Measures

Combination of Measures ⁶	Combined Annual Energy Savings (%) ¹		Combined Energy Savings (\$/year) ²	Combined Demand Savings (%)	Combined Demand Savings (\$/year) ³	Combined Savings (Energy+Demand) (\$/year)	Combined Estimated Cost (\$)		Simple Estimated Payback (yrs)	NOx Emissions Savings Annual (tons/yr)	SO ₂ Emissions Savings Annual (tons/yr)	CO ₂ Emissions Savings Annual (tons/yr)
	Site	Source					Marginal Cost ⁴	New System Cost ⁵				
Combination 1												
13 Improved HVAC System Efficiency (From 9.3 EER to 10.5 EER)	27.34%	16.79%	\$3,244	7.4%	\$178	\$3,422	\$1,366 - \$2,050		0.6 - 0.9	0.009	0.005	7.2
17 Demand Control Ventilation System								\$737 - \$1,105				
Combination 2												
9 Reduced Lighting Power Density (From 1.9 W/sqft to 0.89 W/sqft)	8.34%	15.21%	\$4,148	13.9%	\$335	\$4,482	\$8,000 - \$12,000		1.9 - 2.8	0.033	0.018	25.9
12 Exterior Lighting Power Reduction (From 3.61 kW to 2 kW & reduction in usage to 25% of current usage from 12:00 AM to 6:00 AM)								\$480 - \$720				
Combination 3												
9 Reduced Lighting Power Density (From 1.9 W/sqft to 0.89 W/sqft)	10.78%	16.52%	\$4,377	18.7%	\$449	\$4,827	\$8,000 - \$12,000		3.0 - 4.6	0.033	0.019	26.1
10 Reduced 24 Hour Lighting								\$0 - \$0				
11 Daylighting Control								\$6,663 - \$9,994				

Note:

- Total energy savings from heating, cooling, lighting, equipment and DHW for emissions reductions determination.
- Savings depend on fuel mix used.
* Energy Cost: Electricity = \$0.095/kWh & Demand = \$5.00/kWh
Natural gas = \$0.65/therm
- Yearly demand cost = Sum of monthly demand cost for 12 months
- Marginal cost = new system cost - original system cost
- New system cost = new system cost only
- See individual measures above for specific savings

[ASHRAE 90.1-2001 Code-Compliant Restaurant Building Description]

- * Building type: Restaurant
- * Gross area: 5,500 sq-ft (Dining Area: 4,000 sq-ft; Kitchen Area: 1,500 sq-ft)
- * Building dimension: 61 ft x 91 ft x 14 ft (WxLxH)
- * Dining room dimension: 61 ft x 66 ft x 14 ft (WxLxH)
- * Number of floors: 1
- * Floor-to-floor height: 14 ft
- * Window-to-wall ratio: 17% for the entire building (including kitchen)
- * HVAC system: EER 9.3 Rooftop PSZ & 80% Et Furnace
- * DHW: Et: 80% Gas Water heater

Savings calculations for all measures except exterior lighting performed for dining space only

Figure 1. Individual and Combined Energy Efficiency Measures for an ASHRAE 90.1-2001 Code-Compliant Restaurant Building for the CoA

[ASHRAE 90.1-2007 Code-Compliant Restaurant Building - Dining Zone Only]

Description of Individual Measures

Individual Measures	Annual Energy Savings (%) ¹		Annual Energy Savings (\$/year) ²	Annual Demand Savings (%)	Annual Demand Savings (\$/year) ³	Combined Savings (Energy+Demand) (\$/year)	Estimated Cost (\$)		Simple Estimated Payback (yrs)
	Site	Source					Marginal Cost ⁴	New System Cost ⁵	
A Envelope and Fenestration Measures									
1 Improved Wall Insulation (From R-13 + 3.8 c.i. to R-13 + 7.5 c.i.)	0.1%	0.1%	\$16	0.2%	\$3	\$19	\$506 - \$759		26.4 - 39.6
2 Improved Roof Insulation (From R-20 to R-25)	-0.4%	-0.5%	-\$110	-0.2%	-\$3	-\$114	\$1,760 - \$2,640		-
3 Improved Window U-value (From 0.65 to 0.35)	0.0%	-0.3%	-\$63	0.0%	\$0	-\$62	\$2,442 - \$3,662		-
4 Window Re-Distribution (East & West: 10%, South: 55.1%)	0.2%	0.2%	\$43	0.2%	\$4	\$46	\$0 - \$0		0.0 - 0.0
5 Window Shading (From None to 10ft)	0.7%	0.9%	\$175	0.9%	\$17	\$191	\$38,107 - \$57,160		199.0 - 298.6
6 Window Shading & Redistribution (East & West: 10%, South: 55.1% Shading on South only: 10ft)	0.6%	0.7%	\$137	0.7%	\$13	\$150	\$10,851 - \$16,276		72.3 - 108.4
7 Air Barrier (From 0.322 to 0.05)	0.5%	0.4%	\$62	0.8%	\$14	\$76	\$6,693 - \$10,039		88.4 - 132.5
B Interior Lighting Measures									
8 Reduced Lighting Power Density (From 1.6 W/sqft to 0.89 W/sqft)	9.8%	12.5%	\$2,430	11.5%	\$211	\$2,641	\$8,000 - \$12,000		3.0 - 4.5
9 Reduced 24 Hour Lighting	0.3%	0.4%	\$70	0.0%	\$0	\$71	\$0 - \$0		0.0 - 0.0
10 Daylighting Control	8.8%	10.9%	\$2,111	6.3%	\$115	\$2,226		\$6,663 - \$9,994	3.0 - 4.5
C Exterior Lighting Measures									
11 Exterior Lighting Power Reduction (From 3.61 kW to 2 kW & reduction in usage to 25% of current usage from 12:00 AM to 6:00 AM)	3.9%	4.8%	\$932	1.4%	\$25	\$957	\$480 - \$720		0.5 - 0.8
D HVAC System Measures									
12 Improved HVAC System Efficiency (From 10.8 EER to 11.5 EER)	1.2%	1.4%	\$274	2.5%	\$46	\$320	\$1,366 - \$2,050		4.3 - 6.4
13 Improved Fan Efficiency (From 55% to 65%)	1.5%	2.0%	\$384	1.8%	\$32	\$416	\$928 - \$1,392		2.2 - 3.3
14 Economizer	3.5%	4.3%	\$834	0.0%	\$0	\$834	\$1,523 - \$2,285		1.8 - 2.7
15 Improved Furnace Efficiency (From 80% to 90%)	0.1%	0.0%	\$5	0.0%	\$0	\$5	\$1,360 - \$2,040		250.0 - 375.0
E Service Hot Water System Measure									
16 Improved Efficiency for Service Water Heaters (From Et 80% to Et 95%)	4.3%	1.8%	\$224	0.0%	\$0	\$224	\$342 - \$513		1.5 - 2.3

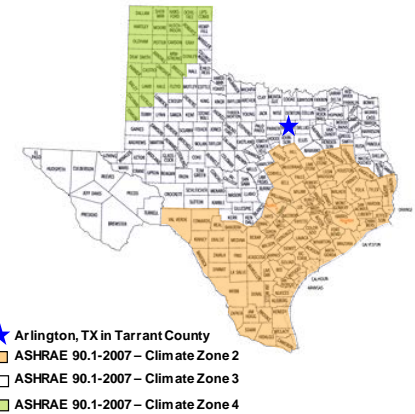

Description of Combined Measures

Combination of Measures ⁶	Combined Annual Energy Savings (%) ¹		Combined Energy Savings (\$/year) ²	Combined Demand Savings (%)	Combined Demand Savings (\$/year) ³	Combined Savings (Energy+Demand) (\$/year)	Combined Estimated Cost (\$)		Simple Estimated Payback (yrs)	NOx Emissions Savings Annual (tons/yr)	SO ₂ Emissions Savings Annual (tons/yr)	CO ₂ Emissions Savings Annual (tons/yr)
	Site	Source					Marginal Cost ⁴	New System Cost ⁵				
Combination 1												
8 Reduced Lighting Power Density (From 1.6 W/sqft to 0.89 W/sqft)							\$8,000 - \$12,000					
11 Exterior Lighting Power Reduction (From 3.61 kW to 2 kW & reduction in usage to 25% of current usage from 12:00 AM to 6:00 AM)	13.8%	17.3%	\$3,362	12.9%	\$236.00	\$3,598	\$480 - \$720		2.4 - 3.5	0.025	0.014	19.8
Combination 2												
10 Daylighting Control								\$6,663 - \$9,994				
14 Economizer							\$1,523 - \$2,285					
16 Improved Efficiency for Service Water Heaters (From Et 80% to Et 95%)	16.1%	16.4%	\$3,052	6.3%	\$114.75	\$3,167	\$342 - \$513		2.6 - 3.9	0.021	0.012	16.6
Combination 3												
8 Reduced Lighting Power Density (From 1.6 W/sqft to 0.89 W/sqft)							\$8,000 - \$12,000					
12 Improved HVAC System Efficiency (From 10.8 EER to 11.5 EER)							\$1,366 - \$2,050					
13 Improved Fan Efficiency (From 55% to 65%)	12.22%	15.51%	3022	15.52%	284	\$3,306	\$928 - \$1,392		2.8 - 4.2	0.023	0.013	17.9

Note:

- Total energy savings from heating, cooling, lighting, equipment and DHW for emissions reductions determination.
- Savings depend on fuel mix used.
* Energy Cost: Electricity = \$0.095/kWh & Demand = \$5.00/kWh
Natural gas = \$0.65/therm
- Yearly demand cost = Sum of monthly demand cost for 12 months
- Marginal cost = new system cost - original system cost
- New system cost = new system cost only
- See individual measures above for specific savings

[ASHRAE 90.1-2007 Code-Compliant Restaurant Building Description]

- * Building type: Restaurant
 - * Gross area: 5,500 sq-ft (Dining Area: 4,000 sq-ft; Kitchen Area: 1,500 sq-ft)
 - * Building dimension: 61 ft x 91 ft x 14 ft (WxLxH)
 - * Dining room dimension: 61 ft x 66 ft x 14 ft (WxLxH)
 - * Number of floors: 1
 - * Floor-to-floor height: 14 ft
 - * Window-to-wall ratio: 17% for the entire building (including kitchen)
 - * HVAC system: EER 10.8 Rooftop PSZ & 80% Et Furnace
 - * DHW: Et: 80% Gas Water heater
- Savings calculations for all measures except exterior lighting performed for dining space only

Figure 2. Individual and Combined Energy Efficiency Measures for an ASHRAE 90.1-2007 Code-Compliant Restaurant Building for the CoA

TABLE OF CONTENTS

1	INTRODUCTION.....	1
1.1	Organization of the Report	1
2	METHODOLOGY	2
2.1	Overview	2
2.2	Base-Case Building Description.....	4
2.3	Assumptions for Cost Analysis	4
3	PROPOSED ENERGY EFFICIENCY MEASURES FOR RESTAURANT BUILDINGS	8
3.1	Individual EEMs	8
3.2	Results of Simulation and Cost Analysis.....	12
3.2.1	Base-Case Energy Use.....	12
3.2.2	Energy Savings from Various Individual EEMs.....	12
3.2.3	Cost Effectiveness of Various Individual EEMs	15
3.2.4	Combined EEMs	16
4	SUMMARY	23
	APPENDIX A.....	26
	APPENDIX B.....	28
	APPENDIX C.....	29

LIST OF TABLES

Table 1a. Base-Case Building Description	5
Table 2. List of Energy Efficiency Measures.....	9
Table 3. Simulation Input Parameters of Individual EEMs for ASHRAE 90.1-2001 Code-Compliant Restaurant Building in CoA.....	10
Table 4. Simulation Input Parameters of Individual EEMs for ASHRAE 90.1-2007 Code-Compliant Restaurant Building in CoA.....	11
Table 5. Simulation Results of Individual EEMs for an ASHRAE 90.1-2001 Code-Compliant Restaurant Building in CoA.....	17
Table 6. Simulation Results of Individual EEMs for an ASHRAE 90.1-2007 Code-Compliant Restaurant Building in CoA.....	18
Table A-1. Summary of the Cost Information for an ASHRAE 90.1-2001 Code-Compliant Base Case	26
Table A-2. Summary of the Cost Information for an ASHRAE 90.1-2007 Code-Compliant Base Case	27
Table B-1: Summary of the Cost Information for the Implementation of Daylight Dimming Controls.....	28

LIST OF FIGURES

Figure 1. Individual and Combined Energy Efficiency Measures for an ASHRAE 90.1-2001 Code-Compliant Restaurant Building for CoA	iii
Figure 2. Individual and Combined Energy Efficiency Measures for an ASHRAE 90.1-2007 Code-Compliant Restaurant Building for CoA	iv
Figure 3. Tarrant County and Fort Worth TMY2 Weather File Used in the Analysis.....	3
Figure 4. eQuest Model of the Restaurant Building Prototype.	7
Figure 5. Site Energy Use of Various EEMs for an ASHRAE 90.1-2001 Code-Compliant Restaurant Building in CoA.....	19
Figure 6. Site Energy Use of Various EEMs for an ASHRAE 90.1-2007 Code-Compliant Restaurant Building in CoA.....	19
Figure 7. Source Energy Use of Various EEMs for an ASHRAE 90.1-2001 Code-Compliant Restaurant Building in CoA.....	20
Figure 8. Source Energy Use of Various EEMs for an ASHRAE 90.1-2007 Code-Compliant Restaurant Building in CoA.....	20
Figure 9. Individual and Combined Energy Efficiency Measures for an ASHRAE 90.1-2001 Code-Compliant Restaurant Building for CoA	21
Figure 10. Individual and Combined Energy Efficiency Measures for an ASHRAE 90.1-2007 Code-Compliant Restaurant Building for CoA	22
Figure C- 1: Annual Heating Energy End-Use for ASHRAE 90.1 2007 Base Case with and without the Option of DCV.....	29
Figure C- 2: Heating Energy End-Use, Occupancy Schedule and Ratio of Outside Air to Total Supply Air for ASHRAE 90.1 2007 Base Case with and without the Option of DCV for a Typical Winter Day – January 15 th	29
Figure C- 3: Ambient Dry Bulb Temperature, Solar Radiation and Zone Temperatures from DFW Weather File for a Typical Winter Day – January 15th	30
Figure C- 3: Annual Zone Temperatures for the ASHRAE 90.1 2007 Base Case.....	30

1 INTRODUCTION

The Energy Systems Laboratory was requested to develop cost-effective recommendations to maximize energy savings for residential and commercial buildings in the City of Arlington (CoA). This report presents the analysis results for restaurant buildings in the CoA.

The deliverables for the CoA in this report are:

- Recommendations of 18 energy efficiency measures (EEMs) to maximize energy savings for small retail buildings in the CoA with estimated cost of the improvement, simple payback calculations, and emissions savings for ASHRAE 2001 base-case.
- Recommendations of 16 energy efficiency measures (EEMs) to maximize energy savings for small retail buildings in the CoA with estimated cost of the improvement, simple payback calculations, and emissions savings for ASHRAE 2007 base-case.

1.1 Organization of the Report

The report is organized in the following order:

- Section 1 presents the introduction and purpose of the report.
- Section 2 presents the methodology that was used.
- Section 3 presents the proposed energy efficiency measures for restaurant buildings in the CoA, including savings from several individual measures along with the simple payback calculations.
- Section 4 is a summary which is followed by references.

2 METHODOLOGY

This section describes the methodology and assumptions that were used in this analysis: to develop the cost-effective recommendations for achieving energy performance better than ASHRAE 90.1-2001 and 2007 code-compliant buildings for small retails in the CoA. Section 2.1 presents an overall approach used in this analysis. Section 2.2 describes the base-case building characteristics. Section 2.3 presents assumptions used in cost analysis.

2.1 Overview

Based on several sources, recommendations were developed to achieve above-code energy performance for an ASHRAE 90.1-2001 and 2007 code compliant restaurant buildings in the CoA. The analysis was performed using the eQuest 3.64 simulation software (JJH. 2009). The software is based on the DOE-2.2 whole building energy simulation program. The simulations were performed using Fort Worth TMY2 weather file (Figure 5) for Tarrant County where the CoA is located. A total of 18 energy efficiency strategies were then applied to the 2001 base-case model and 16 energy efficiency strategies were applied to the 2007 base-case model to determine the savings of each measure. The implementation costs of each measure were also calculated along with simple payback calculations.

The measures were then combined to achieve 15% above code source energy savings for both the ASHRAE 90.1-2001 and 2007 code-compliant buildings. The results from individual measures and cost analysis were used to guide the selection of measures. As a result, three combinations were proposed for each base case. Each combination was formed to have a different payback period. Finally, the corresponding emissions savings of each combination were calculated based on the eCALC software developed by the Energy Systems Laboratory (Haberl et al, 2004).

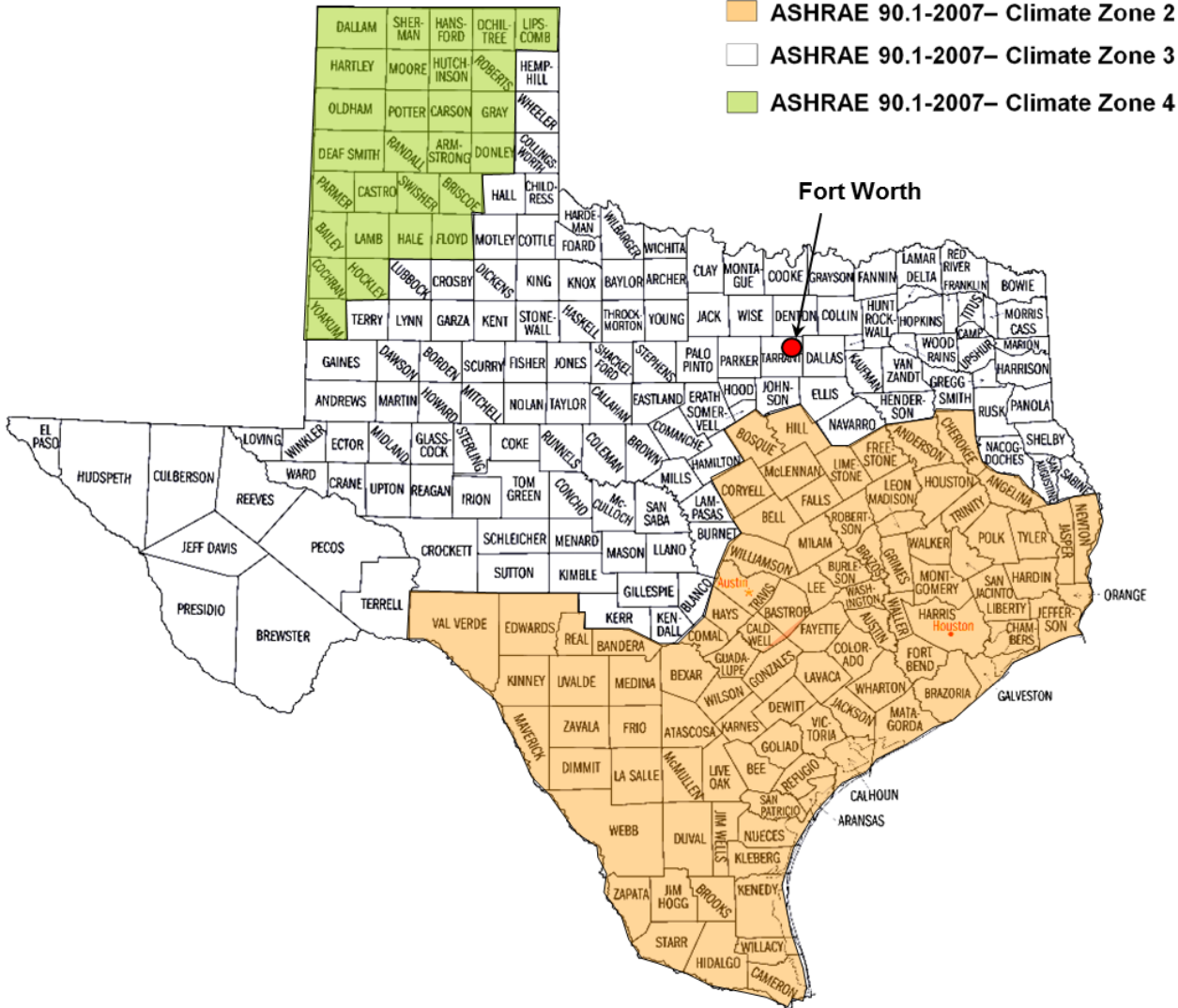

Figure 3. Tarrant County and Fort Worth TMY2 Weather File Used in the Analysis

2.2 Base-Case Building Description

The base-case building simulation model in this analysis is based on the *standard* design as defined in the ASHRAE 90.1-2001 and 2007 and certain assumptions, which are described throughout this document. The base-case building is based on a 5,500 sq. ft., one story restaurant building with an overall window to wall area ratio of 17%. Four thousand square feet of space was allocated to the dining area and 1,500 sq.ft. was allocated to the kitchen. However, due to restrictions associated with the design of kitchen ventilation systems only the 4000 sq.ft. of dining space was modeled for the purpose of this analysis.

The building envelope was modeled as a steel frame structure with the dining room windows allocated on the east, south and west orientations. The overall dimensions of the dining area were set at 60.5ft. wide by 66.05 ft. deep with a floor-to-ceiling height of 14 feet (Figure 4). The other envelope, space and system characteristics were determined from the general characteristics and the climate-specific characteristics as specified in the ASHRAE 90.1-2001 and 2007. Tables 1a and 1b summarize the code-compliance building characteristics that were used in this analysis.

2.3 Assumptions for Cost Analysis

The cost analysis for different measures was carried out based on utility costs of \$0.095/kWh for electricity, \$5.00/kWh for demand charge, and \$0.65/therm for natural gas. The electricity rate was determined based on the annual average prices of Texas commercial electricity for 2010 published by the U.S. DOE EIA (2011), and demand charges were from the previous study by Cho et al. (2007). For natural gas rates, the annual average rates calculated for Arlington were used (Atmos Energy 2011).

Table 1a. Base-Case Building Description

Characteristics	Information Source	Assumptions		Comments
		90.1-2001	90.1-2007	
Exterior Lighting				
Parking Lots	Table 9.4.5 ASHRAE 90.1 2007	N.A	0.15 W/sqft	
Façade & Landscape Lighting	Section 9.3.2 ASHRAE 90.1 2001	0.25 W/sqft	0.2 W/sqft	
Building Entrance (w/o canopy) Building Exit	Table 9.3.2 ASHRAE 90.1 2001 Table 9.4.5 ASHRAE 90.1 2007	33W/ lin ft of door 20W/lin ft of door	30 W/ft of door width 20 W/ft of door width	
Extra Power Allowance	Section 9.4.5 ASHRAE 90.1 2007	N.A	5%	
Equipment				
Electric Equipment in Dining Space	Table 9, Deru et al., 2011	5.625 W/sqft		
HVAC Systems				
HVAC System Type	a) DOE Reference FSR Building (1) b) EPLUS file, Deru et al. 2011 c) College Station Restaurant Survey	Packaged single zone units w/ gas fired furnace		
HVAC Efficiency	For cooling: Table 6.2.1A, ASHRAE 90.1 2001 For heating: Table 6.2.1E, ASHRAE 90.1 2001 For cooling: Table 6.8.1B, ASHRAE 90.1 2007 For heating: Table 6.8.1E, ASHRAE 90.1 2007	?240,000 Btu/hr and < 760,000 Btu/hr 9.3 EER Heating: ?225,000Btu/hr 80% Ec	?135,000 Btu/hr and < 240,000 Btu/hr 10.8 EER Heating: ?225,000Btu/hr 80% Ec	
HVAC Fan Specifications	Sec 3.4.6 Zhang et al. (2010) Used by ASHRAE 90.1 S5PC to develop fan power requirements for the standard. Common design practice.	Static pressure : 2.5 in-wc Fan efficiency: Overall Eff: 55% (Motor eff. @1800rpm: 87.5)		
Economizer		N.A		
Demand Control Ventilation	Section 6.4.3.9, ASHRAE 90.1 2007	N.A	Required as per code	
Service Hot Water				
Service Hot Water	Table 9, Deru et al. (2011)	Peak Hot Water Flow Rate - 133 gal/hr		For assumed peak of 100 meals, assuming that not all the seats are occupied at peak time.
		Storage Type Water Heater - 100 gallon		
	ASHRAE 90.1 2001 Table 7.8, ASHRAE 90.1 2007	Thermal Eff. >75,000 Btu/hr Et: 80%		

Table 1b. Base-Case Building Description Cont....

Characteristics	Information Source	Assumptions		Comments
		90.1-2001	90.1-2007	
Exterior Lighting				
Parking Lots	Table 9.4.5 ASHRAE 90.1 2007	N.A	0.15 W/sqft	
Façade & Landscape Lighting	Section 9.3.2 ASHRAE 90.1 2001	0.25 W/sqft	0.2 W/sqft	
Building Entrance (w/o canopy) Building Exit	Table 9.3.2 ASHRAE 90.1 2001 Table 9.4.5 ASHRAE 90.1 2007	33W/ lin ft of door 20W/lin ft of door	30 W/ft of door width 20 W/ft of door width	
Extra Power Allowance	Section 9.4.5 ASHRAE 90.1 2007	N.A	5%	
Equipment				
Electric Equipment in Dining Space	Table 9, Deru et al., 2011	5.625 W/sqft		
HVAC Systems				
HVAC System Type	a) DOE Reference FSR Building (1) b) EPLUS file, Deru et al. 2011 c) College Station Restaurant Survey	Packaged single zone units w/ gas fired furnace		
HVAC Efficiency	For cooling: Table 6.2.1A, ASHRAE 90.1 2001 For heating: Table 6.2.1E, ASHRAE 90.1 2001 For cooling: Table 6.8.1B, ASHRAE 90.1 2007 For heating: Table 6.8.1E, ASHRAE 90.1 2007	?240,000 Btu/hr and < 760,000 Btu/hr 9.3 EER Heating: ?225,000Btu/hr 80% Ec	?135,000 Btu/hr and < 240,000 Btu/hr 10.8 EER Heating: ?225,000Btu/hr 80% Ec	
HVAC Fan Specifications	Sec 3.4.6 Zhang et al. (2010) Used by ASHRAE 90.1 SSPC to develop fan power requirements for the standard. Common design practice.	Static pressure : 2.5 in-wc Fan efficiency: Overall Eff: 55% (Motor eff. @1800rpm: 87.5)		
Economizer		N.A		
Demand Control Ventilation	Section 6.4.3.9, ASHRAE 90.1 2007	N.A	Required as per code	
Service Hot Water				
Service Hot Water	Table 9, Deru et al. (2011)	Peak Hot Water Flow Rate - 133 gal/hr		For assumed peak of 100 meals, assuming that not all the seats are occupied at peak time.
		Storage Type Water Heater - 100 gallon		
	ASHRAE 90.1 2001 Table 7.8, ASHRAE 90.1 2007	Thermal Eff. >75,000 Btu/hr Et: 80%		

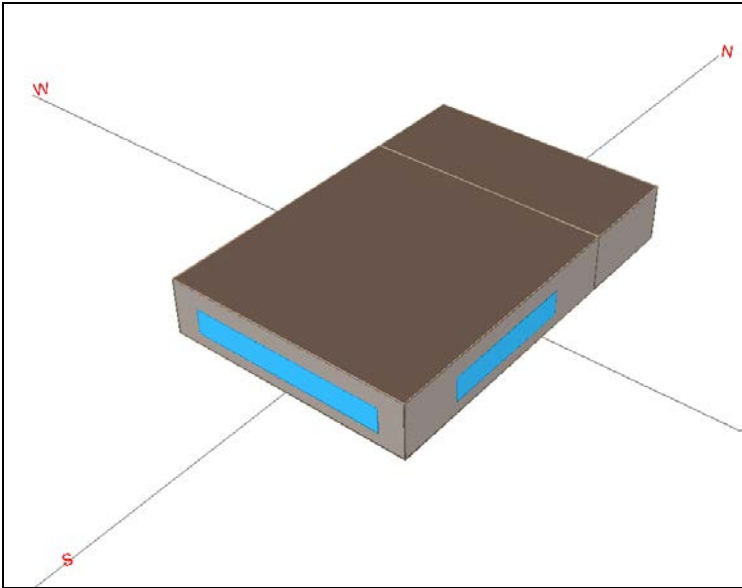

a. Restaurant building: 5,500 sq.ft

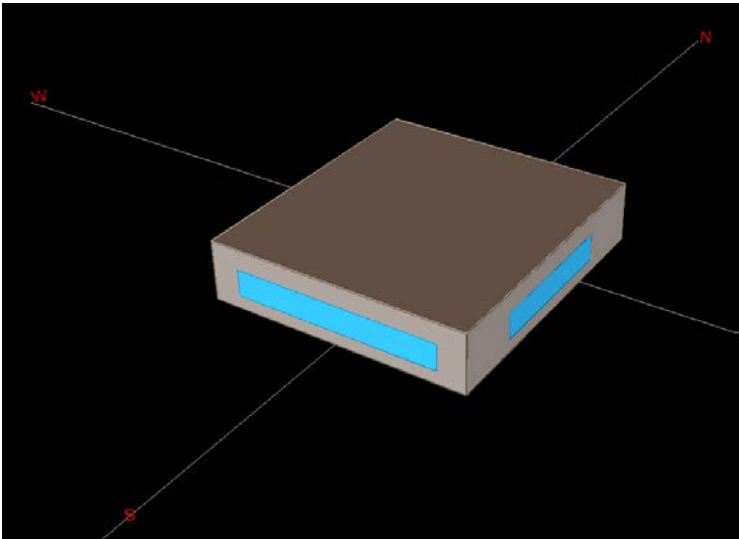

b. Restaurant Model: 4,000 sq. ft.

Figure 4. eQuest Model of the Restaurant Building Prototype.

3 PROPOSED ENERGY EFFICIENCY MEASURES FOR RESTAURANT BUILDINGS

This section documents the energy efficiency measures (EEMs) analyzed for restaurant buildings to achieve above-code energy performance based on the ASHRAE 90.1-2001 and 2007 code-compliant restaurant building in Tarrant County, Texas, where the CoA is located. Section 3.1 gives a brief description of the individual EEMs and provides input parameters used in the simulation of each EEM. Section 3.2 presents the results of simulation and cost analysis.

3.1 Individual EEMs

Table 2 and Table 3 list the EEMs considered in this analysis for ASHRAE 90.1 2001 and ASHRAE 90.1 2007 codes respectively. These include measures for the building envelope and fenestration, HVAC system, service hot water (SHW) system, and options for lighting systems. These measures were simulated by modifying the selected parameters used for the DOE-2 simulation tool. Tables 4 and 5 show the measures as input parameters for the simulation analysis.

Table 2. List of Energy Efficiency Measures

	EEM#	EEM Description
Envelope and Fenestration Measures	1	Improved Wall Insulation (ASHRAE 90.1-2001: From R-13 to R-13 + 7.5 c.i. ASHRAE 90.1-2007: From R-13+3.5 c.i to R-13 + 7.5 c.i.)
	2	Improved Roof Insulation (ASHRAE 90.1-2001: From R-15 to R-25 ASHRAE 90.1-2007: From R-20 to R-25)
	3	Reduced Roof Absorptance (ASHRAE 90.1-2001: From 0.7 to 0.3)
	4	Improved Window U-value (ASHRAE 90.1-2001: From 1.22 to 0.35 ASHRAE 90.1-2007: From 0.65 to 0.35)
	5	Window Re-Distribution (East & West: 10%, South: 55.1%)
	6	Window Shading (From None to 10 ft)
	7	Window Shading & Redistribution (East & West: 10%, South: 55.1%; Shading on South only: 10ft)
	8	Air Barrier (From 0.322 to 0.05)
interior Lighting Measures	9	Reduced Lighting Power Density (ASHRAE 90.1-2001: From 1.9 W/sqft to 0.89 W/sqft ASHRAE 90.1-2007: From 1.6 W/sqft to 0.89 W/sqft)
	10	Reduced 24 Hour Lighting
	11	Daylighting Control
Exterior Lighting Measures	12	Exterior Lighting Power Reduction (From 3.61 kW to 2 kW & Reduction in usage to 25% of current usage from 12:00 AM to 6:00 AM)
HVAC System Measures	13	Improved HVAC System Efficiency (ASHRAE 90.1-2001: From 9.3 EER to 10.5 EER ASHRAE 90.1-2007: From 10.8 EER to 11.5 EER)
	14	Improved Fan Efficiency (From 55% to 65%)
	15	Economizer
	16	Improved Furnace Efficiency (From 80% to 90%)
	17	Demand Control Ventilation System
Service Hot Water Measures	18	Improved Efficiency for Service Water Heaters (From Et: 80% to Et: 95%)

Table 3. Simulation Input Parameters of Individual EEMs for ASHRAE 90.1-2001 Code-Compliant Restaurant Building in the CoA

	EEM	Energy Efficiency Measure	Wall C.I. R-value	Roof Insulation R-Value	Roof Absorptance	Window Glazing U-Value	Window Re-Dist.			Shading			Window Re-Dist./Shading			Air Barrier	Reduced LPD	Reduced 24 Hour Lighting	Daylighting Control	Ext. LPD Reduction	Improved HVAC Eff.	Improved Fan Eff.	Economizer	Improved Furnace Eff.	DCV System	Improved Eff. for SWH
							East	South	West	East	South	West	East	South	West											
		90.1-2001 Base case (CoA)	13	15	0.7	1.22	16.7	35	16.7	0	0	0	16.7/0	35/0	16.7/0	No	1.9	No	No	3.61	9.3	55	No	80	No	80
Envelope and Fenestration Measures	1	Improved Wall Insulation (From R-13 to R-13 + 7.5 c.i.)	13+7.5	15	0.7	1.22	16.7	35	16.7	0	0	0	16.7/0	35/0	16.7/0	No	1.9	No	No	3.61	9.3	55	No	80	No	80
	2	Improved Roof Insulation (From R-15 to R-25)	13	25	0.7	1.22	16.7	35	16.7	0	0	0	16.7/0	35/0	16.7/0	No	1.9	No	No	3.61	9.3	55	No	80	No	80
	3	Reduced Roof Absorptance (From 0.7 to 0.3)	13	15	0.3	1.22	16.7	35	16.7	0	0	0	16.7/0	35/0	16.7/0	No	1.9	No	No	3.61	9.3	55	No	80	No	80
	4	Improved Window U-value (From 1.22 to 0.35)	13	15	0.7	0.35	16.7	35	16.7	0	0	0	16.7/0	35/0	16.7/0	No	1.9	No	No	3.61	9.3	55	No	80	No	80
	5	Window Re-Distribution (East & West: 10%, South: 55.1%)	13	15	0.7	1.22	10	55.1	10	0	0	0	16.7/0	35/0	16.7/0	No	1.9	No	No	3.61	9.3	55	No	80	No	80
	6	Window Shading (From None to 10 ft)	13	15	0.7	1.22	16.7	35	16.7	10	10	10	16.7/0	35/0	16.7/0	No	1.9	No	No	3.61	9.3	55	No	80	No	80
	7	Window Shading & Redistribution (East & West: 10%, South: 55.1%)	13	15	0.7	1.22	16.7	35	16.7	0	0	0	10	55.1	10	No	1.9	No	No	3.61	9.3	55	No	80	No	80
	8	Air Barrier (From 0.322 to 0.05)	13	15	0.7	1.22	16.7	35	16.7	0	0	0	16.7/0	35/0	16.7/0	Yes	1.9	No	No	3.61	9.3	55	No	80	No	80
Interior Lighting Measures	9	Reduced Lighting Power Density (From 1.9 W/sqft to 0.89 W/sqft)	13	15	0.7	1.22	16.7	35	16.7	0	0	0	16.7/0	35/0	16.7/0	No	0.89	No	No	3.61	9.3	55	No	80	No	80
	10	Reduced 24 Hour Lighting	13	15	0.7	1.22	16.7	35	16.7	0	0	0	16.7/0	35/0	16.7/0	No	1.9	Yes	No	3.61	9.3	55	No	80	No	80
	11	Daylighting Control	13	15	0.7	1.22	16.7	35	16.7	0	0	0	16.7/0	35/0	16.7/0	No	1.9	No	Yes	3.61	9.3	55	No	80	No	80
Exterior Lighting Measures	12	Exterior Lighting Power Reduction (From 3.61 kW to 2 kW)	13	15	0.7	1.22	16.7	35	16.7	0	0	0	16.7/0	35/0	16.7/0	No	1.9	No	No	2	9.3	55	No	80	No	80
HVAC System Measures	13	Improved HVAC System Efficiency (From 9.3 EER to 10.5 EER)	13	15	0.7	1.22	16.7	35	16.7	0	0	0	16.7/0	35/0	16.7/0	No	1.9	No	No	3.61	10.5	55	No	80	No	80
	14	Improved Fan Efficiency (From 55% to 65%)	13	15	0.7	1.22	16.7	35	16.7	0	0	0	16.7/0	35/0	16.7/0	No	1.9	No	No	3.61	9.3	65	No	80	No	80
	15	Economizer	13	15	0.7	1.22	16.7	35	16.7	0	0	0	16.7/0	35/0	16.7/0	No	1.9	No	No	3.61	9.3	55	Yes	80	No	80
	16	Improved Furnace Efficiency (From 80% to 90%)	13	15	0.7	1.22	16.7	35	16.7	0	0	0	16.7/0	35/0	16.7/0	No	1.9	No	No	3.61	9.3	55	No	90	No	80
	17	Demand Control Ventilation System	13	15	0.7	1.22	16.7	35	16.7	0	0	0	16.7/0	35/0	16.7/0	No	1.9	No	No	3.61	9.3	55	No	80	Yes	80
Service Hot Water Measures	18	Improved Efficiency for Service Water Heaters (From Et 80% to Et 95%)	13	15	0.7	1.22	16.7	35	16.7	0	0	0	16.7/0	35/0	16.7/0	No	1.9	No	No	3.61	9.3	55	No	80	No	95

Table 4. Simulation Input Parameters of Individual EEMs for ASHRAE 90.1-2007 Code-Compliant Restaurant Building in the CoA

	EEM	Energy Efficiency Measure	Wall C.I. R-value	Roof Insulation R-Value	Roof Absorptance	Window Glazing U-Value	Window Re-Dist.			Shading			Window Re-Dist./Shading			Air Barrier	Reduced LPD	Reduced 24 Hour Lighting	Daylighting Control	Ext. LPD Reduction	Improved HVAC Eff.	Improved Fan Eff.	Economizer	Improved Furnace Eff.	DCV System	Improved Eff. for SWH
							East	South	West	East	South	West	East	South	West											
		90.1-2007 Base case (CoA)	13+7.5	20	0.3	0.65	16.7	35	16.7	0	0	0	16.7/0	35/0	16.7/0	No	1.6	No	No	3.61	10.8	55	No	80	Yes	80
Envelope and Fenestration Measures	1	Improved Wall Insulation (From R-13+3.8 to R-13+ 7.5 c.i.)	13+7.5	20	0.3	0.65	16.7	35	16.7	0	0	0	16.7/0	35/0	16.7/0	No	1.6	No	No	3.61	10.8	55	No	80	Yes	80
	2	Improved Roof Insulation (From R-20 to R-25)	13+7.5	25	0.3	0.65	16.7	35	16.7	0	0	0	16.7/0	35/0	16.7/0	No	1.6	No	No	3.61	10.8	55	No	80	Yes	80
	3	Reduced Roof Absorptance (From 0.3 to 0.3)	13+7.5	20	0.3	0.65	16.7	35	16.7	0	0	0	16.7/0	35/0	16.7/0	No	1.6	No	No	3.61	10.8	55	No	80	Yes	80
	4	Improved Window U-value (From 0.65 to 0.35)	13+7.5	20	0.3	0.35	16.7	35	16.7	0	0	0	16.7/0	35/0	16.7/0	No	1.6	No	No	3.61	10.8	55	No	80	Yes	80
	5	Window Re-Distribution (East & West: 10%, South: 55.1%)	13+7.5	20	0.3	0.65	10	55.1	10	0	0	0	16.7/0	35/0	16.7/0	No	1.6	No	No	3.61	10.8	55	No	80	Yes	80
	6	Window Shading (From None to 10 ft)	13+7.5	20	0.3	0.65	16.7	35	16.7	10	10	10	16.7/0	35/0	16.7/0	No	1.6	No	No	3.61	10.8	55	No	80	Yes	80
	7	Window Shading & Redistribution (East & West: 10%, South: 55.1%)	13+7.5	20	0.3	0.65	16.7	35	16.7	0	0	0	10	55.1	10	No	1.6	No	No	3.61	10.8	55	No	80	Yes	80
	8	Air Barrier (From 0.322 to 0.05)	13+7.5	20	0.3	0.65	16.7	35	16.7	0	0	0	16.7/0	35/0	16.7/0	Yes	1.6	No	No	3.61	10.8	55	No	80	Yes	80
Interior Lighting Measures	9	Reduced Lighting Power Density (From 1.6 W/sqft to 0.89 W/sqft)	13+7.5	20	0.3	0.65	16.7	35	16.7	0	0	0	16.7/0	35/0	16.7/0	No	0.89	No	No	3.61	10.8	55	No	80	Yes	80
	10	Reduced 24 Hour Lighting	13+7.5	20	0.3	0.65	16.7	35	16.7	0	0	0	16.7/0	35/0	16.7/0	No	1.6	Yes	No	3.61	10.8	55	No	80	Yes	80
	11	Daylighting Control	13+7.5	20	0.3	0.65	16.7	35	16.7	0	0	0	16.7/0	35/0	16.7/0	No	1.6	No	Yes	3.61	10.8	55	No	80	Yes	80
Exterior Lighting Measures	12	Exterior Lighting Power Reduction (From 3.61 kW to 2 kW)	13+7.5	20	0.3	0.65	16.7	35	16.7	0	0	0	16.7/0	35/0	16.7/0	No	1.6	No	No	2	10.8	55	No	80	Yes	80
HVAC System Measures	13	Improved HVAC System Efficiency (From 10.8 EER to 11.5 EER)	13+7.5	20	0.3	0.65	16.7	35	16.7	0	0	0	16.7/0	35/0	16.7/0	No	1.6	No	No	3.61	11.5	55	No	80	Yes	80
	14	Improved Fan Efficiency (From 55% to 65%)	13+7.5	20	0.3	0.65	16.7	35	16.7	0	0	0	16.7/0	35/0	16.7/0	No	1.6	No	No	3.61	10.8	65	No	80	Yes	80
	15	Economizer	13+7.5	20	0.3	0.65	16.7	35	16.7	0	0	0	16.7/0	35/0	16.7/0	No	1.6	No	No	3.61	10.8	55	Yes	80	Yes	80
	16	Improved Furnace Efficiency (From 80% to 90%)	13+7.5	20	0.3	0.65	16.7	35	16.7	0	0	0	16.7/0	35/0	16.7/0	No	1.6	No	No	3.61	10.8	55	No	90	Yes	80
	17	Demand Control Ventilation System	13+7.5	20	0.3	0.65	16.7	35	16.7	0	0	0	16.7/0	35/0	16.7/0	No	1.6	No	No	3.61	10.8	55	No	80	Yes	80
Service Hot Water Measures	18	Improved Efficiency for Service Water Heaters (From Et 80% to Et 95%)	13+7.5	20	0.3	0.65	16.7	35	16.7	0	0	0	16.7/0	35/0	16.7/0	No	1.6	No	No	3.61	10.8	55	No	80	Yes	95

3.2 Results of Simulation and Cost Analysis

3.2.1 Base-Case Energy Use

The annual total energy consumption of the ASHRAE 90.1-2001 base case:

- a) Site energy use by end-uses: 1,286 MMBtu/yr, including
 - 17% for cooling;
 - 30% for heating;
 - 13% for lighting;
 - 13% for equipment;
 - 6% for fans and pumps;
 - 17% for service water heating; and
 - 4% for exterior lighting.
- b) Source energy use by fuel type: 2,815 MMBtu/yr, including
 - 76% for electricity; and
 - 24% for natural gas.

The annual total energy consumption of the ASHRAE 90.1-2007 base case:

- a) Site energy use by end-uses: 805 MMBtu/yr, including
 - 20% for cooling;
 - 1% for heating;
 - 18% for lighting;
 - 20% for equipment;
 - 9% for fans and pumps; and
 - 27% for service water heating; and
 - 6% for exterior lighting.
- b) Source energy use by fuel type: 2,079 MMBtu/yr, including
 - 88% for electricity; and
 - 12% for natural gas.

Since the above-code performance is determined based on source energy consumption, the measures reducing electricity consumption will yield higher savings percentage than the measures decreasing natural gas consumption.

3.2.2 Energy Savings from Various Individual EEMs

Tables 6 and 7 summarize the savings achieved from proposed EEMs and cost analysis for the ASHRAE 90.1-2001 and 2007 code-compliant small retail buildings, including:

- Annual site energy consumption for different end-uses and total;
- Annual source energy consumption for different fuel types;
- Above-code savings (%) for site and source and \$ savings;
- Increased cost of implementation (obtained from various resources listed in Appendix A); and
- Simple payback period for each measure.

The annual site energy use was obtained from the BEPS report of the DOE-2 output and then converted to source energy¹. Figures 5-10 provide a graphical representation of the site/source energy consumption of the individual EEMs for the ASHRAE 90.1-2001 and 2007 code-compliant base-case small retail building.

The savings results are:

- a) Increased Wall Insulation R-Value:
 - ASHRAE 90.1-2001: 1% (site energy savings) and 0.7% (source energy savings) and
 - ASHRAE 90.1-2007: 0.15% (site energy savings) and 0.1% (source energy savings).
- b) Increased Roof Insulation R-Value:
 - ASHRAE 90.1-2001: 1% (site energy savings) and 0.8% (source energy savings) and
 - ASHRAE 90.1-2007: -0.4% (site energy savings) and -0.5% (source energy savings).
- c) Reduced Roof Absorptance:
 - ASHRAE 90.1-2001: 0.2% (site energy savings) and 0.5% (source energy savings) and
- d) Decreased Glazing U-Value:
 - ASHRAE 90.1-2001: 2.7% (site energy savings) and 1.2% (source energy savings) and
 - ASHRAE 90.1-2007: 0% (site energy savings) and -0.3% (source energy savings).
- e) Window Re-distribution:
 - ASHRAE 90.1-2001: -0.3% (site energy savings) and 0.3% (source energy savings) and
 - ASHRAE 90.1-2007: 0.2% (site energy savings) and 0.2% (source energy savings).
- f) Window Shading:
 - ASHRAE 90.1-2001: -0.1% (site energy savings) and 0.7% (source energy savings) and
 - ASHRAE 90.1-2007: 0.7% (site energy savings) and 0.9% (source energy savings).
- g) Window Shading and Re-Distribution:
 - ASHRAE 90.1-2001: 0% (site energy savings) and 0.4% (source energy savings) and
 - ASHRAE 90.1-2007: 0.6% (site energy savings) and 0.7% (source energy savings).
- h) Air-Barrier:
 - ASHRAE 90.1-2001: 0.9% (site energy savings) and 0.6% (source energy savings) and
 - ASHRAE 90.1-2007: 0.5% (site energy savings) and 0.4% (source energy savings).
- i) Reduced Lighting Power Density:
 - ASHRAE 90.1-2001: 5.6% (site energy savings) and 11.3% (source energy savings) and
 - ASHRAE 90.1-2007: 9.8% (site energy savings) and 12.5% (source energy savings).
- j) Reduced 24-Hour Lighting:
 - ASHRAE 90.1-2001: 0.1% (site energy savings) and 0.3% (source energy savings) and
 - ASHRAE 90.1-2007: 0.3% (site energy savings) and 0.4% (source energy savings).
- k) Daylighting Control:
 - ASHRAE 90.1-2001: 4.6% (site energy savings) and 8.3% (source energy savings) and

¹ The source energy multipliers used in this analysis were 3.16 for electricity and 1.1 for natural gas based on Section 405.3 of the 2009 IECC.

- ASHRAE 90.1-2007: 8.8% (site energy savings) and 10.9% (source energy savings).
- l) Exterior Lighting Power Reduction:
- ASHRAE 90.1-2001: 2.7% (site energy savings) and 3.9% (source energy savings) and
 - ASHRAE 90.1-2007: 3.9% (site energy savings) and 4.8% (source energy savings).
- m) Improved HVAC System Efficiency:
- ASHRAE 90.1-2001: 1.9% (site energy savings) and 2.7% (source energy savings) and
 - ASHRAE 90.1-2007: 1.2% (site energy savings) and 1.4% (source energy savings).
- n) Improved Fan Efficiency:
- ASHRAE 90.1-2001: 0.6% (site energy savings) and 1.4% (source energy savings) and
 - ASHRAE 90.1-2007: 1.5% (site energy savings) and 2.0% (source energy savings).
- o) Economizer:
- ASHRAE 90.1-2001: 0% (site energy savings) and 0% (source energy savings) and
 - ASHRAE 90.1-2007: 3.5% (site energy savings) and 4.3% (source energy savings).
- p) Improved Furnace Efficiency:
- ASHRAE 90.1-2001: 3.4% (site energy savings) and 1.7% (source energy savings) and
 - ASHRAE 90.1-2007: 0.1% (site energy savings) and 0% (source energy savings).
- q) Demand Control Ventilation:
- ASHRAE 90.1-2001: 25.6% (site energy savings) and 14.3% (source energy savings)
- r) Service Hot Water System:
- ASHRAE 90.1-2001: 2.7% (site energy savings) and 1.3% (source energy savings) and
 - ASHRAE 90.1-2007: 4.3% (site energy savings) and 1.8% (source energy savings).

Of the 18 measures for the ASHRAE 90.1-2001 code-compliant building, reduced lighting power density and demand control ventilation measures present the most savings: 11.3% to 14.3% source energy savings. Of the 16 measures for the ASHRAE 90.1-2007 code-compliant building, reduced lighting power density and daylight dimming control measures present the most savings: 12.5% to 10.9% source energy savings.

Envelope and fenestration measures, increased roof and wall insulation and decreased glazing u-value result in minimal savings due to high internal loads of the base case buildings. Lighting measures resulted in high savings with reducing in lighting power density and implementation of daylight dimming controls resulting in source energy savings of 11.3% and 12.6% for the ASHRAE 90.1 2001 and 2007 codes respectively. The exterior lighting measure also fared well with source energy savings of 3.9% and 4.8% for the ASHRAE 90.1 2001 and 2007 codes respectively. Among the HVAC system measures, CO₂-based demand-controlled ventilation implemented in the ASHRAE 90.1 2001 base case provided 14.3% source energy savings. Improved air conditioner efficiency measure results in a source energy savings: 2.7% and 1.4% for the two codes respectively. Improved furnace efficiency provides a source energy savings of 1.7% for the 2001 base case and has negligible impact in the 2007 base case. On the other hand, the installation of an economizer, while not making an impact in the 2001 set of simulations, provided 4.3% in source energy savings for the corresponding 2007 base case. The implementation of service hot water measures resulted in source energy savings between 1.3% -1.8% for both the codes.

3.2.3 Cost Effectiveness of Various Individual EEMs

It should be noted that, due to the difference in the unit cost of electricity and gas, the energy cost savings for a measure will not always coincide with the energy savings. These savings depend on the fuel type associated with the end use affected from that measure. Because of this, measures that reduce electricity use for space cooling or lighting and equipment resulted in significant energy cost savings compared to the measures that reduce only gas use.

Both interior and exterior lighting measures show a significant reduction in electricity use. Therefore these measures are very effective in reducing the overall energy cost. The measures that reduce electricity use for cooling and fans and pumps also result in high energy cost savings. These measures include improved air conditioner efficiency and improved fan efficiency. A CO₂ based demand-controlled ventilation measure also yields a relatively high cost savings for the 2001 base case.

To estimate the cost-effectiveness of measures, the implementation costs of each measure (obtained from various resources listed in Appendix A), were surveyed and simple payback calculations were performed. The cost-effectiveness of a measure depends upon the energy cost savings versus the cost of implementation. Specific to the ASHRAE 90.1-2001 base-case, installation of demand control ventilation proved to be most effective with a payback period of less than a year. Also, implementation of the exterior lighting power reduction measure provides the short payback period of less than a year for both the ASHRAE 90.1-2001 and ASHRAE 90.1-2007 codes. Both the reduced lighting power density measure and the daylight dimming control measure also prove to be cost-effective with payback periods of 2.3 to 4.5 years for both the ASHRAE 90.1 codes. Improved HVAC system efficiency provides a payback period ranging from 1.6 years to 6.4 years for both the codes. Improved fan efficiency provides a payback period of 2.2 to 3.3 years for both the ASHRAE 90.1- 2001 and ASHRAE 90.1-2007 codes. The installation of the economizer did not prove to be effective for the ASHRAE 90.1-2001 base case, but proved to be highly effective in the ASHRAE 90.1-2007 base case with a payback period of 1.8 to 2.7 years. On the other hand, while improved furnace efficiency was not effective for the ASHRAE 90.1-2007 base case, this efficiency measure proved to be reasonably effective for the ASHRAE 90.1-2001 base case with a payback period of 4.8 – 7.2 years.

3.2.4 Combined EEMs

Individual measures were subsequently grouped to form combined measures. The results from individual measures and cost analysis were used to guide the selection of measures for this group analysis. The measures were combined to achieve the total source energy savings² of the group is 15% above the base-case simulation of each ASHRAE 90.1-2001 and 2007 code-compliant restaurant building. Because the measures are interdependent in many cases, the resultant savings of grouped measures are not always the same as the sum of the savings of the individual measures. In a similar fashion, like the analysis of the individual measures, the group measures were simulated by modifying all the parameters of combined individual measures.

As shown in Figures 9 and 10, three group measures were proposed for each base case. In each figure, the first table summarizes the results obtained from individual measures in terms of annual site energy savings, annual source energy savings, annual demand savings, energy cost savings, estimated costs for each measure implemented individually, and payback period. The second table summarizes the results obtained by implementing combined measures to achieve 15% or more total source energy savings, and includes: energy savings, energy cost savings, estimated costs, payback period for each combination, and annual NO_x-lbs/yr, SO₂-lbs/yr, and CO₂-lbs/yr emission savings.

The example groups represent one way of grouping to achieve 15% savings above the base case. In this analysis, each combination was intended to have a different payback period. The most cost-effective combination (combination 1) has a payback period of:

- a) ASHRAE 90.1-2001: 0.6 to 0.9 years and
- b) ASHRAE 90.1-2007: 2.4 to 3.5 years.

A payback period of the least cost-effective combination (combination 3) is:

- a) ASHRAE 90.1-2001: 3.0 to 4.6 years and
- b) ASHRAE 90.1-2007: 2.8 to 4.2 years.

² The estimated total source energy savings include heating, cooling, lighting, equipment, and SHW for emissions reductions determination.

Table 5. Simulation Results of Individual EEMs for an ASHRAE 90.1-2001 Code-Compliant Restaurant Building in the CoA

EEM#	Energy Efficiency Measure	Total Energy Use & Savings - SITE (MMBtu)										Total Energy Use & Savings - SOURCE (MMBtu)				\$ Savings (\$)	Increased Marginal Cost (\$)	Increased New System Cost (\$)	Pay back (Years)
		Space Cool	Vent. Fans	Pumps & Aux.	Ext. Usage	Misc. Equip.	Area Lights	Space Heat	SHW	Total Energy Use	% Energy Savings above Base Case	Elec.	NG	Total Energy Use	% Energy Savings above Base Case				
	90.1-2001 Base Case Dining Zone Only	223	77	0	51	165	168	388	216	1286	0.0%	2152	664	2815					
Envelope & Fenestration Measures	1 Improved Wall Insulation (From R-13 to R-13 + 7.5 c.i.)	222	76	0	51	165	168	378	216	1274	1.0%	2143	653	2796	0.7%	157	\$2,655 - \$3,983		16.9 - 25.3
	2 Improved Roof Insulation (From R-15 to R-25)	220	75	0	51	165	168	380	216	1274	1.0%	2138	655	2793	0.8%	207	\$3,856 - \$5,784		18.7 - 28.0
	3 Reduced Roof Absorptance (From 0.7 to 0.36)	219	75	0	51	165	168	392	216	1284	0.2%	2132	668	2800	0.5%	177	\$1,760 - \$2,640		9.9 - 14.9
	4 Improved Window U-value (From 1.22 to 0.35)	227	76	0	51	165	168	350	216	1251	2.7%	2159	623	2781	1.2%	180	\$5,818 - \$8,728		32.3 - 48.4
	5 Window Re-Distribution (East & West: 10%, South: 55.1%)	222	76	0	51	165	168	386	216	1283	0.3%	2146	662	2808	0.3%	69	\$0 - \$0		0.0 - 0.0
	6 Window Shading (From None to 10 ft)	216	74	0	51	165	168	399	216	1287	-0.1%	2119	676	2795	0.7%	279	\$38,107 - \$57,160		136.6 - 204.9
	7 Window Shading & Redistribution (East & West: 10%, South: 55.1% Shading on South only: 10ft)	219	76	0	51	165	168	393	216	1287	0.0%	2135	670	2804	0.4%	147	\$10,851 - \$16,276		73.6 - 110.4
	8 Air Barrier (From 0.322 to 0.05)	222	76	0	51	165	168	378	216	1274	0.9%	2144	653	2797	0.6%	148	\$5,885 - \$8,827		39.8 - 59.8
Lighting Measures	9 Reduced Lighting Power Density (From 1.9 W/sqft to 0.89 W/sqft)	201	71	0	51	165	78	432	216	1214	5.6%	1786	712	2498	11.3%	3435	\$8,000 - \$12,000		2.3 - 3.5
	10 Reduced 24 Hour Lighting	222	77	0	51	165	166	389	216	1285	0.1%	2143	665	2808	0.3%	73			0.0 - 0.0
	11 Daylighting Control	206	72	0	51	165	107	411	216	1227	4.6%	1892	689	2581	8.3%	2475		\$6,663 - \$9,994	2.7 - 4.0
	12 Exterior Lighting Power Reduction (From 3.61 kW to 2 kW)	223	77	0	16	165	168	388	216	1251	2.7%	2041	664	2705	3.9%	1053	\$480 - \$720		0.5 - 0.7
HVAC & SHW Measures	13 Improved HVAC System Efficiency (From 9.3 EER to 10.5 EER)	199	77	0	51	165	168	388	216	1262	1.9%	2075	664	2739	2.7%	852	\$1,366 - \$2,050		1.6 - 2.4
	14 Improved Fan Efficiency (From 55% to 65%)	220	65	0	51	165	168	394	216	1278	0.6%	2106	671	2777	1.4%	417	\$928 - \$1,392		2.2 - 3.3
	15 Economizer	223	77	0	51	165	168	388	216	1286	0.0%	2151	664	2815	0.0%	7	\$2,244 - \$3,367		344.9 - 517.4
	16 Improved Furnace Efficiency (From 80% to 90%)	223	77	0	51	165	168	344	216	1243	3.4%	2152	616	2768	1.7%	283	\$1,360 - \$2,040		4.8 - 7.2
	17 Demand Control Ventilation System	204	77	0	51	165	168	78	216	957	25.6%	2090	323	2413	14.3%	2637		\$737 - \$1,105	0.3 - 0.4
	18 Improved Efficiency for Service Water Heaters (From Et 80% to Et 95%)	223	77	0	51	165	168	388	181	1252	2.7%	2152	626	2777	1.3%	225	\$342 - \$513		1.5 - 2.3

Table 6. Simulation Results of Individual EEMs for an ASHRAE 90.1-2007 Code-Compliant Restaurant Building in the CoA

EEM#	Energy Efficiency Measure	Total Energy Use & Savings - SITE (MMBtu)										Total Energy Use & Savings - SOURCE (MMBtu)				\$ Savings (\$)	Increased Marginal Cost (\$)	Increased New System Cost (\$)	Pay back (Years)
		Space Cool	Vent. Fans	Pumps & Aux.	Ext. Usage	Misc. Equip.	Area Lights	Space Heat	SHW	Total Energy Use	% Energy Savings above Base Case	Elec.	NG	Total Energy Use	% Energy Savings above Base Case				
	90.1-2007 Base Case Dining Zone Only	159	70	0	47	165	141	7	215	805	0.0%	1834	245	2079		0.00			
Envelope & Fenestration Measures	1 Improved Wall Insulation (From R-13 + 3.8 c.i. to R-13 + 7.5 c.i.)	160	69	0	47	165	141	7	215	804	0.1%	1833	244	2077	0.1%	19	\$506 - \$759		26.4 - 39.6
	2 Improved Roof Insulation (From R-20 to R-25)	162	71	0	47	165	141	6	215	808	-0.4%	1847	244	2091	-0.5%	-114	\$1,760 - \$2,640		
	3 Improved Window U-value (From 0.65 to 0.35)	163	69	0	47	165	141	5	215	805	0.0%	1843	242	2085	-0.3%	-62	\$2,442 - \$3,662		
	4 Window Re-Distribution (East & West: 10%, South: 55.1%)	159	69	0	47	165	141	7	215	803	0.2%	1830	245	2075	0.2%	46	\$0 - \$0		
	5 Window Shading (From None to 10ft)	155	68	0	47	165	141	8	215	800	0.7%	1815	246	2061	0.9%	191	\$38,107 - \$57,160		199.0 - 298.6
	6 Window Shading & Redistribution (East & West: 10%, South: 55.1% Shading on South only: 10ft)	156	68	0	47	165	141	8	215	801	0.6%	1819	245	2065	0.7%	150	\$10,851 - \$16,276		72.3 - 108.4
	7 Air Barrier (From 0.322 to 0.05)	159	68	0	47	165	141	5	215	801	0.5%	1829	243	2072	0.4%	76	\$6,693 - \$10,039		88.4 - 132.5
Lighting Measures	8 Reduced Lighting Power Density (From 1.6 W/sqft to 0.89 W/sqft)	143	64	0	47	165	78	12	215	726	9.8%	1570	251	1820	12.5%	2641	\$8,000 - \$12,000		3.0 - 4.5
	9 Reduced 24 Hour Lighting	159	70	0	47	165	139	8	215	803	0.3%	1827	245	2072	0.4%	71	\$0 - \$0		0.0 - 0.0
	10 Daylighting Control	145	63	0	47	165	90	9	215	735	8.8%	1606	247	1853	10.9%	2226		\$6,663 - \$9,994	3.0 - 4.5
	11 Exterior Lighting Power Reduction (From 3.61 kW to 2 kW)	159	70	0	16	165	141	7	215	773	3.9%	1734	245	1979	4.8%	957	\$480 - \$720		0.5 - 0.8
HVAC & SHW Measures	12 Improved HVAC System Efficiency (From 10.8 EER to 11.5 EER)	150	70	0	47	165	141	7	215	796	1.2%	1805	245	2050	1.4%	320	\$927 - \$1,391		4.3 - 6.4
	13 Improved Fan Efficiency (From 55% to 65%)	157	59	0	47	165	141	8	215	793	1.5%	1792	246	2038	2.0%	416	\$928 - \$1,392		2.2 - 3.3
	14 Economizer	131	70	0	47	165	141	7	215	777	3.5%	1745	245	1990	4.3%	834	\$1,523 - \$2,285		1.8 - 2.7
	15 Improved Furnace Efficiency (From 80% to 90%)	159	70	0	47	165	141	7	215	804	0.1%	1834	244	2078	0.0%	5	\$1,360 - \$2,040		250.0 - 375.0
	16 Improved Efficiency for Service Water Heaters (From Et 80% to Et 95%)	159	70	0	47	165	141	7	181	771	4.3%	1834	207	2041	1.8%	224	\$342 - \$513		1.5 - 2.3

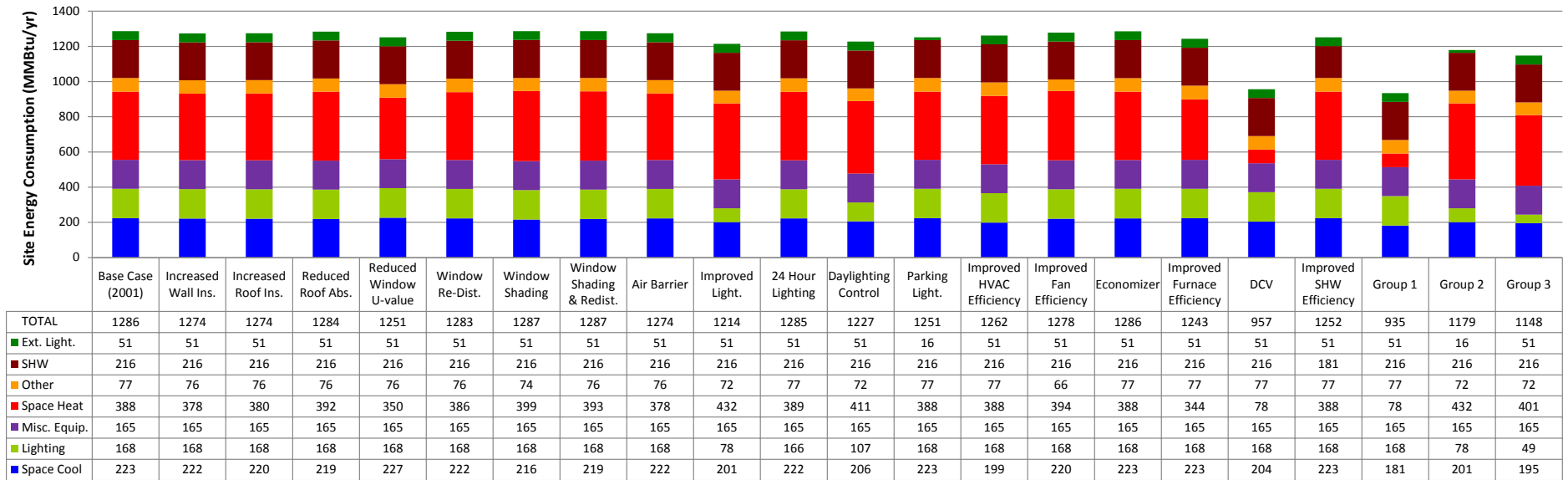

Figure 5. Site Energy Use of Various EEMs for an ASHRAE 90.1-2001 Code-Compliant Restaurant Building in the CoA

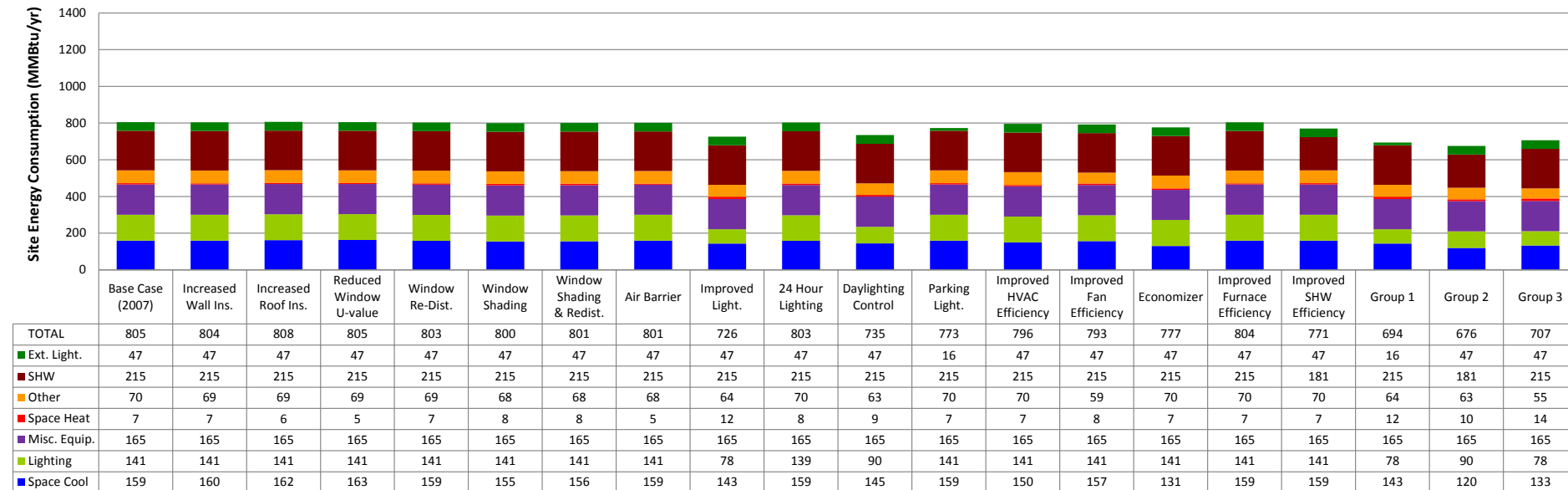

Figure 6. Site Energy Use of Various EEMs for an ASHRAE 90.1-2007 Code-Compliant Restaurant Building in the CoA

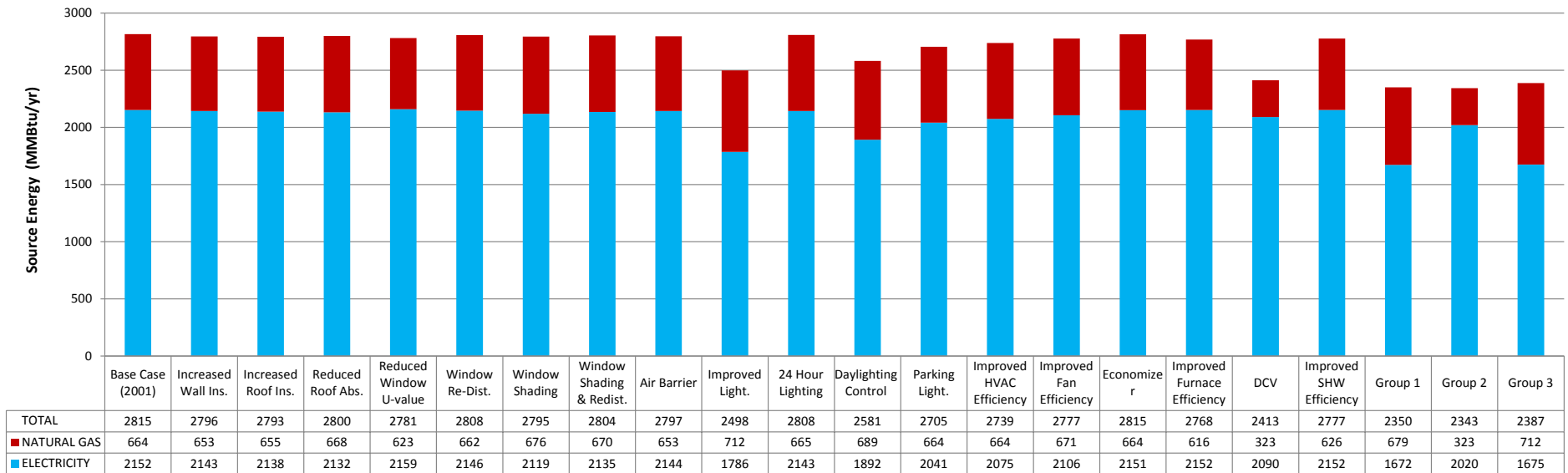

Figure 7. Source Energy Use of Various EEMs for an ASHRAE 90.1-2001 Code-Compliant Restaurant Building in the CoA

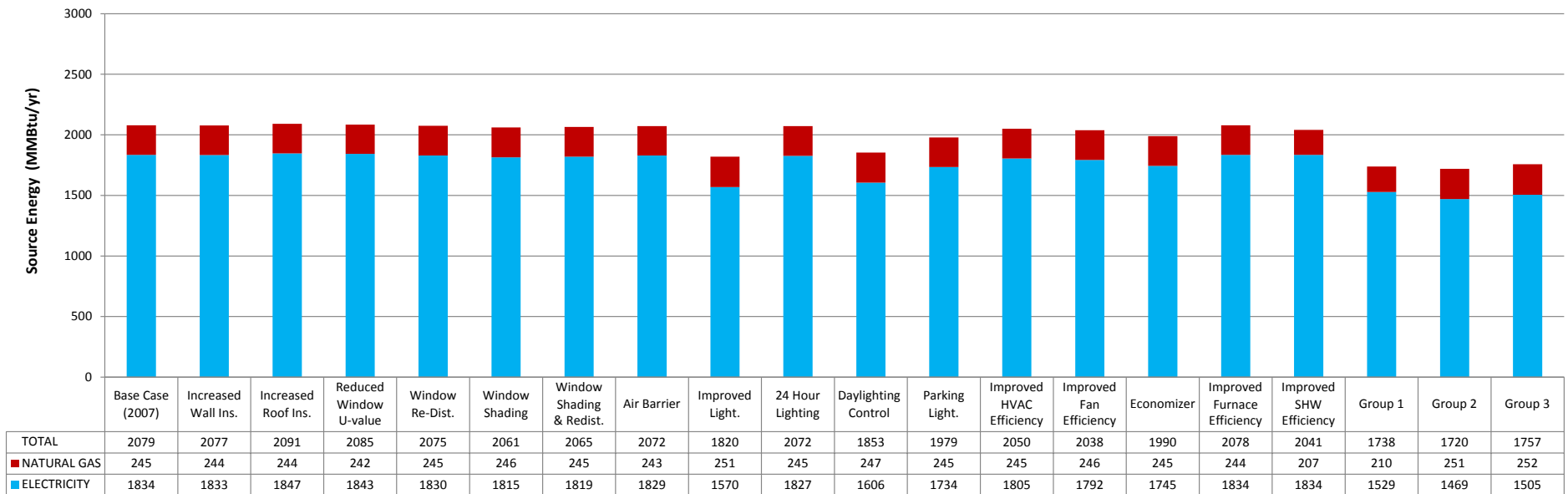
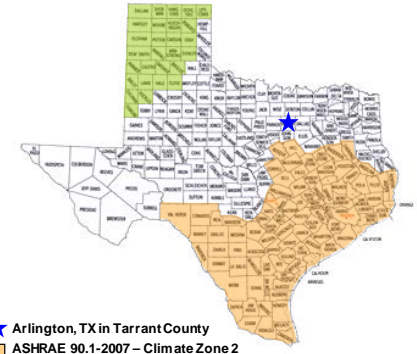

Figure 8. Source Energy Use of Various EEMs for an ASHRAE 90.1-2007 Code-Compliant Restaurant Building in the CoA

[ASHRAE 90.1-2001 Code-Compliant Restaurant Building - Dining Space Only]

Description of Individual Measures

Individual Measures	Annual Energy Savings (%) ¹		Annual Energy Savings (\$/year) ²	Annual Demand Savings (%)	Annual Demand Savings (\$/year) ³	Combined Savings (Energy+Demand) (\$/year)	Estimated Cost (\$)		Simple Estimated Payback (yrs)
	Site	Source					Marginal Cost ⁴	New System Cost ⁵	
A Envelope and Fenestration Measures									
1 Improved Wall Insulation (From R-13 to R-13 + 7.5 c.i.)	1.0%	0.7%	\$144	0.5%	\$13	\$157	\$2,655 - \$3,983		16.9 - 25.3
2 Improved Roof Insulation (From R-15 to R-25)	1.0%	0.8%	\$180	1.1%	\$27	\$207	\$3,856 - \$5,784		18.7 - 28.0
3 Reduced Roof Absorptance (From 0.7 to 0.36)	0.2%	0.5%	\$154	1.0%	\$23	\$177	\$1,760 - \$2,640		9.9 - 14.9
4 Improved Window U-value (From 1.22 to 0.35)	2.7%	1.2%	\$178	0.1%	\$2	\$180	\$5,818 - \$8,728		32.3 - 48.4
5 Window Re-Distribution (East & West: 10%, South: 55.1%)	0.3%	0.3%	\$65	0.2%	\$4	\$69	\$0 - \$0		0.0 - 0.0
6 Window Shading (From None to 10 ft)	-0.1%	0.7%	\$233	1.9%	\$46	\$279	\$38,107 - \$57,160		136.6 - 204.9
7 Window Shading & Redistribution (East & West: 10%, South: 55.1% Shading on South only: 10ft)	0.0%	0.4%	\$123	1.0%	\$24	\$147	\$10,851 - \$16,276		73.6 - 110.4
8 Air Barrier (From 0.322 to 0.05)	0.9%	0.6%	\$134	0.6%	\$14	\$148	\$5,885 - \$8,827		39.8 - 59.8
B Interior Lighting Measures									
9 Reduced Lighting Power Density (From 1.9 W/sqft to 0.89 W/sqft)	5.6%	11.3%	\$3,118	13.2%	\$317	\$3,435	\$8,000 - \$12,000		2.3 - 3.5
10 Reduced 24 Hour Lighting	0.1%	0.3%	\$72	0.0%	\$1	\$73	\$0 - \$0		-
11 Daylighting Control	4.6%	8.3%	\$2,265	8.8%	\$210	\$2,475		\$6,663 - \$9,994	2.7 - 4.0
C Exterior Lighting Measures									
12 Exterior Lighting Power Reduction (From 3.61 kW to 2 kW & reduction in usage to 25% of current usage from 12:00 AM to 6:00 AM)	2.7%	3.9%	\$1,030	1.0%	\$23	\$1,053	\$480 - \$720		0.5 - 0.7
D HVAC System Measures									
13 Improved HVAC System Efficiency (From 9.3 EER to 10.5 EER)	1.9%	2.7%	\$713	5.8%	\$139	\$852	\$1,366 - \$2,050		1.6 - 2.4
14 Improved Fan Efficiency (From 55% to 65%)	0.6%	1.4%	\$379	1.6%	\$37	\$417	\$928 - \$1,392		2.2 - 3.3
15 Economizer	0.0%	0.0%	\$7	0.0%	\$0	\$7	\$2,244 - \$3,367		344.9 - 517.4
16 Improved Furnace Efficiency (From 80% to 90%)	3.4%	1.7%	\$283	0.0%	\$0	\$283	\$1,360 - \$2,040		4.8 - 7.2
17 Demand Control Ventilation System	25.6%	14.3%	\$2,593	1.8%	\$43	\$2,637		\$737 - \$1,105	0.3 - 0.4
E Service Hot Water Heater Measures									
18 Improved Efficiency for Service Water Heaters (From Et 80% to Et 95%)	2.7%	1.3%	\$225	0.0%	\$0	\$225	\$342 - \$513		1.5 - 2.3



- ★ Arlington, TX in Tarrant County
- ASHRAE 90.1-2007 – Climate Zone 2
- ASHRAE 90.1-2007 – Climate Zone 3
- ASHRAE 90.1-2007 – Climate Zone 4

Description of Combined Measures

Combination of Measures ⁶	Combined Annual Energy Savings (%) ¹		Combined Energy Savings (\$/year) ²	Combined Demand Savings (%)	Combined Demand Savings (\$/year) ³	Combined Savings (Energy+Demand) (\$/year)	Combined Estimated Cost (\$)		Simple Estimated Payback (yrs)	NOx Emissions Savings Annual (tons/yr)	SO ₂ Emissions Savings Annual (tons/yr)	CO ₂ Emissions Savings Annual (tons/yr)
	Site	Source					Marginal Cost ⁴	New System Cost ⁵				
Combination 1												
13 Improved HVAC System Efficiency (From 9.3 EER to 10.5 EER)	27.34%	16.79%	\$3,244	7.4%	\$178	\$3,422	\$1,366 - \$2,050		0.6 - 0.9	0.009	0.005	7.2
17 Demand Control Ventilation System								\$737 - \$1,105				
Combination 2												
9 Reduced Lighting Power Density (From 1.9 W/sqft to 0.89 W/sqft)	8.34%	15.21%	\$4,148	13.9%	\$335	\$4,482	\$8,000 - \$12,000		1.9 - 2.8	0.033	0.018	25.9
12 Exterior Lighting Power Reduction (From 3.61 kW to 2 kW & reduction in usage to 25% of current usage from 12:00 AM to 6:00 AM)								\$480 - \$720				
Combination 3												
9 Reduced Lighting Power Density (From 1.9 W/sqft to 0.89 W/sqft)	10.78%	16.52%	\$4,377	18.7%	\$449	\$4,827	\$8,000 - \$12,000		3.0 - 4.6	0.033	0.019	26.1
10 Reduced 24 Hour Lighting								\$0 - \$0				
11 Daylighting Control								\$6,663 - \$9,994				

Note:

1. Total energy savings from heating, cooling, lighting, equipment and DHW for emissions reductions determination.
2. Savings depend on fuel mix used.
* Energy Cost: Electricity = \$0.095/kWh & Demand = \$5.00/kWh
Natural gas = \$0.65/therm
3. Yearly demand cost = Sum of monthly demand cost for 12 months
4. Marginal cost = new system cost - original system cost
5. New system cost = new system cost only
6. See individual measures above for specific savings

[ASHRAE 90.1-2001 Code-Compliant Restaurant Building Description]

- * Building type: Restaurant
 - * Gross area: 5,500 sq-ft (Dining Area: 4,000 sq-ft; Kitchen Area: 1,500 sq-ft)
 - * Building dimension: 61 ft x 91 ft x 14 ft (WxLxH)
 - * Dining room dimension: 61 ft x 66 ft x 14 ft (WxLxH)
 - * Number of floors: 1
 - * Floor-to-floor height: 14 ft
 - * Window-to-wall ratio: 17% for the entire building (including kitchen)
 - * HVAC system: EER 9.3 Rooftop PSZ & 80% Et Furnace
 - * DHW: Et: 80% Gas Water heater
- Savings calculations for all measures except exterior lighting performed for dining space only

Figure 9. Individual and Combined Energy Efficiency Measures for an ASHRAE 90.1-2001 Code-Compliant Restaurant Building for the CoA

[ASHRAE 90.1-2007 Code-Compliant Restaurant Building - Dining Zone Only]

Description of Individual Measures

Individual Measures	Annual Energy Savings (%) ¹		Annual Energy Savings (\$/year) ²	Annual Demand Savings (%)	Annual Demand Savings (\$/year) ³	Combined Savings (Energy+Demand) (\$/year)	Estimated Cost (\$)		Simple Estimated Payback (yrs)
	Site	Source					Marginal Cost ⁴	New System Cost ⁵	
A Envelope and Fenestration Measures									
1 Improved Wall Insulation (From R-13 + 3.8 c.i. to R-13 + 7.5 c.i.)	0.1%	0.1%	\$16	0.2%	\$3	\$19	\$506 - \$759		26.4 - 39.6
2 Improved Roof Insulation (From R-20 to R-25)	-0.4%	-0.5%	-\$110	-0.2%	-\$3	-\$114	\$1,760 - \$2,640		-
3 Improved Window U-value (From 0.65 to 0.35)	0.0%	-0.3%	-\$63	0.0%	\$0	-\$62	\$2,442 - \$3,662		-
4 Window Re-Distribution (East & West: 10%, South: 55.1%)	0.2%	0.2%	\$43	0.2%	\$4	\$46	\$0 - \$0		0.0 - 0.0
5 Window Shading (From None to 10ft)	0.7%	0.9%	\$175	0.9%	\$17	\$191	\$38,107 - \$57,160		199.0 - 298.6
6 Window Shading & Redistribution (East & West: 10%, South: 55.1% Shading on South only: 10ft)	0.6%	0.7%	\$137	0.7%	\$13	\$150	\$10,851 - \$16,276		72.3 - 108.4
7 Air Barrier (From 0.322 to 0.05)	0.5%	0.4%	\$62	0.8%	\$14	\$76	\$6,693 - \$10,039		88.4 - 132.5
B Interior Lighting Measures									
8 Reduced Lighting Power Density (From 1.6 W/sqft to 0.89 W/sqft)	9.8%	12.5%	\$2,430	11.5%	\$211	\$2,641	\$8,000 - \$12,000		3.0 - 4.5
9 Reduced 24 Hour Lighting	0.3%	0.4%	\$70	0.0%	\$0	\$71	\$0 - \$0		0.0 - 0.0
10 Daylighting Control	8.8%	10.9%	\$2,111	6.3%	\$115	\$2,226		\$6,663 - \$9,994	3.0 - 4.5
C Exterior Lighting Measures									
11 Exterior Lighting Power Reduction (From 3.61 kW to 2 kW & reduction in usage to 25% of current usage from 12:00 AM to 6:00 AM)	3.9%	4.8%	\$932	1.4%	\$25	\$957	\$480 - \$720		0.5 - 0.8
D HVAC System Measures									
12 Improved HVAC System Efficiency (From 10.8 EER to 11.5 EER)	1.2%	1.4%	\$274	2.5%	\$46	\$320	\$1,366 - \$2,050		4.3 - 6.4
13 Improved Fan Efficiency (From 55% to 65%)	1.5%	2.0%	\$384	1.8%	\$32	\$416	\$928 - \$1,392		2.2 - 3.3
14 Economizer	3.5%	4.3%	\$834	0.0%	\$0	\$834	\$1,523 - \$2,285		1.8 - 2.7
15 Improved Furnace Efficiency (From 80% to 90%)	0.1%	0.0%	\$5	0.0%	\$0	\$5	\$1,360 - \$2,040		250.0 - 375.0
E Service Hot Water System Measure									
16 Improved Efficiency for Service Water Heaters (From Et 80% to Et 95%)	4.3%	1.8%	\$224	0.0%	\$0	\$224	\$342 - \$513		1.5 - 2.3

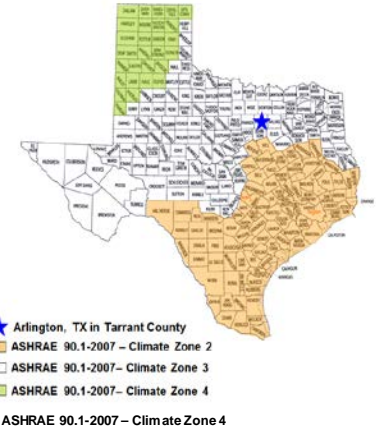

Description of Combined Measures

Combination of Measures ⁶	Combined Annual Energy Savings (%) ¹		Combined Energy Savings (\$/year) ²	Combined Demand Savings (%)	Combined Demand Savings (\$/year) ³	Combined Savings (Energy+Demand) (\$/year)	Combined Estimated Cost (\$)		Simple Estimated Payback (yrs)	NOx Emissions Savings Annual (tons/yr)	SO ₂ Emissions Savings Annual (tons/yr)	CO ₂ Emissions Savings Annual (tons/yr)
	Site	Source					Marginal Cost ⁴	New System Cost ⁵				
Combination 1												
8 Reduced Lighting Power Density (From 1.6 W/sqft to 0.89 W/sqft)	13.8%	17.3%	\$3,362	12.9%	\$236.00	\$3,598	\$8,000 - \$12,000	2.4 - 3.5	0.025	0.014	19.8	
11 Exterior Lighting Power Reduction (From 3.61 kW to 2 kW & reduction in usage to 25% of current usage from 12:00 AM to 6:00 AM)							\$480 - \$720					
Combination 2												
10 Daylighting Control	16.1%	16.4%	\$3,052	6.3%	\$114.75	\$3,167		2.6 - 3.9	0.021	0.012	16.6	
14 Economizer							\$1,523 - \$2,285					
16 Improved Efficiency for Service Water Heaters (From Et 80% to Et 95%)							\$342 - \$513					
Combination 3												
8 Reduced Lighting Power Density (From 1.6 W/sqft to 0.89 W/sqft)	12.22%	15.51%	3022	15.52%	284	\$3,306	\$8,000 - \$12,000	2.8 - 4.2	0.023	0.013	17.9	
12 Improved HVAC System Efficiency (From 10.8 EER to 11.5 EER)							\$1,366 - \$2,050					
13 Improved Fan Efficiency (From 55% to 65%)							\$928 - \$1,392					

Note:

- Total energy savings from heating, cooling, lighting, equipment and DHW for emissions reductions determination.
- Savings depend on fuel mix used.
 * Energy Cost: Electricity = \$0.095/kWh & Demand = \$5.00/kWh
 Natural gas = \$0.65/therm
- Yearly demand cost = Sum of monthly demand cost for 12 months
- Marginal cost = new system cost - original system cost
- New system cost = new system cost only
- See individual measures above for specific savings

[ASHRAE 90.1-2007 Code-Compliant Restaurant Building Description]

- * Building type: Restaurant
 - * Gross area: 5,500 sq-ft (Dining Area: 4,000 sq-ft; Kitchen Area: 1,500 sq-ft)
 - * Building dimension: 61 ft x 91 ft x 14 ft (WxLxH)
 - * Dining room dimension: 61 ft x 66 ft x 14 ft (WxLxH)
 - * Number of floors: 1
 - * Floor-to-floor height: 14 ft
 - * Window -to-w all ratio: 17% for the entire building (including kitchen)
 - * HVAC system: EER 10.8 Rooftop PSZ & 80% Et Furnace
 - * DHW: Et: 80% Gas Water heater
- Savings calculations for all measures except exterior lighting performed for dining space only

Figure 10. Individual and Combined Energy Efficiency Measures for an ASHRAE 90.1-2007 Code-Compliant Restaurant Building for the CoA

4 SUMMARY

This report presents cost-effective recommendations to maximize energy savings for restaurant buildings in the City of Arlington (CoA). Based on a summary of above-code approaches, recommendations were developed to achieve above-code energy performance based on the ASHRAE 90.1-2001 and 2007 standard reference buildings, for restaurant buildings in the CoA.

A total of 18 recommendations based on the energy savings above the base-case restaurant building were selected. These measures include building envelope and fenestration, HVAC system, service hot water (SHW) system, lighting, and renewable options. The implementation costs of each individual measure were also calculated along with simple payback calculations. These measures were then combined to achieve the total source energy savings of the group is 15% above the base case, ASHRAE 90.1-2001 and 2007 code-compliant small retail buildings. As a result, four combinations were proposed for each base case. Each combination was formed to have a different payback period. Finally, the corresponding emissions savings (NO_x-lbs/yr, SO₂-lbs/yr, and CO₂-lbs/yr) of each combination were calculated based on the eGrid for Texas.

REFERENCES

- ACEEE. 2011. *Consumer Resources: Water Heating*. American Council for an Energy-Efficient Economy. Retrieved August 2, 2011, from <http://www.aceee.org/consumer/water-heating>
- Atmos Energy. 2011. *Atmos Energy Tariffs for Mid-Tex: July 2011 Mid-Tex GCR Rates*. Dallas, TX: Atmos Energy. Retrieved August 2, 2011, from <http://www.atmosenergy.com/about/tariffs.html?st=mtx&pass=1>
- ASHRAE. 1999. *ANSI/ASHRAE Standard 62.1-1999 Ventilation for Acceptable Indoor Air Quality*. Atlanta, GA: American Society of Heating, Refrigerating, and Air-Conditioning Engineers, Inc.
- ASHRAE. 2001. *ANSI/ASHRAE/IESNA Standard 90.1-2001 Energy Standard for Buildings Except Low-Rise Residential Buildings*. Atlanta, GA: American Society of Heating, Refrigerating, and Air-Conditioning Engineers, Inc.
- ASHRAE. 2004. *ANSI/ASHRAE Standard 62.1-2004 Ventilation for Acceptable Indoor Air Quality*. Atlanta, GA: American Society of Heating, Refrigerating, and Air-Conditioning Engineers, Inc.
- ASHRAE. 2006. *Advanced Energy Design Guide for Small Retail Buildings*. Atlanta, GA: American Society of Heating, Refrigerating and Air-conditioning Engineers, Inc.
- ASHRAE. 2007a. *ANSI/ASHRAE/IESNA Standard 90.1-2007 Energy Standard for Buildings Except Low-Rise Residential Buildings*. Atlanta, GA: American Society of Heating, Refrigerating, and Air-Conditioning Engineers, Inc.
- Cho, S., J. Mukhopadhyay, C. Culp, J. Haberl, and B. Yazdani. 2007. Recommendations for 15% Above-Code Energy-Efficiency Measures for Commercial Office Buildings. *Proceedings of the 15.5 Symposium on Improving Building Systems in Hot and Humid Climates*, published on CD ROM. San Antonio, TX.
- Coburn's Products for Commercial Gas Water Heaters. Retrieved on October 26, 2011 from <http://www.coburns.com/Products/Default.aspx?Category=71389&Attribute=223>
- Deru, M., Field, K., Studer, D., Benne, K., Griffith, B., Torcellini, P. et.al, 2011. U.S. Department of Energy Commercial Reference Building Models of the National Building Stock. Technical report NREL/TP-550-46861, National Renewable Energy Laboratory, Golden – Colorado 80401.
- E Source. 2005. *HVAC: Demand-Controlled Ventilation Pa-53*. E Source Companies LLC. Retrieved August 2, 2011, from http://www.esource.com/BEA/demo/PDF/P_PA_53.pdf
- Haberl, J., Gilman, D., Culp, C., 2004. Texas Emissions and Energy Calculator (eCALC): Documentation of Analysis Methods. ESL-TR-04/12-06. Energy Systems Laboratory, Texas Engineering Experiment Station, Texas A&M University System.
- Hale, E., Macumber, D., Long, N., Griffith, B., Benne, K., Pless, S. and Torcellini, P., 2008. Technical Support Document of the Advanced Energy Design Guide for Medium Box Retail – 50% Energy

Savings. Technical report NREL/TP – 550-42828, National Renewable Energy Laboratory, Golden – Colorado 80401.

JJH. 2009. *DOE2.com eQUEST*. Camarillo, CA: James J. Hirsch & Associates. Retrieved July 1, 2010, from <http://www.doe2.com/equest/>

Kim, H., S. Do., K. Kim, J.C. Baltazar, J. Haberl, and C. Lewis. 2011b. Cost-Effective Energy Efficiency Measures for Above Code (ASHRAE 90.1-2001 and 2007): Part III. Small Retail Buildings in the City of Arlington. *Energy Systems Laboratory Report No. ESL-TR-11-10-06*. College Station, TX: Texas A&M University.

Leach, M., Hale, E., Hirsch, A., Torcellini, P., 2009. Grocery Store 50% Energy Savings Technical Support Document. Technical report NREL/TP-550-46101, National Renewable Energy Laboratory, Golden – Colorado 80401.

RCD. 2011. *RMeans CostWorks Version 4.7.0 Construction Cost Data*. Norcross, GA: Reed Construcion Data Inc. Retrieved August 2, 2011, from <https://www.meanscostworks.com/securedsite/login.aspx>

U.S. DOE EIA. 2011. *Form EIA-826 Data Monthly Electric Sales and Revenue Data*. Energy Information Administration, U.S. Department of Energy. Retrieved August 2, 2011, from <http://205.254.135.24/cneaf/electricity/page/eia826.html>

Zhang, J., Zabrowski, D., Schrock, D., Lane, M., Fisher, D., Athalye, R. Livchack, A., Liu, B. 2010. Technical Support Document: 50% Energy Savings for Quick-Service Restaurants. Technical report: PNNL – 19809. Richland, WA: Pacific Northwest National Laboratory.

Light Bulbs / LED Product Catalog (2011). Retrieved October 26, 2011, from <http://www.1000bulbs.com/>

APPENDIX A

Appendix A provides the implementation cost of each EEM obtained from various resources. Tables A-1 and A-2 summarize the cost information for all measures.

Table A-1. Summary of the Cost Information for an ASHRAE 90.1-2001 Code-Compliant Base Case

	EEMs for ASHRAE 90.1-2001 Base Case (CoA)	Description of EEM			Increased Cost per Unit		Number of units/Total Area			Avg. Total Cost	Marginal Cost			New System Cost			References
		Unit/Category	Basecase	EEMs	Unit	\$/Unit	Unit (#)	Length (ft)	Area (sqft)		-20%	(Avg)	20%	-20%	(Avg)	+20%	
1	Increased Wall Insulation R-Value (from none to R7.5 c.i.)	hr-sq.ft.-°F/Btu	0 c.i.	7.5c.i.	sq.ft.	\$ 1.68			1,976	\$ 3,319	\$2,655	\$ 3,319	\$3,983				Kim et. al. 2011 b
2	Increased Roof Insulation (from R15 to R25)	hr-sq.ft.-°F/Btu	15	25	sq.ft.	\$ 1.21			4,000	\$ 4,820	\$3,856	\$ 4,820	\$5,784				Kim et. al. 2011 b
3	High Albedo Roof (Roof Absorptance from 0.7 to 0.3)	Roof Absorptance	0.7	0.3	sq.ft.	\$ 0.55			4,000	\$ 2,200	\$1,760	\$2,200	\$2,640				Kim et. al. 2011 b
4	Decreased Glazing U-Value (from 1.22 to 0.35)	U-Value	1.22	0.35	sq.ft.	\$ 10.08			722	\$ 7,273	\$5,818	\$7,273	\$8,728				Kim et. al. 2011 b
5	Window Redistribution	%															Assumed no cost
6	Window Shading (None to 10 ft. Overhang)	Depth (ft)	0.0	10	length feet	\$224.00		212.65		\$ 47,634	\$38,107	\$47,634	\$57,160				RS Means CostWorks ver 4.7.0 (RCD 2011)
7	Window Shading & Redistribution	Depth (ft), %	0.0	10	length feet	\$224.00		60.55		\$ 13,563	\$10,851	\$13,563	\$16,276				RS Means CostWorks ver 4.7.0 (RCD 2011)
8	Air Barrier (From 0.322 to 0.05)	ACH	0.322	0.05	sqft	\$ 1.40			5,254	\$ 7,356	\$5,885	\$7,356	\$8,827				Leach et al. 2009
9	Lighting Power Density	W/sqft	1.9	0.9	-					\$10,000	\$8,000	\$10,000	\$12,000				Light Bulbs / LED Product Catalog (2011)
10	24 Hour Lighting																
15	Daylight Dimming Control	Photocells along the Front Window Wall	No	Yes	each	\$4,164	2			\$ 8,329				\$6,663	\$8,329	\$9,994	Appendix B
12	Exterior Lighting Power Reduction	W			-	\$600				\$600	\$480	\$600	\$720				Zhang et al. (2011)
13	Improved HVAC System Efficiency	EER	9.3	10.5	tons	\$61	28			\$1,708	\$1,366	\$1,708	\$2,050				RS Means CostWorks ver 4.7.0 (RCD 2011)
8	Improved Fan Efficiency (from 55% to 65%)	Fan Efficiency (%)	55%	65%	each	\$ 1,160	1			\$ 1,160	\$928	\$1,160	\$1,392				RS Means CostWorks ver 4.7.0 (RCD 2011)
15	Economizer	-	No	Yes	ton	\$100	28			\$ 2,806	\$2,244	\$2,806	\$3,367				Leach et al. 2009
16	Improved Furnace Efficiency (From Ec 80% to Ec 90%)	Ec %	80.0%	90.0%	each	\$1,700				\$1,700	\$1,360	\$1,700	\$2,040				Talk with Malek Rep.
17	CO ₂ -Based Demand-Controlled Ventilation (DCV)	OA Demand Control	No	Yes	each	\$ 921	1			\$ 921				\$737	\$921	\$1,105	E source. 2005
18	Improved Water Heater Efficiency	Et %	80.0%	95.0%	each	\$427	\$1			\$ 427	\$342	\$427	\$513				RSMeans 2011 Coburn (2011)

Table A-2. Summary of the Cost Information for an ASHRAE 90.1-2007 Code-Compliant Base Case

	EEMs for ASHRAE 90.1-2007 Base Case (CoA)		Basecase	EEMs	Increased Cost per Unit		Number of units/Total Area			Avg. Total Cost	Marginal Cost			New System Cost			References
					Unit	\$/Unit	Unit (#)	Length (ft)	Area (sqft)		-20%	(Avg)	20%	-20%	(Avg)	+20%	
1	Increased Wall Insulation R-Value (from R3.8 c.i. to R7.5 c.i.)	hr-sq.ft.-°F/Btu	3.8 c.i.	7.5c.i.	sq.ft.	\$ 0.32			1,976	\$ 632	\$506	\$ 632	\$759				Kim et. al. 2011 b
2	Increased Roof Insulation (from R20 to R25)	hr-sq.ft.-°F/Btu	20	25	sq.ft.	\$ 0.55			4,000	\$ 2,200	\$1,760	\$ 2,200	\$2,640				Kim et. al. 2011 b
3	Decreased Glazing U-Value (from 0.65 to 0.35)	U-Value	0.65	0.35	sq.ft.	\$ 4.23			722	\$ 3,052	\$2,442	\$3,052	\$3,662				Kim et. al. 2011 b
4	Window Re-Distribution																Assumed no cost
5	Window Shading (None to 10 ft. Overhang)	Depth (ft)	0.0	10	length feet	\$224.00		212.65		\$ 47,634	\$38,107	\$47,634	\$57,160				RS Means CostWorks ver 4.7.0 (RCD 2011)
6	Window Shading & Redistribution	Depth (ft), %	0.0	10	length feet	\$224.00		60.55		\$ 13,563	\$10,851	\$13,563	\$16,276				RS Means CostWorks ver 4.7.0 (RCD 2011)
7	Air Barrier (From 0.322 to 0.05)	ACH	0.322	0.05	sqft	\$1.40			5,976	\$ 8,366	\$6,693	\$8,366	\$10,039				Leach et al. 2009
8	Lighting Power Density	W/sqft	1.6	0.9	-					\$10,000	\$8,000	\$10,000	\$12,000				Light Bulbs / LED Product Catalog (2011)
9	24 Hour Lighting																
10	Daylight Dimming Control	Photocells along the Front Window Wall	No	Yes	each	\$4,164	2			\$ 8,329				\$6,663	\$8,329	\$9,994	Appendix B
11	Exterior Lighting Power Reduction	W			-	\$600				\$600	\$480	\$600	\$720				Zhang et al. (2011)
12	HVAC System Efficiency	EER	10.8	11.5	tons	\$61	19			\$1,159	\$927	\$1,159	\$1,391				RS Means CostWorks ver 4.7.0 (RCD 2011)
13	Improved Fan Efficiency (from 55% to 65%)	Fan Efficiency (%)	55%	65%	each	\$ 1,160	1			\$ 1,160	\$928	\$1,160	\$1,392				RS Means CostWorks ver 4.7.0 (RCD 2011)
14	Economizer	-	No	Yes	ton	\$100	19			\$ 1,904	\$1,523	\$1,904	\$2,285				Leach et al. 2009
15	Improved Furnace Efficiency (From Ec 80% to Ec 90%)	Ec %	80.0%	90.0%	each	\$1,700				\$1,700	\$1,360	\$1,700	\$2,040				Talk with Malek Rep.
16	Improved Water Heater Efficiency	Et %	80.0%	95.0%	each	\$427	\$1			\$ 427	\$342	\$427	\$513				RSMeans 2011 Coburn (2011)

APPENDIX B

Appendix B provides the implementation cost of the daylight dimming control EEM obtained from three resources. Table B-1 summarize this information.

Table B-1: Summary of the Cost Information for the Implementation of Daylight Dimming Controls

Daylighting Control							
Manufacturer / Distributor	Description	Unit	Total cost per unit \$/unit	Installation Costs \$ / unit	Total Cost \$	Reference	Notes
WattStopper	Dimming Ballasts	Each	\$50	100	\$4,332	Robert Rubin w/ WattStopper.com (robert@legacyltg.com)	As per Zhang et al. (2010) 66% of the dining area is controlled with daylight controls. This translates to 2640 sqft of area. Assumed lighting levels to be 35 fc and lumens per lamp for halogen fixtures to be 990 (efficacy 22lumen/watt). This implies a total of 156 lamps.
	Dimming photocell	Each	\$140				
	Handheld programming remote	Each	\$25				
	OCC sensor	Each	\$140				
	PowerPack	Each	\$27				
CW Lighting	Ballasts	Each	\$50	100	\$4,530	Tom Scott w/ CW Lighting 713 - 690 - 9320	As per design two control modules are used for the restaurant. The calculations have been modified to incorporate 78 dimming ballasts instead of 12 dimming ballasts used in the calculations for schools for each module.
	Dimming control module	Each	\$300				
	Lighting Sensors	Each	\$150				
	Wiring	per ln foot	\$5				
	PowerPack	per classroom	\$75				
RS Means	Daylight dimming control module	Each	\$615	Costs included in per unit costs	\$3,631	RS Means CostWorks ver 4.7.0 (RCD 2011)	
	Daylight Sensor, ceiling mounted	Each	\$208				
TOTAL					\$4,164		

APPENDIX C

Appendix C provides a cross check to justify the low heating energy consumption in the ASHRAE 90.1 2007 base-case building. Figure C-1 provides the annual heating energy end-use for the 2007 base case with and without the DCV installed. Figure C-2 provides values for heating energy end-use, occupancy schedule and ratio of outside air to total supply air for the ASHRAE 90.1 2007 base-case building for a typical winter day. Figure C-3 provides the corresponding ambient dry bulb temperature, solar radiation and zone temperatures for the typical winter day. Figure C-4 provides the annual zone temperatures for the ASHRAE 90.1 2007 base case with and without the DCV installed.

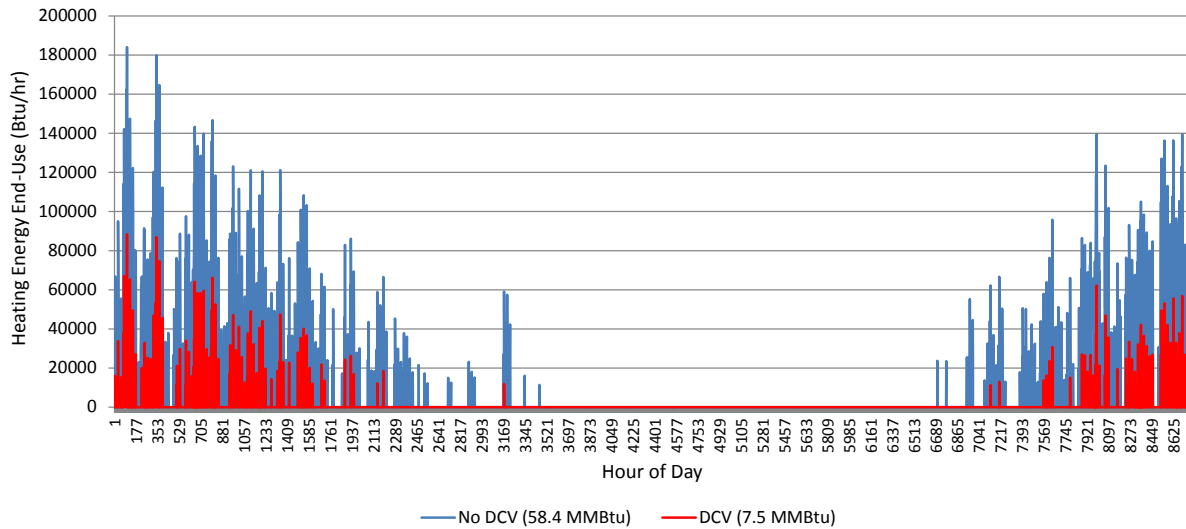

Figure C- 1: Annual Heating Energy End-Use for ASHRAE 90.1 2007 Base Case with and without the Option of DCV

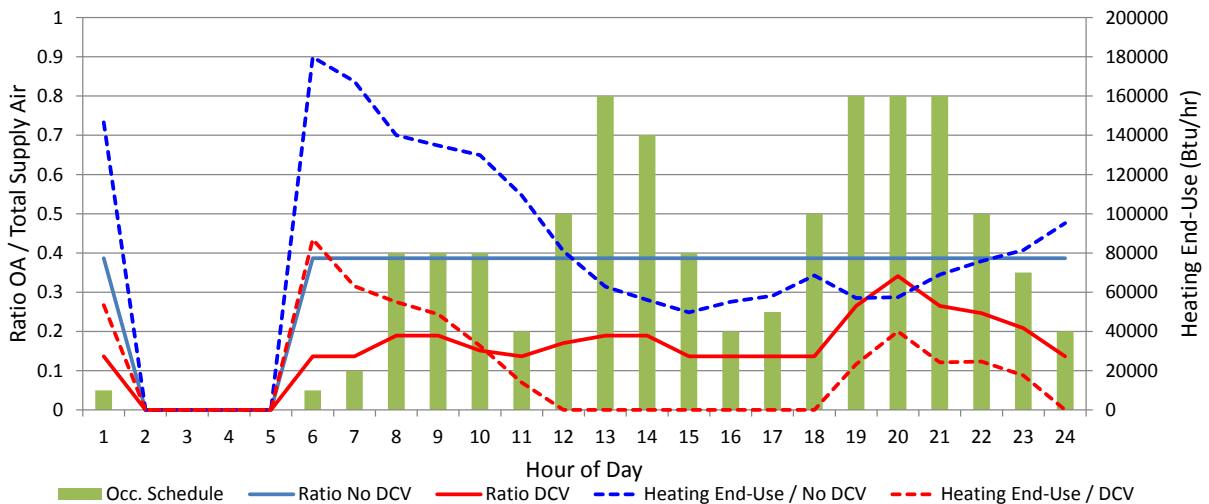

Figure C- 2: Heating Energy End-Use, Occupancy Schedule and Ratio of Outside Air to Total Supply Air for ASHRAE 90.1 2007 Base Case with and without the Option of DCV for a Typical Winter Day – January 15th

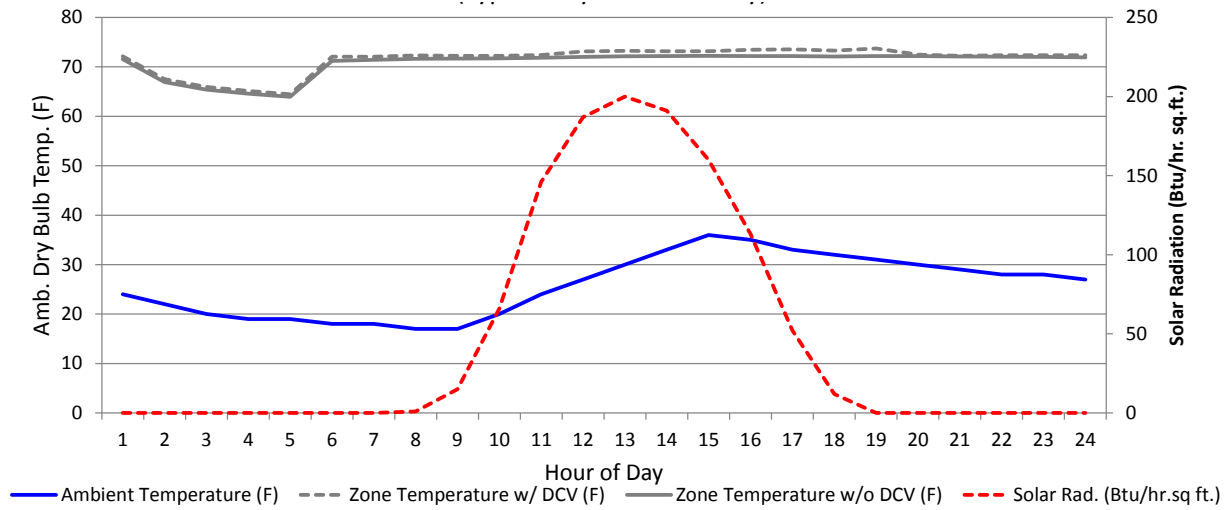

Figure C- 3: Ambient Dry Bulb Temperature, Solar Radiation and Zone Temperatures from DFW Weather File for a Typical Winter Day – January 15th

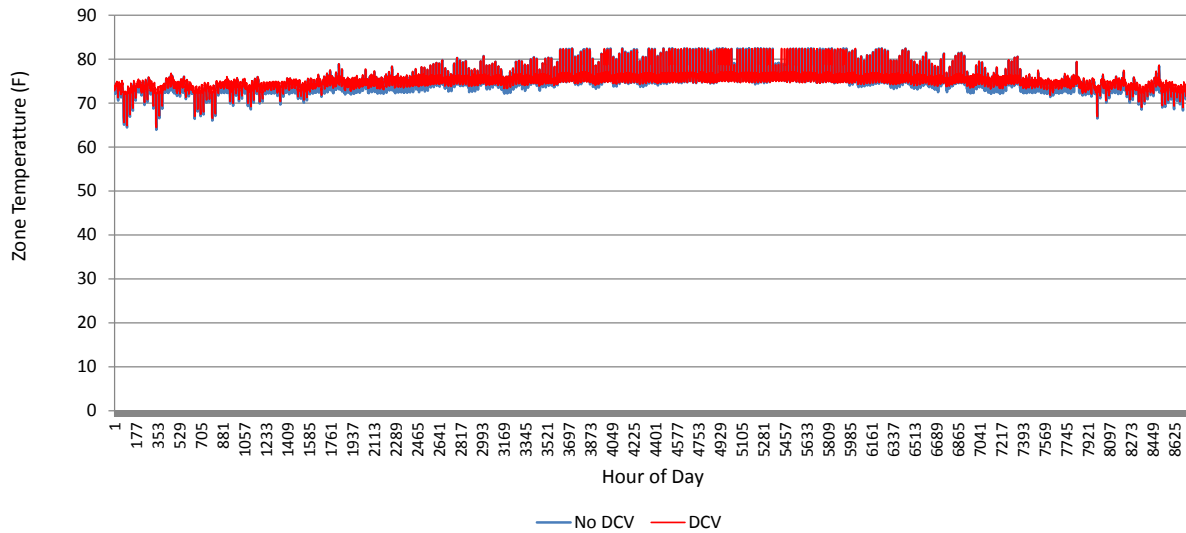

Figure C- 4: Annual Zone Temperatures for the ASHRAE 90.1 2007 Base Case