

PERFORMANCE AND POWER OPTIMIZATION IN VLSI PHYSICAL DESIGN

A Thesis

by

ZHANYUAN JIANG

Submitted to the Office of Graduate Studies of
Texas A&M University
in partial fulfillment of the requirements for the degree of

MASTER OF SCIENCE

December 2007

Major Subject: Computer Engineering

PERFORMANCE AND POWER OPTIMIZATION IN VLSI PHYSICAL DESIGN

A Thesis

by

ZHANYUAN JIANG

Submitted to the Office of Graduate Studies of
Texas A&M University
in partial fulfillment of the requirements for the degree of

MASTER OF SCIENCE

Approved by:

Chair of Committee, Weiping Shi
Committee Members, Jiang Hu
Donald K. Friesen

Head of Department, Costas N. Georghiades

December 2007

Major Subject: Computer Engineering

ABSTRACT

Performance and Power Optimization in VLSI Physical Design. (December 2007)

Zhanyuan Jiang, B.S., Shanghai Jiao Tong University

Chair of Advisory Committee: Dr. Weiping Shi

As VLSI technology enters the nanoscale regime, a great amount of efforts have been made to reduce interconnect delay. Among them, buffer insertion stands out as an effective technique for timing optimization. A dramatic rise in on-chip buffer density has been witnessed. For example, in two recent IBM ASIC designs, 25% gates are buffers.

In this thesis, three buffer insertion algorithms are presented for the procedure of performance and power optimization. The second chapter focuses on improving circuit performance under inductance effect. The new algorithm works under the dynamic programming framework and runs in provably linear time for multiple buffer types due to two novel techniques: restrictive cost bucketing and efficient delay update. The experimental results demonstrate that our linear time algorithm consistently outperforms all known RLC buffering algorithms in terms of both solution quality and runtime. That is, the new algorithm uses fewer buffers, runs in shorter time and the buffered tree has better timing.

The third chapter presents a method to guarantee a high fidelity signal transmission in global bus. It proposes a new redundant via insertion technique to reduce via variation and signal distortion in twisted differential line. In addition, a new buffer insertion technique is proposed to synchronize the transmitted signals, thus further improving the effectiveness of the twisted differential line. Experimental re-

sults demonstrate a 6GHz signal can be transmitted with high fidelity using the new approaches. In contrast, only a 100MHz signal can be reliably transmitted using a single-end bus with power/ground shielding. Compared to conventional twisted differential line structure, our new techniques can reduce the magnitude of noise by 45% as witnessed in our simulation.

The fourth chapter proposes a buffer insertion and gate sizing algorithm for million plus gates. The algorithm takes a combinational circuit as input instead of individual nets and greatly reduces the buffer and gate cost of the entire circuit. The algorithm has two main features: 1) A circuit partition technique based on the criticality of the primary inputs, which provides the scalability for the algorithm, and 2) A linear programming formulation of non-linear delay versus cost tradeoff, which formulates the simultaneous buffer insertion and gate sizing into linear programming problem. Experimental results on ISCAS85 circuits show that even without the circuit partition technique, the new algorithm achieves 17X speedup compared with path based algorithm. In the meantime, the new algorithm saves 16.0% buffer cost, 4.9% gate cost, 5.8% total cost and results in less circuit delay.

To My parents and Lihua

ACKNOWLEDGMENTS

I would like to express my sincere gratitude to my advisor Professor Weiping Shi. Professor Shi led me into the world of VLSI design automation. I truly appreciate all his academic and financial support. With the help of Professor Shi, I not only gained profound knowledge in academics, but also learned the scientific attitude towards research. I am also very thankful for all his advice for my career and life, as well as for his constant encouragement and friendship.

Many thanks to my other committee members, Professor Jiang Hu and Professor Donald Friesen. I appreciate very much their invaluable assistance.

Many thanks to Professor Jiang Hu for his inspiring courses in VLSI design, which provided me with many techniques for VLSI circuit analysis and optimization. In his course projects, I implemented several algorithms and performed a lot of simulations, which prepared me well to be confident in my job interview.

Many thanks to Professor Donald Friesen for introducing me to the algorithm world, which provided me a solid foundation for my research. Before his course, I knew little about algorithm analysis and design. I am very grateful to having taken his course in the beginning of my graduate life.

Special thanks to my friends and fellow graduate students. Thanks to Shiyan Hu for his help with my research work and writing. I learned a lot in daily discussions with him, from coding style to paper writing. Thanks to Zhuo Li for his advice on my research work. He is a model of diligence and intelligence, encouraging me to make progress in my work. Thanks to Cheng-Ta Chiang for introducing me to Latex and many useful hints on that. Thanks to Yang Yi, Zhuo Feng, Xiaoji Ye, Guo Yu, Wei Dong, Weihuang Wang and Yifang Liu for making computer engineering group a big family and a wonderful place to work.

I wish to thank my parents for their encouragement, support and truly believing in me.

Thanks to my wife Lihua Han. Without her support and belief in my work, I could not imagine this thesis being accomplished.

TABLE OF CONTENTS

CHAPTER		Page
I	INTRODUCTION	1
	A. Technology Trend	1
	B. Contribution	3
	C. Organization	4
II	AN RLC BUFFER INSERTION ALGORITHM	5
	A. Introduction	5
	B. Delay Model	7
	1. Inductance Impact on Delay	7
	2. Interconnect Delay Model	8
	3. CMOS Gate Delay Model	12
	C. RLC Buffering Algorithm	13
	1. Preliminaries	13
	2. Overview of van Ginneken's Algorithm	13
	3. Algorithm	15
	a. Sink	17
	b. Wire Insertion	17
	c. Buffer Insertion	18
	d. Branch Merge	19
	e. Linear Time Complexity	19
	D. Experimental Results	21
	1. Comparison between Ismail and NEW	22
	2. Comparison between van Ginneken-Lillis, Impedance and NEW+COST	22
III	A TWISTED DIFFERENTIAL LINE FOR GLOBAL BUS	24
	A. Introduction	24
	B. Effect of Via Variation	26
	1. Experiments Setup	26
	2. Single-end Bus Structure	26
	3. Standard Twisted Differential Line Structure	28
	C. New Twisted Differential Line Structure	31
	1. Redundant Via Insertion	32

CHAPTER	Page
	2. Buffer Insertion 35
IV	CIRCUIT-WISE BUFFER INSERTION AND GATE SIZ- ING ALGORITHM WITH SCALABILITY 37
	A. Introduction 37
	B. Problem Formulation 39
	C. Algorithm 40
	1. Post-buffering Timing Estimation 42
	2. Circuit Partition Technique 43
	a. The Partition Boundary 44
	b. Side Inputs and Outputs 45
	3. Linear Formulation of Delay vs. Cost Tradeoff 45
	4. Linear Programming 49
	a. LP Formulation 50
	b. Redundant Variables and Constraints Removal 50
	5. Considering Slew and Buffer Congestion 52
	D. Experimental Results 53
	1. Comparison between Path Based and Circuit-wise Algorithms 53
	2. The Effect of the Partition Technique 56
	3. Testcase with Million Plus Gates 56
V	CONCLUSION AND FUTURE WORK 58
	A. Conclusion 58
	B. Future Work 59
	REFERENCES 60
	VITA 65

LIST OF TABLES

TABLE		Page
I	Comparison between RLC Elmore delay and SPICE delay. Time unit is <i>ns</i>	12
II	Comparison of buffering between Ismail and NEW on five sets of test cases. Each set consists of randomly selected 200 nets.	23
III	Comparison between van Ginneken-Lillis, Impedance and NEW+COST on five sets of test cases, each having randomly selected 200 nets. . .	23
IV	Comparison of TDL performance between single via and double vias.	36
V	Tree delay with different sink and driver sizes. # Buffer denotes the number of buffers in the tree.	46
VI	Summary of ISCAS placed and routed circuits.	54
VII	Comparison of path based algorithm and new circuit-wise algorithm.	55
VIII	The effect of the partition technique.	57

LIST OF FIGURES

FIGURE		Page
1	Percentage of nets requiring buffers. <i>M3</i> and <i>M6</i> represent nets on third and sixth metal layer in a six metal layer technology.	2
2	Buffers as a percentage of the total cell count for the chip.	3
3	Capacitance crosstalk path of a signal line.	7
4	Comparison of output signals between RLC and RC in global wires.	9
5	Comparison of output signals between RLC and RC in intermediate wires.	9
6	A single segment of an RLC circuit.	10
7	An RLC tree.	11
8	The data structure of cost buckets	16
9	Time complexity of new RLC algorithm with respect to the number of buffer positions.	20
10	A single-end model of 8-bit global bus. OP denotes the signal observation point.	27
11	(a) Noise signal is measured at OP in Figure 10. The peak noise of 6GHz input signal is 0.35V. (b) The peak noise of 200MHz input signal is 0.18V, of 100MHz is 0.15V and of 50MHz is 0.11V.	27
12	A TDL structure of 8-bit global bus with single via.	29
13	(a) Signal in TDL structure with single via and without variation. Output signal is measured at OP4 in Figure 12. (b) Signal in TDL structure with single via and with via variation. Output signal is measured at OP4 in Figure 12.	29

FIGURE	Page
14	Noise signal in TDL structure with single via. Signal is measured at OP3 in Figure 12. The peak noise is 0.11V. 30
15	Peak noise is measured at OP3 in Figure 12. (a) The peak noise with respect to the resistance difference between two neighboring traces. (b) The peak noise with respect to the resistance in two neighboring traces. The resistance of two traces is the same. 31
16	Two layouts of TDL structure with double vias using Virtuoso. Both designs are symmetric for delay balance and noise reduction. 33
17	(a) Input signal and output signal in TDL with double vias. Output signal is measured at OP4 in Figure 12. (b) Noise signal in TDL with double vias. Signal is measured at OP3 in Figure 12. The peak noise is 0.08V. 34
18	(a) Output signals in twisted differential line structure with double vias. Output signals are measured at OP1 and OP4 in Figure 12. The maximum output difference is 37ps. (b) The maximum output difference is 7ps. 35
19	(a) A combinational circuit. (b) The corresponding DAG of the circuit. (c) The corresponding routing trees and gates of the circuit. 41
20	The circuit is partitioned into three sub-circuits based on the downstream cones of primary inputs. The input a is the most critical primary input in the circuit. 43
21	(a) The original buffer delay cost tradeoff and the approximation. (b) The original gate delay cost tradeoff and the approximation. 48
22	The intuition behind the delay constraint formulation. 49

CHAPTER I

INTRODUCTION

A. Technology Trend

As the continuous trend of Very Large Scale Integration (VLSI) circuits technology scaling and frequency increasing, interconnect delay becomes a significant bottleneck in system performances. This trend is a result of increased resistance of the interconnect when feature sizes enter the nano-meter era. From International Technology Roadmap for Semiconductors (ITRS) projection, interconnect delay can contribute to more than 50% of the delay when the feature size is beyond 180 nm. As a result, delay optimization techniques for interconnect are increasingly important for achieving timing closure of high performance designs. A great effort has been made to reduce interconnect delay and buffer insertion appears as a very effective technique.

The objective of buffer insertion is to find where to insert buffers in the interconnect so that the timing requirements are met. Since the propagation Elmore delay has a square dependence on the length of an RC interconnect line, subdividing the line into shorter sections is an effective strategy to reduce the total propagation delay. The interconnect can be subdivided into shorter sections by inserting repeaters, which breaks the quadratic dependence of the delay on the interconnect length but adds additional parasitic impedances due to the inserted repeaters. Thus, an optimum number and size of repeaters exist that minimizes the total propagation delay of the line [1, 2].

Owing to the tremendous drop in VLSI feature size, a huge number of buffers are needed for achieving timing objectives for interconnects. It is stated in a recent

The journal model is *IEEE Transactions on Automatic Control*.

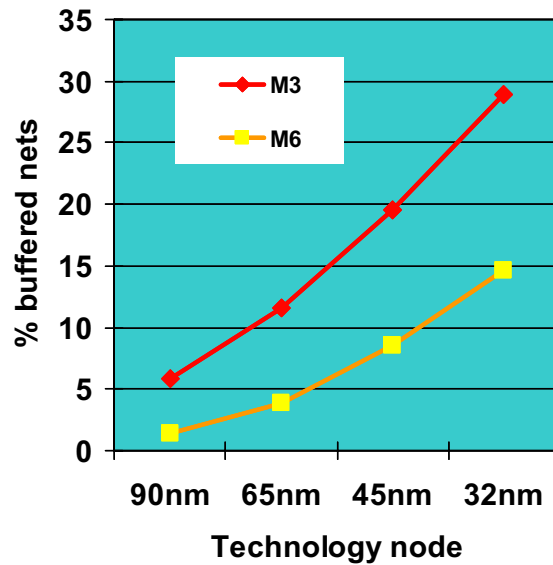

Fig. 1. Percentage of nets requiring buffers. *M3* and *M6* represent nets on third and sixth metal layer in a six metal layer technology.

study [3] that the number of nets that need buffer insertion and the number of buffers will rise dramatically. For example, 12% of nets require buffer insertion and the number of buffers (including clocked buffers) reaches about 15% of the total cell count for intrablock communications for 65nm technology. At 32nm technology node, these numbers become 29% and 70% respectively. The trend is shown in Figure 1 and Figure 2. Although we are not sure whether the number of 70% will finally be reached, hundreds of thousands of buffers can be found in today's ASICs. For example, Osler [4] presents an existing chip with 426 thousand buffers which occupy 15% of the available area. From Figure 1 and Figure 2, the rate at which the percentage of impacted nets is increasing and the rate at which the percentage of buffers is increasing both start accelerating. Therefore, both the complexity and importance of buffer insertion is increasing in an even faster pace.

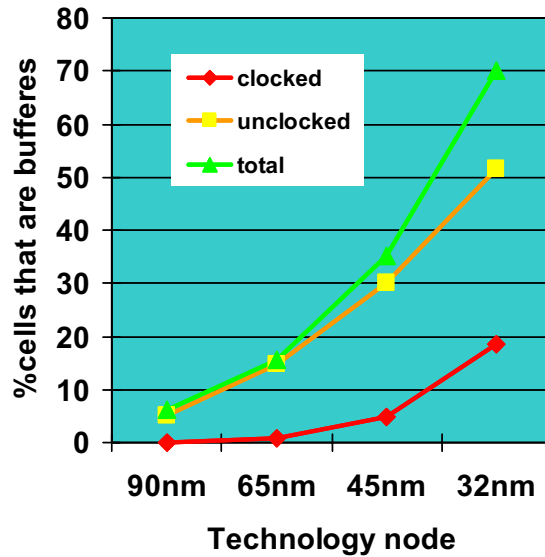

Fig. 2. Buffers as a percentage of the total cell count for the chip.

B. Contribution

The increasing number of buffers cause various design problems such as handling inductance, space congestion and power management. In this thesis, we propose three buffer insertion techniques with emphasis on these challenges.

The second chapter deals with inductance effects in circuit analysis and optimization. A new buffer insertion algorithm considering inductance for intermediate and global interconnect is proposed. The new algorithm works under the dynamic programming framework with two new features: a highly effective restrictive cost bucketing technique for solution pruning and an $O(1)$ -time efficient delay evaluation procedure. The whole algorithm runs in provably linear time in terms of candidate buffer positions. Because RLC circuit behavior is not well understood and only approximate delay model exists, there is no surprise as we have to use some approximation techniques to make our RLC buffering algorithm run in linear time.

The third chapter focuses on reducing signal distortion and synchronizing the transmitted signals, which improves the effectiveness of the twisted differential line in global bus design. A new redundant via insertion technique is proposed to reduce via resistance variation, and then a new buffer technique with spacing constraint is proposed to synchronize the output signals.

The fourth chapter proposes a buffer insertion and gate sizing algorithm for million plus gates. The algorithm takes combinational circuit as input instead of individual nets, which greatly reduces the buffer cost and gate cost of the entire circuit. The algorithm has two main features: 1) A circuit partition technique based on the criticality of the primary inputs, which provides the scalability for the algorithm, and 2) A linear programming formulation of non-linear delay versus cost tradeoff, which formulates the simultaneous buffer insertion and gate sizing into linear programming problem.

C. Organization

This thesis is organized as follows. In Chapter II, we introduce the most classical work in buffer insertion and the buffer insertion algorithm considering inductance. In Chapter III, a new twisted differential line structure in global bus design is proposed. In Chapter IV, we present circuit-wise buffer insertion and gate sizing algorithm with scalability. Finally, conclusion and future work are presented in Chapter V.

CHAPTER II

AN RLC BUFFER INSERTION ALGORITHM

Conventional buffer insertion algorithms neglect the impact of inductance effect, which often introduces large error in circuit optimization. On the other hand, ultra-fast buffering techniques are always desirable as buffering is such a widely used technique in industry. It is a challenge to design an RLC buffering algorithm which excels in both runtime and solution quality.

In this thesis, such an algorithm is proposed. The new algorithm works under the dynamic programming framework and runs in provably linear time for multiple buffer types due to two novel techniques: restrictive cost bucketing and efficient delay update. Experiment results on industrial netlists demonstrate that the new algorithm consistently outperforms van Ginneken and Lillis' algorithm [1, 5] for RC buffering and all known RLC buffering algorithms.

A. Introduction

As VLSI technology moves into the nanoscale regime, interconnect delay becomes a dominant constraint in circuit design. A great amount of effort has been made to reduce interconnect delay and buffer insertion appears as a very effective technique. It is witnessed in [3] that a large number of buffers are needed with current IC technology. In two recent IBM ASIC designs, 25% gates are buffers [4].

Due to fast scaling of technology, inductance effect in circuit performance causes increasing research attention. With higher operating frequencies, the quadratic delay-length dependence in RC model is approaching linear [6]. Thus, RC model often overestimates circuit delay which results in excessive buffers inserted. Realizing this, new RLC buffering algorithms are proposed in [7] and [8], which are able to save more

than 30% buffers compared to the minimum cost RC buffering algorithms.

In [7], a top-down greedy style RLC algorithm is proposed. At each candidate buffer position, the delay at a driver is evaluated to decide whether a buffer is inserted. This method gives a great reduction of the buffer area. Due to the top-down nature of the algorithm, a tree traversal is needed to collect RLC information for delay evaluation, which is the bottleneck for the efficiency of the algorithm. Since only a single solution is maintained, this algorithm still runs fast, however, it sacrifices solution quality.

In [8], a different RLC algorithm based on dynamic programming is designed. The main contributions of [8] are the concept of downstream impedance and new pruning condition to speed up the solution propagation. However, the approach is not efficient. Experimental results in [8] show that the algorithm runs significantly slower than RC timing buffering algorithms. In reality, buffering techniques are often applied to huge volume of nets and thus fast buffering techniques are highly desired. This imposes great challenge on designing state-of-the-art buffer insertion algorithm and motivates this work.

In this thesis, we propose the fastest RLC buffer insertion algorithm. The new algorithm works under the dynamic programming framework with two new features: a highly effective restrictive cost bucketing technique for solution pruning and an $O(1)$ -time efficient delay evaluation procedure. The whole algorithm runs in provably linear time in terms of candidate buffer positions. Because RLC circuit behavior is not well understood and only approximate delay model exists, there is no surprise as we have to use some approximation techniques to make our RLC buffering algorithm run in linear time. The experimental results demonstrate that our linear time algorithm consistently outperforms all known RLC buffering algorithms in terms of both solution quality and runtime. That is, the new algorithm uses fewer buffers, runs in shorter

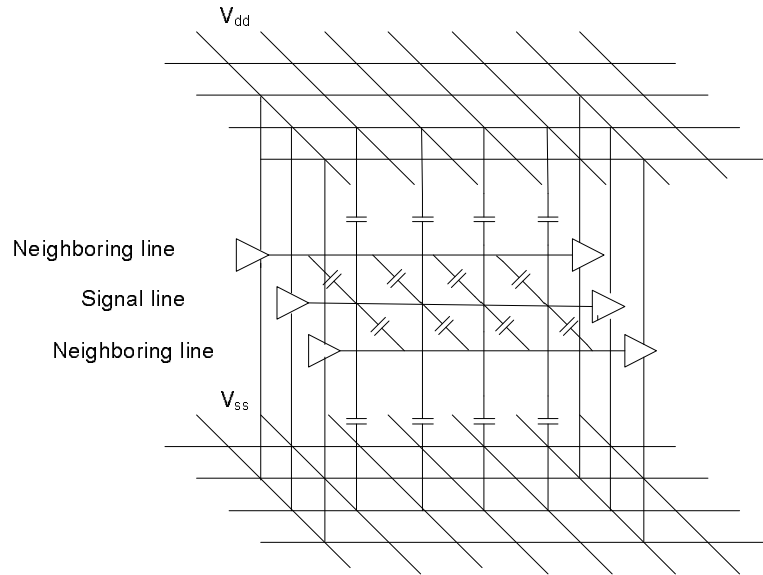

Fig. 3. Capacitance crosstalk path of a signal line.

time and the buffered tree has better timing. In particular, the new algorithm gives up to 8.5% buffer saving and $4\times$ speedup over [7]. When buffer cost minimization is handled, 5.3% fewer buffers and $5\times$ speedup is obtained over [8].

B. Delay Model

Since the prevailing RC Elmore delay model does not catch the actual performance considering inductance effect, various authors claim 30% to 100% timing errors [6, 9]. Thus, more accurate delay models are necessary for accurate timing analysis and buffer insertion. Such a model will be introduced in this section.

1. Inductance Impact on Delay

To accurately investigate the inductance impact on delay, it is important to have the realistic range of unit parasitic resistance, capacitance and inductance. We set

up a realistic environment to accurately extract the parasitics based on the model of [10]. Since the inductance effect depends on current return path, the capacitance crosstalk path which is shown in Figure 3 is crucial. The signal line is assumed to have two neighboring lines which remain static during the entire analysis period. Then, FastCap [11] and FastHenry [12] are used to extract capacitance and inductance. For MOSIS 130nm technology [13], the following parameters are obtained. From metal layer one to six, unit resistance varies from $350\Omega/mm$ to $10\Omega/mm$, unit capacitance from $380fF/mm$ to $180fF/mm$ and unit inductance from $0.6nH/mm$ to $1.3nH/mm$.

We investigated inductance effect in global wires and intermediate wires both. SPICE simulation results demonstrate that differences between applications of RLC model and RC model to global wires on metal layer five and six (Figure 4) and intermediate wires on metal layer three and four (Figure 5) are quite significant. The inductance introduces 20% additional delay to global wires and also causes large overshoot, while relatively less impact has been observed on intermediate wires. The reason behind this phenomenon is that unit resistance of global wires is much less than that of intermediate wires.

2. Interconnect Delay Model

An equivalent Elmore delay model of an RLC tree from [14] is adopted in this thesis. The model comes from a second order approximation of transfer function, which preserves the same accuracy for RLC trees as that of Elmore delay with respect to RC trees.

A single line segment of an RLC circuit is shown in Figure 6. This circuit has a second order transfer function which is given by

$$h(s) = \frac{\omega_n^2}{s^2 + s2\zeta\omega_n + \omega_n^2}, \quad (2.1)$$

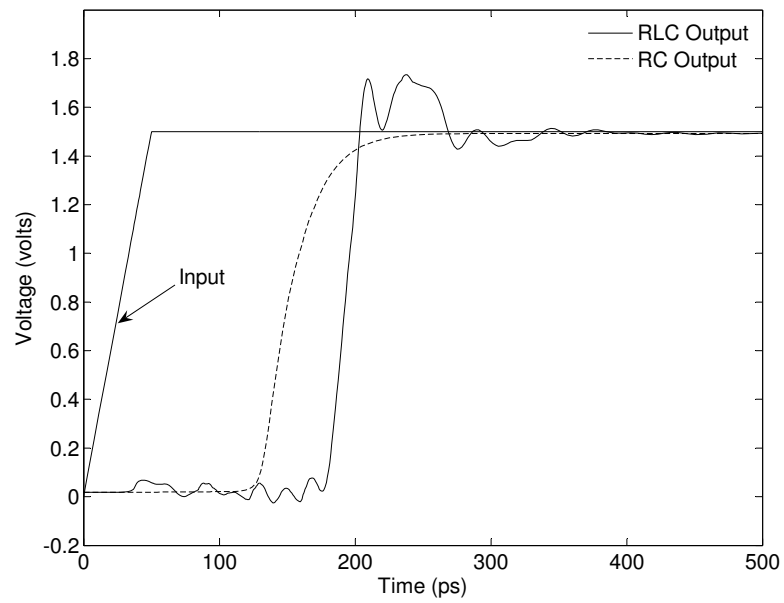

Fig. 4. Comparison of output signals between RLC and RC in global wires.

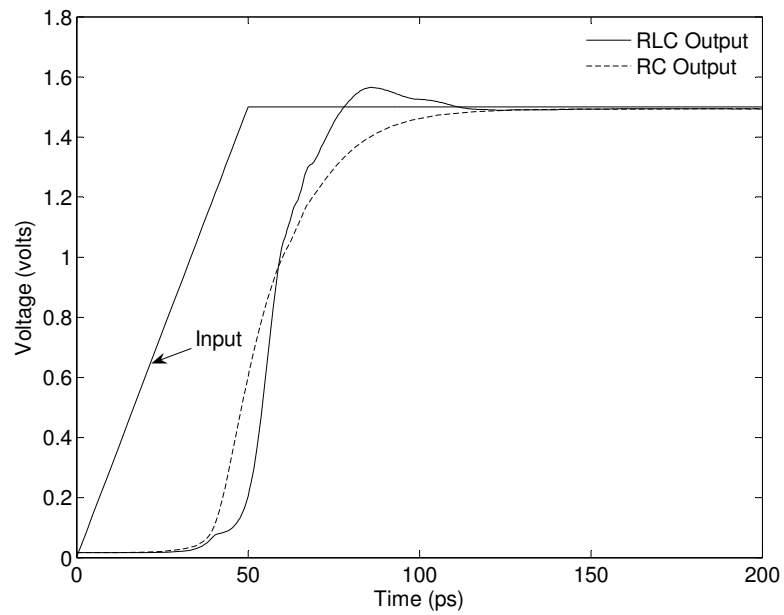

Fig. 5. Comparison of output signals between RLC and RC in intermediate wires.

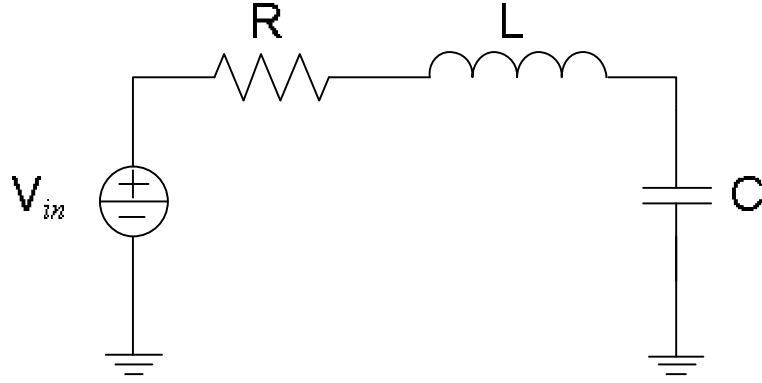

Fig. 6. A single segment of an RLC circuit.

where

$$\zeta = \frac{1}{2} \frac{RC}{\sqrt{LC}} \quad \text{and} \quad \omega_n = \frac{1}{\sqrt{LC}}. \quad (2.2)$$

For a general RLC tree shown in Figure 7, the voltage drop at node N_i compared with the input voltage is

$$V_{in}(s) - V_i(s) = \sum_k C_k V_k(s) s (R_{ki} + L_{ki} s), \quad (2.3)$$

where k is the index of all branches along the path from N_0 to N_i . The normalized transfer function $h_i(s)$ at node N_i is

$$h_i(s) = 1 - \sum_k C_k V_k(s) s (R_{ki} + L_{ki} s) = 1 + m_1^i s + m_2^i s^2 + \dots$$

The first and second moments at node N_i are approximated by

$$m_1^i = - \sum_k C_k R_{ik}, \quad (2.4)$$

$$m_2^i = \left(\sum_k C_k R_{ik} \right)^2 - \sum_k C_k L_{ik}. \quad (2.5)$$

Then ζ and ω_n that characterize a second order approximation of the transfer

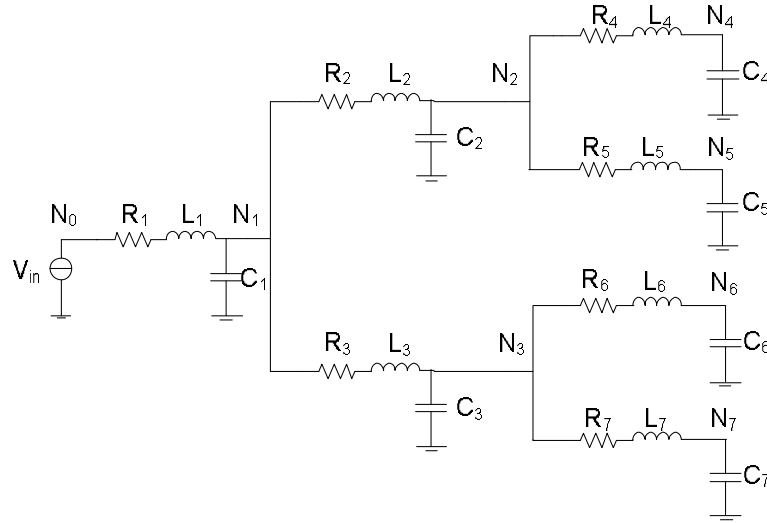

Fig. 7. An RLC tree.

function at node N_i are

$$\zeta_i = \frac{1}{2} \frac{\sum_k C_k R_{ik}}{\sqrt{\sum_k C_k L_{ik}}} \quad \text{and} \quad \omega_{ni} = \frac{1}{\sqrt{\sum_k C_k L_{ik}}}. \quad (2.6)$$

Eqn. (2.1) and Eqn. (2.6) can be used to determine the time domain signal at node i for an arbitrary input. In [14], a curve fitting method is applied to compute 50% delay of a step input and the delay is

$$t = (1.047e^{-\frac{\zeta_i}{0.85}})/\omega_{ni} + 0.695 \sum_k C_k R_{ik}. \quad (2.7)$$

The calculation of ζ_i and ω_{ni} in Eqn. (2.6) requires the calculation of the two summations, $\sum_k C_k R_{ik}$ and $\sum_k C_k L_{ik}$. The former is the RC Elmore delay, which can be calculated efficiently with linear complexity, and the latter is used to characterize inductance effects, which is also calculated with linear complexity.

Table I. Comparison between RLC Elmore delay and SPICE delay. Time unit is *ns*.

Tree Cases	Unbuffered Tree			Buffered Tree		
	RLC	SPICE	Error	RLC	SPICE	Error
1	4.63	4.89	5.3 %	1.14	1.07	6.1 %
2	3.78	3.95	4.3 %	1.12	1.04	7.1 %
3	3.09	3.25	4.9 %	1.18	1.10	6.8 %
4	3.06	3.22	5.0 %	1.09	1.02	6.4 %
5	2.85	2.97	4.0 %	1.11	1.04	6.3 %
6	2.66	2.76	3.6 %	1.08	1.01	6.5 %
7	3.20	3.34	4.2 %	1.20	1.13	5.8 %
8	1.07	1.13	5.3 %	0.63	0.59	6.3 %

3. CMOS Gate Delay Model

The computation of CMOS gate delay t_g is adopted from [15]. CMOS gate delay is a combination of the linear approximation t_{lin} and the saturation approximation t_{sat} ,

$$t_g = t_{lin} + t_{sat} \exp(-1.1 \frac{t_{lin}}{t_{sat}}). \quad (2.8)$$

The calculation of t_{lin} and t_{sat} is related to Eqn. (2.7) [7].

According to [7], the error of this method is within 3% from actual CMOS gate delay.

Eight netlists with tree topology each having around 100 nodes are used to test the accuracy of adopted RLC Elmore delay model and CMOS gate delay model. From Table I, one can see that the maximum error between RLC delay and SPICE delay is 7.1%.

C. RLC Buffering Algorithm

1. Preliminaries

The basic buffering problem includes a routing tree $T = (V, E)$, where $V = \{s_0\} \cup V_s \cup V_n$, and $E \subseteq V \times V$. Vertex s_0 is the *source* vertex, V_s is the set of *sink* vertices and V_n is the set of *internal* vertices. Each sink vertex $s \in V_s$ is associated with sink capacitance C_s , and each edge $e \in E$ is associated with lumped resistance R_e and capacitance C_e . A buffer library B contains different types of buffers. Each type of buffer b is associated with an output resistance R_b , input capacitance C_b , intrinsic delay K_b and a cost W_b . W_b can be measured by area or any other metric, depending on the optimization objective. Without loss of generality, we assume that the driver at source s_0 is also a buffer. A function $f : V_n \rightarrow 2^B$ specifies the types of buffers allowed at each internal vertex. A buffer assignment γ is a mapping $\gamma : V_n \rightarrow B \cup \{\wedge\}$ where \wedge denotes that no buffer is inserted. The cost of a solution γ is $W(\gamma) = \sum_{b \in \gamma} W_b$. With the above notations, our RLC buffering problem can be formulated as follows.

RLC Minimum Cost Buffer Insertion Problem: Given a routing tree $T = (V, E)$, possible buffer positions defined by f , and a buffer library B , find a buffer assignment γ such that the total cost $W(\gamma)$ is minimized, the RLC required arrival time at the driver is no less than a given constant α .

2. Overview of van Ginneken's Algorithm

To understand the context of the presented algorithms and to define notation, this section begins with a brief overview of van Ginneken and Lillis' [1, 5] algorithm. The algorithm proceeds bottom-up from the leaf nodes toward the driver along a given routing tree. A set of candidate solutions keeps updated during the process. Each solution is associated with a three-tuple (C, W, Q) , where C denotes the downstream

capacitance at the current node, W denotes the cost of the solution and Q refers to the required arrival time (RAT).

Suppose that a solution γ_v at position v must “propagate” to an upstream position u and there is no branching point in between. If no buffer is placed at u , then only wire delay needs to be considered. Therefore, the new solution γ_u can be computed as

$$\begin{aligned} C(\gamma_u) &= C(\gamma_v) + C_e, \\ W(\gamma_u) &= W(\gamma_v), \\ Q(\gamma_u) &= Q(\gamma_v) - D_e, \end{aligned} \tag{2.9}$$

where $e = (u, v)$ and $D_e = R_e(\frac{C_e}{2} + C(\gamma_v))$. Otherwise, suppose that we add a buffer b_i at u . γ_u can be then computed as

$$\begin{aligned} C(\gamma_u) &= C_{b_i}, \\ W(\gamma_u) &= W(\gamma_v) + W_{b_i}, \\ Q(\gamma_u) &= Q(\gamma_v) - D_{b_i} - D_e \end{aligned} \tag{2.10}$$

after buffer insertion. In Eqn. (2.10), D_{b_i} refers to the buffer delay and is computed as $D_{b_i} = R'_{b_i} \cdot C(u) + K'_{b_i}$, where R'_{b_i} is the driving resistance of b_i but not the slew resistance of b_i , and K'_{b_i} is the intrinsic buffer delay.

An important concept in van Ginneken’s algorithm are *non-dominated solutions*. For any two solutions γ_1, γ_2 at the same node, γ_1 dominates γ_2 if $C(\gamma_1) \leq C(\gamma_2)$, $W(\gamma_1) \leq W(\gamma_2)$ and $Q(\gamma_1) \geq Q(\gamma_2)$. Whenever a solution becomes dominated, it is removed from the solution set. Therefore, only solutions excel in at least one aspect of downstream capacitance, buffer cost and RAT can survive.

For handling branch merging, suppose that we have obtained all the non-dominated solutions of left branch T_l and right branch T_r at a branching point v_t . The name

”left” or ”right” is assigned arbitrarily. Denote the left-branch solution set and the right-branch solution set by Γ_l and Γ_r , respectively. The merging process is performed as follows. For each solution $\gamma_l \in \Gamma_l$ and each solution $\gamma_r \in \Gamma_r$, generate a new solution γ' according to:

$$\begin{aligned} C(\gamma') &= C(\gamma_l) + C(\gamma_r), \\ W(\gamma') &= W(\gamma_l) + W(\gamma_r), \\ Q(\gamma') &= \min\{Q(\gamma_l), Q(\gamma_r)\}. \end{aligned} \tag{2.11}$$

At a high level, van Ginneken’s algorithm builds the solution set in a bottom-up fashion. Assume that we have computed all feasible non-dominated solutions at a buffer position v . For the immediately upstream buffer position u (without passing any branching point), we first propagate all solutions up there through performing wire insertion of (u, v) to each solution. The propagated solutions resemble the choices when no buffer is inserted at u . Subsequently, for each propagated solution, we compute a new solution for inserting each buffer. The new solution is inserted into the solution set as long as it is not dominated by any existing one. The solution set is meanwhile updated to prune the solutions being dominated by the newcomer. At a merging point, we carry out the process just described to generate the new solution set. In this way, we keep climbing up the routing tree until the driver is met. After pruning solutions violating the timing constraint at driver, we select the best solution as the one with the smallest cost.

3. Algorithm

Our algorithm shares the same dynamic programming framework as van Ginneken and Lillis’ algorithm. In our new algorithm, candidate solutions keep being updated during the procedure from leaf towards the driver, where each solution γ is character-

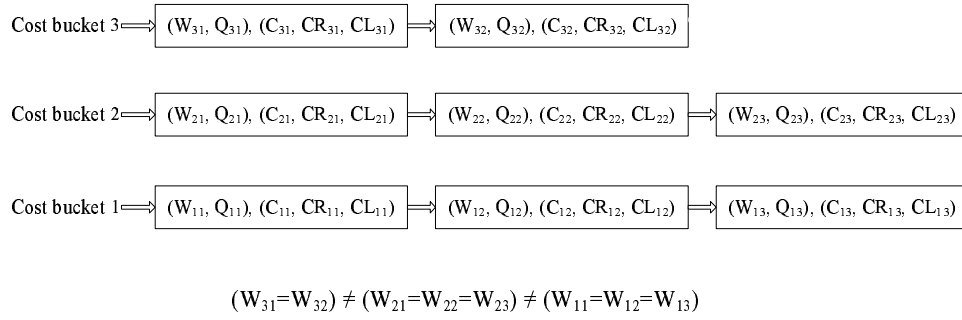

Fig. 8. The data structure of cost buckets

ized by two tuples. The first tuple is (Q, W) , where Q refers to the required arrival time (RAT) and W denotes the cost of the solution. The first tuple is used in pruning. The second tuple is (C, CR, CL) , where C denotes the downstream capacitance, CR and CL represent the largest $\sum_k C_k R_{ik}$ and $\sum_k C_k L_{ik}$ in all downstream branches, respectively, where k represents the index of all branches along the path from the node i to its immediate buffered descendant node (which can also be a sink). The second tuple is used for accurately calculating delay in Eqn. (2.7) and Eqn. (2.8) but not pruning. During the solution propagation, significant amount of solutions are pruned by our new restrictive cost bucketing technique.

Restrictive Cost Bucketing is an effective pruning technique with slight impact on solution quality. In the technique, all solutions with the same buffer cost are placed in a bucket. Each bucket has a *bucket capacity*. It is the maximum number of solutions a bucket can hold. In this thesis, all buckets have the same bucket capacity P . The main power of the restrictive cost bucketing lies in that it imposes some restrictions on the bucket capacity. Through these restrictions, we are able to control the number of solutions in the solution set and thus the overall complexity of the algorithm. If there are excessive solutions to be inserted to a bucket, the *solution*

selection procedure will be carried out. The preference of solutions could be based on various criteria and in our experiments, large slack solutions are preferred.

Figure 8 shows an example of data structure of cost buckets. Eight solutions are inserted into different cost bucket according to their costs, and solutions with the same cost are inserted into the same cost bucket.

The procedure of the new buffering algorithm is as follows.

a. Sink

At a sink node, we create a candidate solution set in which each bucket is associated with a range of buffer costs. A solution is added to a cost bucket associated to zero buffer cost which can be computed since that Q is equal to the required arrival time at that sink and C is equal to the sink capacitance. $W = 0$ and

$$\begin{aligned} CL &= 0, \\ CR &= 0. \end{aligned} \tag{2.12}$$

After this operation, the size of zero cost bucket is equal to 1 and the size of other cost bucket is zero.

b. Wire Insertion

Consider to propagate solutions from a node v to its parent node u through edge $e = (u, v)$. A solution γ_v at v becomes solution γ_u at u , $C(\gamma_u) = C(\gamma_v) + C_e$ and $W(\gamma_u) = W(\gamma_v)$,

$$\begin{aligned} CR(\gamma_u) &= CR(\gamma_v) + R_e \cdot C(\gamma_u), \\ CL(\gamma_u) &= CL(\gamma_v) + L_e \cdot C(\gamma_u), \end{aligned} \tag{2.13}$$

where R_e and L_e are wire resistance and inductance, respectively. Since our delay model is not additive, Q is not updated in the operation of wire insertion. No new

solution is added in the solution set, and the size of each cost bucket does not change.

c. Buffer Insertion

In addition to keeping the unbuffered solution γ_u , a buffer b ($b \in B$) can be inserted at u to generate a buffered solution $\gamma_{u,buf}$.

The required arrival time of new solution is computed as

$$Q(\gamma_{u,buf}) = Q(\gamma_u) - D(\gamma_{buf}), \quad (2.14)$$

where $D(\gamma_{buf})$ is the total downstream delay computed in Eqn. (2.7) and Eqn. (2.8) from node u to its immediate buffered descendant node (which can also be a sink). $D(\gamma_{buf})$ is computed using delay re-evaluation, which is necessary as our delay model is not additive. In [7], when inserting buffers, delay re-evaluation is performed at the driver. For this, an entire tree traversal is needed to get the summation of CR and CL . This step is very time consuming and is the bottleneck for the efficiency of their algorithm.

In our algorithm, an *efficient delay update* technique is used to calculate $D(\gamma_{buf})$ in $O(1)$ time. Our idea is to propagate those summation of CR and CL along with the bottom up solution propagation. At each node, RAT value can be easily computed by Eqn. (2.7) and Eqn. (2.8) without the need to backtrack the downstream subtree. Our experiment indicates that this method significantly saves runtime compared to Ismail's entire tree traversal for delay update.

After buffer insertion, $C(\gamma_{u,buf}) = C_b$ and $W(\gamma_{u,buf}) = W(\gamma_v) + W_b$.

$$\begin{aligned} CR(\gamma_{u,buf}) &= 0, \\ CL(\gamma_{u,buf}) &= 0. \end{aligned} \quad (2.15)$$

The new solution $\gamma_{u,buf}$ is inserted to a cost bucket associated with cost $W(\gamma_{u,buf})$.

According to our *solution selection procedure*, P maximum slack solutions are selected where P is bucket capacity.

d. Branch Merge

When two sets of solutions are propagated through left child branch and right child branch to reach a branching node, they are merged. Denote the left-branch solution set and the right-branch solution set by Γ_l and Γ_r , respectively. For each solution $\gamma_l \in \Gamma_l$ and each solution $\gamma_r \in \Gamma_r$, the corresponding merged solution γ' can be obtained according to $Q(\gamma') = \min\{Q(\gamma_l), Q(\gamma_r)\}$. Note that before merging, $Q(\gamma_l)$ and $Q(\gamma_r)$ need to be re-evaluated by efficient update technique. $C(\gamma') = C(\gamma_l) + C(\gamma_r)$ and $W(\gamma') = W(\gamma_l) + W(\gamma_r)$. To ensure in the worst case, all downstream branches still satisfy the timing constraint, the largest CR and CL between two branches are chosen to propagate. The new $CR(\gamma')$ and $CL(\gamma')$ are computed as

$$\begin{aligned} CR(\gamma') &= \max\{CR(\gamma_l), CR(\gamma_r)\}, \\ CL(\gamma') &= \max\{CL(\gamma_l), CL(\gamma_r)\}. \end{aligned} \tag{2.16}$$

The new solution γ' may be inserted in the buffer cost bucket associated to the cost $W(\gamma')$. After merging, the same *solution selection procedure* is performed on each solution bucket.

e. Linear Time Complexity

Due to introducing restrictive cost bucketing and efficient delay update techniques, the complexity of the whole algorithm breaks down to linear time.

Denote by n the number of nodes of the routing tree and by $|B|$ the number of buffers in the buffer library. Suppose that our solution set has m buckets and bucket capacity is P . It is then clear that at any node, there can be at most mP

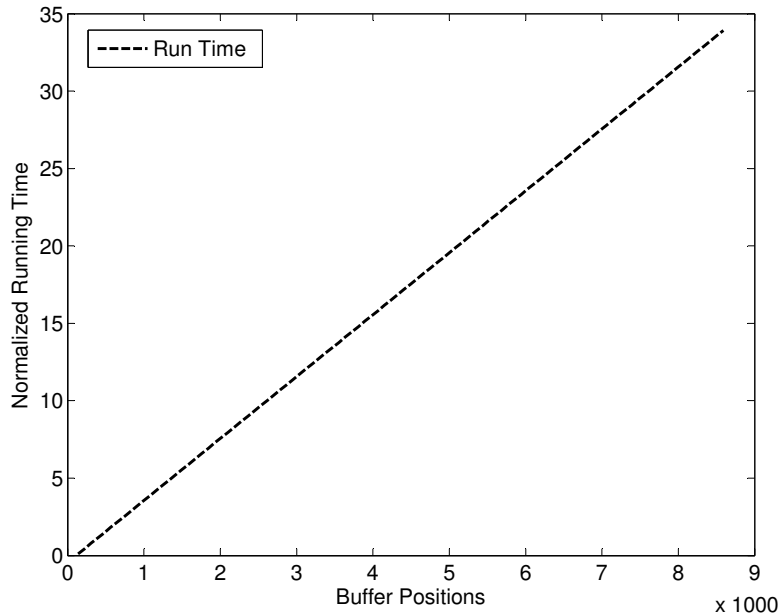

Fig. 9. Time complexity of new RLC algorithm with respect to the number of buffer positions.

solutions. Given this fact, we are to analyze the complexity due to wire insertion, buffer insertion and branch merging operations. For wire insertion, the number of solutions do not increase. For buffer insertion, at most $|B|mP$ could be generated (of course, at most mP can be selected). For branch merging, at most m^2P^2 can be generated. Thus, at any time during the solution propagation, we can have at most $\max\{|B|mP, m^2P^2\}$ solutions. By building a balanced binary search tree on each bucket in the solution set, solution pruning by restrictive cost bucketing can be certainly completed in $\max\{|B|mP, m^2P^2\} \cdot O(\log P)$ time and each delay evaluation only takes $O(1)$ time since we do not need to traverse any subtree. In practice, we set m, P to small constants. Since there are at most n candidate buffer positions, it immediately follows that our algorithm runs in $O(n|B|)$ time.

Figure 9 shows the time complexity of our new algorithm with respect to the

number of buffer positions. The buffer library size is 12. The number of buffer positions is from 138 to 8589. In the figure, the vertical axis is normalized to the running time of the case with 138 buffer positions. We can see our new algorithm behaves linearly with the number of buffer positions.

D. Experimental Results

Our new algorithms and algorithm in [8] are implemented in C++. Implementation of Ismail's RLC algorithm is borrowed from the author's webpage. All algorithms are tested on a Pentium IV computer with a 3.2GHz CPU and 1GB memory. Our test cases are extracted from an industrial ASIC chip, which consists of 1000 nets with more than 50000 nodes including sinks, branching nodes and buffer positions. Among them, 682 nets have ≤ 5 sinks and all the remaining nets have ≤ 20 sinks. The sink capacitances range from $2.5fF$ to $200fF$. The unit resistance is $16.4\Omega/mm$, the unit capacitance is $194.2fF/mm$ and the unit inductance is $1.0nH/mm$. The buffer library consists of 12 buffers. Buffer resistances range from 30Ω to 360Ω and input capacitances range from $3.3fF$ to $40.0fF$. The time unit for this section is ps if not specified. SPICE simulation is based on RLC model in all the experiments below.

For convenience, all algorithms in comparison are listed below together with their abbreviations.

- van Ginneken-Lillis: van Ginneken and Lillis' min-cost timing buffering based on the RC Elmore delay [1, 5].
- Ismail: Ismail's top-down RLC timing buffering algorithm based on RLC Elmore delay [7].
- Impedance: RLC min-cost timing buffering based on *impedance delay* [8].

- NEW: RLC timing buffering without cost minimization based on RLC Elmore delay. In NEW, the number of bucket m is set as 1.
- NEW+COST: RLC min-cost timing buffering based on RLC Elmore delay. In NEW+COST, the number of bucket m is set as 7 and P is equal to 15.

1. Comparison between Ismail and NEW

We compare the number of buffer, SPICE delay and CPU time between Ismail and NEW. The results on total 1000 nets are summarized in Table II. From Table II, we make the following observations:

- The solutions from NEW always have less SPICE delay and less buffer area than those returned by Ismail. Especially, NEW ($P = 50$) can save up to 8.5% buffer area than Ismail.
- In addition to returning high quality solutions, NEW also is efficient in terms of runtime. Especially, NEW ($P = 30$) can provide up to $4\times$ speedup over Ismail. The reason behind this phenomenon is that our restrictive cost bucketing and efficient delay updating techniques tremendously reduce complexity.
- As P increases, the solution quality in NEW also increases and so does the runtime. This property makes NEW greatly suitable for practical use since a tradeoff between solution quality and runtime is easily achieved.

2. Comparison between van Ginneken-Lillis, Impedance and NEW+COST

We compare buffer reduction between van Ginneken-Lillis, Impedance and NEW+COST algorithms since all these three handle cost minimization. The results on total 1000 nets are summarized in Table III. The solution satisfying the minimum delay condi-

tion with minimum number of buffers is chosen. Saving refers to percentage difference in the number of buffers. We make the following observations:

- NEW+COST saves up to 33.4% buffers over van Ginneken-Lillis. One reason for huge buffer saving is that the delay of RLC is approaching linear with inductance effect. Another reason is that delay is overestimated using the traditional Elmore delay model and thus excessive buffers are inserted.
- NEW+COST saves up to 5.3% buffers over Impedance, and in the meantime, NEW+COST achieves up to 5× speedup. NEW+COST provides the best solution quality in the least CPU time, which means that NEW+COST consistently outperforms van Ginneken-Lillis and Impedance.

Table II. Comparison of buffering between Ismail and NEW on five sets of test cases. Each set consists of randomly selected 200 nets.

Test Sets	Ismail			NEW ($P = 30$)			NEW ($P = 40$)			NEW ($P = 50$)		
	# Buf.	SPICE Delay	CPU (s)	# Buf.	SPICE Delay	CPU (s)	# Buf.	SPICE Delay	CPU (s)	# Buf.	SPICE Delay	CPU (s)
S1	1270	965	196	1195	951	50	1236	944	64	1242	939	82
S2	1008	809	124	980	806	45	992	805	51	986	802	70
S3	919	675	106	851	665	40	848	665	50	841	665	61
S4	801	645	103	766	643	40	769	644	47	772	643	58
S5	640	568	66	627	557	35	631	555	42	628	555	50

Table III. Comparison between van Ginneken-Lillis, Impedance and NEW+COST on five sets of test cases, each having randomly selected 200 nets.

Test Sets	van Ginneken-Lillis			Impedance			NEW+COST ($m = 7, P = 15$)				
	# Buf.	SPICE Delay	CPU (s)	# Buf.	SPICE Delay	CPU (s)	# Buf.	SPICE Delay	CPU (s)	Saving to VGL	Saving to Impedance
S1	1635	979	330	1132	935	825	1089	933	167	33.4 %	3.8 %
S2	1428	843	280	982	802	660	965	802	135	32.4 %	1.7 %
S3	1211	688	169	879	667	421	832	658	122	31.3 %	5.3 %
S4	1020	672	152	764	643	388	738	641	110	27.6 %	3.4 %
S5	861	583	123	627	555	271	624	555	103	27.5 %	0.5 %

CHAPTER III

A TWISTED DIFFERENTIAL LINE FOR GLOBAL BUS

Twisted differential line structure can effectively reduce cross-talk noise on global bus, which foresees a wide applicability. However, measured performance based on fabricated circuits is much worse than simulated performance based on the layout. It is suspected that the via resistance variation is the cause.

In this thesis, our extensive simulation confirm this. A new redundant via insertion technique is proposed to reduce via variation and signal distortion. In addition, a new buffer insertion technique is proposed to synchronize the transmitted signals, thus further improving the effectiveness of the twisted differential line.

A. Introduction

With the VLSI technology scaling, global buses between function blocks become much longer and frequencies of signals become much higher. Subsequently, significantly more crosstalk are observed between neighboring bus lines, which causes the bus signal transmission unreliable.

Much research effort has been spent on reducing crosstalk and improving signal integrity on buses. Most of them focus on reducing capacitive crosstalk using single-end structure, for example, shielding and metal spacing [16]. They are capable of eliminating capacitive crosstalk since electrical field effect is of short range and tends to terminate in neighboring metal materials. In contrast, magnetic field effect is of long range, and thus these techniques can not suppress inductive crosstalk. As signal frequency increases, inductive crosstalk becomes as important as (i.e., comparable in magnitude to) capacitive crosstalk and is no longer negligible. Thus, it is imperative to consider both capacitive and inductive crosstalk in global bus design.

Differential signalling is such a technique. It is shown in [17] that 95.7% noise reduction can be obtained by this technique. However, [17] uses two parallel traces for each signal line, which can not effectively handle asymmetric noise sources. Thus, a twisted differential line structure (TDL) is proposed in [18], which differs from [17] in that the two traces can twist each other (through vias) periodically. This helps to balance the amount of noise at each trace. It is demonstrated in [19] that TDL can gain over 90% further noise reduction compared to untwisted differential structure. This foresees the wide applicability of TDL technique. However, measured performance based on fabricated circuits is much worse than simulated performance based on the layout. It is suspected that the via resistance variation is the cause. The problem aggravates with technology shrinking since both the nominal value and variation on via resistance are increasing. This imposes a great challenge in making twisted differential signalling technique practical.

In this thesis, we first analyzed the reason that fabricated TDLs do not perform as expected. Through extensive simulation, we confirm that the cause of the performance degradation is via resistance variation. We then propose a new redundant via insertion technique to reduce the effect of via variation and signal distortion. In addition, we propose a new buffer insertion technique for signal synchronization.

Experimental results demonstrate a 6GHz signal can be transmitted with high fidelity using the new approaches. In contrast, only a 100MHz signal can be reliably transmitted using a single-end bus with power/ground shielding. Compared to conventional twisted differential line structure, our new techniques can reduce the magnitude of noise by 45% as witnessed in our simulation. Furthermore, compared to unbuffered twisted differential line structure, the maximum signal phase difference is reduced from 37ps to 7ps by the new buffer insertion technique.

B. Effect of Via Variation

1. Experiments Setup

The following realistic setup applies to all experiments. MOSIS 130nm technology [13] is used for our simulation. In an 8-bit global bus, each bit occupies an area of width of $2.5\mu m$, height of $3\mu m$, length of $3200\mu m$, and space between adjacent bits is $2.5\mu m$. Our aim is to design high speed bus, thus a 6GHz clock signal with a slew of 10ps is taken as the input signal. The power supply is 1.5V, and we define the acceptable noise margin is 10% of power supply as in [20], which is 0.15V. If signal exceeds the acceptable noise margin, we consider that a performance violation happens. The interconnect is modeled as 50 segments of unit length, and each segment uses the π model. FastHenry [12] is applied to extract both resistance and inductance. An accurate empirical model [21] is applied to extract capacitance of interconnects. SPICE is used for the simulation.

2. Single-end Bus Structure

We perform simulation on the widely used single-end bus structure with power/ground shielding. The schematic is shown in Figure 10. In this structure, each signal line is sandwiched by a power trace and a ground trace, which can almost fully protect the signal line from capacitive crosstalk. Each signal line is also provided with an adjacent current return path, which could help reduce the inductive crosstalk. To test the worst-case noise generated on the 8-bit bus, a 6GHz signal is sent to all the inputs except the one in the middle. The middle line, called *observation line*, serves as the observation point for the noise. Buffers are used as drivers and receivers. SPICE simulation result is shown in Figure 11(a). One sees that the peak noise is 0.35V, which exceeds the acceptable noise margin.

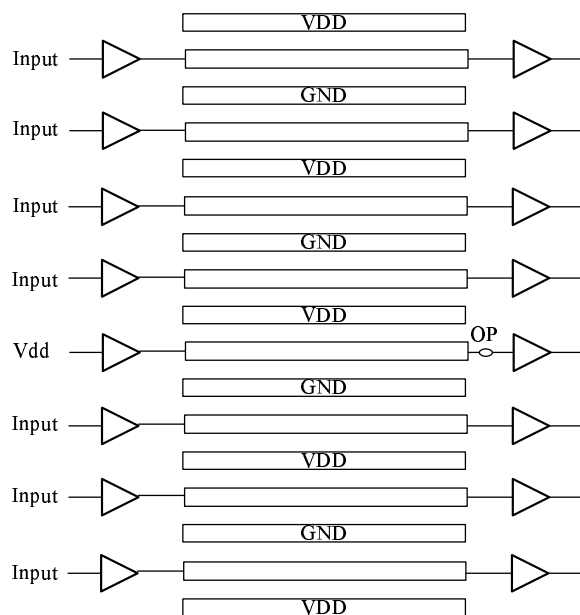

Fig. 10. A single-end model of 8-bit global bus. OP denotes the signal observation point.

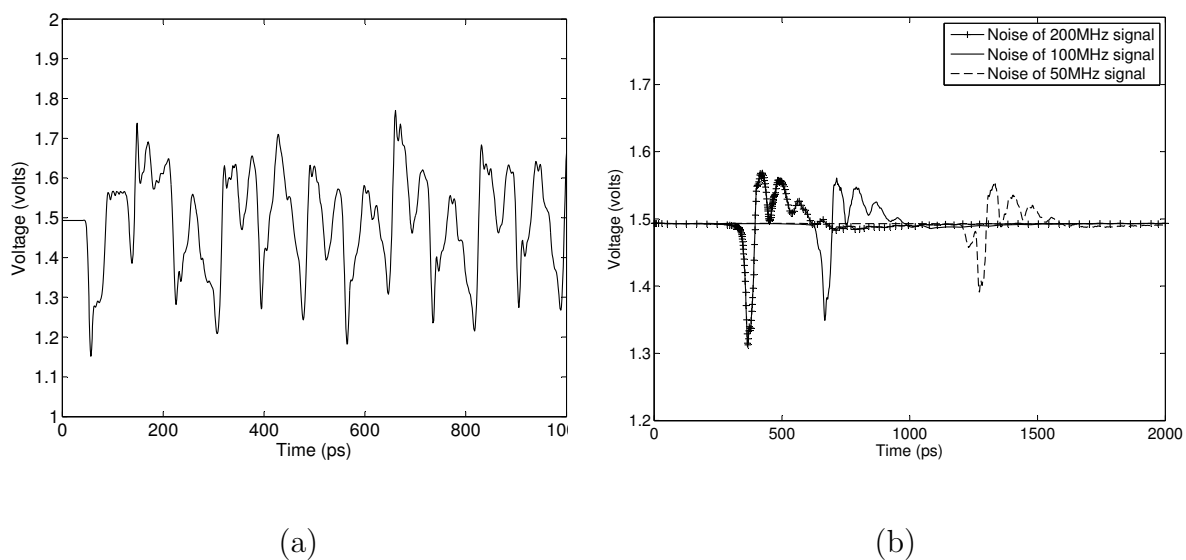

Fig. 11. (a) Noise signal is measured at OP in Figure 10. The peak noise of 6GHz input signal is 0.35V. (b) The peak noise of 200MHz input signal is 0.18V, of 100MHz is 0.15V and of 50MHz is 0.11V.

Since the desired 6GHz signal cannot be transmitted reliably, we investigate the highest signal frequency which can be achieved using single-end bus. In the power/ground shielding bus model, the noise will not fall into the acceptable margin unless we decrease the input signal frequency (signal slew is fixed as 10% of signal period) to 100MHz. Refer to Figure 11(b). It is clear that the conventional single-end bus model is not sufficient to handle high frequency signal transmission even if power/ground shielding technique is incorporated.

3. Standard Twisted Differential Line Structure

In the twisted differential line structure (TDL) in Figure 12, for each bit line, two parallel traces are used to transmit the complementary signals and the two traces are twisted periodically. At a twisting point, one trace keeps its route while the other goes down and then up across metal layers. Two vias are needed for each twisting. The twisted differential line structure is very effective in noise reduction since each trace receives balanced noise from the environment, regardless of the location of noise source.

However, the transmitted signals after fabrication suffer huge distortion even if the signals function correctly in layout simulation. It is suspected that via resistance variation is the cause. In order to justify our statement, we perform intensive simulation considering different sources of variation, e.g. gate length, gate oxide thickness, interconnect height and via resistance.

As a realistic setup, each trace of bus has 4 twisting points, that is, 8 vias in total for each two complementary traces. The nominal value of the via resistance is 5Ω , and it varies from 3Ω to 7Ω [22]. The nominal value of gate length, gate oxide thickness and interconnect height is from MOSIS 130nm technology [13]. From our simulation result in Figure 13(a), one sees that without any variation, the input signal

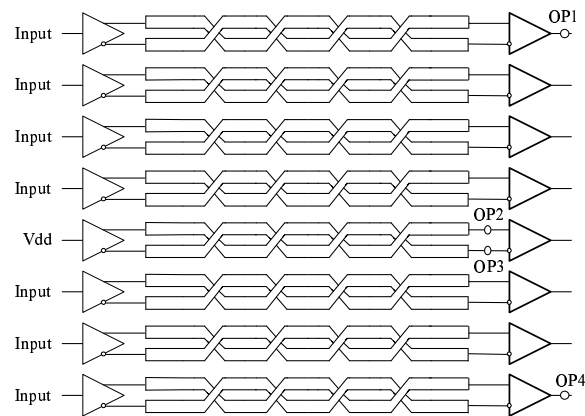

Fig. 12. A TDL structure of 8-bit global bus with single via.

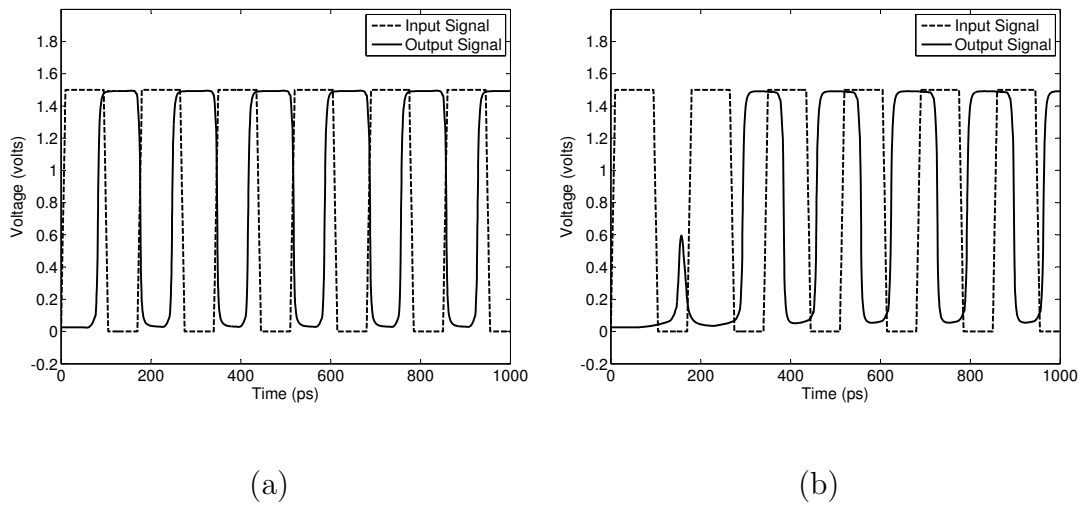

Fig. 13. (a) Signal in TDL structure with single via and without variation. Output signal is measured at OP4 in Figure 12. (b) Signal in TDL structure with single via and with via variation. Output signal is measured at OP4 in Figure 12.

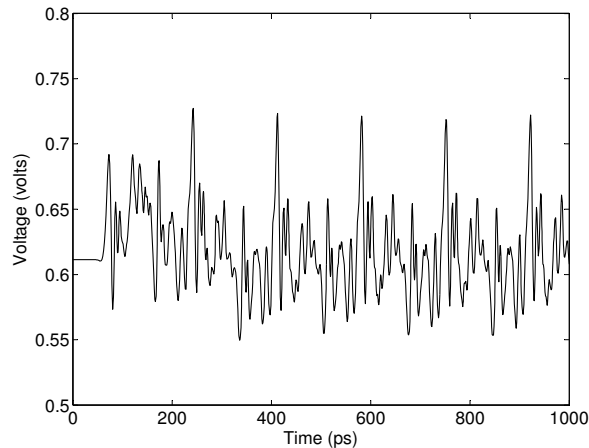

Fig. 14. Noise signal in TDL structure with single via. Signal is measured at OP3 in Figure 12. The peak noise is 0.11V.

can be transmitted in high quality.

A relationship between via resistance variation and other variation is established in the simulation. With 10% via resistance variation, the impact to the output signal is equal to 30% gate length variation, 20% gate oxide thickness variation or 15% interconnect height variation. This demonstrates that the via resistance variation has a larger impact on the output signal. When worst-case via variation is considered, the logic failure of output signal happens. From Figure 13(b), one can see that the input signal originally is 101010101010, however, the output signal turns into 001010101010. These simulations demonstrate that via variation have critical impact on signal transmission on global bus and via resistance increases with technology shrinking. As it turns out, the vias are bottlenecks of performance of TDL.

This imposes a great challenge on high-speed bus design. Note that although signal can not be reliably transmitted when via variation are considered, the noise is still significantly reduced. The noise is shown in Figure 14. The peak noise is 0.11V, compared with 0.35V in the single-end structure shown in Figure 11(a).

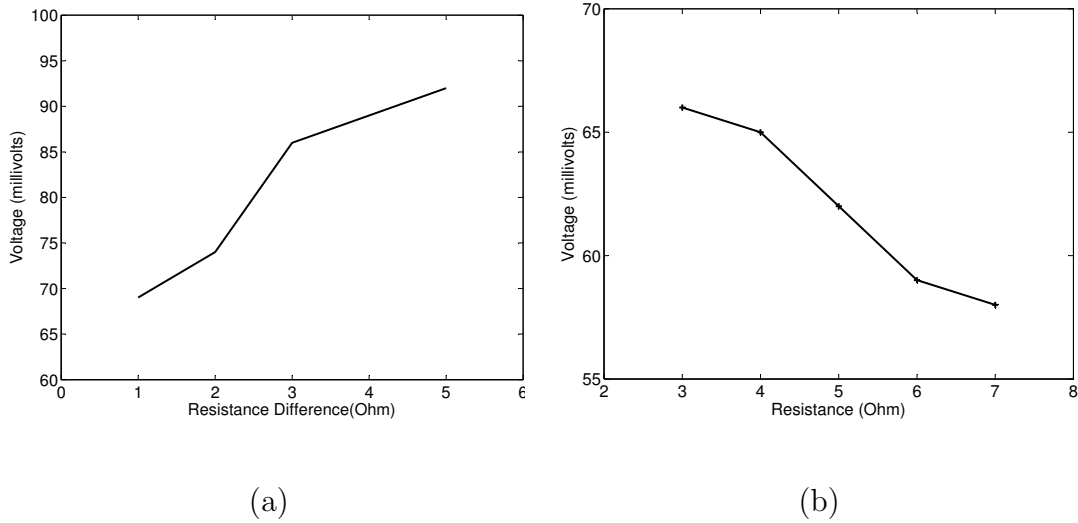

Fig. 15. Peak noise is measured at OP3 in Figure 12. (a) The peak noise with respect to the resistance difference between two neighboring traces. (b) The peak noise with respect to the resistance in two neighboring traces. The resistance of two traces is the same.

C. New Twisted Differential Line Structure

Based on a redundant via insertion technique and a buffer insertion technique, a new twisted differential line structure is proposed. With it, the hurdle of signal distortions associated with the standard TDL is overcome. This makes the TDL technique, which is very effective in reducing both capacitive and inductive noise, practical in high speed global bus design. We envision the new TDL structure to have wide applicability in practice.

We begin with investigating the relationship between cross-talk noise and redundant via. The effect of redundant via is twofold: First, redundant via reduces the resistance variation/difference between neighboring traces. Second, redundant via reduces the nominal resistance value of neighboring traces. Figure 15(a) shows that

peak noise increases with the resistance difference between neighboring traces. Figure 15(b) shows that peak noise decreases with resistance of neighboring traces. The two figures demonstrate that the twofold effect of redundant via competes each other, and since the peak noise is more sensitive to the resistance difference, the crosstalk noise can be reduced by redundant via insertion technique. This observation will be explored in the following section.

1. Redundant Via Insertion

TDL needs vias to connect between neighboring metal layers. With technology scaling, via size keeps shrinking and via contact resistance keeps increasing. The problem aggravates since variation on via due to cut misalignment, electro migration and thermal stress increases. As a consequence, distortions in signal transmission are observed.

To tackle this issue, we propose to insert redundant vias into the initial design. Given a via (which is around a twisting point in TDL), putting $n - 1$ additional vias in its close proximity can reduce the nominal value of the resistance to $1/n$ and variation of the conductance to $O(1/n^2)$. In addition, doing so will also reduce the effect of variation on vias. On the other hand, one might wonder the effect of the additional cost (e.g., power) due to the inserted redundant vias. Since a global bus often has very few twistings/vias, doubling/tripling them will not cause trouble. In fact, redundant via methodology has been recommended as an effective technique to improve yield by major foundries in their $130nm$ and $90nm$ processes [23]. Major EDA vendors such as Cadence and Synopsys have already allowed the feature of redundant via insertion in bus routing design [24] without violating any design rule. Figure 16 shows two different layouts using Virtuoso.

As shown in Figure 13(b), standard TDL with single via fails to transmit high

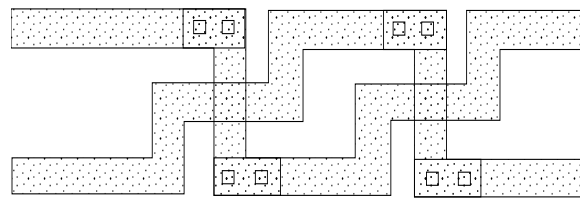

(a)

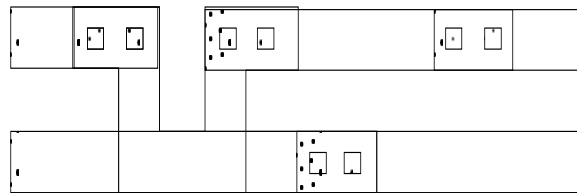

(b)

Fig. 16. Two layouts of TDL structure with double vias using Virtuoso. Both designs are symmetric for delay balance and noise reduction.

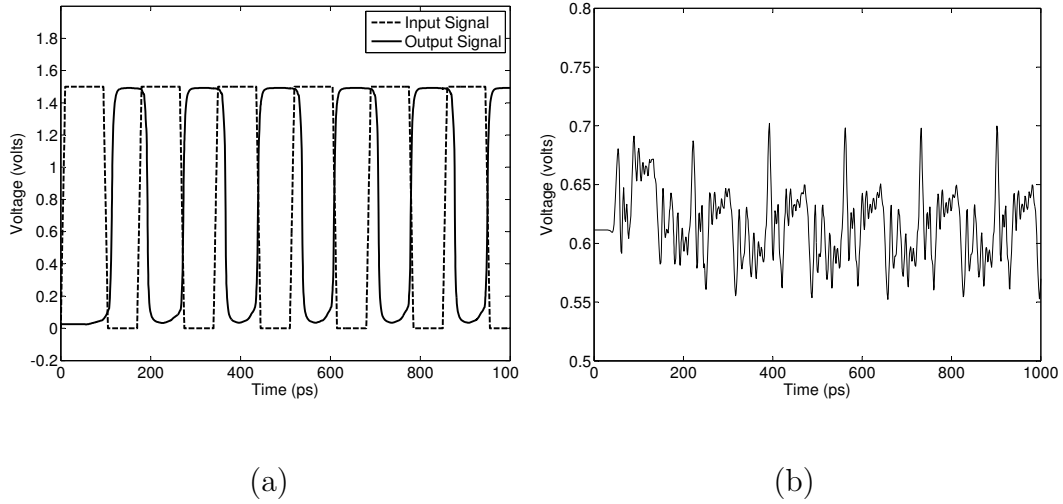

Fig. 17. (a) Input signal and output signal in TDL with double vias. Output signal is measured at OP4 in Figure 12. (b) Noise signal in TDL with double vias. Signal is measured at OP3 in Figure 12. The peak noise is 0.08V.

frequency signal. We apply our redundant via insertion technique in the same simulation environment. Figure 17(a) shows the output signal after adding another via, which well matches the input signal.

The crosstalk noise is also reduced by redundant via technique. Figure 17(b) shows the crosstalk noise in TDL with double vias. The peak noise is 0.08V, compared with 0.11V of standard TDL with single via in Figure 14.

The comparison of TDL performance between single via and double vias is summarized in Table IV. Suc. represents that the noise falls in the acceptable margin and output signal has no logic failure. When input frequency is higher than 5GHz, TDL with single via has logic failure in the output. In the contrast, TDL with double via reliably transmits input signal to the output. In the meantime, the noise and output delay difference of double via circuit is consistently less than these of single via circuit.

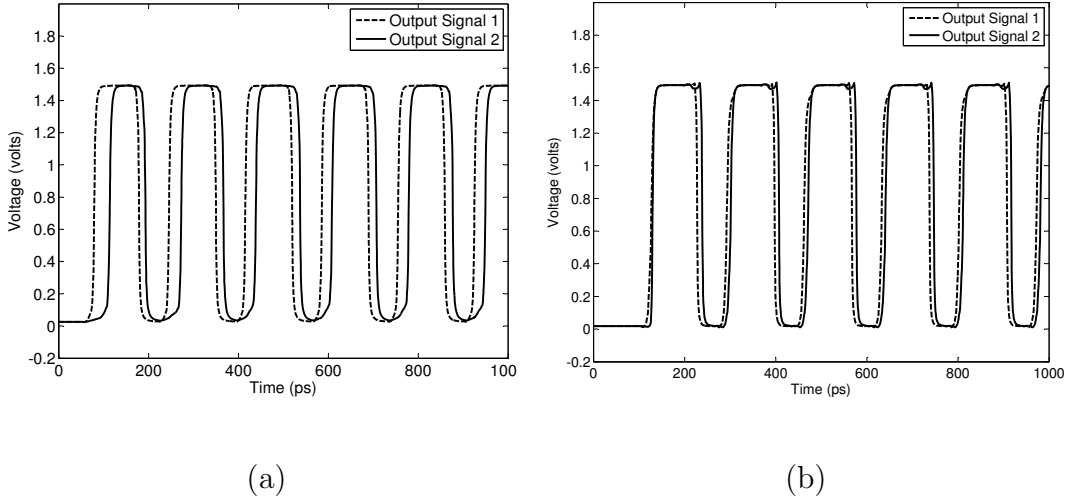

Fig. 18. (a) Output signals in twisted differential line structure with double vias. Output signals are measured at OP1 and OP4 in Figure 12. The maximum output difference is 37ps. (b) The maximum output difference is 7ps.

2. Buffer Insertion

The output signals can be out of synchronization in global bus due to via resistance difference and delay difference on each trace, which is often observed in our simulation. An example is shown in Figure 18(a), where the delay difference between the two output signals is 37ps, which is almost 1/4 of signal period. There are previous works on applying buffer insertion to global bus design [25]. However, all of them focus only on noise reduction, since in previous bus design, signal traces are either singled-ended or not twisted. In the new TDL design, buffer insertion is applied to handle signal synchronization.

Denote by *sync-error* the maximum delay difference between signal traces at the receiver. Thus, we are to reduce *sync-error* in a bus design by buffer insertion. A highly effective pruning technique and a buffering pattern based timing evaluation method are proposed in the algorithm.

Table IV. Comparison of TDL performance between single via and double vias.

Test Freq.	Single Via			Double Vias		
	Noise (volt)	Maximum Delay Difference(ps)	Suc.	Noise (volt)	Maximum Delay Difference(ps)	Suc.
100MHz	0.02	29	YES	0.02	21	YES
500MHz	0.03	42	YES	0.02	21	YES
1GHz	0.04	42	YES	0.03	24	YES
2GHz	0.05	43	YES	0.03	34	YES
3GHz	0.06	44	YES	0.04	34	YES
4GHz	0.06	45	YES	0.05	35	YES
5GHz	0.09	-	NO	0.06	35	YES
6GHz	0.11	-	NO	0.08	37	YES

The simulation result after buffer insertion is shown in Figure 18(b). The sync-error decreases to 7ps compared with 37ps in Figure 18(a). As a comparison, we perform some buffer insertions by hand and the results are consistently worse compared to the above result. The sync-error of our best result by hand is 12ps. Along with sync-error, crosstalk noise can be further reduced by buffer insertion. The peak noise is 0.06V, which is 45% of 0.11V in standard TDL with single via.

CHAPTER IV

CIRCUIT-WISE BUFFER INSERTION AND GATE SIZING ALGORITHM
WITH SCALABILITY

Most existing buffer insertion algorithms, such as van Ginneken's algorithm, consider individual nets and therefore often result in high buffer cost due to over-buffering. Thus, circuit-wise buffering is necessary to reduce buffer cost. Recently, some circuit-wise buffering algorithms are proposed, [26, 27, 28, 29]. However, these algorithms are based on heuristics which are not scalable in handling large circuits. This motivates us to design a scalable circuit-wise buffer insertion algorithm to handle circuits with million plus gates.

In this thesis, we present an algorithm two novel features. (1) A circuit partition technique based on the criticality of the primary inputs. The downstream cones of the critical primary inputs are solved separately in the linear programming solver. The circuit partition technique provides high scalability for the algorithm. (2) A linear programming formulation of non-linear delay versus cost tradeoff. Due to the similar nature of buffer insertion and gate sizing, gate sizing can also be handled in such a formulation.

A. Introduction

As VLSI technology enters the nanoscale regime, a great amount of efforts have been made to reduce interconnect delay. Among them, buffer insertion stands out as an effective technique for timing optimization. A dramatic rise in on-chip buffer density has been witnessed [3, 4]. For example, in two recent IBM ASIC designs, 25% gates are buffers [4].

The most classic work in buffer insertion is van Ginneken's dynamic programming

algorithm [1], which takes an individual net as input and returns the maximum slack solution in quadratic time. As an extension, buffer cost and buffer library is handled in [5]. Recently, the time complexity of van Ginnenken’s algorithm is reduced to $O(n \log n)$ by [30] while keeping its optimality. However, since these works consider individual nets and lack a global view of the entire circuit, usually the algorithms result in excessive buffer cost.

The first circuit-wise buffer insertion algorithm [26] is based on Lagrangian relaxation, which takes an entire circuit as input instead of an individual net. A critical path based buffer insertion algorithm is presented in [27]. The timing constrained buffer minimization problem is formulated as a network flow problem in [28]. A look-ahead and back-off heuristic is proposed in [29]. However, from their experimental results, none of these techniques is scalable to handle large circuits. Due to technology shrinking, millions of gates are placed on a chip, and algorithms without scalability can not fit into current and future physical synthesis flow. This motivates us to design a circuit-wise buffering algorithm with scalability to handle million plus gates.

Along with buffer insertion, gate sizing is another important technique for timing optimization. It is extensively studied, such as [31], [32] and [33]. A posynomial programming approach is proposed in [31], an exact solution based on convex optimization is provided in [32], and a technique based on Lagrangian relaxation is utilized in [33]. Both gate sizing and buffer insertion attempt to adjust the upstream capacitance and downstream resistance of a gate/buffer to minimize total delay and they both provide a tradeoff between delay and cost. Thus, it is beneficial to simultaneously handle both in one algorithm. Such an algorithm is proposed in this thesis.

In this thesis, we propose a novel circuit-wise simultaneous buffer insertion and gate sizing algorithm. The novel features of the algorithm are summarized as follows.

- Circuit partition technique based on the criticality of the primary inputs. The downstream cones of the critical primary inputs are solved separately in the linear programming solver. The circuit partition technique provides the scalability for the algorithm.
- Linear programming formulation of non-linear delay versus cost tradeoff. Based on the observation that non-linear tradeoff is usually convex, it can be modeled into several linear functions, which can be efficiently solved under linear programming formulation.

B. Problem Formulation

Without loss of generality, we only focus on the combinational circuit. A placed and routed combinational circuit is formulated as a directed acyclic graph (DAG) $G = (V, E)$. An example is shown in Figure 19(a) and Figure 19(b). The set of nodes $V = V_t \cup V_n$, where V_t are primary input (PI), primary output (PO), gate input and gate output nodes in the circuit, and V_n are internal nodes and candidate buffer locations on the interconnect. The set of edges E consists of the edges on the interconnect and internal paths within a gate.

A buffer library B is provided as a part of the problem statement. The buffer library B contains different types of buffers. Each type of buffer b is associated with output resistance R_b , input capacitance C_b , intrinsic delay K_b and buffer cost W_b . Buffer cost W_b can be measured by area, power consumption or any other metric, depending on the optimization objective.

Each gate is modeled in a similar manner as a buffer. Each gate input node v is associated with input capacitance C_v and each gate output node u is associated with output resistance R_u . If x_i is the size of the gate, $C_j = \hat{C}_j x_i + f_j$ and $R_i = \hat{R}_i / x_i$,

where \hat{C}_j , \hat{R}_i and f_j are the unit gate area capacitance, unit output resistance and gate perimeter capacitance. In this thesis, the size of each gate x_i is selected from the gate library $S = \{x_1, \dots, x_n\}$, and we do not assume to have a huge buffer and gate library.

Each interconnect edge e is modeled as a π type RC model and is associated with resistance $R(e)$ and capacitance $C(e)$. Elmore delay is adopted in our work.

The problem of **circuit-wise simultaneous buffer insertion and gate sizing** is defined as follows. Given a DAG which represents a placed and routed combinational circuit, possible candidate buffer locations, a buffer library and a gate library, find a buffering and gate sizing solution such that the total costs of buffers and gates are minimized, and the required arrival time at each primary input is less than a given constant constraint.

Routing trees are generated by partitioning the combinational circuit and ignoring all the steiner nodes. An example is shown in Figure 19(c). In each routing tree, the root is either a PI vertex or a gate output node, while each sink is either a PO vertex or a gate input node. Each routing tree is identified by its root, which means that each tree has a corresponding root. For instance, the routing tree with root e , sink o , h and j can be represented as $RT(e)$. In this routing tree, root e is a gate output node, sink o is a PO vertex, and sink h and j are gate input nodes.

C. Algorithm

In this section, a novel circuit-wise simultaneous buffer insertion and gate sizing algorithm is proposed. We first describe the overall flow and then present the key features of the algorithm: (1) Post-buffering timing estimation technique; (2) Circuit partition technique; (3) Linear formulation of non-linear delay versus cost tradeoff;

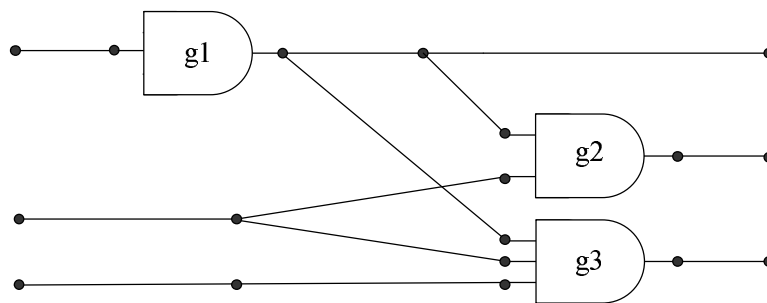

(a)

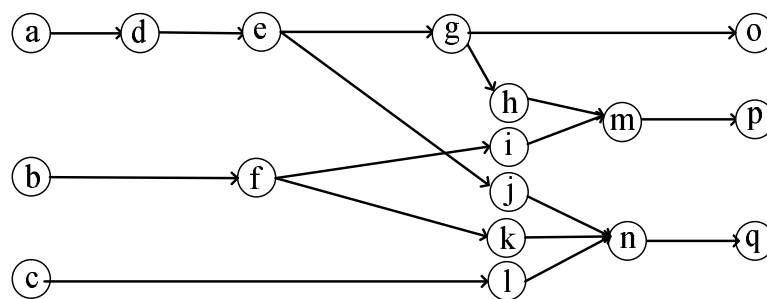

(b)

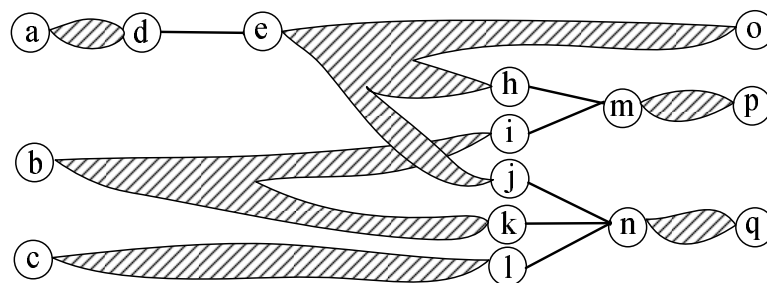

(c)

Fig. 19. (a) A combinational circuit. (b) The corresponding DAG of the circuit. (c) The corresponding routing trees and gates of the circuit.

(4) Linear programming formulation; (5) Considering slew and buffer congestion.

Our algorithm starts with a post-buffering timing estimation [34]. In their estimation, they derive a delay equation for an efficient estimation on multi-pin nets. The required arrival time (RAT) and arrival time (AT) of each node in the circuit serve as the estimated post-buffering value. A circuit partition technique is proposed to solve the sub-circuits separately in the linear programming solver. The circuit partition technique provides the algorithm scalability to handle large circuits, and for small circuits, the technique is optional since these circuits can be solved as a whole within reasonably short time and without partition error.

To generate buffer delay versus cost tradeoff, van Ginneken-Lillis' dynamic programming algorithm is applied to each routing tree. Gate delay versus cost tradeoff can be created in a similar manner. Based on the observation that non-linear tradeoff is usually convex, delay cost tradeoff curve is modeled into linear programming format. Moreover, following the approach in [31], the timing constraint buffer/gate cost minimization problem is formulated into a linear programming problem.

1. Post-buffering Timing Estimation

The circuit-wise algorithm requires an accurate timing analysis for allocating buffer and gate resources. The conventional static timing analysis is ineffective since delays along circuit paths change dramatically during the procedure of buffer insertion. Thus, a more accurate timing analysis method is necessary for the circuit-wise buffer insertion and gate sizing.

A post-buffering timing estimation technique is proposed in [34], which derives delay equations along a buffered wire segment and applies the equations for the delay estimation upon multi-pin nets. This approach is adopted in this thesis. In our experiment, we use a medium-size buffer in the library for the estimation. Experimental

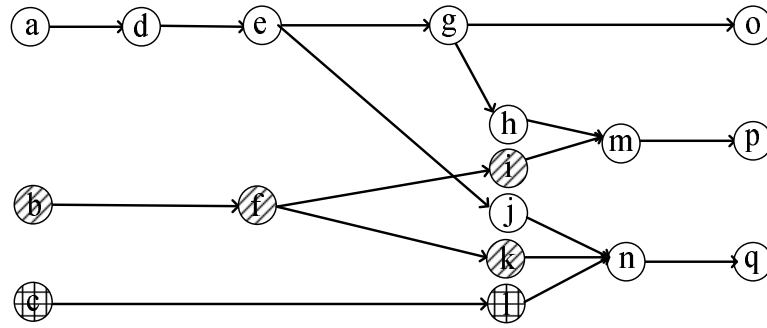

Fig. 20. The circuit is partitioned into three sub-circuits based on the downstream cones of primary inputs. The input a is the most critical primary input in the circuit.

results show that the delay estimation is only 5% off the value of van Ginneken-Lillis's algorithm using full buffer library. After the estimation, the AT and RAT of each node is known, which determines the criticality of each node and helps to allocate the buffer and gate resources in the following part of the algorithm.

2. Circuit Partition Technique

Due to the near quadratic relationship between the CPU time of the linear programming and the number of gates in the circuit, the linear programming method becomes prohibitive as the number of gates approaches millions. It is necessary to adopt the divide-and-conquer scheme to speed up the algorithm. Such a technique is proposed in the following.

The key components of the circuit partition technique are how to decide the partition boundary and how to handle side inputs/outputs in the sub-circuits.

a. The Partition Boundary

In order to minimize partition error, the technique avoids partitioning the critical paths into different sub-circuits, which means that the partition boundary never cuts through the most critical path. It is natural to consider the downstream cone of the most critical primary input as a sub-circuit. The criticality of a primary input is determined by the RAT value of the primary inputs, which are calculated in the post-buffering estimation. Since the first sub-circuit is determined through the criticality of the primary inputs, other sub-circuits can also be determined in the same way. Suppose that the n most critical primary inputs are picked in the circuit, their downstream cones can be considered as individual sub-circuits. If there is an overlap between different downstream cones, the overlap part belongs to the cone with the most critical primary input. Referring to Figure 20, there are overlaps between downstream cones of inputs a, b and a, c . Since a is the most critical primary input, the overlap part belongs to the cone with a .

The whole circuit is partitioned into n downstream cones plus the remaining circuit. In most cases, the remaining circuit is disjointed as m parts, and each part can be treated as a sub-circuit. However, in the case which the remaining circuit is connected as a whole, the circuit can be partitioned evenly to k parts, and each part is considered as a sub-circuit. The reason of the evenly partitioning is that the remaining circuit is non-critical, tolerating more partition error than the critical nets. At this point, the circuit can be partitioned into $n+m$ or $n+k$ sub-circuits depending on whether the remaining circuit is disjointed or not. In Figure 20, if three primary inputs are picked in the first step, there is no nodes in the remaining circuit. If only input a is picked, the remaining circuit contains nodes b, f, i, k, c, l , which is disjointed as two parts: b, f, i, k and c, l .

b. Side Inputs and Outputs

After the post-buffering estimation, the RAT and AT of each node are known. The RAT of boundary nodes are considered as the timing requirement of the side outputs, and the AT of boundary nodes are considered as the initial delay of the side inputs. These values are used in the following linear programming inequations.

3. Linear Formulation of Delay vs. Cost Tradeoff

After post-buffering timing estimation, the AT and RAT of each node are known. Then, van Ginneken-Lillis' algorithm is carried out for each routing tree in the circuit. In multiple-sink tree, each sink have its own RAT value and root-to-sink path. Thus, it has its own buffer delay cost tradeoff curve. To facilitate the curve generation, we need to augment the data structure of conventional van Ginneken-Lillis' algorithm, which only maintains the RAT of the most critical sink. In the augmented data structure, each candidate solution contains a tuple with the updated RAT of all downstream sinks. Later, these RAT value will be used in linear programming formulation. However, the solutions satisfying the RAT requirement of a sink may violate the RAT requirement of another. Conventionally, decoupling buffers are inserted at each branch point to avoid this multi-sink tree problem [26], [28], which wastes a lot of buffers if the optimal number of buffers is far less than the number of branch points in the tree. Instead, in the new algorithm, we only keeps one unique solution set, which is to minimize the maximum delay among all sinks. At the root, only one buffer delay cost tradeoff curve is returned, which contains delay information of each sink due to the data structure augmentation. Thus, the tradeoff curve of each sink can be projected by the tradeoff curve at the root.

Figure 21(a) shows the curves of a tree with 2 sinks: two original curves and two

approximation curves. We focus on the original curves first. One sees that Sink One is more critical than Sink Two since it always has greater delay. Thus, the solution set is maintained only for minimizing the delay of Sink One. The curve of Sink Two can be projected since both curves share the same solution set and the same buffer cost variable. This formulation not only facilitates the delay verse cost tradeoff generation, but also simplifies the following linear programming formulation. If we use one buffer cost variable for each sink, the running time of the tradeoff generation and linear programming becomes prohibitive to approach.

Table V. Tree delay with different sink and driver sizes. # Buffer denotes the number of buffers in the tree.

# Buffer	Fix driver, change sink size				Fix sink, change driver size			
	1X	2X	3X	4X	1X	2X	3X	4X
0	64.1	65.6	66.8	67.6	95.2	90.7	81.6	67.6
1	35.5	36.3	36.9	37.3	43.2	41.2	39.5	37.3
2	28.4	29.0	29.4	29.7	32.1	31.4	30.5	29.7
3	27.8	28.2	28.5	28.7	30.5	29.9	29.1	28.7
4	27.1	27.3	27.5	27.6	29.3	29.0	28.3	27.6

In the tradeoff curve generation, the downstream sink and upstream driver of the routing tree are assumed as fixed size gates. Table V shows that fixed sink and driver sizes only provides insignificant error in most cases. With the same driver and different sink sizes, the delay varies in a small range, especially when buffers are inserted in the routing tree. With the same sink and different driver sizes, the

delay difference is comparatively greater in no buffer case. However, once buffers are inserted, the delay difference decreases dramatically since both the interconnect and buffer shield the varying sink capacitance and driver resistance. Due to the small difference in most cases, it makes sense to use fixed gate size to computer tradeoff curve.

A curve fitting method is adopted to approximate each tradeoff as several linear segments. In this thesis, the number of segments is set as 2, which gives good accuracy. Figure 21(a) shows both the original and approximated curves of an actual net. More segments are tested in our experiments, resulting in marginal improvement. If the number of segments is 3, the final circuit Elmore delay improves less than 0.1% while the linear programming solver time increases more than 50%.

Suppose Q_{root} , $Q_{sinkone}$ and $Q_{sinktwo}$ are RAT values at root, Sink One and Sink Two, respectively. X_c is the number of buffers at this tree, which corresponds to the x coordinate in the figure. Thus, we get the following formulation of the delay constraints:

$$Q_{root} + c_1 X_c + c_5 \leq Q_{sinkone}, \quad (4.1)$$

$$Q_{root} + c_2 X_c + c_6 \leq Q_{sinkone}, \quad (4.2)$$

$$Q_{root} + c_3 X_c + c_7 \leq Q_{sinktwo}, \quad (4.3)$$

$$Q_{root} + c_4 X_c + c_8 \leq Q_{sinktwo}, \quad (4.4)$$

$$L_c \leq X_c \leq U_c, \quad (4.5)$$

where c_i is the curve fitting coefficient. L_c and U_c denote the lower bound and upper bound of the number of buffers, which are 0 and 5 in this case.

The intuition behind the linear formulation of non-linear delay versus cost trade-

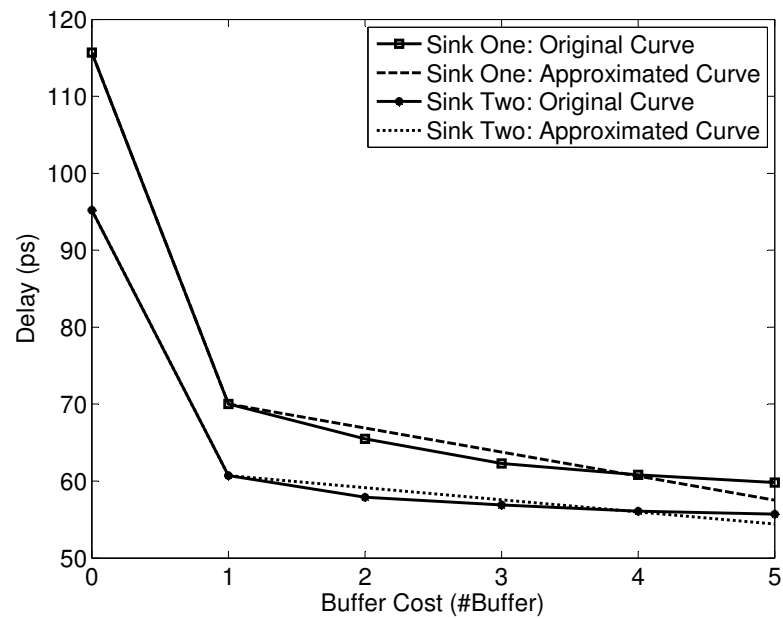

(a)

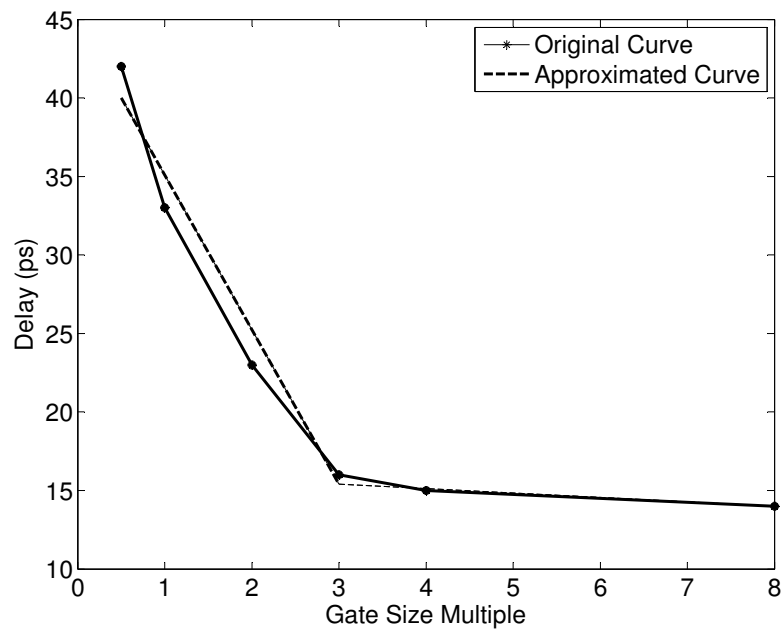

(b)

Fig. 21. (a) The original buffer delay cost tradeoff and the approximation. (b) The original gate delay cost tradeoff and the approximation.

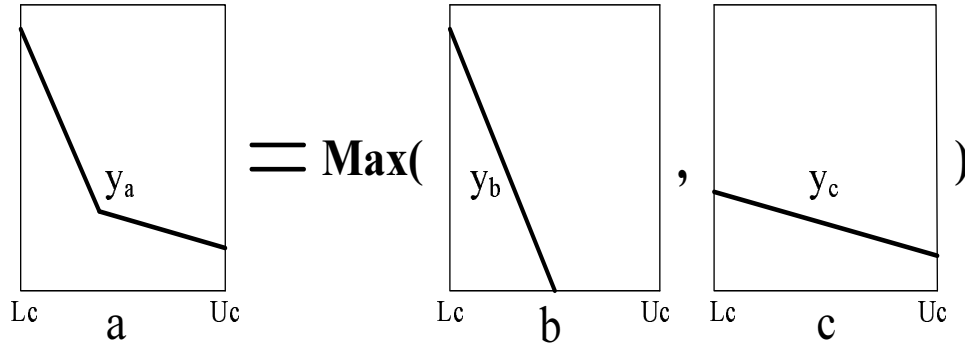

Fig. 22. The intuition behind the delay constraint formulation.

off curve is shown in Figure 22. Curve a is a delay cost tradeoff approximation curve with two segments, which is the max of curve b and curve c . If a variable y is no less than y_a in the range of L_c and U_c , it is equivalent to say that y is no less than y_b and y_c in the same range, and vice versa.

One observation is made on the non-linear delay versus cost tradeoff. The optimal buffer delay cost tradeoff shows that with buffer cost increasing, the delay usually decreases and the amount of delay reduction also decreases. In other words, the approximation curve is convex. Referring to Figure 21(a). The original and approximated curves are convex.

Gate delay cost tradeoff curves are generated for each type of gate in the gate library $S = \{x_1, \dots, x_n\}$ in the similar manner. Referring to Figure 21(b). The curve fitting is applied on gate delay cost tradeoff curves and the convex property can also be observed.

4. Linear Programming

Linear programming is a well-known technique to handle a large amount of variables, which is adopted in this algorithm. The formulation follows the approach in [31].

The circuit path delay is expressed by the sum of its component delay, which is interconnect delay or gate delay. In this way, a relationship between the circuit path delay and its component delay, and the buffer/gate cost is established.

a. LP Formulation

At this point, the circuit-wise simultaneous buffer insertion and gate sizing problem is formally formulated into a linear programming problem.

$$\begin{aligned} & \text{Minimize } \sum_{i=1}^m X_i + \sum_{i=1}^n X_{gi} \\ & \text{S.t. } Q_i + c_e X_i + c_f \leq Q_j, \\ & \quad L_i \leq X_i \leq U_i, \quad \forall i \in \text{Primary Input or Gate Output and } \forall j \in \text{Sinks of RT}(i), \\ & \quad Q_a + c_g X_{gi} + c_h \leq Q_b, \\ & \quad L_{gi} \leq X_{gi} \leq U_{gi}, \quad \forall a \in \text{Gate Input of } gi \text{ and } \forall b \in \text{Gate Output of } gi, \\ & \quad Q_t = \text{User Defined Required Arrival Time}, \quad \forall t \in \text{Primary Output}, \\ & \quad Q_s \geq 0, \quad \forall s \in \text{Primary Input}, \end{aligned}$$

where c_i is the curve fitting coefficient. X_i is the buffer cost of $RT(i)$ and X_{gi} is the gate size of gi . L_i , L_{gi} , U_i and U_{gi} are their lower bounds and upper bounds, respectively.

The objective function is the summation of all buffer/gate costs in the circuit. The timing constraints are interconnect delay and gate delay constraints.

b. Redundant Variables and Constraints Removal

This implementation tip effectively reduces the running time of the linear programming solver. Since the running time increases with the number of variables and constraints, some “redundant” variables and constraints can be removed to speed up the solver time. For example, each gate input corresponds to a sink node of its

upstream root. Once the RAT of its upstream root or the RAT of the gate output is known, the RAT of that gate input can be easily calculated. Under this condition, we can remove all the RAT of gate input by adding the delay of its upstream net and corresponding gate together. According to the approach in [31], the path delay from input b to output p in Figure 19(b) can be represented in the following inequations,

$$Q_b + c_1X_b + c_9 \leq Q_i, \quad (4.6)$$

$$Q_b + c_2X_b + c_{10} \leq Q_i, \quad (4.7)$$

$$Q_e + c_3X_e + c_{11} \leq Q_h, \quad (4.8)$$

$$Q_e + c_4X_e + c_{12} \leq Q_h, \quad (4.9)$$

$$Q_i + c_5X_{g2} + c_{13} \leq Q_m, \quad (4.10)$$

$$Q_h + c_6X_{g2} + c_{14} \leq Q_m, \quad (4.11)$$

$$Q_m + c_7X_m + c_{15} \leq Q_p, \quad (4.12)$$

$$Q_m + c_8X_m + c_{16} \leq Q_p. \quad (4.13)$$

With the tip, the delay formulation is rewrote as follows:

$$Q_b + c_1X_b + c_9 + c_5X_{g2} + c_{13} \leq Q_m, \quad (4.14)$$

$$Q_b + c_2X_b + c_{10} + c_5X_{g2} + c_{13} \leq Q_m, \quad (4.15)$$

$$Q_e + c_3X_e + c_{11} + c_6X_{g2} + c_{14} \leq Q_m, \quad (4.16)$$

$$Q_e + c_4X_e + c_{12} + c_6X_{g2} + c_{14} \leq Q_m, \quad (4.17)$$

$$Q_m + c_7X_m + c_{15} \leq Q_p, \quad (4.18)$$

$$Q_m + c_8X_m + c_{16} \leq Q_p, \quad (4.19)$$

where Q_h and Q_i are removed from the expression, and the number of constraints decreases as well. In our implementation, only one tree and one gate are combined,

which reduces about 40% linear programming solver time. Further reduction can be achieved if more trees and gates are combined.

To justify the solutions into practical use, the continuous solution after linear programming needs to be mapped to discretized buffer library and gate library. Nearest rounding is adopted in this thesis. The circuit with discretized solution only provides insignificant delay overhead compared with the circuit with continuous solution.

5. Considering Slew and Buffer Congestion

As prevailing constraints, both slew constraint and buffer congestion can be incorporated in the flow.

In van Ginneken-Lillis' algorithm, slew rate can be included as a fourth tuple along with RAT, total buffer cost and downstream capacitance. Once the solutions violate the slew constraint, they are pruned. A fast slew buffering algorithm, which is proposed in our previous work [35], is adopted. It assumes a fixed input slew which allows us to process large volume of nets quickly with small solution degradation. Refer to [35] for the further details.

In linear programming formulation, congestion constraints can be included. In congestion region k , let $\text{Congestion}(k)$ denote the maximum number of buffers can be inserted in region k , and n denote the number of trees through that region. The following constraint for region k can be added in the linear programming formulation.

$$\sum_{i=1}^n X_i * \left(\frac{\text{wire length of Tree } i \text{ in region } k}{\text{total wire length of Tree } i} \right) \leq \text{Congestion}(k).$$

The formulation takes probabilistic approach assuming that the buffer location on each routing tree follows uniform distribution. Thus, the number of buffers in region k is proportional to the ratio of the wire length in region k and the total wire

length.

D. Experimental Results

The new algorithm is implemented in C++ and the codes of [27] is borrowed from the authors. All the experiments are run on a Linux machine with 2.8GHz processor and 4GB RAM. The test cases are ISCAS85 circuits, and the sizes are shown in Table VI, where “# edge” denotes the number of edges in the circuit and “# B candidate” denotes the number of candidate buffer locations in the circuit. The interconnect length, resistance and capacitance data of 180nm for the test cases are obtained from [36]. In order to emulate the latest technology, we scale the interconnect by a constant factor. The buffer and gate library contains four buffer and gate types, which are 1X, 2X, 3X and 4X the minimum buffer and gate size. Buffer/gate cost represents the ratio of total buffer/gate area with respect to the minimum buffer/gate area.

For convenience, the algorithms in comparison are listed below together with their abbreviations.

- Path Based: path based buffer insertion and gate sizing algorithm [27].
- Circuit-wise: new circuit-wise simultaneous buffer insertion and gate sizing algorithm.

1. Comparison between Path Based and Circuit-wise Algorithms

In this section, we compare the results between Path Based algorithm and new Circuit-wise algorithm. The results on ISCAS85 benchmark circuits are summarized on Table VII. “Delay” denotes the delay of static timing analysis after buffer insertion and gate sizing. “VGL” denotes the van Ginneken-Lillis’ algorithm time on

Table VI. Summary of ISCAS placed and routed circuits.

Circuit	Circuit Size		
	# gate	# edge	# Buffer Positions
c432	160	343	1015
c499	202	440	1413
c880	383	755	1944
c1355	546	1096	2377
c1908	880	1523	4647
c2670	1193	2292	7982
c3540	1669	2961	8971
c5315	2307	4509	13427
c6288	2416	4832	13042
c7552	3512	6253	19291

all routing trees. “LP” denotes the linear programming solver time. “CPU” denotes the total time of the algorithm, which is “VGL”+“LP”. “Total Red.” denotes the total cost reduction compared with Path Based algorithm.

From Table VII, we have the following observations:

- Compared with Path Based algorithm, the new Circuit-wise algorithm has on average 17.4X speedup, which demonstrates the efficiency of our algorithm. Meanwhile, the speedup ratio of these two algorithms increases from 1.5X to 19.6X as the gate size increases.
- In Path Based algorithm, the CPU time ratio of the largest size circuit and

Table VII. Comparison of path based algorithm and new circuit-wise algorithm.

circuit	Path Based [27]			Circuit-wise						
	Total cost	Delay (ps)	CPU (s)	Total cost	Total Red.	Delay (ps)	VGL (s)	LP (s)	CPU (s)	Speed-up
c432	360	450	0.6	344	4.4%	446	0.2	0.2	0.4	1.5X
c499	460	400	1.2	459	0.2%	392	0.2	0.2	0.4	3.0X
c880	796	360	1.9	842	-5.7%	352	0.4	0.3	0.7	2.7X
c1355	1261	505	6.4	1128	10.5%	497	0.5	0.5	1.0	6.4X
c1908	1740	687	15.5	1787	-2.7%	679	0.6	0.6	1.2	12.9X
c2670	2402	1015	38.2	2190	8.8%	1007	1.0	1.2	2.2	17.4X
c3540	3174	1132	54.9	2774	12.6%	1124	1.6	2.5	4.1	13.4X
c5315	4647	1345	124.2	4408	5.1%	1337	2.9	3.7	6.6	18.8X
c6288	6150	3645	182.7	5830	5.2%	3635	3.2	6.3	9.5	19.2X
c7552	6568	2040	251.2	6233	5.1%	2031	3.7	9.1	12.8	19.6X
Total	27558	-	676.8	25968	5.8%	-	14.3	24.6	38.9	17.4X

the smallest size circuit is 418.7, while in the new Circuit-wise algorithm, the ratio is 32.0. The result implies that our algorithm is efficient in handling large circuits.

- Compared with Path Based algorithm, the new algorithm saves on average 5.8% total cost. In the meantime, the circuit in the new algorithm has less Elmore delay. The result demonstrates that the new Circuit-wise algorithm provides a better buffer/gate resources distribution in the circuit.

In existing literatures, [29] reports the most promising results on circuit-wise buffer insertion, which spends around 260s on all ISCAS85 circuits. Although the new algorithm handles both buffer insertion and gate sizing, it still has 6.7X speedup over [29].

2. The Effect of the Partition Technique

In this section, we compare buffer/gate cost, LP time and circuit Elmore delay between Circuit-wise without and with the partition technique. In the circuit partition, the circuit is partitioned into two parts: one is the downstream cone of the most critical primary input, the other one is the remaining circuit. Note that the VGL time of Circuit-wise without and with the partition technique are the same since van Ginneken-Lillis' algorithm is performed on each routing tree. The results on IS-CAS85 benchmark circuits are summarized on Table VIII. From Table VIII, we have the following observations:

- With the circuit partition technique, the LP speedup is on average 37.8%. Due to the near quadratic relationship between LP time and the number of gates, it makes sense to achieve the speedup if the divide-and-conquer scheme is applied.
- Circuit-wise with partition uses 0.4% less cost than Circuit-wise without partition. In the meantime, it only has on average 2.3% delay overhead. This demonstrates that the circuit partition technique effectively speeds up the algorithm with insignificant cost.

The circuit partition technique is optional for circuits with less than ten thousand gates, since these circuits can be solved as a whole in linear programming solver within reasonably short time and without any partition error.

3. Testcase with Million Plus Gates

The Circuit-wise algorithm with partition is highly scalable to handle large circuits. In order to show this, our algorithm is tested on a testcase with million plus gates. The algorithm selects 150 the most critical primary inputs, and considers their downstream cones as sub-circuits. Then, the algorithm partitions the remaining circuit

Table VIII. The effect of the partition technique.

	Circuit-wise without Partition			Circuit-wise with Partition		
	Total Cost	LP (s)	Delay (ps)	Total Cost	LP (s)	Delay (ps)
c432	344	0.2	446	343	0.2	448
c499	459	0.2	392	444	0.2	404
c880	842	0.4	352	833	0.2	364
c1355	1128	0.5	497	1123	0.3	516
c1908	1787	0.6	679	1778	0.4	688
c2670	2190	1.2	1007	2176	0.5	1040
c3540	2774	2.5	1124	2732	0.8	1182
c5315	4408	3.7	1337	4385	3.1	1363
c6288	5830	6.3	3635	5807	3.6	3722
c7552	6233	9.1	2031	6231	6.0	2034
Total	25968	24.6	-	25852	15.7	-

into another 150 sub-circuits. In our case, the remaining circuit is already disjointed as 150 parts. The million plus gates testcase is partitioned into 300 sub-circuits in total.

The VGL time for the million plus gates is 1221 seconds, and the LP time for the all sub-circuits is 4613 seconds. The total buffer and gate cost is 1872280. From the results, one sees that the testcase is handled in less than 2 hours, which demonstrates the scalability of our algorithm.

CHAPTER V

CONCLUSION AND FUTURE WORK

A. Conclusion

We present several algorithms in buffer insertion for inductance effects, spacing constraints and power management. The first work considers inductance effects to meet the demand of accurate timing optimization in high frequency digital circuits. Experiments on industrial netlists show that buffer insertion considering inductance effects can save up to 33.4% of the resources while giving more accurate timing.

The second work proposes redundant via insertion technique to reduce signal distortions. In addition, a buffer insertion technique is proposed to handle signal synchronization in TDL design. Our experimental results demonstrate that under a realistic setup, a 6GHz signal can be transmitted with high fidelity using our new approaches. In contrast, only a 100MHz signal can be reliably transmitted using a single-end bus structure.

The third work proposes a scalable buffer insertion and gate sizing algorithm to handle million plus gates. The core of the new algorithm is to model nonlinear buffer/gate delay cost tradeoff into linear curves. Thus, the timing constraint buffer/gate cost minimization problem is formulated into a linear programming problem. Experimental results demonstrate that the new circuit-wise algorithm achieves on average 17.4X speedup compared with the path based algorithm. With the novel circuit partition technique, a testcase with million plus gates is handled in less than 2 hours.

B. Future Work

The inductance effects on routing can be explored further. Since inductance effects have significant impact on the delay in global metal layer, in the step of clock routing, inductance effects need to be considered. For the inductance delay model, several other delay models like moment matching have not explored yet, which is also a good direction to study inductance effects on circuit analysis and optimization.

About the circuit-wise buffer insertion and gate sizing, the practical slew constraints and buffer congestion constraints can be incorporated into the flow. In van Ginneken-Lillis' algorithm, slew rate can be included as a fourth tuple along with RAT, total buffer cost and downstream capacitance. Once the solutions violate the slew constraint, they are pruned. About buffer congestion, a probabilistic approach assuming that the buffer location on each routing tree follows uniform distribution can be adopted to avoid the congestion problem in the circuit.

REFERENCES

- [1] L.P.P.P. van Ginneken, “Buffer placement in distributed RC-tree networks for minimal Elmore delay,” in *Proceedings of International Symposium on Circuits and Systems*, Chicago, Illinois, 1990, pp. 865–868.
- [2] W.C. Elmore, “The transient response of damped linear networks with particular regard to wideband amplifiers,” *Journal of Applied Physics*, vol. 19, no. 1, pp. 55–63, 1948.
- [3] P. Saxena and N. Menezes and P. Cocchini and D.A. Kirkpatrick, “Repeater scaling and its impact on CAD,” *IEEE Transactions on Computer-Aided Design*, vol. 23, no. 4, pp. 451–463, 2004.
- [4] P.J. Osler, “Placement driven synthesis case studies on two sets of two chips: hierarchical and flat,” in *Proceedings of International Symposium on Physical Design*, San Diego, California, 2004, pp. 190–197.
- [5] J. Lillis and C.-K. Cheng and T.-T.Y. Lin, “Optimal wire sizing and buffer insertion for low power and a generalized delay model,” *Journal of Solid State Circuits*, vol. 31, no. 3, pp. 437–447, 1996.
- [6] Y.I. Ismail and E.G. Friedman, “Effects of inductance on the propagation delay and repeater insertion in VLSI circuits,” in *Proceedings of the Conference on Design Automation*, New Orleans, Louisiana, 1999, pp. 721–724.
- [7] Y.I. Ismail, E.G. Friedman, and J.L. Neves, “Repeater insertion in tree structured inductive interconnect,” in *Proceedings of the International Conference on Computer-Aided Design*, San Jose, California, 2001, pp. 420–424.

- [8] Z. Jiang, S. Hu, J. Hu, Z. Li, and W. Shi, "A new RLC buffer insertion algorithm," in *Proceedings of the International Conference on Computer-Aided Design*, San Jose, California, 2006, pp. 553–557.
- [9] C.J. Alpert, A. Devgan, and S.T. Quay, "Buffer insertion with accurate gate and interconnect delay computation," in *Proceedings of the Conference on Design Automation*, New Orleans, Louisiana, 1999, pp. 479–484.
- [10] K. Gala, V. Zolotov, R. Panda, B. Young, J. Wang, and D. Blaauw, "On-Chip inductance modeling and analysis," in *Proceedings of the Conference on Design Automation*, Los Angeles, California, 2000, pp. 63–68.
- [11] K. Narbos and J. White, "FastCap: A multipole accelerated 3D capacitance extraction program," *IEEE Transactions on Computer-Aided Design*, vol. 10, no. 11, pp. 1447–1459, 1991.
- [12] M. Kamon and M.J. Ttsuk and J.K. White, "FASTHENRY: A multipole accelerated 3-D inductance extraction program," *IEEE Transactions on Microwave Theory and Techniques*, vol. 42, no. 9, pp. 1750–1758, 1994.
- [13] "Metal oxide semiconductor implementation service," <http://www.mosis.com>, December 2005.
- [14] Y.I. Ismail, E.G. Friedman, and J.L. Neves, "Equivalent Elmore delay for RLC trees," in *Proceedings of the Conference on Design Automation*, New Orleans, Louisiana, 1999, pp. 715–720.
- [15] Y.I. Ismail and E.G. Friedman, "Optimal repeater insertion based on a CMOS delay model for On-Chip RLC interconnect," in *Proceedings of the IEEE ASIC Conference*, Rochester, New York, 1998, pp. 369–373.

- [16] Y. Massoud, S. Majors, T. Bustami, and J. White, "Layout techniques for minimizing on-chip interconnect self inductance," in *Proceedings of the Conference on Design Automation*, San Francisco, California, 1998, pp. 566–571.
- [17] Y. Massoud, J. Kawa, D. MacMillen, and J. White, "Modeling and analysis of differential signaling for minimizing inductive cross-talk," in *Proceedings of the Conference on Design Automation*, Las Vegas, Nevada, 2001, pp. 804–809.
- [18] S.P. Khatri, A. Mehrotra, R.K. Brayton, A.S. Vincentelli, and R.J.M. Otten, "A novel vlsi layout fabric for deep sub-micron applications," in *Proceedings of the Conference on Design Automation*, New Orleans, Louisiana, 1999, pp. 491–496.
- [19] G. Zhong, K. Roy, and C. Koh, "A twisted-bundle layout structure for minimizing inductive coupling noise," in *Proceedings of the International Conference on Computer-Aided Design*, San Jose, California, 2000, pp. 406–411.
- [20] H.H. Chen and D.D. Ling, "Power supply noise analysis methodology for deep-submicron vlsi chip design," in *Proceedings of the Conference on Design Automation*, Anaheim, California, 1997, pp. 638–643.
- [21] S. Wong, T. Lee, D. Ma, and C. Chao, "An empirical three-dimensional crossover capacitance model for multilevel interconnect vlsi circuits," *IEEE Transactions on Semiconductor Manufacturing*, vol. 13, no. 2, pp. 219–227, 2000.
- [22] G. K. Reeves, A. S. Holland, and P. Leech, "Influence of via liner properties on the current density and resistance of vias," in *International Conference on Microelectronics*, Nis, Yugoslavia, 2002, pp. 535–538.
- [23] G.A. Allan and A.J. Walto, "Automated redundant via placement for increased yield and reliability," *Sicitation Digital Library*, vol. 3216, no. 1, pp. 114–125, 1997.

- [24] G. Xu, L.-D. Huang, D.Z. Pan, and M.D.F. Wong, “Redundant-via enhanced maze routing for yield improvement,” in *Proceedings of the Conference on Asia South Pacific Design Automation*, Shanghai, China, 2005, pp. 1148–1151.
- [25] C.J. Alpert, A. Devgan, and S.T. Quay, “Buffer insertion for noise and delay optimization,” in *Proceedings of the Conference on Design Automation*, San Francisco, California, 1998, pp. 362–367.
- [26] I.-M. Liu, A. Aziz, D.F. Wong, and H. Zhou, “An efficient buffer insertion algorithm for large networks based on lagrangian relaxation,” in *Proceedings of International Conference on Computer Design*, Austin, Texas, 1999, pp. 210–215.
- [27] C.N. Sze and C.J. Alpert and J. Hu and W. Shi, “Path based buffer insertion,” in *Proceedings of the Conference on Design Automation*, San Diego, California, 2005, pp. 509–514.
- [28] R. Chen and H. Zhou, “Efficient algorithms for buffer insertion in general circuits based on network flow,” in *Proceedings of the International Conference on Computer-Aided Design*, San Jose, California, 2005, pp. 322–326.
- [29] M. Waghmode, Z. Li, and W. Shi, “Buffer insertion in large circuits with constructive solution search techniques,” in *Proceedings of the Conference on Design Automation*, San Francisco, California, 2006, pp. 296–301.
- [30] W. Shi and Z. Li, “An $O(n \log n)$ time algorithm for optimal buffer insertion,” in *Proceedings of the Conference on Design Automation*, Anaheim, California, 2003, pp. 580–585.
- [31] J.P. Fishburn and A.E. Dunlop, “TILOS: A posynomial programming approach to transistor sizing,” in *Proceedings of the International Conference on Computer-Aided Design*, Santa Clara, California, 1985, pp. 326–328.

- [32] S.S. Sapatnekar, V.B. Rae, P.M. Vaidya, and S.M. Kang, “An exact solution to the transistor sizing problem for CMOS circuits using convex optimization,” *IEEE Transactions on Computer-Aided Design*, vol. 12, no. 11, pp. 1621–1634, 1993.
- [33] C.-P. Chin, C.C.N. Chu and D.F. Wong, “Fast and exact simultaneous gate and wire sizing by lagrangian relaxation,” in *Proceedings of the International Conference on Computer-Aided Design*, San Jose, California, 1998, pp. 617–624.
- [34] C.J. Alpert, J. Hu, S.S. Sapatnekar and C.N. Sze, “Accurate estimation of global buffer delay within a floorplan,” in *Proceedings of the International Conference on Computer-Aided Design*, San Jose, California, 2004, pp. 706–711.
- [35] S. Hu, C.J. Alpert, J. Hu, S. Karandikar, Z. Li, W. Shi, and C.-N. Sze, “Fast algorithms for slew constrained minimum cost buffering,” in *Proceedings of the Conference on Design Automation*, San Francisco, California, 2006, vol. 308-313.
- [36] X. Lu and W. Shi, “Layout and parasitic information for iscas circuits,” <http://dropzone.tamu.edu/.xiang/iscas.html>, December 2006.

VITA

Zhanyuan Jiang received the Bachelor of Science degree from Electrical Engineering department in Shanghai Jiao Tong University, Shanghai, China in 2005. In August 2005, he started to study towards his Master of Science degree in the Computer Engineering group, Texas A&M University, College Station, TX. His research interests focus on designing and implementing the algorithms in physical synthesis flow, especially buffer insertion and gate sizing. His interests also include global bus design.

The typist for this thesis was Zhanyuan Jiang.