

**REGULATION OF *Xylella fastidiosa* VIRULENCE FACTORS
BY C-DI-GMP PHOSPHODIESTERASES**

A Dissertation

by

VERONICA ANCONA-CONTRERAS

Submitted to the Office of Graduate Studies of
Texas A&M University
in partial fulfillment of the requirements for the degree of

DOCTOR OF PHILOSOPHY

August 2011

Major Subject: Plant Pathology

REGULATION OF *Xylella fastidiosa* VIRULENCE FACTORS

BY C-DI-GMP PHOSPHODIESTERASES

A Dissertation

by

VERONICA ANCONA-CONTRERAS

Submitted to the Office of Graduate Studies of
Texas A&M University
in partial fulfillment of the requirements for the degree of

DOCTOR OF PHILOSOPHY

Approved by:

Chair of Committee,	Paul de Figueiredo
Committee Members,	Dennis C. Gross
	David N. Appel
	Jean H. Gould
Head of Department,	Leland S. Pierson III

August 2011

Major Subject: Plant Pathology

ABSTRACT

Regulation of *Xylella fastidiosa* Virulence Factors by
c-di-GMP Phosphodiesterases. (August 2011)

Veronica Ancona-Contreras, B.S., Universidad Autonoma de Nuevo Leon;

M.S., Texas A&M University-Kingsville

Chair of Advisory Committee: Dr. Paul de Figueiredo

Xylella fastidiosa is an important bacterial plant pathogen that colonizes the xylem of hundreds of plant species. *X. fastidiosa* cause Pierce's disease in grapevine by occlusion of the xylem by extensive bacterial colonization, extracellular polysaccharides and the formation of a biofilm. These traits are mediated in a cell-density manner by a cell-to-cell signaling system that transduces a diffusible signaling factor (DSF). This dissertation demonstrates that PD1994, PD1617 and RpfG regulate important traits for bacterial virulence such as cell-cell signaling, biofilm formation and cell aggregation. *X. fastidiosa* strains harboring mutations in *pd1994* (which encodes for a defective GGDEF- EAL-domain protein) and in *pd1617* (which encodes for a EAL-domain protein) have increased growth rate, increased biofilm formation, increased plant colonization and decreased cell aggregation. Gene expression analysis of the *pd1994* mutant strain showed overexpression of *rpfF*, which is a DSF synthase, suggesting that PD1994 regulates DSF signaling by repressing *rpfF* expression. Additionally, the *pd1994*mutant showed overexpression of *pd1617* and *rpfG* (with EAL and HD-GYP

domains respectively, that may be responsible for c-di-GMP turnover), which suggested that this mutant may have low c-di-GMP levels and that PD1994 regulates c-di-GMP turnover by repression of RpfG activity and PD1617 gene expression. *X. fastidiosa* harboring a mutation on *rpfG* exhibited decreased biofilm formation while it had no effect in growth or cell aggregation. Together, these results suggest that PD1994, PD1617 and RpfG regulate the DSF regulatory network by controlling the turnover of the second messenger c-di-GMP.

DEDICATION

To Jorge

ACKNOWLEDGEMENTS

I would like to thank my committee chair Dr. Paul de Figueiredo for giving me the opportunity to work and learn from him and for his patience during the development of this project. I would also like to thank my committee members Dr. Appel, Dr. Gould and Dr. Gross for their support throughout the course of journey.

I would like to thank my current and former fellow lab members, Dr. Qingming Qin, Dr. Lei Li, Dr. Shiping Wei, Cassandra Carrizales, Marshall Frerichs, Carson Sibley, Katy Van Note, Kyle Schmucker, Jillian Blackwell, Charley Gruber, Clayton Knight, for their friendship and company during the long days we spent together.

Thanks to all my friends, Frankie, Julie, Jessica, Sonia, Martha, Angela, Poulami, Carlos, Eugenia, Walter, Barbara, Stephen, Iris, Veria, Shuga, Cruz, Julia, David, fellow graduate students, Departmental faculty and staff for making my stay at Texas A&M University a memorable experience.

Special thanks to my husband, Jorge Solorzano for his love, comprehension and unconditional support throughout my graduate studies.

Finally, I want to thank my family for encouraging me to be better every day, but above all for believing in me.

TABLE OF CONTENTS

	Page
ABSTRACT	iii
DEDICATION	v
ACKNOWLEDGEMENTS	vi
TABLE OF CONTENTS	vii
LIST OF FIGURES	viii
LIST OF TABLES	ix
 CHAPTER	
I INTRODUCTION	1
II C-DI-GMP PHOSPHODIESTERASES CONTRIBUTE IN REGULATION OF CELL-CELL AGGREGATION, BIOFILM FORMATION AND GENE EXPRESSION IN <i>X. fastidiosa</i>	9
Introduction	9
Materials and Methods	14
Results	19
Discussion	31
III CONCLUSIONS	36
REFERENCES	38
VITA	44

LIST OF FIGURES

FIGURE	Page
1.1 Schematic representation of c-di-GMP signaling module	6
2.1 Schematic representation of <i>X. fastidiosa</i> putative c-di-GMP phosphodiesterases	13
2.2 Construction of <i>X. fastidiosa</i> $\Delta pd1617$ mutant strain.....	21
2.3 Southern blot of <i>X. fastidiosa</i> DNA from wild type and mutant strains ...	22
2.4 Growth curve of <i>X. fastidiosa</i> WT and mutant strains.....	24
2.5 Cell-cell aggregation assay of <i>X. fastidiosa</i> WT, $\Delta PD1994$, $\Delta PD1617$, $\Delta PD1671$, $\Delta cgsA$ and $\Delta rpfG$ strains	25
2.6 Biofilm formation assay of <i>X. fastidiosa</i> WT, $\Delta PD1994$, $\Delta PD1617$, $\Delta PD1671$, $\Delta cgsA$ and $\Delta rpfG$ strains	26

LIST OF TABLES

TABLE	Page
2.1 Bacterial strains and plasmids	16
2.2 Bacterial colonization assay in grapevines.....	27
2.3 Quantitative real-time PCR analysis of expression of RpfC/RpfG two-component system genes as influenced by <i>ΔrpfG</i> , <i>Δpd1994</i> , <i>ΔPD1617</i> , <i>ΔPD1671</i> and <i>ΔcgsA</i>	28
2.4 Quantitative real-time PCR analysis of expression of genes involved in biofilm formation, cell-cell aggregation and motility in grapevine in response to <i>ΔrpfG</i> , <i>Δpd1994</i> , <i>Δpd1617</i> , <i>Δpd1671</i> and <i>ΔcgsA</i> mutations ..	30
2.5 Quantitative real-time PCR analysis of expression of putative diguanylate cyclase and c-di-GMP phosphodiesterases in response to <i>ΔrpfG</i> , <i>Δpd1994</i> , <i>Δpd1617</i> , <i>Δpd1671</i> and <i>ΔcgsA</i> mutations	31

CHAPTER I

INTRODUCTION

Xylella fastidiosa is a rod shaped, non-flagellated, Gram-negative bacterium which colonizes the xylem of hundreds of plant species (26). *X. fastidiosa* strains are recognized as being responsible for dozens of plant diseases in the Americas, including phony peach disease (*X. fastidiosa* subsp. *multiplex*) (27), citrus variegated chlorosis (*X. fastidiosa* subsp. *pauca*) (30) and the notorious Pierce's Disease (*X. fastidiosa* subsp. *fastidiosa*) of grapevine (27), which poses a grave threat to the U.S. grape and wine industries (26, 27, 39).

Sap-feeding insect vectors, including many species of leafhoppers and spittlebugs, are responsible for the transmission and spread of *X. fastidiosa* (38). The bacterium is acquired by insects when they feed on infected grapevines, becoming immediately infective since there is no latent period required for transmission (38). Because *X. fastidiosa* attaches and multiplies in the mouthparts (foregut) of the vectors, nymphs will lose the pathogen when they molt, but adult insects will remain infective for life (1, 38). Although these characteristics are general for all vectors, they differ in their transmission efficiencies (39). For example, the glassy winged sharpshooter (*Homalodisca vitripennis*) was introduced into southern California relatively recently (1989) (51), and due to its ability to transmit *X. fastidiosa* very efficiently, Pierce's

This dissertation follows the style of Journal of Bacteriology.

disease has become an important agricultural problem with epidemic proportions in this region (1, 39).

Pierce's disease causes leaf scorching, leaf abscission, and depending on cultivar susceptibility, plant death within a few years (26). These symptoms have been associated with water stress due to occlusion of the plant's xylem by extensive bacterial colonization, extracellular polysaccharide production, biofilm formation and cell aggregation (8, 26, 27). However, some researchers suggest that secreted proteins and outer membrane components of *X. fastidiosa* are responsible for symptom development in grapevines and not water stress (6, 40). Additional studies have also found that there is no correlation between pathogen population and symptom development, which suggests that xylem blockage is not necessary for disease to occur (18). Nevertheless, the formation of a biofilm is important for plant colonization and lifetime infectivity of insect vectors (38).

The process of biofilm development has been divided into five sequential stages: (i) reversible cell attachment to a surface; (ii) irreversible attachment; (iii) maturation onset; (iv) mature biofilm; and, (v) biofilm dispersion (46). *X. fastidiosa* attachment to host surfaces is promoted by type I pili (or short pili) (36). A *fimA* mutant, which lacks type I pili, exhibits decreased attachment, decreased biofilm formation, and increased translocation in grapevines (36). In contrast, genetic mutations of type IV pili (or long pili) precursors exhibit the opposite phenotypes, through increased adhesion to surfaces, increased biofilm formation and decreased translocation in grapevines (13, 36). The ability of *X. fastidiosa* to migrate away from the point of inoculation to spread

throughout the plant is important for virulence (19). In this case, type IV pili play an important role since they are required for pathogen dissemination through means of twitching motility (36).

Afimbrial adhesins (HxfA and HxfB) are hemagglutinin-like proteins that attenuate *X. fastidiosa* virulence by contributing to biofilm maturation within xylem vessels (19). *X. fastidiosa* harboring mutations on *hxfA* and *hxfB* genes are impaired in cell-to-cell aggregation *in vitro* and exhibit increased virulence *in planta*. These bacterial cells were still able to attach to the xylem, but formed a single monolayer on it, suggesting that afimbrial adhesins are not involved in initial surface attachment but in cell aggregation, an important contributor to biofilm maturation in *X. fastidiosa* (19). Type I and type IV pili also influence cell aggregation *in vitro* (12). Together these studies suggest that the ability of *X. fastidiosa* to form cell aggregates *in vitro* is related to the capability of the pathogen to form a mature biofilm within xylem vessels.

Other pathogenicity factors that promote virulence in *X. fastidiosa* include cell wall degrading enzymes such as glucanases, xylanases and polygalacturonases (41). The *X. fastidiosa* genome encodes one polygalacturonase (*pglA*). This enzyme contributes to degrading the pit membranes that separate xylem vessels, which aids *X. fastidiosa*'s systemic colonization of grapevines and virulence (41). Expression of *pglA* is repressed at high cell density, restricting bacterial movement through the plant (8), contrary to *fimA*, *hxfA* and *hxfB* that are up-regulated to promote biofilm formation (10). Therefore the regulatory networks that control the interplay of type I and type IV pili,

afimbrial adhesins, and cell wall degrading enzymes are induced in a population density manner (10).

Bacterial cell-to-cell communication systems, often referred to as quorum sensing, allow bacteria to assess their population density by the use of small diffusible signals (7, 55). These systems allow bacteria to coordinate the expression of certain traits only when a population density has been reached. For bacterial pathogens, this communication aids in synchronizing the expression of virulence factors giving advantage in colonizing their host (55). Quorum sensing involves the diffusion of low molecular weight signals that accumulate as the bacterial population increases (7). When the signal reaches a threshold it activates receptor proteins that trigger signaling cascades to change gene expression (55).

Studies of the plant pathogen *Xanthomonas campestris* pv. *campestris* (*Xcc*) indicate that quorum sensing plays a critical role in mediating the synthesis of virulence factors by transduction of *Xcc* Diffusible Signal Factor (DSF) (23). The sensor protein RpfC of a two-component system recognizes DSF and triggers a cascade of phosphorylation events resulting in the activation of RpfG (16, 17). RpfG is a response regulator that contains an HD-GYP domain that recent studies have demonstrated to degrade the second messenger cyclic diguanylate (c-di-GMP) (44). This signaling network leads to motility and activation of virulence factors (17).

Cyclic di-GMP is a bacterial second messenger that regulates diverse behaviors in several Gram-negative bacteria, including biofilm formation, motility, cell-cell aggregation and expression of virulence factors in pathogenic species (53). This

signaling molecule was discovered in 1987 by Benziman et al. (42) as a cellulose synthase activator in the bacterium *Gluconacetobacter xylinus*. In a subsequent study (52) they described genes that synthesized and hydrolyzed c-di-GMP in *G. xylinus*. Diguanilate cyclase activity (DGC) resides in the GGDEF (Gly-Gly-Asp-Glu-Phe) domain of these proteins, while phosphodiesterase (PDE) activity resides in proteins containing EAL (Glu-Ala-Leu) (52) or HD-GYP (His-Asp, Gly-Tyr-Pro) domains (44).

The ubiquitous presence of GGDEF and EAL domain-containing proteins in bacteria suggests that c-di-GMP signaling modules are conserved in these microorganisms (47). These c-di-GMP signaling modules consist of DGC and PDE enzymes that are activated in response to environmental or cellular signals to synthesize and hydrolyze c-di-GMP. The interplay of DGC and PDE proteins affects the intracellular concentration of c-di-GMP. Depending on c-di-GMP concentrations effector proteins will be allosterically activated or inhibited by direct interaction with the second messenger. Then, a target component will produce a molecular output in response to the activation or inhibition of the effector protein (Fig. 1.1) (24). In many bacteria accumulation of c-di-GMP is associated with increased biofilm formation and inhibition of motility. Therefore, c-di-GMP regulates of the transition between the motile and sessile lifestyles of several bacterial species (53).

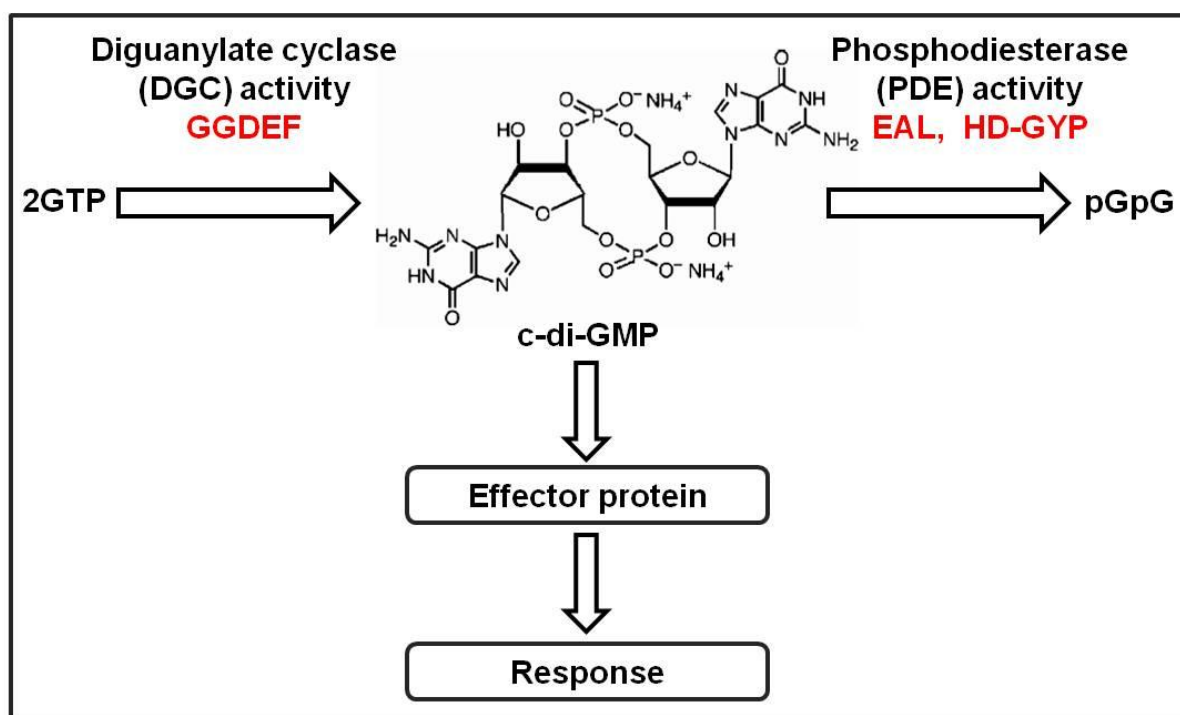

FIG. 1.1. Schematic representation of c-di-GMP signaling module. This molecule is synthesized by diguanylate cyclase enzymes (DGCs) and is hydrolyzed by phosphodiesterases (PDEs). DGC activity resides in the GGDEF-domain and PDE activity in EAL or HD-GYP domains of proteins. Effector proteins are allosterically activated or inhibited by the interaction with c-di-GMP, which in turn produces a response.

Recent studies have described a RpfC/RpfG two-component system mediated by a DSF molecule produced by *X. fastidiosa* (49). Although this molecule is structurally similar to *Xcc* DSF, the regulation of virulence (and virulence factor synthesis) by this system differ between these bacterial species (16). For instance, a mutation on *Xcc*'s *rpfF* gene (DSF synthase) leads to reduced production of exopolysaccharides and extracellular enzymes, reducing *Xcc* virulence. However, mutations in the *rpfF* gene of *X. fastidiosa* increase grapevine colonization and virulence (10). This same mutation causes the overexpression of a GGDEF-domain containing protein (PD0279), which

suggests that c-di-GMP is dependent on DSF signaling and its over expression could be responsible for the corresponding *X. fastidiosa* hypervirulent phenotype that is observed in the *rpfF* mutant strain (8). A new report from Chatterjee et al. (9) in which this GGDEF-domain containing protein (CgsA) in *X. fastidiosa* was studied showed that its expression is necessary for virulence in grapevine and insect transmission. These data suggest that DSF accumulation reduces c-di-GMP intracellular levels and leads to the transition from motile to sessile growth of the pathogen (9).

An analysis of the *X. fastidiosa* genome revealed the presence of five genes that are predicted to encode proteins containing the conserved GGDEF, EAL and/or HD-GYP domains (3). PD1617 and PD1671 contain EAL domains, PD0405 (RpfG) contains an HD-GYP domain, PD1994 contains both GGDEF and EAL domains, and the previously described CgsA contains only a GGDEF domain. Based on this analysis, I hypothesized that the interplay of CgsA with RpfG PD1994, PD1617 and PD1671 regulate the expression of virulence factors in (*X. fastidiosa*) such as biofilm formation, cell aggregation, plant colonization and gene expression. Therefore, the objectives of this dissertation are to (i) introduce mutations on genes encoding EAL, HD-GYP and GGDEF domain-containing proteins in *X. fastidiosa*; (ii) to assess the contribution of these proteins to biofilm formation and cell aggregation by measuring these behaviors in mutant strains; (iii) to determine bacterial translocation in grapevine, and; (iv) to evaluate changes in gene expression of virulence factors in mutant strains.

Dissecting the signaling pathways regulating virulence in *X. fastidiosa* is needed to increase our understanding of Pierce's disease development and for the development

of possible control methods. The genes involved in expression networks as well as signaling molecules are potential targets for manipulating bacterial behaviors such as decreasing bacterial virulence or insect transmission. Control strategies targeting DGC or PDE to change c-di-GMP concentration may provide potential approaches to Pierce's disease management and control.

CHAPTER II
C-DI-GMP PHOSPHODIESTERASES CONTRIBUTE
IN REGULATION OF CELL-CELL AGGREGATION, BIOFILM FORMATION
AND GENE EXPRESSION IN *X. fastidiosa*

INTRODUCTION

Xylella fastidiosa is an important bacterial plant pathogen that has been recognized as the causal agent of several plant diseases including citrus variegated chlorosis, phony peach disease and Pierce's disease of grapevine (26, 27). *X. fastidiosa* is a xylem limited plant pathogen that is transmitted by insect vectors (26, 39). The characteristic disease symptoms of Pierce's disease include leaf scorching, leaf abscission, uneven maturation of canes (often referred as green islands), and plant death within a few years of infection (26). These symptoms are associated with water stress caused by blockage of xylem vessels by a bacterial biofilm composed of extensive bacterial colonization, extracellular polysaccharide (EPS) and plant's gums and tyloses (26). Several studies in *X. fastidiosa* support the hypothesis that virulence is related to the ability of the pathogen to migrate away from the biofilm to colonize new xylem vessels (19, 26, 41). Therefore, understanding the regulatory networks controlling motility and biofilm dispersal in *X. fastidiosa* could potentially offer alternatives to the control and management of Pierce's disease.

In several plant pathogenic bacteria, biofilm formation, biofilm dispersal, motility, EPS production, and the expression of virulence factors are controlled by cyclic

di-GMP concentration (15, 47, 53). This molecule is synthesized by enzymes possessing diguanylate cyclase activity (DGC) which resides in the GGDEF (Gly-Gly-Asp-Glu-Phe) domain of these proteins. Degradation of c-di-GMP is performed by phosphodiesterases (PDE) containing EAL (Glu-Ala-Leu) (52) or HD-GYP (His-Asp, Gly-Tyr-Pro) domains (44). The interplay of DGC and PDE enzymes alters intracellular concentrations of c-di-GMP which in turn, depending on the species, affects the bacterial behaviors mentioned above (53).

PDE and DGC activities, and hence c-di-GMP concentration, are tightly regulated by different mechanisms (53). Allosteric interactions, phosphorylation, cellular localization, and cell-to-cell communication systems, are some mechanisms by which PDE and DGC enzymes may be regulated (7, 53, 55). Domains that frequently appear in combination with GGDEF, EAL and HD-GYP-domain proteins include REC, PAS, PAC, and transmembrane domains among others (2, 4, 21, 44). These domains may sense a wide variety of environmental and intracellular signals and regulate the PDE and DGC activity of these proteins (53). For example, *Xanthomonas campestris* pv. *campestris*, a pathogen of crucifers, utilizes a two component communication system to detect a diffusible signal factor (DSF) that regulates xanthan production, biofilm dispersal and virulence (23). These virulence factors are regulated by the *rpf* (regulation of pathogenicity factors) regulon, where *rpfF* encodes a DSF synthase (5), *rpfC* encodes a histidine-kinase sensor and *rpfG* a response regulator (14). Together, these proteins form the RpfC/RpfG two-component system that recognize and transduce the DSF signal (14, 44). When DSF accumulates in the environment and reaches a threshold it is

recognized by the RpfC sensor, that in turn activates RpfG by phosphorylation of its receiver domain REC (43). Phosphorylation of the REC domain of RpfG activates the HD-GYP domain also present in this protein, which recent studies have demonstrated that hydrolyses the second messenger c-di-GMP (44). Changes of c-di-GMP concentration by RpfG plays an important role in transduction of the DSF signal in *X. campestris* pv. *campestris* affecting the expression of virulence factors, EPS production and biofilm dispersal (44).

A similar two-component system has been described for *X. fastidiosa* where an *rpf* operon encodes a cell-to-cell signaling system mediated by DSF accumulation (10, 37). This system regulates EPS production, biofilm formation, insect transmission, enzyme secretion and type IV pili production, all of which are important for *X. fastidiosa* pathogenicity (28, 36, 41). Although this system is predicted to work similarly to the one in *X. campestris* pv. *campestris*, the virulence outcomes controlled by DSF transduction are different. For instance, mutations on *rpfF*, *rpfC* or *rpfG* in *X. campestris* pv. *campestris*, exhibit reduced virulence, and are deficient in extracellular enzyme and EPS production (5, 14, 50). Although, mutation of *rpfC* in *X. fastidiosa* is reduced in virulence (8, 10) the *rpfF* mutant strain, impaired in DSF production, has the opposite phenotype, exhibits enhanced virulence in grape when needle-inoculated (37).

Additional analysis of the *X. fastidiosa* *rpfF* mutant revealed that this mutation causes increased expression of a GGDEF-domain protein (PD0279) (8, 10). Chatterjee et al. (9) recently reported that a mutation of this GGDEF-domain containing protein (CgsA) leads to increased biofilm formation, more EPS production, less virulence in

grapevine and less insect transmissibility, presumably by synthesizing c-di-GMP (9).

This report also finds that mutation of *cgsA* regulates the same traits as DSF, suggesting that c-di-GMP plays a role in transduction of DSF signaling in *X. fastidiosa* (9).

In *Pseudomonas aeruginosa*, a bacterial system where c-di-GMP has been studied extensively (20, 29, 31), DGC and PDE enzymes regulate biofilm formation by promoting exopolysaccharide production (29, 31). The *P. aeruginosa* genome encodes several GGDEF and EAL domain containing proteins, which are also associated with other signal receiving or transmembrane domains, suggesting activation by multiple signals (29). For example, the PDE protein RbdA that regulates biofilm dispersal in *P. aeruginosa* is composed of PAS-PAC-GGDEF-EAL domains (2). This multidomain protein only possesses PDE activity and its GGDEF domain works as an allosteric activator of the EAL domain (2). The PAS domain seems to act as an oxygen sensor and it is required for RbdA activity, which under anaerobic conditions, degrades c-di-GMP promoting biofilm dispersal (2).

Sequence analysis of *X. fastidiosa* genome revealed that this pathogen encodes one diguanylate cyclase (CgsA described above) and four putative c-di-GMP phosphodiesterase enzymes (Fig.2.1) (54). NCBI conserved-domain analysis revealed that these phosphodiesterases contain EAL or HD-GYP domains together with signal receiver domains like REC and PAS (Fig. 2.1). One of these proteins, RpfG (PD0405), contains both REC and HD-GYP domains and shares 76% identity with RpfG from *X. campestris* pv. *campestris*, suggesting that it may be responsible for transduction of *X. fastidiosa* DSF signaling by c-di-GMP hydrolysis (8). Another putative two-component

response regulator is PD1671 which contains an EAL and REC domains (Fig 2.1) (54). Two-component systems can sense and transduce environmental signals different from DSF (22). PD1617 is a conserved hypothetical protein containing an EAL-domain. PD1994 is also a hypothetical protein with GGDEF, EAL and PAS domains. It is relatively common to find EAL and GGDEF domains in the same protein, although usually one of the domains is inactive (53). The PAS domain that has been implicated in sensing environmental signals such as low oxygen conditions (Fig 2.1) (2, 54) .

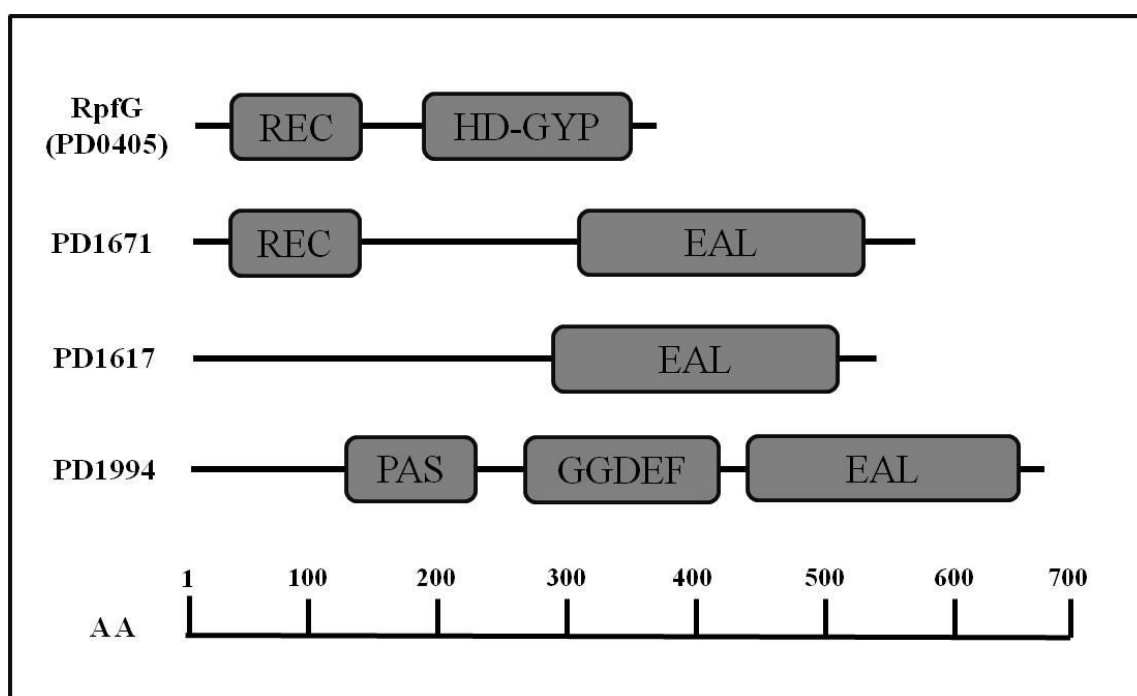

FIG. 2.1. Schematic representation of *X. fastidiosa* putative c-di-GMP phosphodiesterases. RpfG is a 385 amino acid predicted protein with HD-GYP domain and a response regulator receiver domain (REC). PD1671 is a predicted two component response regulator of 567 amino acids containing EAL and REC domains (54). PD1617 and PD1994 are hypothetical proteins of 530 and 690 amino acids respectively, both containing the EAL domain. PD1994 contains additionally a GGDEF domain and a PAS domain which has been described as oxygen level sensor (2). Domain organizations were predicted using the NCBI conserved-domain search (<http://www.ncbi.nlm.nih.gov/Structure/cdd/wrpsb.cgi>). The scale bar represents the length of the proteins in amino acid residues. AA: amino acids.

In this study I made mutations on putative c-di-GMP phosphodiesterases to determine their role in modulating biofilm formation, cell aggregation and grapevine colonization. Additionally, I examined the expression profiles of virulence genes in these mutant strains to assess if their expression was altered. Furthermore, I assessed if these putative phosphodiesterases are related to the transduction of the DSF signal.

MATERIALS AND METHODS

Bioinformatic analysis

Analysis of *X. fastidiosa* genome by BLAST and the NCBI conserved-domain search tools were used to identify four genes encoding putative c-di-GMP phosphodiesterases with EAL and HD-GYP-domains (<http://www.ncbi.nlm.nih.gov/Structure/cdd/wrpsb.cgi>) (Fig. 2.1). The predicted proteins were aligned to the consensus domain sequences to identify the phosphodiesterase active sites. Additionally, a search in the database for prokaryotic operons (DOOR) was performed to check if these genes were predicted to be polycistronic (35).

Bacterial strains and growth conditions

The bacterial strains and plasmids used in this work are listed in Table 2.1. *Escherichia coli* TOP10 (Invitrogen) was used for general cloning cultured in Luria-Bertani (LB) broth or agar medium supplemented with the appropriate antibiotics. *X. fastidiosa* strains were routinely grown at 28°C in PD-3 liquid or agar medium (11). Antibiotics were added accordingly to the following concentrations: Kanamycin 50 µg

mL⁻¹ (Kan50) and Ampicillin 100 µg mL⁻¹ (Amp100). Bacteria were stored in 20% glycerol at -80°C.

Construction of plasmids

The double-joint-polymerase chain reaction (PCR) method (57) was used to construct gene insertion cassette for generation of $\Delta PD1617$ disruption mutant of *X. fastidiosa*. Gene replacement cassettes were constructed for generation of $\Delta rpfG$, $\Delta PD1994$, $\Delta PD1671$, and $\Delta cgsA$ deletion mutants of *X. fastidiosa*. The kanamycin resistant gene was obtained from pBBR1MCS-2. Double-joint PCR products were cloned into a pGEM-T vector (Promega Co., Madison, WI). To confirm that plasmids carried gene replacement and gene disruption cassettes they were sent for sequencing (Table 2.1).

Construction of *X. fastidiosa* mutant strains

X. fastidiosa electrocompetent cells of strain Temecula 1 were prepared as previously described (40). One µg of pGemT vectors carrying gene replacement and gene disruption cassettes were electroporated into the cells utilizing previously described conditions (40). Electroporated cells were suspended in 500 µL of PD3 media without antibiotics and grown overnight without shaking before distributing into five PD3-Kan50 PD3 agar plates. Following 10 days of incubation in PD3-Kan50 agar plates, single colonies were tested by colony PCR for double crossover recombination events. DNA of candidate mutant strains was isolated using the 10% CTAB/NaCl method as previously described (56). Gene replacement was confirmed by Southern blot as previously described (45) utilizing kanamycin and the target gene as probes.

Table 2.1. Bacterial strains and plasmids.

Strain or Plasmid	Relevant genotype description	Source
Strains		
<i>Escherichia coli</i>		
TOP10		Invitrogen ^a
<i>X. fastidiosa</i>		
WT	Wild type	C. Gonzalez ^b
$\Delta PD1994$	PD1994 gene replaced with Kanamycin resistance gene	This study
$\Delta PD1617$	PD1617 gene replaced with Kanamycin resistance gene	This study
$\Delta PD1671$	PD1671 gene replaced with Kanamycin resistance gene	This study
$\Delta cgsA$	PD0279 gene replaced with Kanamycin resistance gene	This study
$\Delta rpfG$	PD0405 gene replaced with Kanamycin resistance gene	This study
Plasmids		
pBBR1MCS-2	Kan ^r ; broad range plasmid	
pGEM-T	Amp ^r ; pUC ori, <i>lacZ</i> cloning vector	Promega ^c
pGT- $\Delta PD1994$	Kan ^r ; pGem-T carrying PD1994 deletion construct	This study
pGT- $\Delta PD1617$	Kan ^r ; pGem-T carrying PD1617 insertion construct	This study
pGT- $\Delta PD1671$	Kan ^r ; pGem-T carrying PD1671 deletion construct	This study
pGT- $\Delta cgsA$	Kan ^r ; pGem-T carrying PD0279 deletion construct	This study
pGT- $\Delta rpfG$	Kan ^r ; pGem-T carrying PD0405 deletion construct	This study

a. Invitrogen, Carlsbad, CA.

b. Carlos Gonzalez. Texas A&M University. Plant Pathology and Microbiology Department. College Station, TX 77843.

c. Promega Co., Madison, WI.

Phenotypic analyses: Growth curves and cell aggregation

The growth of mutant strains was compared with that of wild type *X. fastidiosa*.

Growth rates were determined by growing bacterial strains in glass tubes with 3 ml of

PD3 media and measuring optical density at 600 nm (OD₆₀₀) every day for 6 days.

Initial OD₆₀₀ of bacterial cultures was adjusted to an absorbance of 0.1 nm and incubated on a rotating shaker at 28°C. Because of the aggregative nature of this pathogen, cell cultures were mixed by vortex before measuring cell concentration at OD₆₀₀ (48).

For cell aggregation analysis bacterial cultures were prepared as described for growth rate. To calculate the percentage of aggregated cells the OD₆₀₀ of bacterial cultures was measured immediately after vortex to obtain total OD. Then, cells were incubated 1 hr without shaking to allow cell aggregates to sediment at the bottom of the tube. The OD₆₀₀ of the supernatant in the tube was then measured, and relative percentage of aggregated cells was calculated (32, 48). This procedure was done 6 days after initial incubation. Three independent experiments performed in triplicate were prepared for all the bacterial strains using *X. fastidiosa* wild type and un-inoculated PD3 media as controls. Statistical differences were calculated using Student's t-test.

Biofilm formation

Biofilm formation of *X. fastidiosa* wild type and mutant strains were compared by measuring bacterial surface attachment. *X. fastidiosa* strains were suspended at an initial OD₆₀₀ of 0.1 nm in PD3 media and then 100µL aliquots were distributed into 96 well polystyrene plates. After 6 days incubation at 28°C without agitation, surface attachment was determined by crystal violet staining method as previously described (32). Three independent experiments performed for all the bacterial strains using un-inoculated PD3 media as negative control.

RNA isolation for quantitative RT-PCR (qRT-PCR)

For gene expression analysis of *X. fastidiosa* WT and mutant strains, bacterial cultures were harvested by centrifugation after growing for 3 days in PD3 broth with the appropriate antibiotics. Cell pellets were suspended in Trizol reagents and RNA isolations were performed according to manufacturer's instructions (Invitrogen, Carlsbad, CA). RNA samples were treated with DNase I (Ambion, Austin, TX) to remove any residual DNA according to manufacturer's instructions. RNA concentration was measured using a nanodrop 1000 spectrophotometer (Thermo scientific, Wilmington, DE) and the integrity of RNA samples was assessed by gel electrophoresis. Three independent experiments performed in duplicate were used to collect samples for RNA extraction.

qRT-PCR analysis

To determine the effects of *pd1994*, *pd1617*, *pd1671*, *rpfG* and *cgsA* mutations on the expression of genes involved in c-di-GMP biosynthesis, biofilm formation, virulence and the RpfC/RpfG-two component system, qRT-PCR was performed. Primers specific for *cgsA*, *rpfG*, *PD1994*, *PD1671*, *PD1617*, *rpfF*, *rpfC*, *fimA*, *pilB*, *hxfA*, *pglA* were designed for qRT-PCR. As an internal control the *16S* ribosomal RNA was used to normalize loading. Reverse transcription (RT) of samples was done using Omniscript kit (Qiagen, Germantown, MD). qRT-PCR was performed by utilizing SYBR green PCR master mix in a ABI-7500 system from Applied Biosystems (Carlsbad, CA) according to manufacturer's instructions. Melting curves after the

program finished were analyzed to confirm that a single product was produced. Fold change was calculated using the $2^{-\text{ddCt}}$ method (34).

Bacterial colonization in grapes

To study the effect of *pd1994*, *pd1617*, *pd1671*, *rpfG* and *cgsA* mutations on motility in grapevine 10 two-month-old grapevines (*Vitis vinifera* cv. Chardonnay) were needle inoculated per mutant strain between the third and fourth internode (25).

Bacterial suspensions of wild type *X. fastidiosa* and mutant strains were prepared in SCP buffer (disodium succinate, 1.0 g/L; trisodium citrate, 1.0 g/L; K_2HPO_4 , 1.5 g/L; KH_2PO_4 , 1.0 g/L; pH 7.0) at an OD_{600} of 0.25. Plants were maintained in the greenhouse at 25°C and 12 hrs of light/dark periods. After 8 weeks, petiole samples were taken at 0, 20, 40, 60 cm from the point of inoculation and real time PCR analysis was performed to assess if they were positive for *X. fastidiosa*.

RESULTS

RpfG and PD1617 have the conserved c-di-GMP phosphodiesterase domains

Degradation of c-di-GMP is performed by phosphodiesterases containing EAL(52) or HD-GYP domains (44). Analysis of *X. fastidiosa* genome by BLAST and the NCBI conserved-domain search tools were used to identify 4 genes that encode putative phosphodiesterases. PD1617 and PD1671 predicted proteins contain EAL-domains, PD1994 contains both, GGDEF and EAL domains and RpfG contains an HD-GYP-domain (<http://www.ncbi.nlm.nih.gov/Structure/cdd/wrpsb.cgi>). Domain alignments using the NCBI conserved-domain tool revealed that *X. fastidiosa*'s RpfG

predicted protein contained the conserved amino acid residues HD-GYP and that PD1617 also contained the conserved amino acids for PDE activity, EAL. However, the key amino acids for enzymatic activity are different in PD1994 with QIY (Glu-Ile-Pro) instead of EAL and CETF (Cys-Glu-Thr-Arg-Phe) instead of GGDEF. Also, PD1671 amino acid residues are QVL (Glu-Val-Leu) instead of EAL, which raises the question if these proteins have phosphodiesterase or diguanylate activity.

Additionally, a search in the database for prokaryotic operons (DOOR) was performed to check if these genes were predicted to be polycistronic (35). None of them were polycistronic.

Confirmation of gene replacement by homologous recombination

To study the possible role that putative c-di-GMP phosphodiesterase proteins have on *X. fastidiosa* biology, mutations on genes encoding putative EAL domains *PD1994*, *PD1617*, *PD1671*, and HD-GYP domain *rpfG* (*PD0405*) were performed (Fig.2.1). For comparison, I also performed a mutation on the gene *cgsA* (*PD0279*) which encodes a GGDEF-domain containing protein (9). All these genes had the target gene deleted by homologous recombination, except PD1617 that had an insertion of a kanamycin resistant gene (Fig. 2.2). Mutant strains were confirmed by PCR (Fig. 2.2) and Southern blot analysis (Fig. 2.3). These results demonstrate that the wild type target genes were deleted or disrupted in $\Delta PD1994$, $\Delta PD1617$, $\Delta PD1671$, $\Delta rpfG$ and $\Delta cgsA$.

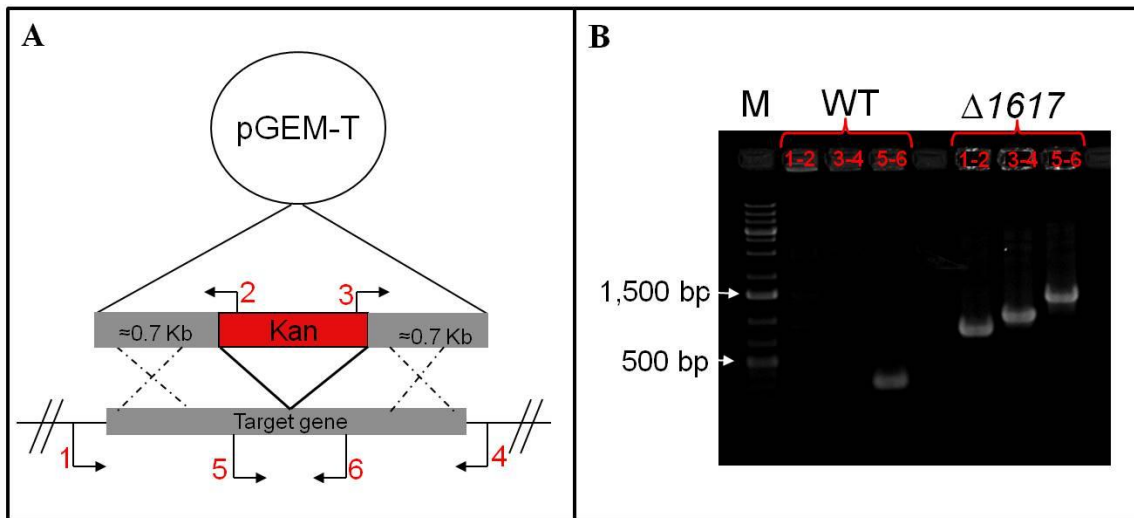

Fig. 2.2. Construction of *X. fastidiosa* $\Delta pd1617$ mutant strain. A) Diagram of gene disruption cassette utilized for mutagenesis of *pd1617* by double recombination. pGemT vector carried a kanamycin gene flanked with about 0.7 Kb base pairs that were homologous to *pd1617*. Numbers 1 to 6 represent approximate locations of primers used to identify mutant strains. *X. fastidiosa* WT would produce a 385 bp PCR product while $\Delta pd1617$ would produce 1,485bp PCR product utilizing primers 5 and 6. B) PCR of *X. fastidiosa* WT and $\Delta pd1617$ showing PCR products of the expected sizes. Kan:kanamycin gene, M: DNA molecular marker, bp: base pairs, Kb: kilobases.

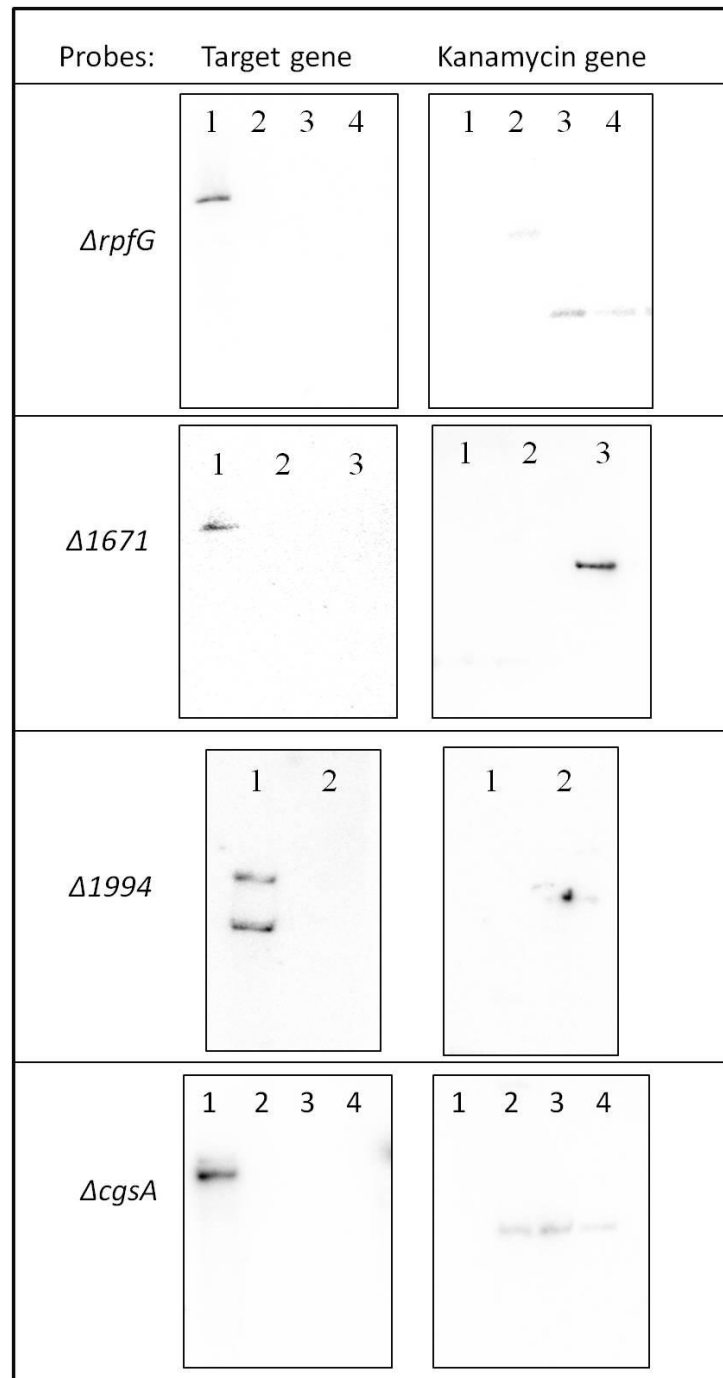

Fig.2.3. Southern blot of *X. fastidiosa* DNA from wild type and mutant strains. Wild type *X. fastidiosa* is located in lane 1 and putative mutant strains were in the other lanes. EcoRI and XhoI restriction enzymes were used to cut *ΔrpfG* DNA. Sequential restriction digestion of *Δpd167* was performed with SpeI and SalI enzymes. *Δpd1994* restriction digestion was performed with HindIII and *ΔcgsA* restriction digestion was done with EcoRI. Restriction digestion of WT DNA was performed for every set of enzymes used for mutant strains. The membranes were probed with P³² label using both target gene and kanamycin gene as probes.

***X. fastidiosa* growth is enhanced in $\Delta PD1994$ and $\Delta PD1617$**

Growth curves were performed to determine whether mutations in putative c-di-GMP phosphodiesterases had an effect on bacterial growth. *In vitro* growth curves over the course of 6 days were not significantly different among the wild type, $\Delta PD1671$, $\Delta rpfG$ and $\Delta cgsA$ (Fig 2.4). $\Delta PD1994$ and $\Delta PD1617$ strains reached stationary phase at day 3 compared to wild type that reached it around day 4. Also, their cell densities were higher when they reached stationary phase. This difference was calculated by Student's t-test with a p value < 0.05 (average of three independent experiments).

 $\Delta PD1994$, $\Delta PD1617$ and $\Delta cgsA$ failed to form cell aggregates in vitro

To determine if cell aggregation was affected by c-di-GMP biosynthesis proteins sedimentation percentages of mutant strains was calculated. $\Delta PD1994$, $\Delta PD1617$, and $\Delta cgsA$ exhibited more planktonic growth when cultured in PD3 broth media and were impaired in forming bacterial aggregates ($p < 0.0001$). However, $\Delta rpfG$ and $\Delta PD1671$ did not exhibit differences with *X. fastidiosa* wild type (Fig. 2.5).

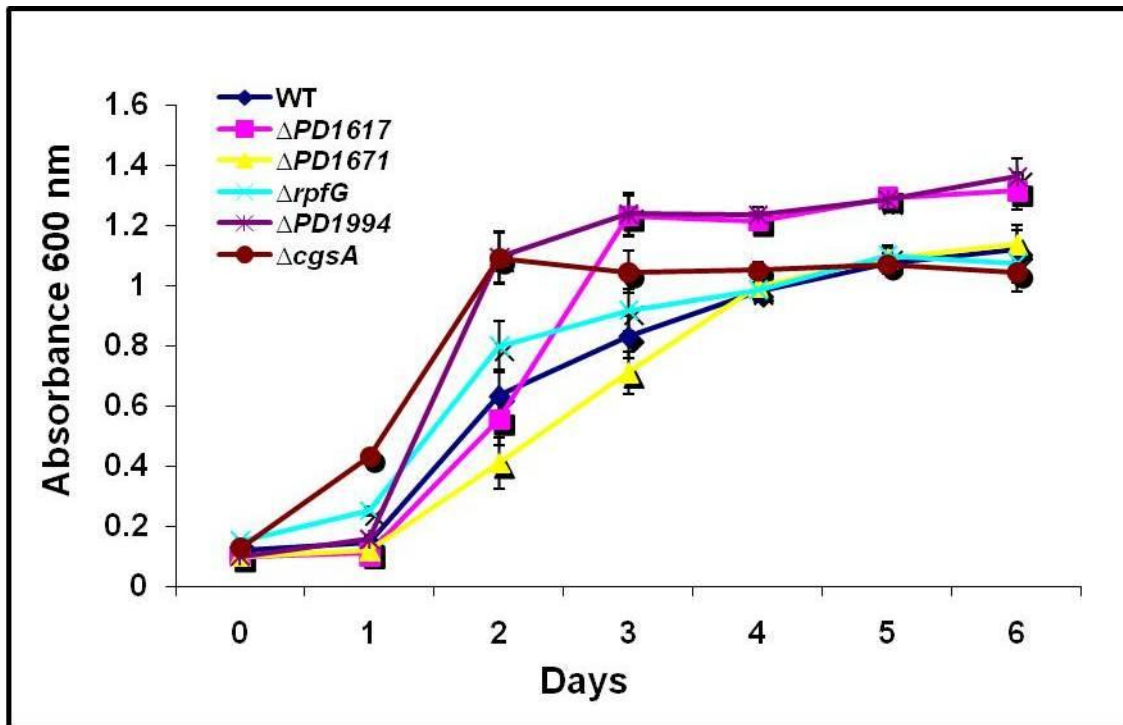

FIG.2.4. Growth curve of *X. fastidiosa* WT and mutant strains. Cell density was determined by measuring optical density at 600 nm (OD₆₀₀) daily for 6 days. No statistical differences were found between WT, $\Delta PD1671$, $\Delta rpfG$ and $\Delta cgsA$ by Student's t-test. $\Delta PD1994$ and $\Delta PD1617$ strains reached stationary phase by day 3 compared to wild type which reached stationary phase at day 4. Additionally, $\Delta PD1994$ and $\Delta PD1617$ strains had higher OD₆₀₀ than that of wild type. Differences were statistically significant with $p < 0.05$.

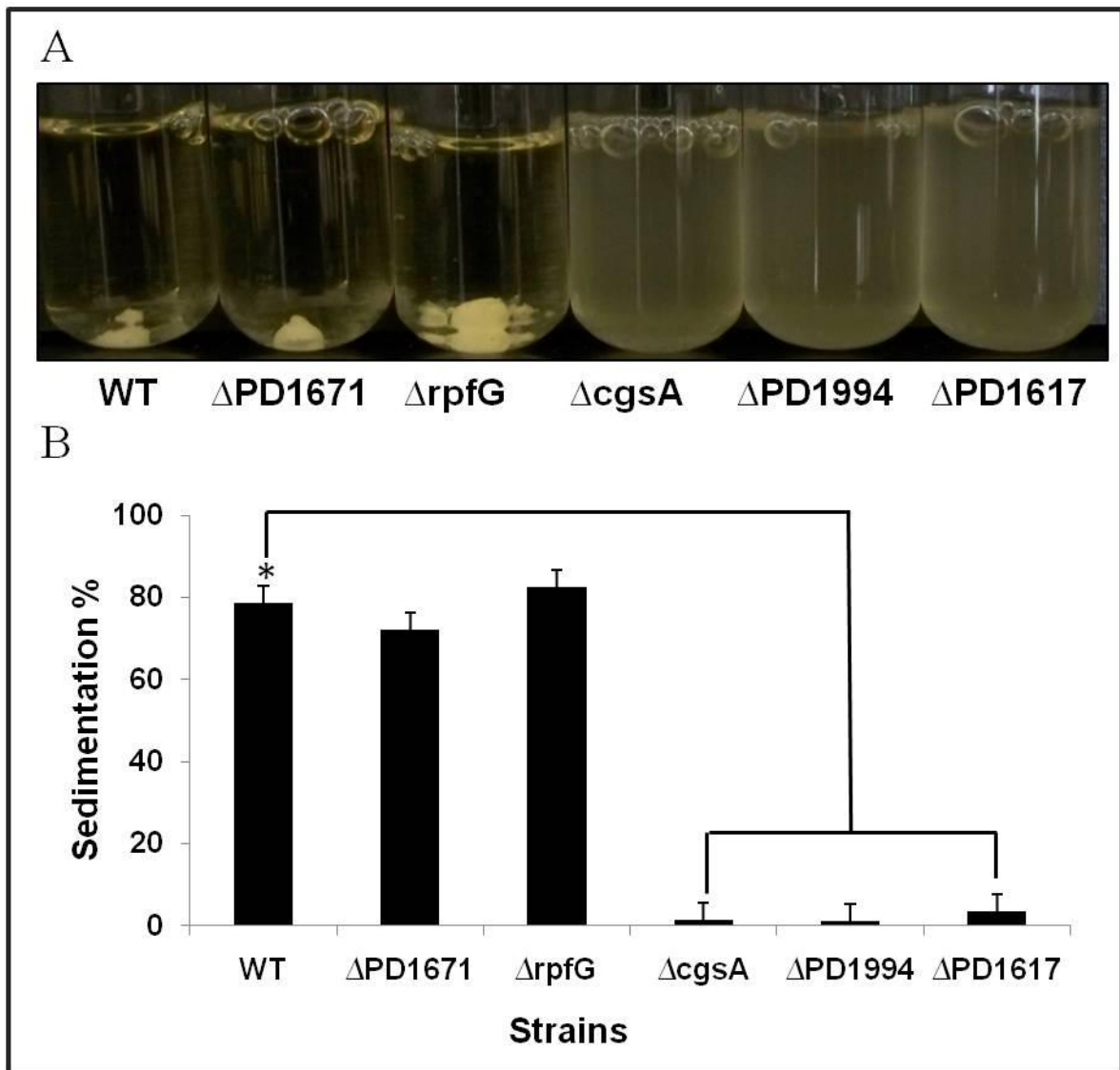

FIG. 2.5. Cell-cell aggregation assay of *X. fastidiosa* WT, Δ PD1994, Δ PD1617, Δ PD1671, Δ cgsA and Δ rpfG strains. A) Cell cultures showing cell aggregates of WT, Δ PD1671 and Δ rpfG strains and planktonic growth of Δ PD1994, Δ PD1617, and Δ cgsA strains. B) Sedimentation percentages of bacterial strains after 6 days of growth. Vertical bars represent the standard deviations of three independent experiments. * represent significant difference with a p value < 0.0001.

ΔPD1994, ΔPD1617 and ΔcgsA have enhanced biofilm in vitro

ΔPD1994, ΔPD1617 and *ΔcgsA* showed a significant increase in biofilm formation ($p < 0.001$) while *ΔrpfG* had reduced biofilm formation (Fig 2.6). *ΔPD1671* strain did not have any effect on biofilm development.

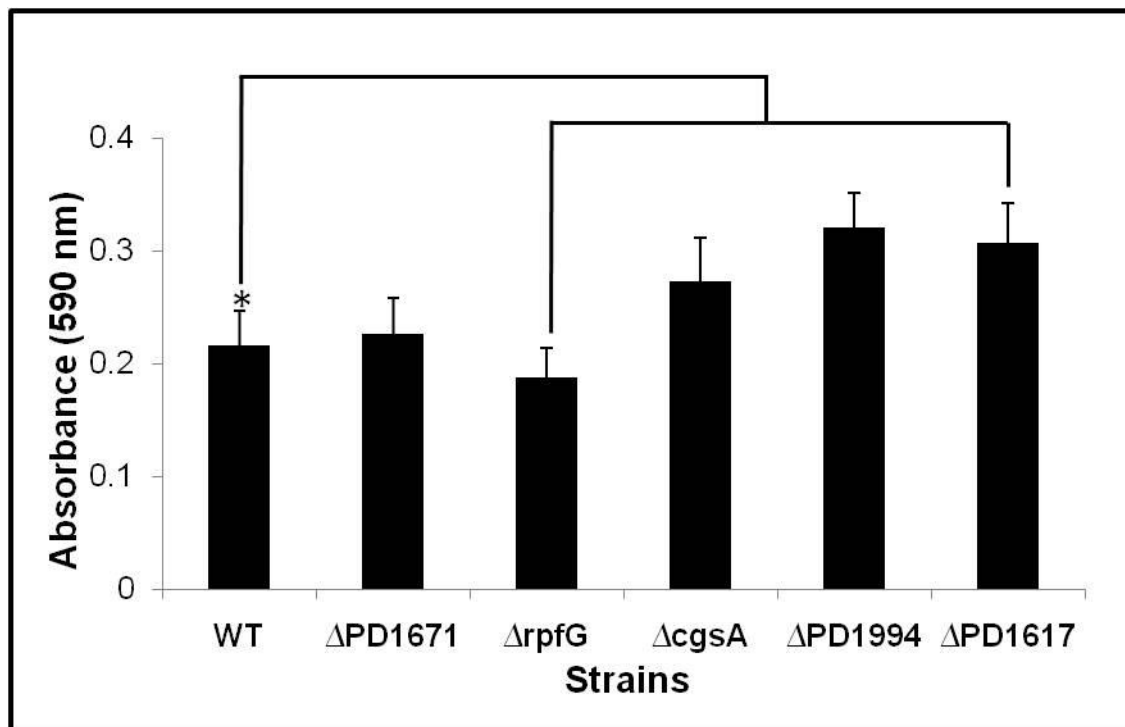

FIG. 2.6. Biofilm formation assay of *X. fastidiosa* WT, *ΔPD1994*, *ΔPD1617*, *ΔPD1671*, *ΔcgsA* and *ΔrpfG* strains. Absorbance at 590 nm was measured on the elution of crystal violet with ethanol. *ΔPD1994*, *ΔPD1617*, *ΔcgsA* had increased biofilm whereas *ΔrpfG* exhibited decreased surface attachment. No significant difference was found with *ΔPD1671*. Vertical bars represent the standard deviations of three independent experiments. * represent significant difference with a p value < 0.01 .

Movement in grapevine is not dependent on cell-cell aggregation

Mutant strains $\Delta pd1617$, $\Delta rpfG$ and $\Delta cgsA$ were able to colonize xylem vessels in grapevines at a longer distance from the point of inoculation (POI) than wild type. 90% of grapevines inoculated with $\Delta rpfG$ (which aggregates in vitro) were positive by real-time PCR at 40 cm above the POI (Table 2.2). $\Delta pd1994$ colonized 60% of grapevines at 40 cm from the POI but only 30% at 60 cm. Only 80% of grapevines were positive for $\Delta pd1671$ at the POI and half of the grapevines were positive for this mutant at 40 and 60 cm above the POI.

Table 2.2. Bacterial colonization assay in grapevines. Percentage of positive petioles at point of inoculation (POI), 20, 40 and 60 cm above POI for *X. fastidiosa* by real time PCR. Results from 1 experiment inoculating 10 grapevines with each bacterial strain. 4 petioles were collected from each grapevine at the different distances from the POI.

Genotype	POI	Distance above Point of Inoculation (POI)		
		20 cm	40 cm	60 cm
Wild type	100%	70%	30%	10%
$\Delta rpfG$	90%	90%	90%	60%
$\Delta PD1994$	90%	60%	60%	30%
$\Delta PD1617$	90%	80%	70%	60%
$\Delta PD1671$	80%	60%	40%	40%
$\Delta cgsA$	100%	100%	80%	80%
SCP buffer	0%	0%	0%	0%

$\Delta PD1994$, $\Delta PD1617$ and $\Delta cgsA$ mutations induce up-regulation of DSF synthase gene

The RpfC/RpfG two-component signaling system is directly related in regulation of gene expression of factors involved in virulence (10). Therefore, quantitative real-time PCR (qRT-PCR) studies were performed to test how $\Delta pd1994$, $\Delta pd1617$, $\Delta pd1671$, $\Delta rpfG$ and $\Delta cgsA$ mutations regulate changes in expression of *rpfC* (DSF receptor), *rpfF* (DSF synthase) and *rpfG* (putative DSF transducer with HD-GYP domain). $\Delta PD1994$, $\Delta PD1617$ and $\Delta cgsA$ mutations induce up-regulation of *rpfF*, suggesting that their gene products may be repressing its expression. Also, *rpfG* expression is upregulated in $\Delta pd1994$ and $\Delta cgsA$ mutant strains. Interestingly, *rpfC* expression was not altered in any of these mutant strains. Results of the qRT-PCR study are summarized in Table 2.3.

Table 2.3. Quantitative real-time PCR analysis of expression of RpfC/RpfG two-component system genes as influenced by $\Delta rpfG$, $\Delta pd1994$, $\Delta pd1617$, $\Delta pd1671$ and $\Delta cgsA$.

Gene	Fold Change* \pm SD				
	Strains				
	$\Delta rpfG$	$\Delta 1994$	$\Delta 1617$	$\Delta 1671$	$\Delta cgsA$
<i>rpfG</i>	n.d.	38.1 \pm 5.08	1.8 \pm 0.3	0.4 \pm 0.078	97.8 \pm 10.13
<i>rpfF</i>	0.8 \pm 0.19	43.7 \pm 5.73	3.6 \pm 0.35	0.63 \pm 0.15	6 \pm 0.17
<i>rpfC</i>	0.7 \pm 0.31	3.4 \pm 0.6	0.9 \pm 0.14	1.2 \pm 0.44	2 \pm 0.31

* 2^{-ddCt} was used to measure relative quantification of genes. 16S rRNA was used as internal control and everything is compared to WT equals to 1. SD: standard deviation from the mean of three independent experiments.

***ΔPD1994*, *ΔPD1617*, *ΔrpfG* and *ΔcgsA* mutations induce expression changes in genes involved in biofilm formation, cell-cell aggregation and virulence**

To test how *ΔPD1994*, *ΔPD1617*, *ΔrpfG* and *ΔcgsA* regulate changes in biofilm formation, cell-cell aggregation and movement, expression analysis of genes involved in these phenotypes was performed.

Biofilm formation and attachment to surfaces is promoted by type I pili and hemagglutinin adhesins (19, 36), therefore, expression of *fimA*, an essential gene for type I pili function and *hxfA*, necessary for biofilm maturation were analyzed. Expression of *fimA* and *hxfA* were up-regulated in *Δpd1994* and *ΔcgsA* strains, which may explain the increased attachment to surfaces in these mutant strains. However, in *Δpd1671* these two genes were up-regulated (although not in the same amounts) and did not exhibit any changes in biofilm formation. Also, in the *Δpd1617* mutant strain only the expression of *fimA* was up-regulated but not *hxfA*, suggesting that besides *fimA* and *hxfA* other factors might influence surface attachment and biofilm formation.

Type IV pili as well as cell wall degrading enzymes are important for grapevine colonization and movement of *X. fastidiosa* (33, 41), therefore, expression of *pilB*, a type IV pili precursor and *pglA*, a functional polygalacturonase, was assessed. Expression of *pglA* was up-regulated in *Δpd1994* and *ΔcgsA* mutant strains suggesting that expression of genes involved in biofilm formation and motility are up-regulated under the same conditions in *X. fastidiosa*. However, *Δpd1617* mutant had reduced expression of *pglA*. Also, *pglA* was down regulated in *ΔrpfG* mutant strain although *pilB* was up-regulated, which may explain why this mutant had reduced biofilm and was able to move further in

grapevines compared to wild type *X. fastidiosa*. Results of the qRT-PCR study are summarized in Table 2.4.

Table 2.4. Quantitative real-time PCR analysis of expression of genes involved in biofilm formation, cell-cell aggregation and motility in grapevine in response to $\Delta rpfG$, $\Delta pd1994$, $\Delta pd1617$, $\Delta pd1671$ and $\Delta cgsA$ mutations.

Gene	Fold Change* \pm SD				
	Strains				
	$\Delta rpfG$	$\Delta 1994$	$\Delta 1617$	$\Delta 1671$	$\Delta cgsA$
<i>fimA</i>	2.1 \pm 0.11	0.8 \pm 0.11	3.5 \pm 0.42	2.9 \pm 0.14	8 \pm 1.0
<i>hfxA</i>	1.4 \pm 0.48	9.6 \pm 1.26	1.3 \pm 0.40	4.7 \pm 0.18	53.8 \pm 6.68
<i>pilB</i>	4 \pm 1.19	3.6 \pm 0.47	0.1 \pm 0.66	3.2 \pm 0.508	2.8 \pm 0.49
<i>pglA</i>	0.1 \pm 0.02	7.2 \pm 0.95	0.1 \pm 0.48	0.6 \pm 0.12	19.2 \pm 1.86

* $2^{-\Delta\Delta Ct}$ was used to measure relative quantification of genes. 16S rRNA was used as internal control and everything is compared to WT equals to 1. SD: standard deviation from the mean of three independent experiments.

$\Delta PD1994$ and $\Delta PD1617$ mutations reduce *cgsA* gene expression

To test if $\Delta pd1994$, $\Delta pd1617$, $\Delta pd1671$, $\Delta rpfG$ and $\Delta cgsA$ mutations are involved in regulating each other's expression, qRT-PCR of *pd1994*, *pd1617*, *pd1671*, *rpfG* and *cgsA* was performed.

X. fastidiosa genome encodes for one GGDEF-domain containing protein CgsA (9). Expression of *cgsA* was down regulated in $\Delta pd1994$ and $\Delta pd1617$ mutant strains suggesting that these mutants may have lower c-di-GMP levels than wild type *X. fastidiosa*. This also may explain why these mutant strains have similar phenotypes as $\Delta cgsA$. Interestingly, $\Delta cgsA$ mutant had over 200-fold increase in expression of *pd1994* and over 20-fold increase in *pd1617*. Also, *pd1617* expression was up-regulated 22-fold

in $\Delta pd1994$. Although $\Delta pd1671$ and $\Delta rpfG$ mutations did not influence the expression of *cgsA*, *pd1994* and *pd1617*, their expression was up-regulated in $\Delta pd1994$ and $\Delta cgsA$.

Together these results suggest that these genes are related and influenced by each other (Table 2.5).

Table 2.5. Quantitative real-time PCR analysis of expression of putative diguanylate cyclase and c-di-GMP phosphodiesterases genes as response to $\Delta rpfG$, $\Delta pd1994$, $\Delta pd1617$, $\Delta pd1671$ and $\Delta cgsA$ mutations.

Gene	Fold Change* \pm SD				
	Strains				
	$\Delta rpfG$	$\Delta 1994$	$\Delta 1617$	$\Delta 1671$	$\Delta cgsA$
<i>cgsA</i>	1 \pm 0.48	0.3 \pm 0.04	0.2 \pm 0.09	0.8 \pm 0.42	n.d.
<i>PD1994</i>	1.3 \pm 0.47	n.d.	0.4 \pm 0.12	2.2 \pm 0.43	203.4 \pm 25.29
<i>PD1617</i>	0.5 \pm 0.07	22.6 \pm 2.96	n.d.	1 \pm 0.47	21.4 \pm 2.65
<i>PD1671</i>	1.1 \pm 0.04	5.7 \pm 0.74	0.1 \pm 0.11	n.d.	10.7 \pm 1.77

* $2^{-\Delta\Delta Ct}$ was used to measure relative quantification of genes. 16S rRNA was used as internal control and everything is compared to WT equals to 1. SD: standard deviation from the mean of three independent experiments. n.d. : non-detected.

DISCUSSION

Cyclic di-GMP is a cytoplasmic second messenger that regulates cell aggregation, biofilm formation, EPS production and virulence in several bacterial pathogens (15, 47, 53). This molecule is synthesized by diguanylate cyclase enzymes that contain GGDEF domains and is hydrolyzed by phosphodiesterases containing EAL or HD-GYP domains (15, 47, 53). The *X. fastidiosa* genome carries three genes which encode for EAL-domain proteins, and one gene for an HD-GYP domain protein. Alignment of the amino acid sequences revealed that PD1994 and PD1671, EAL-

domain containing proteins, do not have the conserved residues needed for enzymatic activity, therefore these proteins may lack PDE activity. However, they may still conserve c-di-GMP binding capacity and be biologically active. In this dissertation, I studied the effect of putative PDEs in regulation of biofilm formation, cell aggregation and gene expression of virulence factors in *X. fastidiosa*. Additionally, the effect on mutation of putative PDEs in bacterial translocation in grapevine was assessed.

I have shown that putative PDEs regulate biofilm formation in *X. fastidiosa*. Biofilm formation is regulated by the action of genes such as type I pili (*fimA*) and hemagglutinins (*hxfA*) that aid in the attachment of surfaces (19, 33). Mutation on putative PDE's $\Delta pd1617$ and $\Delta pd1994$ have enhanced biofilm formation and low cell aggregation as well as the $\Delta cgsA$ strain, which is a DGC (9) (Fig 2.6). Moreover, $\Delta PD1994$, $\Delta PD1617$ and $\Delta cgsA$ have increased expression of genes *fimA* and *hxfA*, which suggests that molecular changes in these mutants affect the same regulatory network. Additionally, expression of *cgsA* in $\Delta pd1617$ and $\Delta pd1994$ was down-regulated and overexpression of *pd1617* was detected in $\Delta pd1994$. Therefore, these three mutants may have low c-di-GMP levels and PD1994 may be a repressor of PD1617. Interestingly, expression of *pd1994* increased by 200-fold in $\Delta cgsA$ mutant strain. $\Delta cgsA$ mutant is without a functional DGC, which will induce over expression of *pd1994*. Although PD1994 has a GGDEF domain without the conserved amino acids for enzymatic activity, it may still bind GTP.

Cyclic di-GMP is important component for transduction of RpfC/RpfG two-component system in *X. campestris* (16). RpfC is a sensor kinase predicted to perceive a

DSF signal. RpfG is a response regulator with a receiver domain (REC) and HD-GYP domain which hydrolyzes c-di-GMP (44, 50). In this two-component system, DSF activates RpfC which in turn activates RpfG leading to low c-di-GMP levels (44). *X. fastidiosa* has a similar RpfC/RpfG two-component system (10). A mutation of *rpfG* is expected to have higher c-di-GMP levels and decreased biofilm formation in *X. fastidiosa*. This phenotype is observed in $\Delta rpfG$, suggesting that this protein has PDE activity.

PD1994, PD1617 and CgsA are involved in the expression of RpfC/RpfG two-component system. *rpfG* expression is up-regulated in $\Delta PD1994$ and $\Delta cgsA$ by 97-fold and 38-fold respectively. Also, *rpfF* (DSF synthase) expression increased 43-, 6-, 3.6-fold in $\Delta PD1994$, $\Delta cgsA$, and $\Delta PD1617$ strains respectively. Previous studies have shown that DSF down-regulates *cgsA* (10), which explains the reduced levels of expression of *cgsA* in $\Delta PD1994$ and $\Delta PD1617$ strains. Additionally, these results suggest that PD1994 may suppress DSF production repressing the expression of *rpfF*. The complex relation between PD1994, PD1617 and CgsA contributes to the regulation of RpfC/rpfG signal transduction likely by altering c-di-GMP intracellular levels.

X. fastidiosa RpfG may act downstream of CgsA, PD1994 and PD1617. $\Delta rpfG$ strain has no effect on gene expression of *cgsA*, *pd1617* and *pd1994*. Conversely *rpfG* expression is affected in $\Delta cgsA$, and $\Delta pd1994$. Whether this regulation is related to c-di-GMP concentrations or direct protein-protein interaction remains to be tested. $\Delta rpfG$ mutation didn't affect the expression of *rpfC* or *rpfF* either. Therefore, RpfG controls

factors downstream of the RpfC/RpfG two-component system, like biofilm formation, but does not produce feedback regulation of the system.

The ability of *X. fastidiosa* to migrate away from the point of inoculation and spread throughout the plant is important for virulence (19). Grapevines inoculated with wild type *X. fastidiosa* and $\Delta rpfG$, $\Delta pd1994$, $\Delta pd1617$, $\Delta pd1671$ and $\Delta cgsA$ mutant strains exhibited different migration rates throughout the plant. Although, $\Delta pd1994$, $\Delta pd1617$ and $\Delta cgsA$ had similar biofilm formation, cell aggregation and gene expression their translocation in grapevine differed. These results suggest that it is too simplistic to say that *in planta* motility can be assessed *in vitro* by measuring biofilm formation and cell aggregation. Although increased biofilm formation and adhesiveness is related to decreased virulence in grapevine, fine tuning of the signals that trigger biofilm dispersal are key for bacterial translocation and disease development.

PD1671 is not involved in regulation of *X. fastidiosa* biofilm formation and cell aggregation. A mutation of *pd1671* in *X. fastidiosa* did not alter growth, cell aggregation or biofilm formation patterns. Additionally, gene expression analysis revealed that $\Delta 1671$ strain did not affect the expression of genes from the RpfC/RpfG two-component system, and other putative PDE's or DGCs. Therefore, PD1671 is not involved in transduction of DSF signaling or in controlling biofilm or cell aggregation by a different gene network.

This dissertation demonstrates that biofilm formation, aggregation and expression of virulence factors are regulated in part by putative PDE proteins PD1994, PD1617, and RpfG. These putative proteins are likely to act synergistically with

RpfC/RpfG two-component system to transduce DSF signaling by altering c-di-GMP intracellular concentration. Whether the regulation of biofilm formation and aggregation is obtained by direct protein-protein interaction with their target or if it is through c-di-GMP remains to be studied.

CHAPTER III

CONCLUSIONS

X. fastidiosa virulence is a complex process that depends on the development of a biofilm that restricts water flow in the plants xylem and the ability of the pathogen to migrate away from the biofilm and colonize more xylem vessels is important for virulence (19, 41). In addition, this pathogen needs to colonize insects in order to spread to new plants (39). Interestingly, for this bacterial pathogen, characteristics that aid in insect colonization oppose those that are needed for plant colonization (8). In this study, I addressed the question of how putative c-di-GMP phosphodiesterase proteins regulate virulence associated traits in the bacterial pathogen *X. fastidiosa*.

In several bacterial pathogens c-di-GMP regulates the transition from a sessile state in a biofilm to a motile lifestyle (24, 53), activities that are important for *X. fastidiosa* virulence (8). The *X. fastidiosa* genome encodes for four genes that contain the domains that control c-di-GMP turnover. Two of these genes, *pd1617* and *rpfG* have the conserved amino acid residues responsible for PDE enzymatic activity which supports the assumption that they are functional PDEs. PD1994 and PD1671 have EAL domains but neither contains the conserved amino acids for enzymatic activity. However, proteins lacking PDE or DGC enzymatic activities can be biologically active (24).

This dissertation confirms that two EAL-domain containing proteins (PD1994 and PD1617) and the HD-GYP-domain containing protein (RpfG) from *X. fastidiosa* contribute in the regulation of cell-to-cell signaling, biofilm formation, cell aggregation

and gene expression of traits important for bacterial virulence. It also suggests that PD1994 regulate DSF signaling by repressing *rpff* expression and c-di-GMP turnover by repression of RpfG and PD1617 gene expression. Whether these regulations are obtained by direct protein-protein interaction with their target or if it is through c-di-GMP turnover remains to be studied. However, the interplay of PD1994, PD1617 and RpfG with CgsA and the DSF regulatory network are likely to regulate c-di-GMP intracellular concentration and thus the phenotypes regulated by it.

This dissertation contributes to our understanding of the signaling pathways that control Pierce's disease development. These findings also suggest that control strategies utilizing c-di-GMP concentration to manipulate bacterial behaviors, such as decreasing bacterial virulence or insect transmission, may provide potential approaches to Pierce's disease management and control.

REFERENCES

1. **Almeida, R. P. P., and A. H. Purcell.** 2003. Transmission of *Xylella fastidiosa* to grapevines by *Homalodisca coagulata* (Hemiptera: Cicadellidae). *J. Econ. Entomol.* **96**:264-271.
2. **An, S., J. Wu, and L.-H. Zhang.** 2010. Modulation of *Pseudomonas aeruginosa* biofilm dispersal by a cyclic-di-GMP phosphodiesterase with a putative hypoxia-sensing domain. *Appl. Environ. Microbiol.* **76**:8160-8173.
3. **Appel, D. N., and P. de Figueiredo.** 2007. An analysis of c-di-GMP signaling in *Xylella fastidiosa* virulence. *Pierce's Disease Research Symposium*:169-172.
4. **Ausmees, N., R. Mayer, H. Weinhouse, G. Volman, D. Amikam, M. Benziman, and M. Lindberg.** 2001. Genetic data indicate that proteins containing the GGDEF domain possess diguanylate cyclase activity. *FEMS Microbiol. Lett.* **204**:163-167.
5. **Barber, C. E., J. L. Tang, J. X. Feng, M. Q. Pan, T. J. G. Wilson, H. Slater, J. M. Dow, P. Williams, and M. J. Daniels.** 1997. A novel regulatory system required for pathogenicity of *Xanthomonas campestris* is mediated by a small diffusible signal molecule. *Mol. Microbiol.* **24**:555-566.
6. **Bruening, G., P. Feldstein, and E. L. Civerolo.** 2008. Exploiting *Xylella fastidiosa* proteins for Pierce's disease control. *Pierce's Disease Research Symposium*:142-148.
7. **Camilli, A., and B. L. Bassler.** 2006. Bacterial Small-Molecule Signaling Pathways. *Science* **311**:1113-1116.
8. **Chatterjee, S., R. P. P. Almeida, and S. Lindow.** 2008. Living in two worlds: the plant and insect lifestyles of *Xylella fastidiosa*. *Annu. Rev. Phytopathol.* **46**:243-271.
9. **Chatterjee, S., N. Killiny, R. P. P. Almeida, and S. E. Lindow.** 2010. Role of cyclic di-GMP in *Xylella fastidiosa* biofilm formation, plant virulence, and insect transmission. *Mol. Plant-Microbe Interact.* **23**:1356-1363.
10. **Chatterjee, S., C. Wistrom, and S. E. Lindow.** 2008. A cell-cell signaling sensor is required for virulence and insect transmission of *Xylella fastidiosa*. *Proc. Nat. Acad. Sci. U. S. A.* **105**:2670-2675.
11. **Davis, M. J., A. H. Purcell, and S. V. Thomson.** 1980. Isolation media for the Pierce's disease bacterium. *Phytopathology* **70**:425-429.

12. **De La Fuente, L., T. J. Burr, and H. C. Hoch.** 2008. Autoaggregation of *Xylella fastidiosa* cells is influenced by type I and type IV pili. *Appl. Environ. Microbiol.* **74**:5579-5582.
13. **De La Fuente, L., E. Montanes, Y. Meng, Y. Li, T. J. Burr, H. C. Hoch, and M. Wu.** 2007. Assessing adhesion forces of type I and type IV pili of *Xylella fastidiosa* bacteria by use of a microfluidic flow chamber. *Appl. Environ. Microbiol.* **73**:2690-2696.
14. **Dow, J. M., L. Crossman, K. Findlay, Y.-Q. He, J.-X. Feng, and J.-L. Tang.** 2003. Biofilm dispersal in *Xanthomonas campestris* is controlled by cell-cell signaling and is required for full virulence to plants. *Proc. Nat. Acad. Sci. U. S. A.* **100**:10995-11000.
15. **Dow, J. M., Y. Fouhy, J. F. Lucey, and R. P. Ryan.** 2006. The HD-GYP domain, cyclic di-GMP signaling, and bacterial virulence to plants. *Mol. Plant-Microbe Interact.* **19**:1378-1384.
16. **Dow, M.** 2008. Diversification of the function of cell-to-cell signaling in regulation of virulence within plant pathogenic xanthomonads. *Sci. Signal.* **1**:pe23.
17. **Fouhy, Y., J. F. Lucey, R. P. Ryan, and J. M. Dow.** 2006. Cell-cell signaling, cyclic di-GMP turnover and regulation of virulence in *Xanthomonas campestris*. *Res. Microbiol.* **157**:899-904.
18. **Gambetta, G. A., J. Fei, T. L. Rost, and M. A. Matthews.** 2007. Leaf scorch symptoms are not correlated with bacterial populations during Pierce's disease. *J. Exp. Bot.* **58**:4037-4046.
19. **Guilhabert, M. R., and B. C. Kirkpatrick.** 2005. Identification of *Xylella fastidiosa* antivirulence genes: hemagglutinin adhesins contribute to *X. fastidiosa* biofilm maturation and colonization and attenuate virulence. *Mol. Plant-Microbe Interact.* **18**:856-868.
20. **Güvener, Z. T., and C. S. Harwood.** 2007. Subcellular location characteristics of the *Pseudomonas aeruginosa* GGDEF protein, WspR, indicate that it produces cyclic-di-GMP in response to growth on surfaces. *Mol. Microbiol.* **66**:1459-1473.
21. **Hay, I. D., U. Remminghorst, and B. H. A. Rehm.** 2009. MucR, a novel membrane-associated regulator of alginate biosynthesis in *Pseudomonas aeruginosa*. *Appl. Environ. Microbiol.* **75**:1110-1120.

22. **He, Y.-W., C. Boon, L. Zhou, and L.-H. Zhang.** 2009. Co-regulation of *Xanthomonas campestris* virulence by quorum sensing and a novel two-component regulatory system RavS/RavR. *Mol. Microbiol.* **71**:1464-1476.
23. **He, Y.-W., and L.-H. Zhang.** 2008. Quorum sensing and virulence regulation in *Xanthomonas campestris*. *FEMS Microbiol. Rev.* **32**:842-857.
24. **Hengge, R.** 2009. Principles of c-di-GMP signalling in bacteria. *Nat. Rev. Microbiol.* **7**:263-273.
25. **Hill, B. L., and A. H. Purcell.** 1995. Multiplication and movement of *Xylella fastidiosa* within grapevine and four other plants. *Phytopathology* **85**:1368-1372.
26. **Hopkins, D. L.** 1989. *Xylella fastidiosa*: xylem-limited bacterial pathogen of plants. *Annu. Rev. Phytopathol.* **27**:271-290.
27. **Hopkins, D. L., and A. H. Purcell.** 2002. *Xylella fastidiosa*: cause of Pierce's disease of grapevine and other emergent diseases. *Plant Dis.* **86**:1056-1066.
28. **Killiny, N., and R. P. P. Almeida.** 2009. *Xylella fastidiosa* afimbrial adhesins mediate cell transmission to plants by leafhopper vectors. *Appl. Environ. Microbiol.* **75**:521-528.
29. **Kulasakara, H., V. Lee, A. Brencic, N. Liberati, J. Urbach, S. Miyata, D. G. Lee, A. N. Neely, M. Hyodo, Y. Hayakawa, F. M. Ausubel, and S. Lory.** 2006. Analysis of *Pseudomonas aeruginosa* diguanylate cyclases and phosphodiesterases reveals a role for bis-(3'-5')-cyclic-GMP in virulence. *Proc. Natl. Acad. Sci. U. S. A.* **103**:2839-44.
30. **Lee, R. F., M. J. Beretta, J. H. Huartung, M. E. Hooker, and K. S. Derrick.** 1993. Citrus variegated chlorosis: confirmation of *Xylella fastidiosa* as the causal agent. *Summa Phytopathol.* **19**:123-125.
31. **Lee, V. T., J. M. Matewish, J. L. Kessler, M. Hyodo, Y. Hayakawa, and S. Lory.** 2007. A cyclic-di-GMP receptor required for bacterial exopolysaccharide production. *Mol. Microbiol.* **65**:1474-1484.
32. **Leite, B., P. C. Andersen, and M. L. Ishida.** 2004. Colony aggregation and biofilm formation in xylem chemistry-based media for *Xylella fastidiosa*. *FEMS Microbiol. Lett.* **230**:283-290.
33. **Li, Y., G. Hao, C. D. Galvani, Y. Meng, L. D. L. Fuente, H. C. Hoch, and T. J. Burr.** 2007. Type I and type IV pili of *Xylella fastidiosa* affect twitching motility, biofilm formation and cell-cell aggregation. *Microbiology* **153**:719-726.

34. **Livak, K. J., and T. D. Schmittgen.** 2001. Analysis of relative gene expression data using real-time quantitative PCR and the $2^{-\Delta\Delta Ct}$ method. *Methods* **25**:402-408.
35. **Mao, F., P. Dam, J. Chou, V. Olman, and Y. Xu.** 2009. DOOR: a database for prokaryotic operons. *Nucl. Acids Res.* **37**:D459-D463.
36. **Meng, Y., Y. Li, C. D. Galvani, G. Hao, J. N. Turner, T. J. Burr, and H. C. Hoch.** 2005. Upstream migration of *Xylella fastidiosa* via pilus-driven twitching motility. *J. Bacteriol.* **187**:5560-5567.
37. **Newman, K. L., R. P. P. Almeida, A. H. Purcell, and S. E. Lindow.** 2004. Cell-cell signaling controls *Xylella fastidiosa* interactions with both insects and plants. *Proc. Nat. Acad. Sci. U. S. A.* **101**:1737-1742.
38. **Purcell, A. H., F. A. H., and D. L. McLean.** 1979. Pierce's disease bacterium: mechanism of transmission by leafhopper vectors. *Science* **206**:839-841.
39. **Redak, R. A., A. H. Purcell, J. R. Lopes, M. J. Blua, R. F. Mizell, 3rd, and P. C. Andersen.** 2004. The biology of xylem fluid-feeding insect vectors of *Xylella fastidiosa* and their relation to disease epidemiology. *Annu. Rev. Entomol.* **49**:243-70.
40. **Reddy, J. D., S. L. Reddy, D. L. Hopkins, and D. W. Gabriel.** 2007. TolC is required for pathogenicity of *Xylella fastidiosa* in *Vitis vinifera* grapevines. *Mol. Plant-Microbe Interact.* **20**:403-410.
41. **Roper, M. C., L. C. Greve, J. G. Warren, J. M. Labavitch, and B. C. Kirkpatrick.** 2007. *Xylella fastidiosa* requires polygalacturonase for colonization and pathogenicity in *Vitis vinifera* grapevines. *Mol. Plant-Microbe Interact.* **20**:411-419.
42. **Ross, P., H. Weinhouse, Y. Aloni, D. Michaeli, P. Weinberger-Ohana, R. Mayer, S. Braun, E. de Vroom, G. A. van der Marel, J. H. van Boom, and M. Benziman.** 1987. Regulation of cellulose synthesis in *Acetobacter xylinum* by cyclic diguanylic acid. *Nature* **325**:279-281.
43. **Ryan, R. P., and J. M. Dow.** 2011. Communication with a growing family: diffusible signal factor (DSF) signaling in bacteria. *Trends Microbiol.* **19**:145-152.
44. **Ryan, R. P., Y. Fouhy, J. F. Lucey, L. C. Crossman, S. Spiro, Y.-W. He, L.-H. Zhang, S. Heeb, M. Camara, P. Williams, and J. M. Dow.** 2006. Cell-cell signaling in *Xanthomonas campestris* involves an HD-GYP domain protein that

- functions in cyclic di-GMP turnover. Proc. Natl. Acad. Sci. U. S. A. **103**:6712-6717.
45. **Sambrook, J., E. F. Fritsch, and T. Maniatis.** 1989. Molecular cloning: a laboratory manual, 2nd ed., Cold Spring Harbor Laboratory, Cold Spring Harbor, NY.
 46. **Sauer, K., A. K. Camper, G. D. Ehrlich, J. W. Costerton, and D. G. Davies.** 2002. *Pseudomonas aeruginosa* displays multiple phenotypes during development as a biofilm. J. Bacteriol. **184**:1140-1154.
 47. **Schirmer, T., and U. Jenal.** 2009. Structural and mechanistic determinants of c-di-GMP signalling. Nat. Rev. Microbiol. **7**:724-735.
 48. **Shi, X. Y., C. K. Dumenyo, R. Hernandez-Martinez, H. Azad, and D. A. Cooksey.** 2007. Characterization of regulatory pathways in *Xylella fastidiosa*: genes and phenotypes controlled by algU. Appl. Environ. Microbiol. **73**:6748-6756.
 49. **Simionato, A. V. C., D. S. d. Silva, M. R. Lambais, and E. Carrilho.** 2007. Characterization of a putative *Xylella fastidiosa* diffusible signal factor by HRGC-EI-MS. J. Mass Spectr. **42**:1375-1381.
 50. **Slater, H., A. Alvarez-Morales, C. E. Barber, M. J. Daniels, and J. M. Dow.** 2000. A two-component system involving an HD-GYP domain protein links cell-cell signalling to pathogenicity gene expression in *Xanthomonas campestris*. Mol. Microbiol. **38**:986-1003.
 51. **Sorensen, J. T., and R. J. Gill.** 1996. A range extension of *Homalodisca coagulata* (Say) (Hemiptera: Clypeorrhyncha: Cicadellidae) to southern California. Pan-Pac. Entomol. **72**:160-161.
 52. **Tal, R., H. C. Wong, R. Calhoon, D. Gelfand, A. L. Fear, G. Volman, R. Mayer, P. Ross, D. Amikam, H. Weinhouse, A. Cohen, S. Sapir, P. Ohana, and M. Benziman.** 1998. Three *cdg* operons control cellular turnover of cyclic di-GMP in *Acetobacter xylinum*: genetic organization and occurrence of conserved domains in isoenzymes. J. Bacteriol. **180**:4416-4425.
 53. **Tamayo, R., J. T. Pratt, and A. Camilli.** 2007. Roles of cyclic diguanylate in the regulation of bacterial pathogenesis. Annu. Rev. Microbiol. **61**:131-148.
 54. **Van Sluys, M. A., M. C. de Oliveira, C. B. Monteiro-Vitorello, C. Y. Miyaki, L. R. Furlan, L. E. A. Camargo, A. C. R. da Silva, D. H. Moon, M. A. Takita, E. G. M. Lemos, M. A. Machado, M. I. T. Ferro, F. R. da Silva, M. H. S. Goldman, G. H. Goldman, M. V. F. Lemos, H. El-Dorry, S. M. Tsai, H.**

- Carrer, D. M. Carraro, R. C. de Oliveira, L. R. Nunes, W. J. Siqueira, L. L. Coutinho, E. T. Kimura, E. S. Ferro, R. Harakava, E. E. Kuramae, C. L. Marino, E. Giglioti, I. L. Abreu, L. M. C. Alves, A. M. do Amaral, G. S. Baia, S. R. Blanco, M. S. Brito, F. S. Cannavan, A. V. Celestino, A. F. da Cunha, R. C. Fenille, J. A. Ferro, E. F. Formighieri, L. T. Kishi, S. G. Leoni, A. R. Oliveira, V. E. Rosa, Jr., F. T. Sasaki, J. A. D. Sena, A. A. de Souza, D. Truffi, F. Tsukumo, G. M. Yanai, L. G. Zaros, E. L. Civerolo, A. J. G. Simpson, N. F. Almeida, Jr., J. C. Setubal, and J. P. Kitajima.** 2003. Comparative analyses of the complete genome sequences of Pierce's disease and citrus variegated chlorosis strains of *Xylella fastidiosa*. *J. Bacteriol.* **185**:1018-1026.
55. **von Bodman, S. B., W. D. Bauer, and D. L. Coplin.** 2003. Quorum sensing in plant-pathogenic bacteria. *Annu. Rev. Phytopathol.* **41**:455-482.
56. **Wilson, K.** 2001. Preparation of genomic DNA from bacteria, *In* Current protocols in molecular biology, vol. 4. John Wiley & Sons, New York, NY.
57. **Yu, J.-H., Z. Hamari, K.-H. Han, J.-A. Seo, Y. Reyes-Domínguez, and C. Scazzocchio.** 2004. Double-joint PCR: a PCR-based molecular tool for gene manipulations in filamentous fungi. *Fungal Gen. Biol.* **41**:973-981.

VITA

Name: Veronica Ancona-Contreras

Address: Plant Pathology and Microbiology Department
Texas A&M University
2132 TAMU
College Station, TX 77843

Email Address: vero_ancona@tamu.edu

Education: B.S., Agronomy, Universidad Autonoma de Nuevo Leon 2000

M.S., Plant and Soil Science, Texas A&M University-Kingsville
2005

Ph.D., Plant Pathology, Texas A&M University, 2011