

EVALUATION OF CONTAMINANT MIXING IN
RAINWATER HARVESTING FIRST FLUSH DIVERTERS

A Thesis

by

JUSTIN KEITH MECHELL

Submitted to the Office of Graduate Studies of
Texas A&M University
in partial fulfillment of the requirements for the degree of

MASTER OF SCIENCE

August 2009

Major Subject: Biological and Agricultural Engineering

EVALUATION OF CONTAMINANT MIXING IN
RAINWATER HARVESTING FIRST FLUSH DIVERTERS

A Thesis

by

JUSTIN KEITH MECHELL

Submitted to the Office of Graduate Studies of
Texas A&M University
in partial fulfillment of the requirements for the degree of

MASTER OF SCIENCE

Approved by:

Chair of Committee,	Bruce Lesikar
Committee Members,	Binayak Mohanty
	Don Wilkerson
	Fouad Jaber
	Dana Porter
Head of Department,	Gerald Riskowski

August 2009

Major Subject: Biological and Agricultural Engineering

ABSTRACT

Evaluation of Contaminant Mixing in Rainwater Harvesting First Flush Diverters.

(August 2009)

Justin Keith Mechell, B.S., Texas A&M University

Chair of Advisory Committee: Dr. Bruce J. Lesikar

As the world population increases, the demand increases for quality drinking water. The harvesting of rainwater has the potential to assist in alleviating pressures on current water supplies and storm water drainage systems. Diversion of a portion of the collected water away from storage is a technique used to improve harvested rainwater water quality prior to storage. Six configurations of a downspout first flush diverter were constructed and tested in the laboratory. The configurations of diverters were evaluated for their affinity to allow diverted water in the diverter chamber to interact with the flow of water to storage. Experiments were conducted at flow rates ranging from 0.76 L/min to 113.56 L/min. This range of flow rates adequately represents a wide range of common storm intensity patterns across the United States to which downspout first flush diverters are subjected.

The diverter chamber to downspout transition fittings tested on a 10.16 cm diameter diverter chamber, upward and downward oriented sanitary and straight tee, do not have a significant impact on the mean difference in initial and final total dissolved solids concentrations observed at multiple sample ports. No statistical difference was

observed when comparing upward and downward oriented sanitary tees used as diverter chambers to downspout transition fittings on 10.16 and 15.24 cm diverter chambers. Utilizing a straight tee as a transition fitting with a floating ball, acting as a barrier between water collected in the diverter chamber of a downspout first flush diverter and the flow passing through the transition fitting, limited diverted water from interacting with the subsequent flow of harvested rainwater. There is not a significant difference between the use of a downspout first flush diverter with diverter chamber diameters of 10.16 and 15.24 cm utilizing upward and downward oriented sanitary tees as downspout to diverter chamber transition fittings. Tests at flow rates less than or equal to 12.11 L/min exhibited limited changes in total dissolved solids concentrations in the downspout first flush diverters with 15.24 cm diameter diverter chambers. Tests at flow rates less than or equal to 1.51 L/min exhibited limited changes in total dissolved solids concentrations in the downspout first flush diverters with 10.16 cm diameter diverter chambers. The diverter chamber drain flow rate and volume impacts the observed differences in initial and final TDS concentrations at all sample ports on the diverter chamber of a downspout first flush diverter regardless of flow rate. The diverter chamber drain flow rate impacts the flow rate of water entering the diverter chamber through the transition fitting.

ACKNOWLEDGEMENTS

I would like to thank my committee chair, Dr. Lesikar, and my committee members, Dr. Mohanty, Dr. Wilkerson, Dr. Jaber, and Dr. Porter, for their guidance and support throughout the course of this research.

Thanks also go to my friends and colleagues and the department faculty and staff for making my time at Texas A&M University a great experience. I would also like to thank all of our student workers who assisted with my research, Nick Kaechler, Shannon Reagan, Kyle Jackson, and Ryan Gerlich.

I would like to thank Clifton and Molly Griffin for encouraging me to pursue my master's degree.

Last but not least, thanks to my family for their encouragement and support throughout my entire educational career. Most importantly, I would like to thank my wife, Jordan, for her patience and support throughout the entire process of me earning my degree.

TABLE OF CONTENTS

	Page
ABSTRACT	iii
ACKNOWLEDGEMENTS	v
TABLE OF CONTENTS	vi
LIST OF FIGURES.....	viii
LIST OF TABLES	xii
INTRODUCTION.....	1
RESEARCH OBJECTIVES	6
LITERATURE REVIEW	7
Runoff Water Quality.....	7
First Flush Diversion.....	10
First Flush Diversion Volume	10
Downspout First Flush Diverter Configurations	11
Catchment Size and Rainfall Characteristics	13
Diverter Chamber Drain.....	14
METHODS AND PROCEDURES.....	16
Test Apparatus.....	16
First Flush Diverters.....	18
Testing Scenarios	23
Flow Control and Testing Equipment	29
Sampling Protocol.....	30
ANALYSIS AND RESULTS	31
Statistical Analysis	31

	Page
Confidence Intervals	34
Diverter A.....	35
Diverter B.....	37
Diverter C.....	40
Diverter D.....	44
Diverter E.....	47
Diverter F.....	49
Diverter Chamber Drain Open	52
DISCUSSION	55
Comparison of 10.16 and 15.24 cm Diameter Diverter Chambers.....	56
Comparison of Upward and Downward Oriented Sanitary Tees as Transition Fittings ...	65
Comparison of Four Transition Fittings.....	73
Observation of Recommended First Flush Diversion Volumes.....	81
Rainfall Characteristics	82
CONCLUSIONS.....	84
FUTURE RESEARCH	86
REFERENCES.....	87
APPENDIX A	92
APPENDIX B	140
VITA	182

LIST OF FIGURES

	Page
Figure 1. Diagram and basic components of a downspout first flush diverter. ...	12
Figure 2. Applicable region for various SCS Type curves.....	13
Figure 3. Downspout first flush diverter mounted on the test stand.....	16
Figure 4. Six downspout first flush diverter configurations utilized for experiments	20
Figure 5. Diverter chamber sampling port locations relative to the diverter chamber to downspout transition fitting.....	23
Figure 6. 2.5, 5.1, 10.2, and 20.3 cm SCS storm curve generated storm events for Austin, Texas	25
Figure 7. Diverter A's relationship between the mean total dissolved solids concentration and location of sampling ports in the diverter chamber at various flow rates with a closed diverter chamber drain.....	35
Figure 8. Diverter B's relationship between the mean total dissolved solids concentration and location of sampling ports in the diverter chamber at various flow rates with a closed diverter chamber drain.....	38
Figure 9. Diverter C's relationship between the mean total dissolved solids concentration and location of sampling ports in the diverter chamber at various flow rates with a closed diverter chamber drain.....	41
Figure 10. Diverter D's relationship between the mean total dissolved solids concentration and location of sampling ports in the diverter chamber at various flow rates with a closed diverter chamber drain ..	44
Figure 11. Diverter E's relationship between the mean total dissolved solids concentration and location of sampling ports in the diverter chamber at various flow rates with a closed diverter chamber drain ..	47

	Page
Figure 12. Diverter F's relationship between the mean total dissolved solids concentration and location of sampling ports in the diverter chamber at various flow rates with a closed diverter chamber drain ..	50
Figure 13. Comparison of the mean differences in initial and final total dissolved solids concentration in two 10.16 cm (left) and two 15.24 cm (right) diverter chambers at a flow rate of 0.76 L/min	57
Figure 14. Comparison of the mean differences in initial and final total dissolved solids concentration in two 10.16 cm (left) and two 15.24 cm (right) diverter chambers at a flow rate of 1.51 L/min	57
Figure 15. Comparison of the mean differences in initial and final total dissolved solids concentration in two 10.16 cm (left) and two 15.24 cm (right) diverter chambers at a flow rate of 3.03 L/min	58
Figure 16. Comparison of the mean differences in initial and final total dissolved solids concentration in two 10.16 cm (left) and two 15.24 cm (right) diverter chambers at a flow rate of 12.11 L/min	59
Figure 17. Comparison of the mean differences in initial and final total dissolved solids concentration in two 10.16 cm (left) and two 15.24 cm (right) diverter chambers at a flow rate of 22.71 L/min	60
Figure 18. Comparison of the mean differences in initial and final total dissolved solids concentration in two 10.16 cm (left) and two 15.24 cm (right) diverter chambers at a flow rate of 43.91 L/min	61
Figure 19. Comparison of the mean differences in initial and final total dissolved solids concentration in two 10.16 cm (left) and two 15.24 cm (right) diverter chambers at a flow rate of 75.71 L/min	62
Figure 20. Comparison of the mean differences in initial and final total dissolved solids concentration in two 10.16 cm (left) and two 15.24 cm (right) diverter chambers at a flow rate of 113.56 L/min	63
Figure 21. Comparison of the mean differences in initial and final total dissolved solids concentration in four downspout first flush diverters utilizing two downward oriented (left) and two upward oriented (right) sanitary tees at a flow rate of 0.76 L/min	65

	Page
Figure 22. Comparison of the mean differences in initial and final total dissolved solids concentration in four downspout first flush diverters utilizing two downward oriented (left) and two upward oriented (right) sanitary tees at a flow rate of 1.51 L/min.....	66
Figure 23. Comparison of the mean differences in initial and final total dissolved solids concentration in four downspout first flush diverters utilizing two downward oriented (left) and two upward oriented (right) sanitary tees at a flow rate of 3.03 L/min.....	67
Figure 24. Comparison of the mean differences in initial and final total dissolved solids concentration in four downspout first flush diverters utilizing two downward oriented (left) and two upward oriented (right) sanitary tees at a flow rate of 12.11 L/min.....	68
Figure 25. Comparison of the mean differences in initial and final total dissolved solids concentration in four downspout first flush diverters utilizing two downward oriented (left) and two upward oriented (right) sanitary tees at a flow rate of 22.71 L/min.....	69
Figure 26. Comparison of the mean differences in initial and final total dissolved solids concentration in four downspout first flush diverters utilizing two downward oriented (left) and two upward oriented (right) sanitary tees at a flow rate of 43.91 L/min.....	70
Figure 27. Comparison of the mean differences in initial and final total dissolved solids concentration in four downspout first flush diverters utilizing two downward oriented (left) and two upward oriented (right) sanitary tees at a flow rate of 75.71 L/min.....	71
Figure 28. Comparison of the mean differences in initial and final total dissolved solids concentration in four downspout first flush diverters utilizing two downward oriented (left) and two upward oriented (right) sanitary tees at a flow rate of 113.56 L/min.....	72
Figure 29. Comparison of the mean differences in initial and final total dissolved solids concentration in four downspout first flush diverters with a 10.16 cm diverter chamber at a flow rate of 0.76 L/min	73

	Page
Figure 30. Comparison of the mean differences in initial and final total dissolved solids concentration in four downspout first flush diverters with a 10.16 cm diverter chamber at a flow rate of 1.51 L/min	74
Figure 31. Comparison of the mean differences in initial and final total dissolved solids concentration in four downspout first flush diverters with a 10.16 cm diverter chamber at a flow rate of 3.03 L/min	75
Figure 32. Comparison of the mean differences in initial and final total dissolved solids concentration in four downspout first flush diverters with a 10.16 cm diverter chamber at a flow rate of 12.11 L/min	76
Figure 33. Comparison of the mean differences in initial and final total dissolved solids concentration in four downspout first flush diverters with a 10.16 cm diverter chamber at a flow rate of 22.71 L/min	77
Figure 34. Comparison of the mean differences in initial and final total dissolved solids concentration in four downspout first flush diverters with a 10.16 cm diverter chamber at a flow rate of 43.91 L/min	78
Figure 35. Comparison of the mean differences in initial and final total dissolved solids concentration in four downspout first flush diverters with a 10.16 cm diverter chamber at a flow rate of 75.71 L/min	79
Figure 36. Comparison of the mean differences in initial and final total dissolved solids concentration in four downspout first flush diverters with a 10.16 cm diverter chamber at a flow rate of 113.56 L/min	80

LIST OF TABLES

	Page
Table 1. Various recommended first flush diversion volumes for rainwater harvesting systems.....	11
Table 2. Sizing of gutters based on a 20.9 mm per meter slope.....	17
Table 3. Sizing roof drain, leaders, and vertical rainwater piping	18
Table 4. Diverter chamber volumes of the various downspout first flush diverter configurations	21
Table 5. Coordinates for SCS Type III curve.....	24
Table 6. SCS storm curve generated rainfall rates for various 9 hour storm events in Austin, TX and corresponding runoff flow rates to simulate the storms based on a 93 square meter catchment area.....	26
Table 7. Experimental flow rates tested in each downspout first flush diverter configuration.....	27
Table 8. Statistical model characteristics for diverter configurations A, B, D, and E	32
Table 9. Analysis of variance for diverter configurations A, B, D, and E	32
Table 10. Statistical model characteristics for diverter configurations C, D, E, and F	33
Table 11. Analysis of variance for diverter configurations C, D, E, and F.....	33
Table 12. Mean differences in initial and final total dissolved solids concentrations at various sample port locations in diverter A's diverter chamber at experimental flow rates presented with 95% confidence intervals	36
Table 13. Mean differences in initial and final total dissolved solids concentrations at various sample port locations in diverter B's diverter chamber at experimental flow rates presented with 95% confidence intervals	39

	Page
Table 14. Mean differences in initial and final total dissolved solids concentrations at various sample port locations in diverter C's diverter chamber at experimental flow rates presented with 95% confidence intervals	42
Table 15. Mean differences in initial and final total dissolved solids concentrations at various sample port locations in diverter D's diverter chamber at experimental flow rates presented with 95% confidence intervals	45
Table 16. Mean differences in initial and final total dissolved solids concentrations at various sample port locations in diverter E's diverter chamber at experimental flow rates presented with 95% confidence intervals	48
Table 17. Mean differences in initial and final total dissolved solids concentrations at various sample port locations in diverter F's diverter chamber at experimental flow rates presented with 95% confidence intervals	51
Table 18. Mean differences in initial and final total dissolved solids concentrations at various sample port locations in diverter F's diverter chamber at experimental flow rates presented with 95% confidence intervals with the diverter chamber drain open	53

INTRODUCTION

As the world population increases, the demand increases for quality drinking water. Surface and groundwater resources are being utilized faster than they can be recharged. Rainwater harvesting is an old practice that is being adopted by many nations as a viable decentralized water source. Individual rainwater harvesting systems are one of the many tools to meeting the growing water demand. Abbott (2008) stated that rainwater harvesting is an environmentally sound solution to address issues brought forth by large projects utilizing centralized water management approaches. Population growth all over the world is causing similar problems and concerns of how to supply quality water to all. This problem is demonstrated by cities like Las Vegas, Nevada, Tuscon, Arizona, and Los Angeles, California where population is growing even though water resources are scarce.

According to Kim et al. (2005), rainwater harvesting may be one of the best methods available to recovering the natural hydrologic cycle and enabling urban development to become sustainable. The harvesting of rainwater has the potential to assist in alleviating pressures on current water supplies and storm water drainage systems. Alleviation of pressure on storm water drainage systems occurs as a result of rainwater harvesting due to the fact that rain falling on the impervious surfaces is being

This thesis follows the style of *Applied Engineering in Agriculture*.

captured and utilized instead of causing immediate runoff.

Rainwater collection has the potential to impact many people in the world. In the Texas Rainwater Harvesting Evaluation Committee's report to the 80th Legislature, *Rainwater Harvesting Potential and Guidelines for Texas* (2006), it was stated that if 10% of the roof surfaces in Texas collected their rainwater, it would accumulate to approximately 38 billion gallons per year. The United States of America is behind countries such as Germany, Denmark, Japan, India, and Australia, who lead the world in the number of rainwater harvesting systems serving individual houses.

While the number of rainwater harvesting systems is growing in Texas, there is not a comprehensive set of guidelines that governs or regulates the industry or its products. The Texas Commission on Environmental Quality (TCEQ) as of January 2007 has published a set of minimum guidelines for individual rainwater harvesting systems that set a base line for design. Lye (1996) states that adoption by the general public and governing agencies of rainwater as a source of water for use in the home has been slowed due to a lack of knowledge regarding the quality of roof captured runoff.

Multiple studies around the world have indicated that chemical and microbial contamination of rooftop rainwater harvesting systems is common (Polkowska et al., 2002; Simmons et al., 2001; Magyar et al., 2007; Melidis, 2007; Lye, 2002; Evans, 2006). If individual rainwater harvesting systems in Texas are going to fall in to the private water supply category, individuals relying on rainwater for in-home use must consider the risk and assume reasonable and necessary precautions. The precautions should be enacted to ensure that the household and any visitors are protected from

contaminated water. Individuals with weak immune systems such as children, the elderly, and individuals with health problems will be at the highest risk of problems associated with contaminated water. While a healthy individual may be able to tolerate certain levels of constituents in drinking water, those with weakened immune systems will be susceptible to serious health problems related to bacteria, viruses, parasites, or chemical contaminants.

The current literature regarding the quality of rainwater harvested from rooftop surfaces is in agreement that multiple constituents have the opportunity to be present in collected rainwater. All rainwater harvesting systems are at risk for different contaminants based on location, design, construction, operation, and maintenance. While a portion of the contaminants are picked up by the rain droplets falling through the atmosphere, the majority of impurities are picked up by the rainwater from their deposition on collection surfaces.

Prior to the storage of harvested rainwater, screening and diversion are the primary techniques utilized for improving the raw water quality. Improvement in the quality of stored raw water decreases the treatment needed by the water to bring it up to potable water standards. Screening has been implemented in many locations along the collection and piping system. Screens are commonly located on gutters, downspouts, and along conveyance piping.

Diversion of a portion of the collected water away from storage is a technique used to improve harvested rainwater quality prior to storage. Diversion can occur at the downspout or along the collection piping. It has been documented that the first volume

of runoff from a storm event has the highest concentrations of contaminants as catchment and conveyances surfaces are washed by the initial flow of rainwater (Coombes et al., 2000 and Kim et al., 2005). Historically the action of diverting this first portion of runoff that has the highest concentrations was completed by manually moving the downspout from a diversion position to a location leading to storage during the rainfall event. This technique required the individual to determine when ample water was diverted and then physically move the downspout, directing water into the storage container. Today, devices that perform the same function have been designed to operate with limited interaction or automatically, with periodic maintenance. The devices that are utilized to divert water are commonly referred to as first flush diverters or roof washers. While these terms are used interchangeably in industry practice, this paper will refer to them as first flush diverters.

The first flush diverter is a device that collects the first portion of runoff from a rooftop rainwater collection system and diverts it away from the rainwater storage system. The Mid-West Plan Service Private Water Systems Handbook (1979) states that “A roof washer traps the first flow of dirty water off the roof.” The diverted water is discarded or used in applications that do not require high quality water. Currently design guidelines for first flush diverters are based on diversion volume and do not take into consideration the catchment location or the diverter type or style. The catchment location determines the type of rainfall events that the diverter will be exposed to. Rainfall events of differing intensities and patterns affect the flow of water to the diverter.

A preliminary study evaluated the effectiveness of utilizing a continuous drain to empty the diverter chamber on the downspout first flush diverter as a maintenance technique and its applicability in various rainfall conditions. The primary study evaluated the influence of flow rate, diverter chamber diameter, and diverter chamber to downspout transition fitting on the movement of contaminants within a downspout first flush diverter.

RESEARCH OBJECTIVES

The goal of this study is to understand the influence of flow rate, diverter chamber diameter, and diverter chamber to downspout transition fitting on the movement of contaminants within a downspout first flush diverter. This goal will be met by addressing the four listed research objectives.

Objective 1:

Determine, at various flow rates, the influence of diverter chamber to downspout transition fittings on the difference in initial and final TDS concentrations in the diverter chamber of a downspout first flush diverter at multiple sample ports.

Objective 2:

Determine, at various flow rates, the influence of diverter chamber diameters on the difference in initial and final TDS concentrations in the diverter chamber of a downspout first flush diverter at multiple sample ports.

Objective 3:

Evaluate, at various flow rates, the impact of utilizing a floating barrier in a downspout first flush diverter on the difference in initial and final TDS concentrations in the diverter chamber at multiple sample ports.

Objective 4:

Evaluate, at various flow rates, the influence of utilizing a drain on a downspout first flush diverter in relation to the difference in initial and final TDS concentrations in the diverter chamber at multiple sample ports.

LITERATURE REVIEW

The Mid-West Plan Service (1979) and the Draft American Rainwater Catchment Systems Association (ARCSEA) Rainwater Catchment Design and Installation Standards (2008) similarly define a first flush diverter as a device or method of diverting the first flow of water off the roof and preventing its entry to storage containers. While first flush diverters are recommended only as an additional treatment method to reduce the collection of contaminants entrained in collected rainwater (enHealth, 2004), they add an additional level of safety to protect water quality. The use of first flush diverters to improve the quality of collected water has been recommended or presented in multiple reports and guidance documents (enHealth Council, 2004; Krishna, 2005; Wade, 2003; MWPS, 1979; Ntale and Moses, 2003; MOH, 2005; Standards Australia, 2006; MOH, 2006; Branz, 2006).

Runoff Water Quality

Understanding the quality of runoff from rooftop surfaces and their potential for public health concerns reinforces the need for use of a first flush diverter as an additional level of protection. Microbial contamination and other water quality problems associated with rainwater harvesting systems are most often derived from the catchment area, conveyance system, or storage components (Lye, 1996).

Microbial and Viral Contamination

Bacterial and viral contaminants found in collected rainwater can lead to gastrointestinal, respiratory, blood infections, and stomach ulcers (Koplan et al., 1978;

Schlech, 1985; Moore, 1995; Klein, 1991). These contaminants are most likely transferred to the catchment surface as a result of contact with animals such as birds, rodents, and insects. Typical, healthy adults tend to tolerate the low levels of bacteria that are present in properly maintained rainwater harvesting systems (Lye, 1996) although the effect of these contaminants, just like others, are amplified in the very young, elderly, and those with weakened immune systems. One-hundred and twenty-five individual residential rainwater collection systems were sampled by Simmons et al. (2001) and microbial pathogens such as aeromonas, cryptosporidium, and salmonella were found in samples.

Massey University in New Zealand conducted a 5 year study of microbial roof water quality from individual homes (Abbott et al., 2008). The study collected samples from 560 homes and determined that at least half of the samples exceeded the local acceptable standards. It was also found that more than 40% of the samples were found to have heavy fecal contamination (Abbot et al., 2008). In these systems, Abbot et al. (2008) found evidence that they were poorly maintained, collected water was not properly disinfected, the conveyance and storage components were poorly designed, and in most cases, even simple measures were not taken to ensure the quality of the water. The likely sources of the problems were determined to be deposition of fecal material and dead animals and insects on the roof, in gutters, and in storage containers.

A study conducted by Abbott, et al. (2006) testing 6 different devices designed to reduce microbial contamination on 6 different tanks, concluded that a tank linked to a first flush diverter yielded very low counts of total coli-forms and *Escherichia coli*

during the study. Abbott, et al. (2006) stated that high levels of these constituents were found in the diverter. This result suggests that first flush diverters are effective in reducing microbial contamination in stored rainwater.

Chemical Contamination

Many volatile chemical and organic compounds have also been found to be present in rainwater harvesting systems across the world. Water samples from roof tops along major transportation routes inside Gdansk, Poland were taken and analyzed for petroleum hydrocarbons, volatile organohalogen compounds, and various pesticides and ions (Polkowska et al., 2002). This study revealed that more than half of the samples taken tested positive for elevated levels of the contaminants in question.

Chemical characteristics of rainwater and rainwater runoff samples in Xanthi, Greece were collected by Melidis et al. (2007). In order to get a representative sample of data, ten sites within the city were selected and sampled that represented various land uses, densities, and traffic volumes. Two years of data and 130 samples were collected. Although rooftop runoff was found to have higher chemical pollutant levels than that of the rainwater alone, Melidis et al. (2007) reported that both were below levels set forth by the Grecian drinking water guidelines.

A study performed by Simmons et al. (2001) found that 14% of 125 rural homes tested had high levels of lead in their collected rainwater that exceeded New Zealand standards for drinking water. In the same study, 1% of the sites were found to exceed zinc guidelines and 2% were found to exceed copper guidelines.

First Flush Diversion

Knowing that constituents have the possibility of being present in the collected rainwater leads to the task of addressing the concern. Kim et al. (2005) and Coombes et al. (2000) stated that the initial periods of runoff from a rainwater catchment contain the highest levels of contamination due to constituents being washed off of the roof surfaces. Due to the fact that the initial periods contain the highest levels of contamination, diverting this water can reduce the concentration of contaminants in the storage component of rainwater harvesting systems. Massey University, home to the Rooftop Water Research Center, has found that there is an increased quality of water in water tanks that utilize first flush diverters (Abbot et al., 2006). Abbot et al. (2006) utilized a first flush diverter that employed a floating ball as a barrier to prevent the diverted water from continuing to flow through the collection system.

First Flush Diversion Volume

While contaminant concentrations have been found to be reduced by first flush diverters, it is known that microbial contaminants still pass through to the storage component in concentrations that are not considered safe for potable use (Ruskin et al., 1992 and Lye, 1991). Recommendations for optimal volumes of first flush water to be diverted vary greatly. The goal for many of the diversion volumes is to divert enough water to effectively reduce contaminant loading without substantially decreasing stored water volumes. Based on current literature there are many suggestions and recommendations to properly size the volume of first flush diverters (Table 1).

Table 1. Various recommended first flush diversion volumes for rainwater harvesting systems.

First flush volume	Target criteria	Source
0.25 mm	typical household	Jenkins and Pearson, 1978
0.4-0.8 mm	100 m ²	Krishna, 2005
25 L	average size roof	EnHealth Council, 2004
20-25 L	-	WHO, 2004
2 mm	100 m ²	Wade, 2003
5 L	-	Yaziz et al., 1989
0.5-1 mm	-	Gardner et al., 2004
3.5-8.4 mm	based on target turbidities	Martinson and Thomas, 2004
5.5 mm	per m ² / 24 hour period	ARCSA, 2008

Many of the recommended diversion volumes are based on rules of thumb due to the fact that contaminant loading to a rainwater harvesting system varies based on rainfall characteristics, debris characteristics, catchment location, number of dry days, catchment area, slope, and material, as well as other site specific variables (Krishna, 2005). Evans et al. (2006) concluded that local weather and environmental conditions highly influence microbial loading and profiles to rooftop collection systems. Abbot et al. (2006) also found that bacterial loading was influenced by the orientation of catchment surfaces to prevailing winds. Evans et al. (2006) and Abbot et al. (2006) are in agreement that bacterial loading on catchment surfaces facing prevailing winds were increased.

Downspout First Flush Diverter Configurations

The types of first flush diverters utilized throughout the world vary greatly. First flush diverters are commercially available, but first flush diverters are commonly constructed from polyvinylchloride (PVC) pipe and fittings. While there is

recommendation and guidance on the volume of water to be diverted, there is not guidance on their construction or design. Further complicating the issue is the fact that first flush diverters vary in where they are positioned in the collection system. The first flush diverters can be located at the downspout or somewhere else along the collection piping before the water is stored. This research is directed at providing guidance on the configuration of a downspout first flush diverter that utilize commonly available PVC pipe for their construction to decrease the interaction of diverted water with the subsequent flow of harvested rainwater within the diverter chamber. One configuration utilizing a floating ball as a barrier to block water from interacting in the diverter chamber was utilized in the research. Figure 1 below illustrates the downspout first flush diverter being tested and its components.

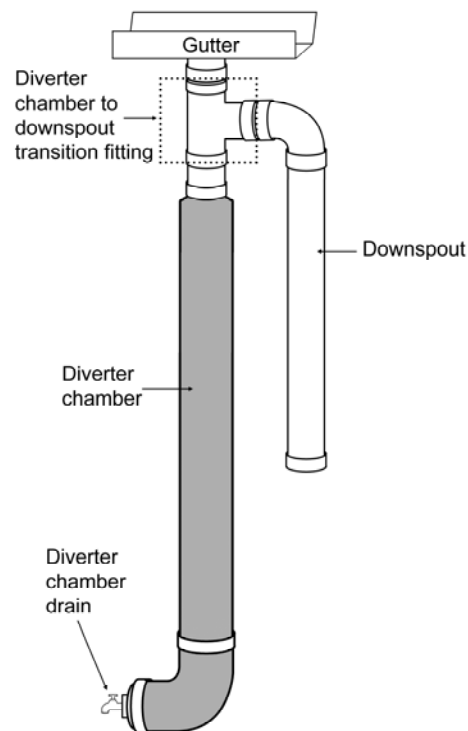

Figure 1. Diagram and basic components of a downspout first flush diverter.

Catchment Size and Rainfall Characteristics

As previously stated, the size of a catchment and rainfall characteristics play a role in determining the volume of water that the first flush diverters should divert. These variables ultimately control the flow rate of collected water interacting with first flush diverters. The catchment area contributing to the flow of water to the first flush diverter is typically known or can be altered by altering the collection and diversion system configuration. The rainfall characteristics such as frequency, volume, and intensity are highly variable based on geographic location. The Soil Conservation Service, which is now the Natural Resource Conservation Service, has developed a map of the United States that is broken down into regional categories of common storm intensity patterns (Figure 2).

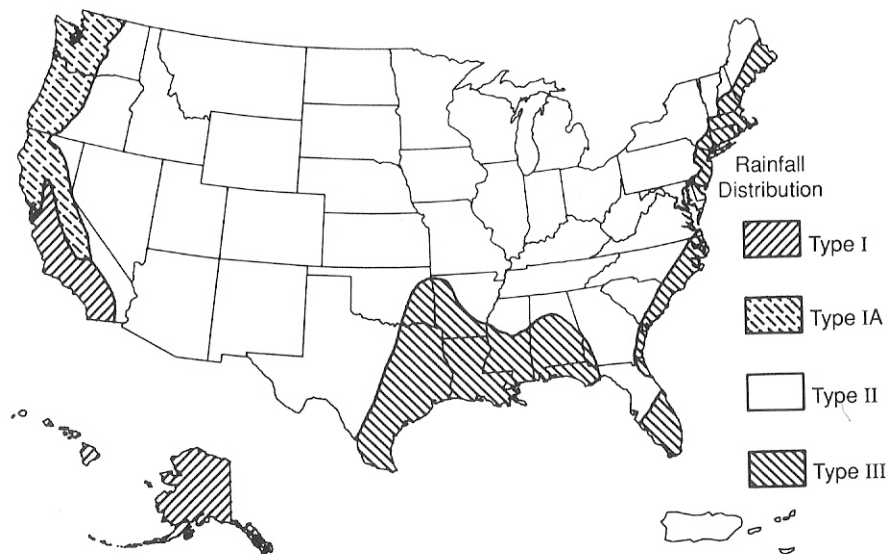

Figure 2. Applicable region for various SCS Type curves (Soil Conservation Service, 1986).

The northwestern portion of the United States is shown in Figure 2 to be of type I rainfall distribution. This designation represents the area with the least intense storm patterns. According to rainfall data collected from storm events over 25 years from 1973 to 1998 from the National Climate Data Center's (NCDC) (2009) Seattle Portage Bay, Washington data collection site, the average storm size was 1.0 centimeters (cm) with a mean storm intensity of 0.09 centimeters per hour (cph). This varies greatly from other locations such as New Orleans, Louisiana, which falls in the type III rainfall distribution category, where the 36 year average (1963-1999) for mean storm depth was 2.1 cm with a mean intensity of 0.43 cph (NCDC, 2009).

While the rainfall characteristics has been shown to affect the volume of diverted water in relation to removal of contaminants, the flow rate may also affect the ability of the diverter to function properly and keep diverted water from interacting with the subsequent flow of harvested rainwater and being transported to storage. Questions regarding the impact of flow rate in relation to diverter feasibility in variable locations are widely asked but largely undocumented. An objective of this research is to evaluate the influence of flow rate on the downspout first flush diverter's ability to retain diverted water.

Diverter Chamber Drain

In order for a first flush diverter to function, the diverter chamber must be empty at the onset of a rainfall event. The first water that flows off a catchment area during a rainfall event is diverted from storage and collected in the first flush diverter chamber. Once the diverter chamber is filled, the remaining runoff from the catchment surface is

directed through the diverter chamber to downspout transition fitting to the next step in the collection process, which is typically storage. At the end of the rainfall event, the diverter chamber must be emptied to prepare for the next rainfall event. The use of a continuous drain on a downspout first flush diverter is a maintenance technique that allows the diverted water to drain between rainfall events without human attention. This maintenance technique is recommended for first flush diverters (ARCSEA, 2008). The technique is pertinent for systems that will not receive routine maintenance after each rainfall event. An objective of this research is to evaluate the continuous drain's influence on diverter function.

METHODS AND PROCEDURES

Test Apparatus

In order to understand the influence of flow rate, diverter chamber diameter, and diverter chamber to downspout transition fitting on the movement of contaminants within a downspout first flush diverter, 3 test stands were constructed to hold the different diverters being tested (Figure 3). The experimental set up was designed to simulate actual field applications.

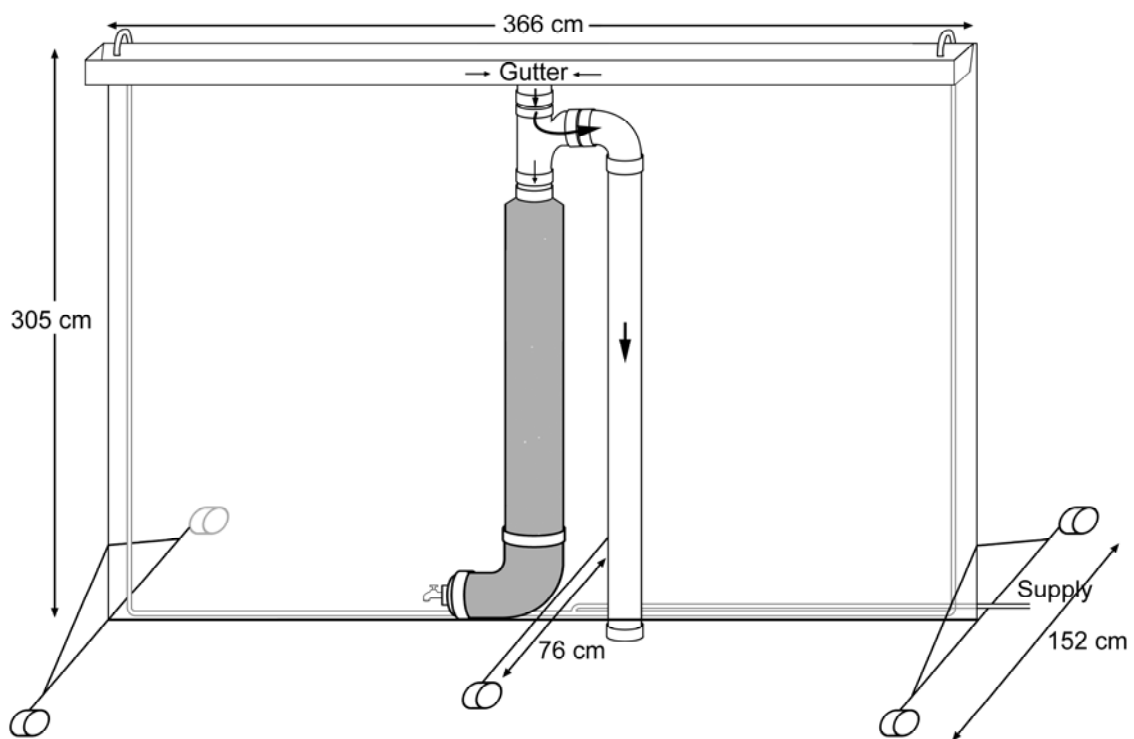

Figure 3. Downspout first flush diverter mounted on the test stand.

The frame of the stand was constructed of 3.8 cm metal square tubing. Plywood was used to cover the frame and mount the gutters and the downspout first flush diverter

assembly. Simulated rainwater flows were piped to both ends of each gutter through PVC pipe and allowed to flow freely through the gutter to the downspout first flush diverter entrance. The gutter and downspout utilized were selected due to the fact that they are commonly used in industry, and they meet gutter sizing guidelines (Table 2) and vertical rainwater piping guidelines (Table 3) set forth by the Uniform Plumbing Code (UPC) (IAPMO, 2000) for a catchment located in Austin, Texas, and the selected catchment size of 93 square meters (m²). Austin, Texas, was selected as a reference location to select system components and experimental conditions. The gutter was a 3.66 meter section of 12.7 cm wide aluminum gutter. The downspout first flush diverters were located in the center of the gutter and fabricated from 7.62, 10.16, and 15.24 cm schedule (SCH) 40 PVC pipe and fittings. Simulated rain flows through the gutters were supplied by 2.54 cm SCH 40 PVC pipe.

Table 2. Sizing of gutters based on a 20.9 mm per m slope (highlighted area denotes experiment operating range) (IAPMO, 2000).

Diameter of gutter	Maximum allowable horizontal projected roof areas (square meters) at various rainfall rates				
	50.8 mm/hr	76.2 mm/hr	101.6 mm/hr	127 mm/hr	152.4mm/hr
80	63.2	42.2	31.6	25.3	29.7
100	133.8	89.2	66.9	53.5	63.2
125	232.3	155.0	116.1	92.9	109.6
150	356.7	237.8	178.4	142.7	171.9
175	512.8	341.9	256.4	204.9	241.4
200	739.5	493.3	369.7	295.4	346.5
250	133.8	891.8	668.9	534.2	618.7

Table 3. Sizing roof drain, leaders, and vertical rainwater piping (highlighted area denotes experiment operating range) (IAPMO, 2000).

Size of drain, leader or pipe	Flow	Maximum allowable horizontal projected roof areas (square meters) at various rainfall rates					
		25 mm/hr	50 mm/hr	75 mm/hr	100 mm/hr	125 mm/hr	150 mm/hr
mm	L/s						
50	1.5	202	101	67	51	40	34
80	4.2	600	300	200	150	120	100
100	9.1	1286	643	429	321	257	214
125	16.5	2334	1117	778	583	467	389
150	26.8	3790	1895	1263	948	758	632
200	57.6	8175	4088	2725	2044	1635	1363

Notes:

1. The sizing data for vertical conductors, leaders, and drains is based on the pipes flowing 7/24 full.
2. For rainfall rates other than those listed, determine the allowable roof area by dividing the area given in the 25 mm/hour column by the desired rainfall rate.
3. Vertical piping may be round, square, or rectangular. Square pipe shall be sized to enclose its equivalent round pipe. Rectangular pipe shall have at least the same cross-sectional area as its equivalent round pipe, except that the ratio of its side dimensions shall not exceed 3 to 1.

First Flush Diverters

The downspout first flush diverter configurations were custom fabricated and are commonly used by installers. Six different configurations were tested. Four downspout first flush diverters utilized a 10.16 cm diameter diverter chamber and 2 utilized a 15.24 cm diameter diverter chamber. All diverters tested utilized 7.62 cm SCH 40 PVC for the transition fitting from the diverter chamber to the downspout, which carries water past the diverter chamber once it is full. Configurations of diverters A and D utilized an upward oriented sanitary tee for the transition fitting from the diverter chamber to the downspout (Figure 4). Diverter A utilized a 15.24 cm diameter PVC diverter chamber, and diverter D utilized a 10.16 cm diameter PVC diverter chamber.

Configurations of diverters B and E utilized a downward oriented sanitary tee as the transition fitting from the diverter chamber to the downspout (Figure 4). Diverter B utilized a 15.24 cm diameter PVC diverter chamber, and diverter E utilized a 10.16 cm diameter PVC diverter chamber.

Configurations of diverters C and F utilized a straight tee to provide the transition from the diverter to the downspout (Figure 4). Diverters C and F utilized a 10.16 cm diameter PVC diverter chamber. Diverter C was selected due to its wide use in rainwater harvesting system applications in Australia and New Zealand. Diverter C utilized a floating ball in the diverter chamber to block the diverted water from the water flowing through the transition fitting. This configuration has been used extensively in testing of first flush diverters by the Massey University Rooftop Catchment Research Center in Wellington, New Zealand.

The two 15.24 cm diameter diverters were designed to meet the ARCSA standard volume for first flush diverters. The recommendation from the Draft ARCSA Rainwater Catchment Design and Installation Standards (2008) of diverting 5.5 mm/m^2 of rainfall

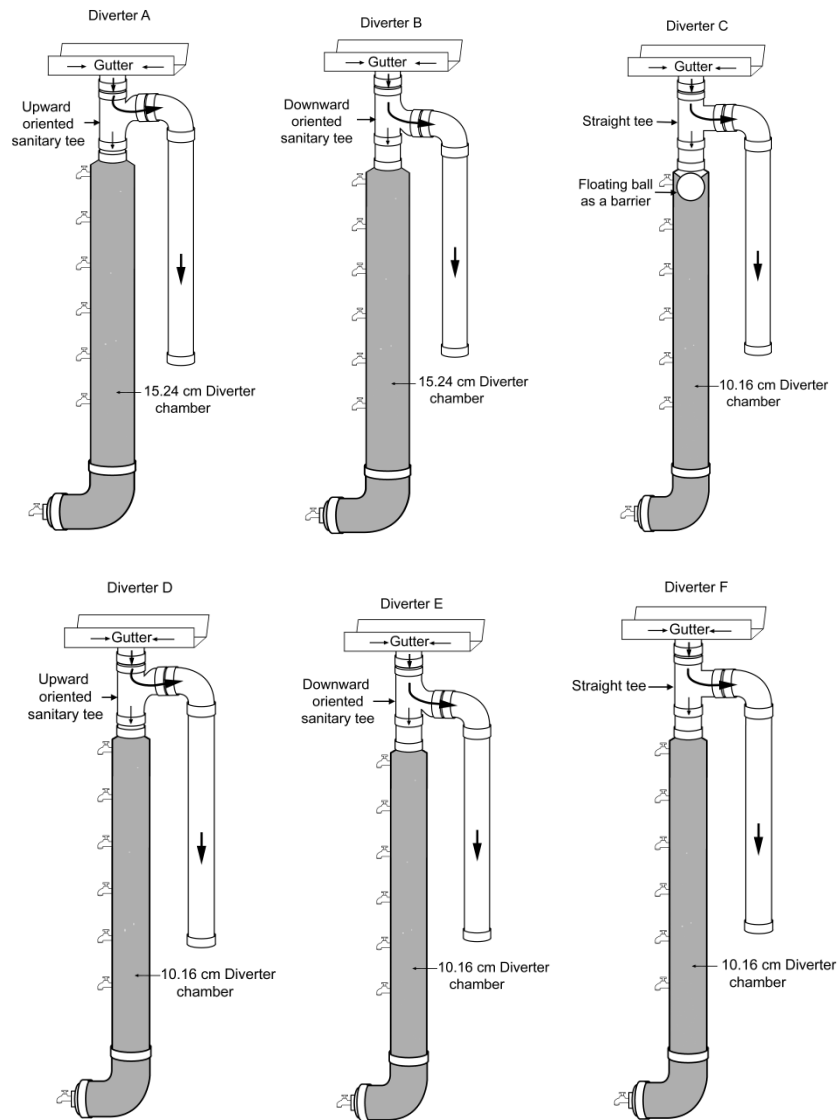

Figure 4. Six downspout first flush diverter configurations utilized for experiments.

per 24 hour rainfall period was used to determine diverter volume for the two 15.24 cm diameter diverters.

Applying this standard, a diverter capacity of 47.16 liters was targeted for the 15.24 cm diameter diverter chambers tested, based on the selection of a 93 square meter catchment area being serviced by the diverter. This volume requires that the diverter be a length of 253 cm of 15.24 cm schedule 40 PVC pipe. The 10.16 cm diameter diverters tested were also 253 cm long. The actual volumes of each diverter's diverter chamber are listed in Table 4.

Table 4. Diverter chamber volumes of the various downspout first flush diverter configurations.

Downspout first flush diverter configuration	Diverter chamber volume (L)
A	47.9
B	47.8
C	20.7
D	20.8
E	20.7
F	20.7

Each diverter chamber was fitted with 7 sampling ports oriented along the chamber's vertical axis to enable sampling of water from multiple locations on each diverter. The top 6 sampling ports were positioned in 30.5 cm increments with the first port located 30.5 cm below the diverter chamber and downspout transition fitting (Figure 5). The sampling port located at the bottom of the diverter chamber also served as the diverter chamber drain during the preliminary experiments.

While primary experiments were conducted on the downspout first flush diverters with the diverter chamber drain closed, preliminary experiments were conducted with the diverter chamber drain open. In order to ensure common drain flow rates between experiments, each diverter chamber's bottom sampling port was fitted with a removable cap that had a 4 millimeter drain hole to allow the diverter to slowly drain during the preliminary experiments to simulate draining during a rainfall event. The drain flow rate of each diverter is a function of its standing water column height. While the theoretical drain flow rates of each diverter were 3.14 liters per minute (L/min) (Equation 1), the measured flow rates were different. Measured drain flow rates were measured to be 0.98 L/min. This difference in flow rate is likely due to the additional friction encountered as the water flows through the diverter chamber drain valve.

$$q=11.79*d^2*h^{1/2}$$

Equation 1

Where: q= orifice flow rate (gpm)

 d= orifice diameter (in)

 h= head (ft)

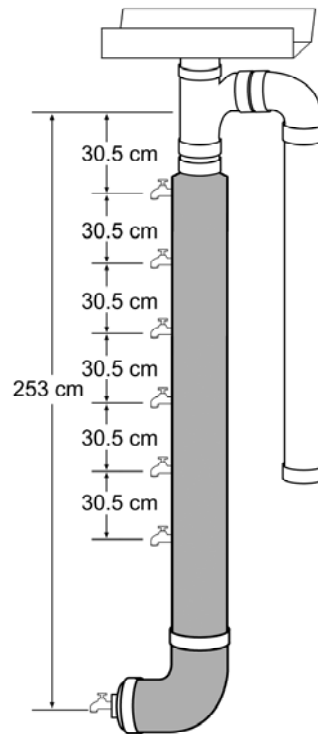

Figure 5. Diverter chamber sampling port locations relative to the diverter chamber to downspout transition fitting.

Testing Scenarios

Supply Flow Rates

Flow rates run through the first flush diverters were selected based on model storm events in Austin, Texas, using rainfall data from the NOAA's Austin Bergstrom Airport collection site. Selected flow rate ranges were determined by analyzing NOAA's National Climate Data Center (NCDC) rainfall data from storm events over 57 years from 1942 to 1999 (2009). Based on the NCDC data, the mean storm duration for Austin was 9 hours, the mean storm size is 1.8 cm, and the mean intensity of a storm event is 0.25 centimeters per hour (cph).

In order to determine reasonable flow rates from the modeled storms to be used in the experiments, representative storms were modeled according to the Soil Conservation Service (SCS) rainfall pattern method (1973). The NOAA data summary was utilized to develop four representative storms for the Austin area. The SCS rainfall pattern selection divides rainfall events into incremental time steps with varying intensities that simulate an actual storm event. Selected storm sizes to model were 2.5, 5.1, 10.2, and 20.3 cm. The incremental flows for each time step were developed based on the coordinates for the SCS type curve for a Type III curve (Table 5). The selection of a Type III curve was based on Austin's geographic location within the SCS's map of regional common storm intensity patterns (Figure 2).

Table 5. Coordinates for SCS Type III curve (Haan et al., 1994).

Time (hrs)	P/P₂₄
7.50	0.10
8.00	0.11
8.50	0.13
9.00	0.15
9.50	0.17
10.00	0.19
10.50	0.22
11.00	0.25
11.50	0.30
12.00	0.50
12.50	0.70
13.00	0.75
13.50	0.78
14.00	0.81
14.50	0.83
15.00	0.85
15.50	0.87
16.00	0.89
16.50	0.90

The ordinates of the Type III curve were multiplied by the desired 24 hour storm size to obtain an estimated rainfall depth. The differences of these depths were then obtained and divided by the time step to represent the incremental rainfall intensity for the denoted time period. Figure 6 below illustrates the cumulative SCS storm curves generated.

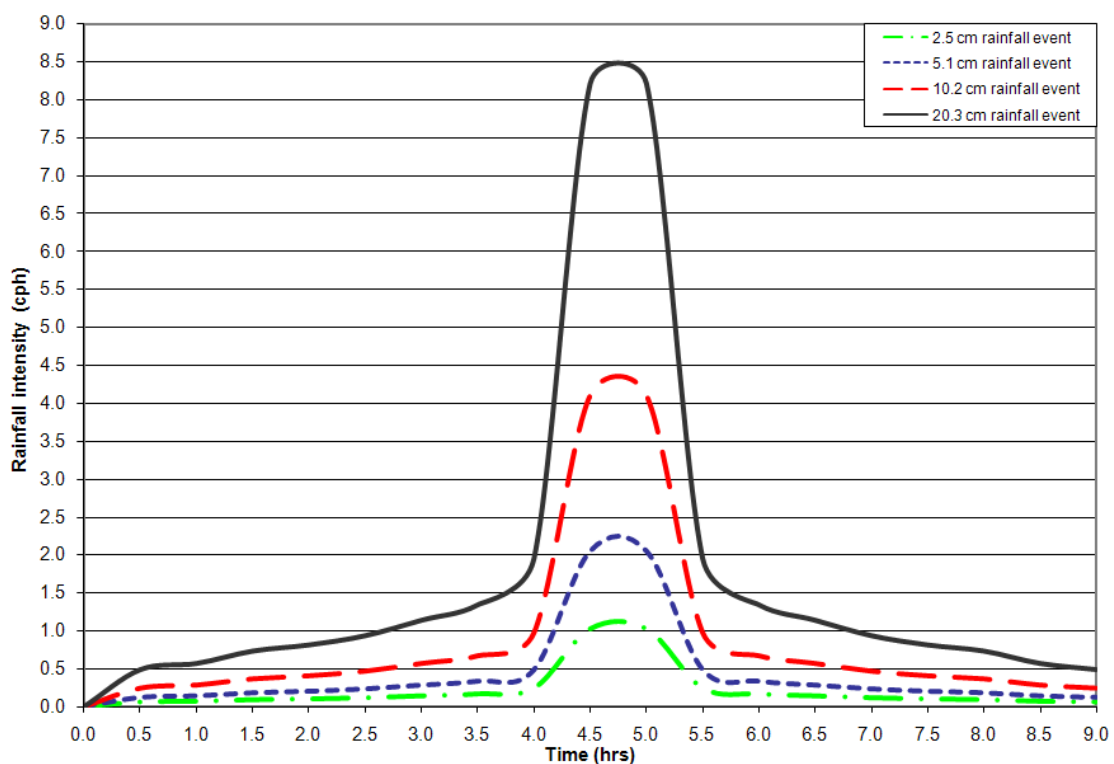

Figure 6. 2.5, 5.1, 10.2, and 20.3 cm SCS storm curve generated storm events for Austin, Texas.

The modeled storm durations were selected to be 9 hours based on the calculated mean storm duration of the Austin, Texas, data collection site. The 2.5 cm storm event was selected due to the fact that the 9 hour SCS simulation of this event produces 2 cm

of runoff, which is near the mean storm depth of 1.8 cm. The 10.2 and 20.3 cm storm events were selected due to the fact that respectively, they are the 2- and 25-year 24 hour rainfall storm events for Austin. Time steps in the storm were selected to be 30 minutes. Simulated rainfall rates and their corresponding runoff flow rates from the storm events on a 93 square meter catchment area are detailed in Table 6.

Table 6. SCS Storm Curve generated rainfall rates for various 9 hour storm events in Austin, TX and corresponding runoff flow rates to simulate the storms based on a 93 square meter catchment area.

Storm event time	2.5 cm storm event flow rate		5.1 cm storm event flow rate		10.2 cm storm event flow rate		20.3 cm storm event flow rate	
	(hrs)	(cm/hr)	(L/min)	(cm/hr)	(L/min)	(cm/hr)	(L/min)	(cm/hr)
0.0	0.0	0.0	0.0	0.0	0.0	0.0	0.0	0.0
0.5	0.1	0.9	0.1	1.9	0.2	3.8	0.5	7.5
1.0	0.1	1.1	0.1	2.2	0.3	4.4	0.6	8.8
1.5	0.1	1.4	0.2	2.8	0.4	5.7	0.7	11.3
2.0	0.1	1.6	0.2	3.1	0.4	6.3	0.8	12.6
2.5	0.1	1.8	0.2	3.6	0.5	7.2	0.9	14.5
3.0	0.1	2.2	0.3	4.4	0.6	8.8	1.1	17.6
3.5	0.2	2.6	0.3	5.2	0.7	10.4	1.3	20.8
4.0	0.2	3.8	0.5	7.5	1.0	15.1	2.0	30.2
4.5	1.0	15.9	2.1	31.8	4.1	63.5	8.2	127.0
5.0	1.0	15.9	2.1	31.8	4.1	63.5	8.2	127.0
5.5	0.2	3.8	0.5	7.5	1.0	15.1	2.0	30.2
6.0	0.2	2.6	0.3	5.2	0.7	10.4	1.3	20.8
6.5	0.1	2.2	0.3	4.4	0.6	8.8	1.1	17.6
7.0	0.1	1.8	0.2	3.6	0.5	7.2	0.9	14.5
7.5	0.1	1.6	0.2	3.1	0.4	6.3	0.8	12.6
8.0	0.1	1.4	0.2	2.8	0.4	5.7	0.7	11.3
8.5	0.1	1.1	0.1	2.2	0.3	4.4	0.6	8.8
9.0	0.1	0.9	0.1	1.9	0.2	3.8	0.5	7.5

In order to effectively represent the range of flows generated from the storms, test flow rates ranged from 0.76 to 113.56 liters per minute (L/min) (Table 7). While the

flow rates were selected to represent the simulated storm events on the selected catchment area of 93 square meters, the data and results obtained in this study from these flow rates can be utilized for other storm events and catchment sizes. Due to the fact that testing was based on flow rates, collected data at the flow rates can be equated to various rainfall rates and catchment area sizes. For example, the 0.76 L/min flow rate comparable to both a rainfall rate of 0.5 cph on a catchment area of 93 square meters and a rainfall rate of 1.0 cph on a catchment area of 46.5 square meters.

Table 7. Experimental flow rates tested in each downspout first flush diverter configuration.

Flow rates (L/min)
0.76
1.51
3.03
12.11
22.71
43.91
75.71
113.56

Downspout First Flush Diverter Testing Configurations

Results from the comparison of the diverter configurations with differing diverter to downspout transition fittings will be utilized to address the first objective. That objective is to determine, at the various flow rates, the effect of the diverter chamber to downspout transition fitting on the change in total dissolved solids (TDS) in the diverter chamber at multiple sample ports.

Results collected based on comparison of the diverter configurations with differing diverter chamber diameters will be utilized to address the second objective. That objective is to determine, at various flow rates, the effect of diverter chamber diameter on the change in TDS in the diverter chamber of a downspout first flush diverter at multiple sample locations.

Results collected based on comparison of the diverter configuration utilizing a floating ball in the diverter chamber as a barrier to other diverter configurations without the floating ball were utilized to address the third objective. That objective is to evaluate, at various flow rates the impact of utilizing a floating ball as a barrier in the diverter chamber of a downspout first flush diverter on the interaction of diverted water with the subsequent flow of collected water.

The downspout first flush diverters were tested with the diverter chamber drain open and closed. The collection and analysis of the preliminary data aided in addressing the fourth objective of this research, the impact of utilizing a drain on a downspout first flush diverter in relation to the change in TDS in the diverter chamber.

While each experimental flow rates was tested on each diverter with the drain valve closed, all flow rates, except for 0.76 L/min, were run during preliminary experiments with the drain valve open. The 0.76 L/min flow rate was omitted due to the fact that the diverter chamber drain flow rate was greater than this resulting in no flow through the downspout.

Flow Control and Testing Equipment

In order to provide the needed flow of water for the experiments, two different pumps were used to produce the range of flow rates necessary. Pump A, a SHURflo Power Twin Model #4111-035, was used to produce flows ranging from 0.76 to 43.91 L/min. Pump B, a 5.1 cm Banjo self priming pump powered by a Briggs and Stratton 6 horsepower engine, mounted on a 3,785 liter water trailer was used to produce flows of 75.71 and 113.65 L/min. Flow rates were controlled and adjusted by brass gate valves. An 11,356 liter fiberglass tank was utilized to supply sufficient water to pump A and a 3,785 liter fiberglass tank mounted on a trailer was utilized to supply pump B. During experiments with the lower range of flow rates that utilized pump A, up to 3 pumps were utilized to supply 3 experiments concurrently. During experiments at the larger flow rates that utilized pump B, only 1 experiment was conducted at a time to allow an adequate supply of water in the tank to be maintained. Flow rates were measured by 2 different flow meters to accurately measure the wide range of flows in the experiment. Flow meter A, an Omega FPR 303 low flow meter with an Omega DPF701 controller, was utilized to monitor flow rates ranging from 0.76 to 43.91 L/min. This flow meter has an accuracy of $\pm 1\%$ of the meter reading. Flow meter B, a GPI Industrial turbine meter Model 10, was utilized to monitor flows from 75.71 to 113.56 L/min. This flow meter has an accuracy of $\pm 1.5\%$ of the meter reading.

An Omega Model CDH-287 conductivity meter along with a CDE-5001-GD1 glass dip probe (K=1.0) with an ATC sensor was utilized in collecting electrical

conductivity, total dissolved solids, saline concentration, and temperature of each sample. This meter's TDS accuracy was rated at $\pm 0.3\%$ of the meter reading.

Sampling Protocol

The purpose of the experiment was to evaluate the influence of flow rate, diverter chamber diameter, and transition fitting on the movement of contaminants within a downspout first flush diverter. In order to do so, prior to the start of each experiment, the diverter chamber of each downspout first flush diverter was filled with a known concentrated solution of saline water. The saline water solution was produced by mixing table salt (sodium chloride) into tap water at a rate to achieve a total dissolved solids (TDS) level of approximately 29.3 grams per liter. Tap water was utilized during the experiment to simulate rain flows. The tap water had a TDS level of 0.6-0.8 grams per liter throughout the experiment. Once the experiment was run, the difference in the initial and final TDS concentration in the diverter chambers was recorded at 7 different sampling ports oriented vertically along the length of the diverter chamber. Experiments were replicated three times to account for variability in the collected data. The initial TDS concentrations are denoted by collection at time equals 0 minutes and final TDS concentrations are denoted by collection at time equals 30 minutes. The differences in the initial and final TDS concentration values collected at each sampling port were used to give insight to the mixing regime within each diverter.

ANALYSIS AND RESULTS

Statistical Analysis

Analysis of Variance

The differences in initial and final TDS concentrations determined at each sample port, of each experiment, were used to determine the decrease in TDS due to the various treatments and variations of downspout first flush diverters. Experiments were replicated 3 times to account for variation in the collected data. In order to facilitate comparison of collected data, two separate general linear models were developed. The SAS Version 9.2 statistical package was utilized in the development of the general linear models.

The first general linear model was developed for diverter configurations A, B, D, and E. This model was constructed to analyze the influence of flow rate, diverter chamber diameter, diverter chamber to downspout transition fitting, and port location, which is nested within the other classes, on the difference between initial and final TDS concentrations at each sample port. The transition fitting values were an upward and downward oriented sanitary tee. The diverter chamber diameter values were 10.16 and 15.24 cm. The flow rate values were 0.76, 1.51, 3.03, 12.11, 22.71, 43.91, 75.71, and 113.56 L/min. The sampling port locations were ports 1 through 7. There were three replications for each experiment. The general linear model for comparing downspout diverter configurations A, B, D, and E had an R-square value of 0.937. Table 8 below details the statistical model characteristics.

Table 8. Statistical model characteristics for diverter configurations A, B, D, and E.

Source	Degrees of freedom	Sum of squares	Mean square	F-value	Pr > F
Model	223	39754	178.3	29.8	<0.0001
Error	448	2681	6.0		
Corrected total	671	42435			

The analysis of variance (ANOVA) table for the first general linear model is summarized in Table 9 below. Due to the significance of the most complex source interactions, the only conclusion that can be made is that all the variables vary together.

Table 9. Analysis of variance for diverter configurations A, B, D, and E.

Source*	Degrees of freedom	Type I sum of squares	Mean square	F-value	Pr > F
T	1	6.4	6.4	1.1	0.3016
D	1	1.1	1.1	0.2	0.6637
T x D	1	83.0	83.0	13.9	0.0002
F	7	4040.4	577.2	96.4	<0.0001
T x F	7	162.9	23.3	3.9	0.0004
D x F	7	453.7	64.8	10.8	<0.0001
T x D x F	7	749.0	107.0	17.9	<0.0001
L (T x D x F)	192	34257.6	178.4	29.8	<0.0001

*T= Transition fitting, D= Diverter chamber diameter, F= Flow rate, L= Sample port location

The second general linear model was developed for diverter configurations C, D, E, and F. This model was constructed to analyze the influence of flow rate, diverter chamber to downspout transition fitting, and port location, which is nested within the other classes, on the difference between initial and final TDS concentrations at each sample port. The transition fitting values were an upward and downward oriented

sanitary tee, a straight tee, and a straight tee that utilized a floating ball as a barrier in the diverter chamber. The flow rate values were 0.76, 1.51, 3.03, 12.11, 22.71, 43.91, 75.71, and 113.56 L/min. The sampling port locations were ports 1 through 7. There were three replications for each experiment. The general linear model for comparing downspout diverter configurations C, D, E, and F had an R-square value of 0.945. Table 10 below details the statistical model characteristics.

Table 10. Statistical model characteristics for diverter configurations C, D, E, and F.

Source	Degrees of freedom	Sum of squares	Mean square	F-value	Pr > F
Model	223	3295	144.8	34.4	<0.0001
Error	448	1886	4.2		
Corrected total	671	34181			

The ANOVA table for the second general linear model is summarized in Table 11 below. Due to the significance of the most complex source interactions, the only conclusion that can be made is that all the variables vary together.

Table 11. Analysis of variance for diverter configurations C, D, E, and F.

Source*	Degrees of freedom	Type I sum of squares	Mean square	F-value	Pr > F
T	3	1083.0	361.0	85.8	<0.0001
F	7	2421.0	345.9	82.2	<0.0001
T x F	21	945.9	45.0	10.7	<0.0001
L (T x F)	192	27845.1	145.0	34.5	<0.0001

*T= Transition fitting, F= Flow rate, L= Sample port location

Confidence Intervals

The differences between the initial and final TDS concentrations from each replicate experiment were averaged to acquire the mean decrease for each experimental port location. Once the mean and standard deviation of each experiment's decrease in TDS was determined, the 95% confidence interval (C.I.) of the decreases was calculated according to equation 2.

$$C.I. = \bar{X} \pm t_{\alpha/2, n-1} \times \frac{s}{\sqrt{n}} \quad \text{Equation 2}$$

Where: \bar{X} = mean of sample

s = sample standard deviation

n = sample size

$$t_{\alpha/2, n-1} = 4.303$$

$$\alpha = 0.05$$

$$n = 3$$

The mean decrease in TDS at each sample port and its associated 95% confidence intervals are presented for each diverter, flow rate, and sampling port location. The confidence interval determination utilized is designed for small sample tests assuming a normal distribution. Diverter relationships between TDS and sampling port location on the diverter chamber, at various flow rates, were determined and are presented below.

Diverter A

Diverter A utilized a 15.24 cm PVC diverter chamber and a 7.62 cm upward oriented sanitary tee as the transition fitting from the diverter chamber to the downspout. This configuration with the diverter chamber drain closed displayed larger mean differences in initial and final TDS in the diverter chamber as flow rate increased (Figure 7). A large mean difference in the initial and final TDS did not occur until the 22.7 L/min flow rate. These differences in TDS only appeared in the upper sampling ports.

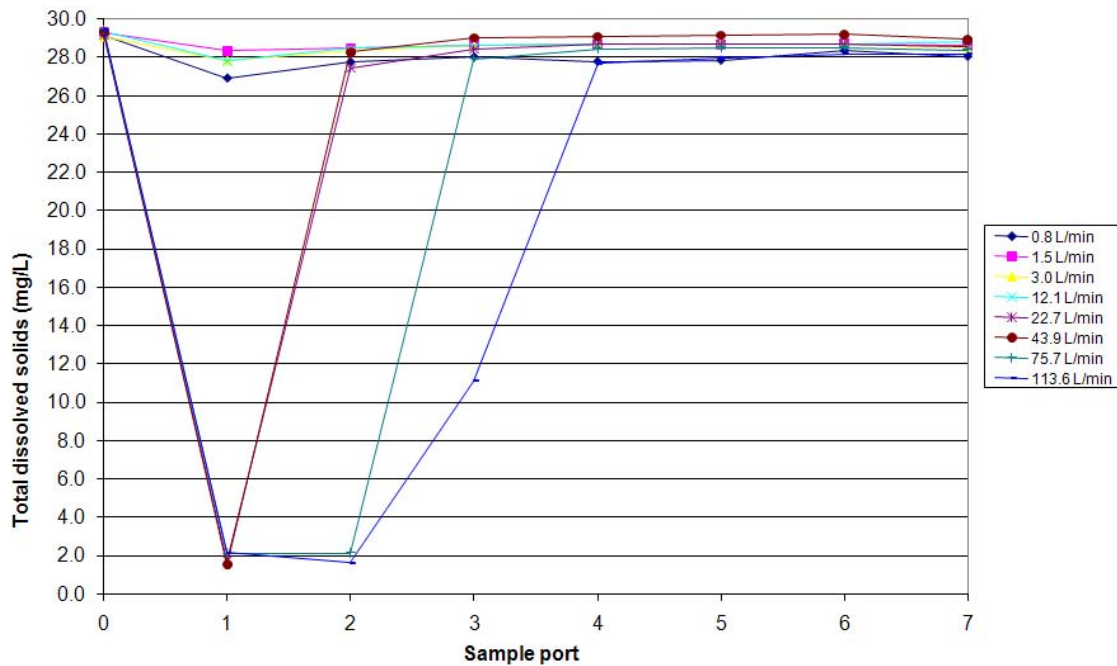

Figure 7. Diverter A's relationship between the mean total dissolved solids concentration and location of sampling ports in the diverter chamber at various flow rates with a closed diverter chamber drain.

The numerical values for diverter A's mean difference in initial and final TDS concentrations at various flow rates, along with each set's 95% confidence interval about the mean, are presented in Table 12 below.

Table 12. Mean differences in initial and final total dissolved solids concentrations at various sample port locations in diverter A's diverter chamber at experimental flow rates presented with 95% confidence intervals.

Flow rate (L/min)	Sample port	n	Mean TDS difference (g/L)	Lower limit (g/L)	Upper limit (g/L)	Average initial TDS (g/L)
0.76	1	3	2.3	0*	7.7	29.2
	2	3	1.4	0*	4.8	29.2
	3	3	1.2	0*	2.9	29.2
	4	3	1.4	0*	3.4	29.2
	5	3	1.3	0*	3.3	29.2
	6	3	0.8	0*	1.9	29.2
	7	3	1.1	0.3	2.0	29.2
1.51	1	3	1.0	0*	2.1	29.3
	2	3	0.8	0*	2.1	29.3
	3	3	0.7	0*	1.6	29.3
	4	3	0.6	0.1	1.2	29.3
	5	3	0.6	0.1	1.2	29.3
	6	3	0.6	0.1	1.1	29.3
	7	3	0.7	0*	1.4	29.3
3.03	1	3	1.3	0	2.5	29.1
	2	3	0.7	0*	1.5	29.1
	3	3	0.5	0*	1.4	29.1
	4	3	0.4	0*	1.3	29.1
	5	3	0.4	0*	1.1	29.1
	6	3	0.4	0*	1.1	29.1
	7	3	0.6	0.4	0.8	29.1
12.11	1	3	1.5	0*	4.3	29.3
	2	3	0.9	0.4	1.4	29.3
	3	3	0.8	0.6	0.9	29.3
	4	3	0.7	0.5	0.8	29.3
	5	3	0.7	0.7	0.7	29.3
	6	3	0.7	0.5	0.8	29.3
	7	3	0.5	0*	1.3	29.3
22.71	1	3	27.5	26.9	28.1	29.2
	2	3	1.8	1.5	2.1	29.2
	3	3	0.8	0.4	1.1	29.2
	4	3	0.5	0*	1.3	29.2

Table 12. Continued.

Flow rate (L/min)	Sample port	n	Mean TDS difference (g/L)	Lower limit (g/L)	Upper limit (g/L)	Average initial TDS (g/L)
22.71	5	3	0.5	0*	1.2	29.2
	6	3	0.5	0*	1.4	29.2
	7	3	0.6	0*	1.6	29.2
43.91	1	3	27.8	27.5	28.2	29.3
	2	3	1.1	0.4	1.7	29.3
	3	3	0.3	0*	1.0	29.3
	4	3	0.2	0*	1.2	29.3
	5	3	0.2	0*	0.9	29.3
	6	3	0.1	0*	0.9	29.3
	7	3	0.4	0*	1.7	29.3
75.71	1	3	27.3	26.5	28.2	29.4
	2	3	27.3	26.2	28.4	29.4
	3	3	1.5	0.4	2.6	29.4
	4	3	1.0	0.3	1.7	29.4
	5	3	0.9	0.4	1.5	29.4
	6	3	0.9	0.4	1.4	29.4
	7	3	1.0	0.7	1.4	29.4
113.56	1	3	27.3	26.2	28.3	29.4
	2	3	27.8	27.8	27.8	29.4
	3	3	18.3	0*	53.3	29.4
	4	3	1.7	0.2	3.3	29.4
	5	3	1.4	0.2	2.7	29.4
	6	3	1.3	0.1	2.4	29.4
	7	3	1.3	0.4	2.1	29.4

*Denotes statistical values that extended beyond the physical limitations of the system that were truncated to fit within the systems physical dimensions.

Diverter B

Diverter B utilized a 15.24 cm diameter PVC diverter chamber and a 7.62 cm downward oriented sanitary tee as the transition fitting from the diverter chamber to the downspout. This configuration with the diverter chamber drain closed displayed similar

mean differences in initial and final TDS concentration in the diverter chamber at all sample ports at flow rates of 12.11 L/min and below (Figure 8). A large mean difference in the initial and final TDS did not occur until the 22.7 L/min flow rate. These differences in TDS only appeared in the upper sampling ports.

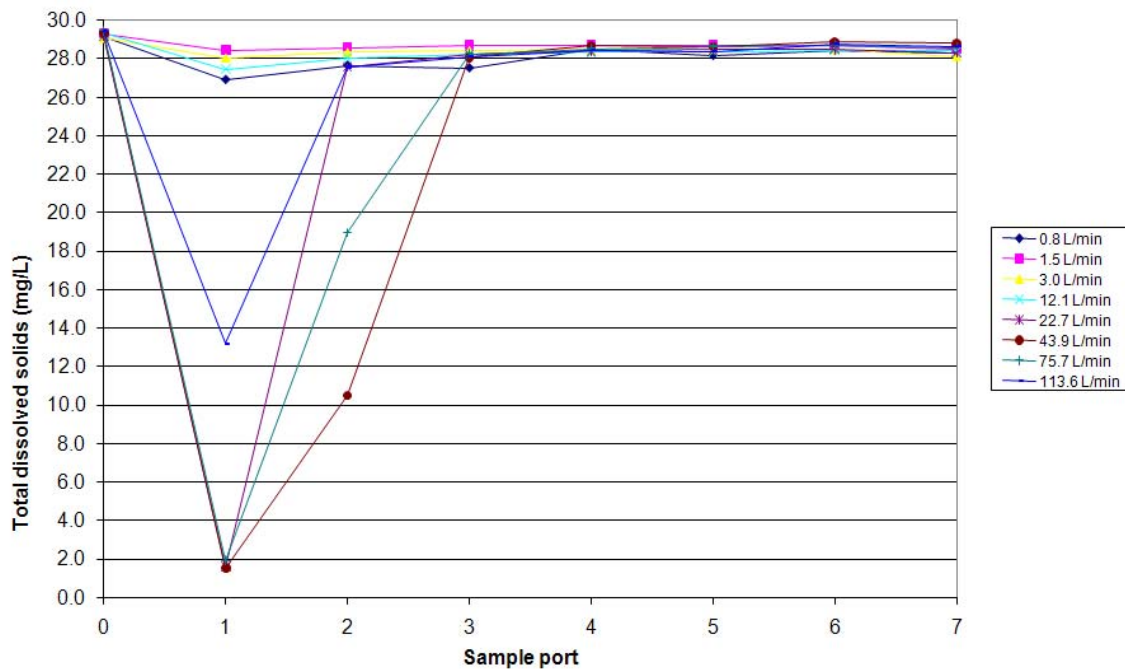

Figure 8. Diverter B's relationship between the mean total dissolved solids concentration and location of sampling ports in the diverter chamber at various flow rates with a closed diverter chamber drain.

The numerical values for diverter B's mean difference in initial and final TDS concentrations at various flow rates, along with each set's 95% confidence interval about the mean, are presented in Table 13 below.

Table 13. Mean differences in initial and final total dissolved solids concentrations at various sample port locations in diverter B's diverter chamber at experimental flow rates presented with 95% confidence intervals.

Flow rate (L/min)	Sample port	n	Mean TDS difference (g/L)	Lower limit (g/L)	Upper limit (g/L)	Average initial TDS (g/L)
0.76	1	3	2.2	0.8	3.7	29.2
	2	3	1.5	0*	3.0	29.2
	3	3	1.6	1.1	2.2	29.2
	4	3	0.7	0.4	1.0	29.2
	5	3	1.0	0*	2.8	29.2
	6	3	0.7	0.1	1.4	29.2
	7	3	0.8	0.7	1.0	29.2
1.51	1	3	0.9	0.6	1.2	29.3
	2	3	0.7	0.5	0.9	29.3
	3	3	0.6	0*	1.3	29.3
	4	3	0.6	0.1	1.1	29.3
	5	3	0.6	0.0	1.1	29.3
	6	3	0.6	0.0	1.1	29.3
	7	3	0.8	0.3	1.4	29.3
3.03	1	3	1.1	0.0	2.1	29.1
	2	3	0.8	0*	1.6	29.1
	3	3	0.7	0.0	1.3	29.1
	4	3	0.6	0.0	1.3	29.1
	5	3	0.6	0.2	1.0	29.1
	6	3	0.6	0*	1.3	29.1
	7	3	1.0	0.2	1.7	29.1
12.11	1	3	1.9	0*	4.0	29.3
	2	3	1.3	0.4	2.2	29.3
	3	3	1.1	0.9	1.3	29.3
	4	3	1.0	0.8	1.2	29.3
	5	3	1.0	0.6	1.3	29.3
	6	3	0.9	0.7	1.1	29.3
	7	3	0.9	0.6	1.2	29.3
22.71	1	3	27.6	27.1	28.1	29.2
	2	3	1.6	1.3	2.0	29.2
	3	3	1.0	0.6	1.3	29.2
	4	3	0.8	0.6	1.0	29.2

Table 13. Continued.

Flow rate (L/min)	Sample port	n	Mean TDS difference (g/L)	Lower limit (g/L)	Upper limit (g/L)	Average initial TDS (g/L)
22.71	5	3	0.7	0.6	0.9	29.2
	6	3	0.7	0.7	0.7	29.2
	7	3	0.9	0.4	1.4	29.2
43.91	1	3	27.8	27.5	28.2	29.3
	2	3	18.9	0*	55.5	29.3
	3	3	1.3	0.5	2.0	29.3
	4	3	0.7	0.0	1.3	29.3
	5	3	0.7	0.3	1.1	29.3
	6	3	0.5	0.1	0.8	29.3
	7	3	0.5	0*	1.2	29.3
75.71	1	3	27.5	27	28.0	29.4
	2	3	10.5	0*	48.1	29.4
	3	3	1.2	0*	2.5	29.4
	4	3	0.9	0.2	1.6	29.4
	5	3	0.8	0.1	1.4	29.4
	6	3	0.7	0.1	1.4	29.4
	7	3	0.9	0.7	1.0	29.4
113.56	1	3	16.2	3.4	29.1	29.4
	2	3	1.9	0.7	3.0	29.4
	3	3	1.3	0.6	2.0	29.4
	4	3	1.0	0*	2.2	29.4
	5	3	1.0	0*	2.6	29.4
	6	3	0.6	0*	2.2	29.4
	7	3	0.8	0*	2.8	29.4

*Denotes statistical values that extended beyond the physical limitations of the system that were truncated to fit within the systems physical dimensions.

Diverter C

Diverter C utilized a 10.16 cm diameter PVC diverter chamber and a straight 7.62 cm tee as the transition fitting from the diverter chamber to downspout. This diverter chamber also had a floating ball that floated to the top of the diverter chamber

when full to block the diverted water from the water that continued to flow through the downspout. This configuration with the diverter chamber drain closed displayed virtually no mean difference in initial and final TDS concentration throughout the range of flow rates tested at all sample ports (Figure 9). The 22.7 L/min flow rate set had one test that resulted in a slight difference in initial and final TDS concentration in the diverter chamber, although this only occurred in one replication at one flow rate. All other tests in that set and all other flow rates did not display large mean differences in initial and final TDS concentrations in the diverter chamber at any sample port.

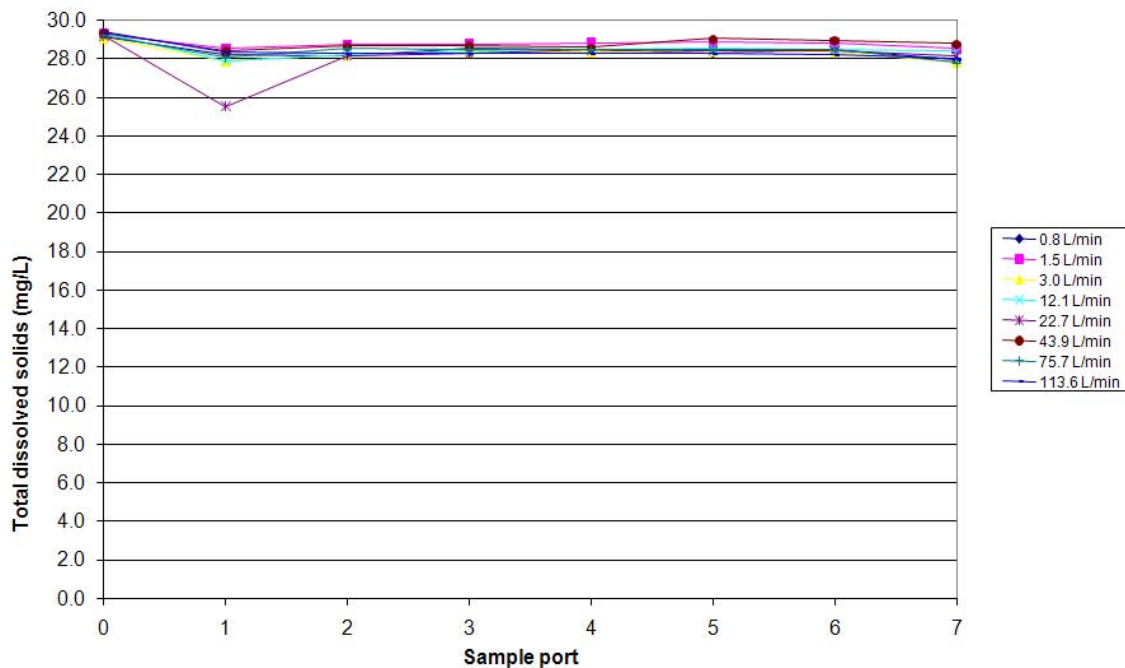

Figure 9. Diverter C's relationship between the mean total dissolved solids concentration and location of sampling ports in the diverter chamber at various flow rates with a closed diverter chamber drain.

The numerical values for diverter C's mean difference in initial and final TDS

concentrations at various flow rates, along with each set's 95% confidence interval about the mean, are presented in Table 14 below.

Table 14. Mean differences in initial and final total dissolved solids concentrations at various sample port locations in diverter C's diverter chamber at experimental flow rates presented with 95% confidence intervals.

Flow rate (L/min)	Sample port	n	Mean TDS difference (g/L)	Lower limit (g/L)	Upper limit (g/L)	Average initial TDS (g/L)
0.76	1	3	0.9	0.4	1.5	29.2
	2	3	1.0	0*	3.2	29.2
	3	3	0.6	0*	1.3	29.2
	4	3	0.7	0.5	0.9	29.2
	5	3	0.9	0*	2.5	29.2
	6	3	0.7	0.5	0.8	29.2
	7	3	1.2	0.4	2.1	29.2
1.51	1	3	0.7	0.2	1.3	29.3
	2	3	0.6	0.2	0.9	29.3
	3	3	0.5	0.0	1.1	29.3
	4	3	0.5	0.1	0.8	29.3
	5	3	0.4	0.1	0.8	29.3
	6	3	0.5	0*	1.0	29.3
	7	3	0.8	0*	1.9	29.3
3.03	1	3	1.2	0*	2.6	29.1
	2	3	0.9	0.0	1.8	29.1
	3	3	0.7	0*	1.6	29.1
	4	3	0.7	0*	1.5	29.1
	5	3	0.7	0*	1.6	29.1
	6	3	0.7	0*	1.5	29.1
	7	3	1.3	0.4	2.2	29.1
12.11	1	3	1.4	0.2	2.7	29.3
	2	3	1.1	0.6	1.6	29.3
	3	3	0.9	0.4	1.5	29.3
	4	3	0.8	0.5	1.2	29.3
	5	3	0.8	0.6	1.0	29.3
	6	3	0.8	0.7	1.0	29.3

Table 14. Continued.

Flow rate (L/min)	Sample port	n	Mean TDS difference (g/L)	Lower limit (g/L)	Upper limit (g/L)	Average initial TDS (g/L)
12.11	7	3	0.9	0.8	1.1	29.3
22.71	1	3	3.7	0*	15.1	29.2
	2	3	1.0	0.4	1.7	29.2
	3	3	0.9	0.6	1.3	29.2
	4	3	0.7	0.2	1.3	29.2
	5	3	0.8	0.2	1.3	29.2
	6	3	0.8	0.2	1.3	29.2
	7	3	1.0	0.2	1.8	29.2
43.91	1	3	0.9	0*	2.8	29.3
	2	3	0.7	0*	2.3	29.3
	3	3	0.7	0*	1.8	29.3
	4	3	0.8	0*	2.5	29.3
	5	3	0.3	0*	1.2	29.3
	6	3	0.4	0*	1.1	29.3
	7	3	0.6	0*	1.9	29.3
75.71	1	3	1.1	0*	2.6	29.2
	2	3	0.7	0.3	1.1	29.2
	3	3	0.7	0.4	1.1	29.2
	4	3	0.8	0.2	1.3	29.2
	5	3	0.7	0.1	1.4	29.2
	6	3	0.8	0.2	1.3	29.2
	7	3	1.4	1.2	1.6	29.2
113.56	1	3	1.1	0.1	2.0	29.4
	2	3	1.1	0.0	2.2	29.4
	3	3	1.1	0.0	2.2	29.4
	4	3	1.1	0*	2.4	29.4
	5	3	1.1	0*	2.6	29.4
	6	3	1.2	0*	2.7	29.4
	7	3	1.4	0*	2.7	29.4

*Denotes statistical values that extended beyond the physical limitations of the system that were truncated to fit within the systems physical dimensions.

Diverter D

Diverter D utilized a 10.16 cm diameter PVC diverter chamber and a 7.62 cm upward oriented sanitary tee as the transition fitting from the diverter chamber to the downspout. This configuration with the diverter chamber drain closed displayed large mean differences in initial and final TDS concentrations at flow rates of 12.1, 43.9, 75.7, and 113.6 L/min (Figure 10). Only small mean differences in initial and final TDS concentrations were observed at flow rates of 3.03 L/min and less. Sample ports 3 through 7 displayed small mean differences in initial and final TDS concentrations at all flow rates tested.

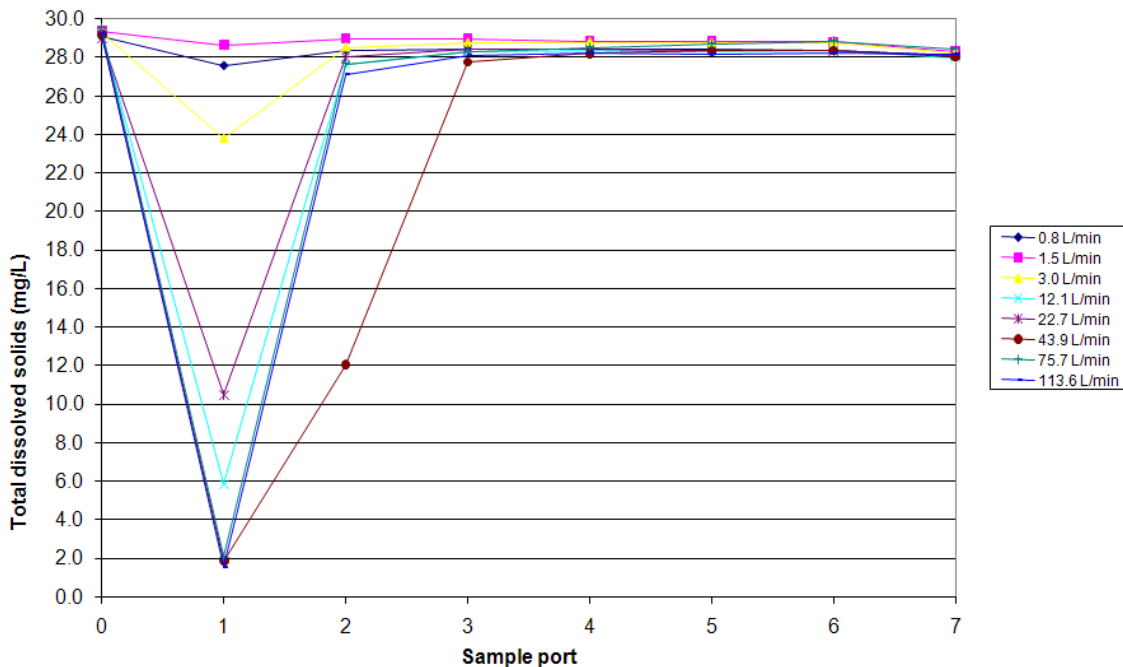

Figure 10. Diverter D's relationship between the mean total dissolved solids concentration and location of sampling ports in the diverter chamber at various flow rates with a closed diverter drain.

The numerical values for diverter D's mean difference in initial and final TDS

concentrations at various flow rates, along with each set's 95% confidence interval about the mean, are presented in Table 15 below.

Table 15. Mean differences in initial and final total dissolved solids concentrations at various sample port locations in diverter D's diverter chamber at experimental flow rates presented with 95% confidence intervals.

Flow rate (L/min)	Sample port	n	Mean TDS difference (g/L)	Lower limit (g/L)	Upper limit (g/L)	Average initial TDS (g/L)
0.76	1	3	1.5	0.8	2.2	29.1
	2	3	0.7	0.5	0.9	29.1
	3	3	0.6	0.3	0.9	29.1
	4	3	0.7	0.5	0.8	29.1
	5	3	0.6	0.3	0.9	29.1
	6	3	0.7	0.5	0.9	29.1
	7	3	1.0	0.4	1.5	29.1
1.51	1	3	0.7	0*	1.9	29.4
	2	3	0.4	0*	1.1	29.4
	3	3	0.4	0.2	0.6	29.4
	4	3	0.5	0.3	0.7	29.4
	5	3	0.5	0.2	0.8	29.4
	6	3	0.6	0.4	0.7	29.4
	7	3	1.1	0.9	1.2	29.4
3.03	1	3	5.5	0*	19.7	29.3
	2	3	0.8	0*	1.6	29.3
	3	3	0.5	0*	1.2	29.3
	4	3	0.5	0*	1.2	29.3
	5	3	0.5	0*	1.1	29.3
	6	3	0.5	0.1	0.9	29.3
	7	3	1.0	0.2	1.8	29.3
12.11	1	3	23.4	4.9	41.9	29.3
	2	3	1.6	0.5	2.8	29.3
	3	3	1.0	0.1	1.8	29.3
	4	3	0.9	0*	1.9	29.3
	5	3	1.0	0.4	1.5	29.3

Table 15. Continued.

Flow rate (L/min)	Sample port	n	Mean TDS difference (g/L)	Lower limit (g/L)	Upper limit (g/L)	Average initial TDS (g/L)
12.11	6	3	0.9	0.3	1.6	29.3
	7	3	1.3	1.1	1.5	29.3
22.71	1	3	18.5	0*	53.3	29
	2	3	1.0	0.3	1.7	29
	3	3	0.6	0.4	0.8	29
	4	3	0.6	0.2	1.0	29
	5	3	0.6	0.3	0.9	29
	6	3	0.7	0.5	0.8	29
	7	3	0.9	0.7	1.1	29
43.91	1	3	27.4	25.7	29	29.2
	2	3	17.2	0*	45.8	29.2
	3	3	1.4	0.0	2.8	29.2
	4	3	1.0	0.3	1.7	29.2
	5	3	0.9	0.1	1.6	29.2
	6	3	0.8	0.0	1.6	29.2
	7	3	1.2	0.2	2.1	29.2
75.71	1	3	27.4	26.8	28.1	29.5
	2	3	1.8	0.2	3.4	29.5
	3	3	1.2	0*	2.5	29.5
	4	3	1.0	0.2	1.7	29.5
	5	3	0.8	0.4	1.2	29.5
	6	3	0.7	0.4	1.0	29.5
	7	3	1.1	0.7	1.4	29.5
113.56	1	3	27.7	26.5	28.9	29.2
	2	3	2.1	0*	4.6	29.2
	3	3	1.1	0.1	2.1	29.2
	4	3	1.0	0.1	1.9	29.2
	5	3	1.0	0.0	2.0	29.2
	6	3	1.0	0*	2.0	29.2
	7	3	1.0	0.3	1.8	29.2

*Denotes statistical values that extended beyond the physical limitations of the system that were truncated to fit within the systems physical dimensions.

Diverter E

Diverter E utilized a 10.16 cm diameter PVC diverter chamber and a 7.62 cm downward oriented sanitary tee as the transition fitting from the diverter chamber to the downspout. This configuration with the diverter chamber drain closed displayed larger mean differences in initial and final TDS concentrations in the upper sample ports as flow rate increased (Figure 11). Only slight mean differences in initial and final TDS concentrations were observed at flow rates of 3.03 L/min and less.

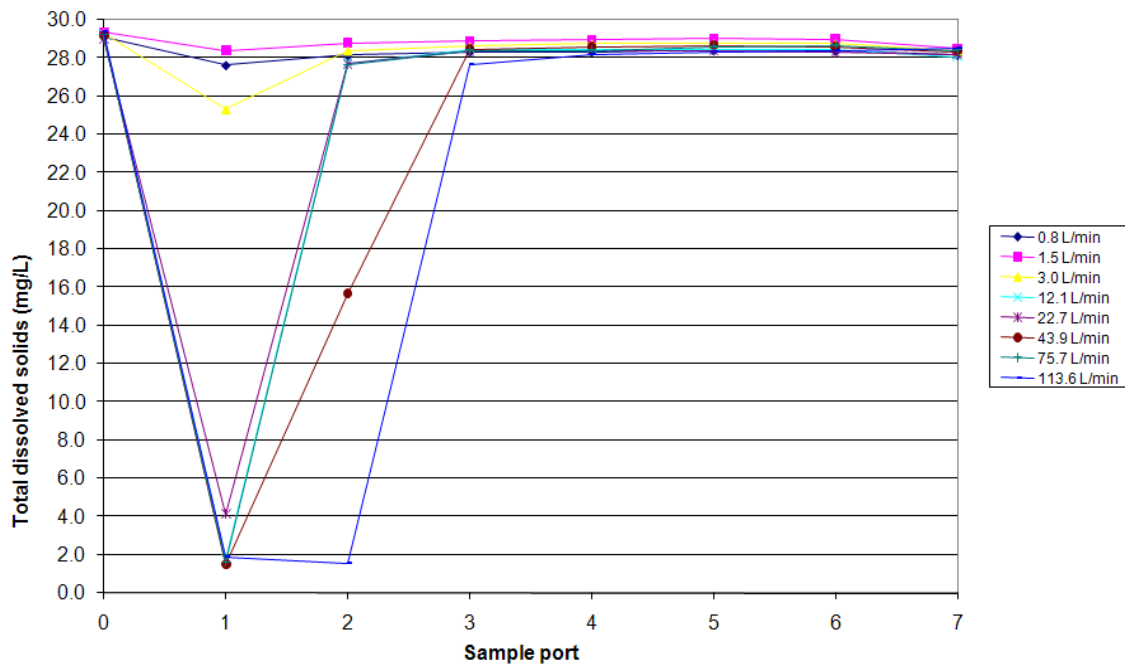

Figure 11. Diverter E's relationship between the mean total dissolved solids concentration and location of sampling ports in the diverter chamber at various flow rates with a closed diverter chamber drain.

The numerical values for diverter E's mean difference in initial and final TDS concentrations at various flow rates, along with each set's 95% confidence interval about the mean, are presented in Table 16 below.

Table 16. Mean differences in initial and final total dissolved solids concentrations at various sample port locations in diverter E's diverter chamber at experimental flow rates presented with 95% confidence intervals.

Flow rate (L/min)	Sample port	n	Mean TDS difference (g/L)	Lower limit (g/L)	Upper limit (g/L)	Average initial TDS (g/L)
0.76	1	3	1.5	0.3	2.6	29.1
	2	3	1.0	0.4	1.5	29.1
	3	3	0.8	0.5	1.1	29.1
	4	3	0.8	0.6	0.9	29.1
	5	3	0.7	0.7	0.7	29.1
	6	3	0.7	0.6	0.9	29.1
	7	3	0.9	0.8	1.1	29.1
1.51	1	3	1.0	0*	2.4	29.4
	2	3	0.6	0*	1.3	29.4
	3	3	0.5	0*	1.3	29.4
	4	3	0.4	0*	0.9	29.4
	5	3	0.3	0.2	0.5	29.4
	6	3	0.4	0.1	0.7	29.4
	7	3	0.9	0.7	1.0	29.4
3.03	1	3	4.0	0*	13.8	29.3
	2	3	0.9	0.2	1.6	29.3
	3	3	0.7	0.3	1.0	29.3
	4	3	0.5	0.2	0.9	29.3
	5	3	0.5	0.4	0.7	29.3
	6	3	0.5	0.4	0.7	29.3
	7	3	0.9	0.7	1.1	29.3
12.11	1	3	27.5	26.6	28.4	29.3
	2	3	1.5	1.3	1.7	29.3
	3	3	0.8	0.4	1.1	29.3
	4	3	0.8	0.4	1.1	29.3
	5	3	0.8	0.4	1.1	29.3
	6	3	0.8	0.6	1	29.3
	7	3	1.2	0.8	1.6	29.3
22.71	1	3	24.9	13.7	36.1	29
	2	3	1.3	1.2	1.5	29
	3	3	0.7	0.5	0.8	29
	4	3	0.6	0.5	0.8	29

Table 16. Continued.

Flow rate (L/min)	Sample port	n	Mean TDS difference (g/L)	Lower limit (g/L)	Upper limit (g/L)	Average initial TDS (g/L)
22.71	5	3	0.6	0.5	0.8	29
	6	3	0.7	0.6	0.9	29
	7	3	0.8	0.7	1.0	29
43.91	1	3	27.7	27.1	28.3	29.2
	2	3	13.5	0*	47.3	29.2
	3	3	0.7	0*	2.0	29.2
	4	3	0.6	0*	1.9	29.2
	5	3	0.5	0*	1.6	29.2
	6	3	0.6	0*	1.5	29.2
	7	3	0.8	0.5	1.2	29.2
75.71	1	3	27.6	27	28.2	29.2
	2	3	1.5	0.7	2.3	29.2
	3	3	0.8	0*	1.7	29.2
	4	3	0.8	0*	1.7	29.2
	5	3	0.6	0*	1.3	29.2
	6	3	0.5	0*	1.2	29.2
	7	3	0.8	0.6	1.0	29.2
113.56	1	3	27.5	27.1	28	29.4
	2	3	27.8	27.3	28.4	29.4
	3	3	1.7	1.3	2.1	29.4
	4	3	1.2	0.8	1.5	29.4
	5	3	1.1	0.4	1.7	29.4
	6	3	1.0	0.3	1.6	29.4
	7	3	0.9	0.2	1.5	29.4

*Denotes statistical values that extended beyond the physical limitations of the system that were truncated to fit within the systems physical dimensions.

Diverter F

Diverter F utilized a 10.16 cm diameter PVC diverter chamber and a straight 7.62 cm tee as the transition fitting from the diverter chamber to the downspout. This configured is similar to diverter C except without the floating ball to block the diverted

water from interacting with water that is bypassing the diverter chamber. This diverter configuration with the diverter chamber drain closed displayed larger mean differences in initial and final TDS concentrations in the upper sample ports as flow rate increased (Figure 12). Only slight mean differences in initial and final TDS concentrations were observed at all sample ports at flow rates of 3.03 L/min and lower.

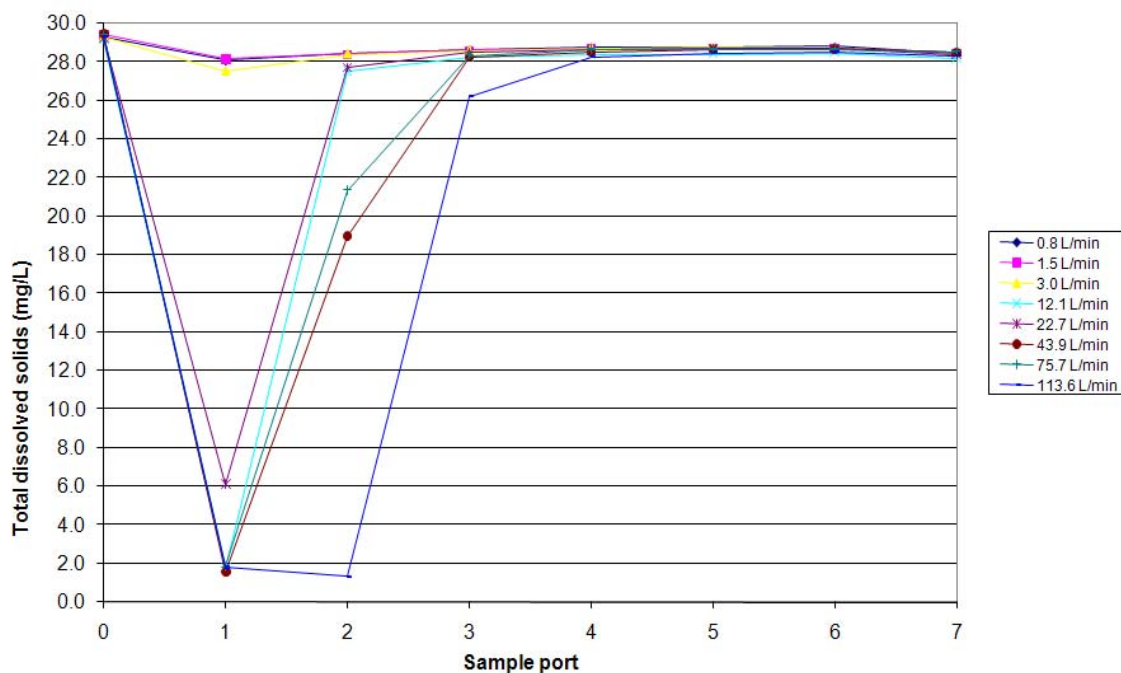

Figure 12. Diverter F's relationship between the mean total dissolved solids concentration and location of sampling ports in the diverter chamber at various flow rates with a closed diverter chamber drain.

The numerical values for diverter F's mean difference in initial and final TDS concentrations at various flow rates, along with each set's 95% confidence interval about the mean, are presented in Table 17 below.

Table 17. Mean differences in initial and final total dissolved solids concentrations at various sample port locations in diverter F's diverter chamber at experimental flow rates presented with 95% confidence intervals.

Flow rate (L/min)	Sample port	n	Mean TDS difference (g/L)	Lower limit (g/L)	Upper limit (g/L)	Average initial TDS (g/L)
0.76	1	3	1.2	0*	3.4	29.3
	2	3	0.9	0*	2.7	29.3
	3	3	0.6	0*	2.0	29.3
	4	3	0.5	0*	1.7	29.3
	5	3	0.6	0*	1.3	29.3
	6	3	0.5	0*	1.2	29.3
	7	3	0.9	0.3	1.4	29.3
1.51	1	3	1.3	1.0	1.6	29.4
	2	3	1.0	0.9	1.2	29.4
	3	3	0.8	0.7	1.0	29.4
	4	3	0.7	0.6	0.9	29.4
	5	3	0.7	0.5	0.9	29.4
	6	3	0.7	0.5	0.9	29.4
	7	3	1.0	0.8	1.1	29.4
3.03	1	3	1.8	0*	5.7	29.3
	2	3	0.9	0*	2.1	29.3
	3	3	0.7	0.0	1.4	29.3
	4	3	0.6	0.2	1.0	29.3
	5	3	0.6	0.2	0.9	29.3
	6	3	0.6	0.4	0.8	29.3
	7	3	0.9	0.7	1.1	29.3
12.11	1	3	27.4	27.3	27.6	29.2
	2	3	1.7	1.3	2.0	29.2
	3	3	0.9	0.8	1.1	29.2
	4	3	0.8	0.8	0.8	29.2
	5	3	0.8	0.6	0.9	29.2
	6	3	0.7	0.7	0.7	29.2
	7	3	1.0	0.8	1.2	29.2
22.71	1	3	23.2	14.6	31.7	29.3
	2	3	1.6	1.4	1.7	29.3
	3	3	0.8	0.6	1.0	29.3
	4	3	0.7	0.1	1.2	29.3

Table 17. Continued.

Flow rate (L/min)	Sample port	n	Mean TDS difference (g/L)	Lower limit (g/L)	Upper limit (g/L)	Average initial TDS (g/L)
22.71	5	3	0.6	0.0	1.1	29.3
	6	3	0.6	0.0	1.1	29.3
	7	3	0.9	0.7	1.1	29.3
43.91	1	3	27.9	26.9	28.9	29.5
	2	3	10.5	0*	48.3	29.5
	3	3	1.2	0.6	1.9	29.5
	4	3	1.0	0.8	1.1	29.5
	5	3	0.8	0.5	1.1	29.5
	6	3	0.8	0.6	1.0	29.5
	7	3	1.0	0.8	1.1	29.5
75.71	1	3	27.5	27.3	27.8	29.4
	2	3	8.0	0*	18.3	29.4
	3	3	1.0	0.7	1.4	29.4
	4	3	0.7	0.4	1.0	29.4
	5	3	0.7	0.5	0.9	29.4
	6	3	0.7	0.5	0.9	29.4
	7	3	0.8	0.5	1.2	29.4
113.56	1	3	27.5	26.9	28.1	29.3
	2	3	28.0	27.7	28.3	29.3
	3	3	3.1	0*	6.4	29.3
	4	3	1.0	0.7	1.3	29.3
	5	3	0.8	0.7	1.0	29.3
	6	3	0.8	0.6	1.0	29.3
	7	3	1.0	0.8	1.1	29.3

*Denotes statistical values that extended beyond the physical limitations of the system that were truncated to fit within the systems physical dimensions.

Diverter Chamber Drain Open

As previously stated a preliminary study evaluated the effectiveness of utilizing a continuous drain to empty the diverter chamber on the downspout first flush diverter as a maintenance technique and its applicability in various rainfall

conditions. It was found that in this experimental design the diverter chamber volume and drain flow rate of the diverter chamber controls the resulting mean differences in initial and final TDS concentrations. Regardless of flow rate or transition fitting, all results were similar. The observed mean difference found between the 10.16 and 15.24 cm diameter diverter chambers were only a result of a difference in initial diversion volume. Table 18 below shows a sample of results from diverter F with the diverter chamber drain open. All other diverters displayed similar results with the diverter chamber drain open.

Table 18. Mean differences in initial and final total dissolved solids concentrations at various sample port locations in diverter F's diverter chamber at experimental flow rates presented with 95% confidence intervals with the diverter chamber drain open.

Flow rate (L/min)	Sample port	n	Mean TDS difference (g/L)	Lower limit (g/L)	Upper limit (g/L)	Average initial TDS (g/L)
1.51	1	3	28.4	27.4	29.4	29.5
	2	3	28.8	28.8	28.9	29.5
	3	3	28.9	28.8	28.9	29.5
	4	3	28.9	28.8	28.9	29.5
	5	3	28.9	28.8	28.9	29.5
	6	3	28.8	28.8	28.9	29.5
	7	3	23.9	23.1	24.7	29.5
3.03	1	3	28.1	26.9	29.4	29.4
	2	3	28.7	28.7	28.8	29.4
	3	3	28.8	28.7	28.8	29.4
	4	3	28.8	28.7	28.8	29.4
	5	3	28.8	28.8	28.8	29.4
	6	3	28.8	28.7	28.8	29.4
	7	3	24.4	24.2	24.6	29.4
12.11	1	3	28.3	28.2	28.4	29.5
	2	3	28.8	28.8	28.9	29.5
	3	3	28.9	28.9	28.9	29.5

Table 18. Continued.

Flow rate (L/min)	Sample port	n	Mean TDS difference (g/L)	Lower limit (g/L)	Upper limit (g/L)	Average initial TDS (g/L)
12.11	4	3	28.9	28.8	28.9	29.5
	5	3	28.9	28.8	28.9	29.5
	6	3	28.9	28.8	28.9	29.5
	7	3	23.7	23.6	23.7	29.5
22.71	1	3	28.0	27.3	28.6	29.3
	2	3	28.6	28.5	28.7	29.3
	3	3	28.6	28.4	28.8	29.3
	4	3	28.6	28.5	28.7	29.3
	5	3	28.6	28.5	28.8	29.3
	6	3	28.6	28.5	28.8	29.3
	7	3	24.0	22.5	25.4	29.3
43.91	1	3	27.8	26.7	28.9	29
	2	3	28.3	28.2	28.4	29
	3	3	28.3	28.2	28.4	29
	4	3	28.3	28.2	28.4	29
	5	3	28.3	28.1	28.4	29
	6	3	28.3	28.2	28.4	29
	7	3	23.7	22.6	24.8	29
75.71	1	3	27.9	27.7	28.1	29.1
	2	3	28.5	28.4	28.5	29.1
	3	3	28.5	28.4	28.6	29.1
	4	3	28.5	28.4	28.5	29.1
	5	3	28.4	28.3	28.5	29.1
	6	3	28.4	28.3	28.5	29.1
	7	3	24.3	24.0	24.6	29.1
113.56	1	3	28.6	28.5	28.7	29.3
	2	3	28.5	27.9	29.1	29.3
	3	3	28.6	28.4	28.8	29.3
	4	3	28.7	28.6	28.7	29.3
	5	3	28.6	28.6	28.7	29.3
	6	3	28.6	28.6	28.7	29.3
	7	3	23.2	22.4	23.9	29.3

*Denotes statistical values that extended beyond the physical limitations of the system that were truncated to fit within the systems physical dimensions.

DISCUSSION

Two general linear models were developed to evaluate the results of the experiments. The differences in the initial and final TDS concentrations at each sample port location were utilized to evaluate the influence of the various first flush diverter configurations. The first general linear model, which was developed for diverter configurations A, B, D, and E, allows us to evaluate the influence of diverter chamber diameter, diverter chamber to downspout transition fitting, flow rate, and port location, which is nested, on the difference in initial and final TDS concentrations. The ANOVA from the first general linear model (Table 9) concluded that all of the variables varied together. This result does not allow for statistically significant conclusions to be made on individual variables. It only allows general comparisons between variables, which is discussed below.

The results from the second general linear model, which was developed for diverter configurations C, D, E, and F, allows us to evaluate the influence of diverter chamber to downspout transition fitting, flow rate, and port location, which is nested, on the difference in initial and final TDS concentrations. Similar to the results from the ANOVA for the first general linear model, the ANOVA for the second general linear model (Table 11) concluded that all of the variables varied together. This result does not allow for statistically significant conclusions to be made on individual variables. It only allows general comparisons between variables, which is discussed below.

The decreases in TDS concentrations measured after each experiment can be attributed to the initial solution in the diverter chamber, which had high TDS

concentrations, being diluted by the simulated rainwater flows, which had a lower concentration of TDS. The dilution of the initial solution in the diverter chamber shows an interaction of the diverted water initially in the diverter chamber with the simulated rainwater that is passing through to the downspout and to the next step in collection, typically storage. Evaluating the mean differences in initial and final TDS concentration observed at different sampling ports locations gives insight to how suspended contaminants may react and be transported out of the diverter chamber.

Comparison of 10.16 and 15.24 cm Diameter Diverter Chambers

Comparison of the mean differences in TDS concentrations observed at each sample port, at experimental flow rates, allow for comparison between experimental variables. When comparing 10.16 cm and 15.24 cm diverter chambers with upward and downward oriented sanitary tees as transition fittings at the experimental flow rate of 0.76 L/min, there are minimal differences in the mean differences in initial and final TDS concentrations at every sample port (Figure 13). Figure 13 shows the minimal differences in the 10.16 and 15.24 cm diverter chamber results.

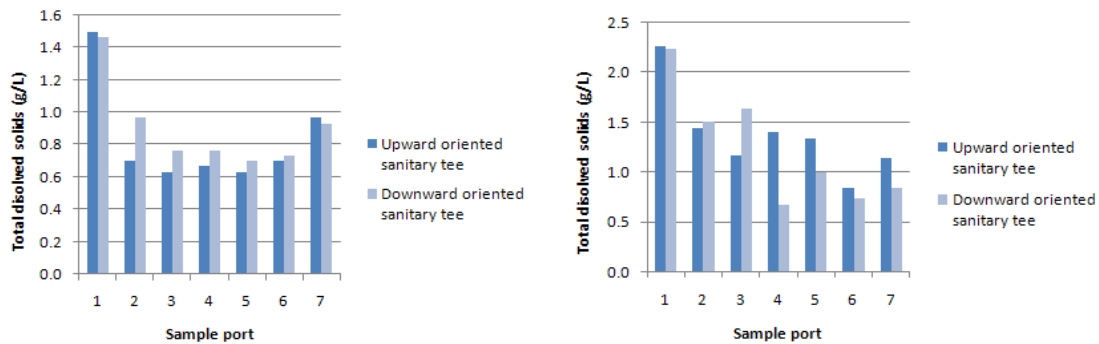

Figure 13. Comparison of the mean differences in initial and final total dissolved solids concentration in two 10.16 cm (left) and two 15.24 cm (right) diverter chambers at a flow rate of 0.76 L/min.

When comparing 10.16 cm and 15.24 cm diverter chambers with upward and downward oriented sanitary tees as transition fittings at the experimental flow rate of 1.51 L/min, there are minimal differences in the mean differences in initial and final TDS concentrations at every sample port (Figure 14). Figure 14 shows the minimal mean differences in the 10.16 and 15.24 cm diverter chamber results.

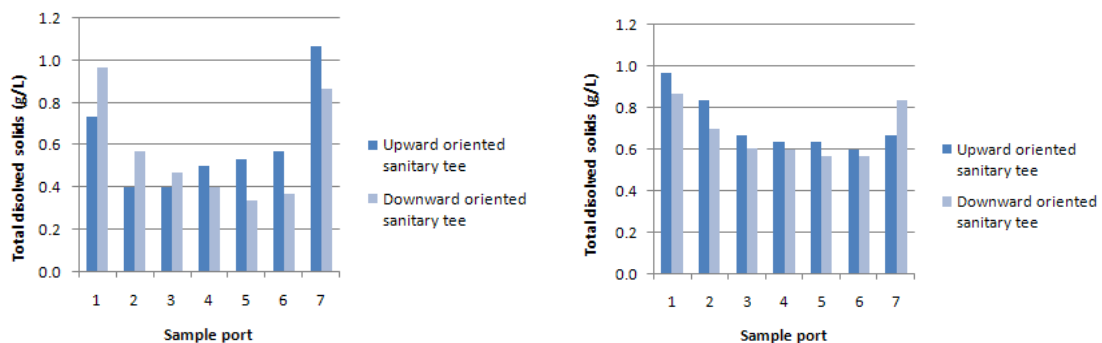

Figure 14. Comparison of the mean differences in initial and final total dissolved solids concentration in two 10.16 cm (left) and two 15.24 cm (right) diverter chambers at a flow rate of 1.51 L/min.

When comparing 10.16 cm and 15.24 cm diverter chambers with upward and downward oriented sanitary tees as transition fittings at the experimental flow rate of 3.03 L/min, there are minimal differences in the mean differences in initial and final TDS concentrations at sample ports on the 15.24 cm diverter chamber (Figure 15). The mean differences in the initial and final TDS concentrations at different sample ports are slightly increased in the 10.16 cm diverter chamber at 3.03 L/min. Figure 15 also shows the minimal differences between the upward and downward oriented sanitary tees in both the 10.16 and 15.24 cm diverter chamber results.

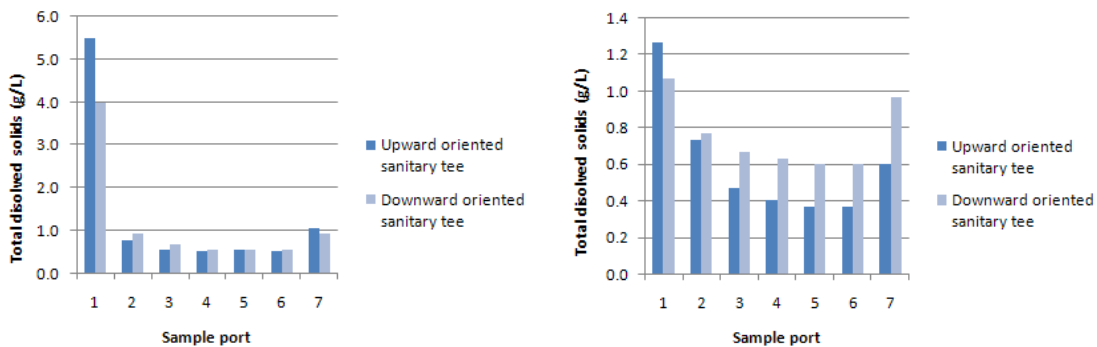

Figure 15. Comparison of the mean differences in initial and final total dissolved solids concentration in two 10.16 cm (left) and two 15.24 cm (right) diverter chambers at a flow rate of 3.03 L/min.

Similar to results at the 3.03 L/min flow rate, mean differences between the initial and final TDS concentrations at all sample ports in the 15.24 cm diverter chamber are relatively similar at 12.11 L/min (Figure 16). When comparing the results of both transition fittings in the 10.16 and 15.24 cm diverter chamber, the 10.16 diverter chamber results show a large difference between sample port 1 and the rest of the sample

ports. The mean differences in the initial and final TDS concentrations at different sample ports show the dilution of the initial solution at the sample port location. Similar to previous comparisons, figure 16 also shows the minimal differences between the upward and downward oriented sanitary tees in both the 10.16 and 15.24 cm diverter chamber results at the 12.11 L/min flow rate.

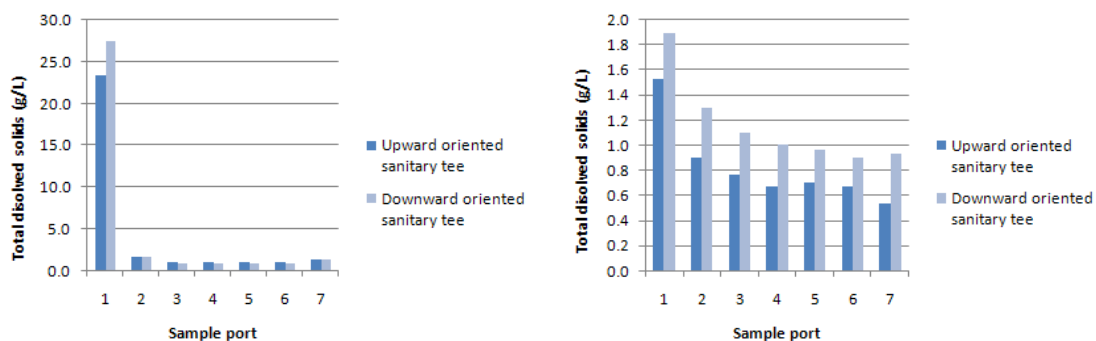

Figure 16. Comparison of the mean differences in initial and final total dissolved solids concentration in two 10.16 cm (left) and two 15.24 cm (right) diverter chambers at a flow rate of 12.11 L/min.

Figure 17 shows a large difference between the mean differences in initial and final TDS concentrations observed at the top sample port, sample port 1. The mean differences in the initial and final TDS concentrations at different sample ports show the dilution of the initial solution at the sample port location. Similar to previous comparisons, figure 17 also shows the minimal differences between the upward and downward oriented sanitary tees in both the 10.16 and 15.24 cm diverter chamber results at the 22.71 L/min flow rate.

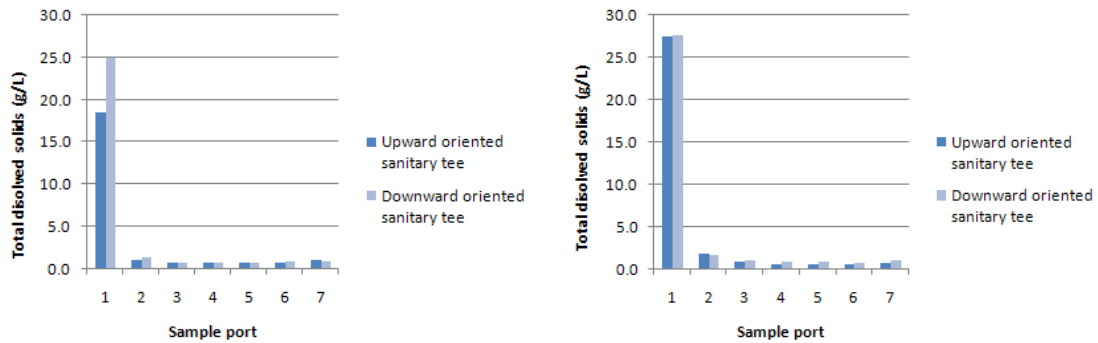

Figure 17. Comparison of the mean differences in initial and final total dissolved solids concentration in two 10.16 cm (left) and two 15.24 cm (right) diverter chambers at a flow rate of 22.71 L/min.

Figure 18 shows a large difference between the mean differences in initial and final TDS concentrations observed at the top two sample ports, sample port 1 and 2, in both the 10.16 and 15.24 cm diverter chambers. The mean differences in the initial and final TDS concentrations at different sample ports show the dilution of the initial solution at the sample port location. Overall, figure 18 shows minimal differences between the upward and downward oriented sanitary tees in both the 10.16 and 15.24 cm diverter chamber results at the 43.91 L/min flow rate. The downward oriented sanitary tee in the 15.24 cm diverter chamber did allow a greater mean differences in initial and final TDS concentration than the upward oriented sanitary tee at sample port 2.

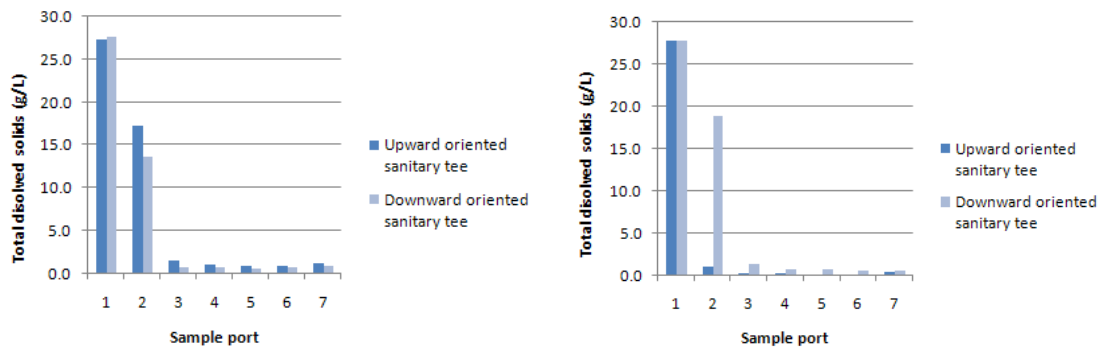

Figure 18. Comparison of the mean differences in initial and final total dissolved solids concentration in two 10.16 cm (left) and two 15.24 cm (right) diverter chambers at a flow rate of 43.91 L/min.

Figure 19 shows a large difference between the mean differences in initial and final TDS concentrations observed at the top sample port, sample port 1, in both the 10.16 and 15.24 cm diverter chambers at 75.71 L/min. The mean differences in the initial and final TDS concentrations at different sample ports show the dilution of the initial solution at the sample port location. Overall, figure 19 shows minimal differences between the upward and downward oriented sanitary tees in both the 10.16 and 15.24 cm diverter chamber results at the 75.71 L/min flow rate. The upward oriented sanitary tee in the 15.24 cm diverter chamber did allow a greater mean differences in initial and final TDS concentration than the downward oriented sanitary tee at sample port 2.

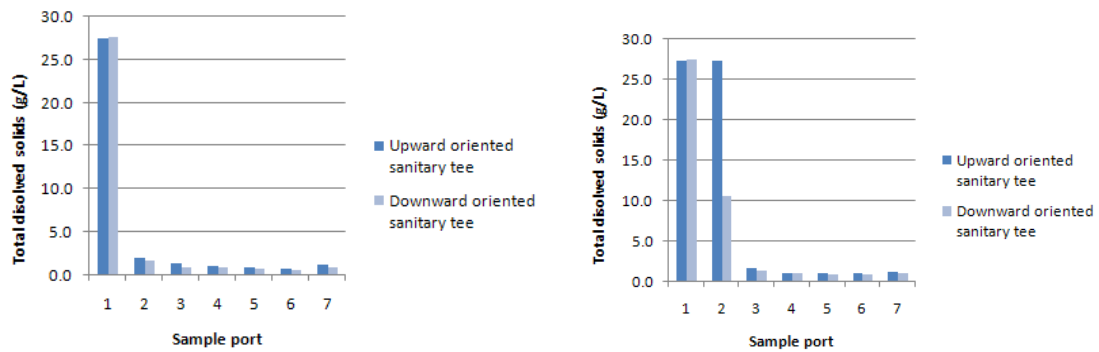

Figure 19. Comparison of the mean differences in initial and final total dissolved solids concentration in two 10.16 cm (left) and two 15.24 cm (right) diverter chambers at a flow rate of 75.71 L/min.

Figure 20 shows more variable results than the previous flow rates. large difference between the mean differences in initial and final TDS concentrations were observed at the top sample port, sample port 1, in both the 10.16 and 15.24 cm diverter chambers at 113.56 L/min for both transition fittings. The mean differences in the initial and final TDS concentrations at different sample ports show the dilution of the initial solution at the sample port location. Except for sample port 2 on the 10.16 cm diverter chamber and sample ports 1, 2, and 3 on the 15.24 cm diverter chamber, figure 20 shows minimal differences between the upward and downward oriented sanitary tees in both the 10.16 and 15.24 cm diverter chamber results at the 113.56 L/min flow rate. The downward oriented sanitary tee in the 10.16 cm diverter chamber allowed greater mean differences in initial and final TDS concentration than the upward oriented sanitary tee at sample port 1. The upward oriented sanitary tee in the 15.24 cm diverter chamber did allow a greater mean differences in initial and final TDS concentration than the downward oriented sanitary tee at sample ports 1, 2 and 3.

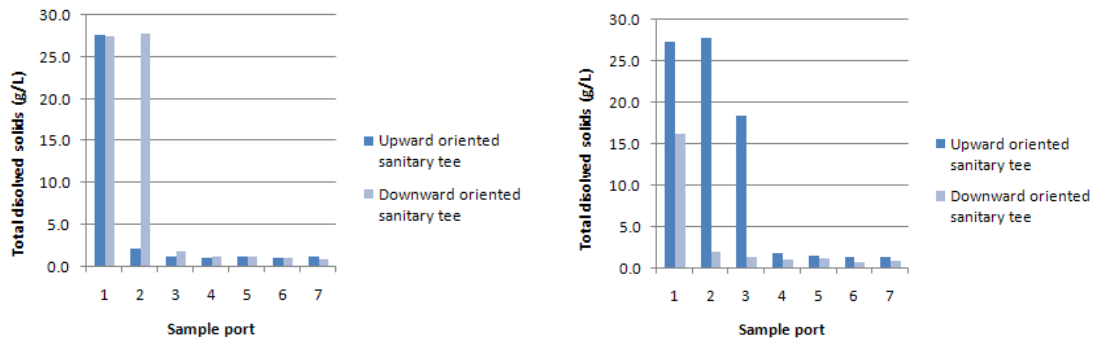

Figure 20. Comparison of the mean differences in initial and final total dissolved solids concentration in two 10.16 cm (left) and two 15.24 cm (right) diverter chambers at a flow rate of 113.56 L/min.

When comparing the overall performance of the upward oriented sanitary tee against the downward oriented sanitary tee, there is not a clear advantage for either one in its ability to limit the interaction of diverted water with simulated rainwater flows. When comparing the diverter configurations utilizing 15.24 cm diameter diverter chambers to their 10.16 cm diameter counterparts, results showed that a large mean difference in the initial and final TDS concentration was found starting at the flow rate of 12.11 L/min for the 10.16 cm diverter chambers and 22.71 L/min for the 15.24 cm diverter chambers. At flow rates of 15.71 and 113.56 L/min, the 15.25 cm diverter chamber displayed a large mean difference in initial and final TDS concentrations at sample ports 1 and 2.

These results suggest the depths of interaction, based on the location of the sample ports, due to the dilution of the initial solution in the diverter chamber in each experimental test. The experimental results suggest that an interaction between the

diverted water in the diverter chamber and the simulated flow of rainwater does not occur in the 10.16 cm diverter chambers at flow rates of 3.03 L/min or less and does not occur in the 15.24 cm diverter chambers at flow rates of 12.11 L/min or less. The results also suggest that at flows of 12.11 L/min and greater in the 10.16 cm diverter chambers and 22.71 L/min and greater in the 15.24 cm diverter chambers, an interaction occurs at sample port 1 which is located at a depth of 30.5 cm in the diverter chamber (Figure 5). Large mean differences between the initial and final TDS concentrations are also observed in sample ports 1 and 2, which are located at a depth of 30.5 and 61 cm, respectively, in the diverter chamber, in the 15.24 cm diverter chambers at flows of 43.91 L/min and greater. The 10.16 cm diverter chambers displayed large mean differences in sample ports 1 and 2, which are located at a depth of 30.5 and 61.0 cm, respectively, in the diverter chamber, at flow rates of 43.91 and 113.56 L/min. Based on the results, it was determined that there is not a difference between the use of a downspout first flush diverter with diameters of 10.16 and 15.24 cm utilizing upward and downward oriented sanitary tees as downspout to diverter chamber transition fittings. The data suggests that diverter chamber diameter should be more dependent on the volume of water that the system designer wants to divert rather than utilizing the diverter chamber diameter to promote decreased interaction of the diverted water with the subsequent flow of rainwater.

Comparison of Upward and Downward Oriented Sanitary Tees as Transition Fittings

Comparison of the mean differences in TDS concentrations observed at each sample port, at experimental flow rates, allow for comparison between experimental variables. When comparing upward and downward oriented sanitary tees as transition fittings on 10.16 and 15.24 cm diverter chambers at the experimental flow rate of 0.76 L/min, there are minimal differences in the mean differences in initial and final TDS concentrations at every sample port (Figure 21). Figure 21 shows the minimal differences in the upward and downward oriented sanitary tees results.

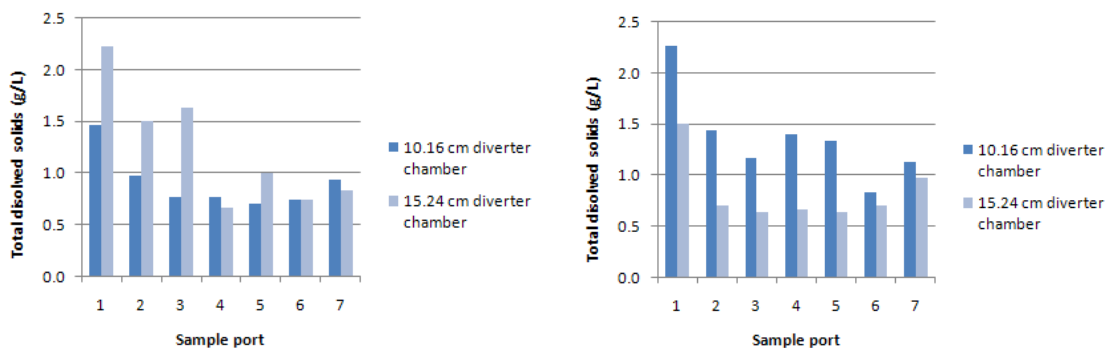

Figure 21. Comparison of the mean differences in initial and final total dissolved solids concentration in four downspout first flush diverters utilizing two downward oriented (left) and two upward oriented (right) sanitary tees at a flow rate of 0.76 L/min.

When comparing upward and downward oriented sanitary tees as transition fittings on 10.16 and 15.24 cm diverter chambers at the experimental flow rate of 1.51 L/min, there are minimal differences in the mean differences in initial and final TDS

concentrations at every sample port (Figure 22). Figure 22 shows the minimal differences in the upward and downward oriented sanitary tees results.

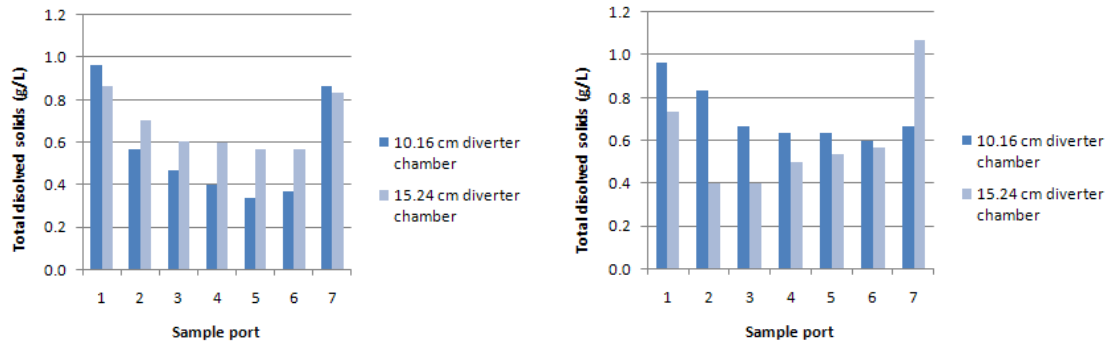

Figure 22. Comparison of the mean differences in initial and final total dissolved solids concentration in four downspout first flush diverters utilizing two downward oriented (left) and two upward oriented (right) sanitary tees at a flow rate of 1.51 L/min.

Similar to results at the flow rate of 1.51 L/min, when comparing upward and downward oriented sanitary tees as transition fittings on 10.16 and 15.24 cm diverter chambers at the experimental flow rate of 3.03 L/min, there are minimal differences in the mean differences in initial and final TDS concentrations at every sample port (Figure 23). While figure 23 shows the minimal differences in the upward and downward oriented sanitary tees results, a trend of larger mean differences at sample port 1 is beginning to develop.

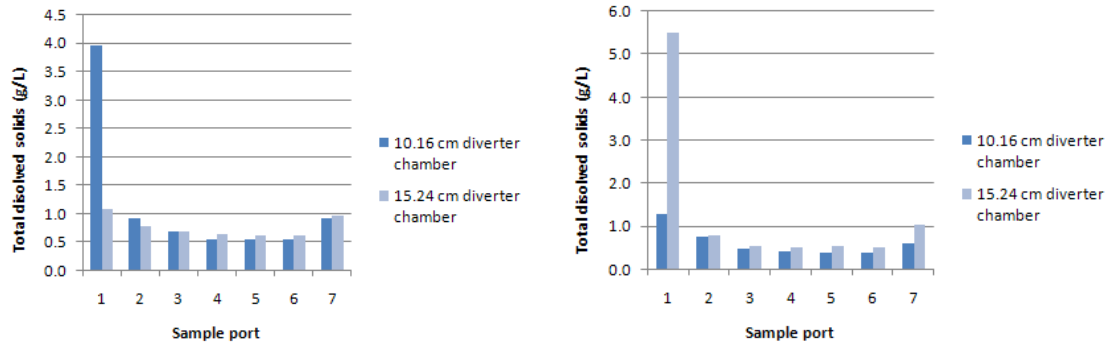

Figure 23. Comparison of the mean differences in initial and final total dissolved solids concentration in four downspout first flush diverters utilizing two downward oriented (left) and two upward oriented (right) sanitary tees at a flow rate of 3.03 L/min.

Figure 24 shows a large mean difference between the initial and final TDS concentration in the downward and upward oriented sanitary tee at sample port 1, at a flow rate of 12.11 L/min. The downward oriented sanitary tee shows a large mean difference at sample port 1 with the 15.24 cm diverter chamber while the upward oriented sanitary tee shows a large difference at sample port 1 with the 10.16 cm diverter chamber. At all other sample ports for both the 10.16 and 15.24 cm diverter chambers there are minimal mean differences in the differences in initial and final TDS concentrations (Figure 24). Similar to the pattern of figure 23, figure 24 shows the minimal mean differences in the 10.16 and 15.24 cm diverter chamber's results at the experimental flow rate of 12.11 L/min.

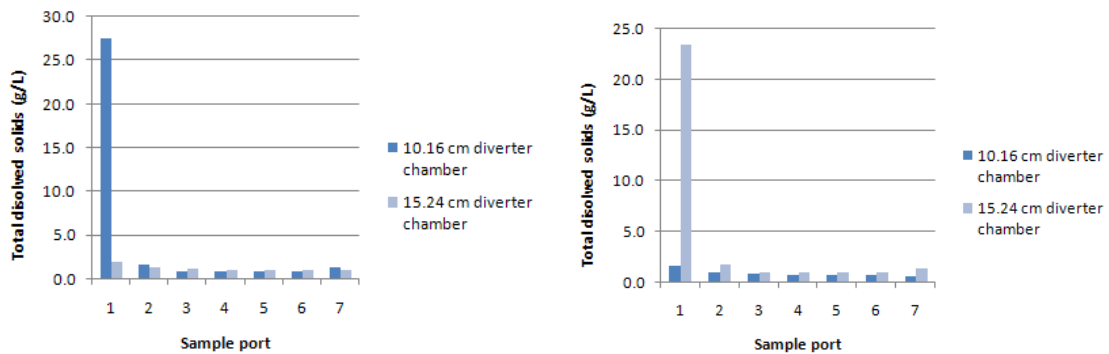

Figure 24. Comparison of the mean differences in initial and final total dissolved solids concentration four downspout first flush diverters utilizing two downward oriented (left) and two upward oriented (right) sanitary tees at a flow rate of 12.11 L/min.

Figure 25 shows a large mean difference between the initial and final TDS concentration in the downward and upward oriented sanitary tee at sample port 1, at a flow rate of 22.71 L/min. The downward and upward oriented sanitary tees show a large mean difference at sample port 1 with both the 10.16 and 15.24 cm diverter chamber. At all other sample ports for both the 10.16 and 15.24 cm diverter chambers there are minimal differences in the mean differences in initial and final TDS concentrations (Figure 25). Similar to the pattern of figure 24, figure 25 shows the minimal differences in the 10.16 and 15.24 cm diverter chamber's results at the experimental flow rate of 22.17 L/min.

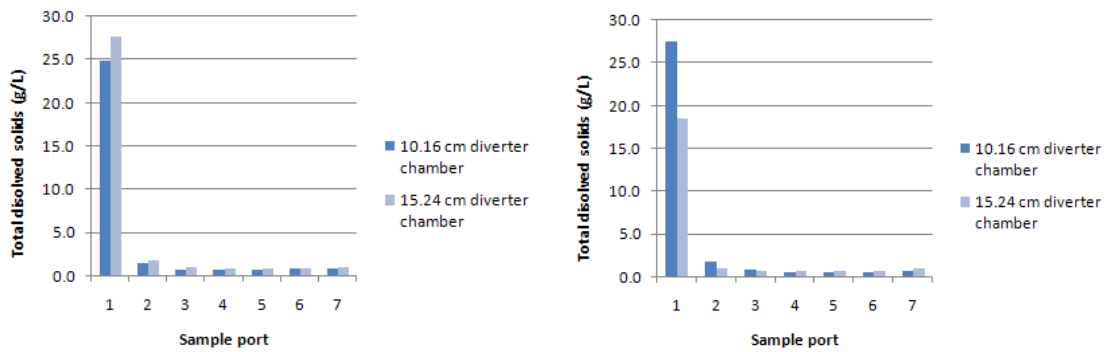

Figure 25. Comparison of the mean differences in initial and final total dissolved solids concentration in four downspout first flush diverters utilizing two downward oriented (left) and two upward oriented (right) sanitary tees at a flow rate of 22.71 L/min.

Figure 26 shows large mean differences between the initial and final TDS concentration in the downward and upward oriented sanitary tee at sample ports 1 and 2, at a flow rate of 43.91 L/min. The downward and upward oriented sanitary tees show a large mean difference at sample port 1 with both the 10.16 and 15.24 cm diverter chamber. At sample port 2 the downward oriented sanitary tee shows a large mean difference in initial and final TDS concentrations for both the 10.16 and 15.24 cm diverter chambers. The upward oriented sanitary tee at sample port 2 only shows a large mean difference in initial and final TDS concentrations in the 15.24 cm diverter chamber. At all other sample ports for both the 10.16 and 15.24 cm diverter chambers there are minimal differences in the mean differences in initial and final TDS concentrations (Figure 26). Similar to the pattern of figure 25, figure 26 shows the minimal differences in the 10.16 and 15.24 cm diverter chamber's results at the experimental flow rate of 43.91 L/min.

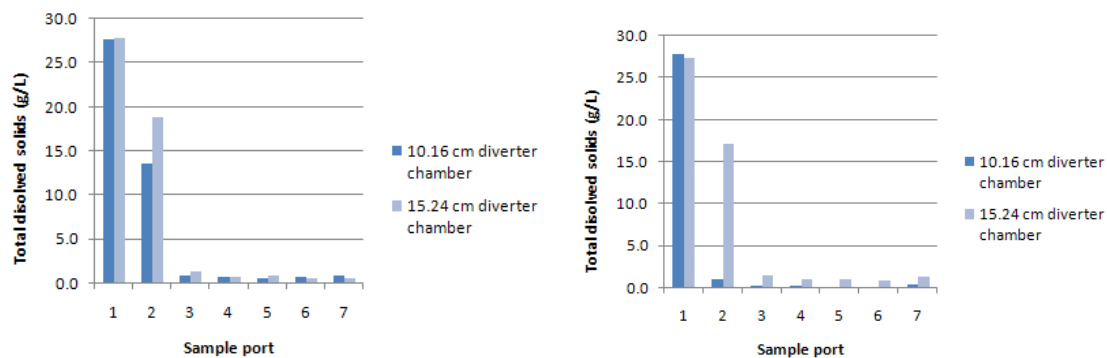

Figure 26. Comparison of the mean differences in initial and final total dissolved solids concentration in four downspout first flush diverters utilizing two downward oriented (left) and two upward oriented (right) sanitary tees at a flow rate of 43.91 L/min.

Figure 27 shows a large mean difference between the initial and final TDS concentration in the downward and upward oriented sanitary tee at sample port 1 at a flow rate of 75.71 L/min. The downward and upward oriented sanitary tees show a large mean difference at sample port 1 with both the 10.16 and 15.24 cm diverter chambers. At sample port 2 the downward oriented sanitary tee shows a large mean difference in initial and final TDS concentrations for the 15.24 cm diverter chamber. The upward oriented sanitary tee at sample port 2 shows a large mean difference in initial and final TDS concentrations in the 10.16 cm diverter chamber. At all other sample ports for both the 10.16 and 15.24 cm diverter chambers there are minimal differences in the mean differences in initial and final TDS concentrations (Figure 27). Similar to the pattern of figure 26, figure 27 shows the minimal differences in the 10.16 and 15.24 cm diverter chamber's results at the experimental flow rate of 75.71 L/min.

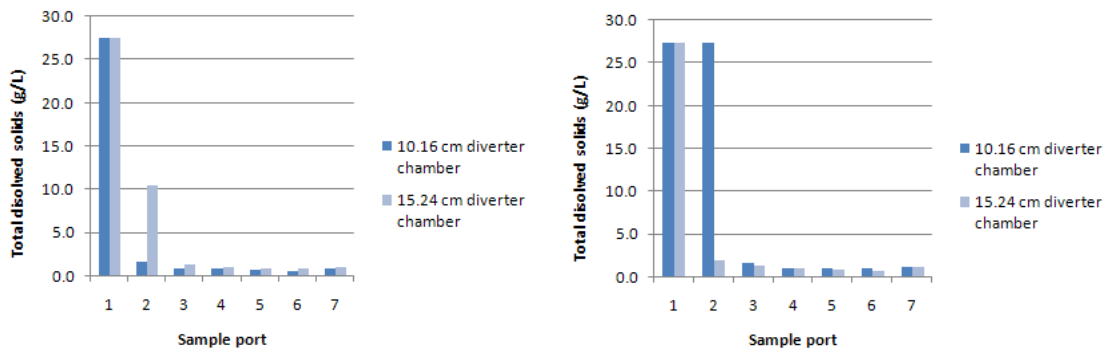

Figure 27. Comparison of the mean differences in initial and final total dissolved solids concentration in four downspout first flush diverters utilizing two downward oriented (left) and two upward oriented (right) sanitary tees at a flow rate of 75.71 L/min.

Figure 28 shows a large mean difference between the initial and final TDS concentration in the downward and upward oriented sanitary tee at sample port 1 at a flow rate of 113.56 L/min. The downward and upward oriented sanitary tees show a large mean difference at sample port 1 with both the 10.16 and 15.24 cm diverter chambers. At sample port 2 the downward oriented sanitary tee shows a large mean difference in initial and final TDS concentrations for the 10.16 cm diverter chamber. The upward oriented sanitary tee at sample ports 2 and 3 show a large mean difference in initial and final TDS concentrations in the 10.16 cm diverter chamber. At all other sample ports for both the 10.16 and 15.24 cm diverter chambers there are minimal differences in the mean differences in initial and final TDS concentrations (Figure 28).

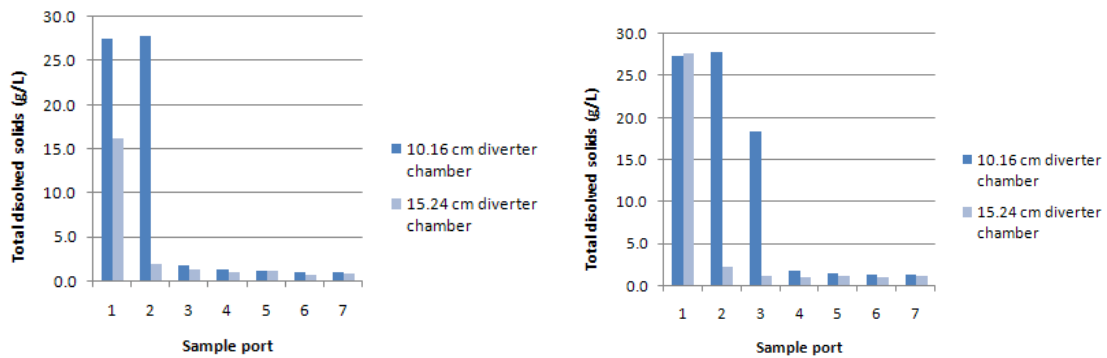

Figure 28. Comparison of the mean differences in initial and final total dissolved solids concentration four downspout first flush diverters utilizing two downward oriented (left) and two upward oriented (right) sanitary tees at a flow rate of 113.56 L/min.

These results suggest the depths of interaction, based on the location of the sample ports, due to the dilution of the initial solution in the diverter chamber in each experimental test. The experimental results suggest that an interaction between the diverted water in the diverter chamber and the simulated flow of rainwater does not occur in the upward and downward oriented sanitary tees at flow rates of 3.03 L/min or less. The results also suggest that at flows between 12.11 and 22.71 L/min both the upward and downward oriented sanitary tees display an interaction that occurs only at sample port 1 which is located at a depth of 30.5 cm in the diverter chamber (Figure 5). Large mean differences in the initial and final TDS concentrations are observed in sample ports 1 and 2, which are located at a depth of 30.5 and 61 cm, respectively, in the diverter chamber, in the upward and downward oriented sanitary tee transition fittings at flows of 43.91 L/min and greater. While there were some minor mean differences in initial and final TDS concentrations, no pattern was observed when comparing upward

and downward oriented sanitary tees used as diverter chamber to downspout transition fittings on 10.16 and 15.24 cm diverter chambers.

Comparison of Four Transition Fittings

Comparison of the mean differences in TDS concentrations observed at each sample port, at experimental flow rates, allow for comparison between experimental variables. When comparing the 10.16 cm diverter chambers with an upward and downward oriented sanitary tee, a straight tee, and a straight tee with a floating ball as transition fittings at the experimental flow rate of 0.76 L/min, there are minimal mean differences in the differences in initial and final TDS concentrations at every sample port (Figure 29).

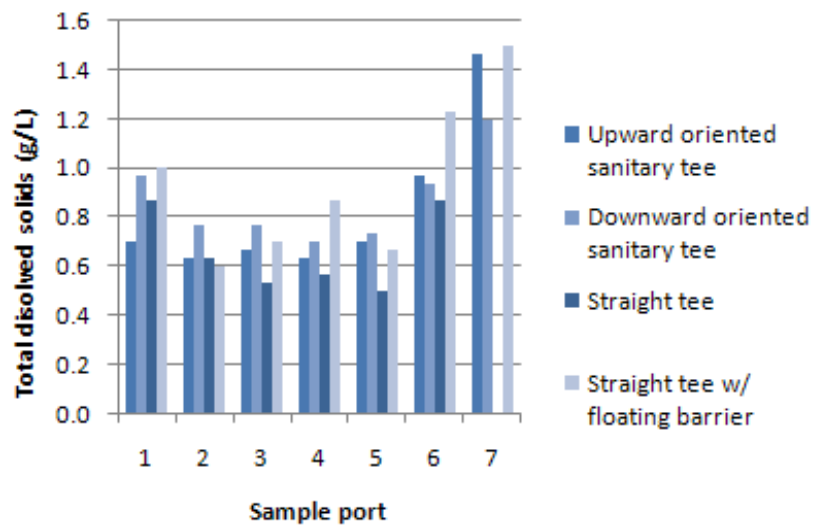

Figure 29. Comparison of the mean differences in initial and final total dissolved solids concentration in four downspout first flush diverters with a 10.16 cm diverter chamber at a flow rate of 0.76 L/min.

The results at the flow rate of 1.51 L/min are similar to results at 0.76 L/min. When comparing the 10.16 cm diverter chambers with an upward and downward oriented sanitary tee, a straight tee, and a straight tee with a floating ball as transition fittings at the experimental flow rate of 1.51 L/min, there are minimal differences in the mean differences in initial and final TDS concentrations at every sample port (Figure 30).

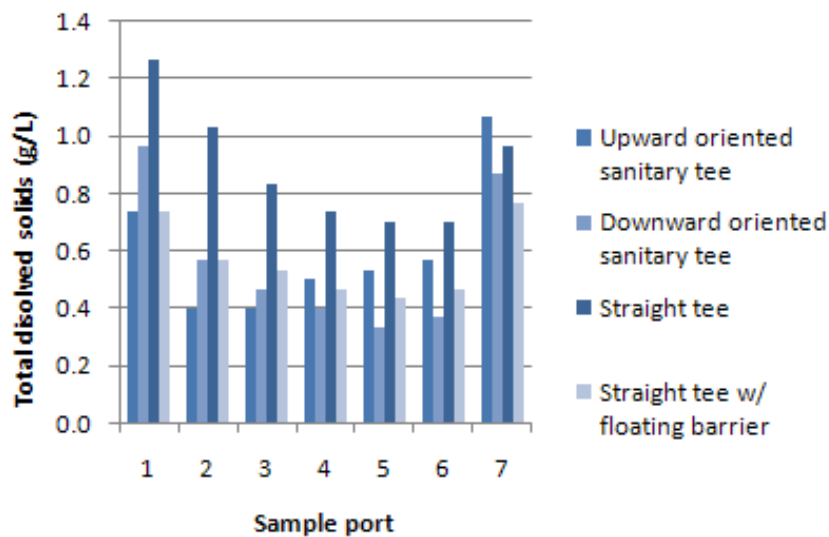

Figure 30. Comparison of the mean differences in initial and final total dissolved solids concentration in four downspout first flush diverters with a 10.16 cm diverter chamber at a flow rate of 1.51 L/min.

The results at a flow rate of 3.03 L/min begin to show a trend of larger mean differences in initial and final TDS concentrations at sample port 1. When comparing the 10.16 cm diverter chambers with an upward and downward oriented sanitary tee, a straight tee, and a straight tee with a floating ball as transition fittings at the experimental

flow rate of 3.03 L/min, there are minimal differences in the mean differences in initial and final TDS concentrations at every sample port (Figure 31).

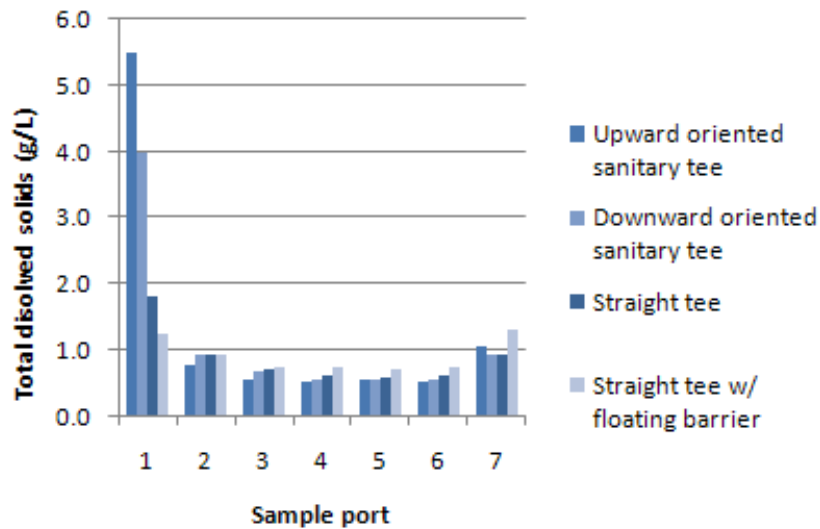

Figure 31. Comparison of the mean differences in initial and final total dissolved solids concentration in four downspout first flush diverters with a 10.16 cm diverter chamber at a flow rate of 3.03 L/min.

The results at a flow rate of 12.11 L/min show larger mean differences in initial and final TDS concentrations at sample port 1 for all transition fittings except the straight tee with floating barrier (Figure 32). When comparing the 10.16 cm diverter chambers with an upward and downward oriented sanitary tee, a straight tee, and a straight tee with a floating ball as transition fittings at the experimental flow rate of 12.11 L/min, there are minimal differences in the mean differences in initial and final TDS concentrations at sample ports 2-7 (Figure 32).

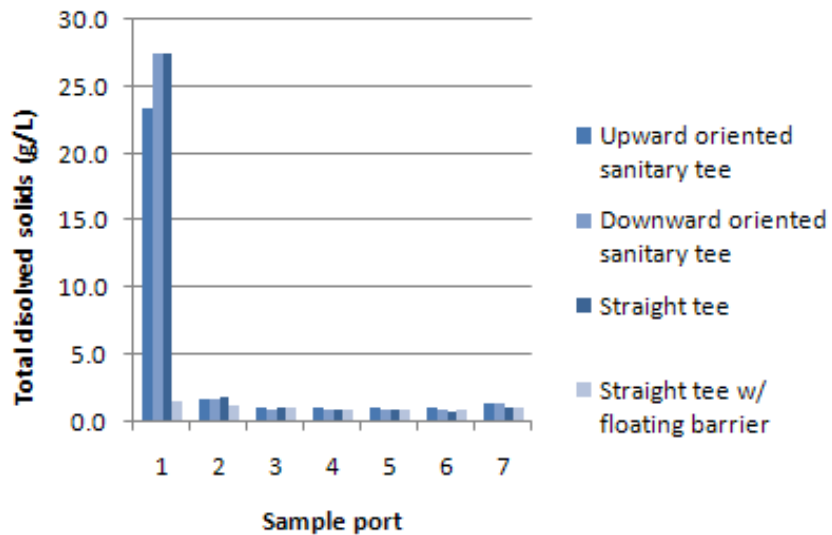

Figure 32. Comparison of the mean differences in initial and final total dissolved solids concentration in four downspout first flush diverters with a 10.16 cm diverter chamber at a flow rate of 12.11 L/min.

Similar to the results at a flow rate of 12.11 L/min, the results at 22.71 L/min show a large mean difference in initial and final TDS concentrations at sample port 1 for all transition fittings except the straight tee with floating barrier (Figure 33). When comparing the 10.16 cm diverter chambers with an upward and downward oriented sanitary tee, a straight tee, and a straight tee with a floating ball as transition fittings at the experimental flow rate of 22.71 L/min, there are minimal differences in the mean differences in initial and final TDS concentrations at sample ports 2-7 (Figure 33).

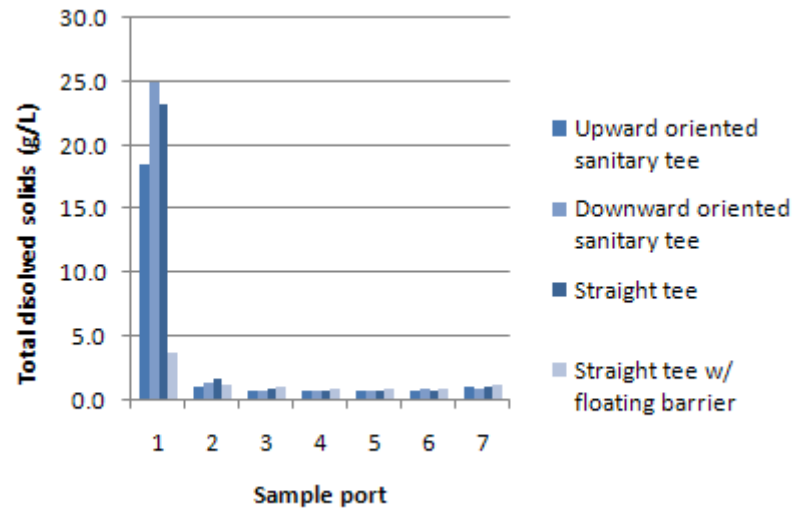

Figure 33. Comparison of the mean differences in initial and final total dissolved solids concentration in four downspout first flush diverters with a 10.16 cm diverter chamber at a flow rate of 22.71 L/min.

The results at 43.91 L/min show large mean differences in initial and final TDS concentrations at sample ports 1 and 2 for all transition fittings except the straight tee with floating barrier (Figure 34). When comparing the 10.16 cm diverter chambers with an upward and downward oriented sanitary tee, a straight tee, and a straight tee with a floating ball as transition fittings at the experimental flow rate of 43.91 L/min, there are minimal differences in the mean differences in initial and final TDS concentrations at sample ports 3-7 (Figure 34).

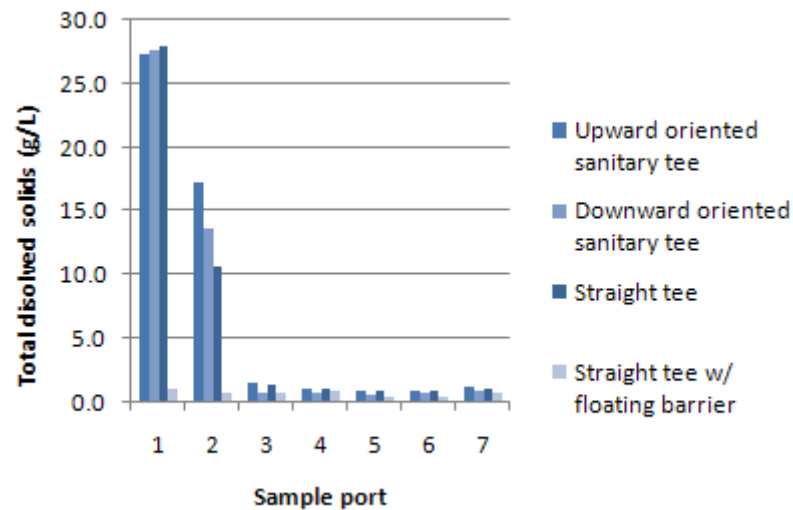

Figure 34. Comparison of the mean differences in initial and final total dissolved solids concentration in four downspout first flush diverters with a 10.16 cm diverter chamber at a flow rate of 43.91 L/min.

The results at 75.71 L/min show a large mean difference in initial and final TDS concentrations at sample port 1 for all transition fittings except the straight tee with floating barrier (Figure 35). When comparing the 10.16 cm diverter chambers with an upward and downward oriented sanitary tee, a straight tee, and a straight tee with a floating ball as transition fittings at the experimental flow rate of 75.711 L/min, there are minimal differences in the mean differences in initial and final TDS concentrations at sample ports 2-7 (Figure 35). This figure does show a slight irregularity in the data at sample port 2 when compared to the flow rate of 43.91 and 113.56 L/min that show large mean differences in initial and final TDS concentrations at sample port 2.

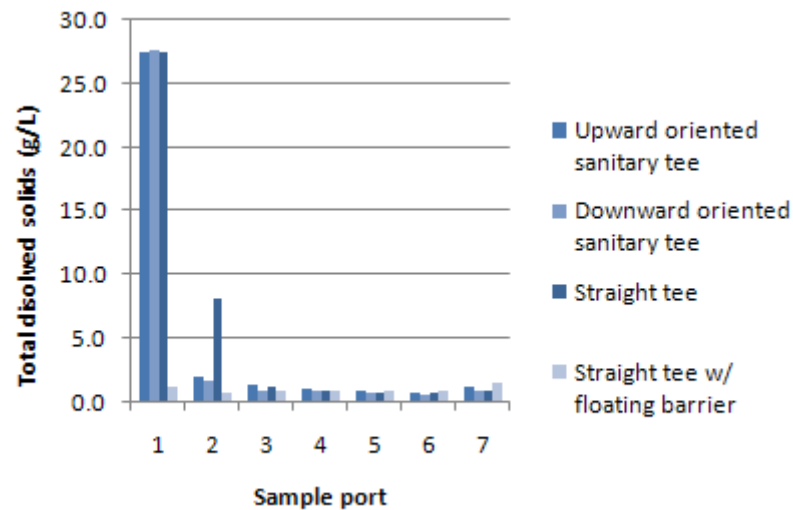

Figure 35. Comparison of the mean differences in initial and final total dissolved solids concentration in four downspout first flush diverters with a 10.16 cm diverter chamber at a flow rate of 75.71 L/min.

The results at 113.56 L/min show a large mean difference in initial and final TDS concentrations at sample ports 1 and 2 for all transition fittings except the straight tee with floating barrier (Figure 36). The straight tee transition fitting also shows a minimal mean difference in initial and final TDS concentration at sample port 2. When comparing the 10.16 cm diverter chambers with an upward and downward oriented sanitary tee, a straight tee, and a straight tee with a floating ball as transition fittings at the experimental flow rate of 113.56 L/min, there are minimal differences in the mean differences in initial and final TDS concentrations at sample ports 3-7 (Figure 36).

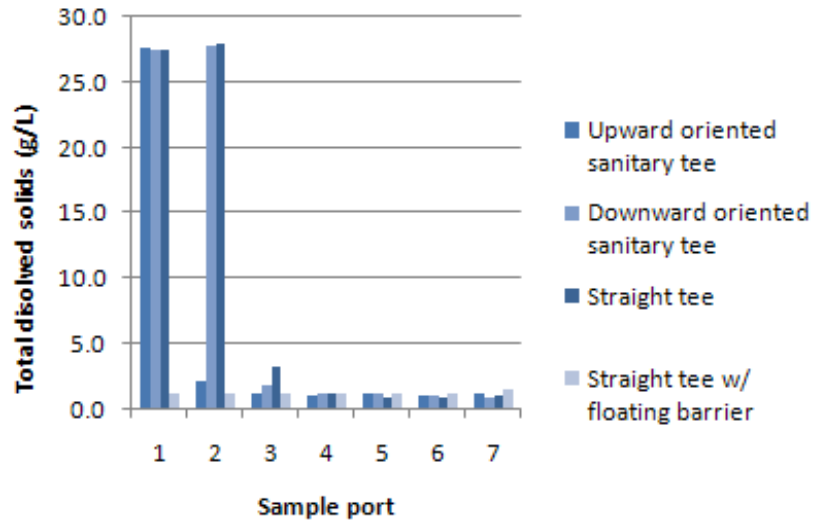

Figure 36. Comparison of the mean differences in initial and final total dissolved solids concentration in four downspout first flush diverters with a 10.16 cm diverter chamber at a flow rate of 113.56 L/min.

These results suggest the depths of interaction, based on the location of the sample ports, due to the dilution of the initial solution in the diverter chamber in each experimental test. The experimental results suggest that an interaction between the diverted water in the diverter chamber and the simulated flow of rainwater does not occur with any of the tested transition fittings at flow rates of 3.03 L/min or less. The results also suggest that at all flow rates tested the straight tee with a floating barrier displayed no interaction at any sample port. The results show that at flows of 12.11 , 22.71, and 75.71 L/min large mean differences in the initial and final TDS concentrations were observed only at sample port 1, which is located at a depth of 30.5 cm in the diverter chamber (Figure 5), in the diverter chambers utilizing the a straight tee, upward and downward oriented sanitary tees. The results also show large mean

differences in the initial and final TDS concentrations were observed at flows of 43.91 and 113.56 L/min the diverters with a straight tee, upward and downward oriented sanitary tees at sample ports 1 and 2, which are located at a depth of 30.5 and 61 cm, respectively, in the diverter chamber (Figure 5).

Overall, the downspout first flush diverter that utilized the straight tee with a floating ball as the downspout to diverter chamber transition fitting outperformed all other transition fittings. While utilizing the floating ball as a barrier, the straight tee was the most effective at deterring diverted water from interacting with the subsequent flow of harvested rainwater. It was determined that utilizing a straight tee as a transition fitting with a floating ball acting as a barrier between water collected in the diverter chamber of a downspout first flush diverter and the flow passing through the transition fitting limits water from interacting with the subsequent flow of harvested rainwater. Results of the remaining transition fittings, the straight tee and the upward and downward oriented sanitary tees showed that there are minimal differences in the mean differences in initial and final TDS concentrations observed at experimental flow rates and sample ports.

Observation of Recommended First Flush Diversion Volumes

Results may be utilized to aid in observing the various recommendations on volumes of rainwater to be diverted by the first flush diverters. Since the results suggest the depths of interaction, based on the location of the sample ports due to the dilution of the initial solution in the diverter chamber, we can assume that diverted water located below the sample ports that showed an interaction is effectively diverted. Diverter

chamber designs that account for the interaction of diverted water require additional length. This additional length allows the desired volume of diverted water to be located below the level at which an interaction between the diverted water and subsequent flow of rainwater occurs. To account for this additional length of diverter chamber needed, downspout first flush diverters of similar configurations to the ones tested in the experiment should be designed with additional length to allow for an interaction layer in the diverter chamber while keeping the diverted water in the diverter chamber.

Rainfall Characteristics

Based on the preliminary experiment, if rainfall characteristics and system configurations allow, it is advantageous to allow the diverter chamber to drain during rainfall events. In certain areas where rainfall patterns and frequencies produce rain events with low intensities, utilizing a drain on a diverter chamber will result in the loss of a significant volume of water through the diverter chamber. In this situation, the diverter chamber drain should either be closed, the flow rate should be decreased, or an automatic control valve on the drain should be installed. In the case that the diverter chamber drain is normally closed, the diverter chamber should be drained after every rainfall event, the diverter should be designed with an increased length to compensate for the interaction of diverted water, or the treatment system after storage should be designed for the additional constituents that may be present in the diverted water that bypasses or is transported out of the diverter chamber. In locations where rainfall patterns and frequencies produce rain events with high intensities, the volume of water lost through the diverter chamber drain will be minimal. Although the volume of water

lost will be minimal compared to the volume collected in storage, care should be taken when selecting a diverter chamber drain flow rate. When the diverter chamber drain is continuously open, a properly selected flow rate may effectively decrease the volume of water that diverter chamber must contain, assuming the initial design has added additional length to account for interaction of the diverted water and the subsequent flow of harvested rainwater. This is due to the fact that the diverted water collected at the beginning of the rainfall event begins to drain immediately, thereby decreasing the additional depth of diverted water recommended.

CONCLUSIONS

The goal of the experiment was focused on understanding the influence of flow rate, diverter chamber diameter, and diverter chamber to downspout transition fitting on the movement of contaminants within a downspout first flush diverter. Through this research the following conclusions were developed:

1. The diverter chamber to downspout transition fittings tested on a 10.16 cm diameter diverter chamber, upward and downward oriented sanitary and straight tee, do not have a significant impact on the mean difference in initial and final TDS concentrations observed at multiple sample ports.
2. No statistical difference was observed when comparing upward and downward oriented sanitary tees used as diverter chamber to downspout transition fittings on 10.16 and 15.24 cm diverter chambers.
3. Utilizing a straight tee as a transition fitting with a floating ball, acting as a barrier between water collected in the diverter chamber of a downspout first flush diverter and the flow passing through the transition fitting, limited diverted water from interacting with the subsequent flow of harvested rainwater.
4. There is not a significant difference between the use of a downspout first flush diverter with diameters of 10.16 and 15.24 cm utilizing upward and downward oriented sanitary tees as downspout to diverter chamber transition fittings.

5. Tests at flow rates less than or equal to 12.1 L/min exhibited limited changes in total dissolved solids concentrations in the downspout first flush diverters with 15.24 cm diameter diverter chambers.
6. Tests at flow rates less than or equal to 1.5 L/min exhibited limited changes in total dissolved solids concentrations in the downspout first flush diverters with 10.16 cm diameter diverter chambers.
7. The diverter chamber drain flow rate and volume impacts the observed differences in initial and final TDS concentrations at all sample ports on the diverter chamber of a downspout first flush diverter regardless of flow rate.
8. The diverter chamber drain flow rate impacts the flow rate of water entering the diverter chamber through the transition fitting.

FUTURE RESEARCH

Many areas surrounding the subject of rainwater harvesting first flush diverters still must be addressed in order to understand all processes at work. Future work should look at additional downspout first flush diverter configurations that promote decreased interaction of diverted water with the subsequent flow of harvested rainwater.

Additional research is also needed for determining the time it takes for the layers of interaction in the diverter chamber to form and its boundary characteristics. Knowing the boundary characteristics between the diverted and layer of interaction would enable more accurate determination of the location of that layer boundary. Understanding the time it takes for the layers to form would allow one to more accurately determine the effectiveness of the diverter chamber drain. Analysis of rainfall characteristics to determine acceptable diverter chamber drain flow rates would allow for application of the first flush diverters with diverter drains in locations with challenging rainfall characteristics.

REFERENCES

- Abbott, S.E., J. Douwes, and B.P. Caughley. 2006. A systematic evaluation of measures improving the quality of roof-collected rainwater. In *Proc. NZWWA's 48 Annual Water Conference*. Christchurch, New Zealand.
- Abbott, S.E., B.P. Caughley, A. Ward, G. Gowan, and M. Heinrich. 2007. Quantifying first flush diversion volumes for potable roof-collected rainwater. In *Proc. NZWWA 49th Annual Conference*. Rotorua, New Zealand.
- Abbott, S. E. 2008. Overcoming Impediments to Rainwater Harvesting. In *Proc. New Zealand Institute of Environmental Health Conference*. Auckland, New Zealand.
- American Rainwater Catchment Systems Association (ARCSA). 2008. Austin, TX. Draft Rainwater Catchment Design and Installation Standards.
- Branz. 2006. *Rainwater Collection for Domestic Use. No. 478*. Wellington, New Zealand. Building Research Association, New Zealand.
- Coombes, R., J. Argue, and G. Kuczera. 2000. Rainwater quality from roofs tanks, and hot water systems at Fig Tree Place. In *Proc. Third International Hydrological and Water Resources Symposium*. Perth, Australia.
- enHealth Council. 2004. Guidance on Use of Rainwater Tanks. Canberra, Australia. Department of Health and Ageing. Australian Government.
- Evans, C.A., Coombes, P.J., Dunstan, R.H. 2006. Wind, rain and bacteria: The effect of weather on the microbial composition of roof harvested rainwater. *Water Research*. 40:37-44.
- Gardner, T., J. Baisden, and G. Millar. 2004. *Rainwater Catchment Systems for Domestic Supply: Design, Construction, and Implementation*. London: Intermediate Technology Publications Ltd.

- Haan, C. T., J. C. Barfield. 1994. *Design Hydrology and Sedimentology for Small Catchments*. San Diego, CA: Academic Press, Inc.
- IAPMO. 2000. Uniform Plumbing Code 2000. Los Angeles, CA: The International Association of Plumbing and Mechanical Codes (IAPMO).
- Jenkins, D. and F. Pearson 1978. Feasibility of rainwater collection systems in California. Davis, CA: California Water Resources Centre, University of California.
- Kim, R. H., S. Lee, Y. M Kim, J. H Lee, S. K Kim, S. G Kim. 2005. Pollutants in rainwater runoff in Korea: Their impacts on rainwater utilization. *Environmental Technology*. 26:11-420.
- Klein, P.D., D. Y. Graham, A. Gaillour, A.R. Opekun, and E. O'Brian Smith. 1991. Water sources as risk factor for helicobacter pylori infection in Peruvian children. *The Lancet*. 377: 1503-1506.
- Koplan, J.P., R. D. Deen, W. H. Swanston, and B. Tota. 1978. Contaminated roof-collected rainwater as a possible cause of an outbreak of samnoellosis. *Journal of Hygiene*. 81: 303-309.
- Krishna, J. 2005. *The Texas Manual of Rainwater Harvesting*, 3rd Ed. Austin, TX: Texas Water Development Board (TWDB).
- Lye, D.J. 1991. Microbial Levels in Cistern Systems: Acceptable or Unacceptable. In *Proc. Fifth International Conference on Rain Water Cistern Systems*. Taiwan, Republic of China.
- Lye, D.J. 1996. *Water Quality of American Cistern Systems*. Austin, TX: American Rainwater Catchment Systems Association (ARCSA).

- Lye, D. J. 2002. Health risks associated with consumption of untreated water from household roof catchment systems. *American Water Resources Association*. 38: 1301-1306.
- Magyar, M. I., V. G. Mitchell, A. R. Ladson, C. Diaper. 2007. An investigation of rainwater tanks quality and sediment dynamics. *Water Science and Technology*. 56(9): 21-28.
- Martinson, D., and T. Thomas. 2004. Quantifying the first flush phenomenon. In *Proc. 12th International Rainwater Catchment Systems Association Conference*. New Delhi, India.
- Melidis, P., C.S. Akratos, V. A. Tsihrintzis, and E. Trikilidou. 2007. Characterization of rain and roof drainage water quality in Xanthi, Greece. *Environmental Monitoring Assessment*. 127: 15-27.
- Mid-West Plan Service (MWPS). 1979. *Private Water Systems Handbook*. Ames, IA: MWPS-14. Iowa State University.
- Ministry of Health (MOH). 2005. *Small, Individual and Roof Water Supplies: Guidelines for drinking water quality management for New Zealand*. Wellington, New Zealand.
- Ministry of Health (MOH). 2006. *Water collections tanks and safe household water: Code 10148*. Wellington, New Zealand.
- Moore, C., and R. Norton. 1995. *Corynebacterium aquaticum* septicæmi in neurogenic patient. *Journal of Clinical Pathology*. 48: 971-972.
- National Climate Data Center (NCDC). 2009. Hourly Precipitation Data Rainfall Event Statistics. Date accessed: 7/30/2008. In: <http://hurricane.ncdc.noaa.gov/cgi-bin/HPD/HPDStats.pl>.

- Ntale, H.K., and N. Moses. 2003. Improving quality of harvested rainwater by using first flush interceptors/retainers. In *Proc. 11th International Conference on Rainwater Catchment Systems*. Texcaco, Mexico.
- Polkowska, Z., T. Gorecki, J. Namiesnik. 2002. Quality roof runoff waters from an urban region. Gdansk, Poland. *Chemosphere*. 49: 1275-1283.
- Ruskin, R.H., D.J. Lye, and J.H. Krishna. 1992. The Need to Separate Water Quality Standards for Cistern Water Systems: A Review. London: *Journal of Environmental Science and Health*. Part A, 27:8,2123 — 2166.
- Schlech, W.F., G.W. Gorman, M.C. Payne, and C.V. Broome. 1985. Legionnaires Disease in the Caribbean: an outbreak associated with a resort hotel. *Archives Internal Medicine*. 145:2067-2079.
- Simmons, G., V. Hope, G. Lewis, J. Whitmore, and W. Gao. 2001. Contamination of potable roof-collected rainwater in Auckland, New Zealand. *Water Research*. 35(6): 1518-1524.
- Soil Conservation Service. 1973. A Method for Estimating Volume and Rate of Runoff in Small Watersheds. SCS-TP-149. Washington, D.C: U.S. Department of Agriculture, Soil Conservation Services.
- Soil Conservation Service. 1986. Urban Hydrology for Small Watersheds. Technical Release No. 55. Washington, D.C: U.S: Department of Agriculture, Soil Conservation Service.
- Standards Australia. 2006. Rainwater Tank Design and Installation Handbook. HB 230-2006. 1st Ed. Sydney. Standards Australia.
- Texas Rainwater Harvesting Evaluation Committee. 2006. Rainwater Harvesting Potential and Guidelines for Texas. Report to the 80th Texas Legislature. Austin, TX: Texas Water Development Board.
- Wade, R. 2003. *Sustainable Water from Rain Harvesting*. 3rd Edition. Queensland, Australia. Environmental Conservation Planning and Consultancy, Pty Ltd.

World Health Organization (WHO). 2004. *Guidelines for Drinking Water Quality*. 3rd Ed. Vol. 1. Geneva, Switzerland.

Yaziz, M.I., H. Gunting, N. Sapari, and A.W. Ghazali. 1989. Variations in rainwater quality from roof catchments. *Water Research*. 23: 761-765.

APPENDIX A

Table A-1. Three collected data sets for Diverter A at 0.76 L/min flow rate with the diverter chamber drain closed.

Replication 1					
Time (min)	Sample port	Conductivity (ms/cm)	Total dissolved solids (g/L)	Salinity	Temp (°C)
0.0	-	43.9	29.3	27.6	19.6
30.0	1	36.8	24.5	22.7	18.1
30.0	2	39.6	26.3	24.5	18.1
30.0	3	41.1	27.4	25.5	18.1
30.0	4	41.6	27.7	25.9	18.2
30.0	5	41.3	27.5	25.7	18.3
30.0	6	43.1	28.6	26.7	18.4
30.0	7	41.7	27.8	26.0	18.4
Replication 2					
Time (min)	Sample port	Conductivity (ms/cm)	Total dissolved solids (g/L)	Salinity	Temp (°C)
0.0	-	43.9	29.2	27.6	18.1
30.0	1	42.2	28.0	26.4	17.4
30.0	2	42.7	28.4	26.6	17.4
30.0	3	42.2	28.1	26.4	17.5
30.0	4	40.8	27.1	25.3	17.7
30.0	5	41.2	27.4	25.5	17.7
30.0	6	41.8	27.9	26.1	17.8
30.0	7	42.0	28.1	26.4	17.8
Replication 3					
Time (min)	Sample port	Conductivity (ms/cm)	Total dissolved solids (g/L)	Salinity	Temp (°C)
0.0	-	43.5	29.0	27.4	18.3
30.0	1	42.4	28.2	26.4	17.5
30.0	2	42.8	28.5	26.7	17.6
30.0	3	42.9	28.5	26.7	17.6
30.0	4	42.9	28.5	26.8	17.7
30.0	5	42.9	28.6	26.8	17.7
30.0	6	42.8	28.5	26.7	17.8
30.0	7	42.4	28.2	26.5	17.7

Table A-2. Three collected data sets for Diverter B at 0.76 L/min flow rate with the diverter chamber drain closed.

Replication 1					
Time (min)	Sample port	Conductivity (ms/cm)	Total dissolved solids (g/L)	Salinity	Temp (°C)
0.0	-	43.9	29.3	27.6	19.6
30.0	1	39.5	26.4	24.5	18.1
30.0	2	41.4	27.5	25.7	18.1
30.0	3	41.8	27.8	26.0	18.1
30.0	4	43.2	28.7	27.9	18.2
30.0	5	43.5	28.9	27.2	18.4
30.0	6	43.3	28.8	27.1	18.5
30.0	7	42.7	28.5	26.8	18.4
Replication 2					
Time (min)	Sample port	Conductivity (ms/cm)	Total dissolved solids (g/L)	Salinity	Temp (°C)
0.0	-	43.9	29.2	27.6	18.1
30.0	1	40.8	27.2	25.7	17.7
30.0	2	42.6	28.4	26.5	17.7
30.0	3	41.1	27.3	25.4	17.7
30.0	4	42.9	28.6	26.8	17.7
30.0	5	41.2	27.4	25.5	17.7
30.0	6	42.4	28.2	26.4	17.7
30.0	7	42.6	28.4	26.6	17.8
Replication 3					
Time (min)	Sample port	Conductivity (ms/cm)	Total dissolved solids (g/L)	Salinity	Temp (°C)
0.0	-	43.5	29.0	27.4	18.3
30.0	1	40.9	27.2	25.5	18.1
30.0	2	40.8	27.1	25.4	18.1
30.0	3	41.3	27.5	25.6	18.1
30.0	4	42.4	28.2	26.5	18.1
30.0	5	42.4	28.2	26.5	18.1
30.0	6	42.4	28.3	26.5	18.1
30.0	7	42.1	28.1	26.3	18.0

Table A-3. Three collected data sets for Diverter C at 0.76 L/min flow rate with the diverter chamber drain closed.

Replication 1					
Time (min)	Sample port	Conductivity (ms/cm)	Total dissolved solids (g/L)	Salinity	Temp (°C)
0.0	-	43.9	29.3	27.6	19.6
30.0	1	42.4	28.3	26.5	17.6
30.0	2	43.4	28.9	27.0	17.8
30.0	3	43.5	29.0	27.2	17.9
30.0	4	43.2	28.6	26.9	18.1
30.0	5	43.6	29.0	27.2	18.2
30.0	6	43.3	28.7	27.0	18.3
30.0	7	42.7	28.4	26.7	18.2
Replication 2					
Time (min)	Sample port	Conductivity (ms/cm)	Total dissolved solids (g/L)	Salinity	Temp (°C)
0.0	-	43.9	29.2	27.6	18.1
30.0	1	42.2	28.1	26.4	17.7
30.0	2	41.0	27.2	25.5	17.5
30.0	3	42.6	28.3	26.5	17.5
30.0	4	42.9	28.4	26.6	17.6
30.0	5	41.4	27.6	25.8	17.6
30.0	6	42.9	28.5	26.8	17.6
30.0	7	41.4	27.6	25.6	17.5
Replication 3					
Time (min)	Sample port	Conductivity (ms/cm)	Total dissolved solids (g/L)	Salinity	Temp (°C)
0.0	-	43.5	29.0	27.4	18.3
30.0	1	42.6	28.3	26.6	18.0
30.0	2	42.7	28.4	26.7	17.8
30.0	3	42.7	28.4	26.7	17.8
30.0	4	42.7	28.4	26.6	17.8
30.0	5	42.6	28.3	26.6	17.9
30.0	6	42.6	28.3	26.6	17.9
30.0	7	42.6	27.8	26.1	17.7

Table A-4. Three collected data sets for Diverter D at 0.76 L/min flow rate with the diverter chamber drain closed.

Replication 1					
Time (min)	Sample port	Conductivity (ms/cm)	Total dissolved solids (g/L)	Salinity	Temp (°C)
0.0	-	43.6	29.0	27.4	21.8
30.0	1	41.3	27.8	26.2	21.7
30.0	2	42.7	28.4	26.9	21.7
30.0	3	42.8	28.5	26.9	21.7
30.0	4	42.7	28.4	26.9	21.8
30.0	5	42.8	28.5	27.0	21.8
30.0	6	42.7	28.4	26.9	21.8
30.0	7	42.4	28.2	26.7	21.8
Replication 2					
Time (min)	Sample port	Conductivity (ms/cm)	Total dissolved solids (g/L)	Salinity	Temp (°C)
0.0	-	43.8	29.2	27.7	21.8
30.0	1	41.3	27.4	25.9	21.8
30.0	2	42.6	28.4	26.8	21.8
30.0	3	42.8	28.5	27.0	21.9
30.0	4	42.8	28.5	27.0	21.9
30.0	5	42.7	28.5	26.8	21.9
30.0	6	42.6	28.4	26.9	21.9
30.0	7	42.2	28.0	26.5	21.8
Replication 3					
Time (min)	Sample port	Conductivity (ms/cm)	Total dissolved solids (g/L)	Salinity	Temp (°C)
0.0	-	43.7	29.1	27.6	21.8
30.0	1	41.5	27.6	26.1	21.9
30.0	2	42.6	28.4	26.8	21.9
30.0	3	42.7	28.4	26.9	21.9
30.0	4	42.6	28.4	26.9	21.9
30.0	5	42.6	28.4	26.9	21.9
30.0	6	42.6	28.4	26.8	21.9
30.0	7	42.3	28.2	26.7	21.8

Table A-5. Three collected data sets for Diverter E at 0.76 L/min flow rate with the diverter chamber drain closed.

Replication 1					
Time (min)	Sample port	Conductivity (ms/cm)	Total dissolved solids (g/L)	Salinity	Temp (°C)
0.0	-	43.6	29.0	27.4	21.8
30.0	1	40.7	27.1	25.5	21.7
30.0	2	41.8	27.8	26.2	21.7
30.0	3	42.2	28.1	26.5	21.8
30.0	4	42.4	28.2	26.7	21.8
30.0	5	42.5	28.3	26.8	21.8
30.0	6	42.4	28.3	26.7	21.8
30.0	7	42.0	28.0	26.5	21.8
Replication 2					
Time (min)	Sample port	Conductivity (ms/cm)	Total dissolved solids (g/L)	Salinity	Temp (°C)
0.0	-	43.8	29.2	27.7	21.8
30.0	1	41.8	27.7	26.2	21.8
30.0	2	42.5	28.3	26.7	21.8
30.0	3	42.9	28.5	27.0	21.8
30.0	4	42.8	28.5	27.0	21.8
30.0	5	42.8	28.5	27.0	21.8
30.0	6	42.7	28.4	26.9	21.8
30.0	7	42.4	28.3	26.6	21.8
Replication 3					
Time (min)	Sample port	Conductivity (ms/cm)	Total dissolved solids (g/L)	Salinity	Temp (°C)
0.0	-	43.7	29.1	27.6	21.8
30.0	1	42.2	28.1	26.4	21.8
30.0	2	42.6	28.3	26.8	21.8
30.0	3	42.7	28.4	26.9	21.8
30.0	4	42.6	28.3	26.8	21.9
30.0	5	42.7	28.4	26.8	21.9
30.0	6	42.6	28.4	26.8	21.8
30.0	7	42.3	28.2	26.7	21.8

Table A-6. Three collected data sets for Diverter F at 0.76 L/min flow rate with the diverter chamber drain closed.

Replication 1					
Time (min)	Sample port	Conductivity (ms/cm)	Total dissolved solids (g/L)	Salinity	Temp (°C)
0.0	-	44.3	29.5	27.8	18.2
30.0	1	41.1	27.4	25.7	18.6
30.0	2	42.0	27.9	26.2	18.6
30.0	3	42.5	28.3	26.6	18.5
30.0	4	42.9	28.5	26.8	18.4
30.0	5	43.0	28.6	26.9	18.4
30.0	6	43.0	28.7	26.9	18.3
30.0	7	42.5	28.4	26.7	18.2
Replication 2					
Time (min)	Sample port	Conductivity (ms/cm)	Total dissolved solids (g/L)	Salinity	Temp (°C)
0.0	-	43.9	29.2	27.5	18.4
30.0	1	42.1	28.0	26.3	18.4
30.0	2	42.5	28.3	26.5	18.3
30.0	3	42.9	28.6	26.8	18.2
30.0	4	43.0	28.7	26.9	18.2
30.0	5	43.2	28.7	27.0	18.1
30.0	6	43.2	28.8	27.0	18.1
30.0	7	42.5	28.4	26.8	18.0
Replication 3					
Time (min)	Sample port	Conductivity (ms/cm)	Total dissolved solids (g/L)	Salinity	Temp (°C)
0.0	-	43.9	29.2	27.5	18.4
30.0	1	43.5	28.9	26.9	16.9
30.0	2	43.8	29.1	27.3	17.1
30.0	3	43.8	29.1	27.3	17.2
30.0	4	43.7	29.1	27.3	17.5
30.0	5	43.5	28.9	27.2	17.6
30.0	6	43.4	28.9	27.2	17.7
30.0	7	42.7	28.5	26.7	17.7

Table A-7. Three collected data sets for Diverter A at 1.51 L/min flow rate with the diverter chamber drain closed.

Replication 1					
Time (min)	Sample port	Conductivity (ms/cm)	Total dissolved solids (g/L)	Salinity	Temp (°C)
0.0	-	44.1	29.4	27.6	18.0
30.0	1	43.2	28.7	27.0	17.9
30.0	2	43.3	28.8	27.1	17.9
30.0	3	43.4	28.9	27.2	17.9
30.0	4	43.0	28.9	27.2	17.9
30.0	5	43.5	28.9	27.2	17.9
30.0	6	43.5	29.0	27.3	17.8
30.0	7	43.4	28.9	27.2	17.8
Replication 2					
Time (min)	Sample port	Conductivity (ms/cm)	Total dissolved solids (g/L)	Salinity	Temp (°C)
0.0	-	43.9	29.3	27.6	18.4
30.0	1	41.6	27.8	26.1	19.0
30.0	2	41.9	27.9	26.3	18.8
30.0	3	42.4	28.2	26.6	18.6
30.0	4	42.6	28.4	26.7	18.6
30.0	5	42.7	28.4	26.7	18.5
30.0	6	42.7	28.5	26.7	18.4
30.0	7	42.4	28.3	26.6	18.3
Replication 3					
Time (min)	Sample port	Conductivity (ms/cm)	Total dissolved solids (g/L)	Salinity	Temp (°C)
0.0	-	43.8	29.2	27.6	19.7
30.0	1	42.8	28.5	26.8	18.9
30.0	2	43.3	28.7	27.0	18.9
30.0	3	43.2	28.8	27.0	19.0
30.0	4	43.2	28.7	27.1	19.0
30.0	5	43.1	28.7	27.0	19.1
30.0	6	43.0	28.6	27.0	19.2
30.0	7	42.9	28.7	26.9	19.2

Table A-8. Three collected data sets for Diverter B at 1.51 L/min flow rate with the diverter chamber drain closed.

Replication 1					
Time (min)	Sample port	Conductivity (ms/cm)	Total dissolved solids (g/L)	Salinity	Temp (°C)
0.0	-	44.1	29.4	27.6	18.0
30.0	1	43.1	28.6	26.9	17.7
30.0	2	43.2	28.7	27.0	17.7
30.0	3	43.5	29.0	27.2	17.7
30.0	4	43.5	29.0	27.2	17.7
30.0	5	43.5	29.0	27.2	17.7
30.0	6	43.5	29.0	27.2	17.7
30.0	7	43.3	28.8	27.1	17.7
Replication 2					
Time (min)	Sample port	Conductivity (ms/cm)	Total dissolved solids (g/L)	Salinity	Temp (°C)
0.0	-	43.9	29.3	27.6	18.4
30.0	1	42.5	28.3	26.6	18.7
30.0	2	42.8	28.5	26.8	18.6
30.0	3	43.6	28.4	26.7	18.5
30.0	4	42.7	28.5	26.8	18.5
30.0	5	42.8	28.5	26.8	18.4
30.0	6	42.8	28.5	26.8	18.4
30.0	7	42.4	28.3	26.6	18.3
Replication 3					
Time (min)	Sample port	Conductivity (ms/cm)	Total dissolved solids (g/L)	Salinity	Temp (°C)
0.0	-	43.8	29.2	27.6	19.7
30.0	1	42.7	28.4	26.7	19.1
30.0	2	43.0	28.6	26.9	19.0
30.0	3	43.1	28.7	27.0	19.0
30.0	4	43.1	28.6	27.0	19.1
30.0	5	43.1	28.7	27.0	19.1
30.0	6	43.1	28.7	27.0	19.1
30.0	7	42.5	28.3	26.7	19.1

Table A-9. Three collected data sets for Diverter C at 1.51 L/min flow rate with the diverter chamber drain closed.

Replication 1					
Time (min)	Sample port	Conductivity (ms/cm)	Total dissolved solids (g/L)	Salinity	Temp (°C)
0.0	-	44.1	29.4	27.6	18.0
30.0	1	43.2	28.8	27.0	17.7
30.0	2	43.2	28.8	27.0	17.7
30.0	3	43.3	28.8	27.1	17.7
30.0	4	43.4	28.8	27.0	17.8
30.0	5	43.2	28.8	27.0	17.8
30.0	6	43.0	28.7	26.9	17.9
30.0	7	42.1	28.2	26.4	18.0
Replication 2					
Time (min)	Sample port	Conductivity (ms/cm)	Total dissolved solids (g/L)	Salinity	Temp (°C)
0.0	-	43.9	29.3	27.6	18.4
30.0	1	43.1	28.7	27.0	18.2
30.0	2	43.4	28.9	27.1	18.2
30.0	3	43.5	29.0	27.2	18.2
30.0	4	43.5	29.0	27.3	18.2
30.0	5	43.6	29.0	27.3	18.2
30.0	6	43.5	29.0	27.3	18.3
30.0	7	43.6	29.0	27.3	18.2
Replication 3					
Time (min)	Sample port	Conductivity (ms/cm)	Total dissolved solids (g/L)	Salinity	Temp (°C)
0.0	-	43.8	29.2	27.6	19.7
30.0	1	42.4	28.2	26.5	18.9
30.0	2	42.9	28.5	26.8	18.9
30.0	3	42.8	28.5	26.8	19.0
30.0	4	43.2	28.7	27.1	19.0
30.0	5	43.4	28.8	27.2	19.1
30.0	6	43.3	28.8	27.2	19.1
30.0	7	42.6	28.4	26.7	19.0

Table A-10. Three collected data sets for Diverter D at 1.51 L/min flow rate with the diverter chamber drain closed.

Replication 1					
Time (min)	Sample port	Conductivity (ms/cm)	Total dissolved solids (g/L)	Salinity	Temp (°C)
0.0	-	44.0	29.3	27.6	18.2
30.0	1	42.3	28.4	26.5	18.0
30.0	2	43.1	28.7	26.9	17.9
30.0	3	43.3	28.8	27.0	17.9
30.0	4	43.3	28.7	27.0	18.0
30.0	5	43.2	28.7	27.0	18.0
30.0	6	43.2	28.7	27.0	18.0
30.0	7	43.4	28.3	26.6	17.9
Replication 2					
Time (min)	Sample port	Conductivity (ms/cm)	Total dissolved solids (g/L)	Salinity	Temp (°C)
0.0	-	44.0	29.3	27.6	18.1
30.0	1	42.5	28.2	26.4	17.1
30.0	2	43.4	28.8	27.0	17.4
30.0	3	43.4	28.9	27.1	17.5
30.0	4	43.2	28.8	27.0	17.6
30.0	5	43.1	28.7	26.9	17.7
30.0	6	43.0	28.7	26.8	17.8
30.0	7	42.3	28.2	26.5	17.6
Replication 3					
Time (min)	Sample port	Conductivity (ms/cm)	Total dissolved solids (g/L)	Salinity	Temp (°C)
0.0	-	44.2	29.5	27.7	18.1
30.0	1	44.0	29.3	27.4	16.8
30.0	2	44.2	29.4	27.5	17.1
30.0	3	44.1	29.2	27.5	17.4
30.0	4	43.9	29.1	27.4	17.5
30.0	5	43.6	29.1	27.3	17.7
30.0	6	43.5	29.0	27.2	17.7
30.0	7	42.6	28.4	26.7	17.7

Table A-11. Three collected data sets for Diverter E at 1.51 L/min flow rate with the diverter chamber drain closed.

Replication 1					
Time (min)	Sample port	Conductivity (ms/cm)	Total dissolved solids (g/L)	Salinity	Temp (°C)
0.0	-	44.0	29.3	27.6	18.2
30.0	1	42.2	27.9	26.1	17.8
30.0	2	42.7	28.4	26.6	17.7
30.0	3	42.9	28.5	26.7	17.8
30.0	4	43.1	28.7	26.9	17.7
30.0	5	43.6	29.0	27.3	17.7
30.0	6	43.6	29.0	27.3	17.8
30.0	7	43.8	28.5	26.8	17.7
Replication 2					
Time (min)	Sample port	Conductivity (ms/cm)	Total dissolved solids (g/L)	Salinity	Temp (°C)
0.0	-	44.0	29.3	27.6	18.1
30.0	1	42.4	28.1	26.3	18.1
30.0	2	43.2	28.8	27.0	18.0
30.0	3	43.3	28.8	27.1	18.0
30.0	4	43.3	28.9	27.1	18.0
30.0	5	43.4	28.9	27.2	17.9
30.0	6	43.3	28.8	27.1	17.9
30.0	7	42.5	28.4	26.7	17.9
Replication 3					
Time (min)	Sample port	Conductivity (ms/cm)	Total dissolved solids (g/L)	Salinity	Temp (°C)
0.0	-	44.2	29.5	27.7	18.1
30.0	1	43.9	29.2	27.4	17.6
30.0	2	43.8	29.2	27.5	17.7
30.0	3	44.2	29.4	27.7	17.9
30.0	4	44.0	29.3	27.6	17.9
30.0	5	43.9	29.2	27.5	18.0
30.0	6	43.8	29.2	27.5	18.0
30.0	7	42.9	28.6	26.9	17.9

Table A-12. Three collected data sets for Diverter F at 1.51 L/min flow rate with the diverter chamber drain closed.

Replication 1					
Time (min)	Sample port	Conductivity (ms/cm)	Total dissolved solids (g/L)	Salinity	Temp (°C)
0.0	-	44.2	29.5	27.8	19.6
30.0	1	42.4	28.3	26.6	19.3
30.0	2	42.9	28.5	26.9	19.3
30.0	3	43.0	28.6	27.0	19.3
30.0	4	43.1	28.7	27.1	19.2
30.0	5	43.1	28.7	27.1	19.2
30.0	6	43.2	28.8	27.1	19.1
30.0	7	42.7	28.5	26.8	19.1
Replication 2					
Time (min)	Sample port	Conductivity (ms/cm)	Total dissolved solids (g/L)	Salinity	Temp (°C)
0.0	-	44.1	29.4	27.7	19.0
30.0	1	42.1	28.0	26.3	18.9
30.0	2	42.5	28.3	26.6	18.7
30.0	3	43.0	28.6	26.9	18.7
30.0	4	43.2	28.7	27.0	18.6
30.0	5	43.3	28.8	27.1	18.6
30.0	6	43.3	28.8	27.1	18.6
30.0	7	42.8	28.5	26.8	18.6
Replication 3					
Time (min)	Sample port	Conductivity (ms/cm)	Total dissolved solids (g/L)	Salinity	Temp (°C)
0.0	-	44.2	29.4	27.7	18.6
30.0	1	42.3	28.2	26.5	18.8
30.0	2	42.7	28.4	26.7	18.8
30.0	3	42.9	28.6	26.9	18.7
30.0	4	43.1	28.7	27.0	18.6
30.0	5	43.1	28.7	27.0	18.6
30.0	6	43.0	28.6	26.9	18.6
30.0	7	42.5	28.4	26.7	18.4

Table A-13. Three collected data sets for Diverter A at 3.03 L/min flow rate with the diverter chamber drain closed.

Replication 1					
Time (min)	Sample port	Conductivity (ms/cm)	Total dissolved solids (g/L)	Salinity	Temp (°C)
0.0	-	43.8	29.2	27.5	19.0
30.0	1	41.2	27.4	25.5	17.0
30.0	2	42.9	28.4	26.6	17.4
30.0	3	43.6	29.0	27.2	17.7
30.0	4	43.8	29.1	27.3	18.0
30.0	5	43.8	29.1	27.4	18.1
30.0	6	43.6	29.1	27.3	18.2
30.0	7	43.1	28.7	27.0	18.2
Replication 2					
Time (min)	Sample port	Conductivity (ms/cm)	Total dissolved solids (g/L)	Salinity	Temp (°C)
0.0	-	43.9	29.2	27.5	18.5
30.0	1	42.8	28.4	26.7	17.6
30.0	2	43.4	28.8	27.0	17.7
30.0	3	43.4	28.9	27.1	17.7
30.0	4	43.4	28.9	27.1	17.9
30.0	5	43.4	28.9	27.2	17.9
30.0	6	43.2	28.9	27.1	18.0
30.0	7	42.7	28.5	26.7	18.0
Replication 3					
Time (min)	Sample port	Conductivity (ms/cm)	Total dissolved solids (g/L)	Salinity	Temp (°C)
0.0	-	43.3	28.9	27.3	19.3
30.0	1	41.6	27.7	25.9	18.4
30.0	2	41.9	27.9	26.2	18.4
30.0	3	42.1	28.0	26.3	18.4
30.0	4	42.3	28.1	26.3	18.5
30.0	5	42.3	28.2	26.4	18.6
30.0	6	42.0	28.2	26.5	18.6
30.0	7	42.6	28.3	26.6	18.5

Table A-14. Three collected data sets for Diverter B at 3.03 L/min flow rate with the diverter chamber drain closed.

Replication 1					
Time (min)	Sample port	Conductivity (ms/cm)	Total dissolved solids (g/L)	Salinity	Temp (°C)
0.0	-	43.8	29.2	27.5	19.0
30.0	1	41.8	27.8	26.0	18.2
30.0	2	42.6	28.3	26.6	18.2
30.0	3	42.9	28.5	26.8	18.2
30.0	4	43.0	28.6	26.9	18.3
30.0	5	43.1	28.7	27.0	18.4
30.0	6	43.2	28.7	27.0	18.4
30.0	7	42.7	28.4	26.7	18.3
Replication 2					
Time (min)	Sample port	Conductivity (ms/cm)	Total dissolved solids (g/L)	Salinity	Temp (°C)
0.0	-	43.9	29.2	27.5	18.5
30.0	1	42.9	28.6	26.8	17.7
30.0	2	43.3	28.8	27.0	17.8
30.0	3	43.3	28.8	27.1	17.9
30.0	4	43.2	28.8	27.0	18.0
30.0	5	43.2	28.7	27.0	18.1
30.0	6	43.2	28.8	27.0	18.1
30.0	7	42.7	28.4	26.7	18.1
Replication 3					
Time (min)	Sample port	Conductivity (ms/cm)	Total dissolved solids (g/L)	Salinity	Temp (°C)
0.0	-	43.3	28.9	27.3	19.3
30.0	1	41.6	27.7	25.9	18.4
30.0	2	41.9	27.9	26.1	18.4
30.0	3	42.1	28.0	26.3	18.5
30.0	4	42.1	28.0	26.3	18.5
30.0	5	42.1	28.1	26.3	18.6
30.0	6	42.0	28.0	26.3	18.6
30.0	7	41.4	27.6	25.8	18.6

Table A-15. Three collected data sets for Diverter C at 3.03 L/min flow rate with the diverter chamber drain closed.

Replication 1					
Time (min)	Sample port	Conductivity (ms/cm)	Total dissolved solids (g/L)	Salinity	Temp (°C)
0.0	-	43.8	29.2	27.5	19.0
30.0	1	41.5	27.5	25.8	18.3
30.0	2	42.3	28.2	26.4	18.2
30.0	3	42.8	28.5	26.7	18.3
30.0	4	42.9	28.6	26.9	18.3
30.0	5	43.1	28.7	27.0	18.3
30.0	6	43.1	28.7	27.0	18.4
30.0	7	42.0	28.1	26.4	18.2
Replication 2					
Time (min)	Sample port	Conductivity (ms/cm)	Total dissolved solids (g/L)	Salinity	Temp (°C)
0.0	-	43.9	29.2	27.5	18.5
30.0	1	43.0	28.6	26.8	18.1
30.0	2	43.2	28.7	27.0	18.0
30.0	3	43.2	28.8	27.0	18.1
30.0	4	43.1	28.7	27.0	18.0
30.0	5	43.1	28.7	26.9	18.1
30.0	6	43.0	28.6	26.9	18.1
30.0	7	42.1	28.1	26.4	17.9
Replication 3					
Time (min)	Sample port	Conductivity (ms/cm)	Total dissolved solids (g/L)	Salinity	Temp (°C)
0.0	-	43.3	28.9	27.3	19.3
30.0	1	41.3	27.5	25.8	19.2
30.0	2	41.6	27.7	26.0	19.0
30.0	3	41.8	27.8	26.1	18.9
30.0	4	41.8	27.8	26.1	18.8
30.0	5	41.8	27.8	26.1	18.8
30.0	6	41.8	27.8	26.1	18.8
30.0	7	40.8	27.2	25.6	18.6

Table A-16. Three collected data sets for Diverter D at 3.03 L/min flow rate with the diverter chamber drain closed.

Replication 1					
Time (min)	Sample port	Conductivity (ms/cm)	Total dissolved solids (g/L)	Salinity	Temp (°C)
0.0	-	44.0	29.3	27.8	21.3
30.0	1	41.5	27.6	26.0	20.1
30.0	2	43.6	28.9	27.2	20.2
30.0	3	43.7	29.0	27.4	20.3
30.0	4	43.6	29.0	27.4	20.4
30.0	5	43.6	28.9	27.3	20.5
30.0	6	43.5	28.9	27.3	20.6
30.0	7	42.7	28.5	26.9	20.6
Replication 2					
Time (min)	Sample port	Conductivity (ms/cm)	Total dissolved solids (g/L)	Salinity	Temp (°C)
0.0	-	43.7	29.2	27.5	20.2
30.0	1	39.8	26.5	24.8	20.4
30.0	2	42.4	28.2	26.4	20.5
30.0	3	42.7	28.4	26.8	20.5
30.0	4	42.7	28.4	26.8	20.5
30.0	5	42.7	28.4	26.7	20.5
30.0	6	42.8	28.5	26.8	20.5
30.0	7	42.0	27.8	26.3	20.4
Replication 3					
Time (min)	Sample port	Conductivity (ms/cm)	Total dissolved solids (g/L)	Salinity	Temp (°C)
0.0	-	44.2	29.4	27.9	21.8
30.0	1	26.0	17.3	15.6	20.6
30.0	2	42.9	28.5	26.8	20.8
30.0	3	43.5	28.9	27.4	21.0
30.0	4	43.6	29.0	27.5	21.1
30.0	5	43.4	29.0	27.5	21.2
30.0	6	43.3	29.0	27.3	21.3
30.0	7	42.8	28.5	27.0	21.3

Table A-17. Three collected data sets for Diverter E at 3.03 L/min flow rate with the diverter chamber drain closed.

Replication 1					
Time (min)	Sample port	Conductivity (ms/cm)	Total dissolved solids (g/L)	Salinity	Temp (°C)
0.0	-	44.0	29.3	27.8	21.3
30.0	1	31.3	20.8	19.1	20.4
30.0	2	42.8	28.5	26.9	20.5
30.0	3	43.3	28.8	27.2	20.6
30.0	4	43.4	28.9	27.3	20.7
30.0	5	43.3	28.8	27.3	20.7
30.0	6	43.3	28.8	27.3	20.7
30.0	7	42.5	28.4	26.8	20.7
Replication 2					
Time (min)	Sample port	Conductivity (ms/cm)	Total dissolved solids (g/L)	Salinity	Temp (°C)
0.0	-	44.0	29.2	27.7	20.4
30.0	1	42.0	27.9	26.2	19.5
30.0	2	43.0	28.5	26.7	19.6
30.0	3	43.1	28.5	27.0	19.8
30.0	4	43.1	28.7	27.0	19.9
30.0	5	43.2	28.7	27.1	20.0
30.0	6	43.0	28.7	27.1	20.0
30.0	7	42.4	28.4	26.8	20.0
Replication 3					
Time (min)	Sample port	Conductivity (ms/cm)	Total dissolved solids (g/L)	Salinity	Temp (°C)
0.0	-	44.2	29.4	27.9	21.8
30.0	1	41.1	27.3	25.7	21.3
30.0	2	42.4	28.2	26.7	21.2
30.0	3	43.0	28.6	27.1	21.2
30.0	4	43.1	28.7	27.1	21.3
30.0	5	43.2	28.8	27.2	21.3
30.0	6	43.2	28.8	27.2	21.3
30.0	7	42.6	28.4	26.9	21.3

Table A-18. Three collected data sets for Diverter F at 3.03 L/min flow rate with the diverter chamber drain closed.

Replication 1					
Time (min)	Sample port	Conductivity (ms/cm)	Total dissolved solids (g/L)	Salinity	Temp (°C)
0.0	-	44.0	29.3	27.8	21.3
30.0	1	31.3	20.8	19.1	20.4
30.0	2	42.8	28.5	26.9	20.5
30.0	3	43.3	28.8	27.2	20.6
30.0	4	43.4	28.9	27.3	20.7
30.0	5	43.3	28.8	27.3	20.7
30.0	6	43.3	28.8	27.3	20.7
30.0	7	42.5	28.4	26.8	20.7
Replication 2					
Time (min)	Sample port	Conductivity (ms/cm)	Total dissolved solids (g/L)	Salinity	Temp (°C)
0.0	-	44.2	29.4	27.8	19.6
30.0	1	38.7	25.8	24.0	19.5
30.0	2	42.1	28.0	26.3	19.5
30.0	3	42.8	28.5	26.8	19.5
30.0	4	43.0	28.7	27.0	19.5
30.0	5	43.2	28.8	27.2	19.4
30.0	6	43.3	28.8	27.2	19.4
30.0	7	42.9	28.6	26.9	19.3
Replication 3					
Time (min)	Sample port	Conductivity (ms/cm)	Total dissolved solids (g/L)	Salinity	Temp (°C)
0.0	-	44.2	29.4	27.8	19.6
30.0	1	42.3	28.2	26.5	19.5
30.0	2	42.8	28.5	26.8	19.5
30.0	3	43.0	28.6	27.0	19.4
30.0	4	43.1	28.7	27.1	19.3
30.0	5	43.2	28.7	27.1	19.3
30.0	6	43.1	28.7	27.1	19.3
30.0	7	42.7	28.4	26.8	19.2

Table A-19. Three collected data sets for Diverter A at 12.11 L/min flow rate with the diverter chamber drain closed.

Replication 1					
Time (min)	Sample port	Conductivity (ms/cm)	Total dissolved solids (g/L)	Salinity	Temp (°C)
0.0	-	44.2	29.4	27.8	19.9
30.0	1	40.0	26.6	24.8	19.2
30.0	2	42.6	28.3	26.6	19.5
30.0	3	43.0	28.6	27.0	19.6
30.0	4	43.2	28.8	27.1	19.8
30.0	5	43.2	28.7	27.1	19.8
30.0	6	43.2	28.8	27.2	19.9
30.0	7	43.1	28.7	27.1	19.9
Replication 2					
Time (min)	Sample port	Conductivity (ms/cm)	Total dissolved solids (g/L)	Salinity	Temp (°C)
0.0	-	44.1	29.3	27.7	18.8
30.0	1	43.0	28.6	27.0	19.3
30.0	2	42.9	28.6	26.9	19.4
30.0	3	43.0	28.6	27.0	19.3
30.0	4	42.9	28.6	26.9	19.3
30.0	5	43.0	28.6	27.0	19.3
30.0	6	43.0	28.6	27.0	19.3
30.0	7	43.6	29.1	27.4	19.2
Replication 3					
Time (min)	Sample port	Conductivity (ms/cm)	Total dissolved solids (g/L)	Salinity	Temp (°C)
0.0	-	44.1	29.3	27.8	20.7
30.0	1	42.3	28.2	26.6	20.7
30.0	2	42.7	28.4	26.8	20.7
30.0	3	42.8	28.5	26.9	20.7
30.0	4	42.9	28.6	27.0	20.7
30.0	5	42.9	28.6	27.0	20.7
30.0	6	42.9	28.6	27.0	20.7
30.0	7	42.8	28.6	27.0	20.6

Table A-20. Three collected data sets for Diverter B at 12.11 L/min flow rate with the diverter chamber drain closed.

Replication 1					
Time (min)	Sample port	Conductivity (ms/cm)	Total dissolved solids (g/L)	Salinity	Temp (°C)
0.0	-	44.2	29.4	27.8	19.9
30.0	1	40.1	26.7	25.0	19.9
30.0	2	41.7	27.8	26.1	20.0
30.0	3	42.5	28.3	26.7	20.0
30.0	4	42.7	28.5	26.8	20.1
30.0	5	43.0	28.6	27.0	20.1
30.0	6	43.0	28.6	27.0	20.1
30.0	7	42.9	28.6	27.0	20.1
Replication 2					
Time (min)	Sample port	Conductivity (ms/cm)	Total dissolved solids (g/L)	Salinity	Temp (°C)
0.0	-	44.1	29.3	27.7	18.8
30.0	1	41.0	27.3	25.6	20.4
30.0	2	41.8	27.9	26.3	20.2
30.0	3	42.1	28.1	26.5	20.0
30.0	4	42.3	28.2	26.6	19.8
30.0	5	42.3	28.3	26.7	19.7
30.0	6	42.4	28.3	26.7	19.5
30.0	7	42.5	28.3	26.7	19.5
Replication 3					
Time (min)	Sample port	Conductivity (ms/cm)	Total dissolved solids (g/L)	Salinity	Temp (°C)
0.0	-	44.1	29.3	27.8	20.7
30.0	1	42.5	28.3	26.7	20.6
30.0	2	42.6	28.4	26.8	20.6
30.0	3	42.5	28.3	26.7	20.7
30.0	4	42.4	28.3	26.7	20.7
30.0	5	42.4	28.2	26.7	20.7
30.0	6	42.6	28.4	26.8	20.6
30.0	7	42.5	28.3	26.8	20.6

Table A-21. Three collected data sets for Diverter C at 12.11 L/min flow rate with the diverter chamber drain closed.

Replication 1					
Time (min)	Sample port	Conductivity (ms/cm)	Total dissolved solids (g/L)	Salinity	Temp (°C)
0.0	-	44.2	29.4	27.8	19.9
30.0	1	41.3	27.5	25.8	20.1
30.0	2	42.5	28.3	26.7	20.1
30.0	3	43.0	28.6	27.0	20.2
30.0	4	43.1	28.7	27.1	20.2
30.0	5	43.1	28.7	27.1	20.3
30.0	6	42.9	28.6	27.0	20.3
30.0	7	42.7	28.4	26.9	20.2
Replication 2					
Time (min)	Sample port	Conductivity (ms/cm)	Total dissolved solids (g/L)	Salinity	Temp (°C)
0.0	-	44.1	29.3	27.7	18.8
30.0	1	42.6	28.4	26.7	19.4
30.0	2	42.6	28.4	26.7	19.5
30.0	3	42.8	28.5	26.8	19.5
30.0	4	42.8	28.5	26.9	19.5
30.0	5	42.7	28.5	26.8	19.5
30.0	6	42.7	28.5	26.9	19.4
30.0	7	42.7	28.4	26.8	19.4
Replication 3					
Time (min)	Sample port	Conductivity (ms/cm)	Total dissolved solids (g/L)	Salinity	Temp (°C)
0.0	-	44.1	29.3	27.8	20.7
30.0	1	41.8	27.8	26.2	21.1
30.0	2	42.0	28.0	26.4	21.1
30.0	3	42.2	28.1	26.6	21.1
30.0	4	42.4	28.3	26.7	20.9
30.0	5	42.6	28.4	26.8	20.9
30.0	6	42.7	28.4	26.9	20.9
30.0	7	42.6	28.4	26.9	20.8

Table A-22. Three collected data sets for Diverter D at 12.11 L/min flow rate with the diverter chamber drain closed.

Replication 1					
Time (min)	Sample port	Conductivity (ms/cm)	Total dissolved solids (g/L)	Salinity	Temp (°C)
0.0	-	44.0	29.3	27.7	19.9
30.0	1	1.7	1.2		20.5
30.0	2	40.8	27.2	25.6	20.3
30.0	3	42.0	28.0	26.4	20.5
30.0	4	42.1	28.0	26.4	20.4
30.0	5	42.1	28.1	26.5	20.3
30.0	6	42.2	28.1	26.5	20.1
30.0	7	41.8	27.9	26.3	19.9
Replication 2					
Time (min)	Sample port	Conductivity (ms/cm)	Total dissolved solids (g/L)	Salinity	Temp (°C)
0.0	-	44.0	29.3	27.7	19.8
30.0	1	21.7	14.5	12.9	20.5
30.0	2	41.4	27.7	26.1	20.3
30.0	3	42.3	28.3	26.5	20.2
30.0	4	42.5	28.3	26.6	20.1
30.0	5	42.6	28.4	26.8	20.0
30.0	6	42.6	28.4	26.8	19.9
30.0	7	42.0	28.0	26.9	19.8
Replication 3					
Time (min)	Sample port	Conductivity (ms/cm)	Total dissolved solids (g/L)	Salinity	Temp (°C)
0.0	-	43.8	29.2	27.6	19.9
30.0	1	2.9	1.9		19.5
30.0	2	42.0	28.0	26.1	19.5
30.0	3	43.0	28.6	26.8	19.6
30.0	4	42.8	28.7	27.0	19.7
30.0	5	43.0	28.4	26.8	19.7
30.0	6	42.8	28.5	26.9	19.7
30.0	7	42.0	28.0	26.5	19.6

Table A-23. Three collected data sets for Diverter E at 12.11 L/min flow rate with the diverter chamber drain closed.

Replication 1					
Time (min)	Sample port	Conductivity (ms/cm)	Total dissolved solids (g/L)	Salinity	Temp (°C)
0.0	-	44.0	29.3	27.7	19.9
30.0	1	3.2	2.1		19.8
30.0	2	41.7	27.8	26.1	19.8
30.0	3	42.7	28.4	26.8	19.8
30.0	4	42.7	28.4	26.8	19.8
30.0	5	42.6	28.4	26.7	19.8
30.0	6	42.6	28.4	26.8	19.7
30.0	7	41.8	27.9	26.3	19.6
Replication 2					
Time (min)	Sample port	Conductivity (ms/cm)	Total dissolved solids (g/L)	Salinity	Temp (°C)
0.0	-	44.0	29.3	27.7	19.8
30.0	1	2.1	1.4		19.5
30.0	2	42.0	27.9	26.3	19.5
30.0	3	43.1	28.7	27.1	19.6
30.0	4	42.0	28.7	27.0	19.6
30.0	5	43.1	28.7	27.0	19.7
30.0	6	43.0	28.6	27.0	19.6
30.0	7	42.6	28.2	26.6	19.5
Replication 3					
Time (min)	Sample port	Conductivity (ms/cm)	Total dissolved solids (g/L)	Salinity	Temp (°C)
0.0	-	43.8	29.2	27.6	19.9
30.0	1	2.6	1.7		19.9
30.0	2	41.4	27.6	25.9	19.9
30.0	3	42.6	28.4	26.8	19.9
30.0	4	42.6	28.4	26.7	19.9
30.0	5	42.7	28.4	26.8	19.8
30.0	6	42.7	28.4	26.8	19.8
30.0	7	42.2	28.1	26.5	19.7

Table A-24. Three collected data sets for Diverter F at 12.11 L/min flow rate with the diverter chamber drain closed.

Replication 1					
Time (min)	Sample port	Conductivity (ms/cm)	Total dissolved solids (g/L)	Salinity	Temp (°C)
0.0	-	43.9	29.2	27.8	22.8
30.0	1	2.7	1.8		22.9
30.0	2	41.1	27.4	26.1	23.0
30.0	3	42.2	28.2	26.7	22.9
30.0	4	42.6	28.4	26.9	22.8
30.0	5	42.8	28.5	27.0	22.7
30.0	6	42.8	28.5	27.0	22.6
30.0	7	42.4	28.3	26.8	22.4
Replication 2					
Time (min)	Sample port	Conductivity (ms/cm)	Total dissolved solids (g/L)	Salinity	Temp (°C)
0.0	-	43.9	29.2	27.8	22.8
30.0	1	2.7	1.8		22.8
30.0	2	41.5	27.7	26.2	22.9
30.0	3	42.5	28.3	26.9	22.8
30.0	4	42.7	28.4	26.9	22.7
30.0	5	42.6	28.4	26.9	22.8
30.0	6	42.8	28.5	26.9	22.6
30.0	7	42.1	28.1	26.6	22.4
Replication 3					
Time (min)	Sample port	Conductivity (ms/cm)	Total dissolved solids (g/L)	Salinity	Temp (°C)
0.0	-	44.0	29.2	27.8	22.8
30.0	1	2.7	1.7		22.7
30.0	2	41.2	27.5	26.0	22.8
30.0	3	42.4	28.3	26.8	22.7
30.0	4	42.7	28.4	26.9	22.6
30.0	5	42.7	28.4	27.0	22.5
30.0	6	42.8	28.5	27.0	22.4
30.0	7	42.1	28.2	26.7	22.2

Table A-25. Three collected data sets for Diverter A at 22.71 L/min flow rate with the diverter chamber drain closed.

Replication 1					
Time (min)	Sample port	Conductivity (ms/cm)	Total dissolved solids (g/L)	Salinity	Temp (°C)
0.0	-	43.9	29.2	27.7	21.6
30.0	1	2.2	1.5		21.5
30.0	2	41.0	27.3	25.7	21.5
30.0	3	42.9	28.6	27.0	21.4
30.0	4	43.5	29.0	27.4	21.4
30.0	5	43.6	29.0	27.5	21.4
30.0	6	43.7	29.1	27.6	21.4
30.0	7	43.6	29.0	27.5	21.4
Replication 2					
Time (min)	Sample port	Conductivity (ms/cm)	Total dissolved solids (g/L)	Salinity	Temp (°C)
0.0	-	43.7	29.1	27.6	21.6
30.0	1	2.7	1.8		21.8
30.0	2	41.4	27.4	25.8	21.8
30.0	3	42.6	28.3	26.8	21.7
30.0	4	42.7	28.4	26.9	21.6
30.0	5	42.8	28.5	27.0	21.7
30.0	6	42.6	28.4	26.9	21.7
30.0	7	42.4	28.2	26.8	21.6
Replication 3					
Time (min)	Sample port	Conductivity (ms/cm)	Total dissolved solids (g/L)	Salinity	Temp (°C)
0.0	-	44.1	29.3	27.9	22.2
30.0	1	2.8	1.9		22.1
30.0	2	41.5	27.6	26.1	22.1
30.0	3	42.7	28.4	26.9	22.1
30.0	4	42.9	28.6	27.1	22.1
30.0	5	43.0	28.6	27.1	22.1
30.0	6	42.9	28.6	27.1	22.1
30.0	7	42.7	28.5	27.0	22.1

Table A-26. Three collected data sets for Diverter B at 22.71 L/min flow rate with the diverter chamber drain closed.

Replication 1					
Time (min)	Sample port	Conductivity (ms/cm)	Total dissolved solids (g/L)	Salinity	Temp (°C)
0.0	-	43.9	29.2	27.7	21.6
30.0	1	2.7	1.8		21.4
30.0	2	41.5	27.7	26.1	21.4
30.0	3	42.3	28.2	26.6	21.5
30.0	4	42.7	28.4	26.9	21.5
30.0	5	42.8	28.5	26.9	21.5
30.0	6	42.9	28.5	27.0	21.5
30.0	7	42.8	28.5	27.0	21.5
Replication 2					
Time (min)	Sample port	Conductivity (ms/cm)	Total dissolved solids (g/L)	Salinity	Temp (°C)
0.0	-	43.7	29.1	27.6	21.6
30.0	1	2.0	1.4		22.0
30.0	2	41.0	27.3	25.7	21.9
30.0	3	42.3	28.0	26.5	21.8
30.0	4	42.3	28.2	26.6	21.8
30.0	5	42.4	28.3	26.7	21.8
30.0	6	42.5	28.4	26.2	21.8
30.0	7	42.4	28.2	26.5	21.7
Replication 3					
Time (min)	Sample port	Conductivity (ms/cm)	Total dissolved solids (g/L)	Salinity	Temp (°C)
0.0	-	44.1	29.3	27.9	22.2
30.0	1	2.3	1.6		22.0
30.0	2	41.5	27.7	26.1	22.0
30.0	3	42.9	28.5	27.0	22.0
30.0	4	43.0	28.6	27.1	22.1
30.0	5	43.0	28.6	27.1	22.1
30.0	6	42.9	28.6	27.1	22.1
30.0	7	42.3	28.2	28.2	22.1

Table A-27. Three collected data sets for Diverter C at 22.71 L/min flow rate with the diverter chamber drain closed.

Replication 1					
Time (min)	Sample port	Conductivity (ms/cm)	Total dissolved solids (g/L)	Salinity	Temp (°C)
0.0	-	43.9	29.2	27.7	21.6
30.0	1	30.3	20.2	18.6	21.6
30.0	2	41.9	27.9	26.3	21.5
30.0	3	42.7	28.4	26.8	21.5
30.0	4	42.9	28.6	27.0	21.5
30.0	5	43.0	28.6	27.1	21.6
30.0	6	43.0	28.6	27.1	21.6
30.0	7	42.7	28.4	26.9	21.5
Test run 2					
Time (min)	Sample port	Conductivity (ms/cm)	Total dissolved solids (g/L)	Salinity	Temp (°C)
0.0	-	43.7	29.1	27.6	21.6
30.0	1	42.6	28.2	26.7	21.8
30.0	2	42.6	28.3	26.8	21.8
30.0	3	42.4	28.2	26.7	21.7
30.0	4	42.7	28.5	26.9	21.7
30.0	5	42.6	28.4	26.9	21.7
30.0	6	42.6	28.4	26.8	21.7
30.0	7	42.3	28.2	26.6	21.7
Replication 3					
Time (min)	Sample port	Conductivity (ms/cm)	Total dissolved solids (g/L)	Salinity	Temp (°C)
0.0	-	44.1	29.3	27.9	22.2
30.0	1	42.4	28.2	26.6	22.6
30.0	2	42.4	28.3	26.7	22.6
30.0	3	42.5	28.2	26.8	22.5
30.0	4	42.4	28.3	26.8	22.5
30.0	5	42.5	28.3	26.8	22.4
30.0	6	42.5	28.3	26.8	22.3
30.0	7	41.7	27.9	26.3	22.2

Table A-28. Three collected data sets for Diverter D at 22.71 L/min flow rate with the diverter chamber drain closed.

Replication 1					
Time (min)	Sample port	Conductivity (ms/cm)	Total dissolved solids (g/L)	Salinity	Temp (°C)
0.0	-	43.6	29.1	27.6	21.8
30.0	1	39.9	26.7	25.5	21.8
30.0	2	42.7	28.4	26.7	21.9
30.0	3	42.7	28.5	26.9	21.9
30.0	4	42.6	28.4	26.9	21.9
30.0	5	42.6	28.4	26.9	21.9
30.0	6	42.6	28.4	26.9	21.9
30.0	7	42.2	28.1	26.6	21.9
Replication 2					
Time (min)	Sample port	Conductivity (ms/cm)	Total dissolved solids (g/L)	Salinity	Temp (°C)
0.0	-	43.5	29.0	27.5	21.8
30.0	1	4.4	2.9		22.0
30.0	2	41.8	27.8	26.2	21.9
30.0	3	42.5	28.3	26.7	21.9
30.0	4	42.5	28.3	26.8	21.9
30.0	5	42.5	28.3	26.8	21.9
30.0	6	42.5	28.3	26.8	21.9
30.0	7	42.1	28.1	26.6	21.9
Replication 3					
Time (min)	Sample port	Conductivity (ms/cm)	Total dissolved solids (g/L)	Salinity	Temp (°C)
0.0	-	43.5	29.0	27.5	21.8
30.0	1	2.8	1.8		22.0
30.0	2	42.0	27.9	26.4	22.0
30.0	3	42.9	28.5	27.0	22.0
30.0	4	42.9	28.6	27.0	22.1
30.0	5	42.8	28.5	26.9	22.1
30.0	6	42.7	28.4	27.0	22.1
30.0	7	42.3	28.2	26.7	22.1

Table A-29. Three collected data sets for Diverter E at 22.71 L/min flow rate with the diverter chamber drain closed

Replication 1					
Time (min)	Sample port	Conductivity (ms/cm)	Total dissolved solids (g/L)	Salinity	Temp (°C)
0.0	-	43.6	29.1	27.6	21.8
30.0	1	2.4	1.6		21.7
30.0	2	41.6	27.7	26.1	21.7
30.0	3	42.8	28.4	26.8	21.8
30.0	4	42.7	28.4	26.9	21.8
30.0	5	42.8	28.5	26.9	21.8
30.0	6	42.5	28.3	26.8	21.9
30.0	7	42.3	28.2	26.7	21.8
Replication 2					
Time (min)	Sample port	Conductivity (ms/cm)	Total dissolved solids (g/L)	Salinity	Temp (°C)
0.0	-	43.5	29.0	27.5	21.8
30.0	1	14.0	9.3	8.0	21.8
30.0	2	41.7	27.7	26.2	21.8
30.0	3	42.6	28.3	26.6	21.9
30.0	4	42.6	28.4	26.8	21.9
30.0	5	42.6	28.3	26.8	21.9
30.0	6	42.5	28.3	26.8	21.9
30.0	7	42.3	28.2	26.7	21.9
Replication 3					
Time (min)	Sample port	Conductivity (ms/cm)	Total dissolved solids (g/L)	Salinity	Temp (°C)
0.0	-	43.5	29.0	27.5	21.8
30.0	1	2.3	1.5		22.0
30.0	2	41.5	27.7	26.1	22.0
30.0	3	42.7	28.4	26.8	22.0
30.0	4	42.7	28.4	26.7	22.1
30.0	5	42.6	28.4	26.9	22.1
30.0	6	42.5	28.3	26.8	22.1
30.0	7	42.3	28.2	26.6	22.1

Table A-30. Three collected data sets for Diverter F at 22.71 L/min flow rate with the diverter chamber drain closed.

Replication 1					
Time (min)	Sample port	Conductivity (ms/cm)	Total dissolved solids (g/L)	Salinity	Temp (°C)
0.0	-	44.3	29.5	28.1	23.3
30.0	1	3.6	2.4		23.2
30.0	2	41.8	27.9	26.4	23.0
30.0	3	43.1	28.7	27.2	22.8
30.0	4	43.6	29.0	27.5	22.6
30.0	5	43.7	29.1	27.6	22.5
30.0	6	43.8	29.1	27.6	22.5
30.0	7	43.1	28.7	27.3	22.5
Replication 2					
Time (min)	Sample port	Conductivity (ms/cm)	Total dissolved solids (g/L)	Salinity	Temp (°C)
0.0	-	44.0	29.2	28.1	23.1
30.0	1	11.3	7.6	6.4	23.2
30.0	2	41.5	27.7	26.3	23.2
30.0	3	42.7	28.5	27.1	23.1
30.0	4	43.0	28.6	27.2	23.0
30.0	5	43.1	28.7	27.2	22.9
30.0	6	43.1	28.7	27.2	22.8
30.0	7	42.4	28.3	26.9	22.7
Replication 3					
Time (min)	Sample port	Conductivity (ms/cm)	Total dissolved solids (g/L)	Salinity	Temp (°C)
0.0	-	43.9	29.2	27.8	22.9
30.0	1	12.5	8.4	7.0	23.3
30.0	2	41.3	27.6	26.2	23.3
30.0	3	42.4	28.3	26.8	23.3
30.0	4	42.5	28.3	26.9	23.1
30.0	5	42.6	28.4	26.9	23.0
30.0	6	42.7	28.4	27.0	22.8
30.0	7	42.4	28.2	26.6	22.7

Table A-31. Three collected data sets for Diverter A at 43.91 L/min flow rate with the diverter chamber drain closed.

Replication 1					
Time (min)	Sample port	Conductivity (ms/cm)	Total dissolved solids (g/L)	Salinity	Temp (°C)
0.0	-	44.1	29.4	28.3	32.8
30.0	1	2.2	1.5		32.3
30.0	2	42.2	28.3	27.3	32.2
30.0	3	43.8	29.2	28.2	31.7
30.0	4	44.1	29.4	28.3	31.5
30.0	5	44.1	29.4	28.4	31.3
30.0	6	44.2	29.4	28.4	31.2
30.0	7	44.1	29.4	28.3	31.1
Replication 2					
Time (min)	Sample port	Conductivity (ms/cm)	Total dissolved solids (g/L)	Salinity	Temp (°C)
0.0	-	44.0	29.3	28.2	31.3
30.0	1	2.5	1.6		30.5
30.0	2	42.8	28.5	27.4	30.0
30.0	3	43.9	29.2	28.0	29.9
30.0	4	44.0	29.3	28.2	29.9
30.0	5	43.9	29.2	28.1	29.7
30.0	6	44.0	29.3	28.2	29.6
30.0	7	43.6	29.1	27.9	29.6
Replication 3					
Time (min)	Sample port	Conductivity (ms/cm)	Total dissolved solids (g/L)	Salinity	Temp (°C)
0.0	-	44.2	29.3	28.0	22.8
30.0	1	2.1	1.4		22.1
30.0	2	42.2	28.0	26.5	22.0
30.0	3	43.0	28.7	27.1	22.2
30.0	4	43.0	28.6	27.1	22.2
30.0	5	43.2	28.8	27.3	22.2
30.0	6	43.3	28.8	27.3	22.3
30.0	7	42.5	28.3	26.8	22.5

Table A-32. Three collected data sets for Diverter B at 43.91 L/min flow rate with the diverter chamber drain closed.

Replication 1					
Time (min)	Sample port	Conductivity (ms/cm)	Total dissolved solids (g/L)	Salinity	Temp (°C)
0.0	-	44.1	29.4	28.3	32.8
30.0	1	2.1	1.4		34.5
30.0	2	41.3	27.6	26.5	33.1
30.0	3	42.5	28.3	27.3	33.4
30.0	4	42.6	28.5	27.3	33.4
30.0	5	42.7	28.5	27.5	33.3
30.0	6	42.8	28.9	27.8	32.4
30.0	7	43.7	28.9	27.8	32.3
Replication 2					
Time (min)	Sample port	Conductivity (ms/cm)	Total dissolved solids (g/L)	Salinity	Temp (°C)
0.0	-	44.0	29.3	28.2	31.3
30.0	1	2.3	1.5		31.0
30.0	2	2.6	1.7		30.4
30.0	3	42.4	28.2	27.0	30.3
30.0	4	43.4	28.9	27.8	30.2
30.0	5	43.3	28.7	27.6	30.1
30.0	6	43.7	29.0	28.0	30.0
30.0	7	43.5	29.0	27.9	29.9
Replication 3					
Time (min)	Sample port	Conductivity (ms/cm)	Total dissolved solids (g/L)	Salinity	Temp (°C)
0.0	-	44.2	29.3	28.0	22.8
30.0	1	2.3	1.6		22.4
30.0	2	3.2	2.1		22.5
30.0	3	41.7	27.7	26.3	22.5
30.0	4	42.8	28.6	27.0	22.4
30.0	5	43.1	28.7	27.2	22.4
30.0	6	43.0	28.7	27.2	22.4
30.0	7	42.6	28.5	26.9	22.3

Table A-33. Three collected data sets for Diverter C at 43.91 L/min flow rate with the diverter chamber drain closed.

Replication 1					
Time (min)	Sample port	Conductivity (ms/cm)	Total dissolved solids (g/L)	Salinity	Temp (°C)
0.0	-	44.1	29.4	28.3	32.8
30.0	1	44.0	29.3	28.3	33.6
30.0	2	44.1	29.4	28.4	33.1
30.0	3	43.9	29.2	28.3	33.4
30.0	4	43.9	29.3	28.2	33.5
30.0	5	44.0	29.3	28.3	33.4
30.0	6	43.7	29.1	28.1	33.5
30.0	7	43.3	28.3	28.0	33.4
Replication 2					
Time (min)	Sample port	Conductivity (ms/cm)	Total dissolved solids (g/L)	Salinity	Temp (°C)
0.0	-	44.0	29.3	28.2	31.3
30.0	1	41.6	27.7	26.5	32.2
30.0	2	42.0	28.0	26.9	32.1
30.0	3	42.3	28.2	27.7	30.2
30.0	4	41.8	27.8	26.5	30.0
30.0	5	43.9	29.2	28.1	30.0
30.0	6	43.9	29.2	28.0	30.0
30.0	7	43.1	28.7	27.5	29.9
Replication 3					
Time (min)	Sample port	Conductivity (ms/cm)	Total dissolved solids (g/L)	Salinity	Temp (°C)
0.0	-	44.2	29.3	28.0	22.8
30.0	1	42.2	28.2	26.9	22.7
30.0	2	42.9	28.5	27.0	22.4
30.0	3	43.0	28.6	27.1	22.4
30.0	4	43.0	28.6	27.0	22.3
30.0	5	43.0	28.6	26.9	22.4
30.0	6	43.1	28.6	26.8	22.6
30.0	7	44.0	29.3	28.0	22.2

Table A-34. Three collected data sets for Diverter D at 43.91 L/min flow rate with the diverter chamber drain closed.

Replication 1					
Time (min)	Sample port	Conductivity (ms/cm)	Total dissolved solids (g/L)	Salinity	Temp (°C)
0.0	-	44.0	29.2	27.7	20.4
30.0	1	2.5	1.6		20.1
30.0	2	2.7	1.8		20.2
30.0	3	41.3	27.6	26.0	20.3
30.0	4	42.5	28.3	26.7	20.3
30.0	5	42.8	28.5	26.9	20.3
30.0	6	42.9	28.6	27.0	20.3
30.0	7	42.3	28.2	26.7	20.3
Replication 2					
Time (min)	Sample port	Conductivity (ms/cm)	Total dissolved solids (g/L)	Salinity	Temp (°C)
0.0	-	43.8	29.2	27.6	20.3
30.0	1	1.9	1.3		22.3
30.0	2	14.8	9.8	8.5	22.1
30.0	3	40.8	27.3	25.8	21.9
30.0	4	41.7	27.9	26.3	21.5
30.0	5	41.9	28.0	26.4	21.2
30.0	6	42.0	28.0	26.5	21.0
30.0	7	41.4	27.6	26.1	20.7
Replication 3					
Time (min)	Sample port	Conductivity (ms/cm)	Total dissolved solids (g/L)	Salinity	Temp (°C)
0.0	-	43.9	29.2	27.7	22.1
30.0	1	3.6	2.6		22.3
30.0	2	38.0	24.5	24.0	22.3
30.0	3	42.8	28.4	26.7	22.4
30.0	4	42.8	28.4	26.9	22.5
30.0	5	42.8	28.5	27.0	22.4
30.0	6	42.9	28.5	27.0	22.3
30.0	7	42.4	28.3	26.8	22.2

Table A-35. Three collected data sets for Diverter E at 43.91 L/min flow rate with the diverter chamber drain closed.

Replication 1					
Time (min)	Sample port	Conductivity (ms/cm)	Total dissolved solids (g/L)	Salinity	Temp (°C)
0.0	-	44.0	29.2	27.7	20.4
30.0	1	2.3	1.5		20.3
30.0	2	22.7	18.5	16.7	20.5
30.0	3	42.1	28.1	26.5	20.6
30.0	4	42.5	28.2	26.7	20.5
30.0	5	42.7	28.4	26.8	20.5
30.0	6	42.7	28.4	26.9	20.4
30.0	7	42.2	28.2	26.6	20.3
Replication 2					
Time (min)	Sample port	Conductivity (ms/cm)	Total dissolved solids (g/L)	Salinity	Temp (°C)
0.0	-	43.8	29.2	27.6	20.3
30.0	1	1.9	1.2		19.5
30.0	2	1.4	0.9		19.9
30.0	3	43.7	29.1	27.4	20.3
30.0	4	44.2	29.2	27.6	20.7
30.0	5	44.0	29.2	27.6	20.9
30.0	6	43.6	29.0	27.6	21.1
30.0	7	42.5	28.4	26.8	21.1
Replication 3					
Time (min)	Sample port	Conductivity (ms/cm)	Total dissolved solids (g/L)	Salinity	Temp (°C)
0.0	-	43.9	29.2	27.7	22.1
30.0	1	2.6	1.7		22.4
30.0	2	41.5	27.6	26.1	22.4
30.0	3	42.6	28.3	26.8	22.5
30.0	4	42.7	28.4	26.9	22.5
30.0	5	42.8	28.5	26.9	22.4
30.0	6	42.7	28.4	27.0	22.4
30.0	7	42.6	28.5	26.9	22.3

Table A-36. Three collected data sets for Diverter F at 43.91 L/min flow rate with the diverter chamber drain closed.

Replication 1					
Time (min)	Sample port	Conductivity (ms/cm)	Total dissolved solids (g/L)	Salinity	Temp (°C)
0.0	-	44.2	29.5	28.1	24.1
30.0	1	2.2	1.4		24.4
30.0	2	41.6	27.8	26.4	24.6
30.0	3	42.8	28.5	27.2	24.6
30.0	4	42.9	28.6	27.2	24.5
30.0	5	43.2	28.8	27.4	24.4
30.0	6	43.3	28.8	27.4	24.3
30.0	7	42.9	28.6	27.2	24.2
Replication 2					
Time (min)	Sample port	Conductivity (ms/cm)	Total dissolved solids (g/L)	Salinity	Temp (°C)
0.0	-	44.2	29.5	28.1	24.1
30.0	1	2.0	1.3		24.7
30.0	2	2.2	1.4		25.2
30.0	3	42.1	28.0	26.6	25.2
30.0	4	42.7	28.5	27.1	25.0
30.0	5	42.9	28.6	27.2	24.7
30.0	6	43.0	28.6	27.3	24.4
30.0	7	42.7	28.5	27.1	24.2
Replication 3					
Time (min)	Sample port	Conductivity (ms/cm)	Total dissolved solids (g/L)	Salinity	Temp (°C)
0.0	-	44.2	29.5	28.1	24.1
30.0	1	3.3	2.0		24.7
30.0	2	41.4	27.7	26.4	25.5
30.0	3	42.5	28.3	27.0	25.3
30.0	4	42.7	28.5	27.1	25.0
30.0	5	42.9	28.6	27.2	24.7
30.0	6	43.1	28.7	27.3	24.3
30.0	7	42.8	28.5	27.2	24.0

Table A-37. Three collected data sets for Diverter A at 75.71 L/min flow rate with the diverter chamber drain closed.

Replication 1					
Time (min)	Sample port	Conductivity (ms/cm)	Total dissolved solids (g/L)	Salinity	Temp (°C)
0.0	-	44.3	29.5	28.1	23.3
30.0	1	3.3	2.2		23.4
30.0	2	3.4	2.5		23.5
30.0	3	41.4	27.6	26.1	23.5
30.0	4	42.5	28.3	26.9	23.5
30.0	5	42.8	28.5	27.1	23.5
30.0	6	43.0	28.6	27.2	23.5
30.0	7	42.9	28.6	27.1	23.4
Replication 2					
Time (min)	Sample port	Conductivity (ms/cm)	Total dissolved solids (g/L)	Salinity	Temp (°C)
0.0	-	44.0	29.4	27.8	20.7
30.0	1	2.6	1.7		19.1
30.0	2	2.4	1.6		19.7
30.0	3	42.6	28.4	26.8	20.1
30.0	4	43.1	28.7	27.2	20.3
30.0	5	43.2	28.7	27.2	20.3
30.0	6	43.1	28.7	27.1	20.4
30.0	7	42.7	28.4	26.8	20.3
Replication 3					
Time (min)	Sample port	Conductivity (ms/cm)	Total dissolved solids (g/L)	Salinity	Temp (°C)
0.0	-	44.1	29.4	27.8	20.9
30.0	1	3.7	2.4		20.7
30.0	2	3.5	2.3		21.3
30.0	3	41.6	27.8	26.2	21.5
30.0	4	42.3	28.3	26.7	21.5
30.0	5	42.4	28.3	26.7	21.3
30.0	6	42.5	28.3	26.7	21.0
30.0	7	42.3	28.2	26.6	20.6

Table A-38. Three collected data sets for Diverter B at 75.71 L/min flow rate with the diverter chamber drain closed.

Replication 1					
Time (min)	Sample port	Conductivity (ms/cm)	Total dissolved solids (g/L)	Salinity	Temp (°C)
0.0	-	44.3	29.5	28.1	23.3
30.0	1	2.9	2.0		23.4
30.0	2	2.3	1.5		23.6
30.0	3	41.7	27.7	26.3	23.7
30.0	4	42.5	28.3	26.9	23.7
30.0	5	428.0	28.5	27.1	23.6
30.0	6	42.9	28.5	27.1	23.6
30.0	7	42.8	28.6	27.1	23.5
Replication 2					
Time (min)	Sample port	Conductivity (ms/cm)	Total dissolved solids (g/L)	Salinity	Temp (°C)
0.0	-	44.0	29.4	27.8	20.7
30.0	1	2.5	1.7		20.4
30.0	2	41.8	27.8	26.2	20.5
30.0	3	42.7	28.5	26.9	20.5
30.0	4	43.2	28.7	27.2	20.5
30.0	5	43.4	28.9	27.3	20.4
30.0	6	43.4	28.9	27.3	20.4
30.0	7	42.9	28.6	27.0	20.3
Replication 3					
Time (min)	Sample port	Conductivity (ms/cm)	Total dissolved solids (g/L)	Salinity	Temp (°C)
0.0	-	44.1	29.4	27.8	20.9
30.0	1	3.1	2.1		21.4
30.0	2	41.3	27.5	26.0	21.4
30.0	3	42.8	28.5	27.0	21.3
30.0	4	43.1	28.6	27.1	21.2
30.0	5	43.0	28.6	27.2	21.0
30.0	6	43.1	28.7	27.2	20.9
30.0	7	42.8	28.5	27.0	20.6

Table A-39. Three collected data sets for Diverter C at 75.71 L/min flow rate with the diverter chamber drain closed.

Replication 1					
Time (min)	Sample port	Conductivity (ms/cm)	Total dissolved solids (g/L)	Salinity	Temp (°C)
0.0	-	43.9	29.3	27.7	20.7
30.0	1	41.7	27.5	25.9	20.5
30.0	2	43.0	28.7	27.1	20.4
30.0	3	43.0	28.6	27.0	20.3
30.0	4	43.0	28.6	27.0	20.2
30.0	5	43.0	28.6	27.0	20.1
30.0	6	42.0	28.6	27.0	20.0
30.0	7	41.8	28.0	26.5	19.8
Replication 2					
Time (min)	Sample port	Conductivity (ms/cm)	Total dissolved solids (g/L)	Salinity	Temp (°C)
0.0	-	43.6	29.0	27.5	20.3
30.0	1	42.5	28.3	26.6	20.5
30.0	2	42.6	28.4	26.8	20.4
30.0	3	42.7	28.4	26.8	20.3
30.0	4	42.7	28.4	26.8	20.1
30.0	5	42.8	28.5	26.8	20.0
30.0	6	42.7	28.4	26.9	19.9
30.0	7	41.4	27.6	26.1	19.8
Replication 3					
Time (min)	Sample port	Conductivity (ms/cm)	Total dissolved solids (g/L)	Salinity	Temp (°C)
0.0	-	43.9	29.3	27.7	20.2
30.0	1	42.6	28.4	26.8	20.4
30.0	2	42.6	28.4	26.8	20.4
30.0	3	42.6	28.4	26.8	20.3
30.0	4	42.6	28.3	26.7	20.2
30.0	5	42.5	28.3	26.7	20.2
30.0	6	42.5	28.3	26.7	20.1
30.0	7	41.6	27.8	26.6	20.0

Table A-40. Three collected data sets for Diverter D at 75.71 L/min flow rate with the diverter chamber drain closed.

Replication 1					
Time (min)	Sample port	Conductivity (ms/cm)	Total dissolved solids (g/L)	Salinity	Temp (°C)
0.0	-	44.2	29.5	27.9	19.9
30.0	1	3.1	2.0		20.3
30.0	2	40.4	27.0	25.5	20.5
30.0	3	41.6	27.7	26.1	20.5
30.0	4	42.3	28.2	26.6	20.3
30.0	5	42.8	28.5	26.9	20.1
30.0	6	43.0	28.7	27.0	19.9
30.0	7	42.5	28.3	26.8	19.7
Replication 2					
Time (min)	Sample port	Conductivity (ms/cm)	Total dissolved solids (g/L)	Salinity	Temp (°C)
0.0	-	44.2	29.5	27.9	19.9
30.0	1	3.1	1.9		20.4
30.0	2	41.5	27.7	26.1	20.7
30.0	3	42.8	28.5	27.0	20.7
30.0	4	43.2	28.7	27.3	20.5
30.0	5	43.2	28.8	27.3	20.3
30.0	6	43.5	28.9	27.3	20.0
30.0	7	42.9	28.6	27.0	19.7
Replication 3					
Time (min)	Sample port	Conductivity (ms/cm)	Total dissolved solids (g/L)	Salinity	Temp (°C)
0.0	-	44.3	29.5	27.9	19.7
30.0	1	3.5	2.4		20.3
30.0	2	42.3	28.3	26.8	20.6
30.0	3	43.0	28.7	27.1	20.5
30.0	4	43.0	28.7	17.3	20.3
30.0	5	43.2	28.8	27.2	20.0
30.0	6	43.4	28.9	27.3	19.8
30.0	7	42.7	28.4	26.9	19.6

Table A-41. Three collected data sets for Diverter E at 75.71 L/min flow rate with the diverter chamber drain closed.

Replication 1					
Time (min)	Sample port	Conductivity (ms/cm)	Total dissolved solids (g/L)	Salinity	Temp (°C)
0.0	-	43.9	29.3	27.7	20.7
30.0	1	2.3	1.5		19.7
30.0	2	41.8	27.9	26.2	19.8
30.0	3	43.2	28.8	27.2	19.8
30.0	4	43.3	28.8	27.2	19.8
30.0	5	43.6	28.9	27.4	19.9
30.0	6	43.7	29.0	27.4	19.9
30.0	7	42.8	28.6	27.0	19.7
Replication 2					
Time (min)	Sample port	Conductivity (ms/cm)	Total dissolved solids (g/L)	Salinity	Temp (°C)
0.0	-	43.6	29.0	27.5	20.3
30.0	1	2.6	1.7		20.0
30.0	2	41.6	27.7	26.1	20.2
30.0	3	42.5	28.3	26.7	20.2
30.0	4	42.6	28.4	26.8	20.2
30.0	5	42.8	28.5	26.8	19.9
30.0	6	43.0	28.6	26.9	19.8
30.0	7	42.0	28.2	26.6	19.7
Replication 3					
Time (min)	Sample port	Conductivity (ms/cm)	Total dissolved solids (g/L)	Salinity	Temp (°C)
0.0	-	43.9	29.3	27.7	20.2
30.0	1	2.5	1.7		20.3
30.0	2	41.1	27.4	25.8	20.5
30.0	3	42.1	28.1	26.5	20.6
30.0	4	42.3	28.1	26.6	20.4
30.0	5	42.7	28.4	26.8	20.3
30.0	6	42.8	28.5	26.9	20.2
30.0	7	42.6	28.4	26.8	20.1

Table A-42. Three collected data sets for Diverter F at 75.71 L/min flow rate with the diverter chamber drain closed.

Replication 1					
Time (min)	Sample port	Conductivity (ms/cm)	Total dissolved solids (g/L)	Salinity	Temp (°C)
0.0	-	44.2	29.4	28.1	23.2
30.0	1	2.9	1.9		23.7
30.0	2	34.3	22.9	21.3	24.1
30.0	3	42.5	28.4	27.0	24.1
30.0	4	42.9	28.6	27.2	23.9
30.0	5	43.0	28.6	27.2	23.8
30.0	6	43.0	28.6	27.2	23.6
30.0	7	42.6	28.4	27.0	23.4
Replication 2					
Time (min)	Sample port	Conductivity (ms/cm)	Total dissolved solids (g/L)	Salinity	Temp (°C)
0.0	-	44.2	29.4	28.1	23.2
30.0	1	3.0	2.0		23.8
30.0	2	36.7	24.5	22.9	23.9
30.0	3	42.7	28.5	27.0	23.9
30.0	4	43.2	28.8	27.4	23.9
30.0	5	43.2	28.8	27.4	23.9
30.0	6	43.2	28.8	27.4	23.9
30.0	7	43.1	28.7	27.3	23.8
Replication 3					
Time (min)	Sample port	Conductivity (ms/cm)	Total dissolved solids (g/L)	Salinity	Temp (°C)
0.0	-	44.2	29.4	28.1	23.2
30.0	1	2.8	1.8		24.0
30.0	2	25.1	16.7	15.2	24.4
30.0	3	42.3	28.2	26.8	24.4
30.0	4	42.9	28.6	27.2	24.2
30.0	5	43.0	28.7	27.3	24.1
30.0	6	43.0	28.7	27.3	24.0
30.0	7	42.8	28.6	27.2	23.9

Table A-43. Three collected data sets for Diverter A at 113.56 L/min flow rate with the diverter chamber drain closed.

Replication 1					
Time (min)	Sample port	Conductivity (ms/cm)	Total dissolved solids (g/L)	Salinity	Temp (°C)
0.0	-	44.0	29.3	27.7	19.9
30.0	1	3.7	2.5		20.7
30.0	2	2.2	1.5		21.2
30.0	3	40.8	27.2	25.6	21.3
30.0	4	41.3	27.7	26.2	21.1
30.0	5	41.7	27.8	26.2	20.8
30.0	6	42.0	28.0	26.4	20.5
30.0	7	42.0	28.0	26.5	20.2
Replication 2					
Time (min)	Sample port	Conductivity (ms/cm)	Total dissolved solids (g/L)	Salinity	Temp (°C)
0.0	-	44.4	29.6	28.0	20.1
30.0	1	2.9	2.0		22.2
30.0	2	2.7	1.8		22.4
30.0	3	3.2	2.1		22.7
30.0	4	40.6	27.2	25.7	22.6
30.0	5	41.4	27.7	26.3	22.1
30.0	6	41.8	27.9	26.4	21.5
30.0	7	42.0	28.0	26.4	20.8
Replication 3					
Time (min)	Sample port	Conductivity (ms/cm)	Total dissolved solids (g/L)	Salinity	Temp (°C)
0.0	-	44.1	29.4	27.9	22.7
30.0	1	3.0	2.0		22.8
30.0	2	2.4	1.6		23.1
30.0	3	6.1	4.0		23.4
30.0	4	42.1	28.2	26.7	23.3
30.0	5	42.7	28.5	27.1	23.1
30.0	6	42.8	28.6	27.2	22.8
30.0	7	42.6	28.5	27.0	22.4

Table A-44. Three collected data sets for Diverter B at 113.56 L/min flow rate with the diverter chamber drain closed.

Replication 1					
Time (min)	Sample port	Conductivity (ms/cm)	Total dissolved solids (g/L)	Salinity	Temp (°C)
0.0	-	44.0	29.3	27.7	19.9
30.0	1	26.1	17.4	15.6	20.3
30.0	2	41.8	27.9	26.3	20.4
30.0	3	42.5	28.3	26.7	20.3
30.0	4	43.4	28.9	27.2	19.2
30.0	5	43.8	29.0	27.3	18.9
30.0	6	43.9	29.2	27.6	18.9
30.0	7	44.0	29.3	27.8	18.9
Replication 2					
Time (min)	Sample port	Conductivity (ms/cm)	Total dissolved solids (g/L)	Salinity	Temp (°C)
0.0	-	44.4	29.6	28.0	20.1
30.0	1	22.1	14.8	13.2	22.7
30.0	2	40.6	27.3	25.9	22.4
30.0	3	41.9	28.1	26.6	21.9
30.0	4	42.7	28.5	27.0	21.4
30.0	5	43.2	28.2	27.3	20.9
30.0	6	43.6	29.1	27.5	20.6
30.0	7	43.4	28.9	27.4	20.2
Replication 3					
Time (min)	Sample port	Conductivity (ms/cm)	Total dissolved solids (g/L)	Salinity	Temp (°C)
0.0	-	44.1	29.4	27.9	22.7
30.0	1	10.9	7.5	6.3	22.6
30.0	2	41.2	27.5	26.0	22.7
30.0	3	41.8	28.0	26.5	22.6
30.0	4	42.0	28.0	26.5	22.5
30.0	5	42.1	28.0	26.5	22.2
30.0	6	42.2	28.1	26.6	22.1
30.0	7	41.7	27.8	26.3	21.8

Table A-45. Three collected data sets for Diverter C at 113.56 L/min flow rate with the diverter chamber drain closed.

Replication 1					
Time (min)	Sample port	Conductivity (ms/cm)	Total dissolved solids (g/L)	Salinity	Temp (°C)
0.0	-	44.0	29.3	27.9	21.7
30.0	1	41.8	27.8	26.3	21.7
30.0	2	41.7	27.7	26.2	21.8
30.0	3	41.6	27.7	26.1	21.8
30.0	4	41.4	27.6	26.0	21.8
30.0	5	41.3	27.5	26.0	21.8
30.0	6	41.2	27.4	25.9	21.8
30.0	7	40.9	27.3	25.7	21.8
Replication 2					
Time (min)	Sample port	Conductivity (ms/cm)	Total dissolved solids (g/L)	Salinity	Temp (°C)
0.0	-	44.3	29.5	28.0	21.7
30.0	1	43.2	28.7	27.3	22.2
30.0	2	43.1	28.7	27.3	22.1
30.0	3	43.1	28.7	27.2	22.1
30.0	4	43.1	28.7	27.2	22.1
30.0	5	43.1	28.7	27.2	22.0
30.0	6	43.0	28.7	27.2	22.0
30.0	7	42.7	28.5	27.0	21.9
Replication 3					
Time (min)	Sample port	Conductivity (ms/cm)	Total dissolved solids (g/L)	Salinity	Temp (°C)
0.0	-	44.1	29.4	27.9	21.8
30.0	1	42.7	28.5	27.0	22.7
30.0	2	42.8	28.5	27.1	22.6
30.0	3	42.8	28.5	27.0	22.5
30.0	4	42.9	28.6	26.9	22.4
30.0	5	42.9	28.6	27.1	22.4
30.0	6	42.9	28.6	27.1	22.3
30.0	7	42.5	28.3	26.9	22.2

Table A-46. Three collected data sets for Diverter D at 113.56 L/min flow rate with the diverter chamber drain closed.

Replication 1					
Time (min)	Sample port	Conductivity (ms/cm)	Total dissolved solids (g/L)	Salinity	Temp (°C)
0.0	-	44.5	29.5	28.9	20.3
30.0	1	2.2	1.4		22.1
30.0	2	39.7	26.4	24.7	22.2
30.0	3	42.2	28.0	26.6	22.1
30.0	4	42.4	28.2	26.8	21.9
30.0	5	42.3	28.1	26.6	21.7
30.0	6	42.3	28.2	26.7	21.5
30.0	7	42.3	28.2	26.7	21.3
Replication 2					
Time (min)	Sample port	Conductivity (ms/cm)	Total dissolved solids (g/L)	Salinity	Temp (°C)
0.0	-	43.6	29.1	27.6	21.9
30.0	1	2.96	1.95		22.7
30.0	2	41.9	28.0	26.5	23.0
30.0	3	42.6	28.4	26.9	23.0
30.0	4	42.8	28.5	27.0	23.1
30.0	5	43.0	28.5	27.1	22.6
30.0	6	42.9	28.6	27.1	22.5
30.0	7	42.8	28.4	26.9	22.3
Replication 3					
Time (min)	Sample port	Conductivity (ms/cm)	Total dissolved solids (g/L)	Salinity	Temp (°C)
0.0	-	43.6	29.1	27.6	21.7
30.0	1	1.9	1.3		23.1
30.0	2	40.4	27.0	25.6	23.3
30.0	3	41.8	27.9	26.5	23.2
30.0	4	41.9	28.0	26.5	23.0
30.0	5	42.1	28.0	26.6	22.7
30.0	6	42.1	28.0	26.6	22.5
30.0	7	41.9	28.0	26.4	22.4

Table A-47. Three collected data sets for Diverter E at 113.56 L/min flow rate with the diverter chamber drain closed.

Replication 1					
Time (min)	Sample port	Conductivity (ms/cm)	Total dissolved solids (g/L)	Salinity	Temp (°C)
0.0	-	44.0	29.3	27.9	21.7
30.0	1	2.6	1.7		21.9
30.0	2	2.3	1.5		22.4
30.0	3	41.4	27.7	26.2	22.6
30.0	4	42.5	28.3	26.9	22.6
30.0	5	42.8	28.5	27.1	22.5
30.0	6	42.9	28.6	27.1	22.4
30.0	7	43.0	28.7	27.2	22.2
Replication 2					
Time (min)	Sample port	Conductivity (ms/cm)	Total dissolved solids (g/L)	Salinity	Temp (°C)
0.0	-	44.3	29.5	28.0	21.7
30.0	1	2.7	1.8		22.3
30.0	2	2.1	1.4		22.7
30.0	3	41.8	27.9	26.5	22.9
30.0	4	42.5	28.3	26.9	22.8
30.0	5	42.6	28.4	26.9	22.7
30.0	6	42.7	28.5	27.0	22.6
30.0	7	42.7	28.6	27.0	22.4
Replication 3					
Time (min)	Sample port	Conductivity (ms/cm)	Total dissolved solids (g/L)	Salinity	Temp (°C)
44.1	-	44.1	29.4	27.9	21.8
3.1	1	3.1	2.1		23.4
2.6	2	2.6	1.8		23.6
41.2	3	41.2	27.5	26.2	23.5
41.9	4	41.9	28.1	26.6	23.3
42.5	5	42.5	28.1	26.7	23.1
42.5	6	42.5	28.2	26.8	22.8
42.5	7	42.5	28.3	26.9	22.6

Table A-48. Three collected data sets for Diverter F at 113.56 L/min flow rate with the diverter chamber drain closed.

Replication 1					
Time (min)	Sample port	Conductivity (ms/cm)	Total dissolved solids (g/L)	Salinity	Temp (°C)
0.0	-	44.0	29.2	27.8	23.2
30.0	1	2.9	1.9		23.4
30.0	2	2.1	1.4		23.6
30.0	3	36.7	24.9	22.7	23.7
30.0	4	42.3	28.1	26.7	23.7
30.0	5	42.6	28.4	26.9	23.5
30.0	6	42.6	28.4	26.9	23.5
30.0	7	42.2	28.2	26.7	23.4
Replication 2					
Time (min)	Sample port	Conductivity (ms/cm)	Total dissolved solids (g/L)	Salinity	Temp (°C)
0.0	-	44.2	29.4	28.0	23.2
30.0	1	3.0	2.0		23.5
30.0	2	2.0	1.3		23.8
30.0	3	39.4	26.1	24.6	24.0
30.0	4	42.4	28.3	26.9	24.0
30.0	5	42.7	28.5	27.1	23.9
30.0	6	42.8	28.5	27.1	23.8
30.0	7	42.5	28.4	26.9	23.5
Replication 3					
Time (min)	Sample port	Conductivity (ms/cm)	Total dissolved solids (g/L)	Salinity	Temp (°C)
0.0	-	44.1	29.4	28.0	23.2
30.0	1	2.4	1.6		23.7
30.0	2	2.0	1.3		24.1
30.0	3	41.7	27.7	26.3	24.3
30.0	4	42.8	28.5	27.0	24.2
30.0	5	43.1	28.6	27.2	24.0
30.0	6	43.1	28.7	27.2	23.8
30.0	7	42.7	28.5	27.1	23.6

APPENDIX B

Table B-1. Three collected data sets for Diverter A at 1.51 L/min flow rate with the diverter chamber drain open.

Replication 1					
Time (min)	Sample port	Conductivity (ms/cm)	Total dissolved solids (g/L)	Salinity	Temp (°C)
0.0	-	44.1	29.3	28.0	23.6
30.0	1	1.7	1.1		23.7
30.0	2	1.2	0.8		23.5
30.0	3	1.0	0.7		23.3
30.0	4	1.0	0.7		23.2
30.0	5	3.6	2.4		23.1
30.0	6	37.2	24.9	23.2	23.0
30.0	7	42.0	27.9	26.4	22.9
Replication 2					
Time (min)	Sample port	Conductivity (ms/cm)	Total dissolved solids (g/L)	Salinity	Temp (°C)
0.0	-	44.2	29.3	27.9	23.9
30.0	1	1.1	0.8		22.8
30.0	2	0.9	0.6		22.9
30.0	3	0.9	0.6		22.9
30.0	4	0.9	0.6		22.9
30.0	5	28.9	19.2	17.5	22.8
30.0	6	41.6	27.7	26.2	22.8
30.0	7	43.2	28.8	27.3	22.8
Replication 3					
Time (min)	Sample port	Conductivity (ms/cm)	Total dissolved solids (g/L)	Salinity	Temp (°C)
0.0	-	44.0	29.3	27.9	23.3
30.0	1	1.1	0.7		23.3
30.0	2	0.9	0.6		23.2
30.0	3	0.9	0.6		23.2
30.0	4	1.0	0.6		22.9
30.0	5	35.7	23.9	22.3	22.9
30.0	6	39.6	26.4	24.9	23.0
30.0	7	42.1	28.1	26.6	22.7

Table B-2. Three collected data sets for Diverter B at 1.51 L/min flow rate with the diverter chamber drain open.

Replication 1					
Time (min)	Sample port	Conductivity (ms/cm)	Total dissolved solids (g/L)	Salinity	Temp (°C)
0.0	-	44.1	29.3	28.0	23.6
30.0	1	1.9	1.3		23.1
30.0	2	1.0	0.7		22.9
30.0	3	1.1	0.7		23.1
30.0	4	1.1	0.7		23.2
30.0	5	6.7	3.8		23.1
30.0	6	38.9	25.9	24.4	23.0
30.0	7	42.3	28.1	26.8	22.8
Replication 2					
Time (min)	Sample port	Conductivity (ms/cm)	Total dissolved solids (g/L)	Salinity	Temp (°C)
0.0	-	44.2	29.3	27.9	23.9
30.0	1	1.4	1.0		24.0
30.0	2	0.9	0.6		24.0
30.0	3	0.9	0.6		23.7
30.0	4	0.9	0.6		23.5
30.0	5	11.0	7.5	6.7	23.6
30.0	6	40.0	26.6	25.1	23.5
30.0	7	42.5	28.2	26.8	23.3
Replication 3					
Time (min)	Sample port	Conductivity (ms/cm)	Total dissolved solids (g/L)	Salinity	Temp (°C)
0.0	-	44.0	29.3	27.9	23.3
30.0	1	2.0	1.3		22.8
30.0	2	0.9	0.6		22.7
30.0	3	0.9	0.6		22.7
30.0	4	0.9	0.6		22.8
30.0	5	12.6	8.3	7.0	23.0
30.0	6	40.1	26.7	25.1	22.8
30.0	7	42.3	28.2	26.7	22.8

Table B-3. Three collected data sets for Diverter C at 1.51 L/min flow rate with the diverter chamber drain open.

Replication 1					
Time (min)	Sample port	Conductivity (ms/cm)	Total dissolved solids (g/L)	Salinity	Temp (°C)
0.0	-	44.1	29.3	28.0	23.6
30.0	1	2.0	1.4		22.8
30.0	2	1.1	0.7		22.9
30.0	3	1.1	0.8		23.0
30.0	4	1.0	0.7		23.0
30.0	5	1.1	0.7		23.2
30.0	6	1.1	0.7		23.1
30.0	7	8.8	5.7		22.9
Replication 2					
Time (min)	Sample port	Conductivity (ms/cm)	Total dissolved solids (g/L)	Salinity	Temp (°C)
0.0	-	44.2	29.3	27.9	23.9
30.0	1	2.0	1.4		23.3
30.0	2	1.0	0.6		23.3
30.0	3	0.9	0.6		23.3
30.0	4	0.9	0.6		23.3
30.0	5	0.9	0.6		23.1
30.0	6	0.9	0.6		23.1
30.0	7	8.5	5.7		22.8
Replication 3					
Time (min)	Sample port	Conductivity (ms/cm)	Total dissolved solids (g/L)	Salinity	Temp (°C)
0.0	-	44.0	29.3	27.9	23.3
30.0	1	1.6	1.1		23.9
30.0	2	0.9	0.6		23.7
30.0	3	0.9	0.6		23.5
30.0	4	0.9	0.6		23.5
30.0	5	0.9	0.6		23.3
30.0	6	0.9	0.6		23.5
30.0	7	9.4	6.3	5.2	23.3

Table B-4. Three collected data sets for Diverter D at 1.51 L/min flow rate with the diverter chamber drain open.

Replication 1					
Time (min)	Sample port	Conductivity (ms/cm)	Total dissolved solids (g/L)	Salinity	Temp (°C)
0.0	-	43.9	29.2	27.7	21.7
30.0	1	1.3	0.8		22.1
30.0	2	1.1	0.7		22.1
30.0	3	1.0	0.7		22.2
30.0	4	1.1	0.8		22.2
30.0	5	1.0	0.7		22.2
30.0	6	1.0	0.7		22.3
30.0	7	8.9	5.9		22.2
Replication 2					
Time (min)	Sample port	Conductivity (ms/cm)	Total dissolved solids (g/L)	Salinity	Temp (°C)
0.0	-	44.0	29.3	27.8	22.9
30.0	1	1.9	1.3		21.8
30.0	2	1.1	0.7		21.9
30.0	3	1.0	0.7		22.4
30.0	4	1.0	0.7		22.4
30.0	5	1.0	0.7		22.4
30.0	6	1.0	0.7		22.4
30.0	7	9.5	6.3	5.3	22.4
Replication 3					
Time (min)	Sample port	Conductivity (ms/cm)	Total dissolved solids (g/L)	Salinity	Temp (°C)
0.0	-	43.5	29.1	27.5	20.0
30.0	1	1.9	1.2		20.3
30.0	2	1.2	0.8		20.7
30.0	3	1.2	0.8		20.9
30.0	4	1.0	0.7		21.2
30.0	5	1.0	0.7		21.4
30.0	6	1.0	0.7		21.5
30.0	7	8.8	5.9		21.6

Table B-5. Three collected data sets for Diverter E at 1.51 L/min flow rate with the diverter chamber drain open.

Replication 1					
Time (min)	Sample port	Conductivity (ms/cm)	Total dissolved solids (g/L)	Salinity	Temp (°C)
0.0	-	43.9	29.2	27.7	21.7
30.0	1	1.8	1.2		21.7
30.0	2	1.0	0.7		21.8
30.0	3	1.0	0.7		21.9
30.0	4	1.0	0.7		22.0
30.0	5	1.0	0.7		22.1
30.0	6	1.0	0.7		22.2
30.0	7	9.2	6.2	5.1	22.2
Replication 2					
Time (min)	Sample port	Conductivity (ms/cm)	Total dissolved solids (g/L)	Salinity	Temp (°C)
0.0	-	44.0	29.3	27.8	22.9
30.0	1	1.2	0.9		22.4
30.0	2	1.0	0.7		22.4
30.0	3	1.0	0.7		22.5
30.0	4	1.0	0.7		22.5
30.0	5	1.0	0.7		22.5
30.0	6	1.0	0.7		22.5
30.0	7	9.5	6.3	5.2	22.5
Replication 3					
Time (min)	Sample port	Conductivity (ms/cm)	Total dissolved solids (g/L)	Salinity	Temp (°C)
0.0	-	43.5	29.1	27.5	20.0
30.0	1	1.2	0.8		21.7
30.0	2	1.0	0.7		21.7
30.0	3	1.0	0.7		21.8
30.0	4	1.0	0.7		22.0
30.0	5	1.0	0.7		22.0
30.0	6	1.0	0.7		22.1
30.0	7	8.3	5.5		22.0

Table B-6. Three collected data sets for Diverter F at 1.51 L/min flow rate with the diverter chamber drain open.

Replication 1					
Time (min)	Sample port	Conductivity (ms/cm)	Total dissolved solids (g/L)	Salinity	Temp (°C)
0.0	-	44.2	29.5	27.9	20.5
30.0	1	1.8	1.2		21.0
30.0	2	1.0	0.6		21.1
30.0	3	1.0	0.6		21.2
30.0	4	1.0	0.7		21.4
30.0	5	1.0	0.6		21.4
30.0	6	1.0	0.7		21.7
30.0	7	8.5	5.7		21.0
Replication 2					
Time (min)	Sample port	Conductivity (ms/cm)	Total dissolved solids (g/L)	Salinity	Temp (°C)
0.0	-	44.2	29.5	27.9	20.5
30.0	1	2.3	1.5		20.6
30.0	2	1.0	0.7		20.9
30.0	3	1.0	0.6		21.1
30.0	4	1.0	0.7		21.3
30.0	5	1.0	0.6		21.5
30.0	6	1.0	0.6		21.6
30.0	7	7.9	5.2		21.6
Replication 3					
Time (min)	Sample port	Conductivity (ms/cm)	Total dissolved solids (g/L)	Salinity	Temp (°C)
0.0	-	44.2	29.5	27.9	20.5
30.0	1	1.0	0.7		20.6
30.0	2	1.0	0.7		21.1
30.0	3	1.0	0.7		21.3
30.0	4	1.0	0.6		21.7
30.0	5	1.0	0.7		21.6
30.0	6	1.0	0.7		21.4
30.0	7	8.8	5.9		21.3

Table B-7. Three collected data sets for Diverter A at 3.03 L/min flow rate with the diverter chamber drain open.

Replication 1					
Time (min)	Sample port	Conductivity (ms/cm)	Total dissolved solids (g/L)	Salinity	Temp (°C)
0.0	-	43.9	29.2	27.9	25.9
30.0	1	1.4	1.0		25.5
30.0	2	1.0	0.6		25.6
30.0	3	0.8	0.6		25.8
30.0	4	0.9	0.6		25.7
30.0	5	31.1	20.7	19.0	25.5
30.0	6	39.3	26.2	24.7	25.5
30.0	7	40.8	27.7	25.8	25.3
Replication 2					
Time (min)	Sample port	Conductivity (ms/cm)	Total dissolved solids (g/L)	Salinity	Temp (°C)
0.0	-	43.7	29.1	27.8	25.9
30.0	1	1.0	0.7		26.6
30.0	2	0.9	0.6		26.7
30.0	3	0.9	0.6		26.7
30.0	4	1.0	0.7		26.7
30.0	5	29.2	19.5	17.9	26.7
30.0	6	40.3	26.9	25.5	26.6
30.0	7	41.4	27.6	26.2	26.5
Replication 3					
Time (min)	Sample port	Conductivity (ms/cm)	Total dissolved solids (g/L)	Salinity	Temp (°C)
0.0	-	44.2	29.4	28.2	26.2
30.0	1	1.1	0.7		27.0
30.0	2	0.8	0.6		27.0
30.0	3	0.9	0.6		27.1
30.0	4	0.9	0.6		27.1
30.0	5	28.3	18.9	17.1	27.1
30.0	6	40.7	27.1	25.8	27.0
30.0	7	41.9	27.9	26.6	26.8

Table B-8. Three collected data sets for Diverter B at 3.03 L/min flow rate with the diverter chamber drain open.

Replication 1					
Time (min)	Sample port	Conductivity (ms/cm)	Total dissolved solids (g/L)	Salinity	Temp (°C)
0.0	-	43.9	29.2	27.9	25.9
30.0	1	1.6	1.1		25.6
30.0	2	0.8	0.6		25.7
30.0	3	0.9	0.6		25.8
30.0	4	0.9	0.6		26.0
30.0	5	13.4	9.0	7.6	25.9
30.0	6	39.6	26.4	25.0	25.8
30.0	7	40.6	27.1	25.5	25.6
Replication 2					
Time (min)	Sample port	Conductivity (ms/cm)	Total dissolved solids (g/L)	Salinity	Temp (°C)
0.0	-	43.7	29.1	27.8	25.9
30.0	1	1.7	1.2		27.1
30.0	2	0.9	0.6		27.0
30.0	3	0.9	0.6		27.0
30.0	4	0.9	0.6		27.0
30.0	5	2.5	1.7		26.9
30.0	6	38.0	25.4	24.0	26.8
30.0	7	40.7	27.1	25.8	26.6
Replication 3					
Time (min)	Sample port	Conductivity (ms/cm)	Total dissolved solids (g/L)	Salinity	Temp (°C)
0.0	-	44.2	29.4	28.2	26.2
30.0	1	2.0	1.3		26.4
30.0	2	0.9	0.6		26.5
30.0	3	0.9	0.6		26.6
30.0	4	0.9	0.6		26.7
30.0	5	4.9	3.3		26.7
30.0	6	40.7	27.2	25.8	26.5
30.0	7	42.9	28.6	27.3	26.5

Table B-9. Three collected data sets for Diverter C at 3.03 L/min flow rate with the diverter chamber drain open.

Replication 1					
Time (min)	Sample port	Conductivity (ms/cm)	Total dissolved solids (g/L)	Salinity	Temp (°C)
0.0	-	43.9	29.2	27.9	25.9
30.0	1	1.8	1.2		25.6
30.0	2	0.9	0.6		25.7
30.0	3	0.9	0.6		25.7
30.0	4	0.9	0.6		25.8
30.0	5	0.9	0.6		26.0
30.0	6	0.9	0.6		26.0
30.0	7	8.8	5.9		25.9
Replication 2					
Time (min)	Sample port	Conductivity (ms/cm)	Total dissolved solids (g/L)	Salinity	Temp (°C)
0.0	-	43.7	29.1	27.8	25.9
30.0	1	1.9	1.3		26.7
30.0	2	0.9	0.6		26.7
30.0	3	0.9	0.6		26.8
30.0	4	0.9	0.6		26.8
30.0	5	0.9	0.5		26.8
30.0	6	0.9	0.6		26.9
30.0	7	0.9	6.1	5.1	26.7
Replication 3					
Time (min)	Sample port	Conductivity (ms/cm)	Total dissolved solids (g/L)	Salinity	Temp (°C)
0.0	-	44.2	29.4	28.2	26.2
30.0	1	2.1	1.4		27.2
30.0	2	0.9	0.6		27.2
30.0	3	0.8	0.6		27.3
30.0	4	0.8	0.6		27.3
30.0	5	0.9	0.6		27.3
30.0	6	0.8	0.6		27.3
30.0	7	9.4	6.3	5.3	27.3

Table B-10. Three collected data sets for Diverter D at 3.03 L/min flow rate with the diverter chamber drain open.

Replication 1					
Time (min)	Sample port	Conductivity (ms/cm)	Total dissolved solids (g/L)	Salinity	Temp (°C)
0.0	-	44.0	29.2	27.7	21.7
30.0	1	1.1	0.8		22.0
30.0	2	1.1	0.7		22.1
30.0	3	1.0	0.7		22.1
30.0	4	1.0	0.7		22.2
30.0	5	1.0	0.7		22.3
30.0	6	1.0	0.7		22.4
30.0	7	9.2	6.2	5.1	22.4
Replication 2					
Time (min)	Sample port	Conductivity (ms/cm)	Total dissolved solids (g/L)	Salinity	Temp (°C)
0.0	-	44.1	29.3	27.9	21.9
30.0	1	1.2	0.8		22.6
30.0	2	1.1	0.7		22.6
30.0	3	1.0	0.7		22.6
30.0	4	1.0	0.7		22.6
30.0	5	1.0	0.7		22.7
30.0	6	1.2	0.8		22.7
30.0	7	9.4	6.3	5.2	22.6
Replication 3					
Time (min)	Sample port	Conductivity (ms/cm)	Total dissolved solids (g/L)	Salinity	Temp (°C)
0.0	-	43.8	29.1	26.7	26.7
30.0	1	1.2	0.8		22.8
30.0	2	1.1	0.7		22.8
30.0	3	1.0	0.7		22.8
30.0	4	1.0	0.7		22.8
30.0	5	1.0	0.7		22.8
30.0	6	1.0	0.7		22.8
30.0	7	6.1	6.2	5.1	22.8

Table B-11. Three collected data sets for Diverter E at 3.03 L/min flow rate with the diverter chamber drain open.

Replication 1					
Time (min)	Sample port	Conductivity (ms/cm)	Total dissolved solids (g/L)	Salinity	Temp (°C)
0.0	-	44.0	29.2	27.7	21.7
30.0	1	1.8	0.8		22.4
30.0	2	1.0	0.7		22.4
30.0	3	1.0	0.7		22.5
30.0	4	1.0	0.7		22.6
30.0	5	1.0	0.7		22.6
30.0	6	1.0	0.7		22.6
30.0	7	9.6	6.2	5.3	22.6
Replication 2					
Time (min)	Sample port	Conductivity (ms/cm)	Total dissolved solids (g/L)	Salinity	Temp (°C)
0.0	-	44.1	29.3	27.9	21.9
30.0	1	1.9	1.3		22.3
30.0	2	1.9	0.7		22.4
30.0	3	1.0	0.7		22.4
30.0	4	1.0	0.7		22.5
30.0	5	1.0	0.7		22.6
30.0	6	1.0	0.7		22.7
30.0	7	9.4	6.2	5.2	22.7
Replication 3					
Time (min)	Sample port	Conductivity (ms/cm)	Total dissolved solids (g/L)	Salinity	Temp (°C)
0.0	-	43.8	29.1	26.7	26.7
30.0	1	1.8	1.2		23.0
30.0	2	1.0	0.7		23.0
30.0	3	1.0	0.7		23.0
30.0	4	1.0	0.7		23.0
30.0	5	1.0	0.7		23.0
30.0	6	1.0	0.7		22.9
30.0	7	9.3	6.2	5.1	22.9

Table B-12. Three collected data sets for Diverter F at 3.03 L/min flow rate with the diverter chamber drain open.

Replication 1					
Time (min)	Sample port	Conductivity (ms/cm)	Total dissolved solids (g/L)	Salinity	Temp (°C)
0.0	-	44.1	29.4	27.8	20.5
30.0	1	2.5	1.6		20.4
30.0	2	1.0	0.7		20.7
30.0	3	1.0	0.6		20.8
30.0	4	1.0	0.6		21.0
30.0	5	1.0	0.6		21.1
30.0	6	1.0	0.6		21.2
30.0	7	7.6	5.1		21.3
Replication 2					
Time (min)	Sample port	Conductivity (ms/cm)	Total dissolved solids (g/L)	Salinity	Temp (°C)
0.0	-	2.7	29.4	27.8	20.5
30.0	1	1.0	0.7		21.1
30.0	2	1.0	0.7		21.3
30.0	3	1.0	0.6		21.3
30.0	4	1.0	0.6		21.7
30.0	5	1.0	0.6		21.6
30.0	6	1.0	0.7		21.7
30.0	7	7.4	5.0		21.3
Replication 3					
Time (min)	Sample port	Conductivity (ms/cm)	Total dissolved solids (g/L)	Salinity	Temp (°C)
0.0	-	2.3	29.4	27.8	20.5
30.0	1	1.0	1.5		20.6
30.0	2	1.0	0.7		20.8
30.0	3	1.0	0.7		21.2
30.0	4	1.0	0.7		21.3
30.0	5	1.0	0.6		21.3
30.0	6	1.0	0.6		21.6
30.0	7	7.3	4.9		21.6

Table B-13. Three collected data sets for Diverter A at 12.11 L/min flow rate with the diverter chamber drain open.

Replication 1					
Time (min)	Sample port	Conductivity (ms/cm)	Total dissolved solids (g/L)	Salinity	Temp (°C)
0.0	-	43.9	29.2	27.9	26.0
30.0	1	1.8	1.2		26.6
30.0	2	1.0	0.7		26.6
30.0	3	0.9	0.6		26.7
30.0	4	0.9	0.6		26.8
30.0	5	1.1	0.7		26.9
30.0	6	41.7	27.9	26.6	26.8
30.0	7	42.6	28.4	27.1	26.7
Replication 2					
Time (min)	Sample port	Conductivity (ms/cm)	Total dissolved solids (g/L)	Salinity	Temp (°C)
0.0	-	43.7	29.1	27.8	26.3
30.0	1	1.0	0.7		27.0
30.0	2	0.9	0.6		26.7
30.0	3	0.9	0.6		26.7
30.0	4	0.8	0.5		26.6
30.0	5	9.5	6.4	5.3	26.6
30.0	6	38.8	25.9	24.6	26.5
30.0	7	42.4	28.3	27.0	26.3
Replication 3					
Time (min)	Sample port	Conductivity (ms/cm)	Total dissolved solids (g/L)	Salinity	Temp (°C)
0.0	-	44.1	29.4	28.1	26.8
30.0	1	1.6	1.0		26.9
30.0	2	0.9	0.6		26.8
30.0	3	0.8	0.5		26.8
30.0	4	0.8	0.5		26.8
30.0	5	0.8	0.6		26.7
30.0	6	1.0	0.7		26.7
30.0	7	42.0	28.0	26.7	26.5

Table B-14. Three collected data sets for Diverter B at 12.11 L/min flow rate with the diverter chamber drain open.

Replication 1					
Time (min)	Sample port	Conductivity (ms/cm)	Total dissolved solids (g/L)	Salinity	Temp (°C)
0.0	-	43.9	29.2	27.9	26.0
30.0	1	1.9	1.3		26.5
30.0	2	0.9	0.6		26.5
30.0	3	0.9	0.6		26.7
30.0	4	0.9	0.6		26.8
30.0	5	0.9	0.6		26.8
30.0	6	1.3	0.9		26.7
30.0	7	40.6	27.1	25.8	26.7
Replication 2					
Time (min)	Sample port	Conductivity (ms/cm)	Total dissolved solids (g/L)	Salinity	Temp (°C)
0.0	-	43.7	29.1	27.8	26.3
30.0	1	0.8	0.5		28.2
30.0	2	0.8	0.6		27.8
30.0	3	1.0	0.7		26.6
30.0	4	1.0	0.7		27.5
30.0	5	1.1	0.7		27.3
30.0	6	39.4	26.4	25.1	27.1
30.0	7	41.9	27.9	26.6	26.8
Replication 3					
Time (min)	Sample port	Conductivity (ms/cm)	Total dissolved solids (g/L)	Salinity	Temp (°C)
0.0	-	44.1	29.4	28.1	26.8
30.0	1	1.8	1.2		26.4
30.0	2	1.1	0.7		26.4
30.0	3	0.9	0.6		26.4
30.0	4	0.9	0.6		26.5
30.0	5	1.5	1.0		26.3
30.0	6	39.4	26.3	24.9	26.3
30.0	7	43.2	28.8	27.5	26.1

Table B-15. Three collected data sets for Diverter C at 12.11 L/min flow rate with the diverter chamber drain open.

Replication 1					
Time (min)	Sample port	Conductivity (ms/cm)	Total dissolved solids (g/L)	Salinity	Temp (°C)
0.0	-	43.9	29.2	27.9	26.0
30.0	1	1.6	1.1		26.5
30.0	2	0.9	0.6		26.5
30.0	3	0.9	0.6		26.5
30.0	4	0.9	0.6		26.6
30.0	5	0.9	0.6		26.6
30.0	6	0.9	0.6		26.5
30.0	7	9.0	6.0		26.7
Replication 2					
Time (min)	Sample port	Conductivity (ms/cm)	Total dissolved solids (g/L)	Salinity	Temp (°C)
0.0	-	43.7	29.1	27.8	26.3
30.0	1	1.7	1.1		26.6
30.0	2	0.9	0.6		26.6
30.0	3	0.9	0.6		26.6
30.0	4	0.9	0.6		26.7
30.0	5	0.9	0.6		26.7
30.0	6	0.9	0.6		26.8
30.0	7	9.5	6.3	5.3	26.7
Replication 3					
Time (min)	Sample port	Conductivity (ms/cm)	Total dissolved solids (g/L)	Salinity	Temp (°C)
0.0	-	44.1	29.4	28.1	26.8
30.0	1	2.1	1.4		26.0
30.0	2	0.9	0.6		26.1
30.0	3	0.9	0.6		26.1
30.0	4	0.9	0.6		26.2
30.0	5	0.9	0.6		26.2
30.0	6	0.9	0.6		26.3
30.0	7	9.5	6.3	5.3	26.1

Table B-16. Three collected data sets for Diverter D at 12.11 L/min flow rate with the diverter chamber drain open.

Replication 1					
Time (min)	Sample port	Conductivity (ms/cm)	Total dissolved solids (g/L)	Salinity	Temp (°C)
0.0	-	43.6	29.0	27.5	22.5
30.0	1	1.3	0.8		22.4
30.0	2	1.1	0.7		22.4
30.0	3	1.0	0.7		22.4
30.0	4	1.0	0.7		22.4
30.0	5	1.0	0.6		22.5
30.0	6	1.0	0.7		22.5
30.0	7	9.1	6.1	5.1	22.5
Replication 2					
Time (min)	Sample port	Conductivity (ms/cm)	Total dissolved solids (g/L)	Salinity	Temp (°C)
0.0	-	44.0	29.2	27.7	21.6
30.0	1	1.2	0.8		21.9
30.0	2	1.1	0.7		21.9
30.0	3	1.0	0.7		22.1
30.0	4	1.0	0.7		22.1
30.0	5	1.0	0.7		22.2
30.0	6	1.0	0.7		22.2
30.0	7	9.1	6.1	5.1	22.1
Replication 3					
Time (min)	Sample port	Conductivity (ms/cm)	Total dissolved solids (g/L)	Salinity	Temp (°C)
0.0	-	44.3	29.5	28.1	22.8
30.0	1	1.9	1.3		22.9
30.0	2	1.1	0.7		22.8
30.0	3	1.0	0.7		22.7
30.0	4	1.0	0.7		22.7
30.0	5	1.0	0.7		22.6
30.0	6	1.0	0.7		22.6
30.0	7	8.7	5.8		22.6

Table B-17. Three collected data sets for Diverter E at 12.11 L/min flow rate with the diverter chamber drain open.

Replication 1					
Time (min)	Sample port	Conductivity (ms/cm)	Total dissolved solids (g/L)	Salinity	Temp (°C)
0.0	-	43.6	29.0	27.5	22.5
30.0	1	1.4	0.9		23.0
30.0	2	1.0	0.7		23.0
30.0	3	1.0	0.7		22.8
30.0	4	1.0	0.7		22.8
30.0	5	1.0	0.7		22.8
30.0	6	1.0	0.7		22.8
30.0	7	9.0	6.0		22.7
Replication 2					
Time (min)	Sample port	Conductivity (ms/cm)	Total dissolved solids (g/L)	Salinity	Temp (°C)
0.0	-	44.0	29.2	27.7	21.6
30.0	1	1.8	1.2		21.1
30.0	2	1.0	0.7		21.4
30.0	3	1.0	0.7		21.5
30.0	4	1.0	0.7		21.7
30.0	5	1.0	0.7		21.9
30.0	6	1.0	0.7		21.9
30.0	7	8.9	6.0		22.0
Replication 3					
Time (min)	Sample port	Conductivity (ms/cm)	Total dissolved solids (g/L)	Salinity	Temp (°C)
0.0	-	44.3	29.5	28.1	22.8
30.0	1	1.1	0.8		22.5
30.0	2	1.0	0.7		22.6
30.0	3	1.0	0.7		22.6
30.0	4	1.0	0.7		22.6
30.0	5	1.5	1.0		22.6
30.0	6	1.0	0.7		22.6
30.0	7	9.4	6.2	5.1	22.6

Table B-18. Three collected data sets for Diverter F at 12.11 L/min flow rate with the diverter chamber drain open.

Replication 1					
Time (min)	Sample port	Conductivity (ms/cm)	Total dissolved solids (g/L)	Salinity	Temp (°C)
0.0	-	44.4	29.5	28.1	20.1
30.0	1	1.8	1.2		20.2
30.0	2	1.0	0.7		20.3
30.0	3	1.0	0.6		20.5
30.0	4	1.0	0.7		20.7
30.0	5	1.0	0.6		20.7
30.0	6	1.0	0.6		20.8
30.0	7	8.8	5.9		20.9
Replication 2					
Time (min)	Sample port	Conductivity (ms/cm)	Total dissolved solids (g/L)	Salinity	Temp (°C)
0.0	-	44.4	29.5	28.1	20.2
30.0	1	1.9	1.2		20.5
30.0	2	1.0	0.7		20.5
30.0	3	0.9	0.6		20.7
30.0	4	1.0	0.6		20.9
30.0	5	0.9	0.6		20.8
30.0	6	1.0	0.7		21.0
30.0	7	8.8	5.9		20.8
Replication 3					
Time (min)	Sample port	Conductivity (ms/cm)	Total dissolved solids (g/L)	Salinity	Temp (°C)
0.0	-	44.4	29.5	28.1	20.2
30.0	1	1.7	1.2		20.8
30.0	2	1.0	0.6		20.7
30.0	3	0.9	0.6		20.8
30.0	4	1.0	0.6		20.9
30.0	5	1.0	0.7		21.0
30.0	6	0.9	0.6		21.1
30.0	7	8.7	5.8		21.1

Table B-19. Three collected data sets for Diverter A at 22.71 L/min flow rate with the diverter chamber drain open.

Replication 1					
Time (min)	Sample port	Conductivity (ms/cm)	Total dissolved solids (g/L)	Salinity	Temp (°C)
0.0	-	44.0	29.2	27.8	23.4
30.0	1	1.7	1.1		23.2
30.0	2	0.9	0.6		23.1
30.0	3	1.0	0.6		23.0
30.0	4	1.0	0.7		22.9
30.0	5	1.0	0.7		22.8
30.0	6	40.9	27.2	25.7	22.8
30.0	7	43.1	28.7	27.2	22.8
Replication 2					
Time (min)	Sample port	Conductivity (ms/cm)	Total dissolved solids (g/L)	Salinity	Temp (°C)
0.0	-	43.9	29.1	27.7	23.2
30.0	1	1.1	0.7		22.6
30.0	2	0.9	0.6		22.6
30.0	3	1.0	0.6		22.7
30.0	4	1.0	0.7		22.6
30.0	5	1.1	0.7		22.7
30.0	6	41.7	27.2	26.2	22.6
30.0	7	43.5	28.8	27.4	22.8
Replication 3					
Time (min)	Sample port	Conductivity (ms/cm)	Total dissolved solids (g/L)	Salinity	Temp (°C)
0.0	-	44.1	29.4	28.0	23.2
30.0	1	1.9	1.3		23.8
30.0	2	0.9	0.6		23.6
30.0	3	1.0	0.6		23.5
30.0	4	1.0	0.7		23.4
30.0	5	1.0	0.7		23.3
30.0	6	39.6	26.4	24.9	23.3
30.0	7	42.0	28.0	26.5	23.3

Table B-20. Three collected data sets for Diverter B at 22.71 L/min flow rate with the diverter chamber drain open.

Replication 1					
Time (min)	Sample port	Conductivity (ms/cm)	Total dissolved solids (g/L)	Salinity	Temp (°C)
0.0	-	44.0	29.2	27.8	23.4
30.0	1	1.7	1.2		22.7
30.0	2	1.0	0.6		22.6
30.0	3	0.9	0.6		22.6
30.0	4	0.9	0.6		22.6
30.0	5	1.0	0.6		22.6
30.0	6	42.0	28.0	25.3	22.7
30.0	7	43.0	27.3	25.6	22.8
Replication 2					
Time (min)	Sample port	Conductivity (ms/cm)	Total dissolved solids (g/L)	Salinity	Temp (°C)
0.0	-	43.9	29.1	27.7	23.2
30.0	1	1.7	1.1		23.2
30.0	2	0.9	0.6		23.1
30.0	3	0.9	0.6		23.1
30.0	4	0.9	0.6		23.0
30.0	5	1.0	0.7		23.0
30.0	6	39.9	26.5	25.0	23.0
30.0	7	42.2	28.1	26.5	22.9
Replication 3					
Time (min)	Sample port	Conductivity (ms/cm)	Total dissolved solids (g/L)	Salinity	Temp (°C)
0.0	-	44.1	29.4	28.0	23.2
30.0	1	1.7	1.2		23.3
30.0	2	1.0	0.6		23.3
30.0	3	0.9	0.6		23.3
30.0	4	0.9	0.6		23.3
30.0	5	1.0	0.6		23.3
30.0	6	40.1	26.7	25.2	23.2
30.0	7	42.6	28.3	25.9	23.2

Table B-21. Three collected data sets for Diverter C at 22.71 L/min flow rate with the diverter chamber drain open.

Replication 1					
Time (min)	Sample port	Conductivity (ms/cm)	Total dissolved solids (g/L)	Salinity	Temp (°C)
0.0	-	44.0	29.2	27.8	23.4
30.0	1	1.9	1.3		22.7
30.0	2	1.0	0.7		22.6
30.0	3	1.0	0.7		22.6
30.0	4	0.9	0.6		22.6
30.0	5	0.9	0.6		22.5
30.0	6	1.0	0.6		22.5
30.0	7	7.0	4.7		22.3
Replication 2					
Time (min)	Sample port	Conductivity (ms/cm)	Total dissolved solids (g/L)	Salinity	Temp (°C)
0.0	-	43.9	29.1	27.7	23.2
30.0	1	1.9	1.2		22.9
30.0	2	0.9	0.6		22.9
30.0	3	0.9	0.6		22.9
30.0	4	0.9	0.6		22.8
30.0	5	0.9	0.6		22.8
30.0	6	0.9	0.6		22.8
30.0	7	8.8	5.9		22.8
Replication 3					
Time (min)	Sample port	Conductivity (ms/cm)	Total dissolved solids (g/L)	Salinity	Temp (°C)
0.0	-	44.1	29.4	28.0	23.2
30.0	1	1.8	1.2		23.3
30.0	2	1.0	0.7		23.2
30.0	3	0.9	0.6		23.2
30.0	4	0.9	0.6		23.2
30.0	5	0.9	0.6		23.2
30.0	6	0.9	0.6		23.2
30.0	7	8.7	5.8		23.1

Table B-22. Three collected data sets for Diverter D at 22.71 L/min flow rate with the diverter chamber drain open.

Replication 1					
Time (min)	Sample port	Conductivity (ms/cm)	Total dissolved solids (g/L)	Salinity	Temp (°C)
0.0	-	43.8	29.2	27.7	21.5
30.0	1	1.3	0.9		20.5
30.0	2	1.2	0.8		20.4
30.0	3	1.1	0.8		20.5
30.0	4	1.0	0.7		20.5
30.0	5	1.0	0.7		20.6
30.0	6	1.0	0.7		20.7
30.0	7	9.5	6.4	5.3	20.6
Replication 2					
Time (min)	Sample port	Conductivity (ms/cm)	Total dissolved solids (g/L)	Salinity	Temp (°C)
0.0	-	44.0	29.3	27.8	21.3
30.0	1	1.2	0.8		21.9
30.0	2	1.2	0.8		21.9
30.0	3	1.1	0.7		21.9
30.0	4	1.6	1.6		21.8
30.0	5	1.2	0.8		21.9
30.0	6	1.2	0.8		21.9
30.0	7	9.6	6.4	5.3	21.9
Replication 3					
Time (min)	Sample port	Conductivity (ms/cm)	Total dissolved solids (g/L)	Salinity	Temp (°C)
0.0	-	44.0	29.3	27.9	21.8
30.0	1	1.8	1.2		21.8
30.0	2	1.4	0.7		21.9
30.0	3	1.0	0.6		21.9
30.0	4	1.0	0.6		22.0
30.0	5	1.0	0.7		22.1
30.0	6	1.1	0.7		22.1
30.0	7	9.2	6.1	5.1	22.1

Table B-23. Three collected data sets for Diverter E at 22.71 L/min flow rate with the diverter chamber drain open.

Replication 1					
Time (min)	Sample port	Conductivity (ms/cm)	Total dissolved solids (g/L)	Salinity	Temp (°C)
0.0	-	43.8	29.2	27.7	21.5
30.0	1	1.8	1.2		20.9
30.0	2	1.2	0.8		20.8
30.0	3	1.2	0.8		20.7
30.0	4	1.2	0.8		20.7
30.0	5	1.2	0.8		20.7
30.0	6	1.1	0.7		20.7
30.0	7	9.2	6.1	5.0	20.6
Replication 2					
Time (min)	Sample port	Conductivity (ms/cm)	Total dissolved solids (g/L)	Salinity	Temp (°C)
0.0	-	44.0	29.3	27.8	21.3
30.0	1	1.0	1.3		21.5
30.0	2	1.2	0.8		21.6
30.0	3	1.2	0.8		21.7
30.0	4	1.2	0.8		21.8
30.0	5	1.2	0.8		21.9
30.0	6	1.2	0.8		21.9
30.0	7	9.3	6.2	5.1	21.9
Replication 3					
Time (min)	Sample port	Conductivity (ms/cm)	Total dissolved solids (g/L)	Salinity	Temp (°C)
0.0	-	44.0	29.3	27.9	21.8
30.0	1	1.1	0.7		22.0
30.0	2	1.0	0.6		22.1
30.0	3	1.0	0.7		22.1
30.0	4	1.0	0.7		22.1
30.0	5	1.0	0.7		22.2
30.0	6	1.0	0.6		22.2
30.0	7	9.4	6.2	5.2	22.2

Table B-24. Three collected data sets for Diverter F at 22.71 L/min flow rate with the diverter chamber drain open.

Replication 1					
Time (min)	Sample port	Conductivity (ms/cm)	Total dissolved solids (g/L)	Salinity	Temp (°C)
0.0	-	44.1	29.3	27.8	20.1
30.0	1	1.7	1.1		20.2
30.0	2	1.0	0.7		20.2
30.0	3	0.9	0.6		20.4
30.0	4	1.0	0.6		20.4
30.0	5	1.0	0.6		20.3
30.0	6	1.0	0.7		20.3
30.0	7	8.9	5.9		20.4
Replication 2					
Time (min)	Sample port	Conductivity (ms/cm)	Total dissolved solids (g/L)	Salinity	Temp (°C)
0.0	-	44.1	29.3	27.8	20.1
30.0	1	2.5	1.6		20.2
30.0	2	1.0	0.7		20.3
30.0	3	1.0	0.6		20.6
30.0	4	1.0	0.7		20.8
30.0	5	1.0	0.6		21.0
30.0	6	1.0	0.6		21.3
30.0	7	7.9	5.3		21.5
Replication 3					
Time (min)	Sample port	Conductivity (ms/cm)	Total dissolved solids (g/L)	Salinity	Temp (°C)
0.0	-	44.0	29.2	27.8	20.2
30.0	1	1.8	1.1		20.4
30.0	2	1.0	0.6		20.5
30.0	3	1.0	0.7		20.5
30.0	4	1.0	0.6		20.4
30.0	5	1.0	0.7		20.4
30.0	6	1.0	0.6		20.4
30.0	7	7.0	4.7		20.3

Table B-25. Three collected data sets for Diverter A at 43.91 L/min flow rate with the diverter chamber drain open.

Replication 1					
Time (min)	Sample port	Conductivity (ms/cm)	Total dissolved solids (g/L)	Salinity	Temp (°C)
0.0	-	44.0	29.3	27.8	20.9
30.0	1	1.7	1.2		20.8
30.0	2	1.0	0.6		21.0
30.0	3	1.0	0.6		21.1
30.0	4	1.0	0.7		21.2
30.0	5	1.0	0.7		21.3
30.0	6	24.4	16.3	14.6	21.3
30.0	7	42.1	28.1	26.5	21.2
Replication 2					
Time (min)	Sample port	Conductivity (ms/cm)	Total dissolved solids (g/L)	Salinity	Temp (°C)
0.0	-	44.0	29.3	27.7	21.8
30.0	1	1.1	0.7		20.3
30.0	2	1.0	0.7		20.5
30.0	3	1.0	0.6		20.7
30.0	4	1.0	0.6		20.9
30.0	5	1.0	0.7		21.0
30.0	6	41.0	27.3	25.7	21.1
30.0	7	42.5	28.3	26.8	21.1
Replication 3					
Time (min)	Sample port	Conductivity (ms/cm)	Total dissolved solids (g/L)	Salinity	Temp (°C)
0.0	-	44.0	29.3	27.8	22.4
30.0	1	1.1	0.7		20.7
30.0	2	1.0	0.6		21.0
30.0	3	1.0	0.6		21.3
30.0	4	1.0	0.7		21.4
30.0	5	1.7	1.1		21.6
30.0	6	41.6	27.8	26.2	21.7
30.0	7	42.9	28.6	27.0	21.7

Table B-26. Three collected data sets for Diverter B at 43.91 L/min flow rate with the diverter chamber drain open.

Replication 1					
Time (min)	Sample port	Conductivity (ms/cm)	Total dissolved solids (g/L)	Salinity	Temp (°C)
0.0	-	44.0	29.3	27.8	20.9
30.0	1	1.5	1.0		19.9
30.0	2	1.1	0.8		20.2
30.0	3	1.0	0.6		20.4
30.0	4	1.0	0.6		20.7
30.0	5	1.0	0.6		20.9
30.0	6	41.5	27.6	26.1	20.9
30.0	7	42.6	28.4	26.8	20.9
Replication 2					
Time (min)	Sample port	Conductivity (ms/cm)	Total dissolved solids (g/L)	Salinity	Temp (°C)
0.0	-	44.0	29.3	27.7	21.8
30.0	1	1.7	1.1		20.3
30.0	2	1.0	0.7		20.5
30.0	3	1.0	0.7		20.8
30.0	4	1.1	0.7		21.1
30.0	5	1.2	0.8		21.2
30.0	6	1.2	0.8		21.3
30.0	7	41.3	27.5	25.9	21.4
Replication 3					
Time (min)	Sample port	Conductivity (ms/cm)	Total dissolved solids (g/L)	Salinity	Temp (°C)
0.0	-	44.0	29.3	27.8	22.4
30.0	1	2.0	1.3		20.9
30.0	2	1.2	0.8		21.1
30.0	3	1.2	0.8		21.3
30.0	4	1.0	0.6		21.5
30.0	5	1.0	0.7		21.7
30.0	6	1.1	0.7		21.8
30.0	7	41.5	27.6	26.1	21.9

Table B-27. Three collected data sets for Diverter C at 43.91 L/min flow rate with the diverter chamber drain open.

Replication 1					
Time (min)	Sample port	Conductivity (ms/cm)	Total dissolved solids (g/L)	Salinity	Temp (°C)
0.0	-	44.0	29.3	27.8	20.9
30.0	1	1.6	1.0		20.0
30.0	2	0.9	0.6		20.3
30.0	3	0.9	0.6		20.5
30.0	4	0.9	0.6		20.7
30.0	5	1.0	0.6		20.9
30.0	6	0.9	0.6		21.1
30.0	7	9.1	6.0		21.1
Replication 2					
Time (min)	Sample port	Conductivity (ms/cm)	Total dissolved solids (g/L)	Salinity	Temp (°C)
0.0	-	44.0	29.3	27.7	21.8
30.0	1	1.9	1.3		22.2
30.0	2	1.0	0.7		22.1
30.0	3	0.9	0.6		22.0
30.0	4	0.9	0.6		22.0
30.0	5	0.9	0.6		21.9
30.0	6	0.9	0.6		21.9
30.0	7	7.2	4.8		21.8
Replication 3					
Time (min)	Sample port	Conductivity (ms/cm)	Total dissolved solids (g/L)	Salinity	Temp (°C)
0.0	-	44.0	29.3	27.8	22.4
30.0	1	2.0	1.3		21.3
30.0	2	1.0	0.7		21.4
30.0	3	1.0	0.6		21.6
30.0	4	1.0	0.6		21.8
30.0	5	1.0	0.6		22.0
30.0	6	1.0	0.6		22.1
30.0	7	9.2	6.1	5.1	22.1

Table B-28. Three collected data sets for Diverter D at 43.91 L/min flow rate with the diverter chamber drain open.

Replication 1					
Time (min)	Sample port	Conductivity (ms/cm)	Total dissolved solids (g/L)	Salinity	Temp (°C)
0.0	-	43.9	29.2	27.7	22.3
30.0	1	1.1	0.7		23.0
30.0	2	1.1	0.7		23.0
30.0	3	1.2	0.8		23.1
30.0	4	1.2	0.8		23.1
30.0	5	1.2	0.8		23.1
30.0	6	1.1	0.7		23.1
30.0	7	9.4	6.3	5.2	23.1
Replication 2					
Time (min)	Sample port	Conductivity (ms/cm)	Total dissolved solids (g/L)	Salinity	Temp (°C)
0.0	-	43.9	29.2	27.8	23.8
30.0	1	1.6	1.1		23.3
30.0	2	1.0	0.7		23.2
30.0	3	1.0	0.7		23.1
30.0	4	1.0	0.7		23.1
30.0	5	1.0	0.7		23.1
30.0	6	1.0	0.7		23.1
30.0	7	9.6	6.4	5.3	23.0
Replication 3					
Time (min)	Sample port	Conductivity (ms/cm)	Total dissolved solids (g/L)	Salinity	Temp (°C)
0.0	-	44.0	29.3	28.0	23.4
30.0	1	1.6	1.1		23.4
30.0	2	1.0	0.7		23.4
30.0	3	1.0	0.7		23.4
30.0	4	1.0	0.7		23.4
30.0	5	1.0	0.7		23.3
30.0	6	1.0	0.7		23.3
30.0	7	8.9	5.9		23.2

Table B-29. Three collected data sets for Diverter E at 43.91 L/min flow rate with the diverter chamber drain open.

Replication 1					
Time (min)	Sample port	Conductivity (ms/cm)	Total dissolved solids (g/L)	Salinity	Temp (°C)
0.0	-	43.9	29.2	27.7	22.3
30.0	1	1.8	1.1		23.2
30.0	2	1.2	0.8		22.9
30.0	3	1.1	0.8		22.9
30.0	4	1.2	0.8		22.9
30.0	5	1.2	0.8		22.9
30.0	6	1.2	0.8		22.9
30.0	7	9.1	6.0	5.0	22.9
Replication 2					
Time (min)	Sample port	Conductivity (ms/cm)	Total dissolved solids (g/L)	Salinity	Temp (°C)
0.0	-	43.9	29.2	27.8	23.8
30.0	1	1.2	0.8		22.8
30.0	2	1.0	0.7		22.9
30.0	3	1.1	0.8		23.0
30.0	4	1.1	0.8		23.0
30.0	5	1.0	0.7		23.0
30.0	6	1.0	0.7		23.0
30.0	7	9.1	6.1	5.0	22.9
Replication 3					
Time (min)	Sample port	Conductivity (ms/cm)	Total dissolved solids (g/L)	Salinity	Temp (°C)
0.0	-	44.0	29.3	28.0	23.4
30.0	1	1.1	0.8		22.6
30.0	2	1.0	0.7		22.8
30.0	3	1.0	0.7		23.0
30.0	4	1.0	0.7		23.0
30.0	5	1.0	0.7		23.1
30.0	6	1.0	0.7		23.2
30.0	7	9.7	6.4	5.3	23.2

Table B-30. Three collected data sets for Diverter F at 43.91 L/min flow rate with the diverter chamber drain open.

Replication 1					
Time (min)	Sample port	Conductivity (ms/cm)	Total dissolved solids (g/L)	Salinity	Temp (°C)
0.0	-	43.6	29.0	27.4	19.8
30.0	1	2.7	1.7		20.1
30.0	2	1.1	0.8		20.4
30.0	3	1.0	0.7		20.5
30.0	4	1.1	0.7		20.5
30.0	5	1.1	0.7		20.5
30.0	6	1.1	0.8		20.3
30.0	7	7.6	5.1		20.3
Replication 2					
Time (min)	Sample port	Conductivity (ms/cm)	Total dissolved solids (g/L)	Salinity	Temp (°C)
0.0	-	43.6	29.0	27.4	19.8
30.0	1	1.8	1.1		20.2
30.0	2	1.0	0.7		20.5
30.0	3	1.0	0.7		20.6
30.0	4	1.0	0.6		20.4
30.0	5	1.0	0.7		20.4
30.0	6	1.0	0.7		20.3
30.0	7	7.1	5.0		20.3
Replication 3					
Time (min)	Sample port	Conductivity (ms/cm)	Total dissolved solids (g/L)	Salinity	Temp (°C)
0.0	-	43.6	29.0	27.4	19.8
30.0	1	1.3	0.9		20.3
30.0	2	1.0	0.7		20.5
30.0	3	1.2	0.8		20.6
30.0	4	1.1	0.7		20.6
30.0	5	1.2	0.8		20.6
30.0	6	1.0	0.7		20.4
30.0	7	8.7	5.8		20.4

Table B-31. Three collected data sets for Diverter A at 75.71 L/min flow rate with the diverter chamber drain open.

Replication 1					
Time (min)	Sample port	Conductivity (ms/cm)	Total dissolved solids (g/L)	Salinity	Temp (°C)
0.0	-	44.2	29.5	27.8	20.6
30.0	1	2.5	1.7		21.8
30.0	2	1.2	0.8		22.2
30.0	3	1.3	0.9		22.7
30.0	4	1.3	0.9		23.1
30.0	5	1.3	0.9		23.4
30.0	6	1.2	0.8		23.7
30.0	7	39.3	26.5	25.0	23.5
Replication 2					
Time (min)	Sample port	Conductivity (ms/cm)	Total dissolved solids (g/L)	Salinity	Temp (°C)
0.0	-	44.0	29.3	22.8	21.5
30.0	1	2.0	1.3		23.0
30.0	2	1.2	0.8		23.2
30.0	3	1.2	0.8		23.6
30.0	4	1.2	0.8		23.8
30.0	5	1.2	0.8		24.0
30.0	6	1.6	1.1		24.0
30.0	7	40.9	26.9	25.6	23.8
Replication 3					
Time (min)	Sample port	Conductivity (ms/cm)	Total dissolved solids (g/L)	Salinity	Temp (°C)
0.0	-	44.0	29.2	27.8	19.6
30.0	1	3.0	1.9		20.3
30.0	2	1.1	0.8		20.7
30.0	3	1.1	0.7		20.9
30.0	4	1.1	0.7		21.0
30.0	5	1.1	0.8		21.1
30.0	6	1.3	0.8		21.1
30.0	7	40.6	27.3	25.8	20.6

Table B-32. Three collected data sets for Diverter B at 75.71 L/min flow rate with the diverter chamber drain open.

Replication 1					
Time (min)	Sample port	Conductivity (ms/cm)	Total dissolved solids (g/L)	Salinity	Temp (°C)
0.0	-	44.2	29.5	27.8	20.6
30.0	1	2.4	1.6		23.4
30.0	2	1.1	0.7		23.5
30.0	3	1.2	0.8		23.6
30.0	4	1.1	0.8		23.7
30.0	5	10.8	7.3	6.1	23.6
30.0	6	39.1	26.2	24.8	23.3
30.0	7	40.8	27.3	25.8	22.3
Replication 2					
Time (min)	Sample port	Conductivity (ms/cm)	Total dissolved solids (g/L)	Salinity	Temp (°C)
0.0	-	44.0	29.3	22.8	21.5
30.0	1	2.1	1.3		21.8
30.0	2	1.3	0.8		22.5
30.0	3	1.3	0.9		23.4
30.0	4	1.1	0.8		23.7
30.0	5	4.2	2.8		23.8
30.0	6	39.1	26.2	24.8	23.8
30.0	7	40.6	27.3	25.9	23.1
Replication 3					
Time (min)	Sample port	Conductivity (ms/cm)	Total dissolved solids (g/L)	Salinity	Temp (°C)
0.0	-	44.0	29.2	27.8	19.6
30.0	1	2.1	1.3		20.4
30.0	2	1.5	0.8		20.4
30.0	3	1.1	0.7		20.6
30.0	4	1.2	0.8		20.7
30.0	5	2.1	1.4		20.7
30.0	6	37.5	25.2	23.6	20.2
30.0	7	40.3	27.0	25.4	19.7

Table B-33. Three collected data sets for Diverter C at 75.71 L/min flow rate with the diverter chamber drain open.

Replication 1					
Time (min)	Sample port	Conductivity (ms/cm)	Total dissolved solids (g/L)	Salinity	Temp (°C)
0.0	-	44.0	29.3	27.8	20.4
30.0	1	2.2	1.5		22.0
30.0	2	1.3	0.8		22.2
30.0	3	1.3	0.8		22.4
30.0	4	1.3	0.9		22.6
30.0	5	1.3	0.8		22.8
30.0	6	1.3	0.8		22.9
30.0	7	9.2	6.2	5.1	23.0
Replication 2					
Time (min)	Sample port	Conductivity (ms/cm)	Total dissolved solids (g/L)	Salinity	Temp (°C)
0.0	-	43.3	29.5	28.0	22.2
30.0	1	1.2	1.3		22.0
30.0	2	1.1	0.7		22.2
30.0	3	1.1	0.8		22.5
30.0	4	1.0	0.7		22.7
30.0	5	1.0	0.7		22.9
30.0	6	1.0	0.7		23.1
30.0	7	9.2	6.1	5.1	23.1
Replication 3					
Time (min)	Sample port	Conductivity (ms/cm)	Total dissolved solids (g/L)	Salinity	Temp (°C)
0.0	-	44.3	29.5	28.1	21.9
30.0	1	1.3	0.9		21.2
30.0	2	1.1	0.7		21.5
30.0	3	1.1	0.7		21.8
30.0	4	1.0	0.7		22.1
30.0	5	1.0	0.7		22.7
30.0	6	1.0	0.7		22.9
30.0	7	8.3	5.5		23.0

Table B-34. Three collected data sets for Diverter D at 75.71 L/min flow rate with the diverter chamber drain open.

Replication 1					
Time (min)	Sample port	Conductivity (ms/cm)	Total dissolved solids (g/L)	Salinity	Temp (°C)
0.0	-	44.2	29.4	27.8	19.5
30.0	1	3.1	2.1		21.8
30.0	2	1.3	0.9		22.4
30.0	3	1.3	0.9		22.8
30.0	4	1.3	0.9		23.0
30.0	5	1.3	0.8		23.2
30.0	6	1.2	0.8		23.2
30.0	7	8.5	5.7		23.1
Replication 2					
Time (min)	Sample port	Conductivity (ms/cm)	Total dissolved solids (g/L)	Salinity	Temp (°C)
0.0	-	44.2	29.4	27.9	20.0
30.0	1	2.2	1.6		20.3
30.0	2	1.1	0.8		20.5
30.0	3	1.1	0.7		20.7
30.0	4	1.1	0.7		20.8
30.0	5	1.1	0.7		20.9
30.0	6	1.0	0.7		20.9
30.0	7	8.8	5.9		20.8
Replication 3					
Time (min)	Sample port	Conductivity (ms/cm)	Total dissolved solids (g/L)	Salinity	Temp (°C)
0.0	-	44.2	29.4	27.9	20.0
30.0	1	2.9	2.0		20.7
30.0	2	1.2	0.8		21.1
30.0	3	1.1	0.7		21.5
30.0	4	1.1	0.7		21.7
30.0	5	1.1	0.7		21.9
30.0	6	1.1	0.7		22.1
30.0	7	8.9	5.9		22.1

Table B-35. Three collected data sets for Diverter E at 75.71 L/min flow rate with the diverter chamber drain open.

Replication 1					
Time (min)	Sample port	Conductivity (ms/cm)	Total dissolved solids (g/L)	Salinity	Temp (°C)
0.0	-	44.0	29.3	27.8	20.4
30.0	1	1.3	0.9		23.1
30.0	2	1.2	0.8		23.1
30.0	3	1.2	0.8		23.2
30.0	4	1.2	0.8		23.3
30.0	5	1.2	0.8		23.2
30.0	6	1.1	0.7		23.1
30.0	7	9.1	6.1	5.0	23.0
Replication 2					
Time (min)	Sample port	Conductivity (ms/cm)	Total dissolved solids (g/L)	Salinity	Temp (°C)
0.0	-	43.3	29.5	28.0	22.2
30.0	1	1.1	0.8		23.1
30.0	2	1.1	0.7		23.1
30.0	3	1.2	0.8		23.2
30.0	4	1.0	0.7		23.2
30.0	5	1.0	0.7		23.2
30.0	6	1.0	0.7		23.2
30.0	7	9.4	6.3	5.2	23.2
Replication 3					
Time (min)	Sample port	Conductivity (ms/cm)	Total dissolved solids (g/L)	Salinity	Temp (°C)
0.0	-	44.3	29.5	28.1	21.9
30.0	1	1.2	0.8		23.1
30.0	2	1.0	0.7		23.2
30.0	3	1.0	0.7		23.3
30.0	4	1.0	0.7		23.3
30.0	5	1.0	0.7		23.4
30.0	6	1.0	0.7		23.5
30.0	7	9.0	6.0		23.4

Table B-36. Three collected data sets for Diverter F at 75.71 L/min flow rate with the diverter chamber drain open.

Replication 1					
Time (min)	Sample port	Conductivity (ms/cm)	Total dissolved solids (g/L)	Salinity	Temp (°C)
0.0	-	43.8	29.1	27.8	22.0
30.0	1	1.7	1.1		22.4
30.0	2	1.0	0.6		22.5
30.0	3	0.9	0.6		22.5
30.0	4	1.0	0.6		22.7
30.0	5	1.0	0.7		22.9
30.0	6	1.0	0.7		22.9
30.0	7	7.0	4.7		23.0
Replication 2					
Time (min)	Sample port	Conductivity (ms/cm)	Total dissolved solids (g/L)	Salinity	Temp (°C)
0.0	-	43.8	29.1	27.8	22.0
30.0	1	1.9	1.3		22.2
30.0	2	1.0	0.7		22.4
30.0	3	1.0	0.7		22.5
30.0	4	0.9	0.6		22.4
30.0	5	1.0	0.7		22.3
30.0	6	1.0	0.6		22.5
30.0	7	7.3	4.9		22.9
Replication 3					
Time (min)	Sample port	Conductivity (ms/cm)	Total dissolved solids (g/L)	Salinity	Temp (°C)
0.0	-	43.8	29.1	27.8	22.0
30.0	1	1.7	1.2		22.9
30.0	2	0.9	0.6		22.8
30.0	3	0.9	0.6		22.8
30.0	4	1.0	0.7		22.6
30.0	5	1.1	0.7		22.6
30.0	6	1.1	0.7		22.5
30.0	7	7.2	4.8		22.6

Table B-37. Three collected data sets for Diverter A at 113.56 L/min flow rate with the diverter chamber drain open.

Replication 1					
Time (min)	Sample port	Conductivity (ms/cm)	Total dissolved solids (g/L)	Salinity	Temp (°C)
0.0	-	44.3	29.5	28.0	22.2
30.0	1	2.1	1.4		22.4
30.0	2	1.4	0.9		22.8
30.0	3	1.3	0.8		23.0
30.0	4	1.5	1.0		23.4
30.0	5	1.6	1.0		23.6
30.0	6	1.6	1.1		23.8
30.0	7	40.2	27.0	25.6	23.5
Replication 2					
Time (min)	Sample port	Conductivity (ms/cm)	Total dissolved solids (g/L)	Salinity	Temp (°C)
0.0	-	44.0	29.3	27.6	17.7
30.0	1	2.5	1.6		18.4
30.0	2	1.2	0.8		19.2
30.0	3	1.2	0.8		19.6
30.0	4	1.2	0.8		20.0
30.0	5	1.2	0.9		20.2
30.0	6	1.4	0.9		20.3
30.0	7	39.1	26.3	24.6	19.9
Replication 3					
Time (min)	Sample port	Conductivity (ms/cm)	Total dissolved solids (g/L)	Salinity	Temp (°C)
0.0	-	44.1	29.3	27.6	17.9
30.0	1	3.0	1.7		19.3
30.0	2	1.3	0.8		20.2
30.0	3	1.2	0.8		20.9
30.0	4	1.3	0.9		21.4
30.0	5	1.3	0.8		21.7
30.0	6	1.5	1.0		21.9
30.0	7	39.5	26.5	24.9	21.5

Table B-38. Three collected data sets for Diverter B at 113.56 L/min flow rate with the diverter chamber drain open.

Replication 1					
Time (min)	Sample port	Conductivity (ms/cm)	Total dissolved solids (g/L)	Salinity	Temp (°C)
0.0	-	44.3	29.5	28.0	22.2
30.0	1	2.2	1.5		19.3
30.0	2	1.5	1.0		20.0
30.0	3	1.4	0.9		20.8
30.0	4	1.5	1.0		21.5
30.0	5	1.5	1.0		22.1
30.0	6	40.3	26.9	25.4	22.2
30.0	7	42.6	28.5	27.0	22.1
Replication 2					
Time (min)	Sample port	Conductivity (ms/cm)	Total dissolved solids (g/L)	Salinity	Temp (°C)
0.0	-	44.0	29.3	27.6	17.7
30.0	1	2.5	1.7		18.3
30.0	2	1.2	0.8		19.2
30.0	3	1.1	0.8		20.1
30.0	4	1.2	0.8		20.6
30.0	5	1.4	0.9		20.8
30.0	6	40.1	26.7	24.9	20.5
30.0	7	40.9	27.4	25.8	19.2
Replication 3					
Time (min)	Sample port	Conductivity (ms/cm)	Total dissolved solids (g/L)	Salinity	Temp (°C)
0.0	-	44.1	29.3	27.6	17.9
30.0	1	2.1	1.4		17.1
30.0	2	1.2	0.8		18.3
30.0	3	1.4	0.9		19.5
30.0	4	1.2	0.8		20.6
30.0	5	1.5	1.0		21.1
30.0	6	39.0	26.0	24.4	21.0
30.0	7	41.3	27.5	25.8	20.3

Table B-39. Three collected data sets for Diverter C at 113.56 L/min flow rate with the diverter chamber drain open.

Replication 1					
Time (min)	Sample port	Conductivity (ms/cm)	Total dissolved solids (g/L)	Salinity	Temp (°C)
0.0	-	44.2	29.5	28.0	23.2
30.0	1	2.2	1.5		23.3
30.0	2	1.2	0.8		23.5
30.0	3	1.2	0.8		23.7
30.0	4	1.2	0.8		24.0
30.0	5	1.2	0.8		24.7
30.0	6	1.2	0.8		24.7
30.0	7	10.0	6.7	5.6	24.6
Replication 2					
Time (min)	Sample port	Conductivity (ms/cm)	Total dissolved solids (g/L)	Salinity	Temp (°C)
0.0	-	44.0	29.3	27.9	23.2
30.0	1	1.7	1.1		22.8
30.0	2	1.2	0.8		23.1
30.0	3	1.0	0.7		23.5
30.0	4	1.1	0.7		23.8
30.0	5	1.0	0.7		24.0
30.0	6	1.0	0.7		24.2
30.0	7	9.7	6.5	5.4	24.4
Replication 3					
Time (min)	Sample port	Conductivity (ms/cm)	Total dissolved solids (g/L)	Salinity	Temp (°C)
0.0	-	44.2	29.4	28.0	23.1
30.0	1	1.6	1.1		23.1
30.0	2	1.1	0.7		23.3
30.0	3	1.0	0.7		23.5
30.0	4	1.0	0.7		23.8
30.0	5	1.0	0.7		24.0
30.0	6	1.0	0.7		24.1
30.0	7	9.3	6.2	5.1	24.3

Table B-40. Three collected data sets for Diverter D at 113.56 L/min flow rate with the diverter chamber drain open.

Replication 1					
Time (min)	Sample port	Conductivity (ms/cm)	Total dissolved solids (g/L)	Salinity	Temp (°C)
0.0	-	44.2	29.4	28.0	23.2
30.0	1	1.3	0.8		22.3
30.0	2	1.0	0.7		22.6
30.0	3	1.0	0.7		22.7
30.0	4	1.0	0.7		23.0
30.0	5	1.0	0.7		23.0
30.0	6	1.0	0.7		23.1
30.0	7	9.0	6.0	5.1	23.0
Replication 2					
Time (min)	Sample port	Conductivity (ms/cm)	Total dissolved solids (g/L)	Salinity	Temp (°C)
0.0	-	44.3	29.5	28.1	22.2
30.0	1	1.2	0.8		22.4
30.0	2	1.8	1.2		22.6
30.0	3	1.1	0.7		22.5
30.0	4	1.2	0.8		22.6
30.0	5	1.2	0.8		22.7
30.0	6	1.3	0.8		22.8
30.0	7	9.2	6.1	5.2	22.4
Replication 3					
Time (min)	Sample port	Conductivity (ms/cm)	Total dissolved solids (g/L)	Salinity	Temp (°C)
0.0	-	44.2	29.4	28.0	22.3
30.0	1	3.1	2.0		22.6
30.0	2	1.1	0.8		22.4
30.0	3	1.1	0.7		22.4
30.0	4	1.1	0.7		21.9
30.0	5	1.0	0.7		21.9
30.0	6	1.0	0.7		22.0
30.0	7	8.8	5.9		21.8

Table B-41. Three collected data sets for Diverter E at 113.56 L/min flow rate with the diverter chamber drain open.

Replication 1					
Time (min)	Sample port	Conductivity (ms/cm)	Total dissolved solids (g/L)	Salinity	Temp (°C)
0.0	-	44.2	29.5	28.0	23.2
30.0	1	1.8	1.2		23.2
30.0	2	1.0	0.7		23.4
30.0	3	1.2	0.8		23.7
30.0	4	1.2	0.8		24.0
30.0	5	1.2	0.8		24.2
30.0	6	1.3	0.8		24.4
30.0	7	9.2	6.2	5.2	24.5
Replication 2					
Time (min)	Sample port	Conductivity (ms/cm)	Total dissolved solids (g/L)	Salinity	Temp (°C)
0.0	-	44.0	29.3	27.9	23.2
30.0	1	2.3	1.6		23.4
30.0	2	1.0	0.7		23.7
30.0	3	1.0	0.7		24.0
30.0	4	1.0	0.7		24.1
30.0	5	1.1	0.7		24.3
30.0	6	1.1	0.7		24.3
30.0	7	9.1	6.1	5.0	24.6
Replication 3					
Time (min)	Sample port	Conductivity (ms/cm)	Total dissolved solids (g/L)	Salinity	Temp (°C)
0.0	-	44.2	29.4	28.0	23.1
30.0	1	1.2	0.8		23.9
30.0	2	1.0	0.7		24.0
30.0	3	1.0	0.7		24.2
30.0	4	1.0	0.7		24.3
30.0	5	1.0	0.7		24.4
30.0	6	1.0	0.7		24.5
30.0	7	8.9	5.9		24.6

Table B-42. Three collected data sets for Diverter F at 113.56 L/min flow rate with the diverter chamber drain open.

Replication 1					
Time (min)	Sample port	Conductivity (ms/cm)	Total dissolved solids (g/L)	Salinity	Temp (°C)
0.0	-	44.1	29.3	27.8	22.5
30.0	1	1.1	0.7		23.6
30.0	2	1.0	0.7		23.9
30.0	3	1.0	0.7		24.1
30.0	4	1.0	0.7		23.9
30.0	5	1.0	0.7		23.9
30.0	6	1.0	0.7		24.0
30.0	7	9.5	6.3	5.2	23.4
Replication 2					
Time (min)	Sample port	Conductivity (ms/cm)	Total dissolved solids (g/L)	Salinity	Temp (°C)
0.0	-	44.1	29.3	27.8	22.6
30.0	1	1.1	0.7		23.7
30.0	2	1.6	1.1		23.8
30.0	3	1.2	0.8		24.0
30.0	4	1.0	0.7		24.0
30.0	5	1.1	0.7		23.9
30.0	6	1.0	0.7		24.0
30.0	7	9.5	6.3	5.2	23.7
Replication 3					
Time (min)	Sample port	Conductivity (ms/cm)	Total dissolved solids (g/L)	Salinity	Temp (°C)
0.0	-	44.1	29.3	27.8	22.5
30.0	1	1.0	0.7		23.8
30.0	2	1.0	0.7		24.0
30.0	3	0.9	0.6		24.0
30.0	4	0.9	0.6		24.1
30.0	5	1.0	0.6		24.2
30.0	6	1.0	0.6		24.0
30.0	7	6.7	5.8		23.9

VITA

- Name: Justin Keith Mechell
- Address: Dept. of Biological and Agricultural Engineering
MS 2117 TAMU
College Station, TX, 77843
- Email Address: jkmechell@ag.tamu.edu
- Education: B.S., Agricultural Engineering, Texas A&M University, 2006
M.S., Agricultural Engineering, Texas A&M University, 2009
- Experience: Texas AgriLife Extension Service May 2006-Present
Extension Assistant
- Develop engineering approaches to addressing water quantity and quality issues associated with the management of water and infrastructure. Develop and calculate example system design guidance documents.
 - Manage various projects and tasks related to agricultural occupational safety, water quality and quantity, organic and commercial nutrient management, small scale solar distillation, low pressure drip irrigation and rainwater harvesting.
 - Evaluate various innovative and alternative wastewater treatment systems through literature review and demonstration in the field.
 - Develop and deliver educational material addressing abandoned water well closure, stormwater management, rainwater harvesting, agricultural safety, proper use of organic fertilizers and implementation of watershed management plans. Program delivery includes conducting presentations at local county meetings, field days, and regional, state, and national conferences.
 - Perform activities related to literature searches and development of equipment drawings for use in printed materials and prepare written reports.
 - Design and conduct research on issues related to low pressure drip irrigation, small scale solar distillation units, and rainwater harvesting first flush devices.
- KP Engineering Ect., August 2005-February 2006
Contract Laborer
- Developed training materials for the Texas Engineering Extension Service 4-day training course on Onsite Sewage Facilities.
 - Developed a course manual, PowerPoint presentations, and exercises related to onsite wastewater technologies and regulations.