

EM-103  
2008

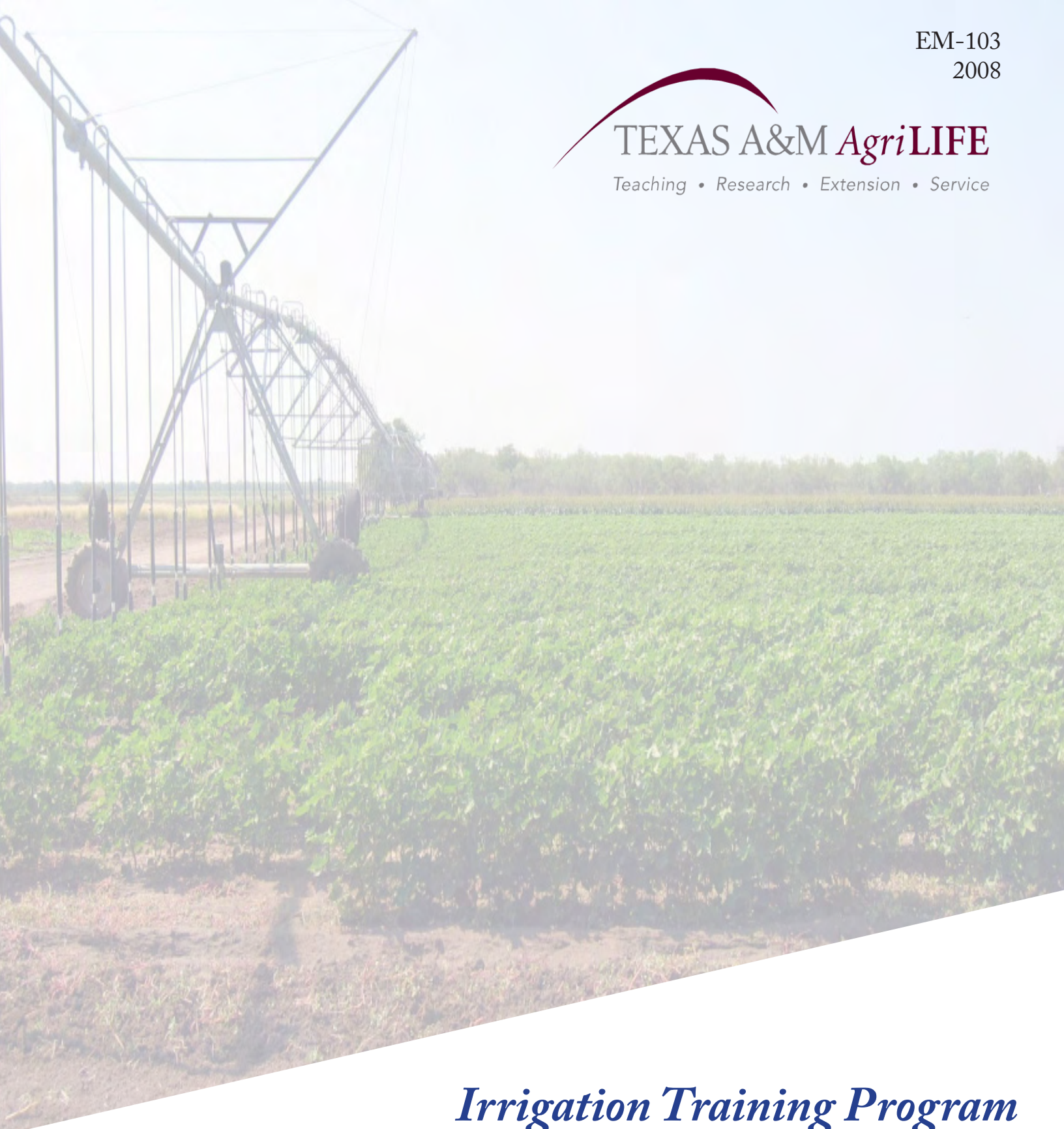

# *Irrigation Training Program*

## **South Texas Edition**



# Acknowledgments

## Funding

This program is made possible by funding from the Texas Water Development Board.

## Program Leadership

The Irrigation Training Program is a collaborative effort between the Texas Water Resources Institute, a unit of Texas A&M AgriLife; the Texas State Soil and Water Conservation Board; and the United States Department of Agriculture Natural Resources Conservation Service. Special appreciation is expressed to the individual authors and technical advisors who have contributed to the information and publications contained in this manual; the agencies, irrigation districts, groundwater conservation districts, Texas Agricultural Irrigation Association and members of other associations who have contributed time and leadership in the delivery of irrigation training programs; and to the site coordinators and those who have shared their expertise as speakers at individual programs throughout the state.

## Lead Editor

Dana Porter

## Contributing Authors

*This manual was adapted from publications written by the following*

Archie Abrameit	Frank Dainello	Gale Norman
Mahbub Alam	Steven Davis	Carl Patrick
Lal Almas	Peter Dotray	Xavier Peries
Steve Amosson	Juan Enciso	Giovanni Piccinni
David Bade	Guy Fipps	Dana Porter
Todd Baughman	James Grichar	Patrick Porter
Paul Baumann	Aung Hla	Danny Rogers
Brent Bean	Terry Howell	Scott Russell
Mark Black	Thomas Isikiet	Christopher Sansone
Randy Boman	John Jackman	Steve Santistevan
Jim Bordvosky	Freddie Lamm	Greta Schuster
Fran Bretz	Thomas Lee	William Sothers
Josh Bynum	Robert Lemon	Douglass Stevenson
Edsel Bynum	Steve Livingston	Charles Stichler
Paul Calaizzo	Thomas Marek	Charles Swanson
Tom Cothren	Mark McFarland	Calvin Trostle
Gregory Cronholm	Travis Miller	Noel Troxclair
Clyde Crumley	Leon New	Billy Warrick

Published by the Texas Water Resources Institute. College Station, TX

October 2008

EM-103

*Mention of specific products, manufacturers, brand names, etc. may be included for informational purposes and are not intended as endorsements.*

*Programs of the Texas AgriLife Extension Service, Texas AgriLife Research and the Texas State Soil and Water Conservation Board are open to all people without regard to race, color, sex, disability, religion, age, national origin or veteran status.*



# Table of Contents

<b>Topic</b>	<b>Page</b>
<b>Economics</b>	
Overview .....	7
Assess your knowledge .....	8
Economics of Irrigation Systems .....	9
Economics of Irrigation Pumping Costs .....	10
Reference: Economics of Irrigation Systems (B-6113).....	11
Reference: Calculating Horsepower Requirements and Sizing Irrigation Pipelines (B-6011) .....	12
<b>Irrigation Scheduling</b>	
<b>Evapotranspiration (ET)</b>	
Overview .....	13
Assess your knowledge .....	14
What is Evapotranspiration? .....	15
What is Reference ET? .....	15
Calculating Crop ET .....	15
Using ET to schedule irrigation .....	16
Additional ET Information .....	16
Reference: The TexasET Network and Website User's Manual .....	17
Reference: Decision Support Systems: Tools for Implementing Best Management Practices in Texas (EM-100) .....	18
<b>Soil Moisture Management &amp; Monitoring</b>	
Overview .....	19
Assess your knowledge .....	20
Soil Moisture Storage Capacity .....	21
Figure: Available Water Storage by Type.....	21
Table: How soil feels and looks at various soil moisture levels .....	22
Table: Root zone depths reported for various crops.....	23
Using Soil Moisture to Improve Irrigation Efficiency .....	23
Soil Water Measurement.....	24
Reference: Soil Moisture Management (B-1670) .....	25
Reference: Irrigation Monitoring with Soil Water Sensors (B-6194) .....	26
Reference: Estimating Soil Moisture by Feel and Appearance (1619) .....	27



# Table of Contents

<b>Topic</b>	<b>Page</b>
<b>Irrigation Technologies and Best Management Practices</b>	
<b>Surface Irrigation</b>	
Overview .....	28
Assess your knowledge .....	29
Surface Methods .....	30
Selection and Applications .....	30
Distribution and Delivery Systems .....	31
Surface Method Best Management Practices .....	32
Reference: Using Flexible Pipe with Surface Irrigation (L 5469) .....	33
Reference: Managing Furrow Irrigation Systems (L-913) .....	34
<b>Center Pivot Irrigation</b>	
Overview .....	35
Assess your knowledge .....	36
Center Pivot Technologies .....	37
Suggestions for Realizing the Benefits of Advanced Irrigation Technology.....	39
Irrigation Management.....	39
Reference: Center Pivot Workbook (B-6162) .....	40
Reference: Utilizing Center Pivot Sprinkler Irrigation Systems to Maximize Water Savings.....	41
<b>Microirrigation</b>	
Overview .....	43
Assess your knowledge .....	44
Key Components.....	45
Maintenance Considerations .....	46
Advantages and Limitations of Microirrigation.....	47
Reference: Basics of Microirrigation (B-6160) .....	48
Reference: Installing a Subsurface Drip System for Row Crops (B-6151).....	49
Reference: Maintaining Subsurface Drip Irrigation Systems (L-5406).....	50
Reference: Subsurface Drip Irrigation (SDI) Components: Minimum Requirements (MF-2576).....	51
Reference: Subsurface Irrigation Systems Water Quality Assessment Guidelines (MF-2575).....	52
Reference: Irrigation System, Microirrigation (441-1) .....	53
Reference: Subsurface Drip Irrigation Information on the Internet.....	54
<b>Conservation Tillage</b>	
Overview .....	55
Assess your knowledge .....	56
Fundamental Best Management Practices for Successful Conservation Tillage .....	57
Reference: Best Management Practices for Conservation/Reduced Tillage (B-6189) .....	60



# Table of Contents

<b>Topic</b>	<b>Page</b>
<b>Water Quality Issues</b>	
<b>Salinity Management</b>	
Overview .....	61
Assess your knowledge .....	62
What is Salinity .....	63
Table: Units commonly used to express salinity .....	64
Why is Salinity a Problem.....	65
How do You Know if You Have a Salinity Problem.....	65
Table: Tolerance of selected crops to salinity in irrigation water and soil .....	65
Managing Irrigation to Mitigate Salinity.....	66
Reference: Irrigation Water Quality Critical Salt Levels for Peanuts, Cotton, Corn and Grain Sorghum (L-5417).....	69
Reference: Irrigation Water Quality Standards and Salinity Management Strategies (B-1667).....	70
Reference: Irrigation Salinity Management Information on the Internet.....	71
<b>Protecting Water Resources from Contamination</b>	
Overview .....	72
Assess your knowledge .....	73
Best Management Practices to Prevent Pesticide Contamination of Water Resources .....	74
Pesticide Properties that affect Risk of Contamination.....	74
Local conditions that affect Risk of Contamination .....	74
Pesticides in the Environment.....	75
Best Management Practices.....	75
Additional Best Management Practices .....	76
Reference: Pesticide Properties That Affect Water Quality (B-6050).....	77
Reference: Chemigation Equipment and Safety (L-2422) .....	78
Reference: Reducing Herbicides in Surface Water Best Management Practices (L-5205).....	79
Reference: Chemigation and Water Quality Protection Information on the Internet .....	80
<b>Crop-Specific Guidelines</b>	
<b>Corn Production</b>	
Overview .....	81
Assess your knowledge .....	82
Corn Water Demand and Irrigation Management .....	83
Figure: Approximate Corn Water Demand (inches per day).....	84
Reference: Predicting the Final Irrigation for Corn, Sorghum and Soybeans (MF-2174) .....	85



# Table of Contents

<b>Topic</b>	<b>Page</b>
<b>Cotton Production</b>	
Overview .....	86
Assess your knowledge .....	87
Pre-Plant, Planting and Stand Establishment .....	88
Emergence to First Bloom .....	88
First Bloom to First Open Boll .....	88
First Open Boll to Harvest.....	89
Figure: Seasonal Water Demand Curve for Cotton .....	89
Reference: An Excerpt from Texas Cotton Production Emphasizing Integrated Pest Management .....	90
Reference: Late Season Issues in 2006 .....	91
<b>Sorghum Production</b>	
Overview .....	92
Assess your knowledge .....	93
Common Mistakes affecting Sorghum Water Use .....	94
Figure: Estimated Daily Water Use for Grain Sorghum.....	95
Reference: Irrigating Sorghum in South and South Central Texas (L-5434) .....	96
<b>Forage Production</b>	
Overview .....	97
Assess your knowledge .....	98
Reference: Irrigation of Forage Crops (B-6150) .....	99
Reference: Forage Bermuda Grass: Selection, Establishment and Management (E-179).....	100
Reference: Managing Annual Winter Grass in South and Southwest Texas (L-5238) .....	101
<b>Wheat Production</b>	
Reference: Late Season Wheat Irrigation for the Texas South Plains .....	103
Reference: Growth Stages of Wheat: Identification and Understanding Improve Crop Management (SCS-1999-16).....	104
<b>Vegetable Production</b>	
Reference: Optimum Irrigation for Black-Eyed Peas in West Texas .....	106
Reference: Estimated Water Requirements for Vegetable Crops .....	107
Reference: Irrigation. An excerpt from TCE Vegetable Handbook .....	108
<b>Citrus Production</b>	
Reference: Impacts of Irrigation on Citrus (B-6205).....	110
<b>Sugarcane Production</b>	
Reference: Irrigation of Sugarcane (B-6156) .....	112



# Table of Contents

<b>Topic</b>	<b>Page</b>
<b>Additional Information/Resources</b>	
Reference: Agricultural Water Conservation Practices .....	114
Reference: Propeller Flow Meters (L-5492) .....	115
Reference: Irrigation Formulas and Conversions .....	116
Reference: Irrigation Information Resources Available on the Internet .....	117
Reference: Publications Referenced in the Irrigation Training Program Manual .....	118



## **Economic Issues in Irrigation**





# *Economic Issues in Irrigation*

## **In this Section**

Overview: Economic Issues in Irrigation

Reference: Economics of Irrigation Systems (B-6113)

Reference: Calculating Horsepower Requirements and Sizing Irrigation Pipelines (B-6011)

## **Overview**

Economic issues in irrigation reflect complex and highly dynamic factors. Energy costs, commodity markets, weather patterns and other issues are difficult to predict and impossible to control. Irrigation is as much a risk management tool as an expensive input. Equipment selection, irrigation management, and other decisions need to be made with economics in mind.

### **Objectives:**

- Increase understanding of factors that affect economics of irrigation systems.
- Increase understanding of costs and associated benefits of commonly used irrigation systems.
- Increase understanding of methods for evaluating and comparing irrigation systems.

### **Key Points:**

1. When considering investing in an irrigation system, several major factors should be noted: the availability of water; the system's application efficiency; the depth from which the water must be pumped, or pumping lifts; the operating pressure of the design; financing; savings in field operations; energy sources; energy prices; crop mix; economies of scale; labor availability; and commodity prices.
2. Overlaying these factors are the differences in the cost and water application efficiencies of the various irrigation systems.
3. Compared to furrow irrigation, center pivots offer more than enough benefits in application efficiency and reduction in field operations to offset the additional costs. Among the three center pivot alternatives, LEPA center pivot generates the highest benefits at low, intermediate and high water requirement scenarios.
4. The less efficient the irrigation system, the more effect that fuel price, pumping lift and wage rate have on the cost of producing an irrigated crop. Therefore, when there is inflation or volatility of these cost factors, it is more feasible to adopt more efficient irrigation systems and technology.



## *Economic Issues in Irrigation*

### **Assess your knowledge:**

1. How do application efficiency and operating pressure vary among different irrigation systems?
2. Explain how to estimate annual operating expenses for an irrigation system.
3. How do fuel prices, pumping life, inches of water pumped and labor wage rate affect the pumping cost?



# *Economic Issues in Irrigation*

## **Economics of Irrigation Systems**

Investing in a new irrigation system is expensive and complex, with many factors needing to be evaluated, including water availability, pumping lift, labor cost, fuel cost, tax rate, soil type, field topography, etc. Overlaying these factors are the differences in the cost and water application efficiencies of the various irrigation systems. These factors make it difficult to make a wise investment decision.

To help farmers weigh these factors and make these decisions, researchers studied the costs and associated benefits of six commonly used irrigation systems in Texas: conventional furrow, surge flow, mid-elevation spray application center pivot, low elevation spray application center pivot, low energy precision application center pivot, and subsurface drip. The study found that:

- Furrow irrigation requires less capital investment but has lower water application efficiency and is more labor intensive than the other irrigation systems.
- Adding surge flow valves increases water application efficiency enough to increase returns per acre. However, before purchasing surge equipment, growers should closely evaluate the ability to provide the required constant management of irrigation scheduling with surge flow systems.
- Compared to furrow irrigation, center pivots offer more than enough benefits in application efficiency and reduction in field operations to offset the additional costs.
- Where it is feasible to use, half-mile center pivot offers substantial savings compared to quarter-mile.
- Among the three center pivot alternatives, low energy precision application (LEPA) center pivot generates the highest benefits at low, intermediate and high water requirement scenarios.
- Advanced irrigation technologies are best suited to crops with high water needs, particularly in areas with deep pumping lifts. Producers using advanced systems will have not only lower pumping costs, but also potential savings from chemigation and the need for fewer field operations.
- Compared to LEPA center pivot, subsurface drip irrigation (SDI) generally is not economically feasible for any crop water-use scenario because of its relatively high investment and small gain in application efficiency. SDI shows greater potential in situations less suited to center pivot irrigation; these may include low water capacities, small or irregularly shaped fields, etc.
- Producers should closely evaluate using SDI systems for high-value crops. Research suggests that SDI systems may improve the application efficiency and the timing of frequent applications. These improvements may increase acreage and yields enough to justify the additional investment costs of subsurface drip systems.



# *Economic Issues in Irrigation*

## **Economics of Irrigation Pumping Costs**

Researchers also studied the effect on pumping cost of variations in fuel prices, pumping lift, amount of water pumped and labor wage rate. Results indicated that:

- The less efficient the irrigation system, the more effect that fuel price, pumping lift and wage rate have on the cost of producing an irrigated crop. Therefore, when there is inflation or volatility of these cost factors, it is more feasible to adopt more efficient irrigation systems and technology.
- As more water is pumped, the fixed cost per acre-inch drops.



# Economics of Irrigation Systems (B-6113)



# Economics of Irrigation Systems



Front cover insets: (top, from left) conventional furrow irrigation on corn; surge flow valve, solar powered; (middle) low energy precision application (LEPA) center pivot; (bottom, from left) conventional furrow, polypipe, on cotton; and low elevation spray application (LESA) on peanuts. Background photo: mid-elevation spray application (MESA) center pivot, single head.

Opposite page: Subsurface drip irrigation system diagram.

Back cover inset: Low energy precision application (LEPA) center pivot on peanut.

# Economics of Irrigation Systems

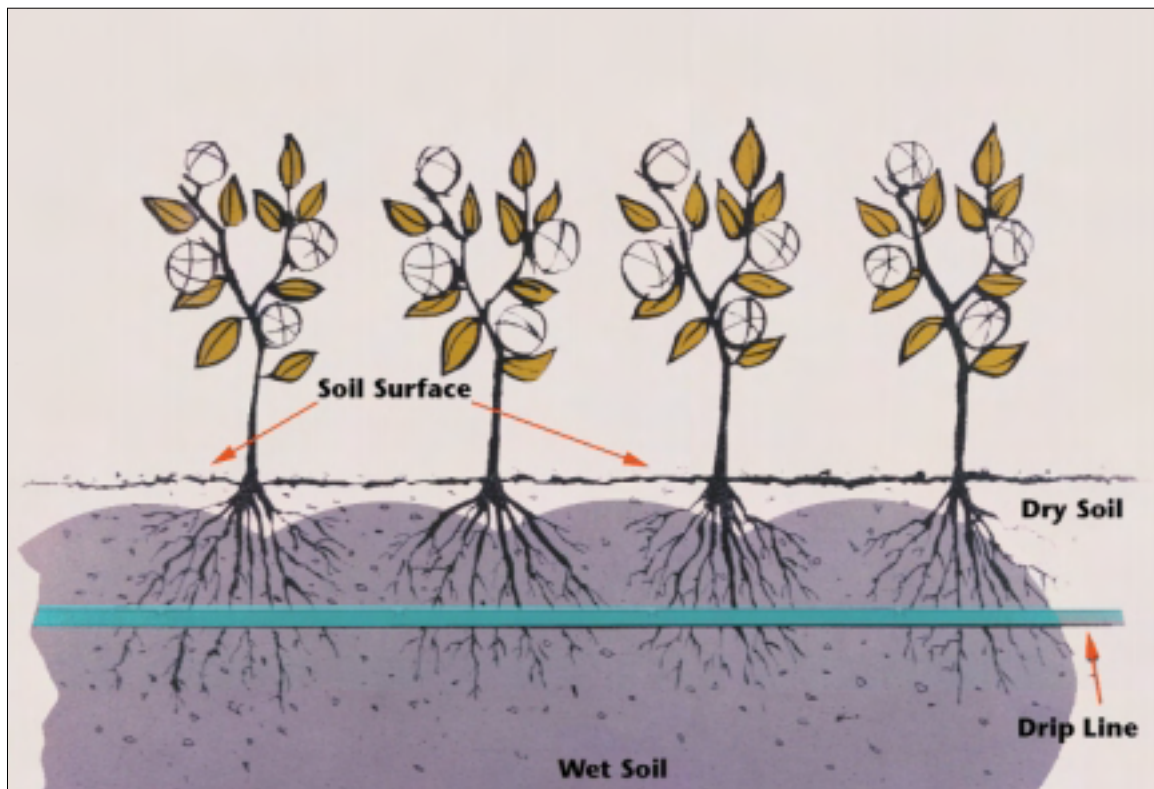



# Contents

Introduction .....	1
Application efficiency .....	1
Operating pressure .....	1
Irrigation Systems .....	1
Conventional furrow (CF) .....	2
Surge flow furrow (SF) .....	2
Mid-elevation spray application (MESA) center pivot .....	3
Low elevation spray application (LESA) center pivot .....	3
Low energy precision application (LEPA) center pivot .....	4
Subsurface drip irrigation (SDI) .....	4
Evaluating irrigation systems .....	4
Investment cost of irrigation systems .....	5
Estimated Annual Operating Expenses .....	5
Assumptions and crop scenarios .....	6
Fixed operating costs .....	6
Variable pumping costs .....	6
Total pumping costs .....	7
Savings from field operations and total annual irrigation .....	7
Cost/Benefit Analysis .....	7
Sensitivity Analysis .....	8
Impact of fuel prices on pumping cost .....	8
Effect of lift on pumping cost .....	8
Amount of water pumped affects fixed pumping costs .....	9
Effect of wage rate on pumping costs .....	10
Additional benefits from fertigation and chemigation .....	10
Study limitations .....	10
Summary .....	11
Appendix .....	12

# Economics of Irrigation Systems

Steve Amosson, Leon New, Lal Almas, Fran Bretz, and Thomas Marek\*

## Introduction

Irrigation can improve crop production, reduce yield variability and increase profits. But choosing and buying an irrigation system are both expensive and complex.

When considering investing in an irrigation system, farmers must keep in mind several major factors: the availability of water; the system's application efficiency; the depth from which the water must be pumped, or pumping lifts; the operating pressure of the design; financing; savings in field operations; energy sources; energy prices; crop mix; economies of scale; labor availability; and commodity prices.

To help producers make decisions about irrigation systems, Texas A&M University System researchers studied the costs and benefits of six types of irrigation systems commonly used in Texas: conventional furrow irrigation (CF); surge flow furrow (SF); mid-elevation spray application (MESA) center pivot; low elevation spray application (LESA) center pivot; low energy precision application (LEPA) center pivot; and subsurface drip irrigation (SDI).

The study focused on:

- The approximate costs, both gross and net, of buying and operating each system.
- Each system's potential benefits for improving water application efficiency and reducing field operations.
- The effect of economies of size of center pivots.
- The potential use of chemigation.
- The impact of other major factors such as fuel prices, pumping lift and labor costs.

The costs of buying and operating an irrigation system may vary among farms because of differences in individual farming/ranching operations. Before changing management strategies, farmers should compare their operations to those in the study.

For the study, it was assumed that each irrigation system was installed on a "square" quarter section of land (160 acres). The terrain and soil type were assumed not to affect the feasibility of the irrigation system.

## Application efficiency

Not all of the water irrigated is used by the crop. The percentage of irrigation water used by a crop is called the system application efficiency. To determine the amount of water required to irrigate crops using the different systems, farmers must know and be able to compare the application efficiency of each system.

Application efficiency can vary among systems because of:

- The differences in design, maintenance and management of the systems.
- Environmental factors such as soil type, stage of crop development, time of year and climatic conditions.
- The availability of water and its potential value for other uses.
- Economic factors such as commodity and fuel prices.

For the six systems studied, the application efficiency ranged from 60 to 97 percent. Those with the highest application efficiencies tend to have the lowest pumping costs. Of the six irrigation systems, the least efficient was the conventional furrow system; the most efficient was the subsurface drip irrigation system.

An efficiency index was calculated to show the amount of water (in acre-inches) that each system would have to apply to be as effective as the LESA system (Table 1).

The calculations were made using the LESA center pivot as a base. It was assumed that applying the same amount of "effective" water would produce the same crop yield.

Therefore, according to the index, a subsurface drip system would need only 91 percent of the water used by the LESA system to be just as effective. The conventional furrow system would require 47 percent more water than the LESA system to be equally effective.

When evaluating the additional costs of the more efficient systems, farmers can take into consideration the reduced irrigation that will be needed for each system.

## Operating pressure

A system's operating pressure affects the cost of pumping water. Higher pressure makes irrigation more expensive. Of the six systems studied:

- Furrow and surge flow systems usually had operating pressures of about 10 pounds per square inch (psi).
- LESA, LEPA and SDI usually had an intermediate operating pressure of 15 psi, depending on the flow rate.
- MESA center pivot systems required higher pressure, about 25 psi.

Table 1 lists the operating pressures that were used to compare the pumping cost for each system.

To function properly, each irrigation system must maintain adequate and consistent operating pressure. Water flow (measured in gallons per minute, or GPM) dictates the operating pressure that must be maintained for that system's design. As GPM declines, growers must close furrow gates, renozzle center pivots and reduce the number of emitter lines to make each system work properly.

## Irrigation Systems

The six irrigation systems studied had varying designs, costs, management requirements, advantages and disadvantages.

---

\* Professor and Extension Economist; Professor and Agricultural Engineer; Assistant Professor (Agricultural Business and Economics), West Texas A&M University; and Research Associate and Agricultural Engineer and Superintendent, Texas Agricultural Experiment Station; The Texas A&M University System.

Table 1. Basic assumptions for six irrigation distribution systems.

Irrigation System	Operating Pressure (psi)*	Application Efficiency (%)	Efficiency Index	Acres Irrigated
Conventional furrow (CF)	10	60	1.47	160
Surge flow furrow (SF)	10	75	1.17	160
Mid-elevation spray application (MESA)	25	78	1.13	125
Low elevation spray application (LESA)	15	88	1.00	125
Low energy precision application (LEPA)	15	95	0.93	125
Subsurface drip irrigation (SDI)	15	97	0.91	160

\*PSI = Pounds of pressure per square inch of water.

tages. Producers should evaluate these systems in light of the characteristics and requirements specific to their farming/ranching operations.

### Conventional furrow irrigation (CF)

Conventional furrow irrigation delivers water from an irrigation well via an underground supply pipeline, to which gated pipe is connected. The water flows by gravity on the surface through the furrows between crop rows (Figure 1).

The gated pipe must be moved manually from one irrigation



Figure 1. Conventional furrow irrigation on cotton.

set to the next one that accommodates the well GPM, usually every 12 hours. In this study, two irrigation sets of gated pipe were used to allow the water flow to be changed without interruption.

Polypipe can be used instead of aluminum or PVC gated pipe. Normally, polypipe is not moved. Appropriate lengths are cut, plugged and connected to under-

ground pipeline risers. Furrow gates are installed to deliver water between crop rows, the same as gated pipe (Figure 2). The limitation of polypipe is that it is much less durable and is usually replaced every 1 to 2 years.

With good planning, land preparation and management, CF irrigation can achieve 60 percent water application efficiency (Table 1). That is, 60 percent of the water irrigated is used by the crop. CF systems are best used in fine-textured soils that have low infiltration rates.

For highest crop production, water should be supplied simultaneously and uniformly to all plants in the field. To make the application more uniform, farmers can consider laser leveling fields, installing surge flow valves, adjusting gates and modifying the shape, spacing or length of the furrow.

CF irrigation usually requires additional tillage preparation and labor, especially if the terrain varies in elevation. Other disadvantages of furrow irrigation include:



Figure 2. Conventional furrow polypipe on cotton.

- It can cause some environmental problems, such as soil erosion, sediment transport, loss of crop nutrients, deep percolation of water and movement of dissolved chemicals into groundwater.
- Terrain variations can cause the water to be distributed unevenly, reducing crop growth and, consequently, lowering overall crop yield.

Furrow irrigation usually applies water at higher increments than do center pivot or subsurface drip systems.

- The risk of nitrate leaching increases.

To address these problems, farmers can take remedial measures such as laser leveling, filter strips, mechanical straw mulching, surge flow, reduced tillage, furrow design, and sediment ponds with tailwater pump back features.

### Surge flow furrow (SF)

Surge flow irrigation was developed to address some of the problems associated with furrow irrigation. The primary differ-



Figure 3. Surge flow furrow on wheat.

ence between conventional furrow and surge flow is the installation and function of a surge valve (Figure 3), which intermittently applies water to two areas of the field.

A surge valve can improve application efficiency by about 15 percent (Table 1). Research has shown that surge flow can reduce runoff and improve distribution efficiency. It applies

water more uniformly and therefore reduces the deep percolation losses associated with furrow irrigation.

Another advantage of SF irrigation, unrelated to the improvements in irrigation system performance, is that a surge valve can improve irrigation system management without a large increase in labor or capital.

There are no detailed, accurate guidelines for setting surge time (number of hours of irrigation) on a particular site. Surge time and the level of irrigation efficiency achieved are influenced by the site's soil type, field terrain and tillage preparation.

Three potential disadvantages are associated with surge flow:

- It may not always reduce the amount of time it takes water to move down the furrow.
- Net water application may be lowered because of the programmed surge time. Too little water may filter into the soil during an application to be adequate for the growing crop until the next allocation.
- It requires more management, including monitoring how long it takes water to advance down the field on each surge, in order to reduce potential water loss.

Farmers must monitor soil moisture more closely and schedule irrigation properly to make sure that enough—but not too much—water is applied.

Nonetheless, surge flow is an improved furrow irrigation system.

## Mid-elevation spray application (MESA) center pivot

Mid-elevation spray application center pivots have water sprayer heads positioned about midway between the mainline and ground level.

The quarter-mile system considered in this study consisted of 145 drops spaced 10 feet apart. Polydrops (or optional flexible drop hose) were attached to the mainline gooseneck or furrow arm and extended down to the water applicator (Figure 4).

In MESA systems, water is applied above the primary crop canopy, even on tall crops such as corn and sugarcane. Weights should be used in combination with flexible drop hoses to reduce water losses and improve distribution.

The nozzle pressure for MESA varies, depending on the type of water applicator and the pad arrangement selected. Although some applicators require an operating pressure of 20 to 30 psi, improved designs require only 6 to 10 psi for conventional 8- to 10-foot mainline outlet and drop spacing. The operating pressure can be lowered to 6 psi or less if the sprayer heads are positioned 60 to 80 inches apart.

Mid-elevation spray application is subject to water losses via the air and through evaporation from the crop canopy and soil surface. Research has shown that when using above-canopy irrigation for corn production, 10 to 12 percent of the water applied is lost from the foliage. Field comparisons show a total water loss (air, foliage and soil) of 20 to 25 percent from MESA center pivot irrigation systems where applicators are set above the crop canopy.

The study found that the water application efficiency averaged 78 percent for MESA center pivot systems (Table 1).

## Low elevation spray application (LESA) center pivot

With low elevation spray application center pivot systems, water applicators are positioned 12 to 18 inches above ground level or high enough to allow space for wheel tracking. Each applicator is attached to a flexible drop hose, which is connected to a gooseneck or furrow arm on the mainline.

Weights, positioned immediately upstream from the pressure regulator and/or the applicator, help stabilize the applicator in wind and allow it to work through plants in straight crop rows. It is best to maintain nozzle pressure as low as 6 psi with the correct water applicator.

The optimal spacing for LESA drops is no wider than 80 inches. If they are installed and managed properly, LESA drops can be spaced on conventional 8- to 10-foot MESA spacing successfully.

Corn should be planted in circle rows and water sprayed underneath the primary foliage. Some growers have used LESA successfully in straight corn rows at conventional outlet spacing by using a flat, coarse, grooved pad that allows water to spray horizontally.

Grain sorghum and soybeans can also be planted in straight rows. In wheat, the foliage may cause the water distribution to



Figure 4. MESA center pivot, half-mile system.

be significantly uneven. To improve the water distribution, you may need to temporarily swing the drop hose and thus the applicator over the truss rod (effectively raising the nozzle above or near the top of the canopy).

LESA center pivots wet less foliage, especially when the crop is planted in a circle. This lowers the amount of water lost to evaporation (Figure 5). The water application efficiency for LESAs usually averages 85 to 90 percent (Table 1), but may be less in open, lower profile crops such as cotton, peanuts or



Figure 5. LESAs center pivot on cotton.

broadcast crops such as wheat or alfalfa.

When drops are spaced no more than 80 inches apart, LESAs center pivots can easily be converted to LEPA with an applicator adapter that includes a connection to attach a drag sock or hose.

### Low energy precision application (LEPA) center pivot

Low energy precision application center pivot systems discharge water between alternate crop rows planted in a circle.



Figure 6. LEPA center pivot with drag sock.

Water is applied with either a bubble applicator 12 to 18 inches above ground level or drag socks or hoses that release water on the ground.

Drag socks help reduce furrow erosion; double-ended socks are designed to protect and maintain furrow dikes (Figure 6). When needed, drag socks and hose adapters can be easily

removed from the applicator and replaced with a spray or chemigation pad.

Another product, the LEPA “quad” applicator, delivers a bubble water pattern (Figure 7) that can be reset to an optional spray pattern for germination, chemigation and other in-field adjustments.



Figure 7. LEPA center pivot with bubble applicator on corn.

LEPA applicators are usually placed 60 to 80 inches apart, corresponding to twice the row spacing. Thus, one row is wet and one row is dry. Dry middles allow more rainfall to be

stored. When the crop is planted in a circle, the applicators are arranged to maintain a dry row for the pivot wheels.

Research and field tests show that crop production is the same whether water is applied in every furrow or only in alternate furrows. The field trials indicated that crops use 95 to 98 percent of the irrigation water pumped through a LEPA system (Table 1). The water application is precise and concentrated.

LEPA can be used successfully in circles or in straight rows. It is especially beneficial for low-profile crops such as cotton and peanuts. This irrigation system is more common in areas with limited water supplies.

This system requires more planning and management, especially for crops in clay soils that infiltrate water more slowly.

### Subsurface drip irrigation (SDI)

In subsurface drip irrigation, drip tubes are placed from 6 to 12 inches below the soil surface, the depth depending on the soil type, crop and tillage practices.

Drip tubes typically include built-in emitters at optional spacings. The spacing and flow rate of the emitters depend on the amount of water required by the crop. Drip tubes should be installed no more than two row widths apart.

The amount of water available dictates the system’s design, control and management. SDI is a low-pressure, low-volume irrigation system (Figures 8a and b) like the LEPA center pivot.

Considered the most water-efficient system available, SDI has an application efficiency of 97 percent (Table 1). The advantages of a subsurface drip system include:

- It is a convenient and efficient way to supply water directly in the soil along individual crop rows and surrounding individual plant roots.
- It saves money by using water and labor efficiently.
- It can effectively deliver very small amounts of water



Figures 8a and b. Subsurface drip irrigation.

daily, which can save energy, increase yields and minimize leaching of soluble chemicals.

The disadvantages of a subsurface drip system include:

- It requires intensive management.
- During dry springs, an SDI system may be unable to deliver enough water to germinate the crop.
- It is essential that the system be designed and installed accurately. If the system is not managed properly, much water can be lost to deep percolation.

### Evaluating irrigation systems

Evaluating the feasibility of investing in a new irrigation system can be very complicated because many factors are involved.

However, once the factors are taken under consideration, the methodology in making the decision is relatively simple.

Growers should first estimate the gross investment cost, which is the amount of money required to buy the system. Next, estimate the “true” economic cost, or the net investment. Net investment takes into account tax savings, future salvage value and the opportunity cost (what the money could be earning if invested in the next best alternative) of the investment.

Each irrigation system has a combination of “annual benefits” that reduce costs and/or improve efficiency. The benefits may include decreased pumping, labor, field operations, etc. These benefits may more than offset the cost of adopting the system.

Because a dollar today is not worth the same as a dollar 5 years from now, all annual costs and benefits must be discounted to today’s dollars. This will allow you to directly compare the costs and benefits of irrigation systems both initially and across multiple years.

### Investment cost of irrigation systems

The investment costs for the six irrigation systems studied are listed in Table 2. The costs for the well, pump and engine were assumed to be the same for each irrigation system and were not included in the investment cost.

The gross investment for each quarter-section system (160 acres) ranged from \$165.32 per acre for conventional furrow to \$832.23 for subsurface drip irrigation with emitter lines spaced 5 feet apart. The gross investment for quarter-mile center pivot systems varied from \$341.68 (MESA) to \$376.00 (LEPA) per acre.

The total investment costs for each irrigation system, including well, pump and engine for five pumping lifts, are given in Appendix A, Table 1.

You can substantially reduce the investment cost of a center pivot irrigation system by increasing the length of the pivot. Using a half-mile center pivot rather than four quarter-mile systems reduces the investment by more than 30 percent, or by \$107.18 (from \$341.68 to \$234.56) to \$126.00 (from \$376.00 to \$250.00) per acre (Table 2). In addition, the corners become more functional for farming increasing in size from 8 to 30 acres.

To calculate the net investment, subtract the salvage value and discounted tax savings associated with a new system from the gross investment cost. By accounting for discounted tax savings and salvage value, producers can get a true comparison of what they would pay for each system.

The net investments for the different systems vary significantly less than the gross investments. For example, the difference in net investment between a quarter-mile LESA center pivot and conventional furrow is \$115.42 per acre (\$268.05-\$152.63), given a 15 percent tax and 6 percent discount rates. The net investment for a subsurface drip irrigation system, \$614.71 per acre, is substantially less than the gross investment of \$832.23 per acre (Table 2).

The economic feasibility of a new irrigation system can be affected by the marginal tax rate. For example, if a producer’s marginal tax rate is 28 percent instead of 15 percent, the net investment in subsurface drip is reduced by \$44.25 (from \$614.71 to \$570.46) per acre; the net investment in furrow is reduced by \$10.98 (from \$152.63 to \$141.65) per acre.

Therefore, all systems become more feasible at the higher tax rate. The most expensive system is affected the most by the marginal tax rate; the least expensive system is affected the least (\$44.25 versus \$10.98 per acre).

### Estimated Annual Operating Expenses

In the study, annual operating expenses—including both fixed and variable costs—were estimated for each system per acre-inch of water pumped. These expenses per acre were based on the application efficiency of each system to apply the equivalent amount of water to achieve the same crop yield (Table 3).

The annual pumping costs per acre were calculated by multiplying the total operating estimates per acre-inch by the number of acre-inches of water required for each system.

$$\begin{matrix} \text{Total operating} \\ \text{cost per} \\ \text{acre-inch} \end{matrix} \times \begin{matrix} \# \text{ acre-inches of water} \\ \text{required for the} \\ \text{irrigation system} \end{matrix} = \begin{matrix} \text{Annual} \\ \text{pumping costs} \\ \text{per acre} \end{matrix}$$

Table 2. Investment costs of alternative irrigation systems.

Distribution System	Gross Investment (\$/acre)	Net Investment <sup>1</sup> (\$/acre)	Net Investment <sup>2</sup> (\$/acre)
Conventional furrow (CF)	165.32	152.63	141.65
Surge flow (SF)	185.32	171.11	158.79
Mid-elevation spray application (MESA)	341.68	252.37	234.21
Low elevation spray application (LESA)	366.90	268.05	252.18
Low energy precision application (LEPA)	376.00	277.73	257.73
Mid-elevation spray application (MESA)*	234.56	173.26	160.78
Low elevation spray application (LESA)*	245.91	181.64	168.56
Low energy precision application (LEPA)*	250.00	184.66	171.37
Subsurface drip irrigation (SDI)	832.23	614.71	570.46

\*Half-mile center pivot.

<sup>1</sup>Assumes a marginal tax rate of 15 percent and discount rate of 6 percent.

<sup>2</sup>Assumes a marginal tax rate of 28 percent and discount rate of 6 percent. Salvage values and useful system life are in Appendix A, Table 2.

## Assumptions and crop scenarios

To calculate operating costs, researchers assumed three crop scenarios: high water use (corn); intermediate water use (sorghum/soybeans); and low water use (cotton).

For each crop scenario, the amount of water needed to be pumped was estimated by multiplying the water required by the LESA center pivot times the application efficiency index for each irrigation system. Therefore, the effective amount of water pumped would remain constant for all systems.

Water required by the LESA center pivot X Application efficiency index for the irrigation system = Amount of water required for the irrigation system

The index for each system was calculated by dividing the LESA application efficiency (which is 0.88) by the application efficiency of that system.

For example, the application efficiency index for furrow is 1.47 (0.88/0.60) and 0.93 for LEPA (0.88/0.95). Therefore, if 14 acre-inches are pumped through the LESA center pivot system, a conventional furrow system would require 20.58 acre-inches of water (14 x 1.47) to apply the same effective amount of water to the crop at the intermediate water use level (Table 3).

## Fixed operating costs

Fixed operating costs include depreciation, taxes, insurance and interest charges associated with an investment. The straight-line method was used to calculate depreciation.

Taxes were calculated at 1 percent of the assessed value using a tax assessment ratio of 0.20. Insurance was calculated as 0.6 percent of the purchase value. Interest was assumed to be 6 percent per year. The operational life of each irrigation system was assumed to be 25 years.

Table 4 lists the fixed costs in dollars per acre-inch of water pumped for the intermediate water-use crop scenario and 350 feet pumping lift. This cost ranged from \$0.87 for conventional furrow to \$4.18 for subsurface drip. The fixed cost per acre-inch for LESA center pivot is estimated to be \$1.92, including \$1.06 for depreciation, \$0.06 taxes, \$0.16 insurance and \$0.64 interest.

The assumptions used in the fixed-cost calculations are presented in Appendix A, Table 2.

## Variable pumping costs

Variable costs include fuel, lubrication, maintenance, repairs and labor. Fuel costs are based on natural gas priced at \$2.71 per thousand cubic feet (MCF). Lubrication, maintenance and repairs are assumed to be 65 percent of the fuel cost. The labor cost to operate the well, pump, engine and irrigation system was assessed at \$8 per hour.

Table 4 shows the variable pumping costs in dollars per acre-inch of water pumped for the six irrigation systems at 350 feet pumping lift.

Table 3. Water pumped for three crop scenarios and six irrigation systems in Texas.

Irrigation System	Application Efficiency (%)	Application Efficiency Index	acre-inches		
			High Water Use	Intermediate Water Use	Low Water Use
CF	60	1.47	29.40	20.58	11.76
SF	75	1.17	23.40	16.38	9.36
MESA	78	1.13	22.60	15.82	9.04
LESA	88	1.00	20.00	14.00	8.00
LEPA	95	0.93	18.60	13.02	7.44
SDI	97	0.91	18.20	12.74	7.28

Table 4. Fixed and variable pumping costs per acre-inch for the intermediate water-use scenario (sorghum/soybeans) at 350-foot pumping lift for the six irrigation systems.

Cost Component/System	dollars/acre-inch of water					
	CF	SF	MESA	LESA	LEPA	SDI
<b>A. Fixed cost</b>						
Depreciation	0.32	0.45	0.76	1.06	1.22	2.09
Taxes	0.02	0.02	0.04	0.06	0.06	0.13
Insurance	0.05	0.07	0.13	0.16	0.17	0.39
Interest charges	0.48	0.68	0.52	0.64	0.70	1.57
Total fixed costs	0.87	1.22	1.45	1.92	2.15	4.18
<b>B. Variable costs</b>						
Fuel costs	2.73	2.73	2.98	2.81	2.81	2.81
LMR <sup>1</sup> charges	1.80	1.82	2.10	2.03	2.05	2.17
Labor costs	0.92	0.73	0.70	0.62	0.57	0.56
Total variable costs	5.45	5.28	5.78	5.46	5.43	5.54
Total fixed and variable cost (A+B)	6.32	6.50	7.23	7.38	7.58	9.72

<sup>1</sup>Lubrication, maintenance and repairs.

The estimated total cost per acre-inch varied considerably among the systems evaluated. Furrow had the lowest total cost at \$6.32 per acre-inch; subsurface drip had the highest cost at \$9.72 per acre-inch. MESA, LESA and LEPA center pivot systems ranged from \$7.23 to \$7.58 per acre-inch.

### Total pumping cost

To calculate the annual pumping cost in dollars per acre, the total operating costs per acre-inch were multiplied by the number of acre-inches of water pumped in each crop scenario.

For the intermediate water use scenario, LEPA center pivot had the lowest annual pumping cost, \$98.69 (13.02 acre-inches x \$7.58 per acre-inch), because of its high application efficiency. Conversely, conventional furrow irrigation, which had the lowest pumping cost per acre-inch (\$6.32), had the highest total annual pumping cost \$130.07 (Table 5). This is because of its relatively low application efficiency, resulting in more water having to be pumped to apply the same effective amount.

Table 5. Total pumping cost per acre using natural gas fuel at 350-foot pumping lift for three crop scenarios and six irrigation systems.

System/ Water Use	dollars/acre		
	High Water Use	Intermediate Water Use	Low Water Use
CF	169.34	130.07	85.02
SF	138.29	106.47	71.51
MESA	148.03	114.38	78.11
LESA	130.60	103.32	72.88
LEPA	124.81	98.69	70.83
SDI	149.06	123.83	96.61

### Savings from field operations and total annual irrigation

Center pivot and subsurface drip irrigation systems require fewer field operations than do furrow or surge flow irrigation. For example, the field operations commonly used to produce corn under furrow or surge flow irrigation include shredding, offset disking, chiseling, tandem disking, bedding, rod weeding, planting and two cultivations.

For center pivot or subsurface drip irrigation, the number of field operations is generally reduced to shredding, offset disking, chiseling, planting and one cultivation. This represents a

reduction of four field operations. Assuming a cost of \$5 per operation, the estimated savings are \$20 per acre.

The number of field operations performed or saved varies considerably, depending on the cropping system, growing conditions for a particular year and the crop planted. Corn producers have indicated that anywhere from four to six field operations may be saved under center pivot or subsurface drip irrigation, amounting to \$20 to \$30 per acre. Typically, three field operations are eliminated for sorghum, soybeans and cotton production, saving \$15 per acre (Table 6).

Table 6. Savings in pumping cost and field operations using natural gas fuel at 350-foot pumping lift for the intermediate water-use scenario when shifting from furrow to more efficient irrigation systems per acre.

System	dollars/acre		
	Savings in Pumping Cost	Savings from Field Operations	Annual Irrigation Savings
CF	0.00	0.00	0.00
SF	23.60	0.00	23.60
MESA	15.69	15.00	30.69
LESA	26.75	15.00	41.75
LEPA	31.37	15.00	46.37
SDI	6.23	15.00	21.23

### Cost/Benefit Analysis

The net investment cost and benefits of adopting efficient irrigation technology at 350-foot pumping lifts for high, intermediate and low water-use crop scenarios are presented in Table 7.

The benefits include the estimated savings from reduced pumping costs and field operations from the five more efficient systems compared to the least efficient system (furrow). The series of benefits accumulated over the life of irrigation equipment (25 years) is discounted at the rate of 6 percent to present value. For example, the benefits for the high water-use scenario (corn) for surge flow are \$396.92 per acre in current dollars over 25 years.

It is considered economically feasible to adopt an irrigation system technology when the change in expected benefits exceeds the net investment cost. Comparing the purchase of conventional furrow system to a LEPA center pivot system

Table 7. Comparison of net investment cost and benefits of irrigation technology adoption at three water-use scenarios.

System	dollars/acre				
	Net Investment Cost	Change in Net Investment <sup>1</sup>	Net Benefits		
			High Water Use	Intermediate Water Use	Low Water Use
CF	152.63				
SF	171.11	18.48	396.92	301.63	172.76
MESA	252.37	99.74	528.13	392.28	280.20
LESA	268.05	115.42	750.95	533.65	347.00
LEPA	277.73	125.10	825.02	592.82	373.22
SDI	614.71	462.08	514.99	271.43	43.71

<sup>1</sup>Change in net investment cost from furrow.



reveals that LEPA requires an additional net investment of \$125.10 per acre; however, the reduction in field operations and pumping costs would save \$825.02 per acre under the assumption of high-water use.

Even under low-water use, adoption of LEPA is favorable, with expected gain in benefits of \$373.22 per acre compared to the \$125.10 per acre of additional investment.

A similar evaluation can be made of the other systems using Table 7. For example, comparing MESA and LESA center pivots indicates that the net investment would increase \$15.68 per acre (from \$252.37 to \$268.05) if a LESA system was purchased instead of MESA. However, assuming an intermediate water-use level, the increase in benefits of \$141.37 (\$392.28 to \$533.65) per acre far outweighs the cost.

Evaluating the conversion or replacement of an existing system from the data presented in Table 7 is more difficult. The expected benefits for each system as given in Table 7 will remain the same. However, a producer will need to estimate the cost of conversion, or the net investment of the “new” system adjusted for the salvage value of the present system, in order to evaluate its feasibility.

Several conclusions can be made from the results presented in Table 7:

- Adding surge valves to a conventional furrow irrigation system is cost effective if a producer can overcome the assorted management problems.
- It appears that the water and/or field operation savings justify converting furrow or MESA irrigation systems to LESA or LEPA center pivots whenever physically possible.
- Converting to drip irrigation is not feasible based on water and field operation savings.

The study did not address the potential yield increases of making more frequent water applications to the crop or the ability to irrigate more acreage with the same amount of water because of the improved application effectiveness. These factors could affect drip irrigation feasibility, especially for high-value crops.

## Sensitivity Analysis

The major factors that influence pumping cost for irrigated crops are price of fuel, pumping lift, inches of water pumped and labor wage rate. It is important to understand how these factors affect the economic feasibility of alternative irrigation systems.

Below are analyses of the effects of varying fuel price, pumping lift, water pumped and wage rate on irrigation costs for each irrigation system.

### Impact of fuel prices on pumping cost

The effect of fuel price on the grower’s fuel costs was calculated for each of the six irrigation systems. The fuel costs were estimated using natural gas prices ranging from \$3.00 to \$8.00 per MCF in increments of \$1.00.

It was assumed that corn irrigated by a LESA center pivot requires 20 acre-inches of water annually. For the other five irrigation systems, the amount of water pumped was adjusted by comparing the relative application efficiency of each system to that of the LESA center pivot (Table 8).

When the price of natural gas price increases from \$3.00 to \$8.00 per MCF, the total irrigation cost per acre-inch for each system more than doubles (Table 8). As natural gas prices rise, so do the savings on pumping costs for the irrigation systems with higher application efficiencies.

For example, at \$3.00 per MCF, a producer would save \$30.76 per acre (a decrease from \$88.79 to \$58.03 per acre) by using LEPA center pivot instead of conventional furrow. At \$8.00 per MCF, the savings would increase to \$82.39 (from \$154.57 to \$236.96) per acre.

This is the result of fuel costs increasing by \$148.17 (from \$88.79 to \$236.96) per acre for furrow, while LEPA increases by only \$96.54 (from \$58.03 to \$154.57) per acre. The more efficient the system, the more insulated a producer is from fuel price changes.

### Effect of lift on pumping cost

Fuel costs are affected by the depth from which the irrigation water must be pumped (pumping lift). In this study, the fuel costs for irrigating corn were estimated for the different irrigation systems at pumping lifts ranging from 150 feet to 550 feet in 100-foot increments to determine the impact of pumping lift (Table 9). The relative efficiency of each system was factored into these calculations.

The study found that the less efficient the irrigation system, the greater the effect of the price of fuel and pumping lift on the cost to produce an irrigated crop.

The fuel cost for an LEPA center pivot at 250-foot pumping lift was \$42.97; at 550 feet, the cost was \$61.94, an increase of \$18.97 per acre of irrigated corn. For that system, fuel cost increased by 44 percent as pumping lift increased from 250 feet to 550 feet.

Table 8. Estimated fuel costs for effective irrigation water applied to 1 acre of irrigated corn at alternative gas prices for six irrigation systems at 350-foot lift.

Gas Price (\$/MCF)		3	4	5	6	7	8
Irrigation System	Water Applied acre-inch	Fuel Costs dollars per acre					
CF	29.40	88.79	118.48	148.18	177.58	207.27	236.96
SF	23.40	70.67	94.30	117.94	141.34	164.97	188.60
MESA	22.60	74.58	99.44	124.30	149.39	174.25	199.11
LESA	20.00	62.40	83.00	103.80	124.60	145.40	166.20
LEPA	18.60	58.03	77.19	96.53	115.88	135.22	154.57
SDI	18.20	56.78	75.53	94.46	113.39	132.31	151.24

Table 9. Estimated fuel costs for pumping water to irrigate corn for five pumping lifts and six irrigation systems (dollars per acre)<sup>1</sup>.

Pumping Lift		150'	250'	350'	450'	550'
Irrigation System	Water Applied acre-inches	dollars per acre				
CF	29.40	46.75	65.27	80.26	86.73	95.84
SF	23.40	37.21	51.95	63.88	69.03	76.28
MESA	22.60	43.17	56.50	67.35	73.22	78.20
LESA	20.00	34.00	46.20	56.20	60.40	66.60
LEPA	18.60	31.62	42.97	52.27	56.17	61.94
SDI	18.20	30.94	42.04	51.14	54.96	60.61

<sup>1</sup>Natural gas price of \$2.71 per MCF was assumed.

For conventional furrow, the pumping cost was \$65.27 at 250 feet and \$95.84 at 550 feet. This was an increase of \$30.57 per acre, which was \$11.60 more than LEPA center pivot. The fuel costs for each irrigated acre of corn were \$80.26 and \$52.27 at 350-foot pumping lift using conventional furrow and LEPA center pivot, respectively.

At 350-foot pumping lift, producers will be able to save about \$28.00 in fuel costs for each irrigated acre by changing to more-efficient irrigation systems and improved technologies.

The savings in fuel cost by shifting from furrow to LEPA increases to \$33.90 for every irrigated acre of corn at the 550-foot pumping lift. This finding indicates that the farther water must be pumped from the ground, the more savings that growers will realize by adopting a more efficient irrigation system.

### Amount of water pumped affects fixed pumping costs

To analyze the effect of the amount of water pumped on fixed cost per acre-inch, researchers calculated the fixed costs for all irrigation systems at 350-foot pumping lift. The amounts of water analyzed ranged from 10 to 30 acre-inches per acre.

It is obvious that fixed cost per acre-inch has an inverse relationship to the amount of water pumped (Figure 9). That is, the less water pumped, the higher the fixed cost per acre-inch.

At 10 acre-inches of water, the fixed cost per acre-inch of water pumped using subsurface drip was \$5.31; for conventional furrow, the fixed cost was \$1.76. However, as the amount of water pumped increased to 30 acre-inches, the fixed cost dropped to \$1.77 for subsurface drip and to \$0.59 for con-

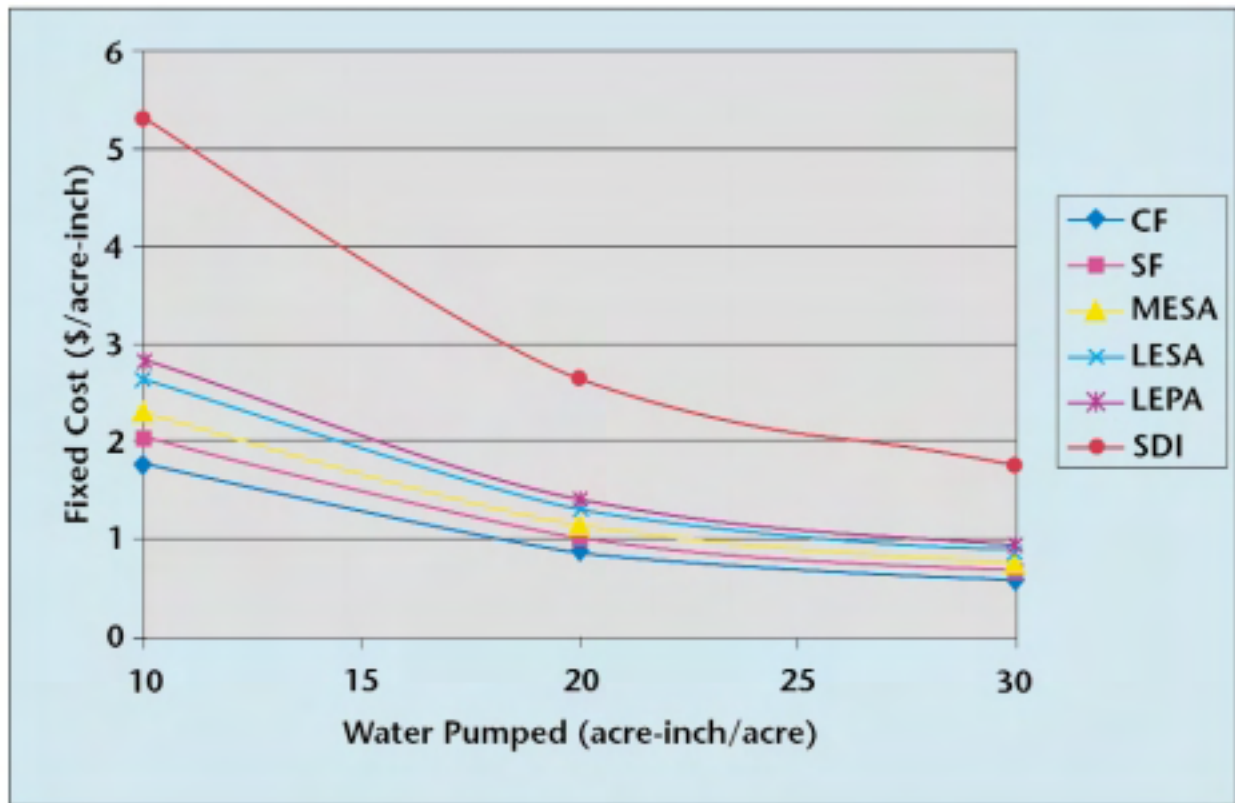

Figure 9. Changes in fixed cost as affected by the amount of water pumped in six types of irrigation systems.

ventional furrow. Therefore, the difference in fixed cost of the systems narrowed significantly, from \$3.55 per acre-inch (from \$5.31 to \$1.76) to \$1.18 per acre-inch (\$1.77 to \$0.59) as use increased from 10 to 30 acre-inches per year.

For MESA, LESA and LEPA center pivots, the fixed cost per acre-inch ranged from \$2.31 to \$2.83 for 10 acre-inches and decreased to \$0.77 and \$0.94 for 30 acre-inches applied, respectively.

It may be deduced that producers tend to pump more water to reduce fixed cost per acre-inch. The large investments involved in adopting more efficient irrigation technology also encourage investors to increase water pumping to recover their investments as soon as possible.

### Effect of wage rate on pumping costs

The availability and cost of labor greatly affect the selection of an irrigation system. To evaluate labor charges accurately, growers must identify all costs. For example, be sure to factor in the costs of transportation, meals, lodging, insurance and/or taxes if you provide or pay them. If you do not identify all labor costs, your estimate of the value of a particular irrigation system may be inaccurate.

The labor costs for irrigated corn were calculated at five wage rates for the six irrigation systems (Table 10). Labor costs at \$12 per hour using conventional furrow and LEPA center pivot were \$28.35 and \$11.29 per acre, respectively. By switching to more a efficient irrigation system, growers can reduce labor costs by \$17.06 for each acre irrigated annually.

The savings in labor cost by shifting from conventional furrow to LEPA center pivot increases to \$22.75 for every irrigated acre of corn at the labor wage rate of \$16 per hour. The comparison indicates that as wage rates rise, it becomes more cost effective to adopt a more efficient irrigation system.

### Additional benefits from fertigation and chemigation

Applying fertilizers with irrigation waters is called fertigation. Most fertigation uses soluble or liquid formulations of nitrogen, phosphorus and potassium. Fertigation can easily be accomplished by using any of the irrigation technologies considered.

Fertigation has many benefits, including:

- Nutrients can be applied uniformly and at any time during the growing season as needed by the crop, thus maximizing the effectiveness of the fertilizer.
- It can reduce application costs and eliminate some of the tillage operations performed to incorporate fertilizer.

- The threat of groundwater contamination and crop “burn” is decreased when smaller but more frequent applications of fertilizer are made.

Chemigation is the application of an approved chemical (herbicide, insecticide, fungicide or nematicide) with irrigation water through an irrigation system. Chemigation is a cost-effective management tool for crop production. Approved systematic chemicals can be used in all six of the irrigation systems evaluated, reducing application costs.

However, center pivot has a distinct advantage over the other systems considered because it is flexible enough to apply chemicals that must reach the crop canopy.

Chemigation through center pivot has many advantages over ground or aerial application, including uniform and precise application, cost saving, operator safety and the need for potentially smaller amounts of chemicals while achieving the same level of control. Also, environmental contamination may be reduced because there is less drift with chemigation than with aerial or ground-sprayer applications.

Chemigation makes irrigation more economically feasible. The cost of applying chemicals through an irrigation system is one-third to one-half as much as from aircraft or tractors.

However, chemigation requires skill in calibration, knowledge of the irrigation and chemigation equipment, and understanding of chemical and irrigation scheduling.

Table 11 gives an example of the costs of applying chemicals using an LEPA center pivot system compared to aerial or ground application. When using conventional application methods, the costs range from \$3.16 to \$6.32; the costs using LEPA center pivot for chemigation range from \$1.17 to \$2.34.

The costs drop significantly as the number of annual applications increase. Producers can save from \$1.99 to \$3.98 per acre when using center pivot for chemigation. This finding suggests that producers can save even more by applying chemicals through advanced irrigation technology such as center pivot.

### Study limitations

Researchers evaluated the predominate irrigation systems in Texas and analyzed the major factors that affect their economic feasibility. But because of study and space limitations, the discussion of some items was omitted or limited.

First, researchers considered only one method of improving the application efficiency of conventional furrow irrigation systems: the addition of a surge valve. A second way to improve the application efficiency of conventional furrow is to

Table 10. Labor costs for irrigated corn at five wage rates for six irrigation systems.

Wage Rate (\$/Hour)		8	10	12	14	16
Irrigation System	Water Applied acre-inches	Labor Cost dollars per acre				
CF	29.40	18.90	23.63	28.35	33.08	37.80
SF	23.40	11.93	14.91	17.89	20.88	23.86
MESA	22.60	11.12	13.90	16.68	19.46	22.24
LESA	20.00	8.70	10.88	13.05	15.23	17.40
LEPA	18.60	7.53	9.41	11.29	13.17	15.05
SDI	18.20	7.21	9.01	10.81	12.62	14.42

Table 11. Variable cost savings of chemigation through LEPA versus aerial application.

Variable Cost Item	dollars per acre					
	One Annual Application			Two Annual Applications		
	Aerial/Conventional	LEPA	Saving	Aerial/Conventional	LEPA	Saving
Application cost	3.00	0.67	2.33	6.00	1.34	4.66
Labor	0.00	0.12	(0.12)	0.00	0.24	(0.24)
Repairs	0.00	0.32	(0.32)	0.00	0.64	(0.64)
Interest (10.5 %, 6 mo)	0.16	0.06	0.10	0.32	0.12	0.20
Total variable cost	3.16	1.17	1.99	6.32	2.34	3.98

add a tailwater recovery system. This involves building a tailwater pit to hold excess runoff and buying a pump and underground line to recirculate the water to the top of the field.

Depending on the topography and soil type of the field, producers can increase application efficiency from 60 percent to 80 percent by adding a tailwater recovery system.

Another limitation in the analysis was that yields were held constant even when the amount of water applied by the distribution system was modified by its application efficiency.

Although this approach is sound, it does not account for potential yield gains that may be obtained through more frequent irrigations that can result through center pivots and especially SDI as compared to conventional furrow.

## Summary

Investing in a new irrigation system is expensive and complex, with many factors needing to be evaluated, including water availability, pumping lift, labor cost, fuel cost, tax rate, soil type, field topography, etc.

Overlaying these factors are the differences in the cost and water application efficiencies of the various irrigation systems. These factors make it difficult to make a wise investment decision.

To help farmers weigh these factors and make these decisions, researchers studied the costs and associated benefits of six commonly used irrigation systems in Texas: conventional furrow, surge flow, mid-elevation spray application center pivot, low elevation spray application center pivot, low energy precision application center pivot, and subsurface drip.

The study found that:

- Furrow irrigation requires less capital investment but has lower water application efficiency and is more labor intensive than the other irrigation systems.
- Adding surge flow valves increases water application efficiency enough to increase returns per acre. However, before purchasing surge equipment, growers should closely evaluate the ability to provide the required constant management of irrigation scheduling with surge flow systems.
- Compared to furrow irrigation, center pivots offer more than enough benefits in application efficiency and reduction in field operations to offset the additional costs.
- Where it is feasible to use, half-mile center pivot offers substantial savings compared to quarter-mile.
- Among the three center pivot alternatives, LEPA center pivot generates the highest benefits at low, intermediate and high water requirement scenarios.

- Advanced irrigation technologies are best suited to crops with high water needs, particularly in areas with deep pumping lifts. Producers using advanced systems will have not only lower pumping costs, but also potential savings from chemigation and the need for fewer field operations.
- Compared to LEPA center pivot, subsurface drip irrigation (SDI) is not economically feasible for any crop water-use scenario because of its relatively high investment and small gain in application efficiency. For most crops, adoption of SDI may be limited to land where pivots cannot physically be installed.
- However, producers should closely evaluate using SDI systems for high-value crops. Research suggests that SDI systems may improve the application efficiency and the timing of frequent applications. These improvements may increase acreage and yields enough to justify the additional investment costs of subsurface drip systems.

Researchers also studied the effect on pumping cost of variations in fuel prices, pumping lift, amount of water pumped and labor wage rate. Results indicated that:

- The less efficient the irrigation system, the more effect that fuel price, pumping lift and wage rate have on the cost of producing an irrigated crop. Therefore, when there is inflation or volatility of these cost factors, it is more feasible to adopt more efficient irrigation systems and technology.
- As more water is pumped, the fixed cost per acre-inch drops. Therefore, pumping more water encourages farmers to recapture their irrigation system investment more quickly.

## For More Information

- B-1241, "Crop and Livestock Enterprise Budgets, Texas High Plains, Projected for 2000," Texas Cooperative Extension.
- B-6096, "Center Pivot Irrigation," Texas Cooperative Extension.
- Bordovsky, James P., William M. Lyle and Eduardo Segarra. "Economic Evaluation of Texas High Plains Cotton Irrigated by LEPA and Subsurface Drip." Texas Journal of Agriculture and Natural Resources. 2000. pp. 76-73.
- Wilson, P., H. Ayer, and G. Snider. "Drip irrigation for cotton: implications for farm profits." Agricultural Economics Research Report 517, Economics Research Service, USDA, Washington, DC. 1984.
- Texas Agricultural Statistics Service. "Texas custom rates statistics." U.S. Department of Agriculture, National Agricultural Statistics Service, Austin, TX. 1999.

# Appendix

Table 1. Estimated gross investment costs (in dollars) for alternative irrigation systems at five pumping lifts in Texas.

Irrigation System/Lift (feet)	Well	Pump	Engine	Sprinkler Heads	Distribution System	Total
<b>CF</b>						
150'			2,800		26,450	29,250
250'	18,700	14,040	3,500		26,450	29,950
350'	23,625	19,610	5,000		26,450	31,450
450'	28,000	23,520	5,500		26,450	31,950
550'	34,312	29,315	20,000		26,450	46,450
<b>SF</b>						
150'			2,800		29,650	32,450
250'	18,700	14,040	3,500		29,650	33,150
350'	23,625	19,610	5,000		29,650	34,650
450'	28,000	23,520	5,500		29,650	35,150
550'	34,312	29,315	20,000		29,650	49,650
<b>MESA</b>						
150'			2,800	1,710	41,000	45,510
250'	18,700	14,040	3,500	1,710	41,000	46,210
350'	23,625	19,610	5,000	1,710	41,000	47,710
450'	28,000	23,520	5,500	1,710	41,000	48,210
550'	34,312	29,315	20,000	1,710	41,000	62,710
<b>LESA</b>						
150'			2,800	4,863	41,000	48,663
250'	18,700	14,040	3,500	4,863	41,000	49,363
350'	23,625	19,610	5,000	4,863	41,000	50,863
450'	28,000	23,520	5,500	4,863	41,000	51,363
550'	34,312	29,315	20,000	4,863	41,000	65,863
<b>LEPA</b>						
150'			2,800	6,000	41,000	49,800
250'	18,700	14,040	3,500	6,000	41,000	50,500
350'	23,625	19,610	5,000	6,000	41,000	52,000
450'	28,000	23,520	5,500	6,000	41,000	52,500
550'	34,312	29,315	20,000	6,000	41,000	67,000
<b>SDI</b>						
150'			2,800		133,157	135,957
250'	18,700	14,040	3,500		133,157	136,657
350'	23,625	19,610	5,000		133,157	138,157
450'	28,000	23,520	5,500		133,157	138,657
550'	34,312	29,315	20,000		133,157	153,157

Table 2. Useful life and salvage value assumptions used to calculate depreciation of six irrigation systems.

Item/Component	Useful Life (years)	Salvage value (%)
Furrow /surge flow	25	0
Center pivot	25	20
Sprinkler heads	8	10
Subsurface drip	25	20

Table 3. Fixed cost for irrigating at three levels of water use under six irrigation systems.

System/Water Use	dollars/acre inch				
	Depreciation	Taxes	Insurance	Interest	Total
<b>CF</b>					
High	0.22	0.01	0.03	0.34	0.60
Intermediate	0.32	0.02	0.05	0.48	0.87
Low	0.56	0.03	0.08	0.84	1.51
<b>SF</b>					
High	0.32	0.02	0.05	0.48	0.87
Intermediate	0.45	0.02	0.07	0.68	1.22
Low	0.79	0.04	0.12	1.19	2.14
<b>MESA</b>					
High	0.53	0.03	0.09	0.37	1.02
Intermediate	0.76	0.04	0.13	0.52	1.45
Low	1.33	0.07	0.23	0.91	2.54
<b>LESA</b>					
High	0.74	0.03	0.11	0.44	1.32
Intermediate	1.06	0.06	0.16	0.64	1.92
Low	1.86	0.09	0.28	1.11	3.34
<b>LEPA</b>					
High	0.85	0.05	0.13	0.49	1.52
Intermediate	1.22	0.06	0.17	0.70	2.15
Low	2.14	0.10	0.30	1.23	3.77
<b>SDI</b>					
High	1.46	0.09	0.27	1.10	2.92
Intermediate	2.09	0.13	0.39	1.57	4.18
Low	3.66	0.23	0.69	2.74	7.32

Table 4. Variable costs (dollars per acre-inch) for a high water-use crop (corn) for six irrigation systems at five lifts.

System/Lift	dollars/acre-inch			
	Fuel	LMR	Labor	Total
<b>CF</b>				
150'	1.59	1.05	0.64	3.28
250'	2.22	1.46	0.64	4.32
350'	2.73	1.79	0.64	5.16
450'	2.95	1.94	0.64	5.53
550'	3.26	2.14	0.64	6.04
<b>SF</b>				
150'	1.59	1.06	0.51	3.16
250'	2.22	1.47	0.51	4.20
350'	2.73	1.80	0.51	5.04
450'	2.95	1.95	0.51	5.41
550'	3.26	2.15	0.51	5.92
<b>MESA</b>				
150'	1.91	1.36	0.49	3.76
250'	2.50	1.75	0.49	4.74
350'	2.98	2.06	0.49	5.53
450'	3.24	2.23	0.49	5.96
550'	3.46	2.37	0.49	6.32
<b>LESA</b>				
150'	1.70	1.25	0.43	3.38
250'	2.31	1.64	0.43	4.39
350'	2.81	1.97	0.43	5.21
450'	3.02	2.10	0.43	5.56
550'	3.33	2.30	0.43	6.07
<b>LEPA</b>				
150'	1.70	1.25	0.41	3.36
250'	2.31	1.65	0.41	4.37
350'	2.81	1.97	0.41	5.19
450'	3.02	2.11	0.41	5.54
550'	3.33	2.31	0.41	6.05
<b>SDI</b>				
150'	1.70	1.35	0.39	3.44
250'	2.31	1.75	0.39	4.45
350'	2.81	2.07	0.39	5.27
450'	3.02	2.21	0.39	5.62
550'	3.33	2.41	0.39	6.13

Table 5. Variable costs (dollars per acre-inch) for an intermediate water-use crop (sorghum/soybeans) for six irrigation systems at five lifts.

System/Lift	dollars/acre-inch			
	Fuel	LMR	Labor	Total
<b>CF</b>				
150'	1.59	1.06	0.92	3.57
250'	2.22	1.47	0.92	4.61
350'	2.73	1.80	0.92	5.45
450'	2.95	1.95	0.92	5.82
550'	3.26	2.15	0.92	6.33
<b>SF</b>				
150'	1.59	1.08	0.73	3.40
250'	2.22	1.49	0.73	4.44
350'	2.73	1.82	0.73	5.28
450'	2.95	1.97	0.73	5.65
550'	3.26	2.17	0.73	6.16
<b>MESA</b>				
150'	1.91	1.40	0.70	4.01
250'	2.50	1.79	0.70	4.99
350'	2.98	2.10	0.70	5.78
450'	3.24	2.27	0.70	6.21
550'	3.46	2.41	0.70	5.57
<b>LESA</b>				
150'	1.70	1.31	0.62	3.63
250'	2.31	1.70	0.62	4.63
350'	2.81	2.03	0.62	5.46
450'	3.02	2.16	0.62	5.81
550'	3.33	2.36	0.62	6.32
<b>LEPA</b>				
150'	1.70	1.33	0.58	3.61
250'	2.31	1.72	0.58	4.61
350'	2.81	2.05	0.58	5.44
450'	3.02	2.18	0.58	5.78
550'	3.33	2.38	0.58	6.29
<b>SDI</b>				
150'	1.70	1.45	0.57	3.72
250'	2.31	1.84	0.57	4.72
350'	2.81	2.17	0.57	5.55
450'	3.02	2.30	0.57	5.89
550'	3.33	2.50	0.57	6.40

Table 6. Variable costs (dollars per acre-inch) for a low water-use crop (cotton) for six irrigation systems at five lifts.

System/Lift	dollars/acre-inch			
	Fuel	LMR	Labor	Total
CF				
150'	1.59	1.08	1.16	3.83
250'	2.22	1.49	1.16	4.87
350'	2.73	1.82	1.16	5.72
450'	2.95	1.97	1.16	6.08
550'	3.26	2.17	1.16	6.59
SF				
150'	1.59	1.11	0.92	3.62
250'	2.22	1.52	0.92	4.66
350'	2.73	1.85	0.92	5.50
450'	2.95	2.00	0.92	5.87
550'	3.26	2.20	0.92	6.38
MESA				
150'	1.91	1.53	0.89	4.33
250'	2.50	1.91	0.89	5.30
350'	2.98	2.23	0.89	6.10
450'	3.24	2.39	0.89	6.52
550'	3.46	2.54	0.89	6.89
LESA				
150'	1.70	1.45	0.79	3.94
250'	2.31	1.85	0.79	4.95
350'	2.81	2.17	0.79	5.77
450'	3.02	2.31	0.79	6.12
550'	3.33	2.51	0.79	6.63
LEPA				
150'	1.70	1.49	0.73	3.92
250'	2.31	1.88	0.73	4.92
350'	2.81	2.21	0.73	5.75
450'	3.02	2.34	0.73	6.09
550'	3.33	2.54	0.73	6.61
SDI				
150'	1.70	1.70	0.72	4.12
250'	2.31	2.10	0.72	5.13
350'	2.81	2.43	0.72	5.95
450'	3.02	2.56	0.72	6.30
550'	3.33	2.76	0.72	6.81

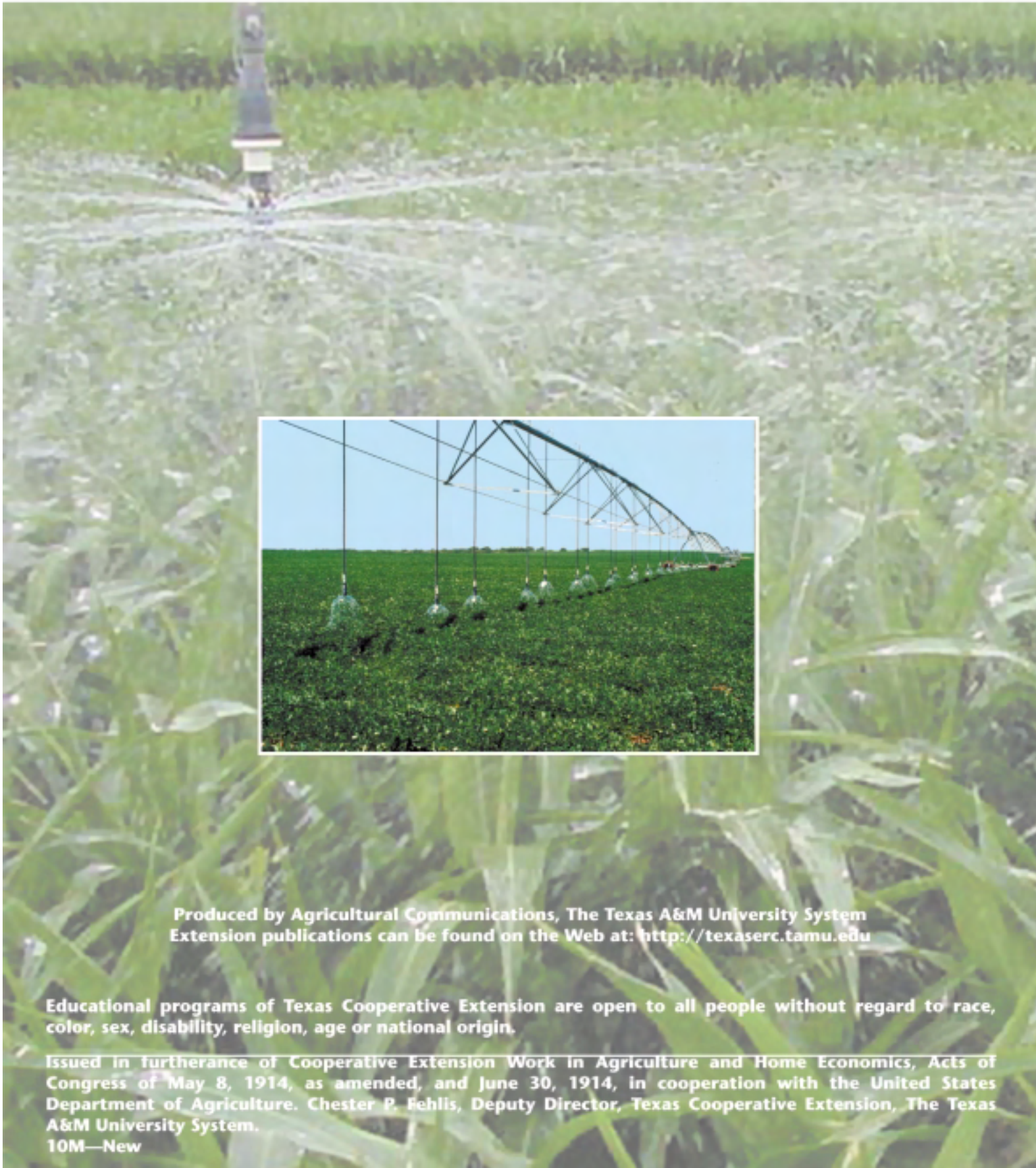

Produced by Agricultural Communications, The Texas A&M University System  
Extension publications can be found on the Web at: <http://texaserc.tamu.edu>

Educational programs of Texas Cooperative Extension are open to all people without regard to race, color, sex, disability, religion, age or national origin.

Issued in furtherance of Cooperative Extension Work in Agriculture and Home Economics, Acts of Congress of May 8, 1914, as amended, and June 30, 1914, in cooperation with the United States Department of Agriculture. Chester P. Fehlis, Deputy Director, Texas Cooperative Extension, The Texas A&M University System.

10M—New





# Calculating Horsepower Requirements and Sizing Irrigation Pipelines (B-6011)



# Calculating Horsepower Requirements and Sizing Irrigation Supply Pipelines

Guy Fipps\*

Pumping costs are often one of the largest single expenses in irrigated agriculture. Table 1 shows typical fuel use and costs of pumping in Texas as measured in irrigation pumping plant tests conducted by the Texas Agricultural Extension Service. Properly sizing pipelines for the particular situation will help minimize these costs. This publication outlines how to calculate the horsepower requirements of irrigation pumps and how to use this information in sizing supply pipelines.

## Pumping Plant Efficiency

An irrigation pumping plant has three major components:

1. a power unit,
2. a pump drive or gear head, and
3. a pump.

For electric powered plants, the pump lineshaft and the motor shaft are usually directly connected, making a pump drive or gear head unnecessary.

The *overall pumping plant efficiency* is a combination of the efficiencies of each separate component. Individual pumping unit components in good condition and carefully matched to the requirements of a specific pumping situation can have efficiencies similar to those given in Table 2. However, many pumping units operate at efficiencies far below acceptable levels (Table 3). Additional details on pumping plant efficiency are given in L-2218, "Pumping Plant Efficiency and Irrigation Costs," (available from your county Extension agent).

## Performance Standards

There are two common methods of determining the efficiency of pumping plants. One is to measure the efficiency of each component of the plant (motor, shaft and pump). Once the efficiencies of the components are

known, the overall efficiency is easily calculated. This requires specialized equipment and considerable expertise.

Another method is to calculate the load on the motor or engine and then measure how much fuel is used by the power unit. The fuel usage can then be compared to a standard. The most widely used standards were developed by the Agricultural Engineering Department of the University of Nebraska (Table 4). The fuel consumption rates in Table 4 indicate the fuel use which can be *reasonably expected* from a properly engineered irrigation pumping plant in good condition. The actual fuel usage of a new or reconditioned plant should not be larger than that shown in Table 4.

## Calculating Horsepower

Horsepower is a measurement of the amount of energy necessary to do work. In determining the horsepower used to pump water, we must know the:

1. pumping rate in gallons per minute (gpm), and
2. total dynamic head (TDH) in feet.

The theoretical power needed for pumping water is called **water horsepower** (whp) and is calculated by:

$$\text{(equation 1)} \quad \text{whp} = \frac{\text{gpm} \times \text{TDH (ft)}}{3,960}$$

Since no device or machine is 100 percent efficient, the horsepower output of the power unit must be higher than that calculated with equation 1. This horsepower, referred to as **brake horsepower** (bhp), is calculated by:

$$\text{(equation 2)} \quad \text{bhp} = \frac{\text{whp}}{\text{(pumping plant efficiency)}}$$

## Total Dynamic Head (TDH)

TDH may be viewed as the total load on the pumping plant. This load is usually expressed in feet of "head" (1 psi, or pound per square inch = 2.31 feet of

\*Extension agricultural engineer, The Texas A&M University System.

head). TDH can be calculated with the following equation:

$$\text{(equation 3) TDH} = \text{(static head)} + \text{(friction loss)} + \text{(operating pressure)} + \text{(elevation change)}$$

**Pumping lift:** “Pumping lift” is the vertical distance from the water level in the well to the pump outlet during pumping. In areas of falling water table, often the maximum depth to the water table expected during the pumping season is used.

**Friction loss:** Water flowing past the rough walls in a pipe creates friction which causes a loss in pressure. Friction losses also occur when water flows through pipe fittings, or when the pipe suddenly increases or decreases in diameter. Tables with values for friction loss through pipe and fittings similar to Tables 6 and 7 are widely available.

**Operating pressure requirements:** Manufacturers provide recommended operating pressures for specific water applicators in irrigation systems. Operating pressure in *psi* is converted to *feet of head* by the relationship:

$$1 \text{ psi} = 2.31 \text{ ft.}$$

**Elevation change:** Use the total change in elevation from the pump to the point of discharge, such as the end of the pipeline or sprinkler head. This elevation change may be positive (when the irrigation system is uphill from the pump) or negative (when it is downhill from the pump). Use only the difference in elevation between these two points, not the sum of each uphill or downhill section. Do not forget to add the distance from the ground to the point of water discharge, particularly for center pivot systems.

For center pivots, elevation differences caused by slopes in the field usually are accounted for in the computer printout of the design, and are included in the operating pressure requirements. If not, then the elevation change from the pivot point to the highest point in the field should be added to the total elevation change.

## Sizing Irrigation Mainlines

In sizing irrigation water supply pipelines, two factors are important: *friction losses* and *water hammer*; both are influenced by the relationship between flow rate (or velocity) and pipe size.

## Water Hammer

When moving water is subjected to a sudden change in flow, shock waves are produced. This is referred to as *water hammer* or *surge pressure*. Water hammer may be caused by shock waves created by sudden increases or decreases in the velocity of the water. Flow changes and shock waves can occur when valves are opened, pumps are started or stopped, or water encounters directional changes caused by pipe fittings.

## Controlling Water Hammer

To control surge pressure in situations where excessive pressures can develop by operating the pump with all valves closed, pressure relief valves are installed between the pump discharge and the pipeline. Also, pressure relief valves or surge chambers should be installed on the discharge side of the check valve where back flow may occur. Air trapped in a pipeline can contribute to water hammer. Air can compress and expand in the pipeline, causing velocity changes. To minimize such problems, prevent air from accumulating in the system by installing air-relief valves at the high points of the pipeline, at the end, and at the entrance.

Other general recommendations for minimizing water hammer include:

1. For long pipelines sloping up from the pump, install “nonslam” check valves designed to close at zero velocity and before the column of water above the pump has an opportunity to move back.
2. In filling a long piping system, the flow should be controlled with a gate valve to approximately three-fourths of the operating capacity. When the lines have filled, the valve should then be slowly opened until full operating capacity and pressure are attained.

## 5 Feet per Second Rule

To minimize water hammer, especially for plastic (PVC) pipe, water velocities should be limited to 5 ft/s (feet per second) unless special considerations are given to controlling water hammer. Most experts agree that the velocity should never exceed 10 ft/s. Also, the velocity of flow in the suction pipe of centrifugal pumps should be kept between 2 and 3 ft/s in order to prevent cavitation. Table 5 lists the maximum flow rates recommended for different ID (internal diameter) pipe sizes using the 5 ft/s rule. Many friction loss tables give both the friction loss and velocity for any given gpm and pipe size.

Velocity (V) in feet per second (ft/s) can be calculated based on the flow rate in gallons per minute (gpm) and pipe internal diameter in inches as:

$$\text{(equation 4) } V \text{ (ft/s)} = \frac{\text{Flow (gpm)}}{2.45 \text{ ID}^2 \text{ (inches)}}$$

## Friction Loss

Pumping plants must provide sufficient energy to overcome friction losses in pipelines. Excessive friction loss will lead to needlessly high horsepower requirements and correspondingly high fuel usage for pumping. Often the extra cost of a larger pipe will be recovered quickly from lower fuel costs. Both undersized and oversized pipe should be avoided.

Smooth pipe produces less friction loss and has lower operating costs than rough pipe. Plastic pipe, such as PVC, is the smoothest, followed by aluminum, steel and concrete, in that order. Table 6 lists typical friction losses in commonly used pipe. The friction

losses shown are for pipes of these internal diameters. This table is presented for information purposes only. Actual pipe diameters vary widely and more precise figures from manufacturers' specifications should be used for design purposes.

## Selecting PVC Pipe

Polyvinyl chloride (PVC) or thermoplastic pipe is exactly manufactured by a continuous extruding process which produces a strong seamless pipe that is chemically resistant, lightweight, and that minimizes friction loss. PVC pipe is produced in many sizes, grades and specifications.

### PVC Terminology

**Low pressure pipelines** – underground thermoplastic pipelines with 4- to 24-inch nominal diameter used in systems subject to pressures of 79 psi or less.

**High pressure pipelines** – underground thermoplastic pipelines of 1/2- to 27-inch nominal diameter that are closed to the atmosphere and subject to internal pressures (including surge pressures, from 80 to 315 psi).

**Class or PSI designation** – refers to a pressure rating in pounds per square inch (Table 8).

**Schedule** – refers to a plastic pipe with the same outside diameter and wall thickness as iron or steel pipe of the same nominal size (see Table 9).

**SDR (Standard Dimension Ratio)** – is the ratio of the outside pipe diameter to the wall thickness. Table 9 gives the pressure rating for pipes of various SDR.

**IPS** – refers to plastic pipe that has the same outside diameter as iron pipe of the same nominal size.

**PIP** – is an industry size designation for plastic irrigation pipe.

### Working Pressure

Tables 8 and 9 show the recommended maximum operating pressures of various classes and schedules of PVC pipe. Actual operating pressure may be equal to these pressure ratings as long as **surge pressures** are included, but be sure to account for **all** surges.

To determine which pipe to use, simply combine the total head in the pipe with the surge pressures, and select the closest larger class. However, surge pressures should not exceed 28 percent of the pipe's pressure class rating.

**When surge pressures are not known**, the actual operating or "working" pressure should not exceed the maximum allowable working pressures given in Table 11.

### Estimating Surge Pressure

As discussed above, keeping the velocity at or below 5 ft/s will help minimize surge pressure (or water hammer). However, the sudden opening and closing of valves will produce a surge pressure, which increases with higher velocities. The maximum surge pressure that will be produced in a PVC pipe with the sudden opening or closing of a valve can be determined with Table 10. For example, the surge pressure from a sudden valve closure with a water velocity of 7 ft/s in a SDR 26 PVC pipe is:

$$7 \times 14.4 = 100.8 \text{ psi}$$

This pressure then is added to the operating pressure to determine which class of PVC pipe to use.

# Example Problem #1 – Complete Analysis

Determine the difference in horsepower requirements and annual fuel costs for 6-inch and 8-inch mainlines (plastic pipe) for the following system:

## System Data

1. type of power plant	diesel
2. cost of energy	\$0.65 per gal.
3. pumping lift	250 ft.
4. pump column pipe distance to pump in column pipe	8-in. steel pipe 350 ft. (or 3.5 x 100-ft. sections)
5. system flow rate	750 gpm
6. yearly operating time	2000 hrs.
7. distance from pump to pivot	4000 ft. (or 40 x 100-ft. sections)
8. required operating pressure	45 psi
9. elevation change from pump to pivot	+37 ft.
10. types of fittings in system	check valve, gate valve, two standard elbows

## Step One - Calculate Total Dynamic Head (equation 3)

$$\text{TDH} = (\text{pumping lift}) + (\text{elevation change}) + (\text{operating pressure}) + (\text{friction losses})$$

1. **Pumping lift** (item 3) = 250 ft.

2. **Elevation change** (item 9) = + 37 ft.

3. **Operating pressure** (item 8) = 45 psi x (2.31 ft./psi) = 104 ft.

4. **Friction loss: Pump column pipe**

a. friction loss in 8-in. well casing (from Table 6) = 1.8 ft./100 ft.

b. total friction loss = 1.8 x 3.5 = 6.3 ft.

5. **Friction loss in plastic mainline (Case 1: 6-in. pipe)**

a. friction loss in pipe (from Table 6) = 3.4 ft./100 ft. x 40 = 136 ft.

b. friction loss in fittings (from Table 7)  
equivalent pipe length = 30 + 3.5 + (2 x 16) = 65.5 ft. of pipe  
friction loss = 3.4 ft./100 ft. x (65.5/100) = 2.2 ft.

c. total friction loss = 136 + 2.2 = 138.2 ft.

6. **Friction loss in plastic mainline (Case 2: 8-in. pipe)**

a. friction loss in pipe (from Table 5) = 0.8 ft./100 ft. x 40 = 32 ft.

b. friction loss in fittings  
equivalent pipe length = 40 + 4.5 + (2 x 14) = 72.5 ft. of pipe  
friction loss = 0.8 ft./100 ft. x (72.5/100) = 0.6 ft.

c. total friction loss = 32 + 0.6 = 32.6 ft.

7. **TDH (Case 1)** = (1) + (2) + (3) + (4) + (5) = 250 + 37 + 104 + 6.3 + 138.2 = 535.5 ft.

8. **TDH (Case 2)** = (1) + (2) + (3) + (4) + (6) = 250 + 37 + 104 + 6.3 + 32.6 = 429.9 ft.

## Step Two - Calculate Water Horsepower (equation 2)

$$\text{(Case 1) whp} = \frac{(750 \text{ gpm}) \times (535.5 \text{ ft.})}{3,960} = 101 \text{ whp}$$

$$\text{(Case 2) whp} = \frac{(750 \text{ gpm}) \times (429.9 \text{ ft.})}{3,960} = 82 \text{ whp}$$

Note: The output of the power plant must be larger than the water horsepower due to the pump's efficiency. Usually a pump efficiency of 75 percent is used in design. However, actual pump selection is based on pump performance curves available from manufacturers. Do not buy a pump on the basis of its horsepower rating alone. For more information see L-2218, "Pumping Plant Efficiency and Irrigation Costs," available from your county Extension agent.

## Brake horsepower (equation 2)

$$\text{(Case 1) bhp} = 101 / .75 = 135 \text{ bhp}$$

$$\text{(Case 2) bhp} = 81 / .75 = 108 \text{ bhp}$$

## Step Three - Calculate Annual Fuel Use

Note: The Nebraska Performance Standards (Table 4) may be used to estimate annual fuel use. From Table 4, each gallon of diesel fuel will provide 12.5 water horsepower-hours.

$$\text{fuel use} = \text{whp} \times \frac{1}{(\text{performance criteria})} \times (\text{hours of operation})$$

$$\text{(Case 1) fuel use} = 101 \text{ whp} \times \frac{\text{gal.}}{12.5 \text{ whp} \cdot \text{hrs.}} \times \frac{2,000 \text{ hrs.}}{\text{yr.}} = \frac{16,160 \text{ gals.}}{\text{yr.}}$$

$$\text{(Case 2) fuel use} = 81 \text{ whp} \times \frac{\text{gal.}}{12.5 \text{ whp} \cdot \text{hrs.}} \times \frac{2,000 \text{ hrs.}}{\text{yr.}} = \frac{12,960 \text{ gals.}}{\text{yr.}}$$

## Step Four - Calculate Annual Fuel Costs

$$\text{(Case 1) } \frac{16,160 \text{ gals.}}{\text{yr.}} \times \frac{\$0.65}{\text{gal.}} = \$ 10,504 \text{ per year for diesel fuel}$$

$$\text{(Case 2) } \frac{12,960 \text{ gals.}}{\text{yr.}} \times \frac{\$0.65}{\text{gal.}} = \$ 8,424 \text{ per year for diesel fuel}$$

$$\text{DIFFERENCE} = \$10,504 - \$8,424 = \$2,080$$

## Step Five - Calculate Total Water Pumped per Year

Note: The conversion rate used is 325,851 gal. = 1 ac.-ft.

$$\frac{750 \text{ gals.}}{\text{min.}} \times \frac{60 \text{ mins.}}{\text{hr.}} \times \frac{2,000 \text{ hrs.}}{\text{yr.}} = 90 \text{ million gals.} = 276 \text{ acre-feet of water}$$

## Example Problem 2: Simplified Analysis

In the above example, we found that the friction losses in the pump column pipe and through the fittings are minor. The only other difference between Case 1 and Case 2 was the friction loss in the pipeline. Thus, the difference in horsepower requirements and annual fuel costs between the 6-inch and 8-inch pipelines in the above example can be *approximated* by considering only the friction loss in the pipe.

### Step One - Calculate Pipeline Friction Loss Difference

$$(\text{friction loss in 6-in.}) - (\text{friction loss in 8-in.}) = 136 - 32 \text{ ft.} = 104 \text{ ft.}$$

### Step 2 - Calculate Increase in Horsepower and Annual Fuel Use

$$\text{whp} = \frac{750 \times 104}{3,960} = 19.7 \text{ whp}$$

$$\text{fuel use} = 19.7 \text{ whp} \times \frac{\text{gal.}}{12.5 \text{ whp} \cdot \text{hrs.}} \times \frac{2,000 \text{ hrs.}}{\text{yr.}} = \frac{3,151 \text{ gals.}}{\text{yr.}}$$

Note: This means that 3,151 more gallons of diesel would be required if a 6-inch mainline was used instead of an 8-inch mainline.

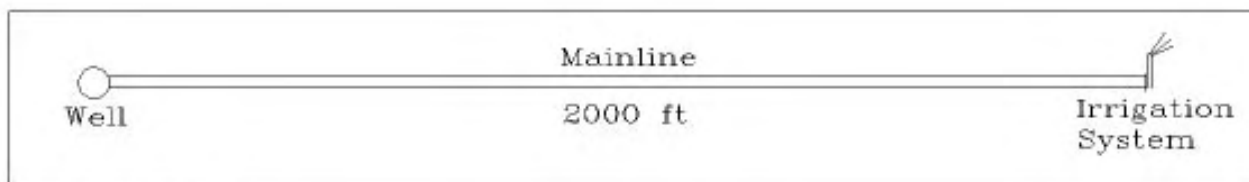
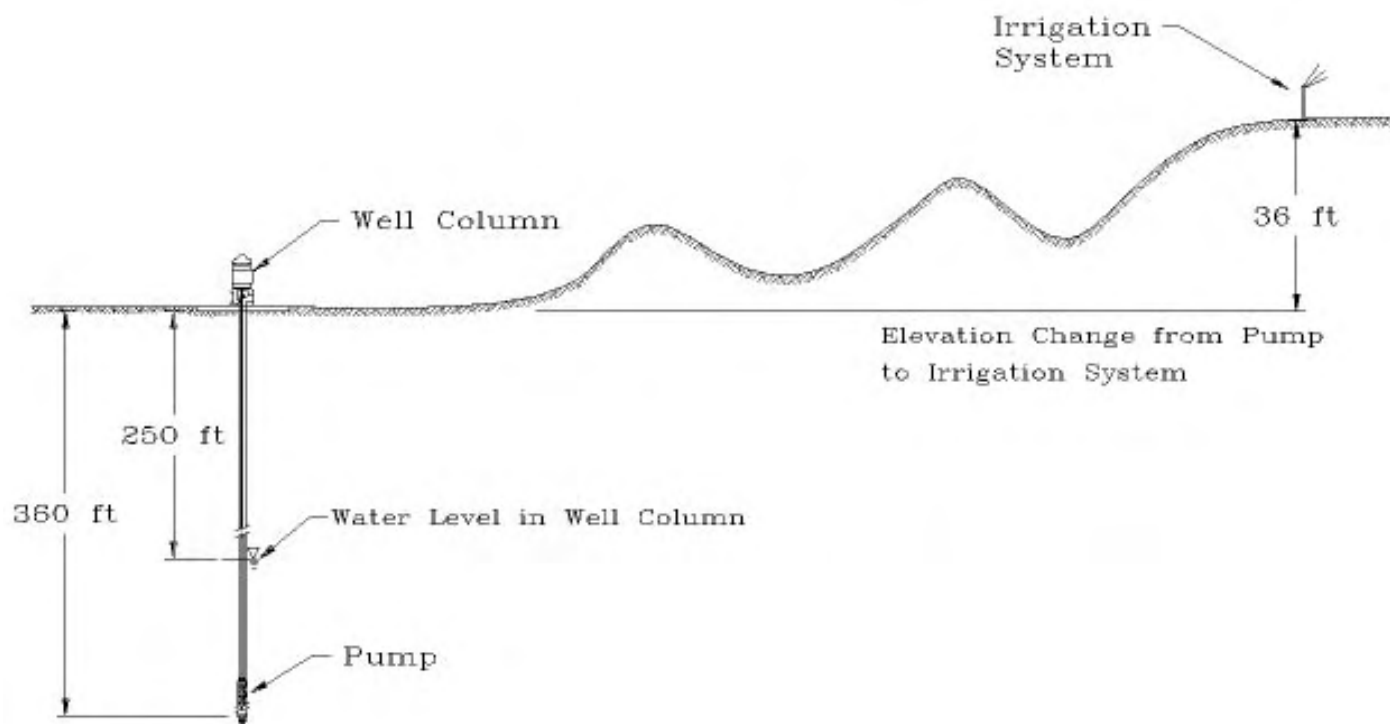

Drawn By: Ed Wilson

**Table 1. Pumping costs in the Texas High Plains (THP) and in South/Central Texas (SCT) per acre-inch of water at 100 feet total head from irrigation pumping plant efficiency tests conducted by the Texas Agricultural Extension Service.**

Type and price <sup>1</sup>	Region <sup>2</sup>	Cost (\$) per ac.-in. per 100 ft. head		
		lowest	highest	average
Natural Gas @ \$3.00 MCF	THP	0.40	3.93	0.81
	SCT	0.31	1.96	0.76
Electricity @ \$0.07/KWH	THP	0.49	3.10	1.35
	SCT	0.29	20.20	1.49
Diesel @ \$0.65/gal.	THP	0.57	1.91	0.77
	SCT	0.36	3.43	0.83

<sup>1</sup>Assumed price—actual prices varied in each region.

<sup>2</sup>THP (Texas High Plains) results are from more than 240 efficiency tests. SCT (South/Central Texas) results are from 240 efficiency tests.

**Table 2. Irrigation pumping equipment efficiency.**

Equipment	Attainable efficiency, percent
Pumps (centrifugal, turbine)	75-82
Right-angle pump drives (gear head)	95
Automotive-type engines	20-26
Industrial engines	
Diesel	25-37
Natural gas	24-27
Electric motors	
Small	75-85
Large	85-92

**Table 4. Nebraska performance criteria for pumping plants. Fuel use by new or reconditioned plants should equal or exceed these rates.**

Energy source	Water horsepower-hours <sup>1</sup> per unit of energy	Energy units
Diesel	12.5	gal.
Gasoline <sup>2</sup>	8.7	gal.
Natural gas	66.7 <sup>3</sup>	1,000 ft. <sup>3</sup>
Electricity	0.885 <sup>4</sup>	kwh

<sup>1</sup>Based on 75 percent efficiency.

<sup>2</sup>Includes drive losses and assumes no cooling fan.

<sup>3</sup>Assumes natural gas content of 1,000 btu per cubic foot.

<sup>4</sup>Direct connection—no drive.

**Table 3. Typical values of overall efficiency for representative pumping plants, expressed as percent.\***

Power source	Recommended as acceptable	Average values from field tests†
Electric	72-77	45-55
Diesel	20-25	13-15
Natural gas	18-24	9-13
Butane, propane	18-24	9-13
Gasoline	18-23	9-12

\* Ranges are given because of the variation in efficiencies of both pumps and power units. The difference in efficiency for high and low compression engines used for natural gas, propane and gasoline must be considered especially. The higher value of efficiency can be used for higher compression engines.

† Typical average observed values reported by pump efficiency test teams.

**Table 5. Approximate maximum flow rate in different pipe sizes to keep velocity ≤ 5 feet per second.**

Pipe diameter	Flow rate (gpm)
1/2	6
3/4	10
1	15
1 1/4	25
1 1/2	35
2	50
3	110
4	200
5	310
6	440
8	780
10	1225
12	1760
16	3140



**Table 6. Friction losses in feet of head per 100 feet of pipe (for pipes with internal diameters shown).**

Pipe size	4-inch			6-inch			8-inch			10-inch			12-inch		
	Steel	Alum.	PVC	Steel	Alum.	PVC	Steel	Alum.	PVC	Steel	Alum.	PVC	Steel	Alum.	PVC
Flow rate (gpm)															
100	1.2	0.9	0.6	---	---	---	---	---	---	---	---	---			
150	2.5	1.8	1.2	0.3	0.2	0.2	---	---	---	---	---	---			
200	4.3	3.0	2.1	0.6	0.4	0.3	0.1	0.1	0.1	---	---	---			
250	6.7	4.8	3.2	0.9	0.6	0.4	0.2	0.1	0.1	0.1	0.1	---	---	---	
300	9.5	6.2	4.3	1.3	0.8	0.6	0.3	0.2	0.1	0.1	0.1	---	---	---	---
400	16.0	10.6	7.2	2.2	1.5	1.0	0.5	0.3	0.2	0.2	0.1	0.1	0.1	---	---
500	24.1	17.1	11.4	3.4	2.4	1.6	0.8	0.6	0.4	0.3	0.2	0.1	0.1	0.1	0.1
750	51.1	36.3	24.1	7.1	5.0	3.4	1.8	1.3	0.8	0.6	0.4	0.3	0.2	0.1	0.1
1000	87.0	61.8	41.1	12.1	8.6	5.7	3.0	2.1	1.4	1.0	0.7	0.5	0.4	0.3	0.2
1250	131.4	93.3	62.1	18.3	13.0	8.6	4.5	3.2	2.1	1.5	1.1	0.7	0.6	0.4	0.3
1500	184.1	130.7	87.0	25.6	18.2	12.1	6.3	4.5	3.0	2.1	1.5	1.0	0.9	0.6	0.4
1750	244.9	173.9	115.7	34.1	24.2	16.1	8.4	6.0	4.0	2.8	2.0	1.3	1.2	0.9	0.6
2000	313.4	222.5	148.1	43.6	31.0	20.6	10.8	7.7	5.1	3.6	2.6	1.7	1.5	1.1	0.7

NOTE: Flow rates below horizontal line for each pipe size exceed the recommended 5-feet-per-second velocity.

**Table 7. Friction loss in fittings. Friction loss in terms of equivalent length of pipe (feet) of same diameter.**

Type of fitting	Inside pipe diameter (inches)					
	4	5	6	8	10	12
45-degree elbow	5	6	7	10	12.5	15
Long-sweep elbow	7	9	11	14	17	20
Standard elbow	11	13	16	20	25	32
Close return bend	24	30	36	50	61	72
Gate valve (open)	2	3	3.5	4.5	5.5	7
Gate valve (1/2 open)	65	81	100	130	160	195
Check valve	100	110	30	40	45	35

**Table 8. Pressure rating for class and SDR non-threaded PVC pipe.\***

Pipe designation	Maximum working pressure including surges (psi)
Class 80	80
Class 100	100
Class 125	125
Class 160	160
Class 200	200
Class 250	250
Class 315	315
SDR 81	50
SDR 51	75
SDR 41	100
SDR 32.5	125
SDR 26	160
SDR 21	200
SDR 17	250
SDR 13.5	315

\*For pipes of standard code designation: PVC 1120, PVC 1220, and PVC 2120.

**Table 10. Maximum surge pressures associated with sudden changes in velocity in psi per ft./s. water velocity (for 400,000 psi modulus of elasticity PVC materials).**

SDR	Maximum surge pressure (psi) per each ft./s. of water velocity
13.5	20.3
17.0	18.0
21.0	16.1
26.0	14.4
32.5	12.9
41.0	11.4
51.0	10.2
64.0	9.1
81.0	8.1

Example: The surge pressure from a sudden valve closure with a water velocity of 7 ft./s. in a SDR 26 PVC pipe is  $7 \times 14.4 = 100.8$  psi.

**Table 9. Pressure rating for schedule 40 and schedule 80 PVC pipe.\***

Diameter (inches)	Maximum operating pressure (psi)	
	Schedule 40	Schedule 80
3	840	1200
4	710	1040
6	560	890
8	500	790
10	450	750
12	420	730

\*For Type I, Grade I at 73.4 degrees F.

**Table 11. Maximum allowable working pressure for non-threaded PVC pipe when surge pressures are not known and for water temperatures of 73.4 degrees F.**

SDR	Maximum working pressure (psi)
13.5	227
17.0	180
21.0	144
26.0	115
32.5	90
41.0	72
51.0	58
64.0	45
81.0	36

## References and Suggested Reading

Jensen, M.E. (editor). 1980. **Design and Operation of Farm Irrigation Systems**. American Society of Agricultural Engineers Monograph No. 3., St. Joseph, MI.

New, L.L. *Center pivot irrigation systems*. L-2219, Texas Agricultural Extension Service.

New, L.L. *Pumping plant efficiency and irrigation costs*. L-2218, Texas Agricultural Extension Service.

New, L.L. and G. Fipps. *Planning and Operating Orchard Drip Irrigation Systems*. B-1663, Texas Agricultural Extension Service.

New, L.L. and G. Fipps. *Chemigation Equipment and Safety*. L-2422, Texas Agricultural Extension Service.

Pair, C.H. (editor). 1983. *Irrigation (Fifth Edition)*. Irrigation Association, Arlington, Virginia.

Turner, J.H. and C.L. Anderson. 1980. *Planning for an Irrigation System*. American Association for Vocational Instructional Materials, Athens, Georgia. (Available from Instructional Materials Services, Texas A&M University, (409) 845-6601, Order #4587, \$12).

Educational programs of the Texas Agricultural Extension Service are open to all people without regard to race, color, sex, disability, religion, age or national origin.

Issued in furtherance of Cooperative Extension Work in Agriculture and Home Economics, Acts of Congress of May 8, 1914, as amended, and June 30, 1914, in cooperation with the United States Department of Agriculture. Zerle L. Carpenter, Director, Texas Agricultural Extension Service, The Texas A&M University System.

2.5M-9-95, New ENG 9

# *IRRIGATION SCHEDULING*



**Evapotranspiration**

**Soil Moisture Management & Monitoring**



## In this Section

Overview: Evapotranspiration

Reference: The TexasET Network and Website User's Manual

Reference: Decision Support Systems: Tools for Implementing Best Management Practices in Texas (EM-100)

## Overview

### Objectives:

- Increase understanding of fundamentals of evapotranspiration (ET).
- Increase familiarity with ET resources, including ET Networks and Internet-available data and online tools.
- Apply these concepts to optimizing water management in crop production.

### Key Points:

1. Meteorological factors most often used to estimate ET are solar radiation (irradiance), air temperature, humidity, and wind speed.
2. ET can be limited by soil moisture availability.
3. Plant factors that affect ET include plant type, plant health, growth stage, plant population, and crop variety (affecting canopy and geometry). Successful application of ET models to irrigation scheduling requires relating the reference crop ET to the target crop ET through use of crop growth information and crop coefficients.
4. ET is most accurately measured through use of weighing lysimeters.
5. Alternate methods of estimating ET include water balance estimation techniques, including soil moisture monitoring.
6. Major ET Networks in the state include the Texas ET Network (primarily central and south Texas), the Texas High Plains ET Network (Texas Panhandle, South Plains, Rolling Plains, and West Texas) and the Precision Irrigators Network (Winter Garden region around Uvalde).



# *Evapotranspiration*

## **Assess your knowledge:**

1. What is Evapotranspiration?
2. What is an ET reference crop?
3. Name the two most commonly used ET reference crops.
4. Which ET reference crop is used most widely by ET networks in Texas?
5. How do you calibrate reference crop ET to estimate crop ET?
6. Why may actual crop use be less than model ET estimates?
7. How do you access ET information for your area and crop on the internet?
8. How can you apply ET to the “checkbook method” of irrigation scheduling?
9. Would you expect cumulative annual reference crop ET to be higher in Lubbock, Texas or Longview, Texas? Why?



# Evapotranspiration

## What is Evapotranspiration (ET)?

Evapotranspiration is a term that describes crop water demand by combining evaporation and transpiration. Evaporation is the process through which water is removed from moist soil and wet surfaces (such as dew on leaves). Transpiration is the process through which water is drawn up through the plant (roots extract water from the soil, and water is eventually removed through stomata on the leaves.)

## What is Reference ET (PET)?

Reference crop evapotranspiration, also referred to as Potential Evapotranspiration (PET), is an estimate of water requirement for a well watered reference crop. This reference crop (grass or alfalfa) is essentially an idealized crop used as a basis for the ET model. Reference ET is calculated by applying climate data (temperature, solar radiation, wind, humidity) in a model (equation). It is helpful to note that reference ET is only an estimate of the water demand for this idealized crop, based upon weather station data at a given location. The Texas High Plains ET Network uses an idealized grass reference crop.

## How is Crop Evapotranspiration Calculated?

Crop-specific ET is estimated by multiplying the Reference ET by a crop coefficient.

Crop ET = Reference ET x Crop Coefficient

The crop coefficient takes into account the crop's water use (at a given growth stage) compared with the reference crop. For instance, seedling corn does not use as much water as the idealized grass reference crop, but during silking the corn can use more water than the grass reference crop. The crop coefficient is understood to follow a pattern (curve) of a general shape, yet each crop (wheat, sorghum, etc.) will have its own crop coefficient curve.

The reference crop ET model and the crop coefficient curves were developed from long-term research at various locations. Actual crop water demand can be affected by many factors, including soil moisture available, health of the crop, and likely by plant populations and crop variety traits. These factors are not taken into account by the models. Hence, ET data provided by on-line networks are probably best used as guidelines for irrigation scheduling, and (where applicable) integrated pest management and integrated crop management. The predicted growth stage and estimated water use should be verified with field observations. The actual crop water use may be somewhat less than the predicted value due to less than optimal field conditions.

\* Compiled by Dana Porter, PhD, PE, Department of Biological and Agricultural Engineering and Texas AgriLife Research and Extension Center, Lubbock.



# Evapotranspiration

## How is Estimated ET used to Schedule Irrigation?

There are a variety of irrigation scheduling methods, models and tools available. Many are essentially based upon a “checkbox” approach: Water stored in the soil (in the crop’s root zone) is withdrawn by evapotranspiration and deposited back into the soil through precipitation and irrigation. When soil moisture storage falls below a given threshold value, irrigation should be applied to restore the moisture. The threshold value may be determined by crop drought sensitivity, by irrigation system capabilities, or other farm-level criteria.

## Where can I find Additional Information on ET and Related Topics?

One of the best sources for ET and other related water use information is available from the USDA-ARS Conservation and Production Research Laboratory, Soil and Water Management Research Unit at Bushland, Texas, near Amarillo. The water management unit is directed by Dr. Terry Howell, who is responsible for the large weighing lysimeter facility at Bushland. In laymen’s terms, lysimeters are extremely large “flower pots” (weighing on the order of 100,000 pounds or so) that rest upon an extremely sensitive scale whereby Dr. Howell’s group can measure water used through a crop’s evaporation and transpiration throughout the growing season. Much of these data from various crops have been incorporated into the TXHPET network water use and crop growth models. Some of Dr. Howell’s research data and associated efforts are available at [http://www.cprl.ars.usda.gov/swmru\\_research.htm](http://www.cprl.ars.usda.gov/swmru_research.htm)

Recently additional weighing lysimeters have been installed at Uvalde, Texas. Dr. Giovanni Piccinni and others are using these to obtain crop water use information for crops and conditions in the Winter Garden area.

Evapotranspiration networks in Texas may be accessed on the following websites:

- Texas High Plains ET Network: <http://txhighplainset.tamu.edu/>
- Texas ET Network: <http://texaset.tamu.edu/>
- Precision Irrigators Network: <http://uvalde.tamu.edu/>
- Crop Weather Program for the coastal plains: <http://cwp.tamu.edu>





# The TexasET Network and Website User's Manual



# The TexasET Network and Website

<http://texaset.tamu.edu>

## User's Manual

By

**Charles Swanson and Guy Fipps<sup>1</sup>**

October 2008

**Texas AgriLIFE Extension Service  
Texas A&M System**

---

<sup>1</sup>Extension Associate-Landscape Irrigation; and Professor & Extension Agricultural Engineer, Director, Irrigation Technology Center

## Table of Contents

TexasET Website Intro	1
What is Evapotranspiration?	1
Using the TexasET Website	3
Viewing the ET and Weather Data	3
Using the Irrigation Scheduling Tools	5
Frequent TexasET Users	10
Setting Up A User Account	10
Contacts	13

## TexasET Network and Website

The TexasET Network and Website access and displays daily weather and ETo (potential evapotranspiration) data from over 30 weather stations across the State of Texas. The web address is <http://texaset.tamu.edu>. In addition to daily weather and ETo data, the website also displays weather parameters useful for crop management, including:

- heat units for cotton, corn, and sorghum
- heat units in terms of 50, 55 and 60 degrees
- daily wind run (miles per day)
- dew point temperature

Users can display sums of weather data over any date range desired and calculate irrigation runtimes.

The website also has interactive, easy to use calculators that allow users to determine the irrigation water requirements of crops and landscapes with drop down menus of Texas High Plains and all FAO crop coefficients. Users can also sign up for automatic email notifications of customized weather data and irrigation recommendations to be sent anytime from once a week to every day. Other tools allow users to download weather and ETo data as well.

The website offers many features that users can access such as:

- Long-term averages of weather data and ETo for 19 locations in Texas
- Bulletin 6019 of Texas crop consumptive water data (useful for certain water planning and permitting activities)
- Weather station maintenance and wiring guidelines

The TexasET Network and Website was established in 1994 by Guy Fipps to support agricultural and landscape irrigation in the State of Texas. TexasET is a program of the Irrigation Technology Center and the Texas AgriLife Extension Service administered through the Biological and Agricultural Engineering Department at Texas A&M University in College Station, Texas.

## What is Evapotranspiration?

**Evapotranspiration (ET)** is a measurement of the total amount of water needed to grow plants and crops. This term comes from the words evaporation (i.e., evaporation of water from the soil) and transpiration (i.e., transpiration of water by plants). Different plants have different water requirements, so they have different ET rates.

To simplify the calculation of ET rates for individual plants and crops, the website reports the **potential Evapotranspiration, ETo** or **PET** (note: the potential evapotranspiration is referred to as both *ETo* and *PET*). ETo is the water requirements for a cool season grass growing 4-inches

tall under well-watered conditions. Crop and plant coefficients are then used along with ETo to determine the actual irrigation requirement (i.e., the "ET") of specific crops and plants. The technical term for this is the "**Potential Evapotranspiration of a Grass Reference Crop**" or "**ETo**" for short.

The TexasET website uses the standardized Penman-Monteith method to calculate ETo from the weather station data. This is one of a number of methods that can be used to determine ETo and ET. Several organizations, such as the International Committee on Irrigation and Drainage, the FAO (Food and Agricultural Organization) of the United Nations, and the American Society of Civil Engineers, have proposed establishing the Penman-Monteith method as a world-wide standard. Such a standard would help facilitate the sharing of ETo data and development of crop coefficients.

ETo depends on the climate and varies from location to location. Special weather stations are used to collect the climatic data for calculating ETo, including temperature, dew point temperature (relative humidity), wind speed, and solar radiation.

The water requirements of specific crops and turf grasses can be calculated as a fraction of the ETo. This "fraction" is called the crop coefficient (Kc) or turf coefficient (Tc). Crop coefficients vary depending on the type of plant and its stage of growth. Detailed information on crop and turf coefficients and how to use them is presented at other locations on this Web Site.

## Using the TexasET Website

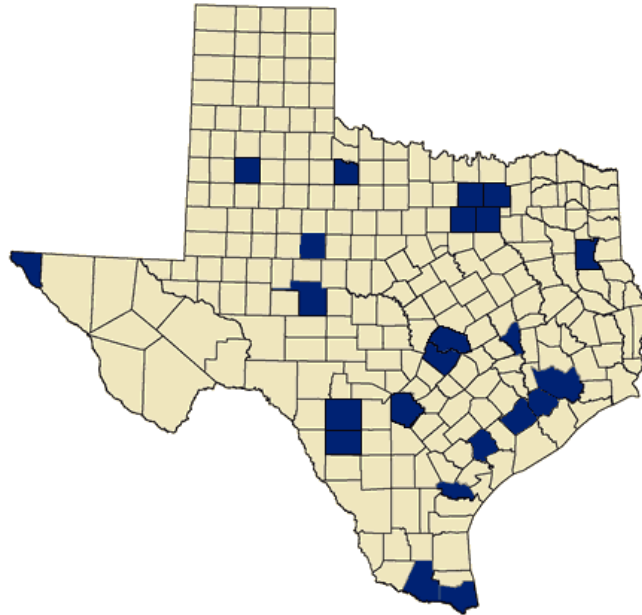

### Viewing the ET and Weather Data

Step 1. To Access the daily ET and Weather nearest to you click on the County (highlighted blue) nearest to you or use the **Current Stations** drop down menu.

A screenshot of the TexasET website interface. The top navigation bar includes the AgriLIFE EXTENSION logo, the text "A Project of the Irrigation Technology Center", and a search box. Below the navigation bar, there are four tabs: "Irrigation Technology Center", "Irrigation District Program", "School of Irrigation", and "TexasET Network". The main content area features a navigation menu on the left with links for Home, ET and Weather Data, Frequent TexasET Users, Weather Stations, Coefficients, Useful Information, Irrigation Demonstrations, Links, Contacts, and ET User Login. The main content area contains a heading "TexasET contains weather information, current and average evapotranspiration data, and irrigation watering recommendations." Below this heading are two dropdown menus labeled "Current Stations: Select a Station" and "Historic Stations: Select a Station". A paragraph of text explains that users can select a station from the dropdown menu, click on a station on the map, or log in with their profile. Below the text is a map of Texas with county boundaries and several counties highlighted in blue. The footer of the page includes copyright information for 2007, a search box, a contact link, and a webmaster link. A small disclaimer at the bottom of the page states that the TexasET network is partially supported through a federal program, the "Rio Grande Basin Initiative," and administered by the Texas Water Resources Institute of the Texas A&amp;M University System.

Step 2. Some counties contain multiple weather stations. In this case a second map will appear for you to choose from. Once you have chosen a station, click on the name.

The screenshot shows the AgriLIFE EXTENSION website interface. At the top, there is a navigation bar with the AgriLIFE EXTENSION logo and the text 'A Project of the Irrigation Technology Center'. Below this is a secondary navigation bar with links for 'Irrigation Technology Center', 'Irrigation District Program', 'School of Irrigation', and 'TexasET Network'. The main content area features a map titled 'Lower Rio Grande Valley' showing several weather stations. A legend at the bottom left of the map explains the symbols: a red diamond for 'Online', a yellow diamond for 'Temporarily Offline', and a blue diamond for 'Discontinued (Historical Data Only)'. The map also shows county boundaries for Hidalgo, Willacy, Cameron, and San Benito counties, along with major roads and cities like Harlingen, Weslaco, and San Juan.

Step 3. After you have clicked on a weather station, a 14 day ETo and weather summary will be displayed.

The screenshot displays the weather summary page for the Weslaco Center Weather Station. At the top, there are three tabs: 'Home Watering', 'Turf/Landscape Irrigation', and 'Crop Irrigation', each with a corresponding image. Below the tabs is a table titled 'Weslaco Center Weather Station' with the subtitle 'Station Sponsored by - Texas AgriLife Research'. The table provides a 14-day summary of weather data. The 14-day summary values are: ETo 2.53, Tmex 88, Tmin 69, RHmin 46, Solar 74.18, Rain 1.25, Wind 4am 1.17, and Wind 4pm 3.08. A note below the table states: 'Note: Reported are the average hourly values, not the absolute highs and lows.' Below the note are links for '3 day summary', '5 day summary', '7 day summary', and 'other day range'. At the bottom, there is a link for 'Detailed Weather and Heat Units'.

Date	ETo (in)	Tmex (F)	Tmin (F)	RHmin (%)	Solar (MJ/m <sup>2</sup> )	Rain (in)	Wind 4am (mph)	Wind 4pm (mph)
2008-09-30	0.19	89	66	30	28.36	0.00	0.09	2.00
2008-10-01	0.20	93	66	26	28.01	0.00	1.55	1.89
2008-10-02	0.19	89	68	41	26.15	0.00	0.56	1.82
2008-10-03	0.20	88	67	41	28.01	0.00	1.12	2.59
2008-10-04	0.18	87	68	48	23.10	0.00	0.47	4.00
2008-10-05	0.18	87	71	57	23.09	0.00	1.88	4.28
2008-10-06	0.20	89	74	42	24.04	0.00	2.36	3.85
2008-10-07	0.16	91	74	52	19.38	0.78	0.33	4.22
2008-10-08	0.19	83	65	27	27.99	0.01	0.85	3.39
2008-10-09	0.18	85	59	37	27.64	0.00	0.00	2.21
2008-10-10	0.19	88	66	51	26.59	0.00	0.85	2.65
2008-10-11	0.15	88	74	58	17.42	0.45	1.76	2.65
2008-10-12	0.16	87	76	65	19.03	0.00	3.40	4.32
2008-10-13	0.16	87	76	66	19.68	0.01	1.10	3.23
<b>14 Day Summary</b>	<b>2.53</b>	<b>88</b>	<b>69</b>	<b>46</b>	<b>74.18</b>	<b>1.25</b>	<b>1.17</b>	<b>3.08</b>

Other day summary periods such as 3 day, 5 day and 7 day can be selected using the link under the weather summary.

Step 4. By clicking on **Detailed Weather and Heat Units** under the weather summary, the following table comes up which gives detailed information on heat units and other weather data.

**Weslaco Center Weather Station**

Date	ET <sub>PET</sub> (in)	Temp (F) Avg	DewPoint (F)		Heat Units (F)			50 degree	55 degree	60 degree	Wind Run miles per day
			Max	Min	Corn	Cotton	Sorghum				
2008-09-30	0.19	77	51	36	26	18	23	28	23	18	0
2008-10-01	0.20	78	53	36	26	19	24	29	24	19	0
2008-10-02	0.19	77	50	37	27	18	23	28	23	18	0
2008-10-03	0.20	76	50	37	27	18	23	28	23	18	0
2008-10-04	0.18	77	49	37	27	17	22	27	22	17	0
2008-10-05	0.18	78	49	39	29	19	24	29	24	19	0
2008-10-06	0.20	80	51	41	30	22	27	32	27	22	0
2008-10-07	0.16	79	52	41	30	22	27	32	27	22	0
2008-10-08	0.19	74	47	35	24	14	19	24	19	14	0
2008-10-09	0.18	71	48	32	22	12	17	22	17	12	0
2008-10-10	0.19	76	50	36	26	17	22	27	22	17	0
2008-10-11	0.15	79	50	41	30	21	26	31	26	21	0
2008-10-12	0.16	80	50	42	31	22	27	32	27	22	0
2008-10-13	0.16	80	49	43	31	22	27	32	27	22	1
<b>14 Day Summary</b>	<b>2.53</b>	<b>77</b>	<b>50</b>	<b>38</b>	<b>386</b>	<b>261</b>	<b>331</b>	<b>401</b>	<b>331</b>	<b>261</b>	<b>3</b>

[3 day summary](#) | [5 day summary](#) | [7 day summary](#) | [other day range](#)

**Using the Irrigation Scheduling Tools**

Step 1. To use the Crop Irrigation Scheduling Tool, Click on the **Crop Irrigation** Button displayed above each weather summary.





The Crop Water Requirement Calculator will appear. (Note: to continue viewing the weather data click on **Show Weather Data** above the calculator). The calculator will automatically contain the total ETo for the last 14 days or the period chosen (i.e. 3 day summary, 7 day summary).

**Weslaco Center Weather Station**  
**Station Sponsored by : Texas AgriLife Research**  
[Show Weather Data](#)

**Crop Water Requirement Calculator**

---

**ETo(pet)**

1. ETo value from weather data  (in)

---

**Crop Selection**

2. Select a crop coefficient

FAO Coefficients

Or

Texas High Plains Coefficients

---

**Growth Stage**

3. Select a crop growth stage

---

**Crop Coefficient**

4. [Crop coefficient](#) from growth stage      Crop Coefficient =

---

**System Efficiency**

5. Enter your [system efficiency](#)      System Efficiency =  (%)

---

**Calculate your total watering requirement**

6.       Total Water Requirement (ET) =  (in)

Precipitation Rate	<input style="width: 30px;" type="text" value="0"/>	(in/hr)
Total Run Time	<input style="width: 30px;" type="text" value="0"/>	(min)
Irrigations/Week	<input style="width: 30px;" type="text" value="1"/>	(count)
Run Time/Irrigation	<input style="width: 30px;" type="text" value="0"/>	(min)

Step 2 . The next step is to select the crop that you are irrigating. The TexasET Website offers a variety of crop coefficients compiled by the Food and Agriculture Organization (FAO) as well as a short list of crop coefficients developed in the Texas High Plains.

The screenshot shows the 'Crop Water Requirement Calculator' interface. The 'Crop Selection' section is active, with a dropdown menu open. The menu lists various crops under three categories: 'a. Small Vegetables', 'b. Vegetables Solanum Family', and 'c. Vegetables Cucumber Family'. The 'Compute' button is visible, and the 'Total Water Requirement' field is empty.

Section	Value	Unit
ETo(pet)	2.53	(in)
ETo value from weather data	2.53	(in)
System Efficiency		
Precipitation Rate	0	(in/hr)
Total Run Time	0	(min)
Irrigations/Week	1	(count)
Run Time/Irrigation	0	(min)

Step 3. Once the crop is selected, choose the growth stage of the crop. In this example we will use Full Season Corn from the Texas High Plains Coefficients at the tassel stage of growth.

The screenshot shows the 'Crop Water Requirement Calculator' interface. The 'Growth Stage' section is active, with a dropdown menu open. The menu lists various growth stages under three categories: '2-Leaf', '4-Leaf', '6-Leaf', '8-Leaf', '10-Leaf', '12-Leaf', '13-Leaf and above', 'Tassel', 'Silk', 'Blister', 'Milk', 'Dough', 'Dent', '1/2 Mat', and 'Black Layer'. The 'Compute' button is visible, and the 'Total Water Requirement' field is empty.

Section	Value	Unit
ETo(pet)	2.53	(in)
ETo value from weather data	2.53	(in)
System Efficiency		
Precipitation Rate	0	(in/hr)
Total Run Time	0	(min)
Irrigations/Week	1	(count)
Run Time/Irrigation	0	(min)

Step 4. After selection of the stage of growth, the crop coefficient appears in the calculator.

**Crop Water Requirement Calculator**

---

**ETo(pet)**

1. ETo value from weather data  (in)

---

**Crop Selection**

2. Select a crop coefficient

FAO Coefficients

Or

Texas High Plains Coefficients

---

**Growth Stage**

3. Select a crop growth stage

---

**Crop Coefficient**

4. Crop coefficient from growth stage      Crop Coefficient =

---

**System Efficiency**

5. Enter your system efficiency      System Efficiency =  (%)

---

**Calculate your total watering requirement**

6.       Total Water Requirement (ET) =  (in)

Precipitation Rate  (in/hr)

Total Run Time  (min)

Irrigations/Week  (count)

Run Time/Irrigation  (min)

Step 5. Next enter the efficiency of your irrigation system. Some common efficiencies can be found by clicking on **system efficiency**.

**Typical Overall On-Farm Efficiencies  
For Various Types Of Irrigation Systems.**

System	Overall Efficiency
Surface	0.5-0.8
-average	0.5
-land leveling and delivery pipeline meeting desing standards	0.7
-tailwater recovery	0.8
-surge	0.6-0.9 <sup>1</sup>
Sprinkler	0.55-0.75 <sup>3</sup>
Center Pivot	0.55-0.90 <sup>3</sup>
LEPA	0.90-0.95
Drip	0.80-0.90 <sup>2</sup>

*footnotes:*

1. Surge has been found to increase efficiencies 8 to 28 percent over non-surge furrow systems.

2. Trickle systems are typically designed at 90 percent efficiency; short laterals (<100ft) or systems with pressure compensong emitters may have higher efficiencies.

3. Under low wind conditions.

Step 6. For our example we will use an efficiency of 90%. To calculate the total watering requirement, click on the **Compute** button. The Total Water Requirement for our crop is 3.37 inches.

Crop Water Requirement Calculator

ETo(pet)

1. ETo value from weather data  (in)

Crop Selection

2. Select a crop coefficient

FAO Coefficients

Or

Texas High Plains Coefficients

Growth Stage

3. Select a crop growth stage

Crop Coefficient

4. Crop coefficient from growth stage      Crop Coefficient =

System Efficiency

5. Enter your system efficiency      System Efficiency =  (%)

Calculate your total watering requirement

6.       Total Water Requirement (ET) =  (in)

Precipitation Rate	<input style="width: 50px;" type="text" value="0"/>	(in/hr)
Total Run Time	<input style="width: 50px;" type="text" value="0"/>	(min)
Irrigations/Week	<input style="width: 50px;" type="text" value="1"/>	(count)
Run Time/Irrigation	<input style="width: 50px;" type="text" value="0"/>	(min)

The Crop Water Requirement Calculator will also calculate the run time for your irrigation system. To calculate your systems run time enter the Precipitation Rate (in inches per hour) and the number of irrigation per week you will perform; then click the **Calculate Run Time** button and the Total Run Time and Run Time Per Irrigation will be Calculated.

Calculate your total watering requirement

6.       Total Water Requirement (ET) =  (in)

Precipitation Rate	<input style="width: 50px;" type="text" value="1.5"/>	(in/hr)
Total Run Time	<input style="width: 50px;" type="text" value="135"/>	(min)
Irrigations/Week	<input style="width: 50px;" type="text" value="1"/>	(count)
Run Time/Irrigation	<input style="width: 50px;" type="text" value="135"/>	(min)

## Frequent TexasET Users

Frequent TexasET Users have the ability to create a profile to setup multiple sites to have the option to receive automated emails with personalized watering recommendations.

### ***Creating a Login Profile***

To create a profile, click on Frequent TexasET Users on the left menu of the TexasET website, then click on Setup a Profile Now

The screenshot shows the TexasET website interface. At the top left is the AgriLIFE EXTENSION logo with the tagline 'Improving Lives. Improving Texas.' and 'Texas A&M System'. Below the logo is the date 'October 14, 2008'. A blue navigation bar contains 'Irrigation Technology Center', 'Irrigation District Program', and 'School of Irrigation'. A left sidebar menu lists: Home, ET and Weather Data, Frequent TexasET Users, Weather Stations, Coefficients, Useful Information, Irrigation Demonstrations, Links, Contacts, and ET User Login. The main content area is titled 'Create a Login Profile' and includes the text: 'By creating a profile, you can create multiple watering sites profiles with a single login, you also have the option to receive automated emails with personalized watering recommendations.' Below this is a link 'Setup a Profile Now'. A 'Login' section contains input fields for 'Email' and 'Password', and a 'Login' button. At the bottom, there is a footer with '©2007', 'Search', and 'Contact' links. A small disclaimer at the very bottom states: 'The TexasET Network is partially supported through a federal program, the "Rio Grande Basin Initiative," and administered by the Texas Water Resources Institute of the Texas A&M University System, Cooperative State Research, Education and Extension Service, U.S. Department of Agriculture under Agreement No. 2005-34461-15661 and Agreement No. 2005-45049-02209.'

Step 1. The next screen will ask for an email address. Enter your email address and click Check For Availability.

The following screens will walk you through the process of setting up a new account.

### **STEP 1: ENTER YOUR EMAIL ADDRESS**

EMAIL ADDRESS

**Check For Availability**

Step 2. If your email address is accepted, the following information is required.

Your email has been accepted.

**STEP 2: FILL IN ALL INFORMATION**

Email	<input type="text"/>
Password	<input type="text"/>
First Name	<input type="text"/>
Last Name	<input type="text"/>
Address	<input type="text"/>
City	<input type="text"/>
State	<input type="text"/>
Zip	<input type="text"/>

Agriculture and/or Landscape  Agriculture  Landscape

receive ET/weather summary by email

---

Step 3. Once you have entered all the user information and clicked that Agriculture box, Submit the information. The following box will appear. Go ahead and click on add site to continue.

[modify your user profile](#)

**Agriculture Sites - add site**

Step 4. To Create an Ag Site, enter-select the criteria for your site. The criteria are the same for using the online scheduling tools. Once everything is entered, click on Add Site and you will begin receiving emails on your selected days.

**EDIT AN AG SITE**

Description	<input type="text"/>
Station	<input type="text" value="Select a Station ..."/>
FAO Crop Coefficients	<input type="text" value="Select A Crop Type"/>
Or	
Texas High Plains Coefficients	<input type="text" value="Select A Crop Type"/>
Growth Stage	<input type="text" value="Initial"/>
System Efficiency	<input type="text"/> ex. 0-100
Day(s) in online weather summary	<input type="text"/> ex. 0-30
Day(s) to receive emails	<input type="checkbox"/> Mo <input type="checkbox"/> Tu <input type="checkbox"/> We <input type="checkbox"/> Th <input type="checkbox"/> Fr <input type="checkbox"/> Sa <input type="checkbox"/> Su
Would you like a weather summary in your emails?	<input type="radio"/> Yes, receive weather summary <input checked="" type="radio"/> No, only watering recommendations

---

Below is an example of the email you will receive.

Mail From: Texas Evapotranspiration Network <webmaster@texaset.tamu.edu>

File Edit View Actions Tools Window Help

Close Reply Forward

Mail Properties Personalize Message Source

From: Texas Evapotranspiration Network <webmaster@texaset.tamu.edu> 9/30/2008 8:11 AM  
To: Swanson, Charles  
Subject: Crop Watering Recommendations

  
Texas A&M System

[Your TexasET Profile Page](#)

Date	ETo	Maximum Temp	Minimum Temp	Minimum Humidity	Total Rainfall
09/26/2008	0.23	86	63	27	0.00
09/27/2008	0.20	86	58	25	0.00
09/28/2008	0.21	86	58	28	0.00
09/29/2008	0.22	87	59	26	0.00

**4 day watering recommendation for Charles Swanson: 0.57 inches  
(assuming no rainfall)\***  
**Weather Station: Wharton**  
**Crop: Soybeans**  
**Growth Stage: Not Selected**

NOTE: Reported are the average hourly values, not the absolute highs and lows.  
\* Adjust this water recommendations for any rainfall that you have received during this time period.

This information is provided by the Irrigation Technology Center, Texas AgriLife Extension Service, Texas A&M System. To discontinue receiving emails, you will need to change your account settings on the TexasET Website. Select the link "Your TexasET Profile Page" (to bring up your profile), select "Modify" for the site you wish to discontinue, then click "Delete Site." (Please contact us if you have any problems)

For questions or comments about this site [Contact Us](#)

## **Contacts**

If you have any questions about the TexasET Network contact:

### **Charles Swanson**

Extension Associate  
Texas AgriLife Extension  
2117 Texas A&M University  
College Station, TX 77843  
Phone: (979) 845-5614  
[clswanson@ag.tamu.edu](mailto:clswanson@ag.tamu.edu)

### **Dr. Guy Fipps**

Professor & Extension Specialist - Irrigation  
Department of Biological and Agricultural Engineering  
Texas A&M University  
College Station, TX 77843-2117  
(979)845-3977  
[g-fipps@tamu.edu](mailto:g-fipps@tamu.edu)





Decision Support Systems:  
Tools for Implementing  
Best Management Practices in Texas  
(EM-100)



## DECISION SUPPORT SYSTEMS:

Tools for Implementing Water Conservation  
Best Management Practices in Texas



EM 100

August 2007



# Precision Irrigators Network

Funded by  
**Texas Water Development Board**  
Contract # 2005-358-023

## Authors:

Josh Bynum, *Graduate Student, Department of Soil and Crop Sciences*  
Tom Cothren, *Professor, Department of Soil and Crop Sciences*  
Tom Marek, *Amarillo Research and Extension Center*  
Giovanni Piccinni, *Crop Physiologist, Uvalde Agricultural Research and Extension Center*

## Editing and Formatting:

Danielle Supercinski, *Communications Coordinator & Project Manager, Texas Water Resources Institute*  
Cecilia Wagner, *Project Manager, Texas Water Resources Institute*

Edited and published  
by the  
Texas Water Resources Institute  
1500 Research Parkway, Suite A240  
2118 TAMU  
College Station, TX 77843-2118

Texas Agricultural Experiment Station, Texas A&M University  
*Texas A&M Agricultural Research and Extension Center, Uvalde, TX 78801*  
<http://uvalde.tamu.edu/>  
Ph: 830.278.9151 Fax: 830.278.1570

*Texas A&M Agricultural Research and Extension Center, Amarillo, TX 79106*  
<http://amarillo.tamu.edu/>  
Ph: 806.677.5600 Fax: 806.677.5644

*Department of Soil and Crop Sciences, College Station, TX 77843*  
<http://soilcrop.tamu.edu/>  
Ph: 979.845.0360 Fax: 979.845.0456

*Texas Water Resources Institute, College Station, TX 77843*  
<http://twri.tamu.edu/>  
Ph: 979.845.1851 Fax: 979.845.8554

**Table of Contents**

Introduction .....1

Most Currently Developed DSS .....2

*TXHPET*.....2

*PIN* .....3

*CroPMan* .....3

Potential Cost and Water Savings from Adopting and Implementing a DSS .....3

How to Use DSS .....5

*Case 1 – TXHPET* .....5

*Case 2 – PIN* .....6

*Case 3 – CroPMan* .....8

Conclusion .....10

References .....11

## DECISION SUPPORT SYSTEMS:

### Tools for Implementing Water Conservation Best Management Practices in Texas

#### **Introduction**

Identifying best management practices (BMPs) promoting greater water use efficiency while maintaining crop yields is essential to the future of Texas cropping systems. Available water for irrigated crops is vital for sustaining crop production throughout the state. However, the availability of this water for irrigation is diminishing through competition by urban development and, in some regions such as the Edwards Aquifer, is falling under state regulation. The awareness and improvement of efficient irrigation and best management practices to conserve water while maintaining crop production will help preserve the aquifer levels and increase water savings to producers.

One component of BMPs for conserving water use is the application of decision support systems (DSS) that are used as tools for implementing irrigation BMPs. This DSS guide was developed as a complement to TWDB Report 362, “Water Conservation Best Management Practices Guide,” which is a more comprehensive report on water conservation including an “Agricultural Irrigation Water Use Management” BMPs section. The full TWDB Report 362 can be found at: <http://www.twdb.state.tx.us/assistance/conservation/consindex.asp>.

DSS include the Texas High Plains Evapotranspiration Network (TXHPET), the Precision Irrigators Network (PIN) and the Crop Production Management (CroPMan) model. These DSS strive to promote grower awareness of water conservation strategies. Irrigation conservation strategies are proposed to result in savings of approximately 1.4 million acre-feet per year by 2060 (TWDB and TWRI).

TXHPET operates 18 meteorological stations located in 15 counties across the Texas North Plains and Texas South Plains. The regional coverage of TXHPET is estimated at 4 million irrigated acres. The network offers insight to evapotranspiration (ET)-based crop water use that producers and agricultural consultants can reference when making decisions on when and how much to irrigate their crops. This information is available to data users via fax or online (<http://txhighplainset.tamu.edu>) and currently results in approximately 300,000 downloads or faxes annually.

The PIN program was formed in 2004 with a goal of saving millions of gallons of water annually by reducing irrigation water use by as much as 20 percent over several years and currently supports several crops (corn, cotton, sorghum, wheat) in seven counties of South Central Texas. Cooperation of the PIN programs consists of area producers, Texas Agricultural Experiment Station researchers, Texas Cooperative Extension personnel, San Antonio Water System, Edwards Aquifer Authority, Texas Water Resources Institute, Texas Water Development Board, Uvalde County Underground Water Conservation District and Wintergarden Water Conservation District. The PIN database will allow producers to gain historical and real-time information for better management of irrigation scheduling. The PIN program estimates that when all irrigators in the Edwards Aquifer region implement limited irrigation scheduling, approximately 50,000 to 60,000 acre-feet of water can be saved per year and made available for purposes other than agriculture.

CroPMan is a computer model designed to aid producers and agricultural consultants in optimizing crop management and maximizing production and profit through a production-risk approach. CroPMan will help growers identify limitations to crop yield, assist in making replant decisions and help recognize management practices that reduce the impact of agriculture on soil erosion and water quality. CroPMan is a Windows-based application program that can be downloaded from the CroPMan Web site (<http://cropman.brc.tamus.edu>).

## Most Currently Developed DSS

### *TXHPET*

Total crop water demand can be estimated by ET. ET represents the combination of water lost through evaporation of moist soil and wet surfaces, and the water lost through plant leaves by transpiration. Data collected from the 18 weather stations that make up the TXHPET are used to calculate daily reference crop (well-watered grass or alfalfa) ET. Based on the ET of the reference crop, specific ET values for individual crops are then produced.

For example, when using TXHPET, sum up the daily ET values from the nearest weather station for your crop of interest for a week. If no rainfall occurred during the week to replenish the crop water demand, the summation of ET is the amount of irrigation required to prevent crop stress. The use of TXHPET allows producers the ability to make in-season irrigation decisions.

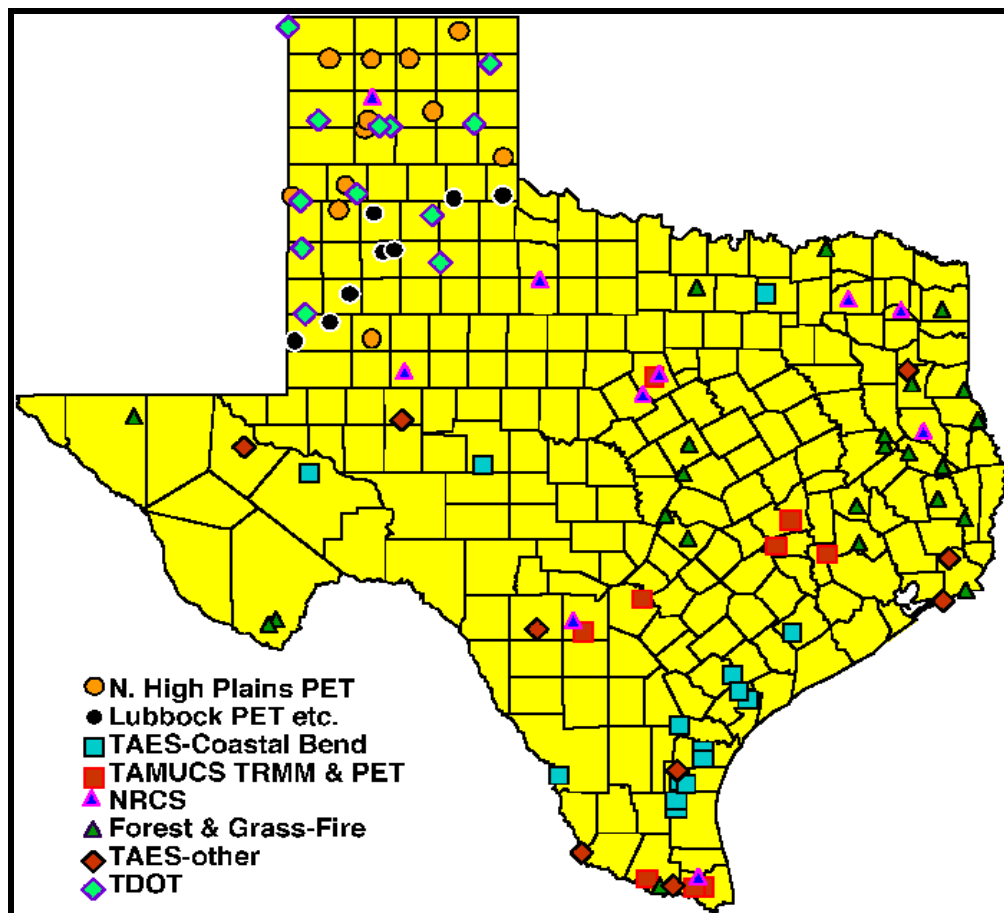

Figure 1. PET networks across Texas provide regional data to guide producers' irrigation decisions.

***PIN***

The formation of PIN has greatly impacted producer awareness of water conserving strategies. The increasing value of water in the Edwards Aquifer region has challenged PIN to search for management practices allowing efficient crop water use. Data in the Edwards Aquifer region suggests that ET overestimates the amount of irrigation needed (Falkenberg et al., 2006). Water savings in this region are possible without depletion of yield when only 75 percent of the ET is replenished with irrigation. The PIN program allows producers to precisely manage their irrigation scheduling in-season in a way that maximizes their returns and ensures irrigation water for coming years.

***CroPMan***

CroPMan is a Windows-based computer application model that can simulate crop management practices and climatic and edaphic conditions allowing producers to see the impact on crop yield, soil properties, soil erosion, profitability and nutrient/pesticide fate. CroPMan permits agricultural consultants and producers to form strategic assessments over years for best management practices and also allows them to run real-time analysis to determine the amount and timing of irrigation. Of the DSS discussed, CroPMan is the only system that allows producers the advantage of long-term planning for the future.

**Potential Cost and Water Savings from Adopting and Implementing a DSS**

Crop	Current mean water usage <i>inches/acre/year</i>	Simulated water usage to maintain yield at current water usage under varying irrigation types <i>inches/acre/year</i>			Irrigated crop acreage in region <sup>1</sup> <i>Acres</i>	Potential water savings <sup>2</sup> <i>acre-ft/year</i>		
		Furrow	Sprinkler-LEPA	Buried Drip (12")		Furrow	Sprinkler-LEPA	Buried Drip (12")
Corn	24	14	14	12	54100	45083	45083	54100
Cotton	21	19	19	17	62000	10333	10333	20667
Grain Sorghum	18	10	10	8	95500	63667	63667	79583
Sugarcane	30	24	22	22	40500	20250	27000	27000

1 Data collected from the NASS 2005 census data in Cameron, Willacy, Hidalgo and Starr counties.

2 Water savings for each irrigation type is based on total acreage of crop.

**Table 1. Potential water savings while maintaining yield from implementing decision support systems.**

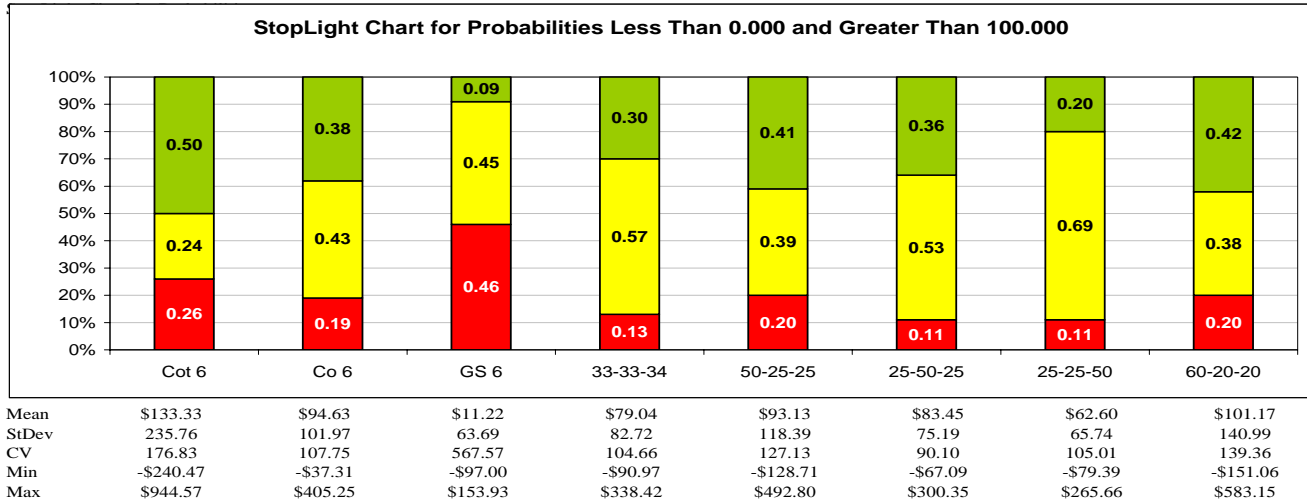

**Figure 2. Probabilities for net returns associated with the percent of total irrigation water available applied to either cotton, corn or grain sorghum.**

Figure 2 indicates the probability of net returns based on the percentage of acres planted to cotton, corn and/or grain sorghum based on 2 acre-feet per year of available irrigation. The red indicates the probability that net returns will be less than \$0.000 per acre, yellow indicates net returns ranging from \$0.000 to \$100.000 per acre, and green indicates the probability of net returns exceeding \$100.000 per acre. The first bar represents a farmer placing all his/her acres in cotton production. The second bar displays the probability for returns if a producer chooses to grow corn on all his/her acres. The third bar corresponds to the probability of net returns per acre if all the acres are planted to grain sorghum. The rest of the bars indicate the probability of net returns if producers' acres are split into cotton, corn and grain sorghum. The numbers on the x-axis below each bar represent the percent of total acres planted to cotton, corn or grain sorghum. For example, the bar on the far right is the probability of net returns when 60 percent of the acres are planted to cotton, 20 percent are planted to corn and 20 percent are planted to grain sorghum.



## How to Use a DSS

### Case 1 - TXHPET

#### Steps:

1. To look at daily water use and other climatic factors for your region, go to <http://txhighplainset.tamu.edu>.
2. From the homepage (Figure 3) click on the Weather Data tab.

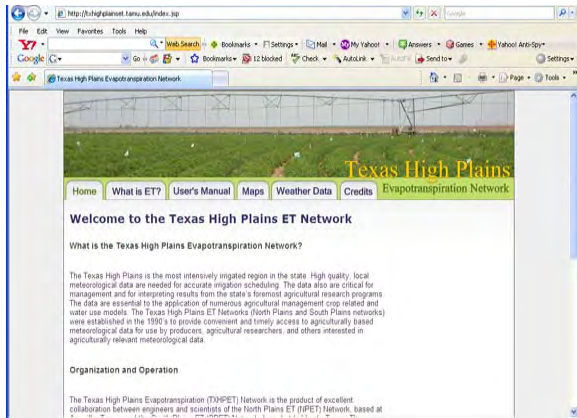

**Figure 3. Homepage of the Texas High Plains Evapotranspiration Network (<http://txhighplainset.tamu.edu>).**



**Figure 4. Options for daily reading data.**

3. Once weather data has been selected, click on “Daily” to receive daily readings.
4. The Daily Weather Page (Figure 4) will open and ask the user to select a location, type of data (i.e. crop water use), dates for viewing, units of measurement and how the users want to view the data.
5. After the information is submitted a data report will be generated. For example, Figure 5 is the result of selecting Dalhart as the location, water use for short-season corn during the time range of May 1, 2007 through May 13, 2007. The units selected are English and the report is in table format.

**Data Table**

Starting Date: 5 / 1 / 2007 0 : 0 am      Ending Date: 5 / 13 / 2007 0 : 0 am      Units: english

Page 1 of 1

**Dalhart**

Date	Cm PD1 SS (in.)
05/01/2007	0.07
05/02/2007	0.03
05/03/2007	0.06
05/04/2007	0.08
05/05/2007	0.08
05/06/2007	0.07
05/07/2007	0.07
05/08/2007	0.04
05/09/2007	0.06
05/10/2007	0.08
05/11/2007	0.11
05/12/2007	0.11
05/13/2007	0.12

**Figure 5. Short-season corn water use in Dalhart, Texas, for May 1 through May 13, 2007.**

When using tables such as that in Figure 5 as a guide for making irrigation decisions, sum the water-use column and subtract the amount of rainfall received by the farm of interest. If the number is less than zero, no irrigation is needed. If the number is above zero, that is the amount of irrigation needed to prevent crop-water stress.

**Case 2 – PIN**

Precise calculation of ET is crucial to meeting the proper water demand by the crop. Figure 6 illustrates several methods and their calculation of ET throughout part of the corn growing season.

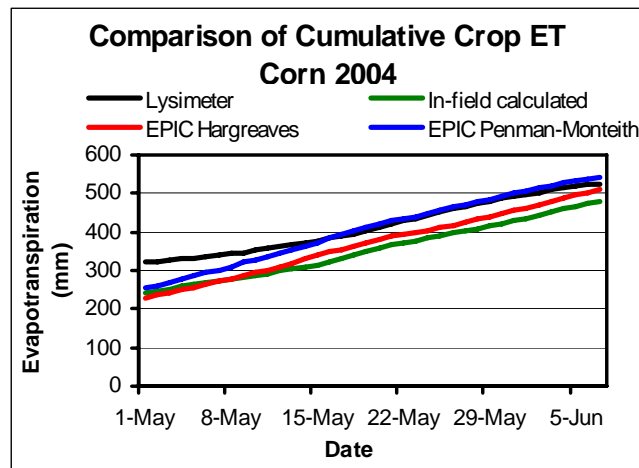

Figure 6. Calculation of evapotranspiration of corn using four different methods.

**Steps:**

1. To calculate or determine ET, go to the Texas A&M University Agricultural Research and Extension Center at Uvalde homepage at <http://uvalde.tamu.edu>.

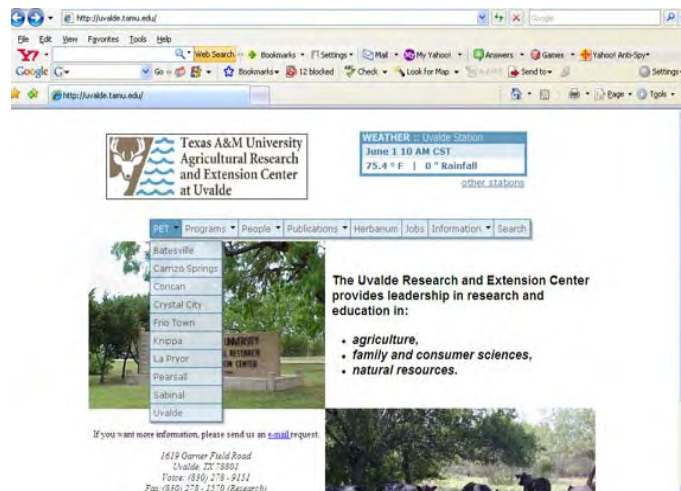

Figure 7. Agricultural Research and Extension Center Web site homepage at <http://uvalde.tamu.edu>.

2. On the homepage (Figure 7), click PET and select the county nearest your location of interest. For example if your farm is located in Uvalde County, click on Uvalde.
3. Click on the date of interest to identify the crop-water use and climate for that date. In the example below, May 17, 2007, was selected for determination of cotton water use.

COTTON						
Water Use						
Seed Date	Acc GDD	Growth Stage	Day	3day	7day	Seas. in.
			----in/d----			
03/15	511	1st Sqr	.09	.09	.08	1.8
03/25	410	1st Brch	.06	.06	.05	1.3
04/05	297	Emerged	.04	.05	.05	0.8
04/15	250	Emerged	.04	.05	.05	0.6

Figure 8. Water use table for cotton selected for May 17, 2007.

When reading the table as in Figure 8, users should choose the date that most closely approximates their planting date. The “Growth Stage” column should be close to the maturity of the user’s crop. The “Day” column represents the amount of ET lost by the crop for May 17. The “3 day” and “7 day” columns are the average daily ET for the previous 3 and 7 days, respectively. The “Seas. in.” column reports the total water lost through ET for the growing season up to May 17.

When making irrigation decisions, sum the amount of daily ET for a given number of days. If the amount of daily ET is not replenished by rainfall, then that is the amount of irrigation required to prevent crop water stress.

**Case 3 – CroPMan**

Implementing CroPMan must first begin with calibration to the user’s region. Ongoing research is being conducted to validate CroPMan in all regions of Texas. The validation procedure uses actual measured yield points in comparison with CroPMan simulated yields. An example of sugarcane yield validation in the Lower Rio Grande Valley can be seen in Figure 9.

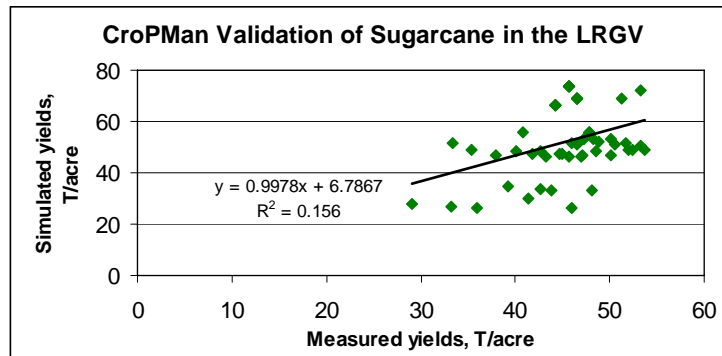

Figure 9. Validation of CroPMan for sugarcane yields using research data.



Figure 10. The CroPMan homepage at <http://cropman.brc.tamus.edu>.

Steps:

1. From the homepage (Figure 10), click on “Decision Aids” and then select “IRRIG-AID.” The irrigation strategy worksheet (Figure 11) will appear.
2. When all the necessary worksheets are filled in a profit analysis of irrigated crops spreadsheet (Figure 12) is generated to guide producers in the best management decision for their crop.

Irrigation Strategy Worksheet for Lower Rio Grande Valley Irrigators							
1							
2	<b>DIRECTIONS:</b>						
3	1. Fill in <i>ONLY</i> the blue boxes to create your irrigation strategy outcomes.						
4	2. Choose 'Print' or 'Print Preview' from the File Menu to print and/or view your Worksheet Summary Report.						
5	Producer Name:	AEC FARMS				DATE:	5/30/2006
6	<i>(Optional)</i>						
7							
8	Counties (for Selection of Soil Type):						
9	<i>SELECT County:</i>						
10	Cameron	Cameron					
11	Hidalgo						
12	Starr						
13	Willacy						
14							
15	Soil Type (%sand) and Salt Level (parts per million):						
16	<i>SELECT Soil Type and Salt Level:</i>						
17	Percent Sand in topsoil (%)	10				% sand *	
18	Salt content of irrigation water (ppm)	700				ppm	
19	* See soils list for %sand value ==>						
20							
21	Weather Stations (RAINFALL):						
22	<i>SELECT Weather Station:</i>						
23	Harlingen	Harlingen					
24	McAllen						
25	Raymondville						
26	Rio Grande City						
27							
28	Irrigation Strategies:						
29	Enter TOTAL Irrigation Water Available for Growing/Pumping Season (OPTIONAL)	1800				inches	
30	Enter Total Crop Acreage for each Crop						
31	Irrigated Crop Alternatives:	Growing Season			Enter	Total Irrigations	
32	<i>SELECT Irrigation Amount for one or more Period(s) of the Growing Season</i>	Quarter I	Quarter II	Quarter III	Total Crop	Applied**	
33	<i>for two or more Competing Crops (inches):</i>	(inches/ac)	(inches/ac)	(inches/ac)	Acreage	(acres)	
34	Cotton Irrigations	6.0	6.0	6.0	100	1800	
35	Corn Irrigations	6.0	6.0	6.0	100	1800	
36	Grain Sorghum Irrigations	0.0	0.0	0.0	100	0	
37							
38							
39	Fertilizer Application:						
40	<i>Enter the Amount of Nitrogen you wish to use to Estimate Yield and Fertilizer Cost</i>						
41	Amount of N applied as sole-source fertilizer (ex. urea or anhydrous ammonia)	Cotton-lbs/ac	Corn-lbs/ac	Sorghum-lbs/ac			
42	Amount of Fertilizer Mix Applied	50.0	175.0	25.00			
43	Percent N (%) of Fertilizer Mix, ex. 20-10-10=20%, 10-20-10=10%, etc.	50.0	100.0	0.00			
44	Total Amount of Nitrogen Applied	10.0	10.0	0.00			
45		55.0	185.0	25.00			
46	Expected Product Price and LDP:						
47	Cotton lint income, \$/lb	Loan Defcy. Pmt	Selling Price	Total			
48	Corn income, \$/bu	\$ 0.00	\$ 0.55	\$ 0.63	per pound		
49	Sorghum income, \$/cwt	\$ 0.25	\$ 3.00	\$ 3.25	per bushel		
50		\$ 0.50	\$ 4.25	\$ 4.75	per 100 lbs		
51	Yield Estimates:						
52	<i>Irrigation Strategies:</i>						
53	<i>No irrigations - (OPTIONAL): ENTER historical dryland yield and proceed to next row</i>	Predicted Yields					
54	<i>No irrigations - SELECT the baseline yield (either your yield or the estimated yield)</i>	Cotton (bales/ac)	Corn (bu/ac)	Sorghum (lbs/ac)			
55		0.5	0	3,000			
56		1.0	0	2,877			
57	One application during the 1st Quarter of Growing Season	0.0	0	0			
58	One application during the 2nd Quarter of Growing Season	0.0	0	0			
59	One application during the 3rd Quarter of Growing Season	0.0	0	0			
60	Two applications during the 1st+2nd Quarter of Growing Season	0.0	0	0			
61	Two applications during the 1st+ 3rd Quarter of Growing Season	0.0	0	0			
62	Two applications during the 2nd+3rd Quarter of Growing Season	0.0	0	0			
63	Full Irrigation: Three applications during the 1st, 2nd and 3rd Quarters	3.8	119	0			
64	Percentage yield adjustment for insect, disease, weed, poor stand, or storm damage:						
65	<i>Irrigation Strategies:</i>						
66	Percentage yield adjustment by crop	Percent					
67		Cotton	Corn	Sorghum			
68		5	3	7			
69	Adjusted Yield Estimates:						
70	<i>Irrigation Strategies:</i>						
71	Adjusted Yield Estimates	Adjusted Yields					
72		Cotton (bales/ac)	Corn (bu/ac)	Sorghum (lbs/ac)			
73		3.6	115.2	2,675.5			
74	Value of Irrigation Water per Unit Applied:						
75	<i>Irrigation Strategies:</i>						
76	Unit value of first application during the 1st Quarter of Growing Season	Unit Value of Water					
77	Unit value of first application during the 2nd Quarter of Growing Season	Cotton (\$/in)	Corn (\$/in)	Sorghum (\$/cwt)			
78	Unit value of first application during the 3rd Quarter of Growing Season	\$0.00	\$0.00	\$0.00			
79	Unit value of second QTR application after a 1st Quarter Irrigation (Q1 & Q2)	\$0.00	\$0.00	\$0.00			
80	Unit value of third QTR application after a 1st Quarter Irrigation (Q1 & Q3)	\$0.00	\$0.00	\$0.00			
81	Unit value of third QTR application after a 2nd Quarter Irrigation (Q2 & Q3)	\$0.00	\$0.00	\$0.00			
82	Unit value of third QTR application after 1st and 2nd Quarter Irrigations	\$47.16	\$10.25	\$0.00			
83	* Conversion based on 480 lbs/bale.						
84							
85							
86							

Figure 11. Irrigation strategy worksheet for Lower Rio Grande Valley irrigators.

	A	B	C	D	E
1	<b>PROFIT ANALYSIS OF IRRIGATED CROPS</b>				
2	<i>Fill in ONLY the blue boxes to calculate your Profit Analysis</i>				
3	<b>Income:</b>		<b>Cotton</b>	<b>Corn</b>	<b>Sorghum</b>
4	<b>Per Acre</b>		<b>(\$/ac)</b>	<b>(\$/ac)</b>	<b>(\$/ac)</b>
5	Dryland	-	\$ -	\$ -	\$ 127.09
6	One application during the 1st Quarter of Growing Season	-	\$ -	\$ -	\$ -
7	One application during the 2nd Quarter of Growing Season	-	\$ -	\$ -	\$ -
8	One application during the 3rd Quarter of Growing Season	-	\$ -	\$ -	\$ -
9	Two applications during the 1st+2nd Quarter of Growing Season	-	\$ -	\$ -	\$ -
10	Two applications during the 1st+ 3rd Quarter of Growing Season	-	\$ -	\$ -	\$ -
11	Two applications during the 2nd+3rd Quarter of Growing Season	-	\$ -	\$ -	\$ -
12	Full Irrigation: Three applications during the 1st, 2nd and 3rd Quarters	-	\$ 1,091.89	\$ 374.49	\$ -
13					
14					
15	<b>Expenses:</b>		<b>Irrigation cost</b>		<b>Irrigation cost</b>
16	<b>Per Acre</b>	<b>\$/Unit</b>	<b>Based on Fuel Type</b>		<b>ENTER Your estimate</b>
17	Select Fuel Type (Option: To customize go to "IRRG COST CALC" SHEET)	None	\$ -	OR	\$ 1.50
18	cost per acre/finch				
19			<b>Cotton</b>	<b>Corn</b>	<b>Sorghum</b>
20	Select Irrigation Cost/finch	\$ 1.50	(\$/ac)	(\$/ac)	(\$/ac)
21	Fertilizer (N costs only) Unit Cost/lb	\$ 0.40	\$ 27.00	\$ 27.00	\$ -
22	Mixed Fertilizer (Other excluding N) Total Cost/ac		\$ 22.00	\$ 74.00	\$ 10.00
23	Additional or Other Costs/ac (see note below)		\$ 8.00	\$ 16.00	\$ -
24	Annual Interest Rate (6 months interest expense)	7.00%	\$ 268.79	\$ 78.19	\$ 58.71
25	Total	-	\$ 11.40	\$ 6.83	\$ 2.40
26			\$ 337.19	\$ 202.02	\$ 71.11
27	<b>Net Income:</b>		<b>Cotton</b>	<b>Corn</b>	<b>Sorghum</b>
28	<b>Per Acre</b>				
29	Net Income (\$/ac)		\$ 754.70	\$ 172.47	\$ 55.97
30	Total Crop Acreage (acres)		100	100	100
31	<b>TOTAL Net Income (\$)</b>		\$ 75,469.69	\$ 17,246.85	\$ 5,597.33
32	Additional Costs for Irrigated Crops: Cotton=\$268.79, Corn=\$78.19, Sorghum=\$80.79				
33	Additional Costs for Dryland Crops: Cotton=\$188.78, Sorghum=\$58.71				
34	<a href="http://agecoext.tamu.edu/budgets/district/12/2006/">http://agecoext.tamu.edu/budgets/district/12/2006/</a>				
35	Visit this site to review/update cost estimates for additional costs				

Figure 12. Profit analysis of irrigated crops.

### Conclusion

Producers must begin exercising best management practices to ensure the sustainability of their farm for future years. The above mentioned DSS will aid producers in managing their production risk, while maintaining profitable yields and conserving irrigation water. By implementing the above DSS, producers will be making educated, economically sound decisions on which crop to plant, how much and when to apply irrigation, and other crop management decisions in an effort to maximize water use efficiency and profits.

## **References**

Falkenburg, N.R., G. Piccinni, J.T. Cothren, D.I. Leskovar, and C.M. Rush. 2006. Remote sensing of biotic and abiotic stress for irrigation management of cotton. *J. Agri. Water Management* 87:23-31.

Porter, D., T. Marek, T. Howell, L. New. 2005. *The Texas High Plains Evapotranspiration Network User Manual*. AREC 05-37.

Schattenberg, P. 2004. Group 'PIN'-pointing irrigation use to conserve water, profit. AgNews. Retrieved May 3, 2007. <http://agnews.tamu.edu/dailynews/stories/SOIL/Dec1604a.htm>

Smith, R. 2001. CroPMan offers growers super model. *Southwest Farm Press*. Retrieved May 3, 2007. [http://southwestfarmpress.com/mag/farming\\_cropman\\_offers\\_growers/](http://southwestfarmpress.com/mag/farming_cropman_offers_growers/)

TWDB and TWRI. 2006. An Assessment of Water Conservation in Texas Prepared for the 80th Texas Legislature. Retrieved June 27, 2007. [http://www.twdb.state.tx.us/publications/reports/TWDBTSSWCB\\_80th.pdf](http://www.twdb.state.tx.us/publications/reports/TWDBTSSWCB_80th.pdf).



# *Soil Moisture Management and Monitoring*

## **In this Section**

Overview: Soil Moisture Management & Monitoring

Reference: Soil Moisture Management (B-1670)

Reference: Irrigation Monitoring with Soil Water Sensors (B-6194)

Reference: Estimating Soil Moisture by Feel and Appearance (1619)

## **Overview**

### **Objectives:**

- Increase understanding of soil physical properties that affect soil moisture storage and permeability.
- Increase familiarity with local soils and their characteristics, as well as information resources addressing local soils.
- Apply these concepts to optimizing water management in crop production.

### **Key Points:**

1. Soil permeability is affected by soil texture, structure, and moisture.
2. Plant available water in the root zone is that which can be stored in the soil between field capacity and permanent wilting point. Plant available water is soil-specific.
3. Water in soil is subjected to gravity, osmotic potential (suction), and matric (or capillary) potential (suction).
4. There are several methods available for measuring or estimating soil moisture. These include gravimetric (oven dry), soil feel and appearance, resistance (gypsum blocks or WaterMark™ sensors), tensiometry, capacitance, and other methods. Factors affecting selection of soil moisture monitoring method include costs, convenience, ease of use, precision and accuracy required, and personal preference of the operator.





## *Soil Moisture Management and Monitoring*

### **Assess your knowledge:**

1. Describe three methods for measuring soil moisture. Discuss advantages and limitations of each.
2. Describe how soil structure can affect permeability.
3. Describe how cultural practices (tillage, cropping patterns, etc.) can affect permeability.
4. Estimate the total water available in the following example:  
*(Example problem based upon local soils)*



# Soil Moisture Management and Monitoring

## Soil Moisture Storage Capacity

**Soil moisture characteristics:** A soil's capacity for storing moisture is affected by soil structure and organic matter content, but it is determined primarily by soil texture.

**Field capacity** is the soil water content after soil has been thoroughly wetted when the drainage rate changes from rapid to slow. This point is reached when all the gravitational water has drained. Field capacity is normally attained 2-3 days after irrigation and reached when the soil water tension is approximately 0.3 bars (30 kPa or 4.35 PSI) in clay or loam soils, or 0.1 bar in sandy soils.

**Permanent wilting point** is the soil moisture level at which plants cannot recover overnight from excessive drying during the day. This parameter may vary with plant species and soil type and is attained at a soil water tension of 10-20 bars. Hygroscopic water is held tightly on the soil particles (below permanent wilting point) and cannot be extracted by plant roots.

**Plant available water** is retained in the soil between field capacity and the permanent wilting point. It is often expressed as a volumetric percentage or in inches of water per foot of soil depth. Approximate plant available water storage capacities for various soil textures are shown below.

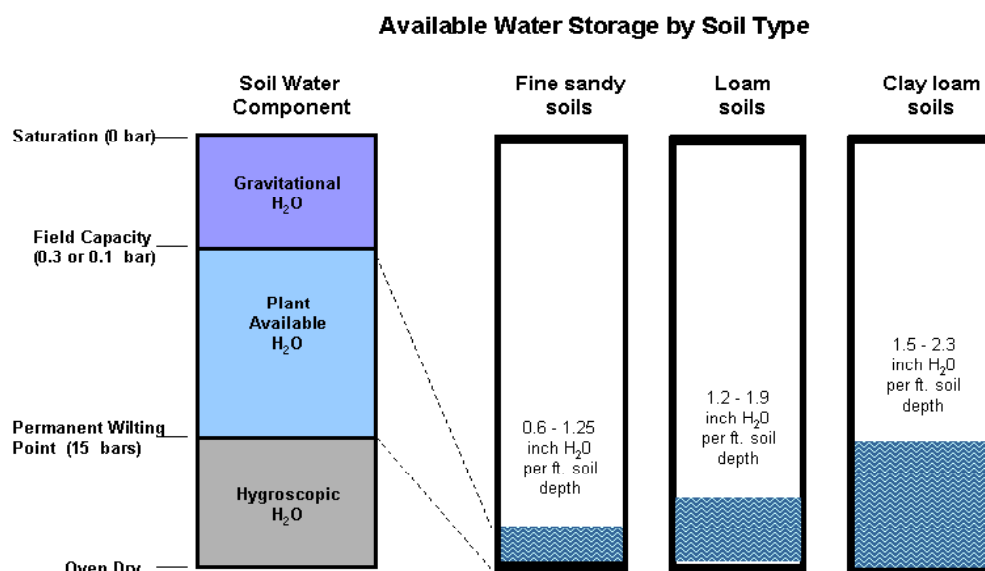

\* Compiled by Dana Porter, PhD, PE, Department of Biological and Agricultural Engineering and Texas A&M AgriLife Research and Extension Center – Lubbock.



# Soil Moisture Management and Monitoring

If the goal is to apply water to moisten the root zone to some target level (75% field capacity, for instance, depending upon local factors), it is essential to know how much water the soil will hold at field capacity, and how much water is already in the soil. Estimating soil moisture can be accomplished through direct methods (gravimetric soil moisture determination) or indirect methods. Soil moisture monitoring instruments, including gypsum blocks and tensiometers, provide the means to estimate soil moisture quickly and easily. Alternately, a soil's moisture condition can be assessed by observing its feel and appearance. A soil probe, auger, or spade may be used to extract a small soil sample within each foot of root zone depth. The sample is manually gently squeezed to determine whether the soil will form a ball or cast, and whether it leaves a film of water and/or soil in the hand. Pressing a portion of the sample between the thumb and forefinger allows one to observe whether the soil will form a ribbon. Results of the sample are compared with the following guidelines.

*Table 1. How soil feels and looks at various soil moisture levels*

Soil moisture level	Fine sand, loamy fine sand	Sandy loam, fine sandy loam	Sandy clay loam, loam, silt loam	Clay loam, clay, silty clay loam
<b>0 - 25% available soil moisture</b>	Appears dry; will not retain shape when disturbed or squeezed in hand.	Appears dry; may make a cast when squeezed in hand but seldom holds together.	Appears dry. Aggregates crumble with applied pressure.	Appears dry. Soil aggregates separate easily, but clods are hard to crumble with applied pressure.
<b>25 - 50% available soil moisture</b>	Slightly moist appearance. Soil may stick together in very weak cast or ball.	Slightly moist. Soil forms weak ball or cast under pressure. Slight staining on finger.	Slightly moist. Forms a weak ball with rough surface. No water staining on fingers.	Slightly moist; forms weak ball when squeezed, but no water stains. Clods break with applied pressure.
<b>50 - 75% available soil moisture</b>	Appears and feels moist. Darkened color. May form weak cast or ball. Leaves wet outline or slight smear on hand.	Appears and feels moist. Color is dark. Forms cast or ball with finger marks. Will leave a smear or stain and leaves wet outline on hand.	Appears and feels moist and pliable. Color is dark. Forms ball and ribbons when squeezed.	Appears moist. Forms smooth ball with defined finger marks; ribbons when squeezed between thumb and forefinger.
<b>75 - 100% available soil moisture</b>	Appears and feels wet. Color is dark. May form weak cast or ball. Leaves wet outline or smear on hand.	Appears and feels wet. Color is dark. Forms cast or ball. Will smear or stain and leaves wet outline on hand; will make weak ribbon.	Appears and feels wet. Color is dark. Forms ball and ribbons when squeezed. Stains and smears. Leaves wet outline on hand.	Appears and feels wet; may feel sticky. Ribbons easily; smears and leaves wet outline on hand. Forms good ball.



# Soil Moisture Management and Monitoring

**Root zone depth:** Roots are generally developed early in the season, and will grow in moist (not saturated or extremely dry) soil. Soil compaction, caliche layers, perched water tables, and other impeding conditions will limit the effective rooting depth. Most crops will extract most (70% - 85%) of their water requirement from the top one to two feet of soil, and almost all of their water from the top 3 feet of soil, if water is available. Deep soil moisture is beneficial primarily when the shallow moisture is depleted to a water stress level. Commonly reported effective root zone depths by crop are listed in Table 2.

*Table 2. Root zone depths reported for various crops*

Crop	Approximate Effective Rooting Depth (feet)
Alfalfa	3.3 – 6.6+
Corn	2.6 – 5.6
Cotton	2.6 – 5.6
Peanut	1.6 – 3.3
Sorghum	3.3 – 6.6

*\*These values represent the majority of feeder roots.*

**Permeability** is the ability of the soil to take in water through infiltration. A soil with low permeability cannot take in water as fast as a soil with high permeability; the permeability therefore affects the risk for runoff loss of applied water. Permeability is affected by soil texture, structure, and surface condition. Generally speaking, fine textured soils (clays, clay loams) have lower permeability than coarse soils (sand). Surface sealing, compaction, and poor structure (particularly at or near the surface) limit permeability.

## Using Soil Moisture Information to Improve Irrigation Efficiency

Deep percolation losses are often overlooked, but they can be significant. Water applied in excess of the soil's moisture storage capacity can drain below the crop's effective root zone. In some cases, periodic deep leaching is desirable to remove accumulated salts from the root zone. But in most cases, deep percolation losses can have a significant negative impact on overall water use efficiency - even under otherwise efficient irrigation practices such as low elevation precision application (LEPA) and subsurface drip irrigation (SDI) irrigation. Furrow irrigation poses increased deep percolation losses at upper and lower ends of excessively long runs. Surge irrigation can improve irrigation distribution uniformity, and hence reduce deep percolation losses. Coarse soils are particularly vulnerable to deep percolation losses due to their low water holding capacity. Other soils may exhibit preferential flow deep percolation along cracks and in other channels formed under various soil structural and wetting pattern scenarios.

Runoff losses occur when water application rate (from irrigation or rainfall) exceeds soil permeability. Sloping fields with low permeability soils are at greatest risk for runoff losses. Vegetative cover, surface conditioning (including furrow dikes), and grade management (land leveling, contouring, terracing, etc.) can reduce runoff losses. Irrigation equipment selection (nozzle packages) and management can also help to minimize runoff losses.



# *Irrigation Scheduling: Soil Moisture Management and Monitoring*

## **Soil Water Measurement\***

Methods used to measure soil water are classified as direct and indirect. The direct method refers to the gravimetric method in which a soil sample is collected, weighed, oven-dried and weighed again to determine the sample's water content on a mass percent basis. The gravimetric method is the standard against which the indirect methods are calibrated. Some commonly used indirect methods include electrical resistance, capacitance and tensiometry.

**Electrical resistance methods** include gypsum blocks or granular matrix sensors (more durable and more expensive than gypsum blocks) that are used to measure electrical resistance in a porous medium. Electrical resistance increases as soil water suction increases, or as soil moisture decreases. Sensors are placed in the soil root zone, and a meter is connected to lead wires extending above the ground surface for each reading. For most on-farm applications, small portable handheld meters are used; automated readings and controls may be achieved through use of dataloggers.

**Capacitance sensors** measure changes in the dielectric constant of the soil with a capacitor, which consists of two plates of a conductor material separated by a short distance (less than 3/8 of an inch). A voltage is applied at one extreme of the plate, and the material that is between the two plates stores some voltage. A meter reads the voltage conducted between the plates. When the material between the plates is air, the capacitor measures 1 (the dielectric constant of air). Most solid soil components (soil particles), have a dielectric constant from 2 to 4. Water has higher dielectric constant of 78. Hence, higher water contents in a capacitance sensor would be indicated by higher measured dielectric constants. Changes in the dielectric constant provide an indication of soil water content. Sensors are often left in place in the root zone, and they can be connected to a datalogger for monitoring over time.

**Tensiometers** measure tension of water in the soil (soil suction). A tensiometer consists of a sealed water-filled tube equipped with a vacuum gauge on the upper end and a porous ceramic tip on the lower end. As the soil dries, soil water tension (suction) increases; in response to this increased suction, water is moved from the tensiometer through the porous ceramic tip, creating a vacuum in the sealed tensiometer tube. Water can also move from the soil into the tensiometer during or following irrigation. Most tensiometers have a vacuum gauge graduated from 0 to 100 (centibars, cb, or kilopascals, kPa). A reading of 0 indicates a saturated soil. As the soil dries, the reading on the gauge increases. The useful limit of the tensiometer is about 80 cb. Above this tension, air enters through the ceramic cup and causes the instrument to fail. Therefore, these instruments are most useful in sandy soils and with drought-sensitive crops because they have narrower soil moisture ranges.

Soil water monitoring methods have advantages and limitations. They vary in cost, accuracy, ease of use, and applicability to local conditions (soils, moisture ranges, etc.) Most require calibration for accurate moisture measurement. Proficiency of use and in interpreting information results from practice and experience under given field conditions.

*\*Excerpts from Enciso, Juan, Dana Porter, and Xavier Peries., 2007. Irrigation Monitoring with Soil Water Sensors. TCE Fact Sheet B-6194. Texas AgriLife Extension Service (formerly Texas Cooperative Extension), Texas A&M System, College Station, TX.*



## Soil Moisture Management (B-1670)



# Texas Agricultural Extension Service

The Texas A&M University System

## Soil Moisture Management

Guy Fipps\*

Water is essential for normal plant growth and makes up to 90 percent or more of the weight of fresh growing plants. Irrigation is used to maintain proper soil moisture for achieving optimal yields or for maximizing return on investment. Understanding the basic principles of soil moisture storage and management is necessary for the efficient use of water in irrigated agriculture and to reduce the pollution potential from runoff and deep percolation.

### Soil Water

Sources and losses of soil moisture are illustrated in Figure 1. Water is usually supplied by rainfall or irrigation. Some of this water is lost due to direct evaporation and runoff, while some infiltrates into

the soil. When adequate soil moisture levels exist, plants can extract water from the soil through the root system. Much of the water that the plant intakes eventually is transpired to the atmosphere through the leaves.

If excess soil moisture levels exist, the infiltrating water will continue to move below the root zone and be lost to deep percolation, thus moisture and nutrients for plant use are lost also. In addition, deep percolation can carry pollutants to underlying aquifers. Water quality problems caused by deep percolation have been identified in some areas of the state. Locations with high water tables may experience water moving up through the soil due to capillary forces.

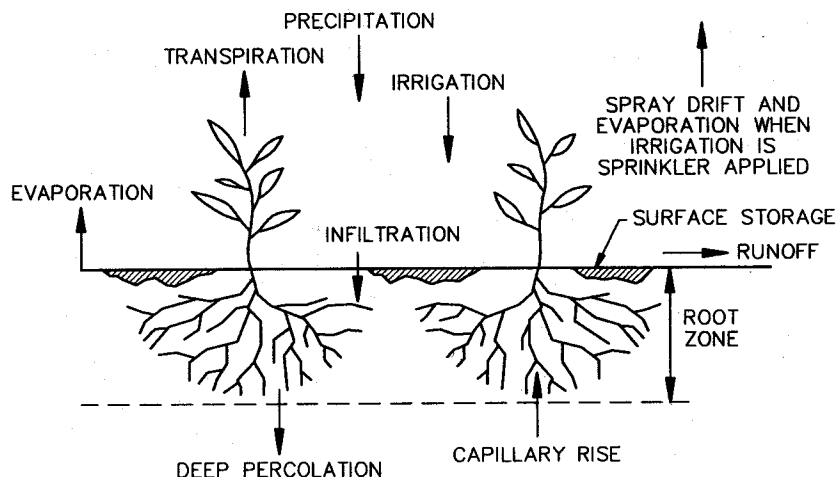
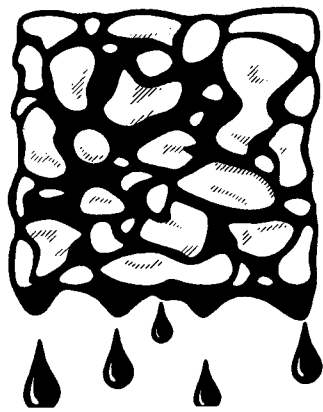
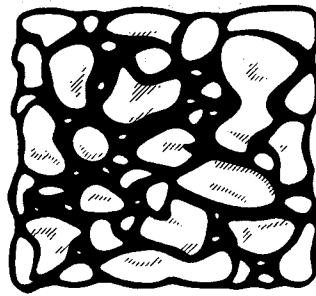

Figure 1. These sources and losses of soil moisture and factors are important in soil moisture management.

\* Extension Agricultural Engineer, Texas Agricultural Extension Service.



a. Saturation



b. Field Capacity

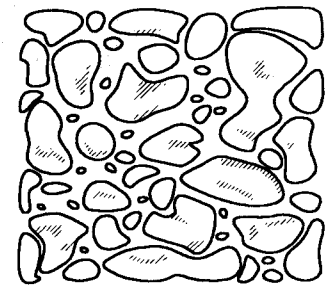

c. Wilting Point

Figure 2. Here are three important soil moisture conditions. At the wilting point, plants can extract little soil moisture.

Various terms are used to describe soil moisture content and the forces that move and hold water in the soil. Three classes of soil water describe the principal forces at work: gravitational, capillary and hygroscopic. *Gravitational water* is the water that moves in response to gravity, usually under saturated conditions (Fig. 2a). This water drains downward, leaving plants only a short period to access any of it. *Capillary water* is held against gravity in the pore spaces of the soil and is the most important for crop production. The capillary and gravitational water that can be used by plants is available water. *Hygroscopic water* is held so tightly by individual soil particles that roots cannot extract it. This water is associated with the soil moisture content at and below the wilting point (Fig. 2c) and is referred to as unavailable water.

### Soil Moisture Storage

In general, soils are made up of (1) mineral matter, (2) organic matter, (3) water and (4) air. Mineral and organic matter are the solids in soil, and many occupy 35 to 75 percent of the total soil volume. The remaining volume, or pore space, is occupied by air and water. A medium-textured soil typically contains about 50 percent solid material and 50 percent pore space.

The size and total volume of pore space are a function of both the soil's texture and structure. Clay soils can hold a significant amount of water because of the relatively large surface areas of individual clay particles and the large number of very small pores. Sand particles, on the other hand, have relatively small surface areas, and sandy soils contain a smaller number of pores which are larger in size. Water

drains more easily from these larger pores due to gravity forces. Figure 3 illustrates the relationship between soil texture and the amount of water held in the soil. Both the amounts of available and unavailable water increase as the clay content of the soil increases. Thus, sands have a much lower water holding capacity than clay soils.

Knowing the water holding capacity of soils is important in determining both the amount and frequency of irrigation. Soils with low water holding capacity must be irrigated more frequently with smaller amounts of water than soils with higher water holding capacity. In Table 1, numerical values of

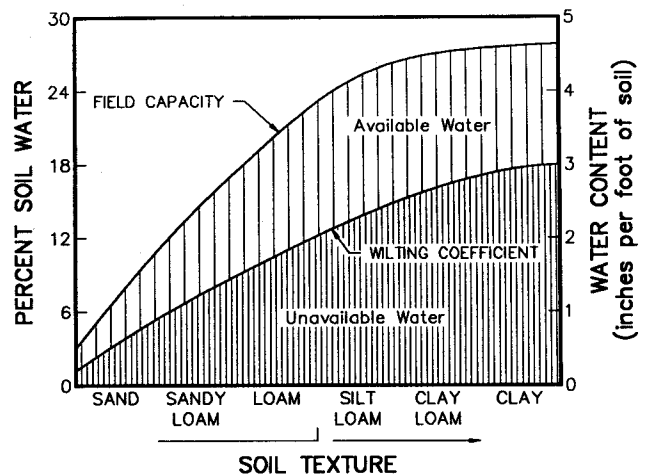

Figure 3. Notice the relationship between soil texture and the soil moisture content. Both the amounts of available and unavailable water increase as the clay content increases.



**Table 1. Approximate water-holding capacity of soils given in inches of water per foot of soil (in/ft).**

Soil texture	Moisture held at field capacity	Moisture held at permanent wilting point	Available moisture	Water to be replaced at irrigation*
Sands	1.0 - 1.4	.2 - .4	.8 - 1.0	.5 - .8
Sandy loams	1.9 - 2.3	.6 - .8	1.3 - 1.5	.8 - 1.2
Loams	2.5 - 2.9	.9 - 1.1	1.6 - 1.8	1.1 - 1.3
Silt loams	2.7 - 3.1	1.0 - 1.2	1.7 - 1.9	1.2 - 1.5
Clay loams	3.0 - 3.4	1.1 - 1.3	1.9 - 2.1	1.3 - 1.7
Clays	3.5 - 3.9	1.5 - 1.7	2.0 - 2.2	1.4 - 1.8

\* Based on application of irrigation water when 50 to 60 percent of the available water in the root zone has been depleted and assuming 75 percent irrigation application efficiency.

Adjust amount to be replaced if more or less than 25 percent of water applied is lost by your irrigation system. (Table 4)

approximate water storage capacities are listed for agricultural soils. These values can be used as a general guide in absence of specific field data. A good source of specific soils information is contained in the county soil survey reports published by the U.S.D.A. Soil Conservation Service.

### Soil, Plant and Water Relationships

Water is essential for plant growth. Without enough water, normal plant functions are disturbed and the plant gradually wilts, stops growing and dies. Plants are most susceptible to damage from water deficiency during reproductive stages of growth (flowering, pollinating and fruiting).

Water also dissolves plant nutrients and carries them into the plant, chiefly through the roots. A small amount of the water taken up by the plant (less than 1 percent) is used in photosynthesis and to maintain turgidity (the proper form and position of stems, leaves and shoots for capturing sunlight). The rest of the water moves to the leaf surfaces where it is transpired to the atmosphere.

#### Available Soil Moisture

Soil moisture tension is a measurement of the energy or the force in which water is held by the soil and is expressed in units of pressure. The plant must use energy to get water from the soil. When soil water is at field capacity and soil moisture tension is low, the plant can readily extract water from the soil. As the soil moisture is depleted, the soil moisture tension increases and it becomes more and more difficult for the plant to extract water. At the permanent wilting point, the soil contains some moisture. However, this water is held so tightly that the plant cannot use any

of it. The term available moisture is used to refer to soil moisture that can be used by the plant.

#### Allowable Soil Moisture Depletion

Although plants can withdraw water to the permanent wilting point, their growth is usually decreased before signs of permanent wilting occur. In order to obtain good yields, soil moisture must be maintained above the wilting point. For many plants, irrigation water should be applied before 50 to 60 percent of the available water is depleted. However, the amount of soil moisture depletion that can be sustained without yield reduction varies among some plants. For example, many vegetable crops require high soil moisture levels and can withstand no more than 25 percent soil moisture depletion.

Grain sorghum, on the other hand, is more drought resistant and can withstand drier soil conditions. Table 2 gives some ranges of allowable soil moisture depletion that have been established for a few crops. However, soil conditions, climate and other local factors may influence these ranges.

#### Rooting Depth

The crop root zone is often viewed as a reservoir. Irrigation is used to fill the soil reservoir or to bring the soil moisture content up to field capacity in order to store water for crop use. Thus, knowing the depth of the root zone is necessary to determine how much irrigation water is needed. The rooting depth is not a constant but increases as the plant grows. In addition, many factors may restrict root development such as high water tables, shallow soils, changes in soil type or compacted and plow layers. Fertility and soil salinity also influence the rooting depth.

**Table 2.** Allowable root zone water depletion between irrigations for near maximum yield (adapted from Jensen, 1980).

Crop	Allowable water depletion (%)	Root zone depth normally irrigated in deep soils (feet)
Alfalfa	30 - 50	4.0 to 6.0
Beans, dry	50 - 70	2.0 to 3.0
Corn	40 - 60	2.5 to 4.0
Cotton	50 - 65	3.0 to 4.0
Deciduous fruit	50 - 70	4.0 to 6.0
Pasture/turf	55 - 65	1.0 to 2.5
Peanuts	45 - 50	2.0 to 2.5
Potatoes	25 - 50	2.0 to 3.0
Sugar beets	30 - 60	2.0 to 4.0
Grain sorghum	50 - 70	2.0 to 3.0
Soybeans	50 - 60	2.0 to 3.0
Wheat	50 - 70	3.0 to 4.0
Vegetable crops	25 - 50	2.0 to 4.0

The depth that soil moisture is managed in irrigation is often referred to as the effective root zone or effective rooting depth. The effective depths given in Table 2 are for mature crops on uniform, deep and well drained soils. Such values should be used with caution since rooting depth is so dependent on local conditions. Generally, the depth containing about 80 percent of the total root mass is used for estimating effective root zone depth from field observations. The maximum effective rooting depth for a crop often occurs when the full crop canopy develops.

The root mass is not evenly distributed throughout the root zone. For most well-watered crops on deep, uniform soils, there is a greater concentration of root mass in the upper portion of the root zone. As a result, more moisture is extracted from the upper portion than from the lower portion of the root zone. As a general rule, crops obtain about 40 percent of their total water requirement from the top one-fourth of the root zone. Figure 4 illustrates the basic moisture extraction pattern of plants. In the absence of specific crop data, this figure can be used

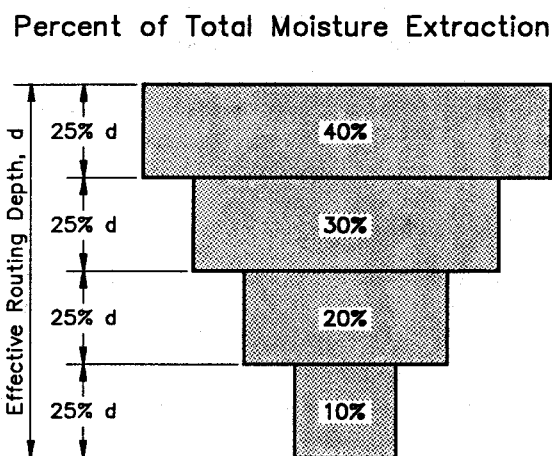
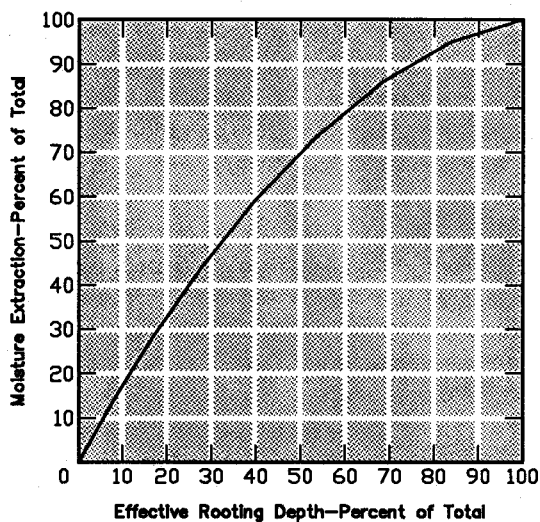

**Figure 4.** The basic soil moisture extraction pattern for many plants in a deep, well-drained soil is shown here. Approximately 40 percent of the total water used by a plant is extracted from the top quarter of the effective root zone.

to estimate soil moisture needs within the effective root zone.

## Soil Moisture Balance

It is important to maintain high levels of available soil moisture. Soil moisture depletion due to plant transpiration, deep seepage or evaporation must be balanced by irrigation and rainfall. Water stored in the root zone is used to meet plant demands between irrigations. These factors are balanced against each other to ensure that the soil moisture in the root zone is not depleted so that reductions in yield occur. They are also used to project when the root zone soil moisture will reach a level that requires replenishment.

## Irrigation Amounts

Water requirements for crops are not constant, but increase as the plants grow. When planning for irrigation, one must determine both the seasonal and peak water requirements for the crops to be irrigated. The peak daily water use of some crops in Texas are listed in Table 3, taken from the Texas Board of Water Engineers (1960). This publication also contains estimates for crop water use for each month and each area of the state.

**Table 3.** Average daily peak water use for some crops in Texas (Texas Board of Water Engineers, 1960)

Crop	Peak water use (in / day)
alfalfa	0.26 - 0.36
perennial pasture	0.23 - 0.32
corn	0.26 - 0.47
cotton	0.22 - 0.38
small grains	0.22 - 0.37
orchards	
citrus	0.16 - 0.21
deciduous fruit	0.22 - 0.31
pecan	0.21 - 0.28
peanuts	0.21 - 0.28
grain sorghum*	0.21 - 0.35
vegetables*	
deep rooted	0.22 - 0.30
shallow rooted	0.21 - 0.34

\* summer crops

In addition to the peak water use period, many crops have certain stages of growth when significant yield or quality reductions will occur if adequate soil moisture levels are not maintained. Irrigations not only must be timed to minimize periods of water stress, but also not exceed the available root zone storage, except as needed for leaching of excess salts.

An effective method for determining the amount of water to apply per irrigation involves soil moisture monitoring. Devices such as tensiometers and gypsum blocks are used to measure the current soil moisture deficit (see TAEX publication B-1610, *Soil Moisture Monitoring*). Next, the total amount of water necessary to bring the soil up to field capacity can be calculated using the effective rooting depth and the soil's water holding capacity. The total irrigation water needed is then determined by increasing this amount to account for losses due to the application in efficiency of the irrigation system (Table 4). Useful units and conversions for calculating irrigation amounts are given in Table 5.

**Table 4.** Typical overall on-farm efficiencies for various types of irrigation systems. (Adapted from James 1988).

System	Overall efficiency (%)
Surface	50 - 80
a. average	50
b. land leveling and delivery pipeline meeting design standards	70
c. tailwater recovery with (b)	80
d. surge	60 - 90*
Sprinkler	55 - 75
Center Pivot	55 - 80
LEPA	95 - 98
Drip	80 - 90**

\* Surge has been found to increase efficiencies 8 to 28 percent over non-surge furrow systems.

\*\*Trickle systems are typically designed at 90 percent efficiency; short laterals (< 100 ft) or systems with pressure compensating emitters may have higher efficiencies.

Table 5. Irrigation Water Units and conversions

one cubic foot	=	7.48 gallons
one acre inch	=	3630 cubic feet
	=	27,154 gallons
one acre foot	=	12 acre inches
	=	43,560 cubic feet
	=	325,851 gallons
450 gallons per minute		
	=	~ 1 acre inch per hour
	=	~ 1 cubic foot per second

### Terms Used in Soil Moisture Management

**Allowable water depletion** is the amount of available water that can be depleted from the soil without adverse effects on plant growth and yield. Some plants are more "drought tolerant" than others and can tolerate dryer soil conditions.

**Available water** is the amount of water held in the soil between field capacity and the permanent wilting point that is readily available for use by plants. It is usually expressed in inches of water per foot of soil.

**Effective root zone** is the depth from which the roots of an average mature plant are capable of reducing soil moisture to the extent that it should be replaced by irrigation.

**Field capacity** is the amount of water a soil will hold against gravity when allowed to drain freely. This moisture content is reached one or two days after irrigation in well-drained soils (Figure 2b).

**Infiltration** is usually defined as the entry of water into the soil profile. The infiltration or intake capacity of the soil determines the rate that water can be applied on the surface without runoff.

**Irrigation efficiency** is the ratio of the amount of water consumed by the crop divided by the total

amount pumped or supplied from the water source. The term is used to account for losses in an irrigation system due to wind drift, evaporation, runoff, etc. (Table 4).

**Permanent wilting point** is the soil moisture content at which plants permanently wilt. At the wilting point, water is held so tightly by the soil particles that it cannot be extracted by plant roots. (Figure 2c).

**Saturation** is a condition in which all pore spaces of a soil are completely filled with water (Figure 2a).

**Soil moisture content** is the quantity of moisture contained in a soil, expressed as a percentage of volume, a given weight of dry soil, or in inches of water per foot of soil.

**Soil moisture tension** is the force or energy that must be exerted to remove water from the soil. Moisture tension is usually expressed in terms of atmospheres of pressure and is directly related to the moisture content of the soil.

### References

- James, L.G. 1988. *Principles of Farm Irrigation System Design*. John Wiles and Sons, New York, 543 p.
- Jensen, M.E. (editor). 1980. *Design and Operation of Farm Irrigation Systems*. American Society of Agricultural Engineers. St. Joseph, MO. 829 p.
- Keese, C.W. and J.C. Henggeler. 1989. *Soil Moisture Storage*. L-754, Texas Agricultural Extension Service, Texas A&M University, College Station, TX. 4 p.
- Sweeten, J.M. and J.C. Henggeler. 1988. B-1610. *Soil Moisture Monitoring*. Texas Agricultural Extension Service, Texas A&M University. College Station, TX. 8 p.
- Texas Board of Water Engineers. 1960. *Consumptive Use of Water by Major Crops in Texas*. Bulletin 6019. November.

## Appendix: Sample Calculations

I. Determine the irrigation amount needed for a mature corn crop being grown in a deep and uniform loamy soil.

**Step 1:** The following data is measured or estimated for the particular field, crop and irrigation system in question

Parameter	Value assumed
rooting depth	3.5 ft
current soil moisture content	2.4 in/ft
moisture held at field capacity	2.9 in/ft
irrigation efficiency	75 percent

**Step 2:** calculate soil moisture deficit in root zone (units in inches and feet)

$[(\text{moisture at field capacity}) - (\text{current soil moisture})] \times (\text{rooting depth}) = (\text{soil moisture deficit})$

$$(2.9 \frac{\text{in}}{\text{ft}} - 2.4 \frac{\text{in}}{\text{ft}}) \times 3.5 = 1.75 \text{ in}$$

**Step 3:** calculate required irrigation amount (units in inches)

$(\text{soil moisture deficit}) \div (\text{irrigation efficiency}) = (\text{irrigation amount})$

$$1.75 \text{ in} \div .75 = 2.33 \text{ in}$$

II. Determine the maximum number of days between irrigation for the corn during the peak use period if the soil moisture is at field capacity.

**Step 1:** the following additional data is measured or estimated

Parameter	Value assumed
available soil water	1.8 in/ft
peak crop water use	0.35 in/day
allowable water depletion	50 percent

**Step 2:** calculate total water that can be used by the crop without yield reduction (units in inches and feet)

$(\text{available soil water}) \times (\text{rooting depth}) \times (\text{allowable water depletion}) = (\text{usable water})$

$$1.8 \frac{\text{in}}{\text{ft}} \times 3.5 \text{ ft} \times 0.50 = 3.15 \text{ in}$$

**Step 3:** calculate maximum time between irrigations (units in inches and days)

$(\text{usable water}) \div (\text{crop water use rate}) = (\text{maximum time between irrigations})$

$$3.15 \text{ in} \times \frac{\text{day}}{0.35 \text{ in}} = 9 \text{ days}$$

This publication was funded by the State Agricultural Soil and Water Conservation Fund.

*Educational programs of the Texas Agricultural Extension Service are open to all citizens without regard to race, color, sex, disability, religion, age or national origin.*

Issued in furtherance of Cooperative Extension Work in Agriculture and Home Economics, Acts of Congress of May 8, 1914, as amended, and June 30, 1914, in cooperation with the United States Department of Agriculture. Zerle L. Carpenter, Director, Texas Agricultural Extension Service, The Texas A&M University System.  
5M-2-95, Reprint

AgEng



# Irrigation Monitoring with Soil Water Sensors (B-6194)



# Irrigation Monitoring with Soil Water Sensors

Juan M. Enciso, Dana Porter and Xavier Périès\*



**M**onitoring soil water content is essential to help growers optimize production, conserve water, reduce environmental impacts and save money. Soil moisture monitoring can improve irrigation decisions, such as how much water to apply and when to apply it. It can also match irrigation water applied with crop water requirements, avoiding over- or under-irrigating the crop. Over-irrigation can increase energy consumption and water cost as well as leaching of fertilizers below the root zone, erosion, and transport of soil and chemical particles to the drainage ditches. Under-irrigation can reduce crop yields.

## Basic concepts

Soil water storage capacities are summarized by soil texture in Table 1. They are characterized by soil-specific parameters and are key to efficient irrigation management. These are defined as follows:

**Field capacity** is the soil water content after a heavy irrigation has finished and when the drainage rate changes from rapid to slow. This point is reached when all the gravitational water has drained (Figure 1). Field capacity is normally attained two to three days after irrigation and reached when the soil water tension is approximately 0.3 bars (30 centibars or 3 m of tension) in clay or loam soils, or approximately 0.1 bar in sandy soils.

**Permanent wilting point** is the soil water content at which plants cannot recover overnight from excessive drying during the day. This parameter, which may vary with plant species and soil type, has been determined in greenhouse experiments. It is attained at a soil water tension between 10 and 20 bars (102 to 204 m of ten-

\*Associate Professor and Extension Agricultural Engineering Specialist, Associate Professor and Extension Agricultural Engineering Specialist, and Extension Associate, respectively, The Texas A&M University System.

**Table 1. Soil moisture content in inches of water per foot of soil.**

Soil Texture	Field Capacity	Permanent Wilting Point (15 Bars)	Plant Available Water (in./ft.)
Sand	1.2 (10)*	0.5 (4)	0.7 (6)
Loamy sand	1.9 (16)	0.8 (7)	1.1 (9)
Sandy Loam	2.5 (21)	1.1 (9)	1.4 (12)
Loam	3.2 (27)	1.4 (12)	1.8 (15)
Silt loam	3.6 (30)	1.8 (15)	1.8 (15)
Sandy clay loam	4.3 (36)	2.4 (20)	1.9 (16)
Sandy clay	3.8 (32)	2.2 (18)	1.7 (14)
Clay loam	3.5 (29)	2.2 (18)	1.3 (11)
Silty clay loam	3.4 (28)	1.8 (15)	1.6 (13)
Silty clay	4.8 (40)	2.4 (20)	2.4 (20)
Clay	4.8 (40)	2.6 (22)	2.2 (18)

\*Numbers in parentheses are volumetric moisture contents in percent.  
Source: Hanson 2000.

sion). A mean value of 15 bars (153 m) is generally used. *Hygroscopic water* is held tightly on the soil particles (below permanent wilting point) and cannot be extracted by plant roots.

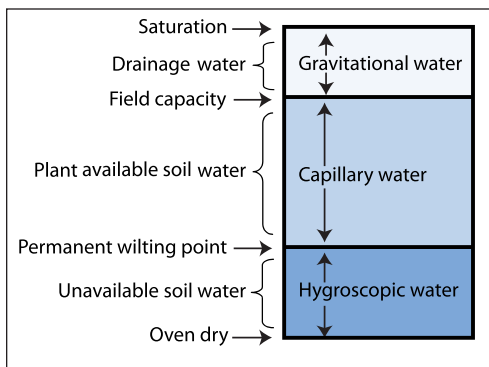

**Figure 1. Soil water parameters and classes of water.**

**Plant available water** is retained in the soil between field capacity and the permanent wilting point. This parameter is generally expressed in inches of water per foot of soil depth. It depends on such factors as soil texture, bulk density and soil structure. Table 1 shows approximate values of plant available water for different soil textures. The soil water contained between these limits moves primarily by capillary, or matric, forces (Figure 1).

**Gravimetric water content**, which is a direct soil moisture measurement, is the standard method to calibrate other soil water determination techniques. The oven drying technique is probably the most widely used of all gravimetric methods for measuring soil water. A soil sample can be taken with an auger or tube sampler. It is placed

in a container and weighed, and is dried in an oven at 105°C until a constant weight is obtained (normally after 24 hours). Then it is weighed again. The gravimetric water content, which is the amount of water in the sample as percent of the dry soil weight, is calculated as follows:

$$\text{Gravimetric water content (\%)} = \frac{\text{Mass of wet soil} - \text{Mass of dry soil} \times 100}{\text{Mass of dry soil}}$$

**Bulk density** is the expression of mass of dry soil per unit volume of soil. It is related to porosity (void space) and compaction, and it is used to calculate volumetric soil water content from gravimetric water content. This parameter is generally expressed in grams per cubic centimeter of soil accordingly:

$$\text{Bulk density} = \frac{\text{Mass of dry soil}}{\text{Volume of soil}}$$



**Volumetric water content** is commonly used to express the soil water content. As the following shows, it is obtained by multiplying the bulk density of the soil by the gravimetric water content:

$$\text{Volumetric water content (\%)} = (\text{Bulk density of soil/density of water}) \times \text{Gravimetric water content (\%)}$$

The volumetric water content (%) can be used to calculate irrigation depth. Assume, for example, that the current volumetric water content is 20 percent and the field capacity is 30 percent. If we want to bring the top 2 feet to field capacity, the required irrigation depth to bring the soil to field capacity is calculated as follows:

$$\begin{aligned} \text{Irrigation depth} &= (30-20)/100 \times 2 \text{ ft} = 0.1 \times 2 \text{ ft} \\ &= 0.1 \times 24 \text{ inches} = 2.4 \text{ inches} \end{aligned}$$

If we want to know how much water the soil contains at 20 percent plant available soil moisture, the available water depth can be calculated accordingly:

$$\text{Water depth} = 20\% \times 2 \text{ ft} = 20/100 \times 24 \text{ inches} = 4.8 \text{ in}$$

**Water storage capacity of soils.** The soil moisture characteristic curve (Figure 2) describes the relationship between soil water content and the tension at which the water is held in the soil. It is non-linear, and the relationship varies from soil to soil. In a saturated soil, the tension is very near zero; and, as soil dries, tension (suction) increases.

Soil texture influences the characteristic curve. Since sandy soils do not hold as much plant available water, they generally drain more quickly and need to be irrigated more frequently than clay or loam soils.

**Management allowable depletion (MAD).** This is the point below which the soil available water should not be depleted to avoid excessive water stress and, therefore, reduction in production. The volume of water between the MAD point and field capacity should be the irrigation depth. The volume of water below this limit is what remains in the soil. The management allowable depletion (or allowable deficit) will depend on the plant species and will vary between growing seasons. It is generally expressed in percent. Recommended MAD levels for many field crops are near 50 percent. For drought-sensitive crops (including many vegetables), MAD may be as low as 25 percent. Table 2 shows the allowable depletion for selected crops.

Another criterion often used to trigger irrigation applications is soil *moisture tension*. This method of irrigation scheduling is most applicable with sprinkler irrigation or microirrigation (drip irrigation) systems that allow for relatively precise irrigation applications. Soil moisture tension can be measured with a sensor such as the Watermark® sensor (granular matrix sensor) or a tensiometer. The trigger-

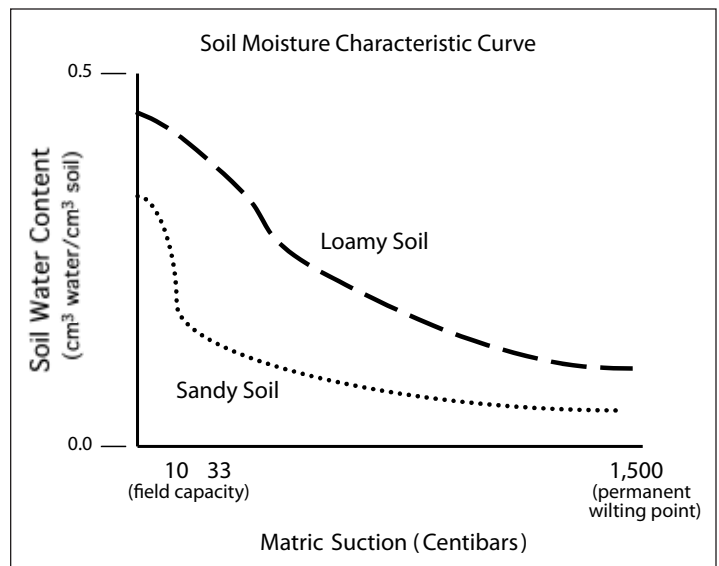

Figure 2. Soil water characteristic curves for typical sandy and clay soils.

**Table 2. Allowable soil moisture depletions (MAD, %) and root depths (ft) for selected crops.**

<b>Crop</b>	<b>Allowable depletion (%)</b>	<b>Root depth* (ft.)</b>
<b>Fiber crops</b>		
Cotton	65	3.3–5.6
<b>Cereals</b>		
Barley and oats	55	3.3–4.5
Maize	50–55	2.6–6.0
Sorghum	50–55	3.3–6.6
Rice	20	1.6–3.3
<b>Legumes</b>		
Beans	45	1.6–4.3
Soybeans	50	2.0–4.1
<b>Forages</b>		
Alfalfa	50–60	3.3–9.9
Bermuda	55–60	3.3–4.5
Grazing pastures	60	1.6–3.3
<b>Turf grass</b>		
Cool season	40	1.6–2.2
Warm season	50	1.6–2.2
<b>Sugarcane</b>	65	4.0–6.5
<b>Trees</b>		
Apricots, peaches	50	3.3–6.6
<b>Citrus</b>		
70% canopy	50	4.0–5.0
50% canopy	50	3.6–5.0
20% canopy	50	2.6–3.6
<b>Conifer trees</b>	70	3.3–4.5
<b>Walnut orchard</b>	50	5.6–8.0
<b>Vegetables</b>		
Carrots	35	1.5–3.3
Cantaloupes and watermelons	40–45	2.6–5.0
Lettuce	30	1.0–1.6
Onions	30	2.0–3.0
Potatoes	65	1.0–2.0
Sweet Peppers	30	1.6–3.2
Zucchini and cucumbers	50	2.0–4.0

\*Root depths can be affected by soil and other conditions. Effective root zone depths are often shallower.

Source: Allen et al., 1998.

ing soil water tension will vary with soil type and the depth at which the sensor is placed. Calibration and site-specific experience optimize the use of soil moisture tension in irrigation scheduling. Some suggested tension values appear in Table 3.

**Root depth** will determine the soil water available for the plant, and Table 2 shows the expected rooting depths for selected crops. Soil conditions (e.g., compacted layers, shallow water tables, dry soil) can limit root zone depth. In general, vegetables have relatively shallow root systems, and, thus, limited access to soil moisture storage. Crops with lower allowable depletion levels and shallower root depths require more frequent irrigations.

## Soil water measurement

Methods used to measure soil water are classified as *direct* and *indirect*. The direct method refers to the gravimetric method in which a soil sample is collected, weighed, oven-dried and weighed again to determine the sample's water content on a mass percent basis. The gravimetric method is the standard against which the indirect methods are calibrated. This section describes several indirect methods for measuring soil moisture.

### Granular matrix sensors and gypsum blocks

Gypsum block sensors respond to soil water conditions at the depth they are placed by measuring electrical resistance between two circles of wire mesh that are connected to a porous material.

### How it works

Although the electrical resistance is measured in ohms, the handheld meter converts the reading automatically to centibars (1 bar = 100 centibars). Electrical resistance increases as soil water suction increases, or as soil moisture decreases. While the Watermark® sensor (Figure 3) functions similarly to the gypsum block sensor, it differs in that it is more durable in the soil and may be more responsive to changes in soil moisture.

The handheld meter for the Watermark® sensor (Figure 4) indicates soil moisture tension over the range of 0 to 199 centibars. The tension should be interpreted carefully, considering the soil properties. For instance, 10 cb could correspond to field capacity for coarse-textured soils (sand), while 30 cb could correspond to field capacity for finer-textured soils (silt, clay, loams). A rising meter reading indicates depletion of total available water. Therefore, 75 cb could correspond to 90 percent depletion for coarse-textured soils, but only 30 percent for fine-textured soils. Consequently, it is recommended to calibrate the Watermark® sensors to a specific soil. These sensors are slightly affected by temperature and salinity. The sensor in Figure 4 can be adjusted for soil temperature.

### Installation and reading

It is important to install several stations of Watermark® sensors in a field to get a good moisture reading accuracy, especially if the field includes several soil types. A station should have sensors placed at multiple depths, depending on the crop grown (and effective root zone depth). This is to evaluate moisture movement and depletion within the root zone over time and with crop water use.

The placement of the sensors will vary slightly according the irrigation technique. In addition, they must be placed in a representative area, such as within the plant row for row crops, in the bed for vegetable crops or in wetted areas under drip irrigation. Depth of placement should also be representative of the effective root zone.

Sensors must be soaked first before installation to improve the sensor response in the first irrigation. They should also be installed wet. To put them into the soil at an appropriate depth, use a 7/8-inch auger to drill a hole in the soil to the desired depth. Push the sensor in with a stick, add water and soil to backfill the hole to bury the sensor, leaving the wire leads accessible on or above the ground. A flag or other marker at each site will make it easier to locate the sensor leads for subsequent readings.

Table 3. Recommended allowable soil moisture tensions for selected crops.

Crop	Tension centibars
Alfalfa	80–150
Cabbage	60–70
Cantaloupe	35–40
Carrot	55–65
Cauliflower	60–70
Celery	20–30
Citrus	50–70
Corn (sweet)	50–80
Deciduous tree	50–80
Grain	
Vegetative growth stage	40–50
Ripening stage	70–80
Lettuce	40–60
Onion	45–65
Potato	30–50
Tomato	60–150

Source: Hanson et al. 2000.



Figure 3. Watermark® sensor before installation.



Figure 4. Using handheld meter for Watermark® sensor.



Figure 5. Watermark® sensors connected to a 3-port (up to 3 sensors) WatchDog® data logger.

If sensors are removed, they can be reused for several seasons with care, so clean and dry them before storage. However, once you are ready to install them again, you need to check the sensors first. To do this, soak them in water and make sure that the submerged sensors read between 0 and 5 cb. If they read more than 5 cb, discard them.

Connecting the sensor leads to a Watermark® digital meter gives an instant reading. Regular readings indicate how fast the soil moisture is depleting, and, therefore, indicate when irrigation will be needed. There are some data loggers like the one in Figure 5 that permit the data to be read directly and recorded continuously. They also allow the downloading of data to a portable computer.

Figure 6 shows the movement of soil water at different soil depths (6, 18 and 30 inches) in an orange orchard. In this application, subsurface drip irrigation is triggered when the sensor located at a soil depth of 18 inches reaches approximately 40 cb. An irrigation application (indicated on the graph by a blue triangle) of about 0.7 inches saturates the soil. Note that the soil dries first in the top of the root zone and then later in the deeper portion of the root zone.

Sensors track irrigation and indicate soil moisture trends. Rainfall (indicated on the graph by purple squares) allows the manager to delay irrigation.

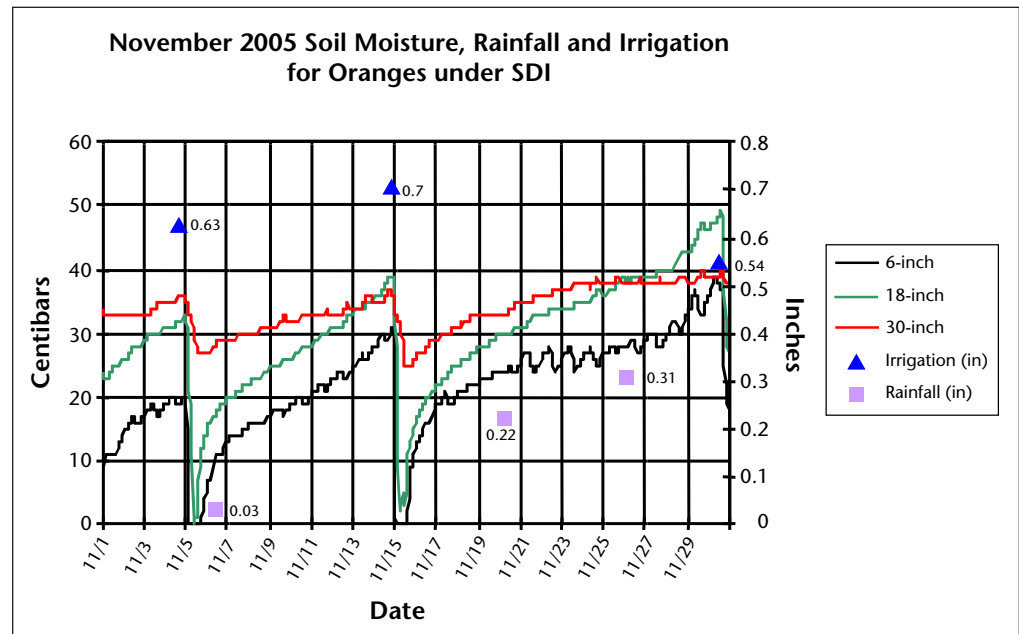

Figure 6. Soil water readings with Watermark® sensors, rainfall and irrigation for oranges under drip irrigation.

## Capacitance sensors

These sensors measure changes in the *dielectric constant* of the soil with a capacitor, which consists of two plates of a conductor material separated by a short distance (less than  $\frac{3}{8}$  of an inch). A voltage is applied at one extreme of the plate, and the material that is between the two plates stores some voltage. A meter reads the voltage conducted between the plates.

When the material between the plates is air, the capacitor measures 1 (the dielectric constant of air). Most materials in soil, such as sand, clay and organic matter, have a dielectric constant from 2 to 4. Water has higher dielectric constant of 78. Hence, higher water contents in a capacitance sensor would be indicated by higher measured dielectric constants. Thus, by measuring the changes in the dielectric constant, the soil water content is measured indirectly.

Some of the available capacitance-based sensors include ECH<sub>2</sub>O<sup>®</sup> probes (Figure 7), EnviroSCAN<sup>®</sup> and Time-Domain Reflectometry (TDR). (This section only describes ECH<sub>2</sub>O<sup>®</sup> probe sensors.)

### **How it works**

These sensors give readings of volumetric soil water content at the depth they are placed (m<sup>3</sup> of water/m<sup>3</sup> of soil). Soil moisture typically ranges from 0 to 0.4 m<sup>3</sup> of water per m<sup>3</sup> of soil. These sensors are already pre-calibrated for a wide range of soil types. However, for high sand content (coarse textures) and soils with high salt contents, the standard calibration will not be accurate. Therefore, some calibrations will have to be done. A value of 0 to 0.1 m<sup>3</sup>/m<sup>3</sup> indicates an oven-dried to dry soil (wilting point), and a value of 0.3 to 0.4 m<sup>3</sup>/m<sup>3</sup> represents a wet (field capacity) to saturated soil.

The sensors are connected to a data logger (such as a HOBO<sup>®</sup> data logger or weather station), and a serial cable will allow data downloading to a personal computer. The HOBO<sup>®</sup> data logger can accept up to four sensors.

### **Installation and reading**

The sensors should be placed at several depths in a representative area of the field in order to evaluate soil water movement and depletion in the root zone. This is monitored over time and with crop water use.

Since sensors measure the water content near their surface, it is important to avoid air gaps and excessive soil compaction around them. This enables readings to be most representative of undisturbed soil.

Probes should be placed at least 3 inches from each other or from other metal surfaces. They can be placed perpendicular or vertical to the soil surface, but it is important to avoid downward water movement along the surface of the probe. To place a probe, make a pre-hole with a 3-inch auger for deeper installations. Then use an ECH<sub>2</sub>O probe<sup>®</sup> auger to insert the probe into the soil at the desired depth (Figure 8). Next you need to cover the probe with soil around it, making sure good contact is made against the probe. The probe cables need to be accessible to be plugged into the data logger through their jacks and will last longer if inserted through a conduit. This protects cables from damage by animals, chemicals and UV rays.

Software is necessary for downloading sensor data from the data logger onto a personal computer (Figure 9). The data logger can be programmed to take readings at different time intervals (e.g., 1 reading every 2 or 24 hours). It is possible to collect soil moisture content data for the whole season for a particular crop.



Figure 7. ECH<sub>2</sub>O probe<sup>®</sup> and ECH<sub>2</sub>O check<sup>®</sup> meter (dielectric meter).



Figure 8. Using a special auger to install the ECH<sub>2</sub>O probes: a blade of the probes shape is hammered down (top) before inserting and pushing down the probe with another tool (below).



Figure 9. Downloading data from the logger to the personal computer.

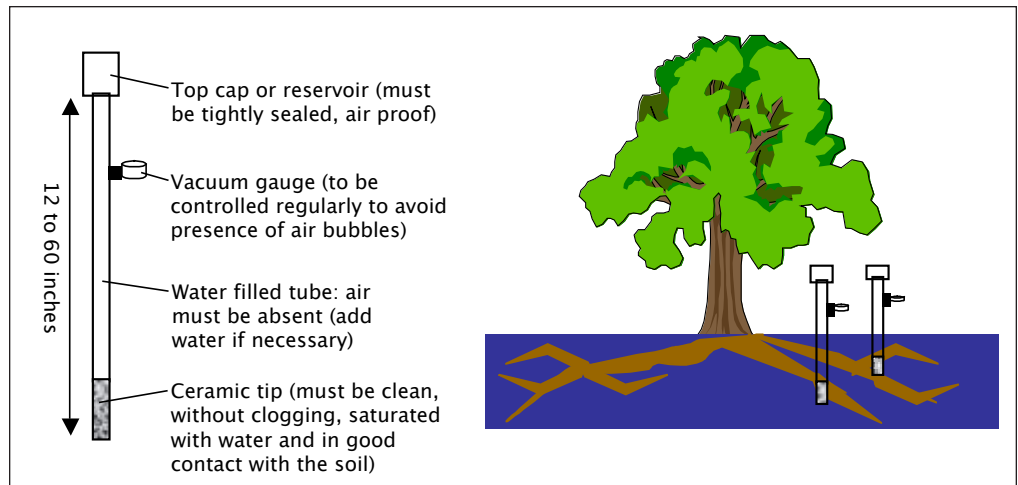

**Figure 10.** Diagram of a tensionmeter and a station of two tensionmeters installed at different soil depths.

## Tensiometer

A tensiometer measures the tension of the soil water or soil suction. This instrument consists of a sealed water-filled tube equipped with a vacuum gauge on the upper end and a porous ceramic cup on the lower end (Figures 10 and 11).

### How it works

Water moves from the tensiometer tube through the ceramic cup to the soil in response to soil water suction (when water is evaporated from the soil or when the plant extracts water from the soil.) Water can also move from the soil to the tensiometer during or following irrigation. As the tensiometer loses water, a vacuum is generated in the tube and is registered by the gauge. Most tensiometers have a vacuum gauge graduated from 0 to 100 (centibars, cb, or kilopascals, kPa). A reading of 0 indicates a saturated soil. As the soil dries, the reading on the gauge increases.

The useful limit of the tensiometer is about 80 cb. Above this tension, air enters through the ceramic cup and causes the instrument to fail. Therefore, these instruments are most useful in sandy soils and with drought-sensitive crops because they have narrower soil moisture ranges. During irrigation, water returns to the tensiometer, and the gauge reading approaches 0. After several wetting and drying cycles, some air may be drawn to the tensiometer and collected below the reservoir. Some tensiometers are equipped with small water reservoirs to replace this water and reduce service required.

### Installation and reading

Before taking the first step to install the tensiometer, soak the instrument in a bucket of water for 2 or 3 days. Then carry out the following:

- Saturate the ceramic tip with water to eliminate any air bubbles.
- Fill the tube with distilled water, colored and treated with algicide. Remove air bubbles (from the tube and the vacuum gauge) by tapping the top of the reservoir gently.



**Figure 11.** Station of three tensiometers installed at different soil depths.

- Apply a strong vacuum with the hand vacuum pump until a reading of 80-85 shows on the gauge.
- Seal the cap properly.
- Check the reading you obtain with the ceramic tip immersed in water. (It should read 0 centibar.)
- Install the ceramic cup in the active root zone of the soil. Two tensiometers are needed in each site (Figure 10). For shallow root crops, such as vegetables, install one tensiometer at 6 inches and one at 12 inches deep. Install one tensiometer at 12 inches and another at 24 or 36 inches deep for deeper rooted field crops.
- Use a  $\frac{7}{8}$ -inch auger that has the same diameter as the tube to dig a hole to the desired depth (minus the height of the ceramic tip). Finish the pre-hole with a smaller diameter probe and push the tensiometer into place. Reading accuracy depends on good contact with the soil.
- Backfill and pour water around the tensiometer to improve soil contact, and pack a 3- to 4-inch mound of soil around the tube. It is also possible to backfill with mud from local soil and pour it into the hole before placing the tensiometer.

## Neutron probes

Neutron scattering is a time-tested technique for measuring total soil water content by volume. This apparatus estimates the amount of water in a volume of soil by measuring the amount of hydrogen that is present.

### How it works

The neutron probe consists of a unit made of a source of fast or high energy neutrons (encapsulated radioactive source) and a detector. This probe unit is lowered in a PVC or aluminum access tube at the desired depth with the help of clips attached to a cable. A control unit, which remains on the surface, is connected to the cable.

Fast neutrons, emitted from the source and passing through the access tube into the surrounding soil, gradually lose their energy through collisions with other atomic nuclei. Neutrons collide with hydrogen in soil moisture and slow down. Slow neutrons “bounce” back to a detector, creating an electrical impulse that is counted automatically and gives a number of neutrons per time period. Basically, this number of pulses is linearly related to the total volumetric soil water content. A higher count indicates higher soil water content. While the relationship is linear, it must be calibrated for each particular soil.

For calibration of the neutron probe, a dry and a wet site need to be established for each soil type. Neutron probe readings, gravimetric and bulk density measurements determine a calibration line with these two points. The calibration converts neutron gauge readings to volumetric water contents. Although the method is well accepted as highly accurate, the high equipment cost, licensing requirements and regulatory burden limit its application to research and to areas where extensive sampling is needed.



Figure 12. Neutron probe used at a citrus orchard.

## Advantages and disadvantages of selected soil moisture sensors

Table 4 describes some of the advantages and disadvantages of the gravimetric method, the Watermark<sup>®</sup> sensors, ECH<sub>2</sub>O Sensors, tensiometers and neutron probe.

**Table 4. Advantages and disadvantages of selected soil moisture monitoring systems.**

	<b>Advantages</b>	<b>Disadvantages</b>
Gravimetric	<ul style="list-style-type: none"> <li>• Very accurate</li> </ul>	<ul style="list-style-type: none"> <li>• Destructive</li> <li>• Requiring labor</li> <li>• Time consuming</li> </ul>
Watermark Sensors	<ul style="list-style-type: none"> <li>• Good accuracy in medium to fine soils due to their fine-sized particle similar to its inner granular matrix</li> <li>• Affordable (about \$20 per sensor, \$250 for the meter)</li> <li>• Easy handling (light weight, pocket-size, easy installation and direct reading)</li> <li>• Larger moisture reading range (0 to 200cb, or kPa)</li> <li>• Usable over several seasons with proper care</li> <li>• Continuous measurements at same location</li> </ul>	<ul style="list-style-type: none"> <li>• Slow response to changes in soil water content, rainfall or irrigation (minimum 24 hours)</li> <li>• Lack of accuracy in sandy soils due to their large particles</li> <li>• Requiring intensive labor to collect data regularly (However, it is possible to connect the Watermark<sup>®</sup> sensors to a data logger; thus, readings are collected automatically and can be downloaded through a program on a personal computer.)</li> <li>• Need for each soil type to be calibrated</li> </ul>
Capacitance sensor: ECH <sub>2</sub> O Sensors (Models EC-20, EC-10, and EC-5)	<ul style="list-style-type: none"> <li>• Ability to read soil volumetric water content directly</li> <li>• No special maintenance necessary</li> <li>• Highly accurate when sensors are installed properly in good contact with soil</li> <li>• Large range of operating environment (0 to 50°C) and range of measurement (0% to saturated water content)</li> <li>• Continuous measurements at same location</li> </ul>	<ul style="list-style-type: none"> <li>• Expensive technique (requiring PC and \$95 for the software or \$300 for the meter for manual readings) (The HOB0<sup>®</sup> data logger costs \$200, enabling several sensors to be connected. The EC Ech<sub>2</sub>o probes cost \$100 (for 1 and 10 units); they are \$70 each if 11 or more units are ordered.)</li> </ul>
Tensiometers	<ul style="list-style-type: none"> <li>• Low cost</li> <li>• Direct water potential reading for irrigation scheduling</li> <li>• Continuous measurements at same location</li> </ul>	<ul style="list-style-type: none"> <li>• Requiring periodic service</li> <li>• Operating only to 80 cb soil moisture suction (not useful in drier soil conditions)</li> </ul>
Neutron Probe	<ul style="list-style-type: none"> <li>• Considered among the most accurate methods for measuring soil water content when properly calibrated</li> <li>• Able to measure soil water at different depths several times during the growing season</li> </ul>	<ul style="list-style-type: none"> <li>• No reading accuracy for the top 6 inches of soil depth due to the escape of fast neutrons emitted from the neutron probe</li> <li>• Very expensive technique (\$3,000 to \$4,000) requiring special licensing, regular training for the operator, special handling, shipping and storage procedures</li> <li>• Radiation safety regulatory burden</li> <li>• Need for calibrating neutron probe readings against gravimetric measurements by selecting a wet and a dry spot; and for calibrating to the different soil types and depths</li> </ul>

Note: Root depths can be affected by soil and other conditions. Effective root zone depths are often shallower.  
Source: Allen et al., 1998.



## Conclusions

There are various soil moisture monitoring methods for irrigation scheduling. While each one has advantages and disadvantages, proper installation and calibration can make them effective tools. Soil moisture monitoring complements knowledge of plant water usage, soil moisture storage capacity, and root zone depth and characteristics to improve irrigation management. Optimizing irrigation by timely, adequate – but not excessive — irrigation applications promotes water conservation and profitability.

## References

Allen, R.G., Pereira, L.S., Raes, D., Smith, M., 1998. Crop Evapotranspiration-Guidelines for Computing Crop Water Requirements. FAO Irrigation and Drainage Paper 56. Rome.

Hanson, B., Orloff S., P. Douglas. 2000. *California Agriculture*, Volume 54, No. 3:38-42.

## Acknowledgment

The material in this publication is based upon work supported by the Cooperative State Research, Education and Extension Service, U.S. Department of Agriculture, under Agreement No. 2005-34461-15661 and Agreement No. 2005-45049-03209.

The information given herein is for educational purposes only. Reference to commercial products or trade names is made with the understanding that no discrimination is intended and no endorsement by Texas Cooperative Extension is implied.

Produced by Agricultural Communications, The Texas A&M University System  
Extension publications can be found on the Web at: <http://tcebookstore.org>  
Visit Texas Cooperative Extension at <http://texasextension.tamu.edu>

Educational programs conducted by Texas Cooperative Extension serve people of all ages regardless of socioeconomic level, race, color, sex, religion, handicap or national origin.

Issued in furtherance of Cooperative Extension Work in Agriculture and Home Economics, Acts of Congress of May 8, 1914, as amended, and June 30, 1914, in cooperation with the United States Department of Agriculture. Edward G. Smith, Director, Texas Cooperative Extension, The Texas A&M University System.  
500 copies, New



# Estimating Soil Moisture by Feel and Appearance (1619)

# Estimating Soil Moisture by Feel and Appearance

Irrigation Water Management (IWM) is applying water according to crop needs in an amount that can be stored in the plant root zone of the soil.

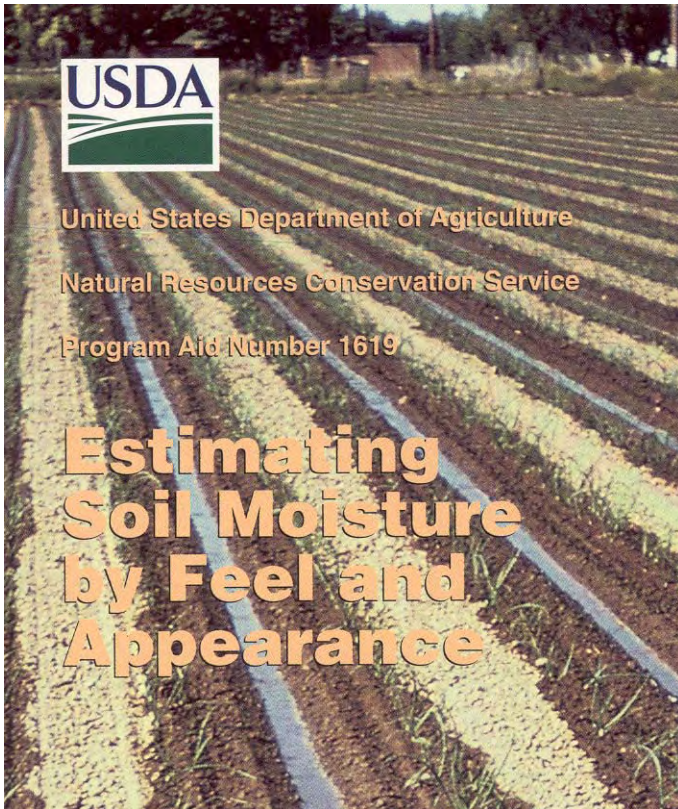

1. Obtaining a soil sample at the selected depth using a probe, auger, or shovel;
2. Squeezing the soil sample firmly in your hand several times to form an irregularly shaped "ball";
3. Squeezing the soil sample out of your hand between thumb and forefinger to form a ribbon;
4. Observing soil texture, ability to ribbon, firmness and surface roughness of ball, water glistening, loose soil particles, soil/water staining on fingers, and soil color. [Note: A very weak ball will disintegrate with one bounce of the hand. A weak ball disintegrates with two to three bounces;
5. Comparing observations with photographs and/or charts to estimate percent water available and the inches depleted below field capacity.

## Example:

Sample Depth	Zone	USDA Texture	AWC*for Zone	Soil Moisture Depletion**	Percent Depletion
6"	0-12"	sandy loam	1.4"	1.0"	70
18"	12-24"	sandy loam	1.4"	.8"	55
30"	24-36"	loam	2.0"	.8"	40
42"	36-48"	loam	$\frac{2.0"}{6.8"}$	$\frac{.5"}{3.1"}$	25

Result: A 3.1" net irrigation will refill the root zone.

\* Available Water Capacity

\*\* Determined by "feel and appearance method"

**Available Water Capacity (AWC)** is the portion of water in a soil that can be readily absorbed by plant roots of most crops.

**Soil Moisture Deficit (SMD) or Depletion** is the amount of water required to raise the soil-water content of the crop root zone to field capacity.

The "feel and appearance method" is one of several irrigation scheduling methods used in IWM. It is a way of monitoring soil moisture to determine when to irrigate and how much water to apply. Applying too much water causes excessive runoff and/or deep percolation. As a result, valuable water is lost along with nutrients and chemicals, which may leach into the ground water.

The feel and appearance of soil vary with texture and moisture content. Soil moisture conditions can be estimated, with experience, to an accuracy of about 5 percent. Soil moisture is typically sampled in 1-foot increments to the root depth of the crop at three or more sites per field. It is best to vary the number of sample sites and depths according to crop, field size, soil texture, and soil stratification. For each sample the "feel and appearance method" involves:

## Appearance of fine sand and loamy fine sand soils at various soil moisture conditions.

### Available Water Capacity 0.6-1.2 inches/foot

**Percent Available:** Currently available soil moisture as a percent of available water capacity.

**In/ft. Depleted:** Inches of water currently needed to refill a foot of soil to field capacity.

**0-25 percent available  
1.2-0.5 in./ft. depleted**

Dry, loose, will hold together if not disturbed, loose sand grains on fingers with applied pressure. (Not pictured)



**50-75 percent available  
0.6-0.2 in./ft. depleted**

Moist, forms a weak ball with loose and aggregated sand grains on fingers, darkened color, moderate water staining on fingers, will not ribbon.



**25-50 percent available  
0.9-0.3 in./ft. depleted**

Slightly moist, forms a very weak ball with well-defined finger mark



**75-100 percent available  
0.3-0.0 in./ft. depleted**

Wet, forms a weak ball, loose and aggregated sand grains remain on fingers, darkened color, heavy water staining on fingers, will not ribbon

**100 percent available  
0.0 in./ft. depleted (field capacity)**

Wet, forms a weak ball, moderate to heavy soil/water coating on fingers, wet outline of soft ball remains on hand. (Not pictured)

## Appearance of sandy loam and fine sandy loam soils at various soil moisture conditions.

### **Available Water Capacity** **1.3-1.7 inches/foot**

**Percent Available:** Currently available soil moisture as a percent of available water capacity.

**In/ft. Depleted:** Inches of water currently needed to refill a foot of soil to field capacity.

**0-25 percent available**  
**7-1.0 in./ft. depleted**

Dry, forms a very weak ball, aggregated soil grains break away easily from ball. (Not pictured)



**25-50 percent available**  
**1.3-0.7 in./ft. depleted**

Slightly moist, forms a weak ball with defined finger marks, darkened color, no water staining on fingers, grains break away.



**50-75 percent available**  
**0.9-0.3 in./ft. depleted**

Moist, forms a ball with defined finger marks, very light soil/water staining on fingers, darkened color, will not slick.



**75-100 percent available**  
**0.4-0.0 in./ft. depleted**

Wet, forms a ball with wet outline left on hand, light to medium staining on fingers, makes a weak ribbon between the thumb and forefinger.

**100 percent available**  
**0.0 in./ft. depleted (field capacity)**

Wet, forms a soft ball, free water appears briefly on soil surface after squeezing or shaking, medium to heavy soil/water coating on fingers. (Not pictured)

## Appearance of sandy clay loam, loam, and silt loam soils at various soil moisture conditions.

### **Available Water Capacity** **1.5-2.1 inches/foot**

**Percent Available:** Currently available soil moisture as a percent of available water capacity.

**In/ft. Depleted:** Inches of water currently needed to refill a foot of soil to field capacity.

**0-25 percent available**  
**2.1-1.1 in./ft. depleted**

Dry, soil aggregations break away easily, no staining on fingers, clods crumble with applied pressure. (Not pictured)



**50-75 percent available**  
**1.1-0.4 in./ft. depleted**

Moist, forms a ball, very light staining on fingers, darkened color, pliable, forms a weak ribbon between the thumb and forefinger.



**25-50 percent available**  
**1.6-0.8 in./ft. depleted**

Slightly moist, forms a weak ball with rough surfaces, no water staining on fingers, few aggregated soil grains break away.



**75-100 percent available**  
**0.5-0.0 in./ft. depleted**

Wet, forms a ball with well-defined finger marks, light to heavy soil/water coating on fingers, ribbons between thumb and forefinger.

**100 percent available**  
**0.0 in./ft. depleted (field capacity)**

Wet, forms a soft ball, free water appears briefly on soil surface after squeezing or shaking, medium to heavy soil/water coating on fingers. (Not pictured)

## Appearance of clay, clay loam, and silt clay loam soils at various soil moisture conditions.

### **Available Water Capacity** **1.6-2.4 inches/foot**

**Percent Available:** Currently available soil moisture as a percent of available water capacity.

**In/ft. Depleted:** Inches of water currently needed to refill a foot of soil to field capacity.

**0-25 percent available**  
**2.4-1.2 in./ft. depleted**

Dry, soil aggregations separate easily, clods are hard to crumble with applied pressure. (Not pictured)



**50 - 75 percent available**  
**1.2-0.4 in./ft. depleted**

Moist, forms a smooth ball with defined finger marks, light soil/water staining on fingers, ribbons between thumb and forefinger.



**25-50 percent available**  
**1.8-0.8 in./ft. depleted**

Slightly moist, forms a weak ball, very few soil aggregations break away, no water stains, clods flatten with applied pressure.



**75-100 percent available**  
**0.6-0.0 in./ft. depleted**

Wet, forms a ball, uneven medium to heavy soil/water coating on fingers, ribbons easily between thumb and forefinger.

**100 percent available**  
**0.0 in./ft. depleted (field capacity)**

Wet, forms a soft ball, free water appears on soil surface after squeezing or shaking, thick soil/water coating on fingers, slick and sticky. (Not pictured)

## Guidelines for Estimating Soil Moisture Conditions

	Coarse Texture- Fine Sand and Loamy Fine Sand	Moderately Coarse Texture Sandy Loam and Fine Sandy Loam	Medium Texture - Sandy Clay Loam, Loam, and Silt Loam	Fine Texture- Clay, Clay Loam, or Silty Clay Loam
<b>Available Water Capacity (Inches/Foot)</b>				
	0.6-1.2	1.3-1.7	1.5-2.1	1.6-2.4
<b>Available Soil Moisture Percent</b>	Soil Moisture Deficit (SMD) in inches per foot when the feel and appearance of the soil are as described.			
<b>0-25</b>	Dry, loose, will hold together if not disturbed, loose sand grains on fingers with applied pressure.  SMD 1.2-0.5	Dry, forms a very weak ball, aggregated soil grains break away easily from ball.  SMD 1.7 -1.0	Dry. Soil aggregations break away easily. no moisture staining on fingers, clods crumble with applied pressure.  SMD 2.1-1.1	Dry, soil aggregations easily separate, clods are hard to crumble with applied pressure  SMD 2.4-1.2
<b>25-50</b>	Slightly moist, forms a very weak ball with well-defined finger marks, light coating of loose and aggregated sand grains remain on fingers.  SMD 0.9-0.3	Slightly moist, forms a weak ball with defined finger marks, darkened color, no water staining on fingers, grains break away.  SMD 1.3-0.7	Slightly moist, forms a weak ball with rough surfaces, no water staining on fingers, few aggregated soil grains break away.  SMD 1.6-0.8	Slightly moist, forms a weak ball, very few soil aggregations break away, no water stains, clods flatten with applied pressure  SMD 1.8-0.8
<b>50-75</b>	Moist, forms a weak ball with loose and aggregated sand grains on fingers, darkened color, moderate water staining on fingers, will not ribbon.  SMD 0.6-0.2	Moist, forms a ball with defined finger marks. very light soil/water staining on fingers. darkened color, will not slick.  SMD 0.9-0.3	Moist, forms a ball, very light water staining on fingers, darkened color, pliable, forms a weak ribbon between thumb and forefinger.  SMD 1.1- 0.4	Moist. forms a smooth ball with defined finger marks, light soil/water staining on fingers, ribbons between thumb and forefinger.  SMD 1.2-0.4
<b>75-100</b>	Wet, forms a weak ball, loose and aggregated sand grains remain on fingers, darkened color, heavy water staining on fingers, will not ribbon.  SMD 0.3-0.0	Wet, forms a ball with wet outline left on hand, light to medium water staining on fingers, makes a weak ribbon between thumb and forefinger.  SMD 0.4-0.0	Wet, forms a ball with well defined finger marks, light to heavy soil/water coating on fingers, ribbons between thumb and forefinger.  SMD 0.5 -0.0	Wet, forms a ball, uneven medium to heavy soil/water coating on fingers, ribbons easily between thumb and forefinger.  SMD 0.6-0.0
<b>Field Capacity (100 %)</b>	Wet, forms a weak ball, moderate to heavy soil/ water coating on fingers, wet outline of soft ball remains on hand.  SMD 0.0	Wet, forms a soft ball, free water appears briefly on soil surface after squeezing or shaking, medium to heavy soil/water coating on fingers.  SMD 0.0	Wet, forms a soft ball, free water appears briefly on soil surface after squeezing or shaking, medium to heavy soil/water coating on fingers.  SMD 0.0	Wet, forms a soft ball, free water appears on soil surface after squeezing or shaking, thick soil/water coating on fingers, slick and sticky.  SMD 0.0

The United States Department of Agriculture (USDA) prohibits discrimination in its programs and activities on the basis of race, color, national origin, gender, religion, age, disability, political beliefs, sexual orientation, and marital or family status. (Not all prohibited bases apply to all programs.) Persons with disabilities who require alternative means for communication of program information (Braille, large print, audiotape, etc.) should contact the USDA's TARGET Center at 202-720-2600 (voice and TDD).

To file a complaint of discrimination, write USDA, Director, Office of Civil Rights, Room 326W, Whitten Building, 14th and Independence Avenue, SW, Washington, DC, 20250-9410 or call 202-720-5964 (voice or TDD). USDA is an equal opportunity provider and employer.



# *IRRIGATION TECHNOLOGIES & BEST MANAGEMENT PRACTICES*



**Surface Irrigation**

**Center Pivot Irrigation**

**Microirrigation**

**Conservation Tillage**



# Surface Irrigation

## In this Section

Overview: Surface Irrigation

Reference: Using Flexible Pipe with Surface Irrigation (L 5469)

Reference: Managing Furrow Irrigation Systems (L-913)

## Overview

### Objectives:

- Increase understanding of irrigation efficiency, losses, and distribution uniformity associated with surface irrigation.
- Increase understanding and application of best management practices to improve efficiency and uniformity of surface irrigation.

### Key Points:

1. Surface irrigation uses gravity flow to spread water over a field. With flood irrigation, the entire land area to be irrigated is covered with water. Furrow irrigation utilizes small channels or ditches between planted rows to convey water across a field.
2. Using pipe systems to convey and distribute water increases on-farm irrigation efficiency, provides better irrigation control, and reduces labor costs.
3. The correct amount of water to apply at each irrigation depends on the amount of soil water used by the plants between irrigations, the water-holding capacity of the soil, and the depth of the crop roots. Applying the right amount of water to an irrigation set does not guarantee efficient irrigation. Water also must be uniformly applied from one end of the irrigation run (field) to the other.
4. Best management practices to consider include precision land leveling, gated pipe, surge flow irrigation, irrigation scheduling, recirculating irrigation runoff (tailwater re-use), and alternate furrow application.



## *Surface Irrigation*

### **Assess your knowledge:**

1. Describe flood, furrow, and level basin irrigation.
2. Which factors affect the uniformity of water application?
3. Name three advantages of using pipe systems to convey and distribute water.
4. Describe two other best management practices that can reduce water losses.



## Surface Irrigation

Surface irrigation uses gravity flow to spread water over a field. Surface systems are the least expensive to install, but have high labor requirements for operation compared to other irrigation methods. Skilled irrigators also are needed in order to achieve good efficiencies. Even if properly designed, surface systems tend to have low water application efficiencies than more advanced irrigation technologies.

### Surface Methods

With **flood irrigation**, the entire land area to be irrigated is covered with water. There may be no method of controlling water flow other than the topography of the land.

**Furrow irrigation** utilizes small channels or ditches between planted rows to convey water across a field. As water infiltrates through the furrow, it is then moved within the soil both laterally and vertically to saturate the soil profile.

With **level basin** irrigation, water is applied over a short period of time to a completely level area enclosed by dikes or borders. The floor of the basin may be flat, ridged or shaped into beds. Basin irrigation is most effective on uniform soils precisely leveled when large stream sizes relative to basin area are available.

### Selection and Applications

#### Application Rates

The correct amount of water to apply at each irrigation depends on the amount of soil water used by the plants between irrigations, the water-holding capacity of the soil, and the depth of the crop roots. The rate at which water goes into the soil varies from one irrigation to the next and from season to season.

In general, to avoid completely refilling the root zone in sandy textured soils, gross application amounts should not exceed 1.5 to 2 inches. On medium to fine textured soils they should not exceed 2.5 to 3 inches.

Applying the right amount of water to an irrigation set does not guarantee efficient irrigation. Water also must be uniformly applied from one end of the irrigation run (field) to the other. Crop yields can be reduced on both ends of the field if one end receives too much water and the other end receives too little water.

#### Set Time-Stream Size

Select a stream size appropriate for the slope, intake rate, and length of run. Runoff and the uniformity of water infiltrated along the furrow are related to the cutoff ratio. This is the ratio of the time required for water to advance to the end of the furrow to the total set time used for the irrigation. A cutoff ratio of 0.5 is desired. For example, for a 12-hour set time, the advance time should be about six hours. The easiest way to change the advance time is by altering the furrow stream size, i.e. by changing the size of the irrigation set. This will affect the cutoff ratio and hence the uniformity of water application.



## *Surface Irrigation*

The best combination of furrow stream size and set time moves water to the end of the furrow within the requirements of the cutoff ratio, is less than the maximum erosive stream size, and results in gross applications that are not excessive.

### **Length of Run**

Irrigation runs which are too long result in water being lost by deep percolation at the head of the furrow by the time the lower end is adequately irrigated. The length of irrigation runs should not exceed 600 feet on sandy soils and about 1300 feet on clay soils. However, on some low intake rate soils, the length of run may be as long as 2600 feet and water should still be distributed uniformly between the upper and lower end of the field. The time required for advance increases dramatically with furrow length. If you have a problem getting rows through in a reasonable length of time (as determined by the cutoff ratio) and you are using the maximum allowable non-erosive stream size, shortening the row length is an alternative for reducing advance time.

### **Intake Rates**

The rate at which water penetrates into the soil varies with the steepness of slope, soil texture, spacing of furrows, and soil compaction. The rate at which soil will absorb water varies with time. At first, water will penetrate rapidly into the soil, but within one or two hours it will decrease to a rate which stays relatively consistent for the remainder of the irrigation. This fairly consistent rate is called basic intake rate. If the basic intake rate is 0.5 inches per hour or less, the length of run can be 1300 feet long. Higher intake rates require shorter water runs.

### **Distribution and Delivery Systems**

Using pipe systems (rather than earthen ditches) to convey and distribute water to fields has several advantages:

- Increased on-farm irrigation efficiency. Avoid water loss due to deep percolation from earthen conveyance ditches.
- Better irrigation control. Fluctuations in irrigation-canal water levels are common. Using earthen ditches and siphon tubes requires intensive labor to avoid water spillage as a result of such fluctuations (for example, siphon tubes may lose their vacuums and stop working). In contrast, a pipe-irrigation system needs only to have an outlet opened to deliver water through the pipe to furrows; irrigation can be left unattended, even when fluctuations in water levels occur.
- Labor savings. In the Rio Grande Valley, water is distributed through canals coming from the river and is delivered at different outlets (called turnouts). Systems are designed to deliver one “head” of water at each turnout (one head equals approximately 3 cfs or 1,346 gpm). One turnout is installed for each 40-acre field. Some field-blocks are larger than 40 acres, and several fields may be irrigated at the same time. With gated pipe or poly pipe irrigation systems, one irrigator can control six to eight irrigation fronts.



# Surface Irrigation

## Surface Method Best Management Practices

**Precision land leveling** improves water application efficiency. Leveling land is cost effective on many sites, and will pay for itself by increasing yields and reducing water losses.

**Gated pipe** can result in a 35 to 60 percent reduction in water and labor costs. Gated pipe provides a more equal distribution of water into each furrow and eliminates seepage and evaporative losses which occur in unlined irrigation ditches. Gated pipe is available as the traditional aluminum pipe, the less expensive low-head PVC pipe, and the inexpensive “lay-flat” plastic tubing (also called “poly-pipe”).

**Surge flow irrigation** is a variation of continuous-flow furrow irrigation. Water is usually applied in cycles of one to three hours of alternating on-off periods. Surge works by taking advantage of the natural surface sealing properties of many soils. Surge often results in increased irrigation efficiencies and gives the grower the ability to apply smaller amounts of water at more frequent intervals. Automatic surge valves are also appealing because of reduction in labor.

**Irrigation scheduling** by use of evapotranspiration data is beneficial to irrigators by providing additional management information on their crop needs. Irrigation scheduling is a method of determining both the time of irrigation application and, within the limits of the flood system distribution, the size of application to make the most efficient use of water.

**Recirculating irrigation runoff** water (also called “tailwater reuse”) is a method of making more effective use of irrigation water and labor. Reuse of runoff water decreases the amount of water that needs to be pumped or delivered and can be used to improve water application efficiencies by approximately 20 percent. Growers who don’t have reuse systems often cut the stream size in the furrow to a very small flow in order to minimize runoff, possibly causing an uneven water distribution pattern.

**Alternate furrow application** supplies water to one side of each row. The result is applying water to more acres than irrigating every furrow from a given water source in a given time. Irrigating every other furrow is often beneficial on soils with high infiltration rates and low water-holding capacities. Finally, alternate furrow irrigation effectively reduces the wetted surface area from which evaporation can occur.



## Using Flexible Pipe with Surface Irrigation (L 5469)



# Using Flexible Pipe (poly-pipe) with Surface Irrigation

Juan Enciso and Xavier Peries\*

Aimed at farmers and irrigators who want to irrigate their crops using flexible plastic pipes (commonly called “poly-pipe”), this publication highlights (1) advantages of using poly-pipe, (2) factors to consider in selecting such pipe, and (3) considerations for installing it.

## Advantages of Using Pipes to Deliver Irrigation Water

Using pipe systems (rather than earthen ditches) to convey and distribute water to fields has several advantages:

- **Increases in on-farm irrigation efficiency**, by avoiding water loss due to deep percolation from earthen conveyance ditches.
- **Better irrigation control.** Fluctuations in irrigation-canal water levels are common. Using earthen ditches and siphon tubes requires intensive labor to avoid water spillage as a result of such fluctuations (for example, siphon tubes may lose their vacuums and stop working). In contrast, a pipe-irrigation system needs only to have an outlet opened to deliver water through the pipe to furrows; irrigation can be left unattended, even when fluctuations in water levels occur.

- **Labor savings.** In the Rio Grande Valley, water is distributed through canals coming from the river and is delivered at different outlets (called turnouts). Systems are designed to deliver one “head” of water at each turnout (one head equals approximately 3 cfs or 1,346 gpm). One turnout is installed for each 40-acre field. Farmers may have field-blocks larger than 40 acres, and sometimes farmers may irrigate several fields at the same time. With pipe-irrigation systems, one irrigator can control six to eight irrigation fronts.

## Types of Pipes Used to Deliver Water

Both gated pipes and poly-pipes can convey and deliver irrigation water. Gated pipes are rigid, made of aluminum or PVC, and generally less than 12 inches in diameter. Poly-pipes are expensive but are flexible and expand when full, are made from polyethylene resins, and generally are used for the larger pipe diameters needed to irrigate furrow crops.

## Selecting the Correct Type of Poly-pipe

The most important of several pipe-selection characteristics are thickness and diameter (see Table 1). Thickness determines pipe durability. Some farmers prefer thinner poly-pipe (6 mil); because poly-pipe is sold by weight, they can save money by economizing on thickness. Poly-pipes also come in larger thicknesses (15 mil), allowing more pressure to be contained (up to 5 feet of water head or 2.15 psi).

\*Assistant Professor and Extension Agricultural Engineering Specialist (Irrigation and Water Management); Extension Associate – Biological and Agricultural Engineering Department; Texas Cooperative Extension, The Texas A&M University System



Pipe diameter should be selected based on irrigation flow-rate. Table 1 provides some approximate diameters and thicknesses needed for selected flow-rates. Larger diameters will yield less friction with less head loss, permitting longer runs (1,320 feet or more). Pipe outlets for discharging water to fields are made with a hole puncher after the poly-pipe has been laid out (see illustrations), with outlet size influencing furrow stream-size. The most common outlet sizes are ½, 1 and 2 inches.

Table 1. Poly-Pipe Characteristics.

Diameter (inches)	Thickness (mil)	Maximum pressure (max psi)	Maximum head (ft)	Gallons/Minute (gpm)
8	10	1.30	3	400
10	6	0.86	2	500
10	10	1.30	3	600
12	6	0.86	2	800
12	10	1.30	3	1,000
16	6	0.86	2	1,800
16	10	1.30	3	2,000
18	6	0.86	2	2,500
18	10	1.30	3	2,700
22	10	1.30	3	3,800

## Economics of Poly-Pipe Irrigation

The main expense associated with poly-pipe is its initial cost. Labor costs are minimal, since installation takes two workers just half a day. Once installed, poly-pipe remains in position for an entire season. Poly-pipe can be used for as many as three irrigation seasons if it is handled carefully to avoid damage and stored between seasons in a dry place out of direct sunlight.

Poly-pipe prices vary according to manufacturer and depending on characteristics such as UV-resistance, diameter and thickness (see Table 2). Price also varies depending on amount of pipe purchased. Prices reported in Table 2 represent 2005 averages for three different

Table 2. Prices for different poly-pipe diameters and thickness.

Diameter (inches)	Thickness (mil)	Price/1,320 ft unit (U.S. \$)
5	9	115.20
10	10	215.69
12	9	203.00
12	10	231.66
15	9	262.96
15	10	278.00
18	9	296.42
18	10	340.53
22	9	383.30

manufacturers and are based on standard tubing length of 1,320 feet. Poly-pipe generally comes in one of two colors, white or blue.

Plugs are used to stop water discharge from pipe outlets. Plug prices vary according to opening size, rang-

ing from 4 cents per unit for ½-inch plugs to 20 cents per unit for 2-inch plugs. Gate holes also are available (\$1.25 per unit for 2-inch size) and permit better irrigation control. Larger outlet sizes allow larger stream-size and faster advance and may be preferable for irrigating long, sandy furrows or furrows containing considerable harvest residue.

## Installing Poly-Pipe

Materials required for poly-pipe installation include

- Tractor with furrower tool and unspooling bracket
- Poly-pipe rolls
- Pump or valve for connection
- Clamps, rubber straps, or duct tape
- Shovel
- PVC connectors (if more than one roll is used)
- Hole puncher with plugs

Prior to poly-pipe installation, fields should be leveled. Poly-pipe should be installed only on flat surfaces or down-hill, never up-hill. A minimum of 6 inches of water head (water surface height above the pipe) is required for poly-pipe use.

Poly-pipe installation steps are as follows:

1. Open the box containing the poly-pipe roll and check pipe condition.
2. Use a furrower to dig a trench (Fig. 1). (A furrower is a V-shaped cutting blade with wings that deflect soil upward and away from the center point of the V to form a ridge or furrow.) The furrow should be deep enough to accommodate about 50% of the poly-pipe's diameter and 100% of its width to avoid any rolling to the side. The trench should be built up to an elevation slightly higher than that of the irrigated furrows to avoid water return. If the field block is curved along its edge, the curve should be no sharper than 70°, preferably with an 8-foot radius.



Figure 1. Making the trench with a furrower.

3. Mount poly-pipe on an unspooling bracket so it is ready to roll out (Fig. 2).



**Figure 2. Poly-pipe set with an unspooling bracket.**

4. Stretch the poly-pipe gently into its trench (until pulling tension disappears), while someone holds onto it at the supply-pipe end. Use a shovel to place dirt on top of the poly-pipe at 10-foot intervals (approximately) to keep it in place and prevent it from being moved by the wind. (Fig. 3). Allow a few extra inches of poly-pipe at any curves to avoid excessive tension as the pipe fills with water.



**Figure 3. Placing dirt on poly-pipe at 10-foot intervals.**

5. Use clamps, rubber straps, string, or even duct tape (Figs. 4a and 4b) to connect the poly-pipe tightly to valves or supply-pipe fittings. Discharge-pipe diameter does not have to match that of the poly-pipe, which can be larger. If the pipe supplying water is at a higher elevation than the ground on which the poly-pipe will rest, build a soil ramp to support the poly-pipe at the connection point so that the poly-pipe does not hang freely in the air. At the point where the poly-pipe connects to the supply pipe, turn the poly-pipe tubing back onto itself for a distance of about a foot. Pressure inside the poly-pipe is likely to be greatest at this connection point, so the extra tubing will provide resistance to prevent the poly-pipe from separating from the clamp. Whenever more than one



**Figure 4a. Poly-pipe connected tightly to the supplying pipe.**



**Figure 4b. Using rubber straps to connect the poly-pipe to the supplying pipe.**

roll of poly-pipe is needed, connect the rolls with a corrugated pipe (Figs. 5a, 5b and 5c). Be sure to roll each end back on itself (as previously described) before strapping it to the supply pipe (Fig. 4a).



**Figure 5a. Connecting two rolls of poly-pipe.**



**Figure 5b. Using a corrugated PVC pipe to connect two rolls of poly-pipe.**



**Figure 5c. Making a tight connection to avoid water leaks.**

At the end of the poly-pipe, build a mount (or place an object) up to 2 feet high to stop water flow; that way, if too many poly-pipe outlets are closed, developing pressure, the water will just flow over the elevated mount without damaging the pipe.

6. Filling can now begin. Open valves slowly and gradually. As the poly-pipe fills with water, create a vent 10 feet from the discharge-pipe connection point by punching a small hole with a pencil in the top of the poly-pipe; additional holes may be necessary at spots further along the poly-pipe to avoid air build-up, which can limit water flow and increase pressures inside pipes.

7. Once the poly-pipe is completely full and has expanded, then the hole puncher can be used to punch holes in front of each row to be irrigated (Fig. 6 and 7), at points between the 2 and the 3 o'clock



**Figure 6.** Hole puncher, plugs, and gates for poly-pipe.



**Figure 7.** Using poly-pipe hole puncher.

positions. If necessary, increase water flow in order to make the last holes.

8. To make new holes, install plugs in old holes, then continue to punch new holes until they all have been finished. When a set of new furrows needs to be irrigated, the holes used in previous irrigations should be closed with plugs (Fig. 8a and 8b). When irrigation is finished, leave plugs inserted in the poly-pipe. Always use plastic plugs larger than the poly-pipe holes.



**Figure 8a.** Inserting plugs in poly-pipe.



**Figure 8b.** Gate holes used to irrigate sugarcane.

Produced by Agricultural Communications, The Texas A&M University System  
Extension publications can be found on the Web at: <http://tcebookstore.org>  
Visit Texas Cooperative Extension at <http://texasextension.tamu.edu>

*Educational programs conducted by Texas Cooperative Extension serve people of all ages regardless of socioeconomic level, race, color, sex, religion, handicap or national origin.*

Issued in furtherance of Cooperative Extension Work in Agriculture and Home Economics, Acts of Congress of May 8, 1914, as amended, and June 30, 1914, in cooperation with the United States Department of Agriculture. Edward G. Smith, Director, Texas Cooperative Extension, The Texas A&M University System.



# Managing Furrow Irrigation Systems (L-913)

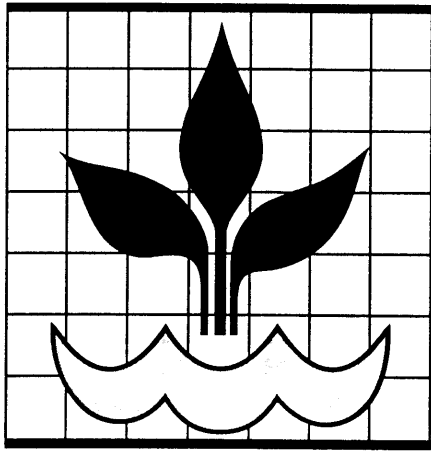

# IRRIGATION MANAGEMENT S E R I E S

## MANAGING FURROW IRRIGATION SYSTEMS

Danny H. Rogers  
Extension Agricultural Engineer

Cooperative Extension Service  
Manhattan, Kansas

Reprinted from  
Neb-Guide G91-1021  
University of Nebraska-Lincoln

Proper furrow irrigation practices can minimize water application, irrigation costs, and chemical leaching, and can result in higher crop yields.

Irrigating the entire field as quickly as possible is often the goal of a furrow irrigator. Often irrigators are satisfied just to get the water to the end of the furrows, but consideration should be given to how much water is being applied and how it is distributed.

The number of gates opened or tubes set—the set size—has a significant impact on how fast the water advances across the field and the amount of water being applied. Set size should change during the season and between years to match changing soil intake conditions. Operating too few gates or tubes and using a long set time can result in a large amount of runoff; however, operating too many gates or tubes can result in slow water advance, causing poor water distribution and deep percolation losses (Figure 1 a). These conditions result in reduced irrigation efficiency.

Efficient irrigation is obtained by almost filling the effective crop root zone each irrigation, applying water uniformly (Figure 1 a), and by either minimizing or utilizing runoff. For furrows, runoff and the uniformity of the water infiltrated along the furrow are related to soil intake rate and the irrigator's management practices.

## EVALUATING AND CHANGING CURRENT PRACTICES

The correct amount of water to apply at each irrigation depends on the amount of soil water used by the plants between irrigations, the water-holding capacity of the soil, and the depth of the crop roots. The rate at which water goes into the soil varies from one irrigation to the next and from season to season. One common problem in furrow irrigation is that too much water is applied, especially during the first irrigation.

In general, apply water when the crop has used about one-half of the available water capacity in the root zone.

When applying water, don't completely fill or overflow the root zone. Overfilling leaches chemicals, such as nitrate-nitrogen; wastes water; and increases costs. Leave room in the soil for storing about one-half to one inch of rainfall that might occur soon after you irrigate.

Corn is furrowed for irrigation when it is about 24 to 30 inches high. At this stage the roots have penetrated about 18 to 24 inches into the soil, so irrigation water should not be applied deeper than 18 inches. During a normal season in Kansas, precipitation has replenished the soil profile below this depth

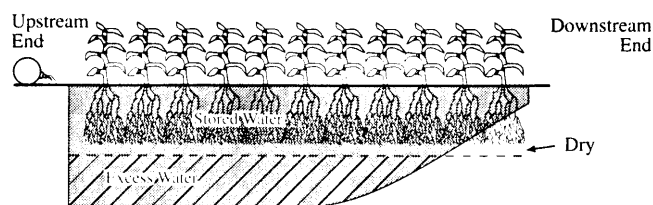

1a. Poor uniformity — adjust stream size and set time.

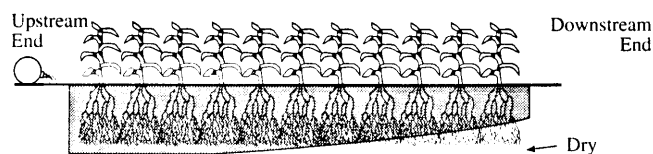

1b. Ideal infiltration pattern

Figure 1. Infiltration patterns with furrow irrigation.

Figure 1. Infiltration patterns with furrow irrigation.

and additional moisture is not needed for plant development. Usually, on medium-textured soils, 1.5 to 2.0 inches of water is all that is necessary to replenish the soil moisture in the top 18 to 24 inches of soil.

To evaluate present practices, estimate the gross depth and uniformity of application. The gross depth of water being applied can be as follows:

$$\text{Stream size (gpm* per furrow)} = \frac{\text{Pump discharge (gpm)}}{\text{set size (number of furrows)}}$$

$$\text{Gross depth of applied water (inches)} = \frac{1155 \times S \times H}{L \times D}$$

Where: S = Stream Size (gpm/furrow)  
 H = Hours & water applied  
 L = Length of furrow (feet)  
 D = Distance between furrows (inches)  
 \*gpm = gallon per minute

For example, consider the following situation:

$$\begin{aligned} &\text{Pump producing 750 gpm} \\ &\text{Set size (number of furrows)} = 100 \\ &\text{Stream size} = \frac{750 \text{ gpm}}{100} \\ &= 7.5 \text{ gpm per furrow} \end{aligned}$$

Water is applied for 12 hours  
 Rows are 1320 feet long  
 Distance between watered furrows is 30 inches

$$\begin{aligned} \text{Gross depth applied} &= \frac{1155 \times 7.5 \times 12}{1320 \times 30} \\ &= 2.6 \text{ inches} \end{aligned}$$

Knowing this information will help you make better management decisions and improve the overall performance of your irrigation system. In general, to avoid completely refilling the root zone in sandy textured soils, gross application amounts should not exceed 1.5 to 2 inches. On medium to fine textured soils they should not exceed 2.5 to 3 inches.

Applying the right amount of water to your irrigation set does not guarantee efficient irrigation. Water also must be uniformly applied from one end of the irrigation run (field) to the other. Crop yields can be reduced on both ends of the field if one end receives too much water and the other end receives too little water.

## SET TIME-STREAM SIZE

Select a stream size appropriate for the slope, intake rate, and length of run. Runoff and the uniformity of water infiltrated along the furrow are related to the cutoff ratio. This is the ratio of the time required for water advance to the end of the furrow to the total set time used for the irrigation. A cutoff ratio of 0.5 is desired. For example, for a 12-hour set time, the advance time should be about six hours. The easiest way to change the advance time is by altering the furrow stream size, i.e. by changing the size of the irrigation set. This will affect the cutoff ratio and hence the uniformity of water application.

When selecting the furrow stream size, consider furrow erosion. Use a furrow stream that does not cause serious erosion. In general, the maximum non-erosive stream size decreases as furrow slope increases.

The stream size selected should be less than the value given in Table 1, but still large enough to obtain relatively uniform water application. With the proper cutoff ratio and gross application, you can achieve uniform water application and minimize deep percolation and runoff. Try different combinations of furrow stream size and set time. The best combination is the one which moves water to the end of the furrow within the requirements of the cutoff ratio, is less than the maximum erosive stream size, and results in gross applications that are not excessive.

**Table 1. Maximum furrow stream to minimize erosion for various slopes (from the Soil Conservation Service).**

Slope (%)	Stream Size (gpm)
0.20	50.0
0.40	30.0
0.75	17.0
1.25	10.0

For example, consider the following situation:

System flow = 760 gpm  
 80 gates opened  
 Set time = 24 hours  
 Advance time = 18 hours (from observation)  
 Furrow stream size = 9.5 gpm/furrow (760 ÷ 80)  
 Furrow length = 2600 feet  
 Furrow spacing (distance between watered furrows) = 30 inches  
 Soil = silt loam  
 Current cutoff ratio = 0.75 (i.e. 18 ÷ 24)

Two items need to be evaluated. First, the cutoff ratio is too high and should be reduced from 0.75 to 0.50. Secondly, the gross water applied is slightly excessive. It is calculated by:

$$\begin{aligned} \text{Gross depth applied} &= \frac{1155 \times 9.5 \times 24}{2600 \times 30} \\ &= 3.4 \text{ inches} \end{aligned}$$

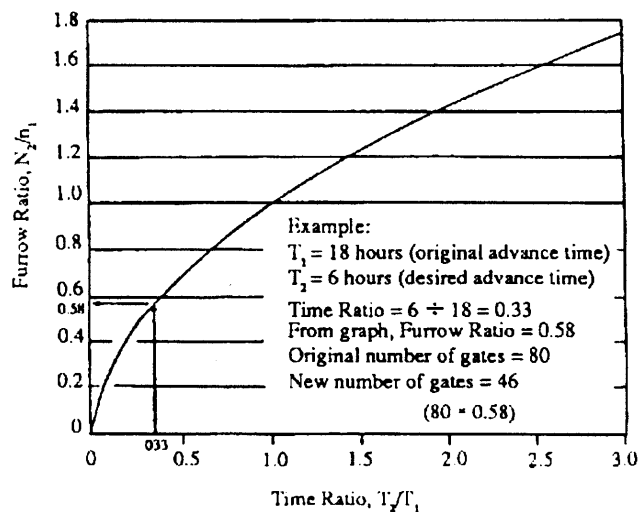

**Figure 2. Graph for determining proper set size.**

One way of reducing the gross application is to reduce set time. In this example, we will increase the rate of advance by increasing the furrow stream size and decreasing gross water applied by reducing the set time to 12 hours. Use Figure 2 to determine the number of furrows to irrigate for different advance times.

For silt loam soils, 2.9 inches gross depth is within the allowable range. Also, if the furrow slope is less than 0.75 percent, the 16.5 gpm stream size is within non-erosive limits.

In this example, we have demonstrated 1) how to improve the uniformity of irrigation by reducing the cutoff ratio; and 2) how to reduce the gross depth of application by reducing irrigation set time.

### LENGTH OF RUN

Irrigation runs which are too long result in water being lost by deep percolation at the head of the furrow by the time the lower end is adequately irrigated.

The length of irrigation runs should not exceed 600 feet on sandy soils and about 1300 feet on clay soils. However, on some low intake rate soils, the length of run maybe as long as 2600 feet and water should still be distributed uniformly between the upper and lower end of the field.

The time required for advance increases dramatically with furrow length. This is illustrated in Figure 3. Here, the time to advance water 2600 feet is three times longer than the time for 1300 feet. Thus, if you have a problem getting rows through in a reasonable length of time (as determined by the cutoff ratio) and you are using the maximum allowable nonerosive stream size, shortening the row length is an alternative for reducing advance time.

### INTAKE RATES

The rate at which water penetrates into the soil varies with the steepness of slope, soil texture, spacing of furrows, and soil compaction. The rate at which soil will absorb water varies with time. At first, water will penetrate rapidly into the soil, but within one or two hours it will decrease to a rate which stays relatively consistent for the

remainder of the irrigation. This fairly consistent rate is called basic intake rate. If the basic intake rate is 0.5 inches per hour or less, the length of run can be at least 1300 feet long. Higher intake rates require shorter water runs.

### EVERY OTHER FURROW IRRIGATION

When irrigation is required it becomes important to irrigate the entire field as quickly as possible. Irrigating every other furrow will supply water to one side of each row. The result is applying water to more acres than irrigating every furrow from a given water source in a given time. Irrigating every other furrow is often beneficial on soils with high infiltration rates and low water-holding capacities.

Often, irrigators encounter higher soil intake rates during the first irrigation. This can result in applying more water during the first irrigation than in subsequent irrigations and requires more hours to irrigate a field from a given water supply.

Another consideration is the ability to store rainfall in a soil that was recently irrigated. If water has been applied to every furrow, the entire root zone may have been refilled to field capacity prior to rainfall. Irrigating every other furrow and applying less water per irrigation may provide more storage space within the root zone for rainfall.

Figure 4 shows the lateral and downward infiltration of water for two soil types where every other furrow is irrigated. When the watered furrow spacing is too wide, there will be a dry area in between the furrows and the crop may not get enough water. The distance between watered furrows should never exceed 6 feet.

Research indicates that fields irrigated in every other furrow have yields which compare closely to fields with every furrow irrigation. Table 2 shows corn yields on various soil textures when irrigating every furrow and every other furrow with a manually operated surface irrigation system with 12 hour irrigation sets.

Recommended Changes	Current Example	Your Example
Desired cutoff ratio =	0.50	_____
Thus, new advance time = i.e. (0.5 x 12)	6 hrs.	_____
Time Ratio = new time ÷ old time = 6 ÷ 18 =	0.33	_____
From Figure 2 find furrow ratio=	0.58	_____
New number of gates= old number of gates x furrow ratio = 80 x 0.58 =	46	_____
New furrow stream size rate = 760 ÷ 46 =	16.5 gpm	_____
New gross depth applied = 1155 x 16.5 x 12 ÷ 2600 ÷ 30 =	2.9 inches	_____

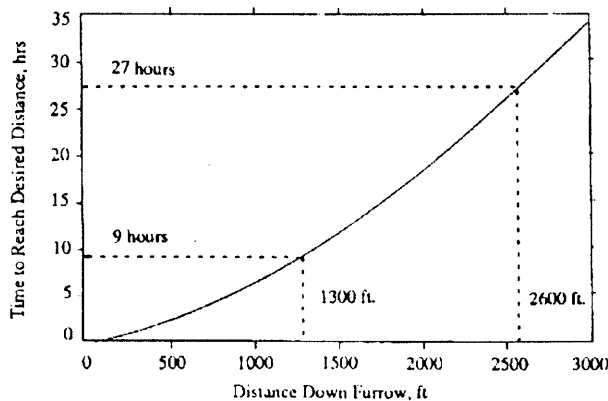
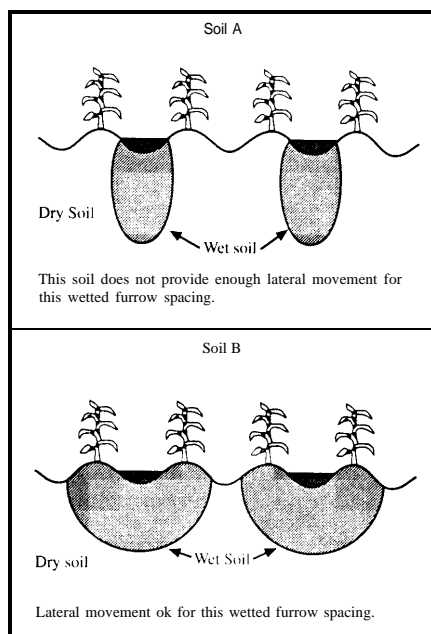

Figure 3. Example of advance of water across the field



**Figure 4. Wetting patterns from irrigated furrows**

**Table 2. Corn yields on various soil textures when irrigating every furrow and every other furrow with a manually operated surface irrigation system with 12-hour irrigation sets.**

Soil	Every furrow (same)	Every-	Every-
		other furrow (alternate)	other furrow (alternate)
bu/acre			
Albaton—clay loam	157	154	—
Luton—silty clay loam	152	159	—
Crete—silty clay loam	153	156	—
Holdrege—silt loam	179	177	174
Sarpy—sandy loam	140	143	—
Ortello—loamy sand	118	119	120
O'Neill—loamy sand	114	107	—

Irrigation water application may be reduced 20 to 30 percent by implementing every other furrow irrigation.

Infiltration is not reduced by one-half compared to watering every furrow because of increased lateral infiltration.

Plant nutrient availability may be hindered in the dry rows when irrigating every other furrow. This is especially important in dryer years. To improve the availability of these nutrients, the irrigator can alternate the wet and dry furrows for each irrigation.

Irrigating in every other furrow should not be used on steep slopes or on soils with low intake rates. On steep slopes, the water flowing down the furrow is in contact with only a limited amount of soil surface, causing low intake rates.

## REUSE

Recirculating irrigation runoff water is a method of making more effective use of irrigation water and labor. Reuse of runoff water decreases the amount of water that needs to be pumped or delivered and can be used to improve water application efficiencies by approximately 20 percent.

Reuse systems are essential for efficient surface irrigation. Growers who don't have reuse systems often cut the stream size in the furrow to a very small flow in order to minimize runoff, possibly causing an uneven water distribution pattern.

The economic value of runoff water often will be the deciding factor in installing a reuse system. However, irrigation runoff is prohibited by law in Kansas. Reuse of irrigation runoff water often is more feasible than the use of additional labor to accomplish efficient irrigation and yet prohibit runoff.

## OTHER MANAGEMENT PRACTICES FOR FURROW IRRIGATION

A relatively new technique for managing furrow irrigation is called surge flow irrigation. With this technique, water is applied intermittently, through the use of an automatic valve, rather than continuously to the irrigation furrows. This method frequently reduces both runoff and water infiltration. For more information, *KSU Extension bulletin, L-912, Surge Irrigation*.

Irrigation scheduling is always important for good water management. With furrow irrigation, it is particularly useful so that irrigations are not started too early. Irrigating too soon leads to deep percolation losses due to infiltrated depths that exceed the soil moisture deficits. The following KSU Extension bulletins provide useful information for properly timing water applications: L-914 *Scheduling Irrigation Using ET for Furrow Irrigation*. L-795 *Soil Water Measurements: An Aid to Irrigation Water Management*, L-904 *Soil Water Plant Relationships*.

Neb-Guide G91-1021 Authors:  
Dean E. Eisenhauer, Associate Professor, Biological Systems Engineering  
David L. Varner, Extension Agent, Lancaster County, Neb.  
C. Dean Yonts, Extension Irrigation Engineer, Panhandle Research and Extension Center  
Wayne Liesemeyer, State Irrigation Engineer, Soil Conservation Service

*This material is based upon work supported by the U.S. Department of Agriculture Cooperative State Research Service under Agreement No. 93-34296-8454.*

*Any opinions, findings, conclusions or recommendations expressed in this publication are those of the authors and do not necessarily reflect the views of the U.S. Department of Agriculture.*



COOPERATIVE EXTENSION SERVICE, MANHATTAN, KANSAS

L-913

July 1995

Issued in furtherance of Cooperative Extension Work, acts of May 8 and June 30, 1914, as amended. Kansas State University. County Extension councils, Extension Districts, and United States Department of Agriculture Cooperating, Richard D. Wootton, Associate Director, All educational program and materials available without discrimination on the basis of race, color, national origin, sex, age, or disability.

MS 5-95-3M

File: Engineering 4-3 Irrigation





# *Center Pivot Irrigation*

## **In this Section**

Overview: Center Pivot Irrigation

Reference: Center Pivot Workbook (B-6162)

Reference: Utilizing Center Pivot Sprinkler Irrigation Systems to Maximize Water Savings

## **Overview**

### **Objectives:**

- Increase understanding of irrigation efficiency, losses, and distribution uniformity associated with center pivot irrigation.
- Increase understanding and application of best management practices to improve efficiency and uniformity of center pivot irrigation.

### **Key Points:**

1. Low pressure center pivot and linear sprinkler irrigation systems are more water efficient and energy efficient than high pressure systems.
2. Low pressure systems include Low Energy Precision Application (LEPA), Low Elevation Spray Application (LESA), Mid-Elevation Spray Application (MESA), and Low Pressure In-Canopy (LPIC) systems. LEPA is an irrigation and field management package.
3. Crop-specific water requirements, soil texture, field topography, water quantity and quality, and other factors should be considered in selecting a sprinkler irrigation system.
4. Sprinkler systems are well-suited to automation, and they offer potential to apply fairly precise irrigation amounts (light, frequent irrigations to less frequent heavy applications) as needed by the crop or for other field activities (such as chemigation applications).
5. Sprinkler nozzle packages should be inspected periodically and updated as needed.
6. Management and maintenance are key to good results with any pressurized sprinkler system.



## *Center Pivot Irrigation*

### **Assess your knowledge:**

1. What are the normal pressure ranges for a high pressure center pivot and a low pressure center pivot?
2. Why are low pressure center pivot irrigation systems considered more efficient than high pressure systems?
3. Center pivot irrigation systems are available with two different types of drive systems. What are they? What are the advantages and limitations of each?
4. On a typical commercially available center pivot system, how is the desired irrigation application depth achieved? (How do you control the depth of application?)
5. What is the role of furrow diking in sprinkler (or LEPA) irrigation management?
6. When is a chemigation check valve required on an irrigation system? What is the purpose of the chemigation check valve?
7. If an irrigation system has a capacity to deliver 3 gpm/acre, how many inches per week can be applied to the field?



# Center Pivot Irrigation

## Center Pivot Technologies

Center Pivot irrigation systems are used widely, especially in the Texas High Plains where most of the systems are low pressure systems, including Low Energy Precision Application (LEPA); Low Elevation Spray Application (LESA); Mid-Elevation Spray Application (MESA) and Low Pressure In-Canopy (LPIC).

Low pressure center pivots are descriptions and their acronyms are the following:

- **Low Energy Precision Application or LEPA:** This type also applies as much to a type of management philosophy as well as the actual hardware. It can operate in a spray or chemigation mode, and includes a surface tillage system that enhances surface storage. LEPA also delivers water directly to the ground in an amount designed not to exceed the surface storage volume.
- **Low Elevation Spray Application or LESA and Mid-elevation Spray Application or MESA:** These describe similar irrigation application systems that embody the LEPA technology but do not meet one or more of the criteria to be called LEPA. These systems are designed to operate either on a center-pivot or a lateral-move sprinkler machine. Typically LESA systems are one to two feet above the ground while MESA systems can vary from five to 10 feet above the ground.

Low pressure systems offer cost savings due to reduced energy requirements as compared with high pressure systems. They also facilitate increased irrigation application efficiency, due to decreased evaporation losses during application. Considering high energy costs and in many areas limited water capacities, high irrigation efficiency can help to lower overall pumping costs, or at least optimize crop yield/quality return relative to water and energy inputs.

LEPA irrigation applies water directly to the soil surface through drag hoses (primarily) or through “bubbler” type applicators, (such as the LEPA mode of Senninger Irrigation Inc. Quad-Spray™ products.) Notably LEPA involves more than just the hardware through which water is applied. It involves farming in a circular pattern (for center pivot irrigation systems) or straight rows (for linear irrigation systems). It also includes use of furrow dikes and/or residue management to hold water in place until it can infiltrate into the soil.

LEPA irrigation generally is applied to alternate furrows; reducing overall wetted surface area, and hence reducing evaporation losses immediately following an irrigation application. Because relatively large amount of water is applied to a relatively small surface area, there is risk of runoff losses from LEPA, especially on clay soils and/or sloping ground. Furrow dikes and circular planting patterns help reduce the runoff risk. Still, LEPA is not universally applicable; some slopes are just too steep for effective application of LEPA irrigation.

Low pressure spray systems – LESA, MESA and LPIC - offer more flexibility in row orientation, and they may be easier for some growers to manage, especially on clay soils or sloping fields. Objectives with these systems include applying water at low elevation (generally 1-2 feet from the soil surface for LESA; often 5 - 10 feet for MESA) to reduce evaporation losses from water droplets (especially important in windy conditions); applying water at a rate not exceeding the soil’s infiltration capacity (preventing runoff); and selecting a nozzle package that provides good distribution uniformity and appropriate droplet size and wetting pattern.



## *Center Pivot Irrigation*

### **Some other considerations:**

In sloping fields, pressure regulators may be warranted to improve irrigation distribution uniformity in the field. This reduces occurrence of “wet spots” and “dry spots” in the field. Good distribution uniformity is also essential to effective chemigation/fertigation.

In many semi-arid areas, including the Texas Southern High Plains, pre-season irrigation or excess early season irrigation is used to provide moisture from crop establishment and to fill soil moisture storage capacity to augment often deficit irrigation during peak crop water use periods. Pre-season irrigation water losses through evaporation and deep percolation can be quite high. Hence it is important for growers to understand how much water their soil root zone will hold, taking into account effective root zone depth and soil moisture storage capacity per foot of soil. Applying more water than the soil can hold can result in deep percolation losses or runoff; starting irrigation too early increases opportunity for evaporation losses. These risks need to be balanced with irrigation system capacity issues.

### **Some thoughts on LEPA vs. LESA:**

Properly managed, LEPA is potentially more water-efficient than LESA. Both systems - PROPERLY MANAGED - can be very efficient. LEPA allows for alternate furrow irrigation - there are alternate dry “traffic” furrows that are more accessible for timely field applications. By limiting field operation traffic to the dry furrows, infiltration capacity of soil in the “wet” irrigated furrows is maintained. LEPA allows for irrigation without foliar wetting. For some crops this can offer reduced foliar disease risk. If water quality (salinity) is an issue, LEPA can reduce salt damage to foliage.

In very coarse soils, there sometimes may be insufficient lateral soil water movement from alternate furrow LEPA applications. This is mainly a concern for seed germination, shallow rooted crops and peanuts that require a moist zone near the soil surface for pegging and pod development. Spray irrigation (LESA and MESA) wet the soil surface more uniformly than LEPA. It is possible to apply LESA for crop germination / establishment, then convert to LEPA to take advantage of the higher irrigation application efficiency in season, and convert back to spray applications for chemigation or for uniform wetting of the shallow root zone as needed.



# *Center Pivot Irrigation*

## **Suggestions for Realizing the Benefits of Advanced Irrigation Technology**

### **New Irrigation Systems** (Center Pivot and Linear Irrigation Systems)

Start with a good design. Work with a qualified designer (Certified Irrigation Designer or licensed Professional Engineer). Design for realistic well capacities; be realistic, not optimistic. Consider whether the water delivery is likely to decrease during the season. Compare “apples to apples” on designs; a cheaper package may not be better. Things to look for in a design include adequate pressure/vacuum relief; flexibility to accommodate crop rotations and well capacity fluctuations as needed; ease of maintenance; and appropriately sized underground pipelines (consider friction losses, especially in longer pipeline runs). Consider whether pressure regulators are needed; they are more likely to be justified in sloping fields. Install the system correctly, and follow design specifications.

### **Older systems:** Considerations

Periodically evaluate the irrigation system to determine if it is performing according to design specifications. Consider wear and maintenance requirements on electrical, mechanical, and hydraulic components; replace worn parts, and upgrade as needed.

Consider whether the sprinkler should be re-nozzled. Has there been a significant drop in well capacity? Has the nozzle package “drifted” over time? (Broken or lost nozzles may be “temporarily” replaced with the wrong size nozzle. Over time these quick fixes can lead to poor distribution uniformity.) Are pressure regulators or nozzles functioning properly? Replace them as needed.

Calibrate the pivot system and conduct a distribution uniformity test periodically to ensure the correct application rates are applied, and that applications are uniform over the field. These are especially important for chemigation applications. Pressure gauges and flow meters can simplify pivot evaluation and troubleshooting.

### **Irrigation Management**

Crop water requirements are crop-specific, and they vary with weather and growth stage. Water management is especially important for critical periods in crop development. Apply knowledge of the root zone to optimize irrigation management; take into account the crop’s effective rooting depth, the soil moisture storage capacity, and field-specific conditions (shallow soils, caliche layers, etc.). In irrigation scheduling, consider using soil moisture monitoring, evapotranspiration information, and/or plant indicators to fine-tune water applications to meet crop needs.



## Center Pivot Workbook (B-6162)



**Center  
Pivot  
Workbook**

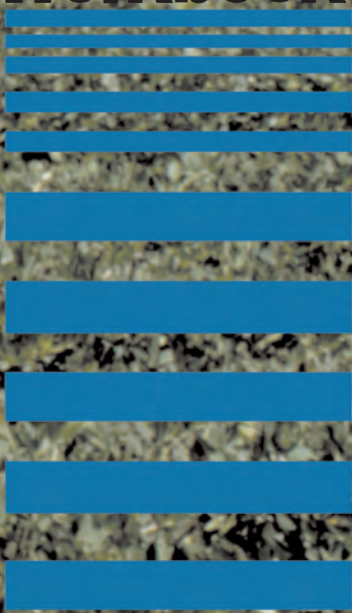

# **Center Pivot Workbook**

by

**Guy Fipps, Professor and Extension Agricultural Engineer**

**Leon New, Professor and Extension Agricultural Engineer**

**The Texas A&M University System**

**This material is based upon work supported by the Cooperative State Research, Education and Extension Service, United States Department of Agriculture under Agreement No. 2001-45049-00149.**



# Contents

Section 1: Introduction .....	5
Section 2: Pivot Costs .....	6
Section 3: Types of Drive Systems.....	7
Section 4: Understanding the Design Printout .....	10
Section 5: System Capacity.....	14
Section 6: Main Pipe Sizing .....	15
Section 7: Pressure Regulators .....	18
Section 8: Water Applicators.....	20
Section 10: Converting Existing Pivots to LEPA .....	24
Section 11: Accessories and Other Considerations .....	26
Section 12: Pivot Management.....	27
Section 13: Irrigation Scheduling .....	29
Section 14: Chemigation and Fertigation .....	31
Section 15: Center Pivot Buyer’s Check List .....	34

# Section 1

## Introduction

---

---

The center pivot is the agricultural irrigation system of choice because of its low labor and maintenance requirements, convenience, flexibility, performance and easy operation. Center pivot systems conserve valuable resources such as water, energy, money and time.

The first center pivot irrigation system was produced in the 1950s and was propelled by water. Today, pivots are driven by electric or oil hydraulic motors. Energy requirements have been decreased and application efficiency has been increased through lowering evaporation losses with LESA (Low Elevation Spray Application) and LEPA (Low Energy Precision Application).

Wise selection of a center pivot system will result in good water management and conservation, low operating costs, and future flexibility. Purchasers of center pivot systems must specify:

- ◆ Mainline size and outlet spacing
- ◆ Length, including the number of towers
- ◆ Drive mechanisms
- ◆ Application rate of the pivot
- ◆ Type of water applicator

### Exercise 1

1. When properly designed, equipped and operated, what resources does the center pivot system conserve?
  - a. Energy
  - b. Money
  - c. Water
  - d. Time
  - e. All of the above
2. Which of the following must be specified when purchasing a center pivot system?
  - a. Mainline size and outlet spacing
  - b. Type of water application
  - c. Drive mechanisms and application rate of the pivot
  - d. Type of water applicator
  - e. All of the above

# Section 2

## Pivot Costs

---

---

Total cost of a pivot system depends on factors such as system length and coverage area, power units and type of water applicator, as well as water supply system costs, which may include groundwater well construction, turbine pumps, etc.

The pivot system commonly used for general pricing purposes is a “quarter-mile system,” which is 1300 feet long and irrigates 120 acres. A quarter-mile system costs \$325 to \$375 per acre, excluding the cost of groundwater well construction, turbine pumps and power units. Longer systems usually cost less on a per-acre basis. For example, a half-mile system (2600 feet) irrigates about 500 acres at a cost of \$200 to \$250 per acre.

The relatively high cost of a center pivot system often can be offset by advantages such as:

- ◆ Reduced labor and tillage
- ◆ Improved water distribution
- ◆ More efficient pumping
- ◆ Lower water requirements
- ◆ More timely irrigation
- ◆ Flexibility and convenience, which with certain options includes
  - Remote control via phone lines and radio to start or stop irrigation, identify pivot field location, increase or decrease travel speed, and reverse direction
  - Application of chemicals and fertilizers
  - Programmable control panels and injection unit controls
  - Towable pivot machines to irrigate additional tracts of land

### Exercise 2

1. Cost of a pivot system depends on
  - a. Pivot system length
  - b. Cost of groundwater well construction
  - c. Cost of turbine pumps
  - d. Cost of power units
  - e. All of the above
2. Advantages of a center pivot system are
  - a. Improved water distribution and lower water requirements
  - b. Reduced labor and tillage
  - c. More efficient pumping and timely irrigation
  - d. Flexibility and convenience
  - e. All of the above
3. Towable pivot machines are available, so that additional tracts of land can be irrigated with the same machine
  - a. True
  - b. False

# Section 3

## Types of Drive Systems

### Electric

For electric-drive pivots, individual electric motors (usually 1.0 to 1.5 hp) power the two wheels at each tower (Fig. 1). Typically, the outermost tower moves to its next position and stops; then each succeeding tower moves into alignment.

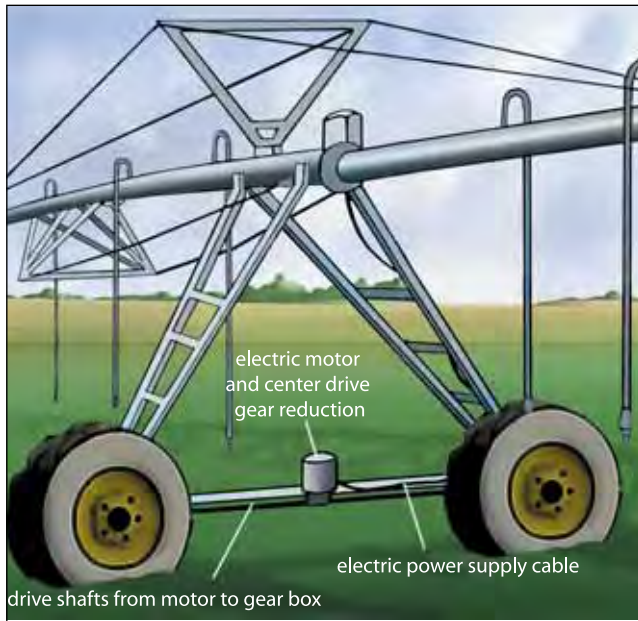

Figure 1a. Electric drive.

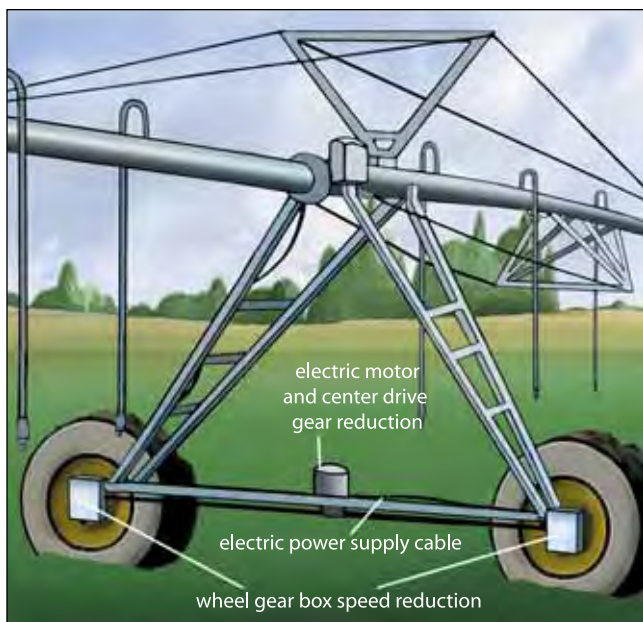

Figure 1b. Electric drive.

Rotation speed (or travel time) of the pivot depends on the speed of the outermost tower and controls the amount of water applied. The system operator can select tower speed using the central power control panel, normally located at the pivot point. At the 100 percent setting, the end tower moves continuously. At the 50 percent setting, each minute the outer tower moves 30 seconds and stops 30 seconds. The speed options on most central power control panels range from 2 to 100 percent.

### Hydraulic

Unlike with electric-drive pivots, all oil-hydraulic-drive towers remain in continuous motion (Fig. 2). Each tower moves continuously at a proportionally reduced speed, with the outermost tower speed being greatest. Travel speed is selected at a central master control valve that increases or decreases oil flow to the hydraulic motors on the last tower. Two motors per tower are used with a planetary drive, one for each wheel. One motor per tower powers an optional worm-drive assembly. Required hydraulic oil pressure usually is 1,500 to 1,800 psi, maintained by a central pump most often located near the pivot pad. This central pump may be powered by natural gas, diesel or electricity.

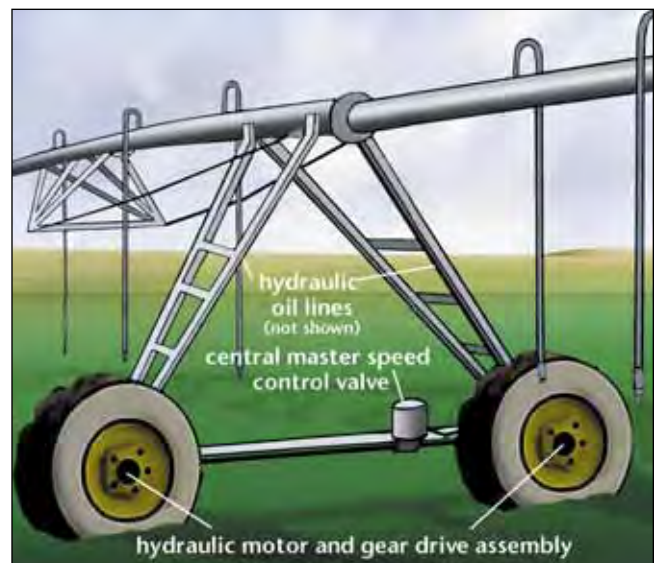

Figure 2. Hydraulic move.

## Electric-drive vs. Hydraulic-drive Pivots

In field tests, both electric and hydraulic drive systems worked well. Choice of pivot type usually is guided by the power source available, personal preferences about system maintenance and service, local dealers' service history, local-market product availability, purchase price, and dependability. Theoretically, continuous-move systems provide greater irrigation uniformity. However, uniformity also is influenced by other factors, including travel speed, system design, type of water applicator, and operator management.

### Wheel and Drive Options

The speed of the pivot controls the amount of water applied. Pivot travel speed depends on both the wheel size and the power-drive mechanisms.

Electric power-drive systems have two gear reductions: one in the drive shaft and one in the gear box driving each wheel. Thus, maximum center-pivot travel speed depends on:

- ◆ Electric motor speed or rotation in revolutions per minute (rpm)
- ◆ Speed reduction rotation in both the center drive shaft and the gear boxes
- ◆ Wheel size

Hydraulic-drive pivots have only one gear reduction. Table 1 lists examples of electric and hydraulic drive systems and the end-tower speed depending on system specifications.

**Table 1a. Typical gear reduction, wheel drive RPM and maximum end tower travel speed.**

Center drive Motor rpm	Gear box ratio	ratio	Wheel dimension (inches)		Rim & tire circumference (feet)	Last wheel drive (rpm)	End tower (feet per hour)
			Rim	& tire			
1,740	58:1	52:1	24	40	10.47	0.5769	362
1,740	40:1	50:1	24	40	10.47	0.8700	546
3,450	40:1	52:1	38	54	14.13	1.6586	1,406

**Table 1b: Typical gear reduction, wheel-drive RPM and maximum end tower travel speed for hydraulic-drives.**

Drive type	Number of towers	Hydraulic pump drive hp	Tire size	Rim & tire circumference (feet)	Last wheel drive (rpm)	End tower (feet per hour)
Hydraulic	8	10	16.9 X 24	10.47	0.5730	360
Hydraulic	8	15	14.9 x 24	10.47	0.9312	585
Hydraulic Hi-Speed	8	25	11.2 x 38	14.13	1.5723	1,333
Hydraulic Hi-Speed	18	25	11.2 x 38	14.13	0.6286	533

### Exercise 3

1. All towers remain in continuous motion in electric drive systems, while motion is not continuous in hydraulic drive systems.
  - a. True
  - b. False
2. Field tests found that hydraulic drive systems are always better than electric drive systems because continuous-move systems provide greater irrigation uniformity.
  - a. True
  - b. False
3. For electric-drive systems, only one electric motor powers the two wheels at each tower, but hydraulic-drive systems may use one or two motors at each tower.
  - a. True
  - b. False
4. An electric-drive system has a motor that generates 1740 RPM and a rim and tire circumference of 10.47 ft. With a gear box ratio of 50:1, what is the expected maximum end tower travel speed in feet per hour?
  - a. 362 feet per hour
  - b. 10 feet per hour
  - c. 546 feet per hour
  - d. 25 feet per hour
  - e. None of the above
5. A hydraulic-drive system has 8 towers, 25 HP hydraulic pump drive and a rim and tire circumference of 14.13 ft. What is the travel speed of the last wheel drive (in RPM) and of the end tower (in feet per hour)?
  - a. 0.8700 RPM and 362 feet per hour
  - b. 0.5730 RPM and 360 feet per hour
  - c. 0.9312 RPM and 585 feet per hour
  - d. 1.5723 RPM and 1333 feet per hour
  - e. None of the above

# Section 4

## Understanding the Design Printout

---

---

The design computer printout provides required information about the center pivot and how it will perform on a particular tract of land. A portion of a typical design printout is shown in Figure 3. It includes:

- ◆ Pivot-design flow rate
- ◆ Irrigated acreage under the pivot
- ◆ Elevation change in the field as measured from the pivot point
- ◆ Operating pressure and mainline friction loss
- ◆ Pressure regulator rating in psi
- ◆ Type of water applicator and applicator spacing and position from mainline
- ◆ Nozzle size for each applicator
- ◆ Water applicator nozzle pressure
- ◆ Maximum travel speed
- ◆ Precipitation chart

A sample precipitation chart is shown in Figure 4. The chart identifies irrigation amounts (in inches of water applied) for optional travel-speed settings, gear reduction ratios and tire size.

It is essential to use correct information about available water supply (in gpm) and changes in field elevation to design the pivot, so that accurate irrigation amounts, operating pressure requirements and pressure-regulator needs can be determined.

### Exercise 4

1. Information about the center pivot and how it will perform can be obtained from a design computer printout which includes:
  - a. Information about nozzle size and pressure
  - b. Information about pivot travel speed
  - c. Information about system capacity and irrigated acreage
  - d. Elevation changes in the field
  - e. All of the above
2. In Figure 4, the pivot applies 1.27 inches of water at 20% timer setting. What is the expected time in hours to complete a circle at this speed setting?
  - a. 37.8
  - b. 189.2
  - c. 113.5
  - d. 126.1
  - e. 90.82

# Notes

---

---



Figure 3. Sample design computer printout.

Pivot identification	J & J Farms	Overall length	1309.00 ft
Pivot location	Section 130	Drop tube length	12.50 ft
Design flow rate	625.00 GPM	Regulator position (from mainline)	12.00 ft
Design Pressure at the end	4.00 PSI	Design elevation of end tower	+7.0 ft, -8.0 ft
Pressure at pivot	13.67 PSI	End gun GPM	0

SPAN NO.	SPAN LENGTH (ft)	MAINLINE DIAMETER (inches)	NUMBER OF DROPS	DROP SPACING (ft)	DROP DIAMETER (inches)	1st DROP POSITION (ft)	REGULATOR SIZE (psi)	ACRES
1	160	6.38	19	6.67	0.75	36.60	6	1.84
2	160	6.38	24	6.67	0.75	3.335	6	5.53
3	160	6.38	24	6.67	0.75	3.335	6	9.23
4	160	6.38	24	6.67	0.75	3.335	6	12.92
5	160	6.38	24	6.67	0.75	3.335	6	16.61
6	160	6.38	24	6.67	0.75	3.335	6	20.30
7	160	6.38	24	6.67	0.75	3.335	6	23.99
8	160	6.38	24	6.67	0.75	3.335	6	27.68
9	29	5.78	5	6.67	0.75	3.335	6	5.41
Total	1309		192					123.51

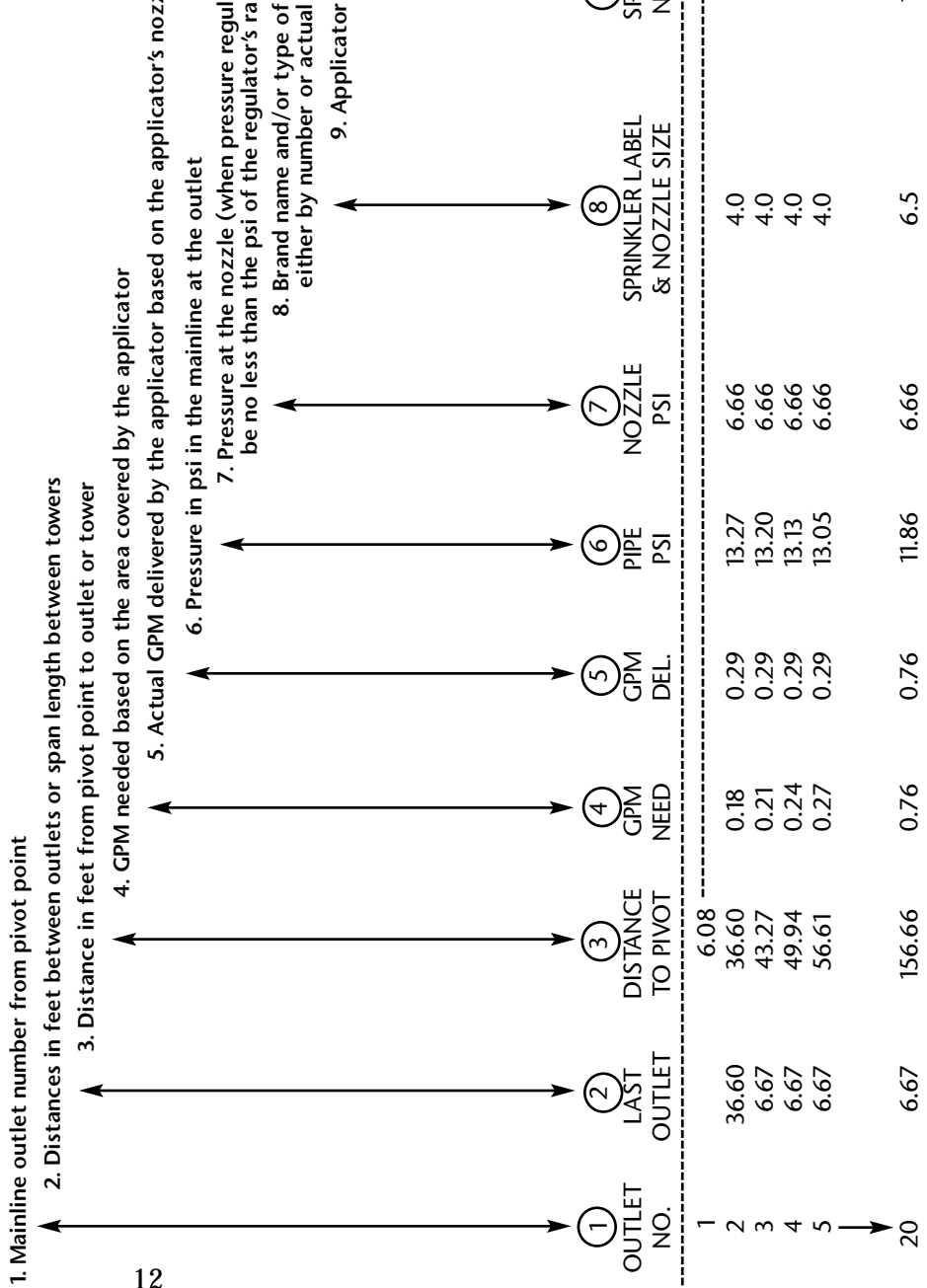
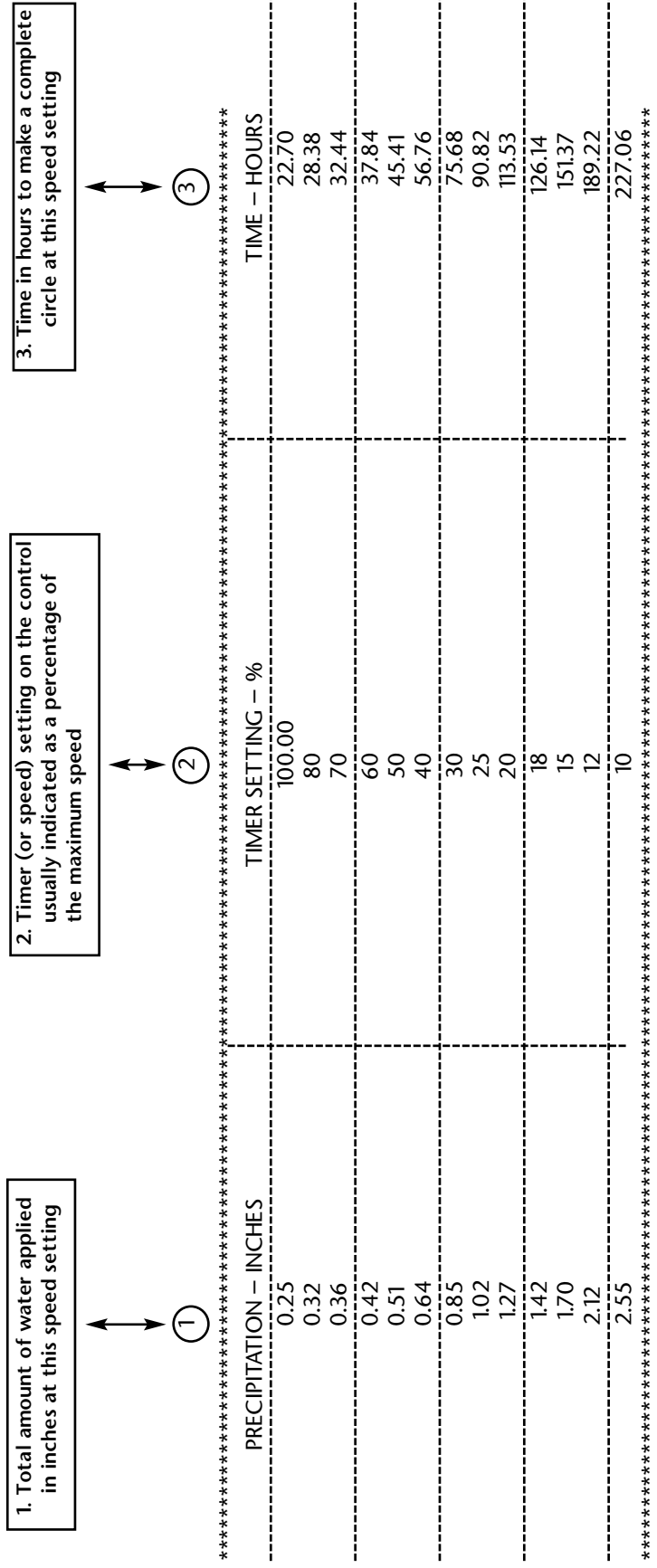

Figure 3. Sample design computer printout. (continued)

Tower 1	160.00	160.00	0.79	0.76	11.79	6.66	6.5	20	6LF	144
21	6.67	163.33	0.82	0.88	11.72	6.66	7.0	21	6LF	144
22	6.67	170.00	0.85	0.88	11.65	6.66	7.0	22	6LF	150
23	6.67	176.67	0.88	0.88	11.58	6.66	7.0	23	6LF	150
24	6.67	183.34	0.89	0.88	11.50	6.66	7.0	24	6LF	156
25	6.67	190.01	0.92	0.88						
44	6.67	316.67	1.53	1.61	10.20	6.66	9.5	43	6LF	144
Tower 2	160.00	320.00								
45	6.67	323.33	1.56	1.61	10.03	6.66	9.5	44	6LF	144
46	6.67	330.00	1.59	1.61	9.96	6.66	9.5	45	6LF	144

Figure 4. Sample precipitation chart.



# Section 5

## System Capacity

---

A pivot's irrigation-system capacity is determined by gallons per minute (gpm) and number of acres irrigated. System capacity is expressed in terms of:

- a) Total flow rate in gpm, or
- b) Application rate in gpm per acre

Knowing a system's capacity in gpm per acre helps in irrigation water management. Table 2 shows the relationship between gpm per acre and irrigation amounts. These irrigation amounts apply to all irrigation systems having the same capacity in gpm per acre. The amounts do not include application losses and apply to systems operating 24 hours a day.

To determine your system's capacity, select desired irrigation amounts in inches and multiply the corresponding gpm per acre by the number of acres you are irrigating. For example, if you irrigate 120 acres with 4.0 gpm per acre, 480 gpm (120 acres H 4 gpm) are required to apply 0.21 inches of water per day, 1.50 inches per week and 6.40 inches in 30 days.

### Exercise 5

1. What is the system capacity if you want to irrigate 200 acres with 6.0 gpm per acre?
  - a. 12.0 gpm
  - b. 120.0 gpm
  - c. 1200.0 gpm
  - d. 400.0 gpm
  - e. 206.0 gpm
  
2. For the system in question 1, what will be the total amount of water applied (in inches) to the 200 acre field after 60 days?
  - a. 382 inches
  - b. 19.1 inches
  - c. 120.0 inches
  - d. 191.0 inches
  - e. 22.6 inches

**Table 2. Daily and seasonal irrigation capacity for irrigation systems operating 24 hours per day.**

gpm/acre	Inch/day	Inch/week	Inches in irrigation days				
			30	45	60	80	100
1.5	.08	.55	2.4	3.8	4.8	6.4	8.0
2.0	.11	.75	3.2	4.8	6.4	8.5	10.6
3.0	.16	1.10	4.8	7.2	9.5	12.7	15.9
4.0	.21	1.50	6.4	9.5	12.7	17.0	21.2
5.0	.27	1.85	8.0	11.9	15.9	21.2	26.5
6.0	.32	2.25	9.5	14.3	19.1	25.4	31.8
7.0	.37	2.60	11.1	16.7	22.6	29.7	37.1

# Section 6

## Main Pipe Sizing

The diameter and length of a pivot mainline pipe influences the total operating cost of the system. Smaller pipe sizes, while less expensive to purchase, may have higher water- flow-friction-pressure loss, resulting in higher energy costs. To minimize pumping costs, plan new center pivots to operate at minimum operating pressure.

For a pivot nozzled at 1,000 gpm, rules of thumb are as follows:

- ◆ Each additional 10 psi of pivot pressure requires an increase of approximately 10 horsepower. (Note: Horsepower is proportional to system flow rates of 1,000 gpm. For example, when the system flow rate is 700 gpm, 7 horsepower is needed for each 10 psi of pivot pressure.)
- ◆ Each additional 10 psi of pivot pressure increases fuel costs about \$0.35 per hour (or \$0.16 per acre-inch) for natural gas costs of \$3.00 per thousand cubic feet (mcf).
- ◆ At \$0.07 per kilowatt hour, electricity costs \$0.60 per hour (\$0.27 per acre-inch) for each additional 10 psi of pressure.
- ◆ For diesel fuel priced at \$1.00 per gallon, it costs \$0.60 per hour (\$0.28 per acre-inch) for each additional 10 psi of pressure.
- ◆ For diesel fuel priced at \$1.50 per gallon, the cost for each additional 10 psi increases to \$0.90 per hour (\$0.42 per acre-inch).

Table 3 lists friction-pressure losses for different mainline sizes and flow rates. Total friction pressure in the pivot mainline for quarter-mile systems (Table 3, sec-

tion A) on flat to moderately sloping fields **should not exceed 10 psi**. Therefore:

- ◆ For flows up to approximately 750 gpm, 6 5/8-inch diameter mainline can be used.
- ◆ Friction-pressure loss exceeds 10 psi when more than 575 gpm is distributed through 6-inch mainlines.
- ◆ Some 8-inch spans should be used when 800 gpm or more are delivered by a quarter-mile system.
- ◆ For center pivots 1,500 feet long (Table 3, Section B), 6 5/8-inch mainline can be used for 700 gpm, while keeping friction-pressure loss under 10 psi.

**Table 3. Approximate friction loss (psi) in center pivot mainlines.**

Flow rate, GPM	Mainline pipe diameter, inches			
	6	6 5/8	8	10
Mainline pressure loss, psi				
A. Quarter-mile system:				
500	8	5		
600	11	7		
700	14	9		
800	18	11	4	
900	23	14	5	
1,000	28	17	7	
1,100	33	20	8	
1,200	39	24	9	
B. 1500-foot system:				
600	13	8	3	
700	16	10	4	
800	21	13	5	
900	26	16	6	
C. Half-mile system				
1,600	134	83	31	10
2,000		125	48	15
2,400			67	22
2,800				29

Some dealers may undersize the mainline in order to reduce their bids, especially when pushed to give the best price. Check the proposed design printout. If operating pressure appears high, ask the dealer to provide another design using proportional lengths of larger pipe, usually in spans, or to telescope pipe (see below) to reduce operating pressure. Table 3, Section C shows how friction and operating pressure for half-mile systems can be reduced with 8- and 10-inch mainline pipe. Saving money on the initial purchase price often means paying more in energy costs over the life of the system.

## Telescoping

Telescoping involves using larger mainline pipe at the beginning of the irrigation line, then smaller sizes as the water-flow rate (gpm) decreases away from the pivot point. Typical mainline sizes are 10, 8 1/2, 8, 6 5/8 and 6 inches. Mainline pipe size governs options in span length (the distance between adjoining towers). Span length options are usually:

- 100 to 130 feet for 10-inch mainline
- ◆ 130 to 160 feet for 8 1/2- and 8-inch
- ◆ 160 to 200 feet for 6 5/8- and 6-inch.

Telescoping mainline pipe can be used to plan a center pivot for minimum water-flow friction loss and low operating pressure, thus for lower pumping costs. Telescoping uses a combination of

pipe sizes based on the velocity of the water flowing through the pipe.

Telescoping is usually accomplished in whole span lengths. Its importance increases with both higher flow rates (gpm) and longer center pivot lengths. Dealers use computer programs to select telescoping mainline pipe size for lowest purchase price and operating costs. If your dealer does not offer this technology, request that the dealer obtain it.

Table 4 shows examples of telescoping mainline size used to manage friction-pressure loss. Example 1 shows that to deliver 1,100 gpm with a center pivot 1,316 feet long, friction-pressure loss is reduced from 19 to 10 psi by using 640 feet of 8-inch mainline rather than selecting all 6 5/8-inch pipe. Example 2 lists friction-pressure losses for various lengths and combinations of mainline pipe size for the delivery of 2,500 gpm by a 2,624-foot system irrigating 496 acres. Friction-pressure loss is reduced from 73 to 25 psi by using more 10- and 8-inch mainline pipe and less 6 5/8-inch pipe.

When designing your system, compare the higher cost of larger mainline pipe to the increased pumping costs associated with smaller pipe. (Higher pumping costs are caused by higher operating pressure requirements. Total operation pressure is the sum of friction and system design pressures and terrain elevation; pressure gauges located at the pivot pad and on the last applicator drop will identify system operating pressure.)

**Table 4. Telescoping to reduce mainline friction pressure with outlets spaced at 60 inches.**

GPM	Feet of mainline size				Total feet	Friction pressure - PSI
	10-inch	8 1/2-inch	8-inch	6 5/8-inch		
Example 1						
1,100	0	0	0	1,316	1,316	19
1,100	0	0	640	676	1,316	10
Example 2						
2,500	0	0	1,697	927	2,624	73
2,500	0	897	800	927	2,624	63
2,500	897	0	800	927	2,624	48
2,500	1,057	640	540	387	2,624	32
2,500	1,697	0	540	387	2,624	25

## Exercise 6

1. Less expensive, smaller pipe sizes may result in higher energy costs because of higher water-flow friction-pressure loss.
  - a. True
  - b. False
2. Total friction pressure in the pivot mainline for quarter-mile systems on flat to moderately sloping fields should not exceed 10 psi.
  - a. True
  - b. False
3. A 1,500 foot long center pivot has a mainline pipe diameter of 8 inches. What is the expected mainline pressure loss (in psi) if the flow rate is 800 gpm?
  - a. 3
  - b. 4
  - c. 5
  - d. 6
  - e. 7
4. A half-mile center pivot has a mainline pipe diameter of 10 inches. What is the expected mainline pressure loss (in psi) if the flow rate is 2800 gpm?
  - a. 31
  - b. 48
  - c. 15
  - d. 29
  - e. 67
5. A quarter-mile center pivot has a mainline pipe diameter of 6 inches. What is the expected mainline pressure loss (in psi) if the flow rate is 1100 gpm?
  - a. 33
  - b. 28
  - c. 11
  - d. 9
  - e. 4
6. Telescoping is
  - a. Using smaller mainline pipe at the beginning and then larger sizes as the water-flow rate (gpm) decreases away from the pivot point.
  - b. A method of planning a center pivot for minimum water-flow friction loss and lower operating pressure.
  - c. Using a combination of pipe sizes with larger size at the beginning and then smaller sizes as the amount of water flowing in the pipe decreases away from the pivot point.
  - d. A & B
  - e. B & C
7. A 2,624 foot center pivot has a telescoped mainline that consists of 1,697 feet of 8-inch pipe and 927 feet of 6-inch pipe. At a flow rate of 2500 gpm, the friction loss is 73 psi. What is the friction-pressure loss if the mainline pipe sizes are changed to 1,697 feet of 10-inch pipe, 540 feet of 8-inch pipe, and 387 feet of 6-inch pipe?
  - a. 63 psi
  - b. 48 psi
  - c. 32 psi
  - e. 25 psi
  - d. 19 psi

# Section 7

## Pressure Regulators

---

Pressure regulators are "pressure killers." They reduce pressure at the water-delivery nozzle so that the appropriate amount of water is applied by each applicator. Selection of nozzle size is based on the rated delivery psi of the pressure regulators. Pressure regulator psi rating influences system design, appropriate operating pressure, total energy requirements and costs of pivot irrigation. However, pressure regulators are not necessarily needed at all sites.

For the same application rate, nozzles used with 10 psi regulators will be smaller than those used with 6 psi regulators. Low-rated (low psi) pressure regulators, if used, allow the center pivot to be designed for minimum operating pressures.

Pressure regulators require energy to function properly. Water-pressure losses within the regulator can be 3 psi or more. So, entrance (or inlet) water pressure should be 3 psi more than the regulator pressure rating. Six-psi regulators should have 9 psi at the inlet; 10-psi regulators, 13 psi; 15-psi regulators, 18 psi; and 20-psi regulators, 23 psi. Regulators do not function properly at operating pressures less than their rating plus 3 psi.

The pressure at the inlet side of a regulator should be monitored with a gauge installed in the last drop at the outer end of the pivot, upstream and adjacent to the regulator. The pressure at this point should be checked when the machine is up slope (or at the highest elevation with relation to the pivot point). Another gauge located in the first drop in span one will monitor operating pressure when the center pivot is located down slope.

Table 5 shows how variations in terrain elevations influence mainline operating pressures. Elevation changes in the field have the largest impact on center pivots with lower design pressures. From the first to the last drop on a pivot, operating pressure at the nozzle should vary not more than 20 percent from design operating pressure. Pressure regulators usually are not necessary if elevation does not change more than 5 feet from the pad to the end of the pivot (i.e., operating pressure and pumping costs usually will not increase significantly). Where elevation changes are greater than 5 feet, the choice is between increasing operating pressure (and,

**Table 5. Percent variation in system operating pressure created by changes in land elevation for a quarter-mile pivot. Maintain less than 20 percent variation.**

Elevation change Feet	psi	System design pressure (psi)*				
		6	10	20	30	40
		% variation				
2.3	1	16.5	10.0	5.0	3.3	2.5
4.6	2	33.0	20.0	10.0	6.6	5.0
6.9	3	50.0	30.0	15.0	10.0	7.5
9.2	4		40.0	20.0	13.3	10.0
11.5	5		50.0	25.0	16.6	12.5
13.9	6			30.0	20.0	15.0
16.2	7				23.3	17.5
18.5	8				26.6	20.0

\*pressure at the nozzle

probably, pumping costs) and using pressure regulators. This decision is site specific and should be made by comparing the extra costs of pressure regulators to the increased pumping costs without them. (Note: As shown in Table 5, every additional 2.3 feet of elevation requires an additional 1 psi of operating pressure.)

In situations where water-flow rate, and, thus, operating pressure, vary significantly during a growing season, perhaps from seasonal variations in groundwater pumping levels, design flow rate (or system capacity) and use of pressure regulators should be evaluated carefully. If water pressure drops below that required to operate the regulators, poor water application and uniformity will result. In contrast, if design operating pressure is high, pumping costs will be unnecessarily high. When operating pressure decreases to less than that required, the solution is to renozzle for the reduced number of gallons per minute. The amount of water flow in the mainline decreases or increases operating pressure for the nozzles installed.

## Exercise 7

1. Pressure regulators are devices used to reduce pressure at the water delivery nozzle so that the appropriate amount of water is applied.
  - a. True
  - b. False
2. Change in land elevation will result in variation in the center pivot operating pressure. A quarter-mile pivot was designed with 20 psi nozzle pressure. What is the percent variation of pressure for an elevation change of 9.2 feet?
  - a. 5.0 psi
  - b. 10.0 psi
  - c. 15.0 psi
  - d. 20.0 psi
  - e. 25.0 psi



# Section 8

## Water Applicators

---

---

### Pads

Several types of spray applicators are available, each with various pad options. Low-pressure spray applicators can be used with flat, concave or convex pads that direct the water spray pattern horizontally, upward and downward at minimum angles. Spray applicator pads also vary in number and depth of grooves, thus, in the size of water droplets they produce. Fine droplets may reduce erosion and runoff but are less efficient because of their susceptibility to evaporation and wind drift.

Some growers prefer to use coarse pads that produce large droplets and to control runoff and erosion with agronomic and management practices. Little data has been published about the performance of various pad arrangements. In the absence of personal experience and local information, following the manufacturer's recommendations is likely the best strategy for choosing pad configuration. Pads are inexpensive, and some growers purchase several groove configurations and experiment to determine which works best in their operations.

### Impact Sprinklers

High-pressure impact sprinklers mounted on the center pivot mainline were prevalent in the 1960s when energy prices were low and water conservation did not seem so important. Now, such sprinklers are recommended only for special situations, such as land application of wastewater, where large nozzles and high evaporation can be beneficial. Impact sprinklers usually are installed directly on the mainline and release water upward at 15 to 27 degrees.

High-pressure impact sprinklers normally produce undistorted water pattern diameters in the range from 50 to more than 100 feet. Water application losses average 25 to 35 percent or more. Low angle, 7-degree sprinklers somewhat reduce water loss and pattern diameter but do not significantly decrease operating pressure. End

guns are higher volume (gpm) impact sprinklers with lower application and distribution efficiencies and high energy requirements, so they are not recommended.

### Low-Pressure Applicators

Very few center pivots in Texas are now equipped with impact sprinklers, because improved applicator and design technologies produce more responsible irrigation-water management. These new applicators operate at low water pressure and work well with current center pivot designs. Low-pressure applicators require less energy and, when appropriately positioned, ensure that most of the water pumped gets to the crop. Growers must choose which low-pressure applicator to use and how close to ground level to place the nozzles.

Generally, the lower the operating pressure requirements, the better. When applicators are spaced 60 to 80 inches apart, nozzle operating pressure can be as low as 6 psi, but more applicators will be required than with wider spacings (15 to 30 feet). Water application is most efficient when applicators are positioned 16 to 18 inches above ground level, so that water is applied within the crop canopy. Spray, bubble or direct soil discharge modes can be used.

Field testing has shown that when there is no wind, low-pressure applicators positioned 5 to 7 feet above ground can apply water with up to 90 percent efficiency. However, as the wind speed increases, the amount of water lost to evaporation increases rapidly. In one study, wind speeds of 15 and 20 miles per hour created evaporative losses of 17 and 30+ percent, respectively. In another study on the southern High Plains of Texas, water loss from a linear-move system was as high as 94 percent when wind speed averaged 22 miles per hour with gusts of 34 miles per hour. Evaporation loss is significantly influenced by wind speed, relative humidity and temperature.

## MESA

With Mid-Elevation Spray Application (MESA), water applicators are located approximately mid-way between the mainline and ground level. Water is applied above the crop canopy, even on tall crops such as corn and sugar cane. Rigid drops or flexible drop hoses are attached to the mainline gooseneck or furrow arm and extend down to the water applicator (Fig. 5). Weights should be used, combined with flexible drop hose.

Nozzle pressure varies, depending on type of water applicator and pad arrangement selected. While some applicators require 20 to 30 psi operating pressure, improved designs require only 6 to 10 psi for conventional 8 1/2- to 10-foot mainline outlet and drop spacing. Operating pressures can be lowered to 6 psi or less when spray applicators are positioned 60 to 80 inches apart. With wider spacings, such as for wobbler and rotator applicators, manufacturers' recommended nozzle operating pressure is greater.

Research has shown that in corn production, 10 to 12 percent of the water applied by above-canopy irrigation is lost by wetting the foliage. More is lost to evaporation. Field comparisons indicate 20 to 25 percent more water loss from MESA above-crop-canopy irrigation than from

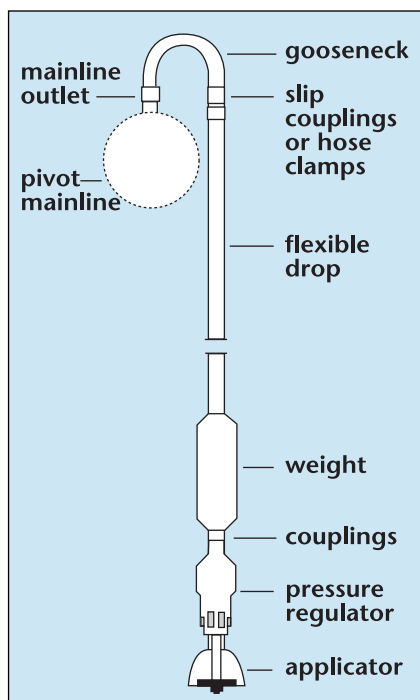

Figure 5. Drop arrangement.

LESA and LEPA within-crop-canopy center pivot systems.

## LESA

Low Elevation Spray Application (LESA) applicators are positioned 12 to 18 inches above ground level or high enough to allow space for wheel tracking. Less crop foliage is wetted, especially when crops are planted in a circle, and less water is lost to evaporation. LESA applicators usually are spaced 60 to 80 inches apart, corresponding to two crop rows. The usual arrangement is illustrated in Figure 6. Each applicator is attached to a flexible drop hose, which is connected to a gooseneck or furrow arm on the mainline (Fig. 7). Weights help stabilize the applicator in winds and allow it to work through plants in straight crop rows. Nozzle pressure as low as 6 psi is best with a correctly chosen water applicator. Water-application efficiency usually averages 85 to 90 percent, but may be less in more open, lower-profile crops such as cotton.

LESA center pivots can be converted easily to LEPA with an applicator adapter that includes a connection to attach a drag sock or hose. Optimal spacing for LESA drops is no wider than 80 inches, but with appropriate installation and management, LESA drops placed on earlier, conventional 8 1/2- to 10-foot spacing can be successful.

Corn should be planted in circle rows, and water sprayed underneath primary foliage. Some growers have been successful using LESA irrigation in straight corn rows at conventional outlet spacing, using a flat, coarse pad that sprays water horizontally. Grain sorghum and soybeans also can be planted in straight rows. For wheat, when plant foliage causes significantly uneven water distribution, swing the applicator over the truss



Figure 6. Drops with LESA applicators.



Figure 7. LESA applicator.

rod to raise it. (Note: When buying a new center pivot, choose a mainline outlet spacing of 60 to 80 inches, corresponding to two row widths.)

## LEPA

Low Energy Precision Application (LEPA) irrigation discharges water between alternate crop rows planted in a circle. Water is applied with:

- ◆ Applicators located 12 to 18 inches above ground level, which apply water in a “bubble” pattern; or
- ◆ Drag socks or hoses that release water on the ground.

Socks help reduce furrow erosion; double-ended socks are designed to protect and maintain furrow dikes (Fig. 8). If desired, drag-sock and hose adapters can be removed from an applicator and a spray or chemigation pad attached in their place. The LEPA “quad” applicator delivers a bubble water pattern (Fig. 9) that can be reset to optional spray for germination, chemigation and other in-field adjustments (Fig. 10).

LEPA applicators typically are placed 60 to 80 inches apart, corresponding to twice the row spacing. Thus, the middle of one is wet, and the next is dry. Dry middles allow more rainfall to be stored. Applicators are arranged to maintain a dry row for the pivot wheels when the crop is



Figure 8. Double-ended sock.



Figure 9. LEPA bubble pattern.

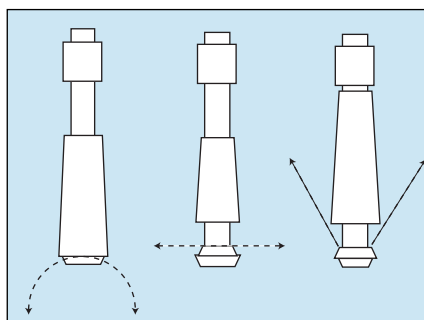

Figure 10. Multi-functional LEPA head.

planted in a circle. Research and field tests show that crop production is the same whether water is applied in every furrow or in alternate furrows. Applicator nozzle operating pressure is typically 6 psi.

Field tests show that with LEPA, 95 to 98 percent of the irrigation water pumped gets to the crop. Water application is precise and concentrated, requiring a higher degree of planning and management, especially in clay soils. Center pivots equipped with LEPA applicators provide maximum water-application efficiency at minimum operating pressure. LEPA can be used successfully in circles or in straight rows and is especially beneficial for low profile crops such as cotton and peanuts. LEPA is even more beneficial where water is limited.

## Exercise 9

1. What is LESA?
  - a. Low Energy Spray Application
  - b. Low Elevation Spray Application
  - c. Low Elevation Specific Application
  - d. Low Energy Specific Application
  - e. None of the above
2. What is LEPA?
  - a. Low Energy Pivot Application
  - b. Low Elevation Power Application
  - c. Low Elevation Precision Application
  - d. Low Energy Precision Application
  - e. None of the above
3. Impact sprinklers are usually installed directly on the mainline and release water upward at 15 to 27 degrees.
  - a. True
  - b. False
4. Low-pressure applicators require more energy.
  - a. True
  - b. False
5. When appropriately positioned, low-pressure applicators ensure that most of the water pumped gets to the crop.
  - a. True
  - b. False
5. MESA is:
  - a. Medium Elevation Sprinkler Application
  - b. Mid-elevation Spray Application
  - c. Mid-elevation Sprinkler Application
  - d. Medium Elevation Spray Application
  - e. None of the above
6. Low Elevation Spray Application (LESA) applicators are positioned 12 to 18 inches above ground level and are usually spaced 60 to 80 inches apart.
  - a. True
  - b. False
7. Which of the following is correct about LEPA?
  - a. Low Energy Precision Application
  - b. Applicators are located 12 to 18 inches above ground level
  - c. Applicators are placed 60 to 80 inches apart
  - d. 95 to 98 percent of the irrigation water pumped gets to the crop
  - e. All of the above
8. On the following figure, identify the location of each of the following: Weight, applicator, mainline outlet, gooseneck, pivot mainline.

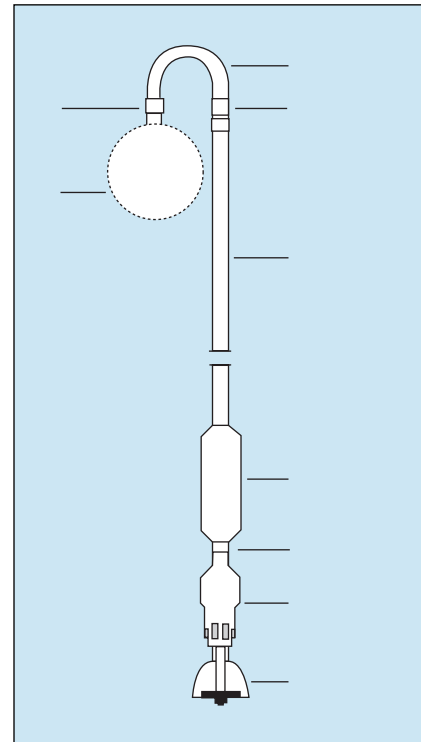

# Section 10

## Converting Existing Pivots to LEPA

Water outlets on older center pivot mainlines typically are spaced 8 ½ to 10 feet apart. Because LEPA drops are placed between every other crop row, additional outlets are needed. For example, for row spacing of 30 inches, drops are needed every 60 inches (5 feet). Likewise, for 36-inch row spacing, drops are placed every 72 inches (6 feet). Two methods can be used to install additional drops and applicators:

- 1) Converting the existing outlets with tees, pipe and clamps or
- 2) Adding additional mainline outlets

Installation is quicker if a platform is placed underneath the pivot mainline. The platform can be made of planks placed across the truss rods or the sideboards of a truck. A tractor equipped with a front end loader provides an even better platform.

### Using Existing Outlets

First, the existing gooseneck is removed, and crosses, tees or elbows are connected to the mainline outlets as needed. One early system used drip-irrigation tees with galvanized or plastic pipe cut to extend from the outlet point to the drop location. A galvanized elbow was used to connect the drop to the extension pipe. Such an elbow should be clamped to the mainline to maintain the drop position (Fig. 11). Now, specially manufactured fittings and clamps are available to simplify the process. This type of system includes double-barb gooseneck and truss-rod hose sling as shown in Figure 12.

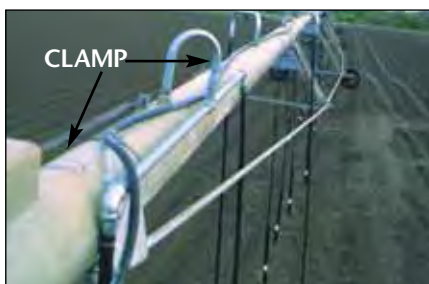

Figure 11. Adding drops.



Figure 12.a. A double barb gooseneck.



Figure 12.b. A truss-rod hose sling.

### Adding Outlets

It is less costly to convert to LEPA by adding outlets than to purchase the tees, plumbing, clamps and labor required to convert existing outlets. New mainline outlets can be installed quickly using a swedge coupler made of metal alloy. An appropriately sized hole is drilled into the pivot mainline at the correct spacing (Fig. 13). The swedge coupler is then inserted into this



Figure 13. Drilling for swedge coupler.

hole. The manufacturer recommends that a small amount of sealant be used with the swedge coupler to ensure a leak-proof connection. A standard hydraulic press (body hydraulic punch equipped with a pull-type cylinder) is attached to the coupler with a special screw-in fitting. The press is used to compress the coupler against the inside of the mainline pipe, making a water-tight seal (Fig. 14). The swedge coupler compresses quite easily; be careful not to over-compress it. Regular goosenecks or furrow arms are then screwed into the coupler (Fig. 15).

Outlets also can be added by welding threaded  $\frac{3}{4}$ -inch female couplings into the existing mainline. Since welding destroys galvanized coating, welded couplings should be used only on ungal-



Figure 14. Installing swedge coupler.



Figure 15. Swedge coupler installed.

vanized mainlines. As with the swedge coupler, goosenecks and drops can be used with welded couplings.

## Other Conversion Tips

When water is pumped into a center pivot, it fills the mainline and the drops. The weight of the water causes the pivot to lower or “squat.” With 160-foot spans, the pivot mainline will be lowered approximately 5 inches at the center of the span. Likewise, when filled with water, a 185-foot span will be about 7 inches lower at its center. Length of the hose drops should account for this change, so that when the system is running, all LEPA heads are about the same height above the ground. Center pivot manufacturers can provide appropriate drop-hose cut lengths. Goosenecks or furrow arms and drops are installed alternately on each side of the mainline to help equalize stresses on the pivot structure for high profile crops. Also, when crops are not planted in circles, having drops on both sides of the mainline helps prevent all the water from being dumped into the same furrows as the system parallels crop rows.

## Exercise 10

1. To install additional drops and applicators, one can convert the existing outlets with tees, pipe and clamps, or add additional mainline outlets.
  - a. True
  - b. False
2. Specially manufactured fittings and clamps, called double-barbed slings, are now available to simplify the adding of additional drops.
  - a. True
  - b. False

# Section 11

## Accessories and Other Considerations

---

---

A permanently installed, continuously functioning flow meter measures the actual amount of irrigation water applied and is recommended. It is used for irrigation-water management, in conjunction with the design printout. In addition, properly located pressure gauges monitor system performance and, combined with the flow meter, provide immediate warning of water deficiency and other system failures. Two pressure gauges are needed on the center pivot, one at the end of the system, usually in the last drop upstream from the applicator or regulator, and one at the pivot point. A third one in the first drop of span one will monitor operating pressure when the machine is down slope with relation to the pivot point.

On older equipment, conventional mainline outlets were spaced every 8 ½ to 10 feet. New center pivots should have 60- or 80-inch mainline outlet spacing, even if this reduced spacing is not required by the water applicator initially selected. Manufacturers continue to develop more efficient applicators, designed to be spaced closer together to achieve maximum irrigation efficiency and pumping economy.

Ordering your pivot with closer mainline outlet spacing will ensure that in the future it can be quickly and inexpensively be equipped with new applicator designs. Retrofitting mainline outlet spacing typically costs \$5,000 to \$7,000 more than specifying such spacing at the time of initial

purchase. As with any other crop production investment, a center pivot should be purchased only after careful analysis. Compare past crop production per acre-inch of irrigation applied to the production projected with center pivot irrigation (use Table 2 and consider the reduced cost of labor and tillage); also consider how much water is available. Then answer the question: Will a center pivot cost or make money in my operation? But remember, personal preference also is an important consideration.

### Exercise 11

1. Two pressure gauges are needed on a center pivot for proper management.
  - a. True
  - b. False
2. Close outlet spacing should always be ordered on a new pivot.
  - a. True
  - b. False
3. A flow meter is used along with the pressure gauges to provide immediate warnings of problems.
  - a. True
  - b. False

# Section 12

## Pivot Management

Pivot management is centered around knowing the number of inches of water applied. The system design printout includes a precipitation chart listing total inches applied for various central control panel speed settings. If a precipitation chart (Fig. 4) is not provided, contact the dealer who first sold the pivot to obtain a copy. Dealers usually keep copies of computer design printouts indefinitely. When a precipitation chart is not available, use Table 6 to determine irrigation amounts based on flow rate and time required to complete a circle. For other sizes of pivots or travel speeds, irrigation inches can be calculated using the first equation below. Keep in mind that the equations assume 100 percent water-application efficiency. Reduce the amounts by 2 to 5 percent for LEPA, 5 to 10 percent for LESA, 20 percent for MESA, and 35 to 40 percent for impact sprinklers. Calculations for pivots of other lengths can be made using the formulas below.

1. Inches applied = 
$$\frac{\text{Pivot GPM} \times \text{hours to complete circle}}{450 \times \text{acres in circle}}$$
2. Acres per hour = 
$$\frac{\text{Acres in circle}}{\text{Hours to complete circle}}$$
3. End tower speed in feet per hour = 
$$\frac{\text{Distance from pivot to end tower in feet} \times 2 \times 3.14}{\text{Hours to make circle}}$$
4. Number of feet the end of machine must move per acre = 
$$\frac{87,120}{\text{Distance (feet) from pivot to outside wetting pattern}}$$

**Table 6. Inches of water applied by a 1,290-foot center pivot\* with 100 percent water application efficiency.**

Pivot GPM	Hours to complete 120-acre circle					
	12	24	48	72	96	120
400	0.09	0.18	0.36	0.53	0.71	0.89
500	0.11	0.22	0.44	0.67	0.89	1.11
600	0.13	0.27	0.53	0.80	1.06	1.33
700	0.16	0.31	0.62	0.93	1.24	1.55
800	0.18	0.36	0.71	1.07	1.42	1.78
900	0.20	0.40	0.80	1.20	1.60	2.00
1000	0.22	0.44	0.89	1.33	1.78	2.22
1100	0.24	0.49	0.98	1.47	1.95	2.44
End tower feet/hour	667	334	167	111	83	67
Acres/hour	10	5	2.5	1.7	1.3	1

\*1,275 feet from pivot to end tower + 15-foot end section

### Runoff Management

Runoff from center pivot irrigation can be controlled through matching water application to soil infiltration by changing the optional speed control settings. Agronomic methods of runoff control include furrow diking (or "chain" diking for pastures), farming in a circular pattern, deep chiseling of clay sub-soils, maintaining crop residue, adding organic matter, and using tillage practices that leave the soil "open."

Farming in the round is one of the best methods of controlling runoff and improving water distribution. When crops are planted in a circle, the pivot never dumps all the water in a few furrows, as it may when it parallels straight rows. Circle farming begins by marking the circular path of the pivot wheels as they make a revolution without water. The tower tire tracks then become a guide for row lay out and planting. If the mainline span length (distance between towers) does not accommodate an even number of crop rows, adjust the guide marker so that the tower wheels travel between crop rows.



Furrow diking is a mechanical tillage operation that places mounds of soil at selected intervals across the furrow between crop rows to form small water storage basins. Rather than running off, rainfall or irrigation water is trapped and stored in the basins until it soaks into the soil (Fig. 8).

Furrow diking reduces runoff and increases yields in both dry land and irrigated crops. A similar practice for permanent pastures, called chain diking, involves dragging a chain-like implement that leaves water-collecting depressions.

### Exercise 12

1. How many feet must the end of a center pivot move per acre if the distance from the pivot to outside wetting pattern is 600 feet?
  - a. 135.1
  - b. 145.2
  - c. 155.3
  - d. 165.4
  - e. 175.5

2. Methods of runoff control include which of the following:

- a. Furrow diking and using tillage practices that leave the soil "open."
- b. Farming in a circular pattern
- c. Deep chiseling of clay sub-soils
- d. Maintaining crop residue and adding organic matter
- e. All of the above

3. How long will it take for a 1,290 foot long pivot to complete a 120 acre circle and apply 1.07 inches of water with a flow rate of 800 gpm?

- 12
- 120
- 72

# Section 13

## Irrigation Scheduling

---

---

### ET-Based

Maximum crop production and quality are achieved when crops are irrigated frequently with amounts that match their water use or ET (evapotranspiration), commonly twice weekly with center pivots. Texas has three PET (Potential Evapotranspiration) weather-station and crop-water-use reporting networks, located at Amarillo, College Station and Lubbock. These networks report daily crop water use based on research. One strategy used by growers is to sum the daily crop water use (ET) reported for the previous 3 to 4 days, then set the pivot central control panel to apply an amount of water equal to that sum. (For more information on PET networks, contact your county Extension office.)

The PET networks report daily crop water-use for full irrigation. Most center pivots operating on the Texas South Plains and High Plains are planned and designed for insufficient capacity (gpm) to supply full daily crop water-use. Growers with insufficient center pivot capacity should use a high water management strategy to ensure that the soil root zone is filled with water by rainfall, pre-watering or early-season irrigation before daily crop water-use exceeds irrigation capacity. Most soils, such as Pullman, Sherm, Olton and Acuff series soils, can store approximately 2 inches of available water per foot of topsoil. Sandy soils store less. Sandy loam soils typically store 1 inch or more of available water per foot of topsoil. The county soil survey available from the Natural Resources Conservation Service lists available water storage capacity for most soils. Be sure to use the value for the soil at the actual center pivot site.

### Soil Moisture-Based

Soil-moisture monitoring is recommended and complements ET-based scheduling, particularly when rainfall occurs during the irrigation season. Soil-moisture monitoring devices such as tensiometers and watermark and gypsum block sensors can identify existing soil moisture, monitor moisture changes, locate depth of water penetration, and indicate crop rooting depths. These three types of sensors' moisture absorption and loss are similar to that of the surrounding soil.

Gypsum block and watermark sensors are read using resistance meters. Watermark sensors respond more quickly and more accurately than do gypsum blocks but cost more. Readings may be taken weekly during the early growing season. During the crop's primary-water-use periods, readings should be taken two or three times each week for more timely management.

Tensiometers have gauges that measure soil moisture pressures in centibars. Tensiometers are highly accurate but are most useful in lighter, frequently irrigated soils.

Plotting sensor readings on computer spreadsheets or on graph paper helps track and interpret them to manage irrigation. The example shown in Figure 16 describes using gypsum blocks to measure soil moisture in wheat production.

A single block or tensiometer installed at a depth of 12 to 18 inches will measure moisture in the upper root zone; another installed at 36 inches will measure deep moisture. Sensors usually are installed at three depths — 12, 24 and 36 inches — and at a representative location in the field where soil is uniform. They should not be placed on extreme slopes or in low areas where water may pond. Select a location within the next to the last center pivot span but away from the wheel tracks.

Locate sensors within the crop row so they do not interfere with tractor equipment. Follow manufacturers' recommendations on preparing sensors. To obtain accurate readings, the sensing tip must make firm contact with undisturbed soil. The soil auger used to install sensors must be no more than  $\frac{1}{8}$  inch larger than the sensing unit.

### Exercise 13

1. Maximum crop production and quality are achieved when crops are irrigated frequently with amounts that match their water use or ET (evapotranspiration).
  - a. True
  - b. False

2. The following is a soil-moisture monitoring device:

- a. Tensiometer
- b. Watermark
- c. Gypsum block sensor
- d. All of the above
- e. None of the above

3. Soil moisture monitoring devices can do which of the following:

- a. Identify existing soil moisture
- b. Monitor moisture changes
- c. Locate the depth of water penetration
- d. Indicate crop rooting depths
- e. All of the above

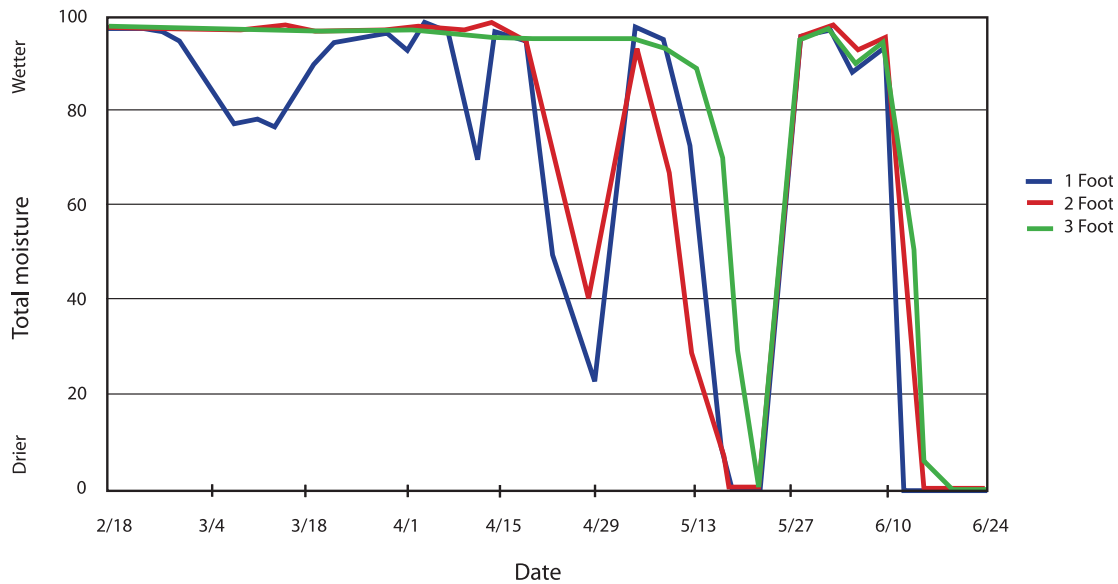

Figure 16a. Soil moisture measurements in a wheat field. Soil moisture should not fall below a reading of 40 to 60 for most soil types.

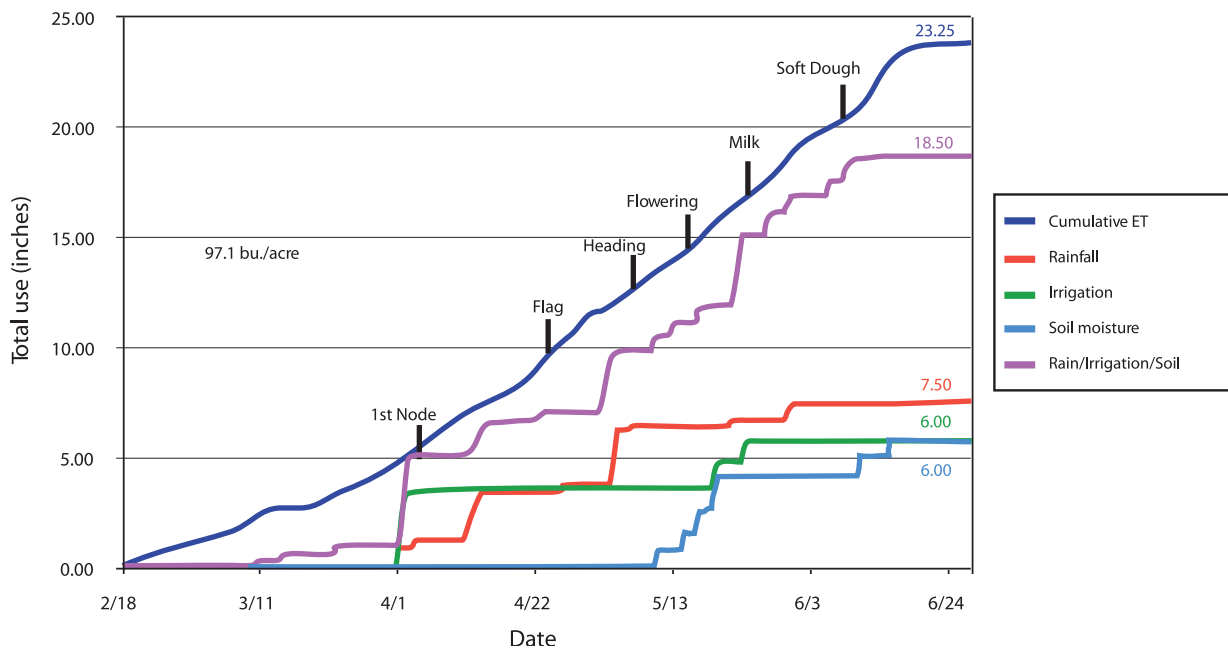

Figure 16b. Cumulative ET and total water supplied to the wheat field in Figure 15a.

# Section 14

## Chemigation

---

---

### Chemigation

Chemigation uses irrigation water to apply an approved chemical (fertilizer, herbicide, insecticide, fungicide or nematicide) through the center pivot. Chemigation is an advanced concept. Labels of pesticides and other chemicals must state whether a product is approved for application in this way. If so, application instructions will be provided on the label.

EPA regulations require use of specific safety-control equipment and devices designed to prevent accidental spills and contamination of water supplies. Using proper chemigation safety equipment and procedures also aids the grower by providing consistent, precise and continuous chemical injection, thus reducing the amounts (and costs) of chemicals applied. As in Texas, other states' regulatory agencies may have their own requirements in addition to those of the EPA. For more information, contact your county Extension office or state department of agriculture.

The advantages of chemigation include:

- ◆ **Uniformity of application.** With a properly designed irrigation system, both water and chemicals can be applied uniformly, resulting in excellent distribution of the water-chemical mixture.
- ◆ **Precise application.** Chemicals can be applied in correct concentrations where they are needed.
- ◆ **Economics.** Chemigation is usually less expensive than other application methods and often requires smaller amounts of chemicals.
- ◆ **Reduced soil compaction and crop damage.** Because conventional in-field spray equipment may not be needed, chemigation may reduce tractor-wheel soil compaction and crop damage.
- ◆ **Operator safety.** Because an operator need not be continuously present in a field during applications, chemigation reduces human contact with chemical drift and reduces exposure during frequent tank fillings and other tasks.

Chemigation does have disadvantages, however; they include:

- ◆ **Skill and knowledge required.** Chemicals always must be applied correctly and safely. Chemigation requires skill in calibration, knowledge of irrigation and chemigation equipment, and an understanding of chemical and irrigation scheduling concepts.
- ◆ **Additional equipment.** Proper injection and safety devices are essential; growers must comply with these legal requirements.

### Fertigation

Application of fertilizers using irrigation water (fertigation) often is referred to as “spoon-feeding” the crop. Fertigation is common and has many benefits. Most fertigation uses soluble or liquid formulations of nitrogen, phosphorus, potassium, magnesium, calcium, sulfur and boron.

Nitrogen is most commonly applied because crops need large amounts of it. Keep in mind that because nitrogen is highly soluble and has the potential to leach, its application needs to be managed carefully. Several nitrogen formulations can be used for fertigation, as shown in Table 7. Be sure solid formulations are dissolved completely in water before being metered into the irrigation system. (Up to three 80-pound bags of nitrogen fertilizer can be dissolved in a 55-gallon drum.) Complete mixing may require initially agitating the mixture for several hours and then throughout the injection process.

The advantages of fertigation include:

- ◆ Nutrients can be applied based on crop needs any time during the growing season.
- ◆ Mobile nutrients such as nitrogen can be regulated with the amount of water applied, so that they are available for rapid use by crops.
- ◆ If the irrigation system distributes water uniformly, nutrients can be applied uniformly over the field.

**Table 7. Amount of fertilizers needed to apply specific amounts of nitrogen.**

Kind of fertilizer	Pounds of N per acre				
	20	40	60	80	100
<b>Solid</b> Ammonium nitrate (33.5% nitrogen) Ammonium sulfate (20.5% nitrogen) Urea (45% nitrogen)	Pounds per acre of fertilizer needed for rate of N listed above				
	60	120	180	240	300
	98	196	294	392	488
	44	89	133	177	222
<b>Solutions</b> Urea-ammonium nitrate (28% nitrogen) Urea-ammonium nitrate (32% nitrogen) Ammonium nitrate (21% nitrogen)	Gallons per acre of fertilizer needed for rate of N listed above				
	6.7	13.4	20	26.8	33.4
	5.7	11.4	17	22.8	28.5
	8.9	17.8	26.7	35.6	44.5

- Some tillage operations may be eliminated, especially if fertilization coincides with the application of herbicides or insecticides. However, do not simultaneously inject two chemicals without knowing whether they are compatible with each other and with the irrigation water.
- Groundwater contamination is less likely with fertigation because less fertilizer is applied at any given time. Application can correspond to periods of maximum crop need.
- There is minimal crop damage during fertilizer application.

Fertigation does have some disadvantages, however; these include:

- Fertilizer distribution is only as uniform as irrigation water distribution. Use pressure gauges to ensure that the center pivot maintains proper pressures.
- Lower-cost fertilizer materials such as anhydrous ammonia often cannot be applied using fertigation.
- Fertilizer placement cannot be localized, as in banding.

- Ammonia solutions are not recommended for fertigation because ammonia is volatile and too much will be lost during the application process. Also, ammonia solutions may precipitate lime and magnesium salts, which are common in irrigation water. Resulting precipitates can build up on the inside of irrigation pipelines and clog nozzles. Besides ammonia, various polyphosphates (e.g., 10-34-0) and iron carriers can react with soluble calcium, magnesium and sulfate salts to form precipitates. The quality of irrigation water should be evaluated before using fertilizers that may create precipitates.
- Many fertilizer solutions are corrosive. Fertigation injection pumps and fittings constructed of cast iron, aluminum, stainless steel and some forms of plastic are less subject to corrosion and failure, but those made of brass, copper and bronze are easily corroded.

Know the materials contained in all pump, mixing and injector components in direct contact with concentrated fertilizer solutions. Table 8 describes the corrosion potential of various metals when they come into direct contact with common commercial fertilizer solutions.

**Table 8. Relative corrosion of various metals after 4 days of immersion in solutions of commercial fertilizers.\***

Fertilizer	pH of solution	Kind of metal				
		Galvanized iron	Sheet aluminum	Stainless steel	Bronze	Yellow brass
Relative corrosion						
Calcium nitrate	5.6	Moderate	None	None	Slight	Slight
Sodium nitrate	8.6	Slight	Moderate	None	None	None
Ammonium nitrate	5.9	Severe	Slight	None	High	High
Ammonium sulfate	5.0	High	Slight	None	High	Moderate
Urea	7.6	Slight	None	None	None	None
Phosphoric acid	0.4	Severe	Moderate	Slight	Moderate	Moderate
Di-ammonium phosphate	8.0	Slight	Moderate	None	Severe	Severe
Complete fertilizer 17-17-10	7.3	Moderate	Slight	None	Severe	Severe

\*Solutions of 100 pounds of material in 100 gallons of water.

## Exercise 14

1. Chemigation using irrigation water to apply an approved chemical (fertilizer, herbicide, insecticide, fungicide or nematicide) through the center pivot.
  - a. True
  - b. False
  
2. What are the advantages of chemigation?
  - a. Uniformity and precision of application
  - b. Economics and timeliness
  - c. Reduced soil compaction and crop damage
  - d. Operator safety
  - e. All of the above
  
3. What are the disadvantages of chemigation?
  - a. Requires skill in calibration
  - b. Proper injection and safety devices are essential
  - c. Grower must be in compliance with legal requirements
  - d. Requires knowledge of the irrigation and chemigation equipment
  - e. All of the above
  
4. What are the advantages of fertigation?
  - a. Nutrients can be spoon-fed to the crop
  - b. Groundwater contamination less likely
  - c. Some tillage operations may be eliminated
  - d. All of the above
  
5. What are the disadvantages of fertigation?
  - a. Fertilizer distribution is only as uniform as the distribution of irrigation water
  - b. Fertilizer placement cannot be localized
  - c. Some fertilizer solutions are corrosive
  - d. Lower-cost fertilizer materials often can not be used
  - e. All of the above

# Section 15

## Center Pivot Buyer's Check List

---

---

### Pivot Design

- \_\_\_ Actual lowest and highest elevations in field with relation to the pivot point were used in the computer design printout.
- \_\_\_ Actual measured flow rate and pressure available from pump or water source was used in the computer design printout.
- \_\_\_ Friction loss in pivot mainline is no greater than 10 psi for quarter-mile long systems.
- \_\_\_ Mainline outlets are spaced a maximum of 60 to 80 inches apart or, alternately, no farther apart than two times the crop row spacing.
- \_\_\_ For non-leveled fields, less than 20 percent pressure variation in system-design operating pressure is maintained when pivot is positioned at highest and lowest points in the field (computer design printout provided for each case).
- \_\_\_ Pressure regulators were evaluated for fields with more than 5 feet of elevation change from pad to the highest or the lowest points in the field.
- \_\_\_ Tower wheels and motor sizes were selected based on soil type and slope following manufacturers' recommendations.
- \_\_\_ Dealer has provided a copy of pivot design printout.

### Applicators

- \_\_\_ Design has no end gun.
- \_\_\_ Consideration was given to equipping the pivot with either LEPA or LESA applicators as follows:
  1. LEPA (low elevation precision application)
    - Option 1:
      - Multi-functional LEPA head with an operating pressure requirement of 6 psi,

positioned 1 to 1.5 feet above the ground, spaced at 2 times the crop row spacing. Flexible drop hose from goose neck or furrow arm on mainline to applicator, equipped with a plastic or a metal weight

Option 2:

- Spray applicator with operating pressure requirement no greater than 10 psi, located 1 to 1.5 feet above the ground. For row crops, spray applicator is equipped with a switchable plate to allow for attachment of a drag hose or double-ended sock
- Flexible drop hose from gooseneck or furrow arm on mainline to applicator, equipped with a plastic or a metal weight

2. LESA (low elevation spray application)

Spray applicators with operating pressure requirement no greater than 10 psi, located 1 to 2 feet above ground

Flexible drop hose from gooseneck or furrow arm on mainline to applicator, equipped with a polyweight or another type of weight

### Installation and Water and Power Supply

- \_\_\_ Pivot pad has been constructed to manufacturer's specifications.
- \_\_\_ Subsurface water-supply pipeline to pivot point is sized to keep water velocity at or below 5 feet per second.
- \_\_\_ Power supply has been connected to pivot following manufacturer's specifications. Power supply may be a power unit alone, a power unit and generator, or subsurface power lines.

## Accessories

- System includes propeller flow meter or other type of flow measurement device having accuracy to + 3 percent and instantaneous flow rate (i.e., gpm) and totalizer (acre-ft, ft<sup>3</sup>, etc.) indicators installed in water-supply pipeline near pivot point. These indicators should be placed in a straight section that is 10 pipe diameters upstream and 5 pipe diameters downstream from the flow meter.
- System includes two pressure gauges, one on the mainline near the pivot point and one in the last drop, located just above the applicator or pressure regulator.
- System includes a computer control panel for fields with soil changes and/or multi-crop situations.
- System has remote control/monitoring system (optional).
- System includes a chemigation unit meeting federal safety requirements and tied into computer control panel or power shut-off system with a positive displacement injector pump sized according to the pivot flow rate.



The logo features a blue circular arrow icon to the left of the text. The text 'Center Pivot' is in a large, bold, white sans-serif font, with 'Center' on the top line and 'Pivot' on the bottom line. Below this, the word 'Workbook' is written in a smaller, white sans-serif font.

# Center Pivot Workbook

Produced by Agricultural Communications, The Texas A&M University System

Extension publications can be found on the web at: <http://tcebookstore.org>  
Visit Texas Cooperative Extension at: <http://texasextension.tamu.edu>

*Educational programs conducted by Texas Cooperative Extension serve all people without regard to race, color, sex, disability, religion, age or national origin.*

Issued in furtherance of Cooperative Extension Work in Agriculture and Home Economics, Acts of Congress of May 8, 1914, as amended, and June 30, 1914, in cooperation with the United States Department of Agriculture. Edward G. Smith, Interim Director, Texas Cooperative Extension, The Texas A&M University System.

1,000, New



# Utilizing Center Pivot Sprinkler Irrigation Systems to Maximize Water Savings



United States  
Department of  
Agriculture

Natural  
Resources  
Conservation  
Service

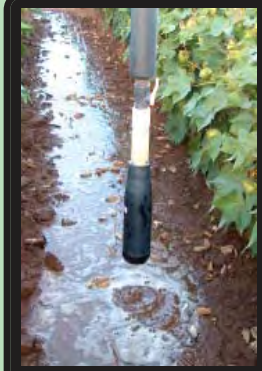

**Utilizing  
Center Pivot Sprinkler  
Irrigation Systems  
to Maximize  
Water Savings**



# *Introduction*

Center pivot sprinkler irrigators of the Ogallala Aquifer on the High Plains of Texas are widely recognized by the irrigation industry for operating the most efficient sprinkler systems in the world. Most irrigators in this region have adapted high application efficiency sprinkler systems into their farming operations as a result of physical, economic, and social limitations on their businesses. The physical limitations of this sub-humid, semi-arid region which include low rainfall, low humidity, high wind, high temperature, and the Ogallala's finite use as an irrigation source, have resulted in their desire to conserve, for beneficial use, as much irrigation water as feasible. Economic pressures of high energy cost, labor cost, and low crop value have prompted irrigators to become economically efficient by utilizing low pressure mechanical irrigation systems as well. Social pressures to maintain the economic viability of the region by conserving the aquifer for use over a long period of time have created awareness by irrigators of their mutual dependency with the region's agricultural infrastructure.

To understand the progression of the development of center pivot sprinkler irrigation on the High Plains, the Ogallala Aquifer's formation, geology, history, and current status should be understood. The Ogallala Formation was deposited across the Great Plains by easterly flowing streams, which originated during the formation and erosion of the Rocky Mountains. Coarse-grained sand, gravel, fine clay, silt, and sand were deposited over the pre-Ogallala land surface, which was much like the present-day area of the Rolling Red Plains just east and in some areas west of the High Plains. These outflow materials from the Rocky Mountains were saturated with water. The base of the Ogallala, called the red beds, contains hills, plateaus, and stream valleys. This red bed base of the aquifer has a relatively high clay content and prevents or greatly limits the downward movement of water. The topography of the base causes variations in the depth of the water saturated thickness of the aquifer. In some parts of Nebraska, the saturated thickness exceeds 1,000 feet, while in other areas of the formation there is no saturation at all. Windblown materials of sands, silts, and clays from the Permian Basin, the Pecos River valley and other areas along the foothills of the Rockies were deposited over the top of the Ogallala Formation. These materials provide the rich soils on the land surface of the Great Plains today. Changes in climate and geologic conditions resulted in erosion patterns that caused the Ogallala Aquifer to be cut off from its original supply of water. The southern portion of the aquifer in Texas and New Mexico is now a plateau, cut off from groundwater recharge on all sides. Because the region is primarily in a semi-arid climate there is little rainfall recharge in most years. Most of the water in the Ogallala Aquifer of the High Plains of Texas was deposited there during the formation of the aquifer.

The Ogallala Aquifer covers 174,000 square miles of eight states and has long been a major source of water for agricultural, municipal, and industrial development on the Great Plains. Nebraska with 64,400 square miles and Texas with 36,080 are the largest. New Mexico, Oklahoma, South Dakota, and Wyoming all have less than 10,000 square miles of surface area underlain by the Ogallala. The amount of aquifer water in storage in each state is dependent on the actual extent of the formation's saturated thickness. In 1990, the Ogallala Aquifer in the eight-state area of the Great Plains contained 3.270 billion acre-feet of water. Out of this, about 65% was located under Nebraska, Texas had about 12% of the water in storage or approximately 417 million acre-feet of water, Kansas had 10% of the water, about 4% was located under Colorado, and 3.5% was located under Oklahoma. Another 2% was under South Dakota and 2% was under Wyoming. The remaining 1.5% of the water was under New Mexico.



## **THE DEVELOPMENT OF SPRINKLER IRRIGATION ON THE HIGH PLAINS OF TEXAS**

The first irrigation wells were dug in the early 1900's. By the 1930s, people had begun to realize the potential of the vast water supply that lay beneath them. By 1949 about 2 million acres of the southern High Plains were irrigated. Recurring drought in the fifties encouraged irrigation all over the High Plains. Technology changed too and over the High Plains the number of wells increased from 14,000 in 1950 to 27,500 in 1954. Irrigated acreage expanded from 1.86 million acres to 3.5 million in the same period. The irrigation boom peaked in the middle 1970s, decreased, then stabilized about 1980. Most of the irrigated acreage was surface or flood irrigated land. Since water pumped from the aquifer could not be replaced at the same rate that it was removed, the water table began to decline. Monitoring of the water level in the aquifer's southern High Plains area showed rapid declines in the water table in the early 1950s, the 1960s, and the 1970s. Declines of a foot or more per year were recorded throughout the 1950s; and during the late 1950s at the peak of irrigation development, some monitoring wells declined as much as five feet in a single year. In the earliest days of irrigation on the Texas High Plains very little water conservation equipment or technology was available and large amounts of water was lost to evaporation and deep percolation. Rapidly declining aquifer levels combined with high energy costs in the early 1970s caused the abandonment of many acres of irrigated land. Other irrigators became aware of the need for efficient irrigation systems that could reduce energy costs. The center pivot sprinkler was a perfect fit.

Center Pivot sprinklers had been installed on sandy soils on the High Plains since the 1950's. This type of pivot used pressured water to power the wheels and move the pivot. Operating at around 100 psi these pivots used wide spaced impact nozzles that sprayed water high into the air resulting in high evaporation losses and non-uniform application patterns.

They were not energy or water efficient and were not the solution for the irrigator's dilemma. In the early 1970's new electric and hydraulic oil powered pivots were appearing on the High Plains. While these center pivots were a great leap forward in sprinkler irrigation and energy conservation, most utilized wide-spaced, high elevation nozzles.

Irrigation efficiency evaluations conducted through a joint effort of the Soil Conservation Service, now known as the Natural Resources Conservation Service (NRCS), the High Plains Underground Water District #1, and local Soil and Water Conservation Districts showed a tremendous need for better pattern and spray nozzle designs by pivot manufacturers. This joint effort, in cooperation with pivot manufacturers, irrigators and state extension personnel led to the greatest advancement of sprinkler irrigation technology with the development of the modern high efficiency, low pressure, close spaced nozzle pivot designs that are so prevalent today on the High Plains of Texas. The irrigators of the Texas High Plains embraced these systems as one of the solutions for aquifer conservation. During the 1980's and 1990's, due to continued aquifer declines and rising labor costs, many thousands of acres of surface irrigated land were converted to these highly efficient center pivot sprinklers. Today most of the irrigated lands on the High Plains in Texas utilize these advanced efficiency, low pressure center pivot sprinklers.

The irrigators of the Texas High Plains are perhaps the most efficient irrigators in the world. They have realized that the first step in water conservation is to utilize high efficiency irrigation systems that allow control of irrigation application amounts. They also realize that the future of the Ogallala Aquifer and the region depends on their stewardship of the land.



# LEPA

## LOW ENERGY PRECISION APPLICATION

### SYSTEM MANAGEMENT

Low Energy Precision Application (LEPA) systems are only applicable on crops planted with furrows or beds. Circular rows are used with center-pivot systems and straight rows are to be used with linear systems. For ease of farming operations, some straight rows are allowed near the center of the center-pivot systems.

The land slope for a LEPA system should not exceed 1.0 percent on more than 50 percent of the field. LEPA systems should employ some method of providing surface basin storage such as furrow diking or pitting or implanted reservoirs. Water is not applied in the tower wheel track.



- REQUIRED CU (Coefficient of Uniformity) – 94 percent
- APPLICATION METHOD - Water shall discharge through a drag sock or hose on the ground surface, or through a nozzle equipped with a bubble shield or pad.
- NOZZLE SPACING – No greater than two times the row spacing of the crop.
- NOZZLE HEIGHT – Less than 18 inches in Bubble Mode. Nozzle height is not applicable when using drag hoses. All application device heights above the soil surface should be uniform when the system is operating.
- ROW ARRANGEMENT – Circular rows
- SLOPE OF FIELD – 1 percent or less



All materials used in the installation of the LEPA system shall be new and free from defects when converting an existing sprinkler system to LEPA. With the exception of weights, none of the existing sprinkler system shall remain as part of the new LEPA below the existing furrow arms or goosenecks. The LEPA shall be comprised of all new components including the flexible drop hose, any rigid pipe used on the drop, pressure regulators (if needed), gate valves (if needed), nozzle bodies or bracket assemblies, sprinkler or bubbler-type nozzles and drag socks or surface hoses.



*Furrow diking is used as a preferred management strategy method for providing surface basin storage.*

*Terry county producer Steve Ellis uses LEPA irrigation applying proper management to include circular rows and furrow diking. He said, "I need to be as efficient as possible with my irrigation water. Keeping the water applied on the ground rather than spraying it in air just makes good sense."*

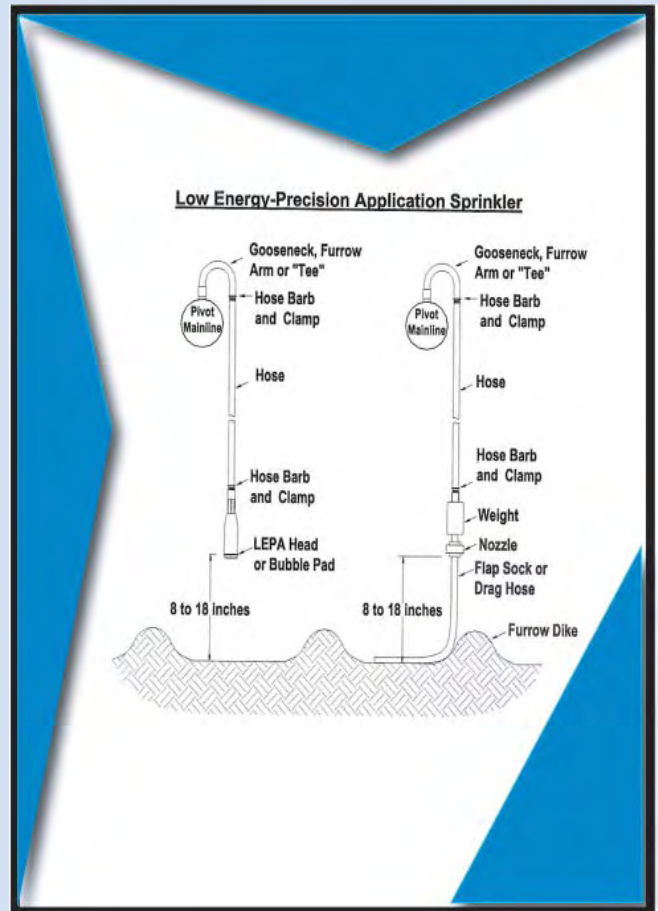



LESA

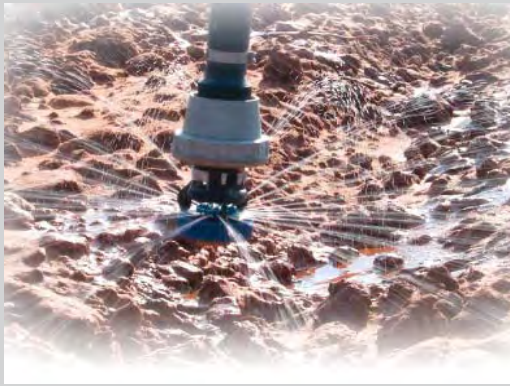

## LOW-ELEVATION SPRAY APPLICATION SYSTEM MANAGEMENT

For optimum efficiency, circular rows should be used with center-pivot systems and straight rows should be used with linear systems. When farming in a circle pattern, straight rows can be utilized near the center of center-pivot systems for ease of farming operations.

The land slope for a LESA system should not exceed 3.0 percent on more than 50 percent of the field. Tillage and/or residue management should be utilized as necessary to control excessive translocation (> 30 ft.) of applied irrigation water. This could include furrow diking or pitting, in-furrow chiseling, or residue management such as limited or no tillage. Terraces may be needed on steeper slopes (> 2 percent) to control rainfall and irrigation induced erosion.

- REQUIRED CU (Coefficient of Uniformity) – 94 percent
- NOZZLE SPACING – No greater than two times the row spacing of the crop.
- NOZZLE HEIGHT – Less than 18 inches above the soil surface. All application device heights above the soil surface should be uniform when the system is operating.
- ROW ARRANGEMENT – Any row arrangement





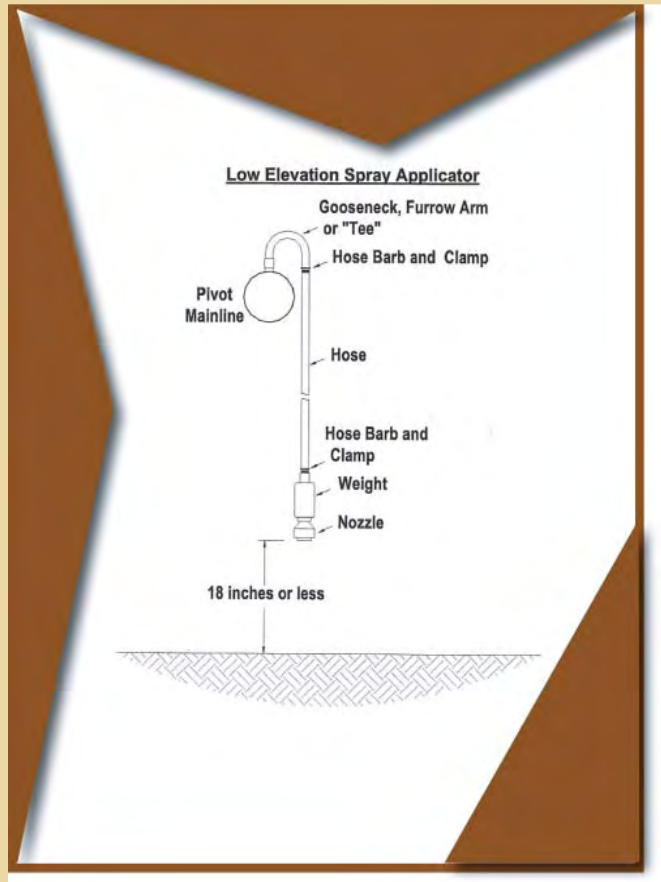

When converting an existing sprinkler system to Low Elevation Spray Application (LESA), all materials used in the installation of the sprinkler system including the LESA sprinkler nozzle package shall be new and free from defects.

Nozzle spacing shall not be greater than two times the row spacing of the crop. Nozzle heights shall not exceed 18 inches above the soil surface when the system is operating. All LESA nozzle heights shall be uniform when the system is operating.

After installation, the system shall be pressure tested at the system operating pressure. All leaks shall be repaired to insure a leak-free system.

*Cochran county producer Russell Greener converted from sideroll irrigation to center pivot sprinklers utilizing LESA nozzles after being approved for the Environmental Quality Incentives Program (EQIP). Greener pre-waters using the bubble mode option to concentrate the water down his rows. He is pleased with the results he has experienced with his system. Greener said, "With this system, it only takes five days to apply one inch with less evaporation. It's a more efficient system that provides labor savings, and gives me the ability to chemigate through the system when I apply fertilizers and pesticides. It's all a learning process, and the more we experience, the better it gets."*





# LPIC

## Low Pressure In Canopy



### System Management

For optimum efficiency, circular rows should be used with center-pivot systems and straight rows should be used with linear systems. When farming in a circle pattern, straight rows can be utilized near the center of the center-pivot systems for ease of farming operations. The land slope for a LPIC system should not exceed 3.0 percent on more than 50 percent of the field. Field runoff should be controlled.

Tillage and/or residue management should be utilized as necessary to control excessive translocation (> 30 ft.) of applied irrigation water. These could include furrow diking or pitting, in-furrow chiseling, or residue management such as limited or not tillage. Terraces may be needed on steeper slopes (> 2 percent) to control rainfall and irrigation induced erosion.

- REQUIRED CU (Coefficient of Uniformity) - 90 percent
- NOZZLE SPACING – Optimum is two crop rows, but drops may be spaced up to 10 feet apart.
- NOZZLE HEIGHT – should be within the planned crop canopy. Lower nozzle heights will require a closer nozzle spacing to insure a high distribution uniformity.
- ROW ARRANGEMENT – Any row arrangement
- SLOPE OF FIELD – 3 percent or less



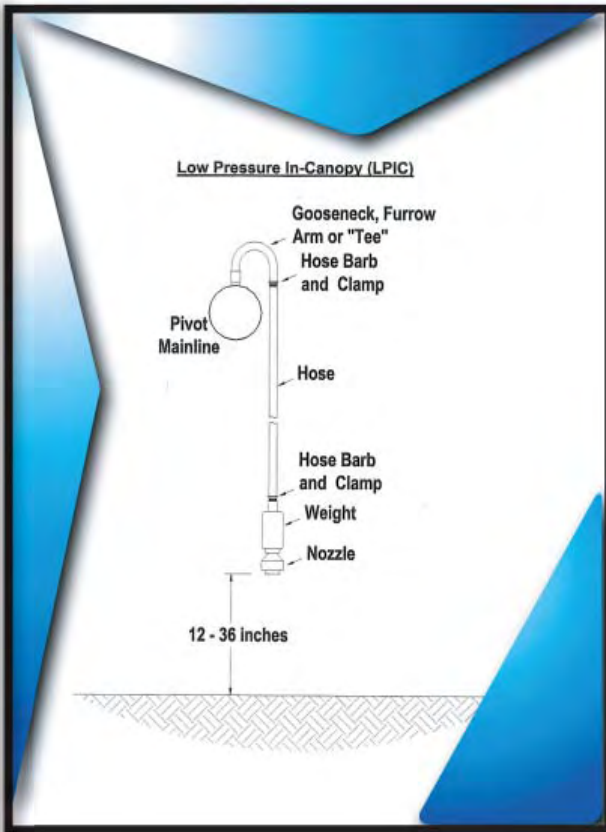

All materials used in the installation of the sprinkler irrigation including the Low Pressure In Canopy (LPIC) sprinkler nozzle package shall be new and free from defects.

LPIC sprinkler systems offer operators a high efficiency alternative application system when LEPA and LESA specification cannot be met. The LPIC system fills a niche on certain soil types, topography and row arrangement where LEPA and LESA systems are not the best choice.



Mike Tyler checks one of his cotton crops where he is using LPIC irrigation.

*Dawson County producer Mike Tyler has experimented using several irrigation methods. Low Pressure In Canopy (LPIC) has become his application and management choice. He converted to no-till farming about five years ago, planting a cover crop of wheat to protect his young cotton seedlings. Tyler said, "I use dual pads, a coarse pad and a chemigation pad, to irrigate in normal or chemigation mode. After I produce a stand, I can easily flip the pads to apply a chemigation spray mode application." Water is Tyler's limiting factor on his farms, and the LPIC system enables him to apply water more efficiently.*





# MESA

## Mid-Elevation Spray Application

### SYSTEM MANAGEMENT



Water distribution is greatly affected by nozzle spacing and height for MESA irrigation systems. In general, closer spaced nozzles will yield higher uniformity. Nozzle heights should be set above areas of high leaf concentrations.

Application rates shall be set such that runoff, translocation, and deep percolation are eliminated, or additional measures, such as furrow diking, in-furrow chiseling, conservation tillage and/or residue management shall be applied.

- REQUIRED CU (Coefficient Uniformity) – 90 percent
- NOZZLE SPACING – Optimum is two crop rows, but drops may be spaced up to 10 feet apart.
- NOZZLE HEIGHT – Above the crop canopy preferably within 3 to 7 feet of the soil surface depending on crop height.
- ROW ARRANGEMENT – Any row arrangement
- SLOPE OF FIELD – 3 percent or less

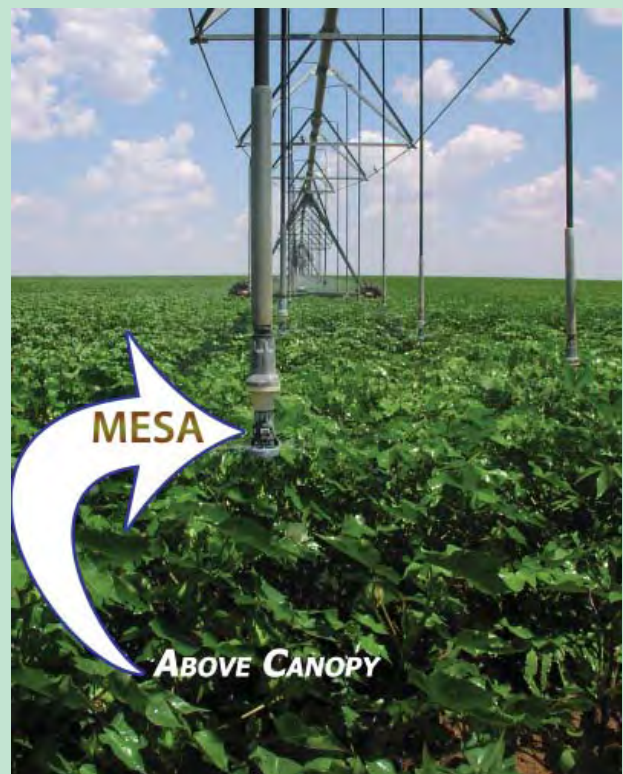



In the installation of the Mid-Elevation Spray Application (MESA), all materials used when converting an existing system to MESA shall be new and free from defects with the exception of weights. None of the existing sprinkler system shall remain as part of the new MESA system below the existing furrow arms or goosenecks. The MESA system will be comprised of all new components including the flexible drop hose, any rigid pipe used on the drop, pressure regulators (if needed), gate valves (if needed), nozzle bodies or bracket assemblies, sprinkler nozzles and splash and/or spray pads.

The existing weights, water outlets on the sprinkler mainline and furrow arms or goosenecks may be used provided they are not leaking and are in good condition. New mainline outlets to facilitate the location of the drops between crop rows shall be installed following the sprinkler system manufacturer's recommendations.



Don Blair rotates cotton and peanuts on his farms near O'Donnell.

*Lynn County producer Don Blair utilizes the Mid-Elevation Spray Application (MESA) on his sloped land. When asked how he determined which irrigation drop nozzle system would best fit his operation, he explained, "Experience is the best teacher. I chose to use the MESA system after listening and learning from those individuals already using the system." Blair is pleased with his MESA system that allows him full irrigation coverage over his crop.*

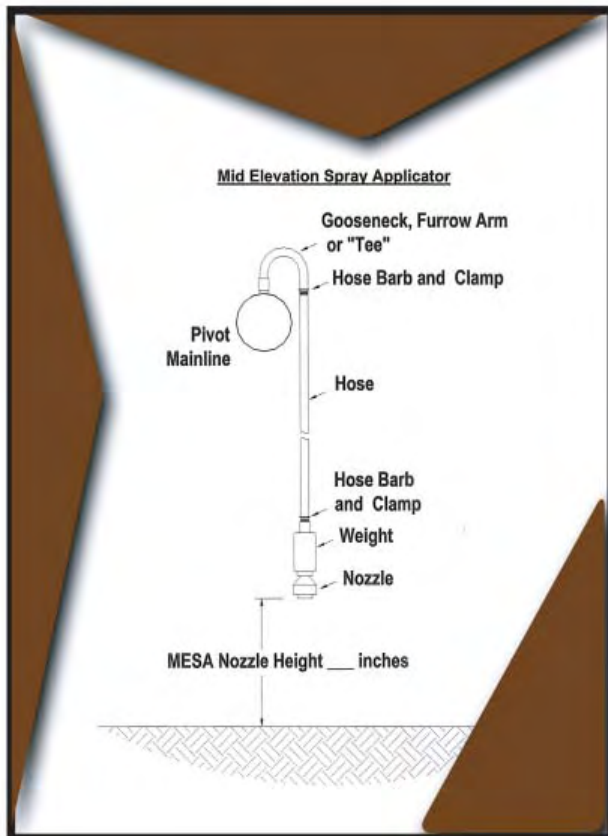

**E**NVIRONMENTAL QUALITY INCENTIVES PROGRAM (EQIP) is a federally funded cost-share program, which was reauthorized in the 2002 Farm Bill. The purpose of the program is to provide a voluntary conservation program to farmers and ranchers that promotes agricultural production and environmental quality.

The installation of new Low Energy Precision Application (LEPA), Low Pressure In-Canopy (LPIC), Low Elevation Spray Application (LESA), Mid-Elevation Spray Application (MESA) sprinkler systems, or the conversion of existing systems to these more efficient systems, are eligible for cost-share in the EQIP program if they are identified as a priority by the local work group in that county.

EQIP cost-share expenditures require the participant to move to a higher level of conservation. Replacement of an existing center pivot sprinkler with a new or refurbished center pivot sprinkler is not eligible for EQIP cost-share. Re-nozzling a pivot that maintains the same level of conservation, is not eligible for cost-share. These conservation practices are considered normal operation and maintenance.

Sprinkler systems vary greatly in size, cost, and adaptability. They must be properly designed, maintained and managed to operate efficiently.

## *Center Pivot Sprinkler Irrigation Systems*

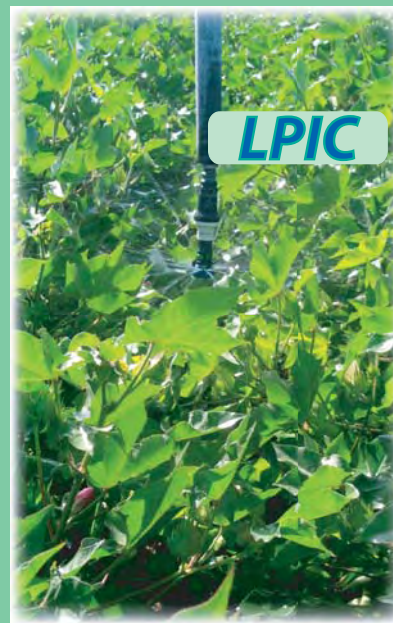



## LOCAL WORK GROUP PLANNING MEETINGS

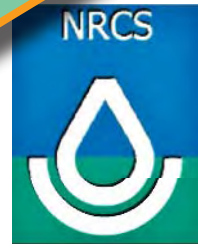

One of the guiding principles of the 2002 USDA Farm Bill is that conservation programs are locally led. Through stake holder meetings the public is given an opportunity to help local conservation leaders set program priorities.

Each county in Texas holds public meetings annually. These meetings are led by the local Soil and Water Conservation District and provide an opportunity for participation and comments from a broad range of local agencies, organizations, businesses and individuals that have an interest in natural resource conditions and needs.

The Local Work Groups make recommendations regarding the resource concerns to be addressed, eligible practices, cost share rates, and ranking for county based EQIP funding.



# Irrigation Water Management



*(IWM) is knowing when to irrigate and how much to apply. Factors to consider in water management planning include soil, water quantity, and quality, crops, climate, available labor, and economics. These considerations are all interrelated.*



Soil provides physical support for the plant and serves as a reservoir for nutrients and water. The chosen irrigation method must suit the soil intake rate. The feel and appearance of soil vary with texture and moisture content. Soil moisture conditions can be estimated, with experience, to an accuracy of about five percent. Soil moisture is typically sampled in one-foot increments to the root depth of the crop at three or more sites per field. It is important to apply water according to crop needs in an amount that can be stored in the plant root zone of the soil.

*(Below)* Furrow diking conserves irrigation and rainfall amounts. This conservation management choice reduces runoff and helps keep the water on the field. Water is stored in the dikes and infiltrates into the soil.



*(Above)* The flowmeter, with its high accuracy, can also be used as a water management tool helping to reduce water costs, preventing over-irrigation and reducing leaching of chemicals and fertilizers into the ground.



# CHEMIGATION SAFETY VALVE



Chemigation Valves are required by the State of Texas on all irrigation systems that inject fertilizer, herbicide, pesticide, or any other chemical. A chemigation valve (which includes an in-line, automatic quick-closing check valve) is required between the point of chemical injection and the well(s) to prevent pollution of the groundwater.

Some local groundwater rules may require a chemigation valve at each well.

The Texas Administrative Code, which became effective January, 2000, has specific requirements for Chemigation Valve components. Refer to Texas Administrative Code 76.1007 for complete information.

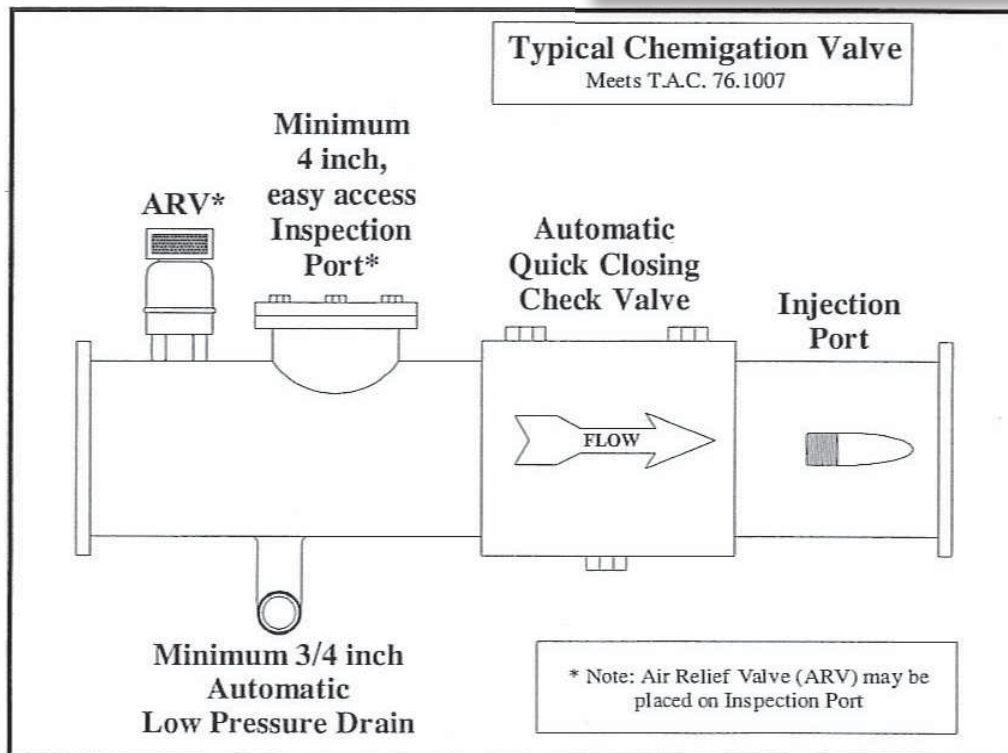



USDA Natural Resources Conservation Service

# Utilizing Center Pivot Sprinkler Irrigation Systems to Maximize Water Savings

This pamphlet was made possible through the Environmental Quality Incentives Program of the United States Department of Agriculture - NRCS and the following cooperating agencies and partners:

Wes-Tex Resource Conservation and Development Area Inc. (RC&D)

Blackwater Valley Soil and Water Conservation District  
Cochran Soil and Water Conservation District  
Dawson County Soil and Water Conservation District  
Gaines County Soil and Water Conservation District  
Lynn County Soil and Water Conservation District  
Terry County Soil and Water Conservation District

High Plains Underground Water Conservation District  
Llano Estacado Underground Water Conservation District  
Mesa Underground Water Conservation District  
Sandyland Underground Water Conservation District  
South Plains Underground Water Conservation District



**The Environmental Quality Incentives Program provides technical, educational and financial assistance to eligible farmers and ranchers to address soil, water and related natural resource concerns on their lands in an environmentally beneficial and cost effective manner. The program provides assistance to farmers and ranchers in complying with federal, state and tribal environmental laws, and encourages environmental enhancement.**

### Commerical Endorsement Disclaimer

The use of trade, firm, corporation or manufactured equipment pictured in this publication is for the information and convenience of the reader. Such use does not constitute an official endorsement of the United States Department of Agriculture or the Natural Resources Conservation Service of or service to the exclusion of others that may be suitable.



The U.S. Department of Agriculture (USDA) prohibits discrimination in all its programs and activities on the basis of race, color, national origin, sex, religion, age, disability, political beliefs, sexual orientation, or marital or family status. (Not all prohibited bases apply to all programs.) Persons with disabilities who require alternative means for communication of program information (Braille, large print, audiotape, etc.) should contact USDA's TARGET Center at (202) 720-2600 (voice and TDD).

To file a complaint of discrimination, write USDA, Director, Office of Civil Rights, Room 326-W, Whitten Building, 1400 Independence Avenue, SW, Washington, D.C. 20250-9410 or call (202) 720-5964 (voice and TDD). USDA is an equal opportunity provider and employer.



## **In this Section**

Overview: Microirrigation

Reference: Basics of Microirrigation (B-6160)

Reference: Installing a Subsurface Drip System for Row Crops (B-6151)

Reference: Maintaining Subsurface Drip Irrigation Systems (L-5406)

Reference: Subsurface Drip Irrigation (SDI) Components: Minimum Requirements (MF-2576)

Reference: Subsurface Irrigation Systems Water Quality Assessment Guidelines (MF-2575)

Reference: Irrigation System, Microirrigation (441-1)

Reference: Subsurface Drip Irrigation Information on the Internet



## Overview

### Objectives:

- Increase understanding of irrigation efficiency, losses, and distribution uniformity associated with microirrigation.
- Increase understanding and application of best management practices to improve efficiency and uniformity of microirrigation.

### Key Points:

1. Microirrigation offers potential for high water, energy and fertilizer efficiency and good distribution uniformity. These can result in good crop response (yield and/or quality) to irrigation and agronomic inputs.
2. Microirrigation, like other advanced irrigation technologies, yields best results when properly designed, installed, maintained and managed.
3. Microirrigation is well-suited to automation. While it can offer labor savings, these savings can be offset by increased management requirement.
4. Water quality is especially important in microirrigation applications. Biological, chemical and physical clogging of emitters generally can be prevented through appropriate filtration and use of chemical additives as needed.
5. Flow meters and pressure gauges can be very helpful in monitoring system performance and in troubleshooting.
6. Some potential problems encountered with microirrigation can include rodent and insect damage to tape and components; clogging of emitters and components; and problems with germination and crop establishment (especially with coarse soils in arid areas).



# *Microirrigation*

## **Assess your knowledge:**

1. List 3 advantages and 3 limitations of microirrigation. Briefly discuss each in context of applicability to your farm operation.
2. Explain why it is desirable to have multiple irrigation zones in a microirrigation system.
3. Briefly describe 3 commonly used types of filters used in microirrigation. How does each work? How does an automated backflushing filtration system work?
4. What is the primary purpose of acid injection into subsurface drip irrigation systems? How is the amount of acid necessary to accomplish this purpose determined? (How do you know how much acid to use?)
5. What is the primary purpose of chlorine injection into subsurface drip irrigation systems? How is the amount of chlorine necessary to accomplish this purpose determined? (How do you know how much chlorine to use?)
6. Describe how pressure gauges and flow meters can be used to identify potential problems in a microirrigation system.



# Microirrigation

Microirrigation, including microspray, surface drip and subsurface drip irrigation methods, can deliver water precisely and efficiently. Microirrigation is commonly used for irrigation of high value horticultural crops, orchards and vineyards. Subsurface drip irrigation (SDI) is gaining popularity in production of agronomic “row” crops, especially in areas of limited well capacities and where small or irregularly shaped fields give SDI a competitive advantage over other irrigation technologies and methods.

## Key Components

Microirrigation systems typically work at relatively low pressures. A **pump** should be correctly sized to deliver required flow and pressure, taking into account system operating pressure, lift(s), friction and dynamic pressure losses, etc.

**Filters** are key to protecting the irrigation system from plugging by suspended solids in the water.

Depending on the type of filtration system, a **pressure sustaining valve** may be needed to facilitate flushing of the filters.

**Pressure gauges** should be used at the inlet and outlet points of the filters to show pressure differential for initiating flushing of the filters.

A **backflow preventer** prevents backflow of fertilizers, chemicals, or particulates into the water supply and are installed between the water supply or pump and the chemical injection line.

A **regulation valve** helps to maintain proper operating pressure in the irrigation lines.

A **chemical injector** precisely injects chlorine, acid, fertilizers or pesticides into the irrigation stream.

A **flow meter** measures the volume of water moving through the system, either as a flow rate or as an accumulated total volume basis.

**Chemigation line check valve** is installed between the injector and the water source. It prevents backflow of water into the chemical supply tank in case of injector failure. This valve is often an integral part of an injector unit and can handle both backpressure and backsiphonage.

**Zone valves** are opened or closed to control the flow to appropriate zones. They may be manual or automatically controlled using an electronic control system.

**Pressure regulators** are typically located on the manifold to help regulate operating pressure for emitters.

**Air and vacuum relief valves** prevent soil or particulate material from being sucked back into emitters when the irrigation system is turned off or when driplines are drained.

**Main line, sub-main lines** supply water from the system head to the **manifolds** which subsequently distribute the water to the **driplines**. The dripline is the polyethylene tubing that includes a built-in **emitter**. Emitter spacing and rate are selected to match crop demands and soil water-holding capacity.



# Microirrigation

**Flush lines** at the tail end of the system serve three purposes:

- 1) Allow any sediment and contaminants to be flushed from dripline laterals at a centralized location,
- 2) Equalization of pressure in the dripline laterals, and
- 3) Allow positive pressure on both sides of a dripline break to prevent soil ingestion into the dripline.

**Connectors** are needed to attach the dripline to the manifold or submain. The number and type depend on system layout. There are many types of connectors. Connector options include glued, grommet, barb, and compression.

Electronic **controllers** allow for automation of irrigation applications to irrigate selected zones based upon set times, volumes, etc.

## Maintenance Considerations

A properly designed and maintained microirrigation system should last more than 20 years. A maintenance program includes cleaning the filters, flushing the lines, adding chlorine, and injecting acids. If these preventive measures are done, the need for major repairs, such as replacing damaged parts, often can be avoided, and the life of the system extended.

One goal of preventive maintenance is to keep the emitters from plugging. Emitters can be plugged by suspended solids, magnesium and calcium precipitation, manganese-iron oxides and sulfides, algae, bacteria, and plant roots. Every system should contain a flow meter and pressure gauges—one gauge before the filters and another after the filters. Daily monitoring of these gauges will indicate whether the system is working properly. A low pressure reading on a pressure gauge can mean that a part is leaking or a pipe is broken. A difference in pressure between the filters may mean the system is not being backflushed properly and that the filters need to be cleaned. Gradual increasing pressure with reduced flow can indicate an emitter clogging problem.

**Maintaining filters.** The filter is important to the system's success. Water must be filtered to remove suspended solids. There are three main types of filters: cyclonic filters (centrifugal separators); screen and disk filters; and media filters. It is common practice to install a combination of filters to deal with various particulate sizes effectively.

**Flushing lines and manifolds.** Very fine particles pass through the filters and can clog the emitters. As long as the water velocity is high and the water is turbulent, these particles remain suspended. If the water velocity slows or the water becomes less turbulent, these particles may settle out. This commonly occurs at the distant ends of the lateral lines. If they are not flushed, the emitters will plug and the line eventually will be filled with sediment from the downstream end to the upstream end. Systems must be designed so that mainlines, sub-mains, manifolds and laterals can all be flushed. Mainlines, sub-mains and manifolds are flushed with a valve installed at the very end of each. Lateral lines can be flushed manually or automatically. It is important to flush the lines at least every 2 weeks during the growing season, or as needed based upon local conditions.

**Injecting chlorine.** At a low concentration (1 to 5 ppm), chlorine kills bacteria and oxidizes iron. At a high concentration (100 to 1000 ppm), it oxidizes organic matter and effectively removes it from the system.



# *Microirrigation*

**Injecting acid.** Acids are injected into irrigation water to prevent or treat plugging caused by precipitation of calcium carbonate (lime), magnesium and some other salts. Water with a pH of 7.5 or higher and a bicarbonate level of more than 100 pm is likely to have problems with lime precipitation, depending on the hardness of the water. Maintaining a low pH (6.5 or less) can generally prevent chemical precipitation and subsequent plugging of emitters; alternately periodic shock acid injection (temporarily lowering the pH below 4) can prevent build-up of precipitates.

## **Advantages and Limitations of Microirrigation**

### **Advantages of microirrigation (properly designed, installed, maintained and managed):**

1. High efficiency and uniformity of water application.
2. Precise application of fertigation and chemigation.
3. Reduced labor requirement compared to other irrigation technologies.
4. Water use efficiency (water conservation and/or crop yield/quality response to water).
5. Applicable to operations with large or small water capacities and over a range of field sizes, topographic and soil conditions.
6. Reduced problems with annual weeds.
7. Well suited to automation.

### **Limitations of microirrigation (depending upon local conditions):**

1. High initial cost.
2. Maintenance and operation require higher level of skilled management than other irrigation systems.
3. Potential problems with emitter clogging, root intrusion, rodent and insect damage.
4. Potential problems with germination of a crop.
5. Limited root zone.
6. Limited options for deep tillage and deep injection of chemicals that may be needed for pest and disease management.





## Basics of Microirrigation (B-6160)

# Basics of Microirrigation



Point source emitters, Line source emitters, Classification of microirrigation emitters, Drip emitters, Pressure compensated emitter, Micro-sprinkler bubbler, Vortex, spaghetti, Soaking hose, Single walled, Emitter inserted in line, Twin wall drip tubing, Wetting pattern, Pig tail, Emitter on the line, Double line with emitters, Micro-sprinklers, Sand separator filter, Screen filter, Sand media filter, Injection pump, Atmospheric Vacuum breaker, Check valve Point source emitters, Line source emitters, Classification of microirrigation emitters, Drip emitters, Pressure compensated emitter, Micro-sprinkler bubbler, Vortex, spaghetti, Soaking hose, Single

# Basics of Microirrigation

**Juan Enciso  
And  
Dana Porter**

**Assistant Professors and Extension Agricultural  
Engineering Specialists,  
Texas A&M University, Weslaco and Lubbock**

Point source emitters, Line source emitters, Classification of microirrigation emitters, Drip emitters, Pressure compensated emitter, Micro-sprinkler bubbler, Vortex, spaghetti, Soaking hose, Single walled, Emitter inserted in line, Twin wall drip tubing, Wetting pattern, Pig tail, Emitter on the line, Double line with emitters, Micro-sprinklers, Sand separator filter, Screen filter, Sand media filter, Injection pump, Atmospheric Vacuum breaker, Check valve Point source emitters, Line source emitters, Classification of microirrigation emitters, Drip emitters, Pressure compensated emitter, Micro-sprinkler bubbler, Vortex, spaghetti, Soaking hose, Single

**m**icroirrigation involves frequent application of small quantities of water as drops (drip irrigation), tiny streams (micro-sprinklers) or a miniature spray (micro-sprayers), using applicators placed along a water delivery line. The outlet device that applies water to the soil is called an emitter. Emitters dissipate the pressure of the pipe distribution network through a small orifice or by a long, narrow flow path, applying water in small quantities at low pressure. Emitters partially wet the soil, moving water horizontally and vertically.

## Advantages and Disadvantages of Microirrigation

### The main advantages of microirrigation are:

1. **Uniformity.** When properly designed and installed, microirrigation systems can obtain uniformities higher than 90 percent.
2. **Fertilization control and chemigation.** Because of their high uniformity, microirrigation systems can apply fertilizers and chemicals along with water, frequently in small quantities, increasing application efficiencies and minimizing chemical losses through deep percolation or drifting.
3. **Labor savings.** Microirrigation systems require less labor than do surface irrigation systems, although such systems do not necessarily reduce management requirements.
4. **Water savings.** By minimizing water losses through deep percolation and runoff, microirrigation systems conserve water when irrigating crops with shallower root systems such as vegetable crops or crops planted in sandy soils that hold little water. Also, some crops respond better to frequent, light water applications, resulting in higher yields and/or improved product quality.
5. **Deficit irrigation.** When water is limited and water available per unit area is low due to low capacities of canal systems or irrigation wells, microirrigation systems can spread small amounts of water over a bigger area.

### The main disadvantages of microirrigation are:

1. **High initial cost.** These systems cost more to install than do surface and sprinkler systems.
2. **Maintenance and operation.** Microirrigation systems require increased maintenance, with periodic injections of sulfuric acid and chlorine or other chemicals to avoid plugging of emitters.
3. **Higher skills.** Proper, safe use of injection chemicals needed for system maintenance and fertigation requires knowledge of chemical reactions between water and injected chemicals to avoid precipitation and plugging the tape. Microirrigation also requires knowledge about calculating irrigation times and injection rates.

# Emitter Classification

Emitters are classified mainly as point source emitters or line source emitters, according to their position in their supplying laterals.

## Point source emitters

Point source emitters are best suited to irrigate trees, bushes and other similarly managed plants. Single emitters can be inserted directly in a lateral or can be connected at the end of a micro-tube (spaghetti). The main types of point-source emitters are single drip emitters, bubblers, micro sprinklers and spray emitters.

### Drip emitters

In drip irrigation (sometimes referred to as trickle irrigation), drip emitters each applying less than 2 gallons per hour are inserted into plastic pipe or hose. Many possible configurations of drip emitters are used to decrease pressure and distribute water from pipes to the soil. Those configuration use small holes, long passageways, vortex chambers or discs. Pressure-compensated emitters deliver constant flow rates even when pressure supplied to the emitter varies.

### Bubblers

The orifices on bubble emitters are larger than those on drip emitters and produce small water streams rather than sprays. Water is applied to the soil surface and moves down into root zones. Bubblers can control water delivery patterns to avoid spraying streets, fences, brick walls or windows. Such emitters are ideal for shrub plantings, trees, containers and flower beds and can apply up to 35 gallons per hour. Emitter plugging also occurs less often with bubbler emitters than with smaller-orifice drip emitters.

### Micro-sprinklers

Micro-sprinklers consist of an orifice with a deflector; water comes out of the micro-sprinkler orifice and crashes into the deflector to spray the soil. These sprinklers may or may not spin. Wetting patterns depend on micro-sprinkler/deflector type. Some micro-sprinklers have fixed, removable parts. Those with movable parts consist of deflectors that move as they are hit by water exiting the orifice. Micro-sprinklers generally are connected to a micro-tube, often referred to as “spaghetti tubing.”

Micro-sprinklers are used in orchards, greenhouses and flower beds. They can apply from 3 to 138 gallons of water per hour; the higher the flow rate and pressure, the longer the wetted diameter. However, small flow rates are preferred in large orchards with large-diameter laterals.

### Micro-sprayers

Micro-spray irrigation sprays water over mass plantings, ground cover, annual flower beds and containers. It lowers soil temperature for rooting and plant propagation and even provides limited frost protection. The micro-sprayer produces tiny droplets and has a relatively small wetting diameter. Its spray or mist is produced by a flat spreader and a small orifice operating at pressures between 30 and 43 pounds per square inch (psi).

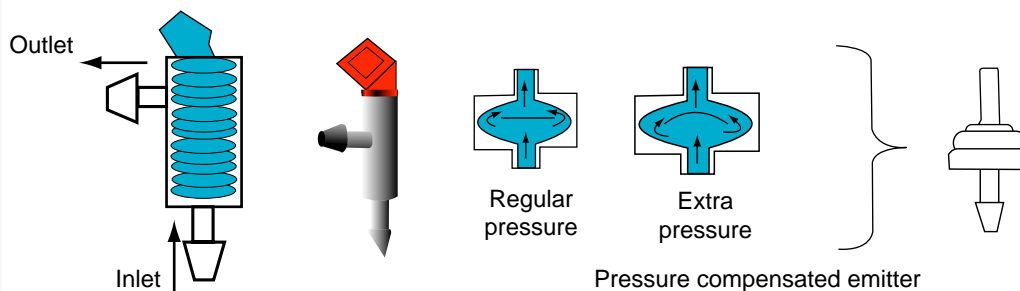

Drip emitters (long path spiral grooved)

Fig. 1a. Classification of microirrigation emitters.

Point source emitters, Line source emitters, Classification of microirrigation emitters, Drip emitters, Pressure compensated emitter, Micro-sprinkler bubbler, Vortex, spaghetti, Soaking hose, Single walled, Emitter inserted in line, Twin wall drip tubing, Wetting pattern, Pig tail, Emitter on the line, Double line with emitters, Micro-sprinklers, Sand separator filter, Screen filter, Sand media filter, Injection pump, Atmospheric vacuum breaker, Check valve Point source emitters, Line source emitters, Classification of microirrigation emitters, Drip emitters, Pressure compensated emitter, Micro-sprinkler bubbler, Vortex, spaghetti, Soaking hose, Single

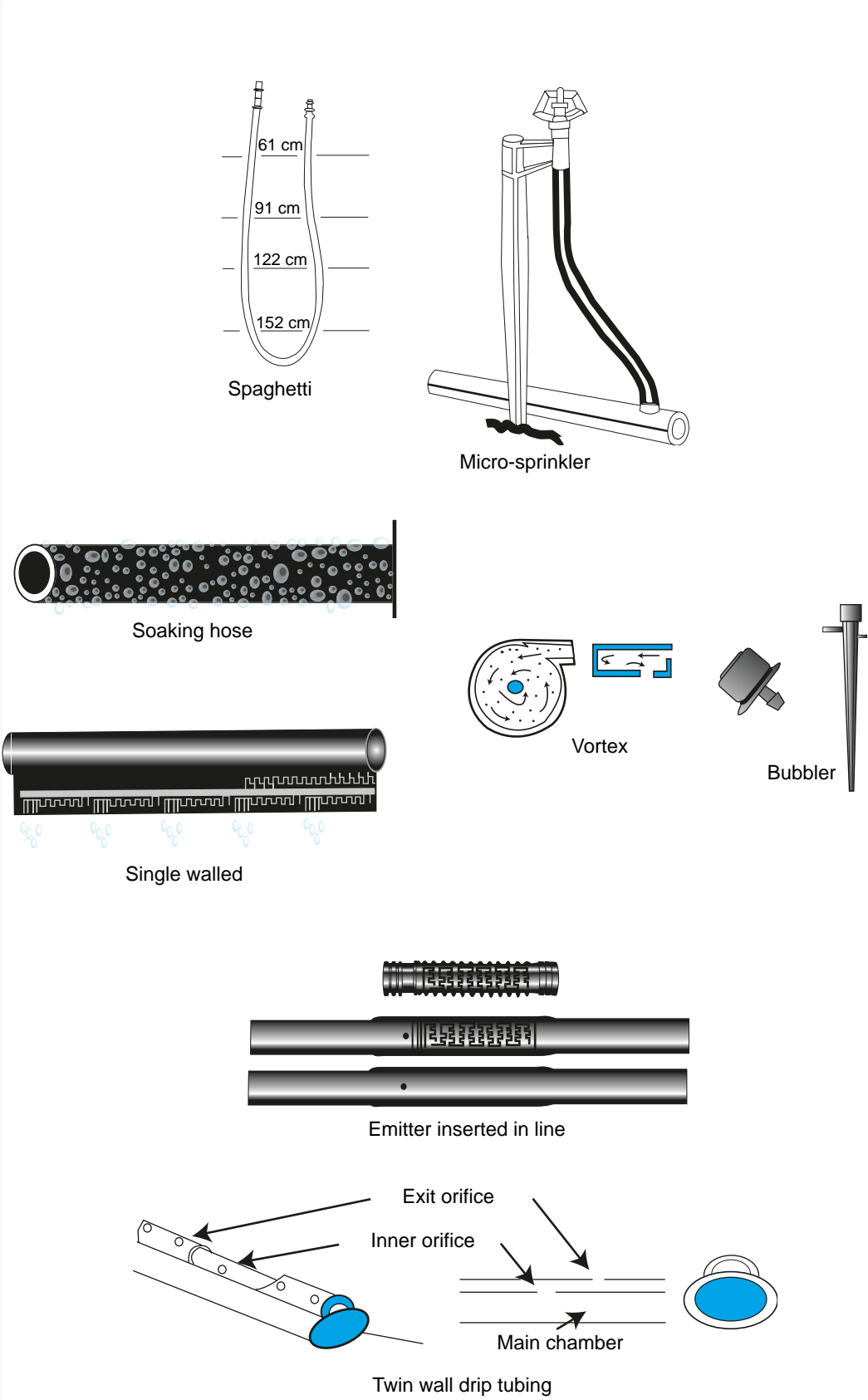

Point source emitters, Line source emitters, Classification of microirrigation emitters, Drip emitters, Pressure compensated emitter, Micro-sprinkler bubbler, Vortex, spaghetti, Soaking hose, Single walled, Emitter inserted in line, Twin wall drip tubing, Wetting pattern, Pig tail, Emitter on the line, Double line with emitters, Micro-sprinklers, Sand separator filter, Screen filter, Sand media filter, Injection pump, Atmospheric vacuum breaker, Check valve Point source emitters, Line source emitters, Classification of microirrigation emitters, Drip emitters, Pressure compensated emitter, Micro-sprinkler bubbler, Vortex, spaghetti, Soaking hose, Single

Fig. 1b. Classification of microirrigation emitters.

## Line source emitters

Line source emitters consist of drip tubing with supply orifices to meter water before it enters the line; then, the water passes through a labyrinth of flow paths to dissipate or compensate pressure and exits to one or more distribution orifices. Line source emitters use three main tubing configurations:

### Soaker hose

Soaker hoses use porous tubing to leak water continuously along the tube length rather than through discrete emitters.

### Single walled tubing

This kind of tubing, generally less than one inch in diameter, has built-in, inserted or attached emitters.

### Double walled or twin wall tubing

These drip lines have two walls forming parallel flow paths; one path delivers water along the length of the tubing, and one contains outlets to deliver water to the soil at set intervals (Fig. 1).

## Soil Wetting Patterns

Drip irrigation wets just part of plants' total root-zone area. The percentage of an area wetted is determined by soil properties, spacing of emitters, spacing of tape laterals and managing irrigation rates and timing. The minimum recommended wetted area is 33 percent for agricultural row crops and 75 percent for landscaping. Thorough partial root-zone wetting with drip irrigation favors aeration of roots, which may increase crop productivity and/or improve health of landscape plants.

Water applied to the soil produces a wetting pattern as it moves downward due to gravity and horizontally due to differential soil moisture and capillary suction (Fig. 2). Wetting-pattern configurations depend on soil type and tillage practices. For example, clay soils have fine particles that exert capillary forces greater than gravity, resulting in horizontal wetting patterns. Sandy soils, on the other hand, have coarser particles that produce faster downward movement of water. Their bigger particles produce bigger voids, making it difficult for water to move horizontally. Most soils comprise a combination of clay, loam and sand particles. The shape of the wetting front is more proportional in medium-textured soils than in other soil types (Fig. 2). Wetting-pattern size will be affected by irrigation dripper-flow rate and application time. Increased application time gives more opportunity for horizontal movement of water, especially in clay soils. Take into account soil characteristics when determining application times, numbers of emitters per plant and emitter flow rates.

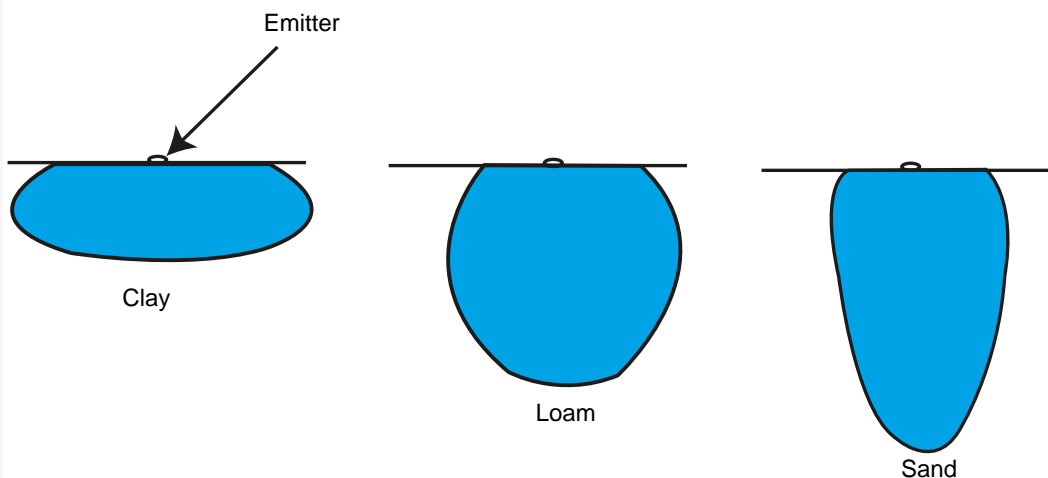

Fig. 2. Wetting pattern shapes for the clay, loam and sand soil textures.

## Emitter Placement in Relation to Plants

Emitter placement and configuration affects water efficiency, plant germination and establishment, nutrient utilization efficiency and soil salinity. Emitter type and placement also affect wetted zone size and horizontal and downward movement of water. When you want a larger wetted area, place more point source emitters per plant (Fig. 3). More emitters can be installed (1) by supplying them from the lateral using several spaghetti tubes or (2) by using a “pigtail configuration” to feed several emitters from a line stemming from a lateral surrounding the plants. Another option is to install two laterals instead of one, distributing several emitters along each.

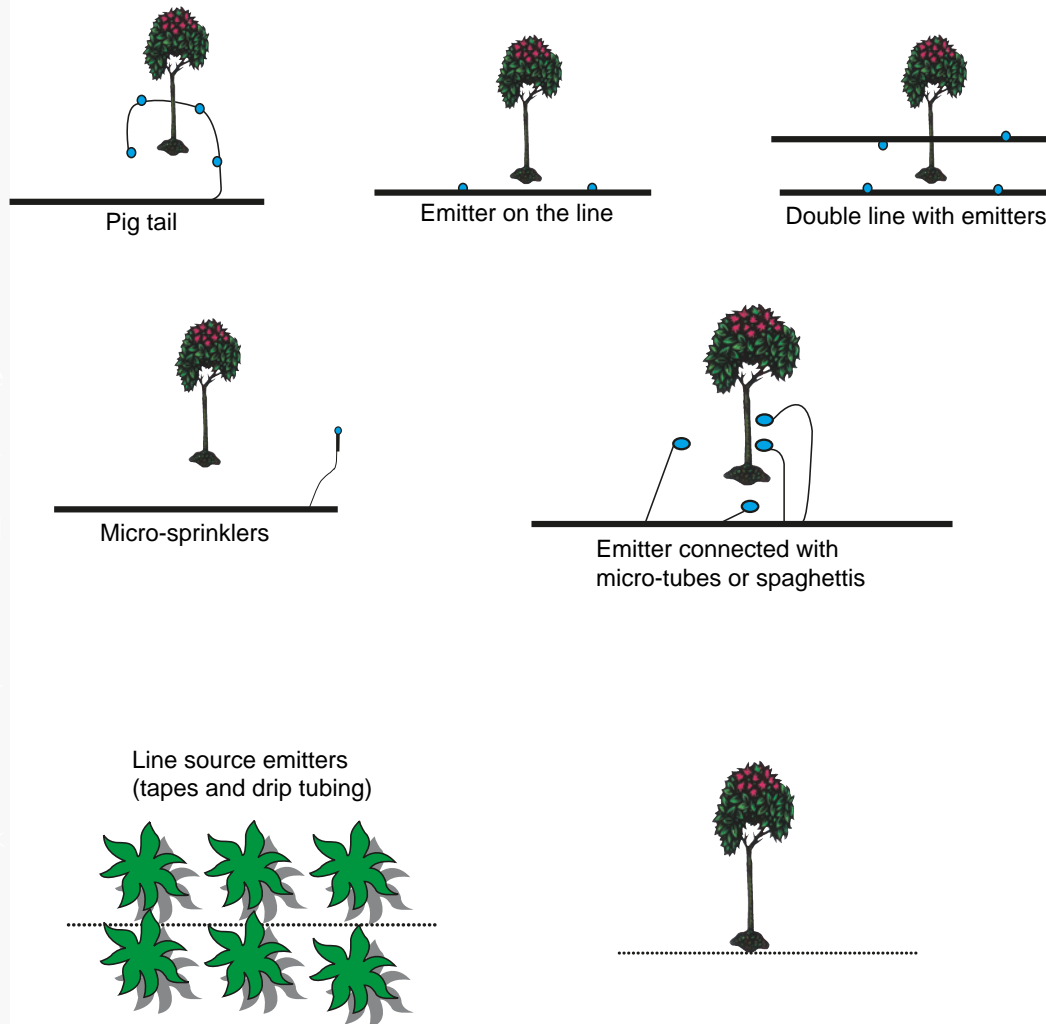

Fig. 3. Installation configurations of point source and line source emitters.

Microsprinklers and bubblers generally are installed one per plant; wetted diameter than can be controlled with pressure and orifice size. For row crops, one lateral can be placed under each row or can be used to irrigate two plant rows (Fig. 4). Configuration depends on factors such as economics, crop tolerance to salinity and soil texture. Spacing between emitters along a lateral depends on the crop. For example, with onions, spacing should be close (less than 8 inches), but with cotton, it can be every 12 inches or more.



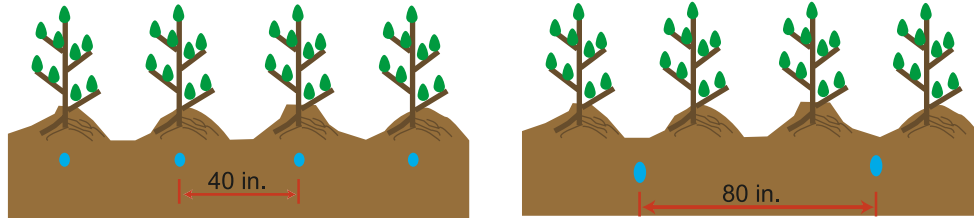

Fig. 4. Typical lateral placement a) under every row; under alternate furrows. This illustration shows tape placement options for a row crop using 40 inch tow spacing.

Wetting patterns can be determined experimentally or by field trials, which can reveal effects of soil layers, compaction and soil variability. Different drip tapes can be tested with water flowing out of an elevated 50 gallon drum. Such trials allow better designs, and it can be especially helpful to consult irrigation professionals and producers experienced with microirrigation in a given area or for a particular crop.

## Components of Microirrigation Systems

Besides emitters, most microirrigation systems include a filter, chemigation units, a mainline, laterals and accessories such as pressure regulators, connections and vacuum and pressure relief valves.

### Filters

- Filters remove impurities that can cause clogging; they are located after the system pump, with multiple filters placed in parallel (side by side, discharging filtered water into the same line). The number of filters needed depends on flow rate and water quality, including suspended particle size:

Particle Size Classification			
Material	Size (microns)	Size (in)	Mesh equivalent
Very coarse sand	1000-2000	0.04-0.08	15-7.5
Coarse sand	500-1000	0.02-0.04	30-15
Medium sand	250-500	0.01-0.02	60-30
Fine sand	100-250	0.004-0.01	150-60
Very fine sand	50-100	0.002-0.004	300-150
Silt	2-50	0.00008-0.002	7500-300
Clay	<2	0.00008	7500

Filter screen openings should be one-fourth the size of emitter openings. Filtration capacity is expressed in “mesh” (mesh numbers correspond to openings per inch, e.g., 200 mesh has 200 openings per inch). Most microirrigation applications require mesh sizes between 100 and 200. The main types of filters are:

- Sand Separator (centrifugal or hydrocyclone) filters** are ideal for removing suspended sand particles (often encountered in pumping from deep wells). Centrifugal separators will remove particles down to 75 microns (200 mesh). These filters spin the water, using centrifugal force to remove high density particles (Fig. 5). Pressures for water passing through the filters decrease by about 8 to 12 psi.

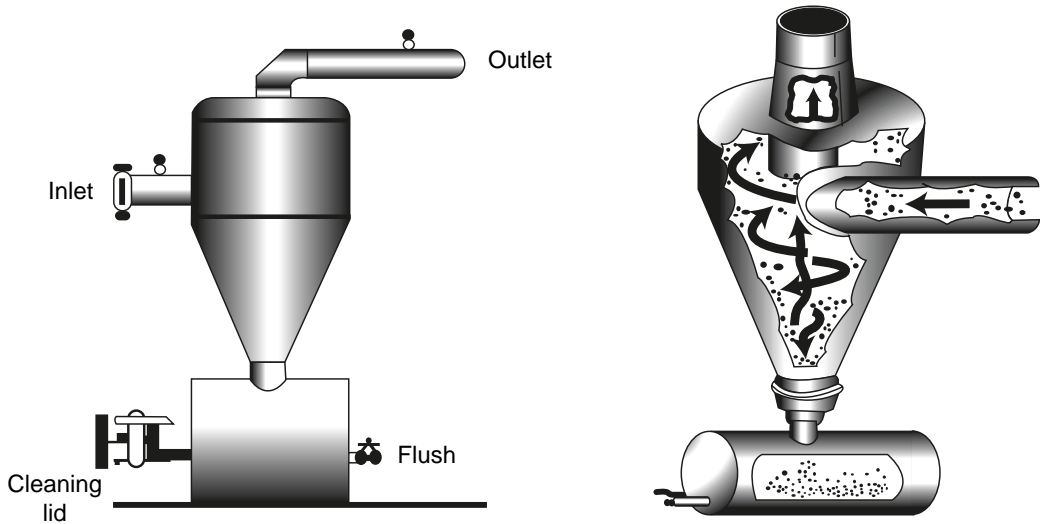

Fig. 5. Sand separator (centrifugal) filter.

- **Screen-mesh filters** (Fig. 6) come in different shapes and sizes, ranging from 20 to 200 mesh. Their mesh can be made of stainless steel, polyester or plastic and can remove very fine sand particles or very small algae. They serve as backup filters to catch particles that get through other filters.

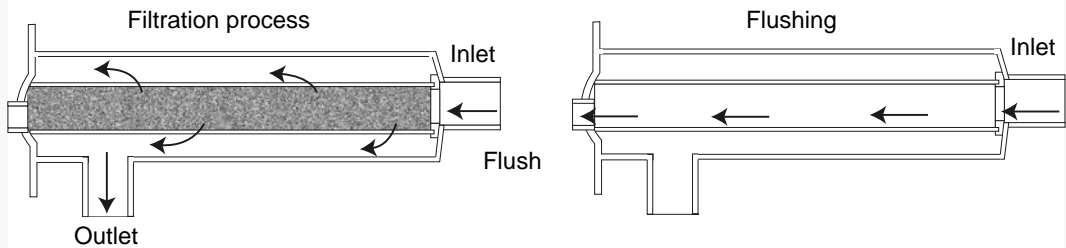

Fig. 6. Screen filter.

- **Sand media filters** contain a vertical cylinder with graded sand inside (Fig. 7). This cylinder efficiently separates organic material (algae, leaves, etc.) and fine sediment, so it often is used to filter water from surface sources such as lakes, rivers or canals. Multiple cylinders can be back-flushed either manually or automatically.

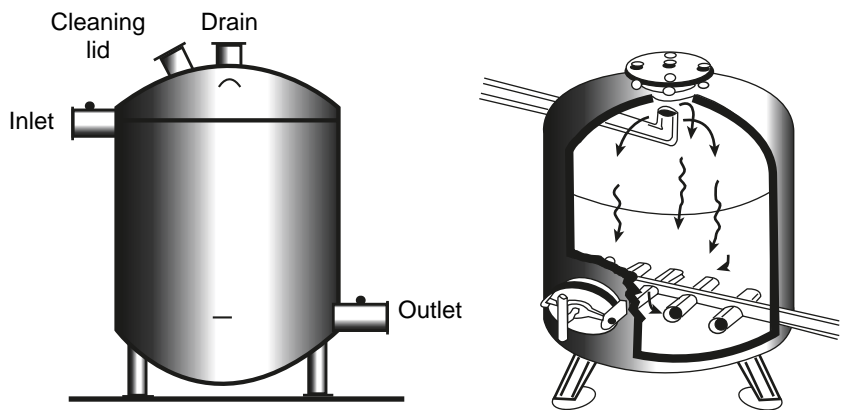

Fig. 7. Sand media filter.

Depending upon water source and quality, more than one type of filter may be needed for a given irrigation system, with typical combinations as follows:

1. If the water source is a deep well, a filter station may consist of a sand separator followed by a screen, disk or media filter.
2. If the water source is a canal, a filter station may consist of a sand media filter combined with a screen filter or a disk filter with screen filter (Fig. 8).

## Chemigation Unit

Microirrigation's high distribution uniformity gives it great potential for uniformly and efficiently applying agricultural chemicals, a process called chemigation. The main components of a chemigation unit are a chemical solution tank, an injection system and chemigation safety devices. [YOU LIST THE CHEMICAL SOLUTION TANK BUT DO NOT DISCUSS IT.]

### Chemical Solution Tanks

Chemical solution tanks generally are constructed of poly or fiberglass. A conical form at the tank bottom facilitates flushing it completely so that no material is wasted. Tanks should have an easy-clean screen downstream of the valve to make them easier to clean.

### Injection system

The main types of chemical injectors are the venturi injector, injection pump, and the differential tank (Fig. 9). Criteria for selecting the proper injection system include cost, ease of use/repair, durability and susceptibility to corrosion.

With *venturi injectors*, water is extracted from the main line, then (1) pressure is added with a centrifugal pump (Fig. 9) or (2) a pressure differential is created by a valve in the mainline forcing water through the injector at high velocity. The high-velocity water passing through the throat of the venturi creates a vacuum or negative pressure, generating suction to draw chemicals into the injector from the chemical tank. Although the venturi is cheaper than a positive displacement pump, its injection rate is more difficult to control.

With *injection pumps*, water is pumped into the system using pistons, diaphragms or gears. An injection pump has a small motor powered either by electricity or by energy from the water itself. The motor moves small pumps (diaphragms) or pistons to inject fertilizer into the system. The advantage of injection pumps is that chemicals can be injected with high uniformity at rates easily adjusted regardless of discharge pressure.

With *differential tanks*, water is forced through a tank containing the chemical to be injected. As water passes into the tank, fertilizer is injected into the irrigation system.

One disadvantage of such a system is that the concentration of the chemical in the tank decreases over time.

### Chemigation safety devices

Backflow can occur in a system due to cross connection between a water source and an irrigation system. For example, water may be turned off, but the chemical injection unit may continue to work, contaminating the water source. To protect groundwater and drinking water supplies from chemical contamination, backflow – whether from *backsiphonage* or *backpressure* – must be prevented. The main chemigation safety devices used to prevent backflow are shown in Figure 10.

*Backsiphonage* is the reversal of normal system flow, caused by negative pressure (vacuum or partial vacuum) in the supplying pipe. Backsiphonage occurs due to low pressure in the water source. For example, the mainline source pipe may break at a spot lower than the irrigation system or pressure may be reduced drastically because a supply pump fails. Such situations can be avoided by installing check valves, vacuum relief valves or vacuum breaker valves.

*Backpressure* is the reversal of normal system flow due to downstream pressure increasing above supply pressure. Backpressure may occur if a system operates at higher pressures than its water supply, perhaps due to use of booster pumps or interconnection of a water source to other water systems. Such situations can be avoided by installing double check valves or special valves that combine check valves with reduced pressure zones inside them (commonly known as reduced pressure principle backflow prevention valves).

Point source emitters, Line source emitters, Classification of microirrigation emitters, Drip emitters, Pressure compensated emitter, Micro-sprinkler bubbler, Vortex, spaghetti, Soaking hose, Single walled, Emitter inserted in line, Twin wall drip tubing, Wetting pattern, Pig tail, Emitter on the line, Double line with emitters, Micro-sprinklers, Sand separator filter, Screen filter, Sand media filter, Injection pump, Atmospheric vacuum breaker, Check valve, Point source emitters, Line source emitters, Classification of microirrigation emitters, Drip emitters, Pressure compensated emitter, Micro-sprinkler bubbler, Vortex, spaghetti, Soaking hose, Single

Point source emitters, Line source emitters, Classification of microirrigation emitters, Drip emitters, Pressure compensated emitter, Micro-sprinkler bubbler, Vortex, spaghetti, Soaking hose, Single walled, Emitter inserted in line, Twin wall drip tubing, Wetting pattern, Pig tail, Emitter on the line, Double line with emitters, Micro-sprinklers, Sand separator filter, Screen filter, Sand media filter, Injection pump, Atmospheric vacuum breaker, Check valve, Point source emitters, Line source emitters, Classification of microirrigation emitters, Drip emitters, Pressure compensated emitter, Micro-sprinkler bubbler, Vortex, spaghetti, Soaking hose, Single

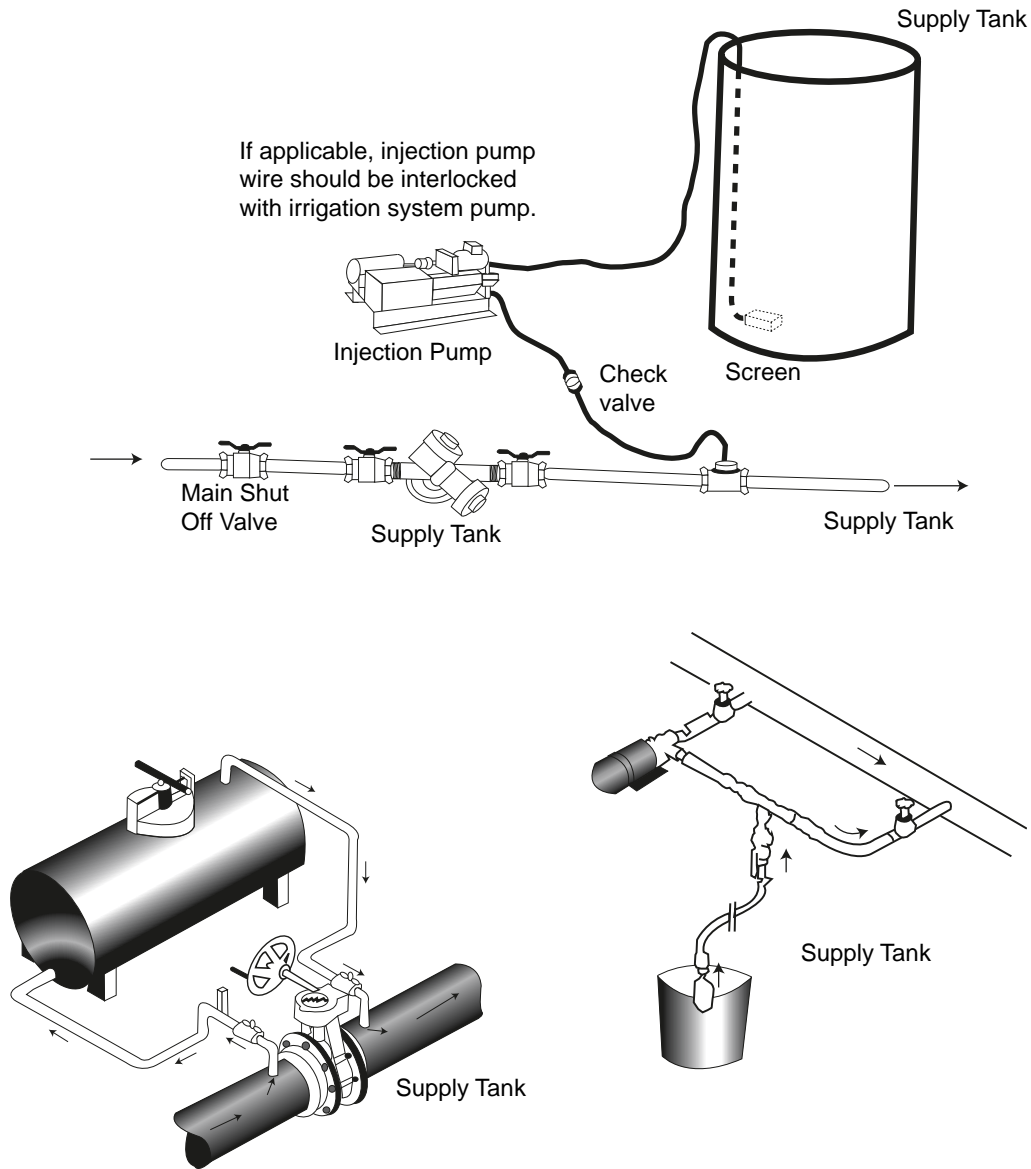

Fig. 9. Fertilizer injectors.

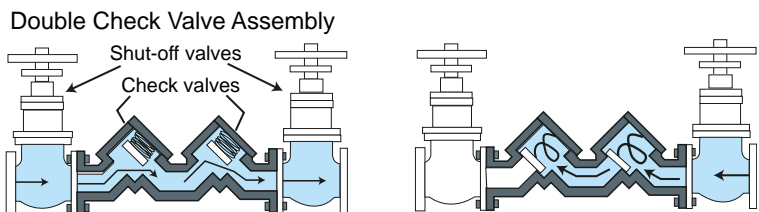
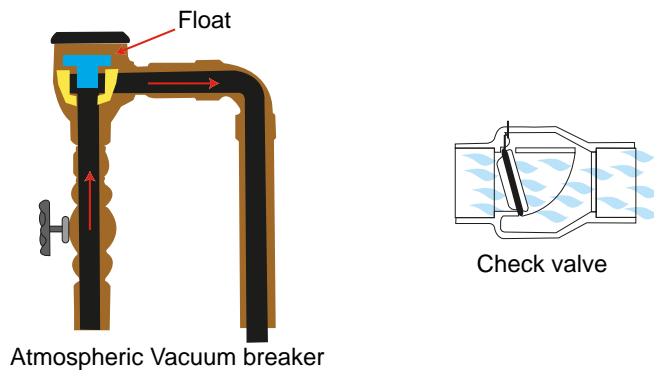

Fig. 10. Chemigation safety devices.

## Laterals

Laterals are the flexible polyethylene tubing used to carry water to areas to be irrigated. They deliver water to plants through spaced orifices or emitters. Layout of laterals is designed according to the dimensions and the topography of the fields to be irrigated. The diameter of a lateral is determined according to hydraulic principles of pipe flow.

## Vacuum and Pressure Relief Valves

Air sometimes enters irrigation pipes, accumulating and becoming trapped in the pipelines' highest points. This trapped air can reduce water flow and increase compression, eventually destroying pipes. Valves help to release the air during pipe filling and draining. An air valve consists of a small orifice with a ball inside. When air is released, the ball lets the air escape but retains the water. Pressure relief valves have an inside spring; when pressure inside the pipe exceeds the pressure of this spring, the valve opens, protecting the pipe from blowing. Pressure pipes are selected according to their resistance.

## Pressure regulators

For areas with irregular topography, particularly in irrigation systems without pressure-compensating emitters, pressure regulators must be used to produce uniform application of water. Pressure regulators dissipate excess pressure or reduce it to normal operating pressure of the emitters. Such regulators use one or more springs to decrease flow diameter and so reduce pressure. Generally, one pressure regulator is used to control pressure in two lines (Fig. 10).

## Summary

Microirrigation systems can help create beautiful landscapes and improve yields and quality of agricultural crops, orchards and vineyards. This publication should have increased your knowledge and understanding about microirrigation systems' advantages and disadvantages and about their components and configuration, as well as about the importance of placing them correctly in relation to soil and plant types for increased irrigation efficiency.

# Point source emitters, Line source



The information given herein is for educational purposes only. Reference to commercial products or trade names is made with the understanding that no discrimination is intended and no endorsement by Texas Cooperative Extension is implied.

Produced by Agricultural Communications, The Texas A&M University System  
Extension publications can be found on the Web at: <http://tcebookstore.org>

Visit Texas Cooperative Extension at <http://texasextension.tamu.edu>

Educational programs conducted by Texas Cooperative Extension serve people of all ages regardless of socioeconomic level, race, color, sex, religion, handicap or national origin.

Issued in furtherance of Cooperative Extension Work in Agriculture and Home Economics, Acts of Congress of May 8, 1914, as amended, and June 30, 1914, in cooperation with the United States Department of Agriculture. Edward G. Smith, Interim Director, Texas Cooperative Extension, The Texas A&M University System.

1,000 copies, New



# Installing a Subsurface Drip System for Row Crops (B-6151)

# Installing a Subsurface Drip Irrigation System for Row Crops

Juan Enciso\*

The success of a subsurface drip irrigation (SDI) system for row crops depends on its design, installation, operation, management and maintenance. All phases are equally important. This publication describes the components and installation of an SDI system. Steps in the installation process are:

- tape injection;
- trenching;
- installing the mainlines, manifolds (sub-mains) and flush lines;
- connecting the tape with the manifolds and flush lines;
- back filling; and
- installing filtration equipment.

## Components of the irrigation system

The main components of an irrigation system are the filters, mainlines, manifolds (submains), field blocks, flush lines, drip lines (laterals) and accessories (Fig. 1).

All the drip lines (laterals) connected to the same submain make up a field block. Several field blocks can be grouped together as one station and operated simultaneously. Water is supplied to drip lines in the field blocks by the manifold (submain). In some permanent systems, the drip lines are also connected to a flush line so that accumulated sediments can be flushed from the drip lines using a

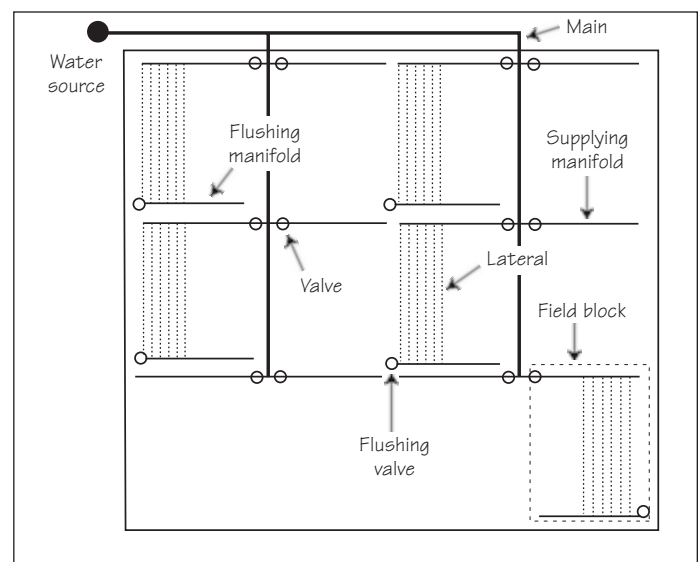
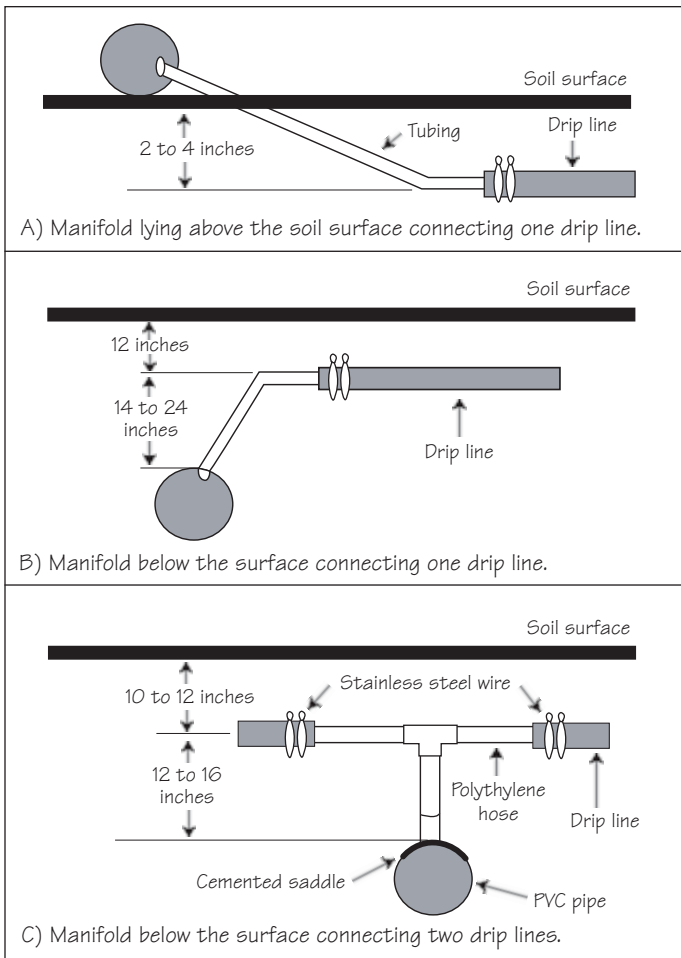

Figure 1. Typical layout of a drip irrigation system.

single valve. The flush line is also called a collector line. In some field blocks, particularly those with longer lateral lengths (more than 200 m), the flush line may also be connected to the mainline by a separate valve and manifold, so that water can be supplied to both ends of the drip line. This prevents excessive pressure loss in longer drip lines. The flush line should always contain a flush-out valve, even if it is also used as a supply line. Seasonal systems do not use flush lines; their tapes last only a season or two before needing to be replaced. The drip lines may be connected to the manifold in several ways as shown in Figure 2. The manifold can be placed at the soil surface or buried.

\*Assistant Professor and Extension Agricultural Engineer,  
 The Texas A&M University System.





**Figure 2.** Typical connections from manifold to drip lines or laterals. In this case the manifold is connected to the drip line with a stainless steel wire (there are many ways to connect it).

## Tape injection

The injector consists of a roll that holds the tape and a shank that opens the soil to bury the tape (Figs. 3 and 4). As the shank opens the soil, the tape is guided into the soil, usually through a curved pipe mounted behind the shank. The shank must be durable enough to resist the impact of rocks and other obstructions in the soil. The pipe that is mounted behind the shank should be smooth and curved so it does not tear the tape. Drip line injection is shown in Figures 4 and 5.

The steps for injecting the tape are:

1. Mark the locations where the manifold and flush lines will be installed, using flags or lines of gypsum on the field.
2. If the tape will be more than 8 inches deep or the soil is rocky, pre-rip the rows using the shank alone without the tape. Pre-ripping makes depth and spacing more uniform and helps to clear away rocks that could damage the tape. Pre-ripping is not necessary on easily plowed fields.



**Figure 3.** Toolbars with drip tape injector.

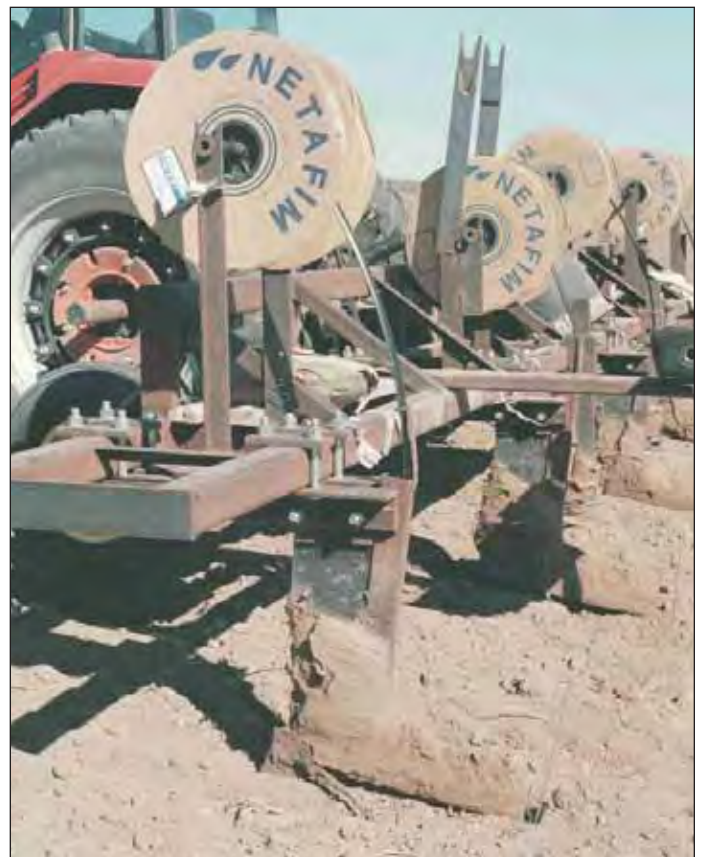

**Figure 4.** Installing the drip tape.



Figure 5. Changing a roll of drip tape in the middle of the field.

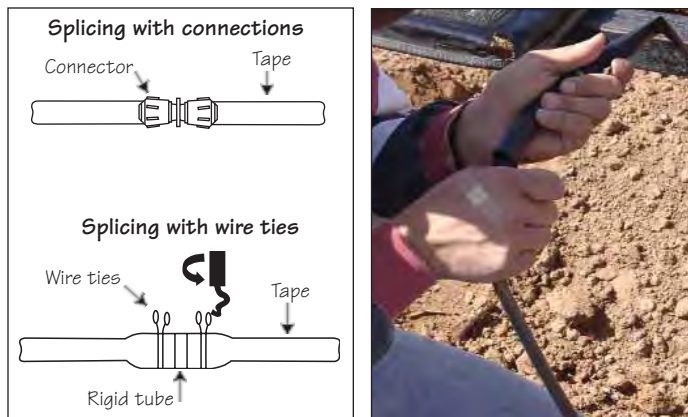

Figure 6. Drip line splicing.

3. Be extremely careful not to cut the tape when unwrapping the plastic that covers the roll. (Sometimes the unwrapping is done with a knife.) Careless or rough handling of the tape may lead to major leaks after installation.
4. Lay the tape down with the emitters facing upward to avoid soil plugging. The rolls have indicators showing the direction of the emitters.
5. Just before lowering the shank, anchor the tape temporarily by hand or with a stake so it can be pulled into the soil. Stakes can be made of welding rods or rigid wire (Fig. 4).
6. The depth of the tape will depend on the crop. Tape has been installed 12 to 14 inches deep for permanent SDI systems in crops such as cotton and alfalfa in the St. Lawrence, Trans-Pecos and Lubbock areas.

In the Lower Rio Grande Valley, tape has been installed 2 to 6 inches deep for vegetable crops such as onions and melons. Check to see that the tape is at the correct depth and adjust the control roller if necessary.

7. If the drip tape runs out in the middle of the field it must be spliced (Figs. 5 and 6). A 3- to 4-inch-long PVC tube can be used to splice the old and new rolls together by securing the tape to the ends of the tube using two stainless steel wires or special connections.

## Trenching

Trenching may be necessary for mainlines, manifolds and flush lines. Manifolds and flush lines sometimes can be installed above the soil surface, with a trench only for the mainline. Trenching can be done with a rotary trencher or a backhoe. A rotary trencher is recommended. The steps are as follows:

1. Before trenching, pack the tape on the field with a tractor, passing a wheel on each side of the tape. (Fig. 7)
2. Trenches should be 2 feet wide or the size of the bucket on the backhoe. The trenches for the submainlines should be at least 16 inches below the depth of the drip line and 1 foot below the flushing line.
3. Expose the tape from the ditch forming a triangle (Fig. 8). Leave enough space to work with the hands and tie the drip line to the PVC pipe.
4. Level and pack the ditch bottoms with soil that falls from exposing the tape.
5. Place some flags where each station ends.

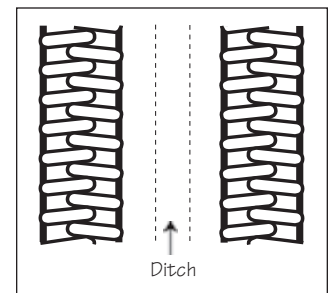

Figure 7. Pack the soil with a tractor tire on each side of the ditch.



Figure 8. Cross-section of the drip tape connection to the PVC manifold.



Figure 9. Drilling the manifold (A), inserting the grommet and the PVC hose (B), and connecting the PVC hose to the drip tape (C).

## Connecting drip lines with manifolds and flush lines

If manifolds and flush lines are below the soil surface:

There are several ways to make the connections. The following example uses grommets and barb fittings.

1. Drill a hole in the top of the manifold or flush line just where the tape is to be connected. (Figs. 9A and B). Use a 13/16-inch drill bit for #700 grommets (1-inch or 7/8-inch tape). Use a 9/16-inch drill bit for #400 grommets (5/8-inch tape).
2. Clean the hole with a knife to remove all plastic residue. This plastic could produce leaks later in the season.
3. Insert the grommets in the hole.
4. Pre-assemble the insertion to the PVC hose, using glue.
5. Soak the insertion with soapy water so it will fit easily into the grommet.
6. Insert the PVC hose into the tape, being careful not to bend the hose.
7. Tie a stainless steel wire around the tape (Fig. 9C).

If submains and flush lines are above the soil surface:

The most common connection method is to insert small-diameter PE tubing (0.188 to 0.35 inches outside diameter) into the PVC, PE or lay flat hose as shown in Figure 10A. A hole is then made on the drip line and the tubing is inserted in the drip line. The tubing is attached to the drip line with a piece of folded tape. Another method is to use connections as shown in Figure 10b.

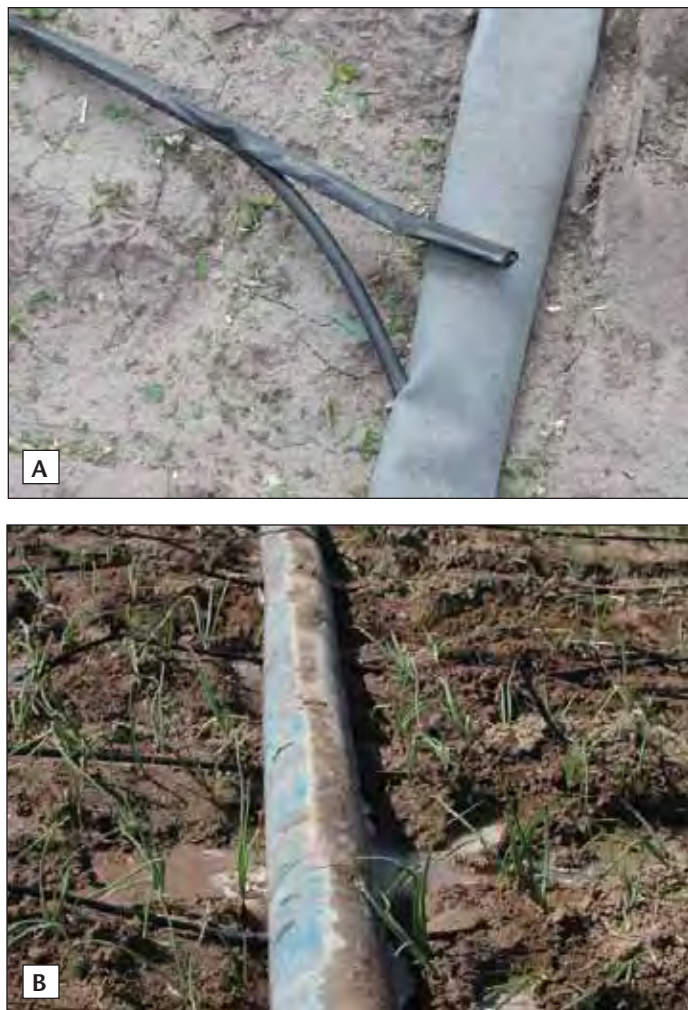

Figure 10. Connecting the drip tape to a manifold above the soil surface with tubing (A) and with a fitting (B).

## Back-filling

Run each station for 4 hours and check for leaks. If there are leaks in the middle of the field, make a hole and splice the tape. If there is a leak in the manifold, the connection between the tape and manifold needs to be redone or the plastic remnants need to be removed from the hole drilled in

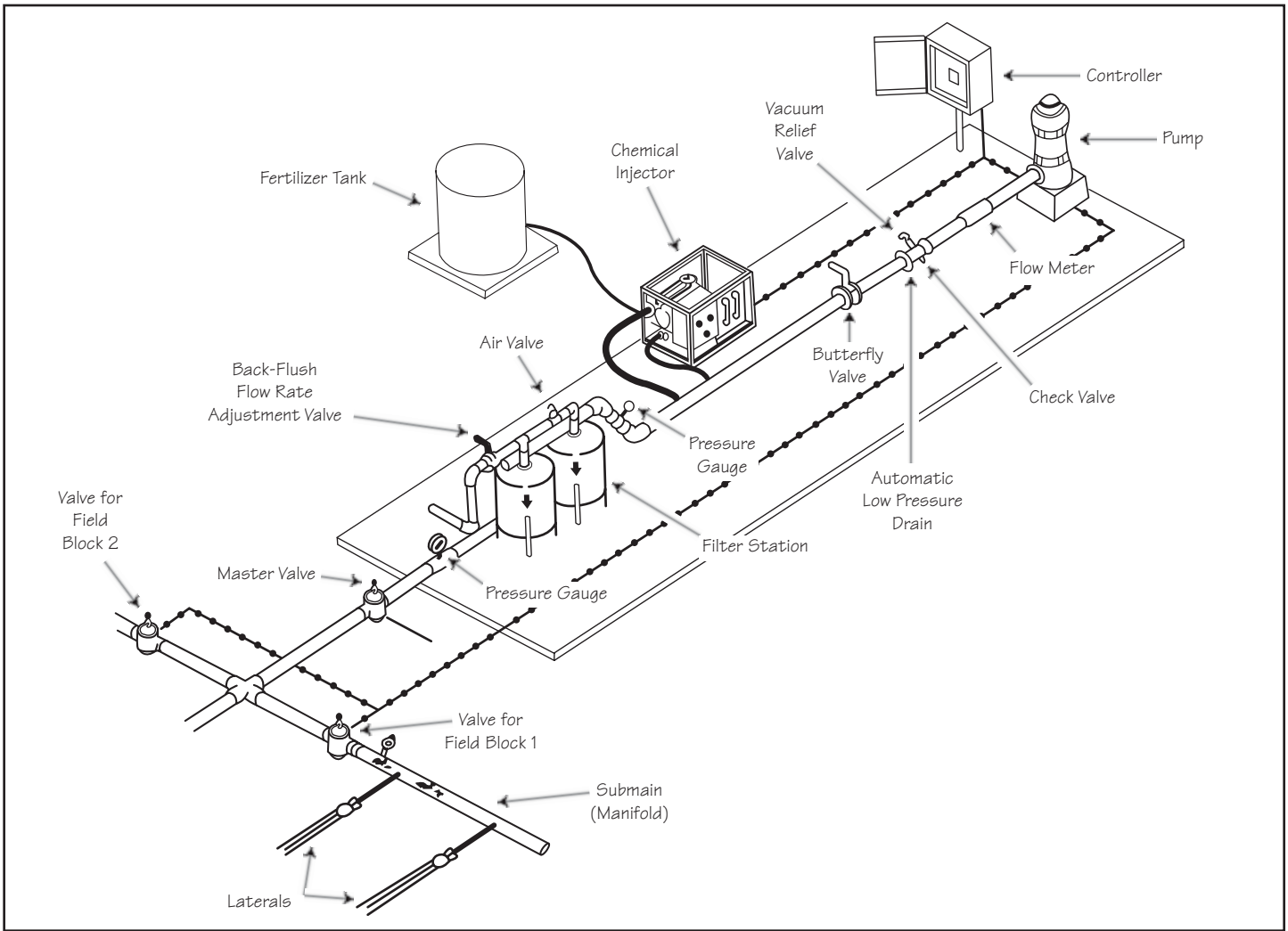

Figure 11. Typical layout of the pumping station showing the filtering equipment.

the manifold. If there are no leaks, GENTLY push some loose soil into the ditch. Then add water to the ditch so the soil will settle around the pipe to hold it and prevent it from moving. Do not move too much soil at once, as this can damage rigid pipe and connections. Pack the soil, then add more soil and water until the ditch is filled.

## Installing filtration equipment

The filters should be installed over solid surfaces, preferably concrete bases. A typical set up of the filtering equipment and its components is shown in Figures 11 and 12. Filters remove the solid matter suspended in the water to keep the drip emitters from clogging. The most common filtration size for subsurface drip irrigation is 200-mesh (200 openings per inch), which represents an opening of about 0.003 inches (0.076 mm). Centrifugal filters, media or

sand filters, and screen and disk filters are commonly used, often in combination. For example, if water comes from an aquifer and some sand is being pumped, a centrifugal filter can be used to trap the sand, followed by a disk or sand media filter. When water comes from a canal, it is common to have both a media filter and a screen filter.

Media filters need the most adjustment during installation. Media filters consist of several tanks that filter the water, and each tank needs to be back-flushed. This is done by passing clean water through a tank in a reverse direction; the clean

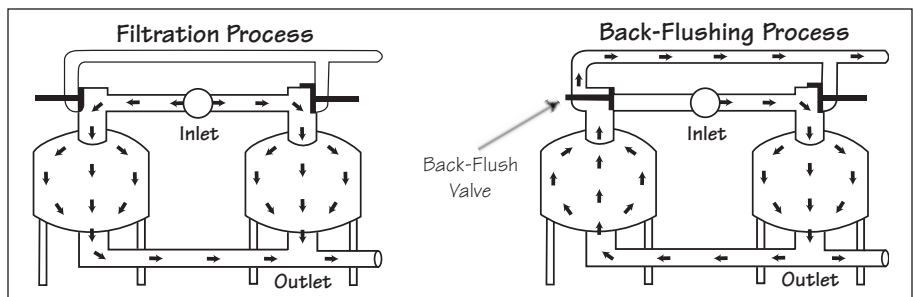

Figure 12. Filtration and back-flushing process.

water comes from the other tanks that are not being back-flushed (Fig. 13). Tanks must be back-flushed when they are dirty, a condition that is usually indicated by an increase of pressure of about 10 psi.

A sand media filter has some pressure loss—about 3 to 5 psi. Incorrect installation can increase the loss to about 10 to 25 psi. Follow these steps to install a sand media filter:

1. Order only pre-washed gravel.
2. Install the gravel and the sand at the depths recommended by the manufacturer.
3. Close all the valves downstream of the tanks (the back-flush valve).
4. Open the main valve (butterfly valve).
5. Open completely the back-flush valve of one of the media tanks. Then open the back-flush flow rate adjustment valve slowly. Remember that the back-flush flow rate adjustment valve should be calibrated just one time. The back-flush flow rate should be determined from visual observation.
  - The back-flush flow rate should be sufficient to expand the media bed and separate the sand into individual particles. The smaller particles and those with lighter specific gravity than the media need to be carried out of the tank.
  - The back-flush flow rate should not be excessive to limit the amount of sand removed from the tank. The first time a tank is back-flushed it is normal to remove some sand. Use a 100-mesh screen at the discharge to catch the sand discharged.
6. Repeat the process, opening the back-flush valve of each tank.

7. Adjust the frequency and the time of the back-flushing operation. It is important to back-flush at least once per day and to control the back-flushing automatically by triggering it with a differential pressure switch. This switch is usually set to start when the differential pressure increases to 5 to 8 psi.



Figure 13. Filtration equipment.



This material is based upon work supported by the Rio Grande Basin Initiative of the Cooperative State Research, Education and Extension Service, U.S. Department of Agriculture under Agreement No. 2001-45049-01149.

The information given herein is for educational purposes only. Reference to commercial products or trade names is made with the understanding that no discrimination is intended and no endorsement by Texas Cooperative Extension is implied.

Produced by Agricultural Communications, The Texas A&M University System  
Extension publications can be found on the Web at: <http://tcebookstore.org>

*Educational programs of Texas Cooperative Extension are open to all people without regard to race, color, sex, disability, religion, age or national origin.* Issued in furtherance of Cooperative Extension Work in Agriculture and Home Economics, Acts of Congress of May 8, 1914, as amended, and June 30, 1914, in cooperation with the United States Department of Agriculture. Chester P. Fehlis, Director, Texas Cooperative Extension, The Texas A&M University System.  
500, New



# Maintaining Subsurface Drip Irrigation Systems (L-5406)

# Maintaining Subsurface Drip Irrigation Systems

Juan Enciso, Dana Porter, Jim Bordovsky and Guy Fipps\*

Subsurface drip irrigation (SDI) systems can deliver water at low flow rates very uniformly. A permanent system, properly designed and maintained, should last more than 20 years. A maintenance program includes cleaning the filters, flushing the lines, adding chlorine, and injecting acids. These preventive measures will reduce the need for major repairs and extend the life of the system.

The purpose of preventive maintenance is to keep the emitters from plugging. Emitters can be plugged by suspended solids, magnesium and calcium precipitation, manganese-iron oxides and sulfides, algae, bacteria and plant roots.

Each SDI system should contain a flow meter and at least two pressure gauges—one gauge before the filters and another after the filters (Fig. 1). Flow meters and pressure gauges, which should be inspected daily, indicate whether the system is working properly. A low pressure reading on a pressure gauge indicates a leak in the system (such as a leaking component or broken pipe). A difference in pressure between the filters may mean that the system is not being back-flushed properly and that the filters need to be cleaned. In larger systems, pressure gauges should be installed in each field block or zone (Fig. 1).

Plugging potential of irrigation water			
Chemical property	Low	Moderate	Severe
PH	< 7.0	7.0 - 8.0	>8.0
Bicarbonate (ppm)		<100.0	
Iron (ppm)	<0.2	0.2 - 1.5	>1.5
Sulfides (ppm)	<0.2	0.2 - 2.0	>2.0
Manganese (ppm)	<0.1	0.1 - 1.5	>1.5

Water quality determines the relative risk of emitter plugging and other problems; therefore, the properties of the water should be taken into account in the system maintenance program. Examples of water quality parameters and their effect on emitter plugging potential are summarized in the following table.

## Maintaining filters

Filters are essential components of an SDI system; they remove suspended solids from the water. There are three main types of filters: cyclonic filters (centrifugal separators); screen and disk filters; and media filters. It is common practice to install a combination of filters to remove particles of various sizes and densities effectively.

### Centrifugal separators

These filters need little maintenance, but they require regular flushing. The amount of sediment in the incoming water, the volume of water used, and the capacity of the collection chamber at the bottom of the filter will determine how often and

\*Assistant Professor and Extension Agricultural Engineer, Assistant Professor and Extension Agricultural Engineer, Agricultural Engineer and Associate Research Scientist, Professor and Extension Agricultural Engineer, The Texas A&M University System.

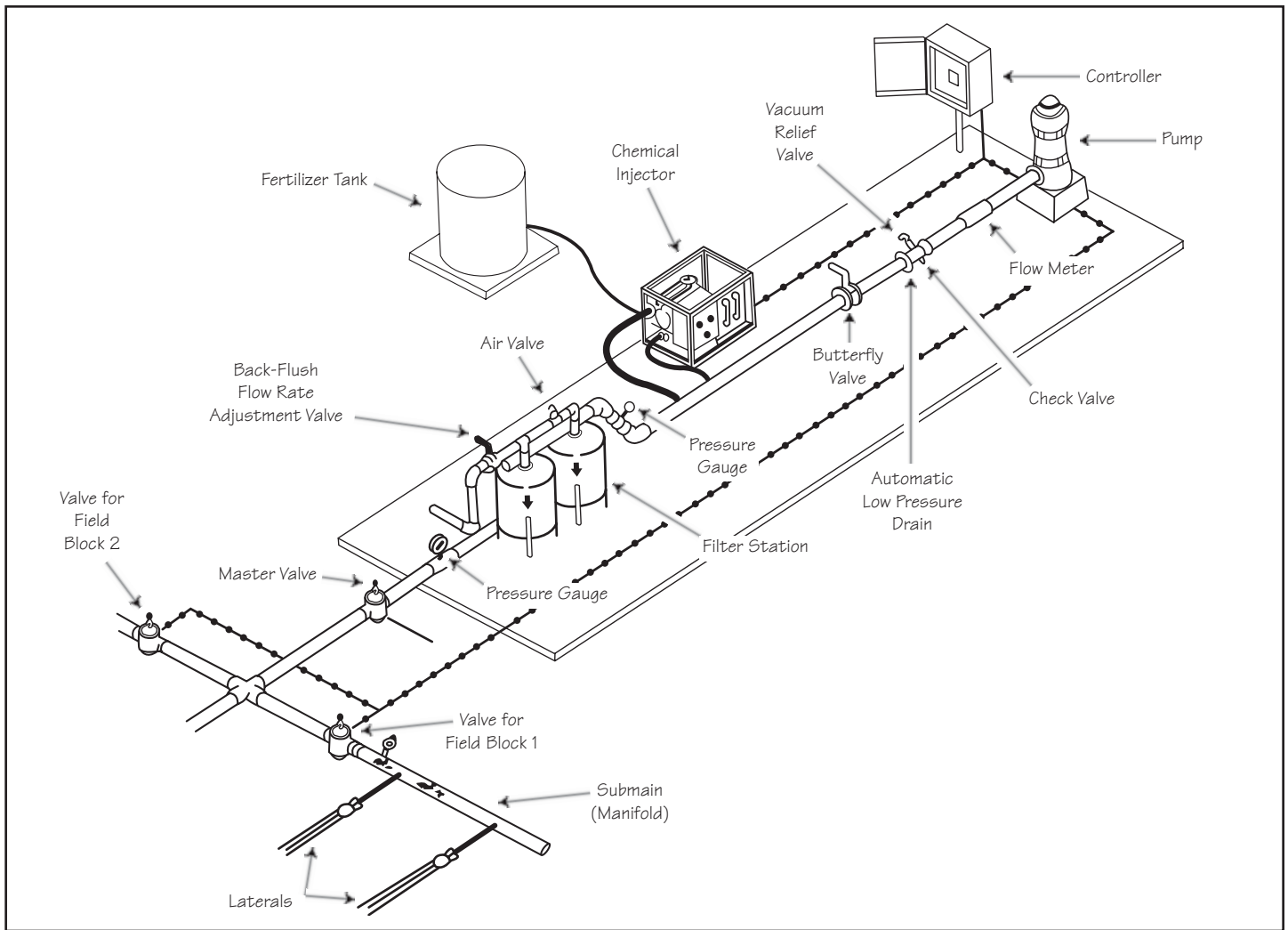

Figure 1. Typical layout of the irrigation system.

how long the flushing valve needs to operate. The sediment can be released manually or automatically. If it is done manually, the bottom valve of the filter should be opened and closed at regular intervals. Or, an electronic valve controlled by a timer can automatically open the bottom valve. Automated operation of the valve should be checked at least every other day during the season.

#### Screen and disk filters

Small screen filters use a nylon strainer or bag, which should be removed and checked periodically for small holes. The flush valve controls the flushing of the screen filter. This can be operated manually or automatically. Flush the screen filter when the pressure between the two pressure gauges drops 5 psi (one gauge is located before the filters and the other after them). Automatic filters use a device called a “pressure differential switch” to detect a pressure drop across the filters. Other systems use a timer, which is usually

set by the operator. The flushing can be timed according to the irrigation time and the quality of the water. The interval between flushing can be adjusted to account for differences in pressures across the filters. Automated flushing devices should be checked at least every other day on large systems.

#### Sand media filters

With these filters the most important task is to adjust the back-flush adjustment valve (Fig. 1). If the backflow rate is too high, sand filter media will be washed out of the filter container. If the backflow rate is too low, contaminating particles will not be washed out of the filter. Bacterial growth and the chemistry of the water can cause the sand media to cement. Cementing of the media causes channels to form in the sand, which can allow contaminated water to pass unfiltered into the irrigation system. Chlorination can correct or prevent sand media cementing.



## Evaluating the System

One way to evaluate clogging problems is to place a container under selected emitters as shown in Figure 2. The emitter flow rate (volume over time) collected at different locations should be compared against the design flow rate. The upper picture of Figure 3 shows a field where plants are stressed because emitters are clogged by manganese oxides. The general condition of a drip system can be easily evaluated by checking system pressures and flow rates often. If emitters become plugged, system pressures will increase and flows will decrease.



**Figure 2.** Evaluating emitter flow rate to identify clogging problems.



**Figure 3.** (Top) Plants in this field are drought-stressed because emitters are clogged. (Bottom) Acid injection can reduce clogging problems so fields are irrigated uniformly.



## Flushing lines and manifolds

Very fine particles pass through the filters and can clog the emitters. As long as the water velocity is high and the water flow is turbulent, these particles remain suspended. If the water velocity slows or the water becomes less turbulent, these particles may settle out. This commonly occurs at the distant ends of the lateral lines. If they are not flushed, the emitters will plug and the line eventually will be filled with sediment from the downstream end to the upstream end. Systems must be designed so that mainlines, manifolds (submains) and laterals can all be flushed. Mainlines and manifolds are flushed with a valve installed at the very end of each line. Lines can be flushed manually or automatically. It is important to flush the lines at least every 2 weeks during the growing season.

## Injecting chlorine

At a low concentration (1 to 5 ppm), chlorine kills bacteria and oxidizes iron. At a high concentration (100 to 1000 ppm), it oxidizes (destroys) organic matter.

### *Bacteria produced by iron and manganese*

The most serious problems with bacteria occur in water that contains ferrous or soluble iron or manganese. Iron and/or manganese concentrations higher than 0.1 ppm can promote bacterial growth and chemical precipitation that clogs emitters. Iron bacterial growth looks reddish, whereas manganese bacterial growth looks black. These bacteria oxidize iron and manganese from the irrigation water. In the western part of Texas, these bacteria often are found in well water.

Be extremely cautious when injecting chlorine into irrigation water containing dissolved manganese, because chlorine can oxidize this element and cause precipitation beyond the filter system. Figure 4 shows an emitter plugged by manganese oxides.

It is hard to eliminate iron bacteria, but it may be controlled by injecting chlorine into the well once or twice during the season. It might also be necessary to inject chlorine and acid before (upstream of) the fil-



**Figure 4.** An emitter clogged by manganese oxides.

ters. When the water contains a lot of iron, some of the iron will feed the bacteria and some will be oxidized by chlorine to form rust (or insoluble iron, ferric oxide). The precipitated ferric oxide is filtered out and flushed from the system. If the iron concentration is high and problems persist, aerating the irrigation water will help to oxidize the iron and settle the sediment. Aerate the water by pumping it into a reservoir and then re-pumping it with a booster pump to the irrigation system.

Use a swimming pool test kit to test for free or residual chlorine in the water at the end of the lateral line. It is worth noting that some of the injected chlorine may be removed from solution (tied up) through chemical reactions with other constituents or absorption by organic matter in the water. If chlorine is continuously injected, a level of 1 ppm of free residual chlorine at the ends of the laterals will be enough to kill most bacteria. With intermittent injection (once every several days), the chlorine concentration at the ends of the laterals should be maintained at 10 to 20 ppm for 30 to 60 minutes.

If emitters are already partially plugged by organic matter, “superchlorination” treatment is warranted; it involves maintaining a concentration of 200 to 500 ppm chlorine in the system for 24 hours.

Some extra chlorine should be injected to account for the tied up chlorine.

## Injecting Acid

Acids are injected into irrigation water to treat plugging caused by calcium carbonate (lime) and magnesium precipitation. Water with a pH of 7.5 or higher and a bicarbonate level higher than 100 ppm has a risk of mineral precipitation, depending on the hardness of the water. Hardness of water, which is determined by the concentrations of calcium and magnesium, is classified as follows: soft (0 to 60 ppm of Ca and Mg); moderate (61 to 120); hard (121 to 180); very hard (more than 180 ppm). Moderate, hard and very hard water needs acid injection.

Sulfuric, phosphoric, urea-sulfuric, or acetic acid can be used. The type most commonly used in drip irrigation is 98% sulfuric acid. Acetic acid, or vinegar, can be used in organic farming, although it is much more expensive. If the irrigation water has more than 50 ppm of calcium, phosphoric acid should not be injected unless enough is added to lower the pH below 4.

Acid is usually injected after the filter so that it does not corrode the filter. If the filter is made of polyethylene, which resists corrosion, acid can be injected before the filter.

---

## Injection rate for chlorine

Calculate the injection rate with these formulas:

English units calculation

$$IR = \frac{0.006xFxC}{P}$$

Where:

IR = Injection rate, gallons/hr

F = Flow rate of the system, GPH

C = Concentration of chlorine wanted, ppm

P = Percentage of chlorine in the solution\*

Metric units calculation

$$IR = \frac{0.36xFxC}{P}$$

Where:

IR = Injection rate, liters/hour

F = Flow rate of the system, LPS

C = Concentration of chlorine wanted, ppm

P = Percentage of chlorine in the solution\*

\*The percentage of chlorine for different compounds is as follows:

calcium hypochlorite—65%

sodium hypochlorite (household bleach)—5.25%

lithium hypochlorite—36%

Example:

A farmer wants to inject chlorine into his system at a concentration of 5 ppm in a system with a flow rate of 100 GPM. He is injecting household bleach that has a chlorine concentration of 5.25%.

$$IR = \frac{0.006xFxC}{P} = \frac{0.006x100x5}{5.25} = 0.571 \text{ GPH sodium hypochlorite (household bleach)}$$

The following tables show the necessary injection rate of chlorine in gallons per hour.

Desired chlorine level in ppm	Gallons of chlorine (5.25% solution) per hour								
	Gallons per minute (GPM) of irrigation water								
	100	150	200	250	300	350	400	450	500
1	0.114	0.171	0.229	0.286	0.343	0.400	0.457	0.514	0.571
2	0.229	0.343	0.457	0.571	0.686	0.800	0.914	1.029	1.143
5	0.571	0.857	1.143	1.429	1.714	2.000	2.286	2.571	2.857
10	1.143	1.714	2.286	2.857	3.429	4.000	4.571	5.143	5.714
15	1.714	2.571	3.429	4.288	5.143	6.000	6.857	7.714	8.571
20	2.286	3.429	4.571	5.714	6.857	8.000	9.143	10.286	11.429
25	2.857	4.286	5.714	7.143	8.571	10.000	11.429	12.857	14.286
30	3.429	5.143	6.867	8.571	10.286	12.000	13.714	15.429	17.143
50	5.714	8.571	11.429	14.286	17.143	20.000	22.857	25.714	28.571

Desired chlorine level in ppm	Gallons of chlorine (10% solution) per hour								
	Gallons per minute (GPM) of irrigation water								
	100	150	200	250	300	350	400	450	500
1	0.060	0.090	0.120	0.150	0.180	0.210	0.240	0.270	0.300
2	0.120	0.180	0.240	0.300	0.360	0.420	0.480	0.540	0.600
5	0.300	0.450	0.600	0.750	0.900	1.050	1.200	1.350	1.500
10	0.600	0.900	1.200	1.500	1.800	2.100	2.400	2.700	3.000
15	0.900	1.350	1.800	2.250	2.700	3.150	3.600	4.050	4.500
20	1.200	1.800	2.400	3.000	3.600	4.200	4.800	5.400	6.000
25	1.500	2.250	3.000	3.750	4.500	5.250	6.000	6.750	7.500
30	1.800	2.700	3.600	4.500	5.400	6.300	7.200	8.100	9.000
50	3.000	4.500	6.000	7.500	9.000	10.500	12.000	13.500	15.000

The amount of acid to use depends on the characteristics of the acid you are using and the chemical characteristics of the irrigation water. A titration curve of the well water used for drip irrigation can be developed by a laboratory. It will show the amount of acid needed to reduce the pH to a certain level. If a titration curve is not available, use a trial-and-error approach until the pH is reduced to 6.5. Colorimetric kits or portable pH meters can be used to determine the water pH at the ends of lines. Many farmers inject 1 to 5 gallons of sulfuric acid per hour, depending on the water pH, water quality and well capacity.

Most chemicals used in drip system maintenance are extremely hazardous. Sulfuric acid is very corrosive and must be handled with proper personal protection equipment. Store sulfuric acid in polyethylene or stainless steel tanks with extra heavy walls. **Always add acid to water; do not add water to acid.** Never mix acid and chlorine or store them together in the same room; a toxic gas will form.

Besides clearing clogged emitters, acid injected into irrigation water may improve the infiltration characteristics of some soils and release micro-

nutrients by lowering the soil pH. To reduce the cost, acid can be injected only during the last third of the irrigation time.

## Other necessary maintenance

### Keep out plant roots

It is important to keep plant roots from penetrating the drip emitters (Fig. 5 shows a root intrusion problem). Metam sodium and trifluralin are two compounds that control roots. In cotton, metam sodium is generally used at defoliation to keep roots out as the soil dries,



Figure 5. Roots penetrating a drip emitter.

while trifluralin is used before harvest. Super-chlorination at a dosage of 400 ppm chlorine also will keep roots out. Fill the tapes with chlorine and leave it overnight.

### Prevent back-siphoning

Back-siphoning is the backflow of water from the soil profile back into the tape at the end of an irrigation cycle. It is caused by a vacuum that develops as residual water in the tape moves to the lower elevations in the field. Back-siphoning may pull soil particles and other debris through emitters and into the tape. Figure 6 shows some live worms that were flushed from SDI lines during normal maintenance. It is thought that the eggs or cocoons of worms were pulled into the drip lines at the higher elevations in the field when zone valves were closed. Once in the drip lines, the eggs hatched and the worms started to grow. Worms and other contaminants were removed during normal flushing cycles (every 2 weeks).

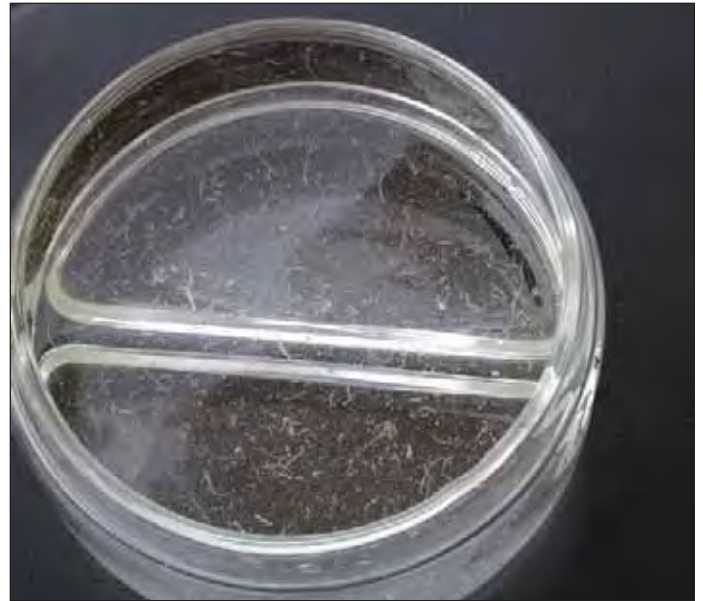

Figure 6. Worms flushed from an SDI system. Flushing twice a week solved the problem.



This material is based upon work supported by the Rio Grande Basin Initiative of the Cooperative State Research, Education and Extension Service, U.S. Department of Agriculture under Agreement No. 2001-45049-01149.

The information given herein is for educational purposes only. Reference to commercial products or trade names is made with the understanding that no discrimination is intended and no endorsement by Texas Cooperative Extension is implied.

Produced by Agricultural Communications, The Texas A&M University System  
Extension publications can be found on the Web at: <http://tcebookstore.org>



# Subsurface Drip Irrigation (SDI) Components: Minimum Requirements (MF-2576)

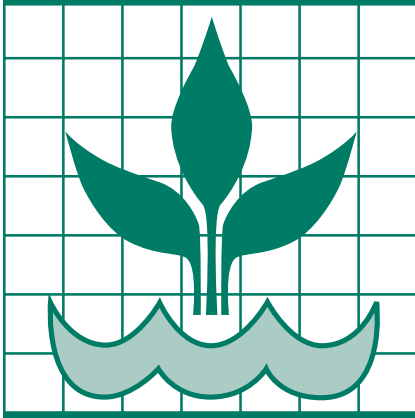

## IRRIGATION MANAGEMENT

S E R I E S

# Subsurface Drip Irrigation (SDI) Components: Minimum Requirements

**Danny H. Rogers**  
Extension Agricultural Engineer

**Freddie R. Lamm**  
Research Irrigation Engineer

**Mahbub Alam**  
Extension Agricultural Engineer

**Kansas State University  
Agricultural Experiment Station  
and Cooperative Extension Service  
Manhattan, Kansas**

Subsurface drip irrigation (SDI) systems provide water and nutrients directly to the plant root zone through built-in emitters on polyethylene tubes that are buried below the soil surface. Experience in Kansas has shown that properly designed and managed systems can maintain or potentially improve yields, while saving water, fertilizer, energy, and money. However, these systems also require careful management to function properly. A good first step toward maintaining a profitable SDI system is proper selection of the system components.

This publication:

1. Lists the basic components for a subsurface drip irrigation system.
2. Explains the important factors to consider in selecting components.

Figure 1 shows the basic components of a typical SDI system and a general organization of the components. These basic components are required for any system.

### Required System Components

An SDI system can function without all of the listed components, but it may be difficult to manage and maintain and may perform poorly. Eventually, the system may fail due to the lack of cues to the manager on the status of performance or insufficient emitter protection. Usually there are several versions of each component; these are listed as options below. A specific option may or may not be acceptable for your application depending on the specific site and system conditions. The major factors that should be considered when selecting each component are listed under considerations. Make sure the characteristics of your site and system are specifically addressed in your SDI system design.

1. **Pump.** SDI systems generally have low pressure requirements. Only one pump is needed, as is the case for most irrigation systems in Kansas. The pressure requirement is in the range of most low-pressure center pivot sprinkler systems. The size of the pump depends on flow rate and total head requirements. The total head requirements include pumping lift, friction/losses, elevation changes, system pressure and, for SDI systems, the pressure loss across the filter and other structural components, such as control valves, flow meter, check valves, main, and submain supply lines.
  - Considerations. The size of the pump will depend on the water supply capacity, system pressure needs, zone size (area to be irrigated at one time), and the filter and flushline flushing requirements.
2. **Filter system.** The filter system removes suspended particles from water to prevent emitter clogging. A group of filters can be installed in parallel to increase total flow rate. A series of filters can be used to improve filtration.
  - Options. Screens, discs, and sand media filters are commonly used depending on water quality. Centrifugal sand separators are used when water carries sand load from deep wells. Settling basins to remove sediment load for surface water supply system may be required in addition to regular filter system. A combination of devices may be used to remove suspended particles. Many of these systems have automatic backflush capability.

- Considerations. Water quality, emitter requirements (maximum allowable particle size), and system flow rate are important filtering factors. Water quality relates to the amount, size, and type of particles (organic or mineral) to be removed. For example, surface water typically has much higher organic matter content than groundwater, which affects the type of filter that can be used. Filtration requirement is determined by the emitter size or opening. That information is provided by the manufacturer and must be followed to help ensure system longevity. In general, filtration is provided to prevent passing of particles  $\frac{1}{10}$  the size of the smallest passageway. Primary filters are grouped as screen, disc, or media filters. K-State Research and Extension publication, MF-2361, *Filtration and Maintenance Considerations for Subsurface Drip Irrigation (SDI) Systems*, discusses filtration needs in more detail.

3. **Pressure-sustaining valve.** Depending on the type of filtration, the unit may be equipped with a pressure-sustaining valve to facilitate flushing (automatic or manual).
4. **Pressure gauges.** The filter(s) should have pressure gauges at the inlet and outlet points to show pressure differential for initiating flushing of the filtration unit, either manually or automatically. Follow the manufacturer's recommendation on the pressure differential value at which flushing should be initiated. It also is recommended to have pressure gauges at the beginning of the main delivery system and at the distal end of the system fitted on flushline. The flow rate from the meter and the pressure reading of the system provide cues to the operator about emitter performance and clogging.
5. **Backflow preventer.** These devices prevent the backflow of fertilizers, chemicals, or

particulates into the water supply and are installed between the water supply or pump and the chemical injection line.

- Options. A physical air gap between waterline and fertigation tank, an atmospheric vacuum breaker, a pressure vacuum breaker, or a double-check valve are options to prevent backflow.
  - Considerations. The type of fluid that can backflow (toxic or nontoxic), and whether there can be back pressure or back siphonage are important considerations. State and local regulations and codes must be followed.
6. **Regulation valve.** These valves are used to help maintain the proper pressure in irrigation lines.
  - Considerations. The manufacturer's emitter rating and the pipeline pressure losses during the delivery of

**Figure 1.** Schematic of Subsurface Drip Irrigation (SDI) System. (Components are not to scale.)

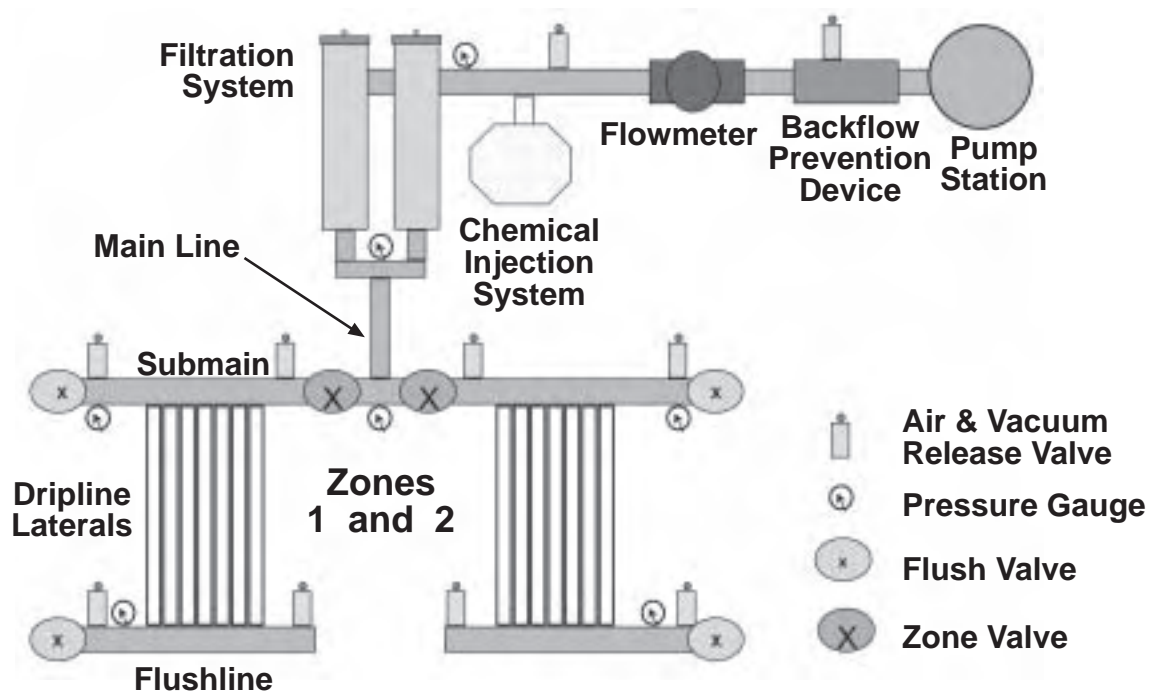

the water to the dripline connection point are important considerations. Emitters are typically rated by manufacturers to provide a specific flow rate if operated at a given pressure. The regulation valve must be sized to provide this pressure while accounting for pressure losses that occur between the valve and the emitter.

7. **Chemical injector.** A chemical injector precisely injects fertilizers or pesticides into the irrigation stream.

- Options. There are two types of chemical injection units:  
1) *Constant rate* (positive displacement): diaphragm, piston, or gear pumps and  
2) *Variable rate*: venturi pressure differential injectors or bladder tanks.
- Considerations. The types of chemicals used, rate of injection, method of injection, and the precision required are determining factors in selection of the best type of injector. The required number of injection systems and their injection point location depend on the clogging hazard and/or the material being injected.

8. **Flowmeter.** The flowmeter measures the volume of water moving through the system, either as a flowrate or as an accumulated total volume basis. The flowmeter provides the operator with information on how the system is performing and how to schedule the water application.

9. **Chemigation line check valve.** This valve, installed between the injector and the water source, prevents backflow of water into the

chemical supply tank in case of injector failure. This valve is often an integral part of an injector unit and can handle both backpressure and backsiphonage.

- Considerations. State and local codes must be followed.

10. **Zone valve.** These valves are opened or closed to control the flow to appropriate zones. They can be automatically controlled using an electronic control system. In production agriculture, these zone valves are often manually operated where the zone size is appreciably large.

11. **Pressure regulator.** Pressure regulators are typically located on the manifold to help regulate operating pressure for emitters.

- Considerations. Manufacturer emitter rating and line pressure losses are the major considerations. Emitters are typically rated by manufacturers to provide a specific flow rate if operated at a given pressure. The pressure regulator must be sized to provide this pressure while accounting for pressure losses that occur between the regulator and the emitters.

12. **Air and vacuum release valves.** These valves prevent soil or particulate material from being sucked back into emitters when the irrigation system is turned off or when driplines are drained. They cannot handle backpressure, only backsiphonage. All high elevation points of system should have air or vacuum relief.

13. **Main line, submain.** The main line and submains are the delivery pipelines that supply

water from the system head-works control to manifolds connecting dripline laterals.

- Considerations. System pressure, required flow rates, water hammer, and pipe cost are the consideration factors for consideration.
14. **Flushlines.** The flushlines at the tail end of the system serve three purposes:  
1) Allow any sediment and contaminants to be flushed from dripline laterals at a centralized location,  
2) Equalization of pressure in the dripline laterals, and  
3) Allow positive pressure on both sides of a dripline break to prevent soil ingestion into the dripline.
15. **Header manifold.** The header manifold delivers water from the submain to the laterals and links a number of driplines together into one controllable unit. In most agricultural fields, the submain serves this function.
16. **Dripline.** The dripline is the polyethylene tubing that includes a built-in emitter. Emitter spacing and rate are selected to match crop demands and soil water-holding capacity. They must be compatible with the pumping pressure and flow capacity. Driplines are available in a variety of wall thicknesses, diameters, emitter spacings, and flow rates. Most SDI systems in Kansas use driplines with 8 (0.250 mm) to 15 (0.375 mm) MIL wall thickness. SDI systems for row crops tend to use large diameter ( $\frac{7}{8}$  inch or greater diameter), thin-walled and low-flow driplines, which are sometimes referred to as driptapes. Larger diameter and lower flows



allow longer length of runs and larger zone size that are appropriate for the typical field sizes in Kansas. Pressure-compensating driplines are available, but are generally not used in Kansas due to higher cost. Water quality also may be a consideration in the choice of emitter size and spacing to avoid clogging. K-State Research and Extension publication, MF-2578, *Design Considerations for SDI Systems*, discuss these considerations in more detail.

- Considerations. Tubing wall thickness, emitter spacing, discharge rate, soil texture, and soil water holding capacity are considerations because these affect plant root zone water content and distribution.

18. **Connectors.** Connectors are needed to attach the dripline to the manifold or submain. The number and type depend on system layout. There are many types of connectors. Connector options include glued, grommet, barb, and compression. These can have a direct

dripline connection or may receive a supply tube that is attached to the dripline. The dripline connector options are wired, clamped, or interference (compression) fit.

### **Optional Automatic System Control**

Automatic control may be useful for precise delivery of water and nutrients according to design or crop need. This also reduces the need for manual control.

**Automatic controls.** Pumps, valves, and injectors can be turned on and off or opened and closed to allow automatic timing and sequencing of irrigation zones. These may be linked to automatic timers, soil water sensors, or weather-based models to determine when irrigation system should run. Computer control and monitoring is an option, but not required for automation.

### **Summary**

SDI systems have higher initial investment costs compared to traditional types of irrigation systems used in Kansas, so efforts

to minimize initial investment costs whenever possible is a practical goal. However, cost reductions should be attempted only if system design and operating integrity are not compromised. Cost cutting that results in a poor design or a difficult to manage system may increase operating costs, decrease system performance and increase the chance of system failure.

### **Additional Resources**

MF-2361 *Filtration and Maintenance Considerations for Subsurface Drip Irrigation (SDI) Systems*

MF-2242 *Economic Comparison of SDI and Center Pivots for Various Field Sizes*

MF-836 *Irrigation Capital Requirements and Energy Cost*

MF-2578 *Design Considerations for Subsurface Drip Irrigation*

MF-2590 *Management Consideration for Operating a Subsurface Drip Irrigation System*

MF-2575 *Water Quality Assessment Guidelines for Subsurface Drip Irrigation*

K-State Research and Extension  
SDI Web site

[www.oznet.ksu.edu/sdi](http://www.oznet.ksu.edu/sdi)

Acknowledgment: This material is based upon work supported by the U.S. Department of Agriculture Cooperative State Research Service under Agreement No. 00-34296-9154. Any opinions, findings, conclusions or recommendations expressed in this publication are those of the authors and do not necessarily reflect the views of the U.S. Department of Agriculture.

Brand names appearing in this publication are for product identification purposes only. No endorsement is intended, nor is criticism implied of similar products not mentioned.

Publications from Kansas State University are available on the World Wide Web at: <http://www.oznet.ksu.edu>

Contents of this publication may be freely reproduced for educational purposes. All other rights reserved.

In each case credit Danny H. Rogers et al., *Subsurface Drip Irrigation (SDI) Components: Minimum Requirements*, Kansas State University, July 2003.

**Kansas State University Agricultural Experiment Station and Cooperative Extension Service**

MF-2576

July 2003

It is the policy of Kansas State University Agricultural Experiment Station and Cooperative Extension Service that all persons shall have equal opportunity and access to its educational programs, services, activities, and materials without regard to race, color, religion, national origin, sex, age or disability. Kansas State University is an equal opportunity organization. Issued in furtherance of Cooperative Extension Work, Acts of May 8 and June 30, 1914, as amended. Kansas State University, County Extension Councils, Extension Districts, and United States Department of Agriculture Cooperating, Marc A. Johnson, Director.



# Subsurface Irrigation Systems Water Quality Assessment Guidelines (MF-2575)

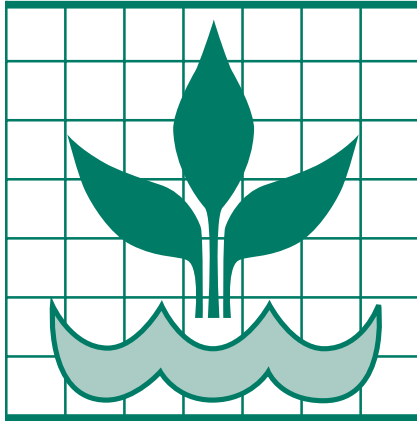

## IRRIGATION MANAGEMENT

S E R I E S

# Subsurface Drip Irrigation Systems (SDI) Water Quality Assessment Guidelines

**Danny H. Rogers**  
Extension Agricultural Engineer

**Freddie R. Lamm**  
Research Irrigation Engineer

**Mahbub Alam**  
Extension Irrigation Specialist

Kansas State University  
Agricultural Experiment Station  
and Cooperative Extension Service  
Manhattan, Kansas

### Introduction

Water quality can have a significant effect on subsurface drip irrigation (SDI) system performance and longevity. In some instances, poor water quality, such as high salinity, can cause soil quality and crop growth problems. However, with proper treatment and management, water with high mineral loading, nutrient enrichment, or high salinity can be used successfully in SDI systems. However, no system should be designed and installed without assessing the quality of the proposed irrigation water supply.

### Sampling Requirements

Water samples should be collected in clean triple-rinsed plastic bottles. Water samples from wells should be collected after the well has been operating for at least 15 minutes. Surface water samples should be collected below the water surface. If the quality varies throughout the pumping season, choose the worst case sample or sample multiple times.

About a half gallon of water is needed to perform the chemical analysis. The samples need to be analyzed within 3 hours. If this is not practical, the samples can be frozen or held below 40 degrees Fahrenheit. Check with the lab for specific collection and handling instructions. Be certain to let them know the types of tests you need. These tests are discussed below.

### Water Quality Analysis Recommendations

Prevention of clogging is the key to SDI system longevity. Prevention requires an understanding of the potential problems associated with a particular water source. Water quality information should be obtained and made available to the designer and irrigation manager in the early stages of the planning so suitable system components — especially

the filtration system — and management and maintenance plans can be selected. Recommended water quality tests include:

1. *Electrical Conductivity (EC)* — measured in ds/m or mmho/cm - a measure of total salinity or total dissolved solids
2. *pH* — a measure of acidity -1 is very acid, 14 is very alkaline, and 7 is neutral
3. *Cations* — measured in meq/L, (milliequivalent/liter), includes: Calcium (Ca), Magnesium (Mg), and Sodium (Na)
4. *Anions* — measured in meq/L, includes: Chloride (Cl), Sulfate (SO<sub>4</sub>), Carbonate (CO<sub>3</sub>) and Bicarbonate (HCO<sub>3</sub>)
5. *Sodium Absorption Ratio (SAR)* — a measure of the potential for sodium in the water to develop sodicity, deterioration in soil permeability, and toxicity to crops. SAR is sometimes reported as Adjusted (Adj) SAR. The Adj. SAR value accounts for the effect of the HCO<sub>3</sub> concentration and salinity in the water and the subsequent potential sodium damage.
6. *Nitrate nitrogen (NO<sub>3</sub>-N)* — measured in mg/L (milligram/liter)
7. *Iron (Fe), Manganese (Mn), and Hydrogen Sulfide (H<sub>2</sub>S)* — measured in mg/L
8. *Total suspended solids* — measured in mg/L of particles in suspension
9. *Bacterial population* — a measure or count of bacterial presence in #/ml
10. *Boron\** - measured in mg/L
11. *Presence of oil\*\**

\* *The boron test would be for crop toxicity concern.*

\*\* *Oil in water would be concern for excessive filter clogging. It may not be a test option at some labs and could be considered an optional analysis.*

The measurement units for reporting concentrations is often milligrams per liter (mg/l). Milligrams per liter, when considering irrigation water, is essentially equivalent to parts per million (ppm). Concentrations may also be reported in milliequivalent per liter (meq/l). Conversion factors are needed to convert from mg/l to meq/l and vice versa. Table 1 lists the conversion factors for common constituents.

Tests 1 through 7 will likely be test results included in a standard irrigation water quality test package. Tests 8 through 11 are generally offered by water labs as individuals tests. The test for presence of oil may be a test to consider in oil producing areas or if the well to be used for SDI has experienced surging that may have introduced oil into the pumped water. The fee schedule for tests 1 through 11 will vary from lab to lab. The total cost for all recommended tests may be a few hundred dollars. This is still a minor

**Table 1.** Conversion factors: parts per million and milliequivalents per liter (Hanson et al. 1997)

Constituent	Convert ppm to meq/l multiply by	Convert meq/l to ppm multiply by
Na (sodium)	0.043	23
CA (calcium)	0.050	20
Mg (magnesium)	0.083	12
Cl (chloride)	0.029	35
SO <sub>4</sub> (sulfate)	0.021	48
CO <sub>3</sub> (carbonate)	0.033	30
HCO <sub>3</sub> (bicarbonate)	0.016	61

*Example:* Convert 10 meq/l of SO<sub>4</sub> to ppm: ppm = 48 x 10 meq/l = 480 ppm

investment compared to the value of determining the proper design and operation of the SDI system.

Water testing can be done by a number of laboratories in the state. Be sure to use a certified lab. Before collecting any sample, remember to check with the lab for the specific collection procedures, test kits, or the handling requirements of the sample that is needed to ensure quality test results. Table 2 summarizes the water quality

guidelines for clogging potential. These guidelines help interpret water quality test results.

### Clogging Hazards

Most surface water and groundwater supplies in Kansas are fairly hard, meaning they have a high mineral content. In addition, many wells, especially older wells, may produce sand when pumping. These two clogging hazards are classified as chemical and physical

**Table 2.** Water Quality Guidelines for Microirrigation Systems

Constituent	Level of Concern		
	Low	Moderate	High
<b>Clogging Potential</b>			
pH	< 7.0	7 - 8	> 8.0
Iron (Fe) mg/L	< 0.2	0.2 - 1.5	> 1.5
Manganese (M <sub>n</sub> ) mg/L	< 0.1	0.1 - 1.5	> 1.5
Hydrogen Sulfide (H <sub>2</sub> S) mg/L	< 0.2	0.2 - 2.0	> 2.0
Total Dissolved solids (TDS) mg/l	< 500	500 - 2000	> 2000
Suspended Solids mg/L	< 50	50 - 100	> 100
Bacteria Count (# / mL)	< 10,000	10,000 - 50,000	> 50,000
<b>Crop Effect Potential</b>			
	<b>Low</b>	<b>Moderate</b>	<b>High</b>
EC - mmho/cm	< 0.75	0.75 - 3.0	> 3.0
NO <sub>3</sub> - mg/L	< 5	5 - 30	> 30
<b>Specific Ion Toxicity</b>			
	<b>Low</b>	<b>Moderate</b>	<b>High</b>
Boron - mg/L	< 0.7	0.7 - 3.0	> 3.0
Chloride - meq/L	< 4	4 - 10	> 10.0
Chloride - mg/L	< 142	142 - 355	> 355
Sodium (Adj SAR)	< 3.0	3 - 9	> 9

Adapted from Hanson et. al, 1994 and Hassan, 1998.

**Table 3.** Example size of various particles.

Particle	Diameter, mm
Coarse sand	0.50 to 1.00
Fine sand	0.10 to 0.25
Silt	0.002 to 0.05
Clay	<0.002
Bacteria	0.0004 to 0.002
Virus	<0.0004

hazards, respectively. The third clogging hazard is biological, which could be slimes produced by bacterial or algal growth.

As a general rule, filtration requirements are sized to remove particles 1/10 the size of the smallest emitter opening. Individual silt and clay particles and bacteria can generally pass through the filtration system and even through the drip irrigation emitters. However, conglomeration of multiple particles is possible, particularly with bonding “glues” provided by biological activity and clogging may result. It is impractical to filter out all the smaller particles, so considerations must

**Example:** A grower wishes to use household bleach (NaOC at 5.25 percent active chlorine) to achieve a 15 ppm chlorine level at the injection point. The flow rate of the irrigation system is 700 gpm.

At what rate should the NaOC be injected?

$$IR = 700 \text{ gpm} \times 15 \text{ ppm} \times 0.006 \div 5.25 = 12 \text{ gallons per hour}$$

At an irrigation flow rate of 700 gpm, the grower is pumping  $700 \times 60 = 42,000$  gph. The goal is to inject 12 gallons of bleach into 42,000 gallons of water each hour that injection occurs.

*If the injector is set for a 300:1 ratio, it will inject  $42,000 \div 300$  or 140 gallons per hour. Then, 12 gallons of bleach should be added to 140 gallons of water in the stock solution. Be careful to use the same time units (hours) when calculating the injection rate.*

be given to periodic flushing. Typical particle sizes are shown in Table 3.

Clogging hazards are discussed in more detail in *Filtration and Maintenance Considerations for Subsurface Drip Irrigation (SDI) Systems*, MF-2361.

### Well Chlorination

Bacteria do not normally live in groundwater until a well allows their introduction, an air exchange, and, in some cases, a source of

nutrients. Bacteria can live on iron, manganese, or sulphur. Their growth process produces a slime that can build up on the well screens and cause well yield declines. A bacteria-contaminated well will introduce bacteria to the SDI system, which can result in clogging of the filtration system and dripline emitters. Chlorination of an irrigation well to kill bacteria should be at least an annual practice. Treat the well with a shock treatment of 500 ppm to

**Table 4.** Notes on Chemical Clogging Hazards

1. Bicarbonate concentrations exceeding about 2 meq/L and pH exceeding about 7.5 can cause calcium carbonate precipitation.
2. Calcium concentrations exceeding 2 to 3 meq/L can cause precipitates to form during injection of some phosphate fertilizers. Special procedures are necessary for the injection of phosphate fertilizers, and careful injection should be attempted only by experienced personnel.
3. High concentrations of sulfide ions can cause iron and manganese precipitation. Iron and manganese sulfides are very insoluble, even in acid solutions. In this case, frequent acidification or the use of a settling basin for separating iron and manganese precipitants is advisable.
4. Irrigation water containing more than 0.1 ppm sulfides may encourage growth of sulfur bacteria within the irrigation system. Regular chlorination may be needed.
5. Chlorination when manganese is present should be used with caution, as a reaction time delay may occur between chlorination and the development of the precipitate. This may cause the manganese precipitate to form downstream of the filter and cause emitter clogging.

2000 ppm. Details for shock chlorination of wells are discussed in *Shock Chlorination Treatment for Irrigation Wells*, MF-2589, or contact your local well service provider. A well that has been shock chlorinated should be pumped to waste until the water clears. This water should never be sent through the SDI system because there will be large amounts of dislodged chemical and biological material from the well casing and screen. A simple Excel template to calculate the chlorine rate for chlorination of deep wells can be found at [www.oznet.ksu.edu/sdi/Software/SDISoftware.htm](http://www.oznet.ksu.edu/sdi/Software/SDISoftware.htm).

### SDI System Chlorination

Chlorination of the SDI system is also a practice that would be a routine maintenance procedure, because chlorine will oxidize biological material. Bacterial growth in driplines can be troublesome due to small clay particles in the water that are smaller than the required level of filtration. The sticky slime growth may cause these small particles to stick together and clog emitters.

Chlorine can be injected to kill bacteria either continuously with a low dosage base (0.5-1.5 ppm) or periodically at a high dose of 5 to 20 ppm. Periodic dosage is more common in Kansas systems. The dosage level should be sufficient that a concentration of 0.5 to 1 ppm of free chlorine should be measured at the end of the system. Chlorine is more effective in acid waters. High pH or alkaline waters should be acidified to a pH of 6.5 for effective chlorine treatment. Acid treatment also can be effective in controlling bacterial growth.

### Chlorine Injection Rate Formula

The general formula for calculating the amount of chlorine to

inject in liquid form (sodium hypochlorite, NaOC) is:

$$IR = Q \times C \times 0.006 \div S$$

where:

IR = Chlorine injection rate (gal/hour)

Q = Irrigation system flow rate (gal/min)

C = Desired chlorine concentration (ppm)

S = Strength of NaOC solution used (percent)

Common household bleach is generally a 5.25 to 7.5 percent solution. Stronger concentrations of chlorine solutions are available from irrigation dealers and industrial suppliers.

The injected chlorine must travel through the entire system during the injection period. The propagation time should be calculated or obtained from the installer. Alternatively, water from the flushline can be tested to see if a free chlorine residual is detected, which would indicate sufficient injection time has elapsed.

### Chemical Precipitation

Chemical precipitation hazard guidelines, as shown in Table 1, give some indication of potential clogging hazards. SDI systems have an advantage over surface drip systems because the emitter level in the driplines are below ground and buffered from sunlight and temperature that could help drive both biological and chemical activity. Water pH and temperature also play a major role in many reactions.

Several of the references listed at the end of this publication noted several important chemical precipitation hazards. These are summarized in Table 4.

### Calcium Carbonate

Calcium carbonate, commonly known as lime, can be a problem with high pH (>7.5) and high

bicarbonate levels (> 2 meq/L). The symptom of calcium precipitant is a white film or plating on the dripline or around the emitters or white precipitants in the flush water of the dripline laterals.

The usual treatment for calcium precipitation is to acidify the water by lowering the pH to 7.0 or lower with continuous injection. Calcium becomes more soluble at low pH. When using a periodic injection treatment, pH may have to be lowered to 4.0 or less and allowed to sit in the system for up to 60 minutes. Temperature, pH, and the calcium concentration affect calcium solubility, so conditions will vary throughout the system. Litmus paper, colorimetric kits, or a portable pH meter can measure the pH at the lower end of the system to determine if free chlorine exists.

Sulfuric acid or hydrochloric acid can be used to reduce pH. Muriatic acid (20 percent hydrochloric acid) may be the most commonly available acid from hardware or farm supply stores. Urea sulfuric acid, an acid with nitrogen fertilizer value, can also be used. This product is safer to use and is marketed as N-pHuric. Check with your irrigation or fertilizer dealer about its availability in your region. **Caution: Use extreme care in handling acids, and always add acid to water.** Be certain to flush and clean the injection system after an acid treatment because the acid may be corrosive to internal parts. Treatments need to be done before total emitter blockage occurs. Remediation, after total blockage, is difficult or impossible because the acid will not come into contact with precipitants in closed passages.

### Iron and Manganese

Iron and manganese precipitation can become a problem with concentrations as low as 0.1 ppm. Most groundwater contains some iron

and manganese in a soluble state, but when exposed to air, they oxidize and precipitate as a solid. Irrigators with center pivots, especially center pivots using alluvial groundwater supplies, often see the structures turn red in a short time. These compounds also can be used as an energy source by bacteria. They form filamentous slime that can clog filters and emitters, and act as a glue to hold other contaminants together.

Symptoms of iron precipitation are reddish stains and rust particles in the flush water and reddish deposits in the orifices. Manganese would be similar, but darker or

black. Bacterial slimes have a similar color as precipitants, but appear as filamentous sludge in flush water or collected on screens.

### Aeration and Settling for Iron and Manganese Treatment

One effective option for removal of high concentrations of iron and manganese for high flow rate systems is the use of aeration and settling basins, especially for manganese. The oxidation rate of manganese is much slower than for iron, making manganese removal problematic with some of the other treatment methods.

Aeration of the source water occurs by spraying water into the air or running it over a series of baffles to enhance mixing with oxygen into the water. There must be sufficient aeration and reaction time; the soluble forms of manganese and iron will oxidize and precipitate. The disadvantage of this treatment is the need for a second pump. Total head requirements are not changed when using two pumps, so energy costs are not a major factor. Other disadvantages of a settling basin are the space requirement, construction costs, and long-term maintenance needs.

**Table 5.** Water treatments to prevent clogging in drip-irrigation systems

Problem	Treatment Options
<b>Carbonate precipitation (white precipitate)</b> HCO <sub>3</sub> greater than 2.0 meq/l — pH greater than 7.5	<ol style="list-style-type: none"> <li>1. Continuous injection: maintain pH between 5 and 7</li> <li>2. Periodic injection: maintain pH at under 4 for 30 to 60 minutes daily</li> </ol>
<b>Iron precipitation (reddish precipitate)</b> Iron concentrations greater than 0.1 ppm	<ol style="list-style-type: none"> <li>1. Aeration and settling to oxidize iron. (Best treatment for high concentrations - 10 ppm or more).</li> <li>2. Chlorine precipitation - injecting chlorine to precipitate iron:               <ol style="list-style-type: none"> <li>a. use an injection rate of 1 ppm of chlorine per 0.7 ppm of iron</li> <li>b. inject in front of the filter so that the precipitate is filtered out</li> </ol> </li> <li>3. Reduce pH to 4 or less for 30-60 minutes daily.</li> </ol>
<b>Manganese precipitation (black precipitate)</b> Manganese concentrations greater than 0.1 ppm	<ol style="list-style-type: none"> <li>1. Inject 1 ppm of chlorine per 1.3 ppm of manganese in front of the filter</li> </ol>
<b>Iron bacteria (reddish slime)</b> Iron concentrations greater than 0.1 ppm	<ol style="list-style-type: none"> <li>1. Inject chlorine at a rate of 1 ppm free chlorine continuously or 10 to 20 ppm for 30 to 60 minutes daily.</li> </ol>
<b>Sulfur bacteria (white cottony slime)</b> sulfide concentrations greater than 0.1 ppm	<ol style="list-style-type: none"> <li>1. Inject chlorine continuously at a rate of 1 ppm per 4 to 8 ppm of hydrogen sulfide, or</li> <li>2. Inject chlorine intermittently at 1 ppm free chlorine for 30 to 60 minutes daily.</li> </ol>
<b>Bacterial slime and algae</b>	<ol style="list-style-type: none"> <li>1. Inject chlorine at a rate of 0.5 to 1 ppm continuously or 20 ppm for 20 minutes at the end of each irrigation cycle.</li> </ol>
<b>Iron sulfide (black sand-like material)</b> Iron and sulfide concentrations greater than 0.1 ppm	<ol style="list-style-type: none"> <li>1. Dissolve iron by injecting acid continuously to lower pH to between 5 and 7.</li> </ol>

Chlorination to control algae and bacteria in the basin may be required.

### Chlorination and Filtration for Iron and Manganese Treatment

Injection of chlorine into water will cause the dissolved iron to precipitate so it can be filtered out. The reaction occurs quickly, but injections need to be located upstream of the filter. This treatment method may be best suited for systems with sand media filters. Chlorine is injected at a rate of 1 ppm for each 0.7 ppm of iron. Additional chlorine may be required if other contaminants, such as iron bacteria, are present. This treatment requires continuous injection of chlorine. Successful treatment also requires complete mixing of the chlorine in the water.

This treatment method is not suited to manganese removal because of its slower oxidation rate. If manganese and free chlorine remain in the line after

filtration, precipitation could occur and clog emitters.

### pH Control

Iron is more soluble at lower pH, so acid can be used as a continuous or periodic treatment as described for calcium carbonate. In this case, the pH should be lowered to 2.0 or less for 30 to 60 minutes for a periodic or cleaning treatment. After a periodic treatment, the system must be flushed.

### Iron and Manganese Sulfides

Dissolved iron and manganese, in the presence of sulfides, can form a black, sand-like insoluble precipitant. The recommended treatment for this combination of compounds is continuous acid injection that lowers pH to between 5 and 7.

Sulfur slime also can be produced by bacteria that can oxidize hydrogen sulfide and produce elemental sulfur. The symptoms of this condition are white, cottony masses of slime that either clog emitters

directly or act as glue to collect small silt and clay particles that clump together and clog emitters.

### Treatment Summary

The symptoms and treatments for the various clogging hazards are summarized in Table 5.

Table 6 gives water quality data from the analysis of two irrigation water samples. Examples 1 and 2 in Table 6 use the water quality data from Table 1 to evaluate the clogging potential of these irrigation waters.

### Summary

Subsurface Drip Irrigation offers a number of agronomic production and water conservation advantages, but requires proper design, operation, and maintenance to be an efficient, effective, and long-lived irrigation system. One management change from the current irrigation systems is the need to understand the SDI system

**Table 6.** Water quality analysis of two irrigation water samples (After Hanson et al. 1997)

Water 1	Water 2
EC = 2.51 dS/m	EC = 0.87 dS/m
pH = 7.4	pH = 7.7
Ca = 306 ppm	Ca = 44 ppm
Mg = 121 ppm	Mg = 16 ppm
Na = 124 ppm	Na = 127 ppm
Cl = 158 ppm	Cl = 70 ppm
HCO <sub>3</sub> = 317 ppm	HCO <sub>3</sub> = 122 ppm
SO <sub>4</sub> = 912 ppm	SO <sub>4</sub> = 226 ppm
Mn = less than 0.1 ppm	Mn = 2.6 ppm
Fe = less than 0.1 ppm	Fe = 0.65 ppm

*Example 1.* The relatively high total dissolved salts (EC rating) indicates that *Water 1* has some clogging potential. This is verified by the relatively high bicarbonate concentration. The calcium concentration and the bicarbonate concentration together suggest that calcium carbonate could clog the emitters, particularly if the pH were to rise as a result of any chemical injection. The iron and manganese concentrations indicate little potential for clogging from precipitation of those elements.

*Example 2.* The analysis of *Water 2* reveals little potential for clogging from total dissolved salts (EC rating), but the pH and bicarbonate concentrations indicate that clogging might result from calcium carbonate precipitation. The levels of manganese and iron indicate a severe potential for clogging from manganese oxide precipitation and iron oxide precipitation.



sensitivity to clogging by physical, biological, or chemical agents.

Before designing or installing an SDI system, be certain a comprehensive water quality test is conducted on the source water supply. Once this assessment is complete, the manager should be aware of many of the potential problems that might be caused by the water supply. The adage “an ounce of prevention is worth a pound of cure” is very appropriate for SDI systems because early recognition of developing problems can prevent hardship. Developing problems can be easily handled as compared to remediation of a clogged system. While this may seem daunting at first, as with most new technology, managers will quickly become familiar with the system and its operational needs.

## References

- Burt, C.M. and S.W. Styles. 1994. *Drip and Microirrigation for Trees, Vines, and Row Crops* (with special sections on buried drip). Irrigation Training and Research Center, Cal Poly, San Luis Obispo, CA. 261 pgs.
- Clark, G.A., W.J. Lamont Jr, C.W. Marr, and D. H. Rogers. 1996. *Maintaining Drip Irrigation Systems: Commercial Vegetable Production bulletin*. MF-2178.

K-State Research and Extension. Manhattan, KS. 6 pgs.

Hanson, B., L. Schwankl, S.R. Grattan, and T. Prichard. *Drip Irrigation for Row Crops*. Water Management Series #93-05. University of California, Davis. Davis, CA. 175 pgs.

Hassan, F., 1998. *Micro-irrigation Management and Maintenance*. Agro Industrial Management. Fresno, CA. 233 pgs.

Hanson, B., Schwankl, L, Grattan, S., and Prichard, T. 1997. *Drip Irrigation for Row Crops*. Division of Agriculture and Natural Resources. Publication 3376. University of California, Davis. 238 pgs.

Rogers, D.H., F.R. Lamm, M. Alam and C.M. Powell. *Shock Chlorination treatment for Irrigation wells*. Water Quality Series Bulletin MF-2589. K-State Research and Extension. Manhattan, KS. 4 pgs.

Schwankl, L., B. Hanson, and T. Prichard. 1993. *Low-Volume Irrigation*. Water Management Series #93-03. University of California, Davis. Davis, CA. 116 pgs.

Van der Gulik, T.W. 1999. *B.C. Trickle Irrigation Manual*. B.C.

Ministry of Agriculture and Food. Abbotsford, B.C., Canada. 321 pgs.

## Additional Resources:

MF-2361, *Filtration and Maintenance Considerations for Subsurface Drip Irrigation (SDI) Systems*

MF-2242, *Economic Comparison of SDI and Center Pivots for Various Field Sizes*

MF-836, *Irrigation Capital Requirements and Energy Cost*

MF-2590, *Management Consideration for Operating a Subsurface Drip Irrigation System*

MF-2578, *Design Considerations for Subsurface Drip Irrigation (SDI) Systems*

MF-2576, *Subsurface Drip Irrigation (SDI) Components: Minimum Requirements*

Related K-State Research and Extension SDI Irrigation Web sites:

General Irrigation  
[www.oznet.ksu.edu/irrigate](http://www.oznet.ksu.edu/irrigate)

Mobile Irrigation Lab  
[www.oznet.ksu.edu/mil](http://www.oznet.ksu.edu/mil)

Subsurface Drip Irrigation  
[www.oznet.ksu.edu/sdi](http://www.oznet.ksu.edu/sdi)

**Acknowledgment:** This material is based upon work supported by the U.S. Department of Agriculture Cooperative State Research Service under Agreement No. 00-34296-9154. Any opinions, findings, conclusions or recommendations expressed in this publication are those of the authors and do not necessarily reflect the views of the U.S. Department of Agriculture.

Brand names appearing in this publication are for product identification purposes only. No endorsement is intended, nor is criticism of similar products not mentioned.

Publications from Kansas State University are available on the World Wide Web at [www.oznet.ksu.edu](http://www.oznet.ksu.edu)

Contents of this publication may be freely reproduced for educational purposes. All other rights reserved. In each case, credit Danny H. Rogers, Freddie R. Lamm, and Mahbub Alam, *SDI Water Quality Assessment Guideline*, Kansas State University, July 2003.

**Kansas State University Agricultural Experiment Station and Cooperative Extension Service**  
MF-2575 July 2003

It is the policy of Kansas State University Agricultural Experiment Station and Cooperative Extension Service that all persons shall have equal opportunity and access to its educational programs, services, activities, and materials without regard to race, color, religion, national origin, sex, age or disability. Kansas State University is an equal opportunity organization. Issued in furtherance of Cooperative Extension Work, Acts of May 8 and June 30, 1914, as amended. Kansas State University, County Extension Councils, Extension Districts, and United States Department of Agriculture Cooperating, Marc A. Johnson, Director.



# Irrigation System, Microirrigation (441-1)

**NATURAL RESOURCES CONSERVATION SERVICE  
CONSERVATION PRACTICE STANDARD**

**IRRIGATION SYSTEM, MICROIRRIGATION**

(No. and Ac.)

**CODE 441**

**DEFINITION**

An irrigation system for frequent application of small quantities of water on or below the soil surface: as drops, tiny streams or miniature spray through emitters or applicators placed along a water delivery line.

**PURPOSE**

This practice may be applied as part of a conservation management system to support one or more of the following purposes.

- To efficiently and uniformly apply irrigation water and maintain soil moisture for plant growth.
- To prevent contamination of ground and surface water by efficiently and uniformly applying chemicals.
- To establish desired vegetation

**CONDITIONS WHERE PRACTICE APPLIES**

On sites where soils and topography are suitable for irrigation of proposed crops and an adequate supply of suitable quality water is available for the intended purpose(s).

Microirrigation is suited to vineyards, orchards, field crops, windbreaks, gardens, greenhouse crops, and residential and commercial landscape systems. Microirrigation is also suited to steep slopes where other methods would cause excessive erosion, and areas where other application devices interfere with cultural operations.

Microirrigation is suited for use in providing irrigation water in limited amounts to establish desired vegetation such as windbreaks, living snow fences, riparian forest buffers, and

wildlife plantings.

This practice standard applies to systems with design discharge less than 60 gal/hr at each individual lateral discharge point.

Conservation Practice Standard 442, Irrigation System, Sprinkler applies to systems with design discharge of 60 gal/hr or greater at each individual lateral discharge point.

**CRITERIA**

**General Criteria Applicable to All Purposes**

The system shall be designed to uniformly apply water and/or chemicals while maintaining soil moisture within a range for good plant growth without excessive water loss, erosion, reduction in water quality, or salt accumulation.

Microirrigation systems consist of point-source emitter (drip, trickle, and bubbler), surface or subsurface line-source emitter, basin bubbler, and spray or mini sprinkler systems.

The system shall include all irrigation appurtenances necessary for proper operation. Appurtenances shall be sized and positioned in accordance with sound engineering principles and site-specific features.

Appurtenances include but are not limited to totalizing flow measurement devices, water filtration, air vent valves, vacuum relief valves, pressure relief valve(s), water control valve(s), pressure gauges, pressure regulators, and pressure reducers.

**Water Quality.** The irrigation water supply shall be tested and assessed for physical, chemical and biological constituents to determine suitability and treatment requirements for use in a microirrigation system.

**Emitter discharge rate.** The design discharge rate of applicators shall be determined based on manufacturer's data for expected operating conditions. The discharge rate shall not create runoff within the immediate application area.

For bubbler irrigation, a basin beneath the plant canopy shall be required for water control, and applications shall be confined to the basin area.

**Number and spacing of emitters.** The number and spacing of emitters along a lateral line shall be adequate to provide water distribution to the plant root zone and percent plant wetted area ( $P_w$ ). Procedures found in Reference 4 shall be used to calculate  $P_w$ .

**Operating pressure.** The design operating pressure shall be in accordance with published manufacturer recommendations. The system operating pressure must compensate for pressure losses through system components and field elevation effects.

**Emitter manufacturing variability.** The manufacturer's coefficient of variation ( $C_v$ ) shall be obtained and used to assess the acceptability of a particular product for a given application.

The  $C_v$  shall be less than 0.07 for point source emitters and less than 0.20 for line source emitters.

**Allowable pressure variations.**

Manifold and lateral lines. Manifold and lateral lines, operating at the design pressure, shall be designed to provide discharge to any applicator in an irrigation subunit or zone operated simultaneously such that they will not exceed a total variation of 20 percent of the design discharge rate. Internal pressure shall not exceed manufacturer recommendations during any phase of operation.

Main and submain lines. Main and submain lines shall be designed to supply water to all manifold and lateral lines at a flow rate and pressure not less than the minimum design requirements of each subunit. Adequate pressure shall be provided to overcome all friction losses in the pipelines and appurtenances (valves, filters, etc.). Mains and submains shall maintain flow velocities less than 5 ft/sec during all phases of operation, unless special consideration is

given to flow conditions and measures taken to adequately protect the pipe network against surge.

Main and submain lines shall be designed and installed according to criteria in reference 3.

**Emission Uniformity.** Pipe sizes for mains, submains, and laterals shall maintain subunit (zone) emission uniformity (EU) within recommended limits as determined by procedures contained in Reference 4.

**Filters.** A filtration system (filter element, screen, strainer, or filtration) shall be provided at the system inlet. Under clean conditions, filters shall be designed for maximum head loss of 5 psi. Maximum design head loss across a filter before cleaning shall be based on manufacturer recommendations. In the absence of manufacturer data maximum permissible design head loss across a filter is 7 psi before filter cleaning is required.

The filter shall be sized to prevent the passage of solids in sizes or quantities that might obstruct the emitter openings. Filtration systems shall be designed to remove solids based on emitter manufacturer recommendations. In the absence of manufacturer data or recommendations, filtration systems shall be designed to remove solids equal to or larger than one-tenth the emitter opening diameter.

The filter system shall provide sufficient filtering capacity so that backwash time does not exceed 10% of the system operation time. Within this 10% time period, the pressure loss across the filter shall remain within the manufacturer's specification and not cause unacceptable EU.

Filter/strainer systems designed for continuous flushing shall not have backwash rates exceeding 1.0% of the system flow rate or exceeding the manufacturer's specified operational head loss across the filter.

**Air/Vacuum relief valves.** Vacuum relief shall be designed and installed to prevent ingestion of soil particles if there are summits in system laterals.

Air/vacuum relief valves shall be installed on both sides of all block or manifold water supply control valves.

**Pressure regulators.** Pressure regulators shall be used where topography and the type of applicator dictate their use. Pressure regulators shall not be planned to compensate for improperly designed pipelines.

**System flushing.** Appropriate fittings shall be installed above ground at the ends of all mains, submains, and laterals to facilitate flushing. The system shall be designed and installed to provide a minimum flow velocity of 1 ft/sec during flushing. During flushing submain and manifold (pipelines located downstream from a control valve) velocities shall not exceed 7 ft/sec velocity. Each flushing discharge outlet shall include a pressure gauge and/or Schrader valve tap.

#### **Criteria Applicable to Efficiently and Uniformly Apply Irrigation Water**

**Depth of application.** Net depth of application shall be sufficient to replace the water used by the plant during the plant peak use period or critical growth stage. Gross depth of application shall be determined by using field application efficiencies consistent with the type of microirrigation system planned. Applications shall include adequate water for leaching to maintain a steady state salt balance.

**System capacity.** The system shall have either (1) a design capacity adequate to meet peak water demands of all crops to be irrigated in the design area, or (2) enough capacity to meet water application requirements during critical crop growth periods when less than full irrigation is planned. The rationale for using a design capacity less than peak daily irrigation water requirement shall be fully explained and agreed upon by the end user. Design capacity shall include an allowance for reasonable water losses (evaporation, runoff, and deep percolation) during application periods.

The system shall have the capacity to apply a specified amount of water to the design area within the net operation period. Minimum system design capacity shall be sufficient to deliver the specified amount of water in 90% of the time available, but not to exceed 22 hours of operation per day.

**Subsurface Drip Irrigation (SDI).** Tubing depth and spacing are soil and crop dependent. Emitter line depth shall consider the auxiliary irrigation methods used for

leaching, germination, and initial development. Maximum lateral line distance from the crop row shall be 24 inches for annual row crops and 48 inches for vineyard and orchard crops. EU shall be designed for a minimum of 85 percent.

#### **Criteria Applicable to Preventing Contamination of Ground and Surface Water**

**Chemigation and Chemical Water Treatment.** System EU shall not be less than 85 percent where fertilizer or pesticides, or treatment chemicals are applied through the system.

Backflow prevention devices shall be provided on all microirrigation systems equipped for chemical injection.

Injectors (chemical, fertilizer or pesticides) and other automatic operating equipment shall be located and installed in accordance with manufacturer's recommendations and include integrated back flow prevention protection.

Chemigation shall be accomplished in the minimum length of time needed to deliver the chemicals and flush the pipelines. Application amounts shall be limited to minimum amount necessary, and rate shall not exceed maximum rate recommended by chemical label.

Proper maintenance and water treatment shall be followed to prevent clogging based upon dripper and water quality characteristics.

Irrigation water supply tests shall be used to plan for addressing or avoiding chemical reactions with injected chemicals to prevent precipitate or biological plugging.

#### **Criteria Applicable to Establishing Desired Vegetation**

**System capacity.** The system shall have design capacity adequate to provide supplemental water at a rate that will insure survival and establishment of planned vegetation for a period of at least 3 years. The system shall have the capacity to apply the specified amount of water to the design area within the net operation period.

Gross application volume per plant shall be determined using field application efficiency consistent with the type of microirrigation

system planned. If a need is indicated by water test results, applications shall include adequate water for leaching to maintain a steady state salt balance.

Microirrigation systems installed solely to deliver supplemental water for establishment of windbreaks or riparian vegetation shall be designed to deliver a minimum of eight gallons per tree or shrub per week to assist in the establishment process. Design net application volumes per plant are dependent on the species of tree or shrub and the age (first, second, or third year).

Drip lateral lines installed on the ground surface shall be placed along the plant row(s) in a serpentine pattern to allow for expansion and contraction of the line while keeping the emitter close to the tree or shrub. Above ground drip line shall be pinned or anchored to prevent the line from being dislodged or moved away from the trees or shrubs.

Windbreaks shall be planned, designed, and installed according to NRCS, Conservation Practice Standard, Windbreak-Shelterbelt Establishment, Code 380.

When lateral emitter spacing or capacities vary with each row, the laterals must be designed separately.

Operation and maintenance items specific to vegetation establishment are included in Chapter 6 of reference.

## **CONSIDERATIONS**

In the absence of local experience field application efficiency (E) of 90% should be used to estimate system capacity.

In arid climates with subsurface systems natural precipitation and/or stored soil water is sometimes inadequate to provide crop germination. Special provisions should be made for germination (i.e. portable sprinklers), or the microirrigation system should apply water at a rate sufficient to adequately wet the soil to germinate seeds or establish transplants. The depth of subsurface systems on annual crops should be limited by the ability of the system to germinate seeds, unless other provisions are made for this function.

Potential rodent damage should be considered when selecting materials and deciding on above or below ground system installation.

## **NRCS, NHCP**

**August 2006**

Chemigation may or may not be required at the same time the plant requires irrigation, which may affect the economics of chemigation. Weather conditions should be considered before applying chemicals. Pest or nutrient management planning should address the timing and rate of chemical applications.

Field shape and slope often dictate the most economical lateral direction. Laying laterals down slope can allow for longer lateral run lengths and/or lateral size reduction. Uneven topography may require use of pressure compensating emitters.

For terrain slopes steeper than 5%, lateral lines should be laid along the field contour and pressure-compensating emitters specified or pressure control devices used along downslope submains at lateral inlets.

Economic assessments of alternative designs should include equipment and installation as well as operating costs.

Longer, less frequent irrigations of windbreaks during establishment are recommended to encourage deeper root development that increases drought tolerance.

Chemicals should not be applied if rainfall is imminent.

Installation and operation of microirrigation systems have the potential to save energy as a result of reduced seasonal irrigation application, and in some situations reduced operating pressures.

## **PLANS AND SPECIFICATIONS**

Plans and specifications for the microirrigation system shall be in keeping with this standard and shall describe the requirements for properly installing the practice to achieve its intended purpose.

## **OPERATION AND MAINTENANCE**

A site specific operation and maintenance (O&M) plan shall be developed and reviewed with the landowner/operator. The O&M plan shall provide specific instructions for operating and maintaining the system to ensure that it functions properly, including reference to periodic inspections and the prompt repair or replacement of damaged components. Operation and Maintenance Plan should

include but is not limited to:

- Install flow meter and monitor water application.
  - Clean or backflush filters when needed.
  - Flush lateral lines at least annually.
  - Check applicator discharge often; replace applicators as necessary.
  - Check operating pressures often; a pressure drop (or rise) may indicate problems.
  - Check pressure gauges to ensure proper operation; repair/replace damaged gauges.
  - Inject chemicals as required to prevent precipitate buildup and algae growth.
  - Check chemical injection equipment regularly to ensure it is operating properly.
- Check and assure proper operation of backflow protection devices.

## REFERENCES

1. Design and Installation of Microirrigation Systems, American Society of Agricultural Engineers (ASAE), ASAE EP405.1, February 2003.
2. National Engineering Handbook, Part 652, Irrigation Guide, 1996.
3. NRCS, Conservation Practice Standard Irrigation Water Conveyance, Pipeline, High Pressure Plastic, Code 430DD, 1988.
4. National Engineering Handbook, Part 623, Chapter 7, Trickle Irrigation, 1984.
5. National Engineering Handbook, Part 623, Chapter 2, Irrigation Water Requirements, 1993



# Subsurface Drip Irrigation Information on the Internet





## Subsurface Drip Irrigation Information on the Internet

*This list of references, though not exhaustive on the subject, has been assembled to aid the reader in accessing additional information on subsurface drip irrigation in agriculture. It was compiled by Extension Agricultural Engineer Dana Porter; it was updated in September 2007.*

### **Texas Cooperative Extension and Texas Agricultural Experiment Station**

Irrigation Research Reports, TAES-Lubbock/Halfway  
<http://lubbock.tamu.edu/irrigate/research/HelmsReports.html>  
<http://lubbock.tamu.edu/irrigate/research/byMethod.html>  
2001 Leaf Necrosis Problems in Drip-Irrigated Cotton Fields  
<http://lubbock.tamu.edu/cotton/2001leafnecrosis/necrosis.html>

### **Kansas State University Research and Extension**

Advantages and Disadvantages of Subsurface Drip Irrigation  
<http://www.oznet.ksu.edu/sdi/Reports/2002/ADofSDI.pdf>  
Subsurface Drip Irrigation Systems (SDI) Water Quality Assessment Guidelines  
<http://www.oznet.ksu.edu/library/ageng2/mf2575.pdf>  
Subsurface Drip Irrigation (SDI) Components: Minimum Requirements  
<http://www.oznet.ksu.edu/library/ageng2/mf2576.pdf>  
Design Considerations for Subsurface Drip Irrigation (SDI) Systems  
<http://www.oznet.ksu.edu/library/ageng2/mf2578.pdf>  
Filtration and Maintenance Considerations for Subsurface Drip (SDI) Systems  
<http://www.oznet.ksu.edu/library/ageng2/mf2361.pdf>  
Criteria for Successful Adoption of SDI Systems  
<http://www.oznet.k-state.edu/irrigate/OOW/P06/RogersSA06.pdf>

### **The Microirrigation Forum and Kansas State University**

Installation Issues for SDI Systems  
<http://www.microirrigationforum.com/new/archives/installsdi.html>  
Microirrigation Related Links <http://www.microirrigationforum.com/new/links/>

### **University of Florida Cooperative Extension**

Principles of Micro Irrigation <http://edis.ifas.ufl.edu/WI007>  
Treating Irrigation Systems with Chlorine <http://edis.ifas.ufl.edu/AE080>

### **Colorado State University Cooperative Extension**

Subsurface Microirrigation <http://www.ext.colostate.edu/pubs/crops/04716.pdf>

### **National Centre for Engineering in Agriculture University of Southern Queensland**

Drip Irrigation in the Australian Cotton Industry: A Scoping Study  
<http://www.ncea.org.au/Irrigation/downloads/Driplrrigation.pdf>

### **USDA-ARS Conservation and Production Research Laboratory- Bushland, Texas**

Crop production comparison under various irrigation systems  
<http://www.cprl.ars.usda.gov/wmru/pdfs/Colaizzi06.pdf>  
Cotton Response to Phosphorus Fertigation using Subsurface Drip Irrigation  
<http://www.cprl.ars.usda.gov/wmru/pdfs/Colaizzi%20sw6692.pdf>



# *Conservation Tillage*

## **In this Section**

Overview: Conservation Tillage

Reference: Best Management Practices for Conservation/Reduced Tillage (B-6189)

## **Overview**

### **Objectives:**

- Increase understanding of the benefits of conservation tillage.
- Increase understanding and application of best management practices.

### **Key Points:**

1. With conservation tillage, at least 30 percent of the soil surface is covered with crop residue after planting.
2. Maintaining residue on the soil surface increases water infiltration, reduces erosion, increases organic matter, reduces weed pressure, saves and reduces costs.
3. Best Management Practices with regard to soil compaction, fertilizer application, weed control, roller choppers, closing wheels, planting moisture, water, earthworms, stalk spreaders and narrow rows are essential to conservation tillage.



## *Conservation Tillage*

### **Assess your knowledge:**

1. Define conservation tillage and list its benefits.
2. Explain how organic matter affects soil compaction with regard to conservation tillage.
3. Describe how tillage affects weed control.
4. Explain how conservation tillage reduces runoff.
5. Discuss the implications of the best management practices for conservation tillage on corn, sorghum, cotton and wheat.



# Conservation Tillage

Because of increased crop production costs, most farmers have to re-evaluate how they till and consider conservation tillage practices. With conservation tillage, at least 30 percent of the soil surface is covered with crop residue after planting, which helps preserve soil moisture. Maintaining residue on the soil surface increases water infiltration, reduces erosion, increases organic matter and reduces weed pressure. Economic advantages also result from having less labor, less fuel, fewer repairs and less maintenance, better field accessibility, lower capital investment and lower equipment horsepower requirements.

## Fundamental Best Management Practices for Successful Conservation Tillage

### Soil compaction

The primary cause of compaction comes from heavy equipment traffic crushing air spaces out of moist soil. Top soils typically contain approximately 50 percent of pore space by volume. Pore space may be filled with water or air; so, when weight is applied to a moist soil, the soil aggregates are crushed, and some of the pore space is destroyed. Traffic patterns must be controlled, and proper tire pressure on equipment must be maintained. Generally, the potential for compaction increases as the percent of clay in the soil increases and as the organic matter content decreases. Reduced tillage leaves residue on the soil surface, which decreases the rate of decomposition and increases organic matter in the surface horizon.

### Fertilizer placement and application

Surface applications of fertilizer can result in nitrogen loss from volatilization and cause phosphorus and other immobile nutrients to accumulate near the soil surface. Nutrient deficiencies are likely to occur in no-till or stale seed beds.

Because placement and timing of phosphorus applications are important, the following practices are recommended:

- Phosphorus should be applied before or at planting to ensure that it is available early in the season.
- In corn and sorghum production, it is important to apply a starter fertilizer or place all phosphorus fertilizer close to the developing seedling to prevent nutrient deficiencies.
- Where a starter or a well-placed high-phosphate fertilizer is used, grain crops grow better and mature faster although yields may not be higher. This is also true if you use a pop-up, or seed placed fertilizer, that is applied directly to the seed.
- While pop-ups have not helped cotton, they are more likely to increase yield and to establish stands quickly in grain crops. The amount of phosphorus in the pop-up should be subtracted from the total amount that is needed for the crop to prevent over-fertilization.
- To slow stratification, phosphorus and other immobile nutrients should be banded 5 to 6 inches below the surface where possible. Placing the nutrient close to the planted row will also increase fertilizer efficiency.



# Conservation Tillage

## Weed control

Weeds compete with the crop for moisture, fertilizer and light and can be greatly reduced if the soil is not tilled. It is easier and generally better to control weeds under no-till and reduced tillage systems. These are some other practices that help with weed control:

- Use herbicides in the winter and during the growing season.
- Applying transgenic technology, such as Roundup Ready® and LibertyLink® products, has made conservation tillage much easier.
- A hooded sprayer is important for weed control in sorghum (particularly for grass control) and in cotton (for lay-by applications of herbicides).
- Pre-emergence herbicides are still important. Weed control before planting prevents weeds from depleting valuable soil moisture and from creating a haven for insects.

## Roller choppers or rolling stalk choppers

Stalk choppers are found to be more effective in continuous cotton crops or where ridge-tillage is done farther north in Texas. The stalks are left standing all winter and spring to protect the soil against wind erosion, and are chopped in late winter or early spring when beds are remade. These choppers proved to be of no extra benefit in no-tillage in south Texas. They were ineffective in breaking surface compaction, but did a good job of chopping residue. Residue managers on the planter adequately removed un-chopped stalks at planting time.

## The closing wheels or closing system

Using closing wheels or a closing system on the planter might mean the difference between a good stand and a poor stand. Because of varying conditions at planting, you should have several types of closing wheels. Schlegel Manufacturing wheels and closely spaced spiked closing wheels have been the most effective in tests with loose soil under most planting conditions.

It is important to break any side wall compaction caused by disc openers, to firm the seed in the bottom of the seed trench and to leave the surface slightly roughened to prevent crusting and baking. The seed must be firmed into moist soil and properly covered (as with conventional tillage) to achieve a good stand. Double disc planters tend to leave smooth, slick side walls that reduce root penetration.

## Planting moisture

If a small bed is made before the onset of winter, moisture should be more consistent at planting time. You can then use a bed to remove dry soil and will not need to plant “in a hole” to find moisture.



## *Conservation Tillage*

Make sure the bed is not a high ridge, but rather only a low, rolling hump formed without burying residue. Meanwhile, keep the bed covered with as much residue as possible. Flat planting and “busting out” the dry soil on the surface to get to moisture will cause deep planting in a trench. It also will bury the seed if a heavy rain comes before stand establishment. Try to maintain as much residue on the surface as possible to increase water penetration.

### **Water**

Covering the soil with residue rather than tilling it clean improves water infiltration. The impact of rain on base soil destroys small aggregates, or clods, causing the soil to seal over. Residue breaks the impact of rain drops, “wicks” or moves moisture into the soil, and reduces runoff.

### **Earthworms**

Just because a field is under conservation-tillage does not automatically mean you will have a large number of earthworms, which can do a tremendous amount of tillage. Their populations rise and fall with moisture, number of roots and amount of organic matter (their food source) in the soil. Water soaks into the soil through worm tunnels, which also helps soil gas exchanges.

### **Stalk spreaders**

Stalk spreaders are important for distributing the residue rather than pushing it into wind rows. This is particularly true for combines with larger headers, but less important for smaller combines.

### **Narrow rows**

Making rows 30 inches instead of 38 to 40 inches can help shade the soil faster (close the crop canopy faster) and reduce weed growth. In research around the state, sorghum yields have consistently been higher with narrow rows.



# Best Management Practices for Conservation/Reduced Tillage (B-6189)

# Best Management Practices for Conservation/Reduced **TILLAGE**

Charles Stichler, Archie Abrameit  
and Mark McFarland\*

**F**arming today requires producers to employ best management practices (BMPs) to be successful. Because of increased crop production costs, most farmers have to re-evaluate how they till and consider adopting reduced or conservation tillage practices.

*Conservation tillage does not mean never till.* Some tillage is not bad if it is necessary, but unnecessary trips across the field are costly — often in more ways than one. Maintaining residue on the soil surface increases water infiltration, reduces erosion, increases organic matter, reduces weed pressure, saves time and reduces costs.

There is no specific formula for success, and the BMP that works best in one area or on one farm may not necessarily work somewhere else. In 1995 we began evaluating different tillage systems in south central Texas at the Luling Foundation Farm (LFF). Crop failures and poor crop performance have demonstrated since then what practices are inappropriate for the region, while other BMPs have proven to be profitable. In addition, cooperation with innovative producers in the region has been invaluable in reducing the time needed to determine appropriate practices.

\*Extension Agronomist, Extension Specialist-Stiles Farm Foundation Manager, and Extension Soil Fertility Specialist, respectively, The Texas A&M University System.

## Tillage Systems

To explain the results of our LLF trials and the differences among tillage practices, we use the following terms:

- **Conventional tillage** leaves less than 15 percent residue cover after planting through intensive tillage.
- **Conservation tillage (con-till)** covers 30 percent or more of the soil surface with crop residue after planting.
- **Reduced-till** leaves 15 to 30 percent residue cover after planting.
- **No-till** leaves the soil undisturbed from harvesting to planting except for nutrient injection. Planting and fertilization are done with row cleaners and slits in the soil for placing seed and nutrients. Weeds are controlled with herbicides except when doing emergency weed control.
- **Ridge-till (stale seed bed)** leaves the soil undisturbed from harvesting to planting except for nutrient injection, but rows are rebuilt during cultivations for next year's crop. Permanent rows and traffic patterns are important to the success of this system.
- **Mulch-till** disturbs the soil before planting with chisels, field cultivators, disks or sweeps. Weeds are controlled by cultivation/and or herbicides.



- ♦ **Strip-till and zone-till** are not separate systems, but are variations of systems. A fertilizer knife or mole knife is typically run in the row in the fall, early winter or late spring to loosen the soil and inject fertilizer. The soil usually is tilled with sweeps or disks over the row only, leaving the soil in between the rows untilled. The width of the tilled area can vary, and a bed may or may not be formed.

Performing strip-till or zone-till occasionally is the best compromise between conventional tillage and no-till. Yield with these systems is comparable to that of conventional tillage — without the cost.

## Fundamental BMPs for Successful Con-till

In our experiments, we have not documented increased yields from con-till compared to conventional tillage, but there are economic advantages. These come from having less labor, less fuel, fewer repairs and less maintenance, better field accessibility, lower capital investment and lower horsepower equipment. The way we have dealt with specific challenges to crop production have led to a BMP system that fits the LLF operation and may help producers elsewhere in implementing their own practices.

### Soil compaction

This is one of the reasons soil is tilled. While most producers worry about soil compaction, their concern is often unwarranted because compaction does not exist in most fields. *The primary cause of compaction comes from heavy equipment traffic crushing air spaces out of moist soil.* (See “Recommended Reading” on page 6.)

Top soils typically contain approximately 50 percent of pore space by volume. Pore space may be filled with water or air; so, when weight is applied to a moist soil, the soil aggregates are crushed, and the pore space is destroyed. Traffic patterns must be controlled, and proper tire pressure on equipment must be maintained. Generally, the potential for compaction increases as the percent of clay in the soil increases and as the organic matter content decreases.

Organic matter absorbs water like a sponge, provides nutrients as it decomposes and reduces the bulk density (or weight per volume) of soil. Tillage mixes, oxygenates and buries crop residue, resulting in maximum decomposition under warm, moist conditions. Reduced tillage, however, leaves residue on the soil surface, which decreases the rate of decomposition and increases organic matter in the surface horizon.

*A second type of compaction occurs slowly over time in clay soils that receive more than 30 inches of annual rainfall.* Because of their small size, clay particles begin to fill the pore space, which increases bulk density. Soils at the LFF site are 50 percent or more clay, and we had to deal with naturally occurring soil compaction in the seed drill zone because no tillage had been done in 3 years. Organic matter appeared to decompose rapidly in the planting zone, which resulted in very dense, firm soil in the top 4 inches.

*Rotational tillage*, where the soils are tilled every second or third season, or strip or zone tillage will eliminate this problem. In areas with less clay and lower rainfall, compaction does not seem to be a problem, and the topsoil horizon actually becomes more mellow with time.

### Fertilizer placement and application

These practices are more difficult to accomplish in con-till than in conventional tillage, which is another justification for rotational tillage. Surface applications of fertilizer can result in nitrogen loss from volatilization and cause phosphorus and other immobile nutrients to accumulate near the soil surface. Nutrient deficiencies are likely to occur in no-till or stale seed beds, where crops are planted into the same row each year. Rotational tillage with a chisel plow will break up soil firmness in the top 6 inches and may replace a herbicide application.

Because *placement and timing of phosphorus applications are important*, we recommend the following practices:

- ♦ Phosphorus should be applied *before or at* planting to ensure that it is available early in the season. Most producers prefer a smooth coulter with fertilizer sprayed into the coulter slit or a strip-till unit.

- In corn and sorghum, it is important to apply a starter fertilizer or place all phosphorus fertilizer close to the developing seedling to prevent nutrient deficiencies. However, you must *keep excessive nitrogen away from developing seedlings to prevent possible salt injury*. (Nitrogen can be side-dressed easily with a coulters/knife or coulters/spray.)
- Where a starter or a well-placed high-phosphate fertilizer is used, grain crops grow better and mature faster although yields may not be higher. If all the fertilizer is banded 2 or 3 inches from the seed at planting, there should be no delays in crop development.
- This is also true if you use a *pop-up*, or seed-placed fertilizer, that is applied directly to the seed. Pop-up fertilizer applications of 10-34-0 or 11-37-0 in the seed drill at rates of about 5 to 7 gallons per acre or less are an option.
- While pop-ups have not helped cotton, they are more likely to increase yield and to establish stands quickly in grain crops. The amount of phosphorus in the pop-up should be subtracted from the total amount that is needed for the crop to prevent over-fertilization. This is because the nutrients are *not in addition to* the normal fertility amounts and because they minimize total fertilizer costs. *Do not use fertilizer on the seed in sandy soils because injury is likely.*
- Phosphorus, potassium and many micronutrients (such as zinc and copper) are immobile in the soil and tend to remain very near the point of placement. In reduced-till and no-till systems, repeated surface applications of these nutrients with little or no incorporation can lead to *stratification*. This process involves the build-up of nutrients in the upper 2 to 3 inches of soil, where they may have very limited availability to plant roots — especially under dry land conditions. This is particularly a problem in heavy-textured soils that contain clay.
- To slow stratification, phosphorus and other immobile nutrients should be banded 5 to 6 inches below the surface where possible. Placing the nutrient close to the planted row will also increase fertilizer efficiency. Using rota-

tional tillage also may be necessary to incorporate surface-bound nutrients from organic matter decomposition and improve their availability to plants.

### Weed control

Weeds compete for moisture, fertilizer and light and can be greatly reduced if the soil is not tilled. This is because tillage brings weed seeds continually to the surface, where they readily germinate with any rain. We have found that it is easier and generally better to control weeds under no-till and reduced tillage systems.

These are some other BMPs that help with weed control:

- Use herbicides in the winter and during the growing season.
- Applying transgenic technology, such as Roundup Ready® and LibertyLink® products, has made no-till and reduced-till much easier. Using these and other herbicides is essential for good weed control and prevention of resistant weeds.
- A hooded sprayer is important for weed control in sorghum (particularly for grass control) and in cotton (for lay-by applications of herbicides).
- Pre-emergence herbicides are still important. Weed control before planting prevents weeds from depleting valuable soil moisture and from creating a haven for insects. For example, wireworms may attack seed prior to stand establishment, and cutworms may damage a crop upon emergence. Following several years of no-till, weed populations may shift to those weeds that compete better under these conditions.

### Roller choppers or rolling stalk choppers

We have found stalk choppers to be more effective in continuous cotton crops or where ridge-till is done farther north in Texas. The stalks are left standing all winter and spring to protect against winds, and are chopped in late winter or early spring when beds are remade. These choppers proved to be of no extra benefit in no-till and reduced-till in south Texas. They were ineffective in breaking surface compaction, but did a good job of chopping residue. Residue managers on the planter adequately removed un-chopped stalks at planting time.

## The closing wheels or closing system

Using closing wheels or a closing system on the planter is *very important*. It might mean the difference between a good stand and a poor stand. Because of varying conditions at planting, you should have several types of closing wheels. Schlagel Manufacturing wheels and closely-spaced spiked closing wheels have been the most effective in tests with loose soil under most planting conditions.

We also found it is important to break any side wall compaction caused by disc openers, to firm the seed in the bottom of the seed trench and to leave the surface slightly roughened to prevent crusting and baking. The seed must be firmed into moist soil and properly covered (as with conventional tillage) to achieve a good stand. Double disc planters tend to leave smooth, slick side walls that reduce root penetration.

## Planting moisture

If a small bed is made before the onset of winter, when soil moisture normally accumulates, moisture should be more consistent at planting time. You can then use a bed to remove dry soil and will not need to plant “in a hole” to find moisture.

Make sure the bed is not a high ridge, but rather only a low, rolling hump formed without burying residue. Meanwhile, keep the bed covered with as much residue as possible. Flat planting and “busting out” the dry soil on the surface to get to moisture will cause deep planting in a trench. It also will bury the seed if a heavy rain comes before stand establishment. Try to maintain as much residue on the surface as possible to increase water penetration.

## Water

Covering the soil with residue rather than tilling it clean improves water infiltration. The impact of rain on base soil destroys small aggregates, or clods, causing the soil to seal over. Residue breaks the impact of rain drops, “wicks” or moves moisture into the soil, and reduces runoff.

## Earthworms

Just because a field is under con-till does not automatically mean you will have a large number of earthworms, which can do a tremendous amount of tillage. Their populations rise and fall with the

moisture, number of roots and amount of organic matter (their food source) in the soil. Water soaks into the soil through worm tunnels, which also helps soil gas exchanges. There are fewer earthworms in conventional till plots because planting can kill them and because soil organic matter rapidly decomposes.

## Controlled traffic patterns

To prevent compaction in the seed or planting zone, controlled traffic patterns in fields are essential. Driving on moist soil causes compaction, so you need to avoid crushing the soils. Once compaction has occurred, tillage may be necessary to break up compacted zones or areas.

## Stalk spreaders

Stalk spreaders are important for distributing the residue rather than pushing it into wind rows. This is particularly true for combines with larger headers, but less important for smaller combines.

## Narrow rows

Making rows 30 inches instead of 38 to 40 inches can help shade the soil faster and reduce weed growth. In research around the state, particularly at Temple, sorghum yields have consistently been higher with narrow rows.

## Results of BMPs

Our findings have shown us that it is extremely important to consider the effect of a single management practice 3, 4 or 6 months into the future. We have seen this principle at work with various crops and have learned that, as in any production system, the crop must be properly established to a good stand and be properly fertilized. Then, to harvest a good crop, weeds must be controlled.

## Corn

Of the crops we are producing, corn is the easiest to grow. It responds well to no-till for several years, but clay soils do get firm by then and must be loosened occasionally by tillage (e.g., strip till unit, ripper-hipper or some kind of in-row tillage).

Our research has also showed us the following:

- The corn seed is large, which results in better stand establishment under less than opti-

mum conditions. It is planted early, and soil moisture at planting is generally good. Corn can be planted flat — without beds — where fields contain a lot of residue, rainfall is sufficient, and where spring moisture is usually not a problem.

- Corn is planted earlier when soils are generally wetter and the crop is finished before the onset of summer heat. LLF trials have shown that corn is most profitable under no-till, followed by reduced till, and is least profitable when conventionally tilled.
- More herbicides are available for corn than for any other crop. We found the Roundup Ready® varieties yield the same as the non-transgenic herbicides, and that weed control is simple. Without herbicide rotation and pre-emergence application, however, grasses and weeds or such species as morning glory and copperleaf will become a problem.
- In wetter regions (east and north of San Antonio and near the coast), you do not need to shred down stalks if you use residue managers on the planter or use a pre-planting rig, such as a fertilizer applicator. Corn roots, crowns and stalks decompose faster than sorghum, and it is easier to plant into them than it is to plant into sorghum. In the coastal regions where rainfall can be heavy and water runoff is significant, shredded residue will float off after a lot of rain. The option is to shred and incorporate the stalks into stale beds if they are not left standing.

However, in the dryer areas west of San Antonio where residue does not decay as rapidly, shredding the stalks will lay them on the soil surface and provide the essential mulch cover. It also reduces problems such as stalks sticking up into the planter and knocking off chains. A flail shredder works best for this.

## Sorghum

This crop is the next easiest one for getting a stand. These are some of the results from our tests:

- Sorghum seed is smaller, must be planted more shallow and is planted shortly after corn.

- There is little difference in yields of sorghum among the three tillage treatments.
- The profitability of sorghum is a problem. Unless the yield is approximately 4,000 pounds per acre or more and input costs are minimized, the crop will not be profitable — even under reduced tillage. However, it still is a good rotational crop for corn and cotton. In hot, dry years when aflatoxin is a problem in corn, sorghum has a market.
- It is important to kill the sorghum with glyphosate *before or soon after* harvest so the crowns will begin to rot. If the plant survives until fall and the winter is dry, the sorghum crown is usually intact by planting time in the spring and is difficult to move with residue managers. Cotton root rot can survive on live sorghum roots, so it is important to kill the sorghum plant as soon as possible to stop the disease.
- Sorghum stalks decay much more slowly than corn stover, but shredding will cause them to deteriorate more rapidly. Shredding the stalks will lay them on the soil surface and provide the essential mulch. It helps keep stalks from sticking up into the planter and knocking off chains, for example. As we found with our corn stalks, a flail shredder works best for this. In the coastal regions where it rains a lot and shredded residue will float off after heavy rains, you can shred and incorporate the stalks into stale beds if they are not left standing.
- Most producers plant too many sorghum seed per acre. Plant populations in the 60,000 to 70,000 range are best on a 30- to 40-inch row spacing. Research in San Patricio County and Temple continues to show increased yields with narrow 30-inch row spacing.

## Cotton

This crop is more difficult to establish in no-till unless conditions are optimum. Here are highlights from our studies:

- Because it requires warm soil for germination, cotton is planted later. If spring rain is late, the soil might become hard, and the moisture will be deep on flat-planted no-till.

- A bed or ridge is important for cotton. Therefore, you need to create a bed with ridge-till or even conventional-till.
- With rows, it is easier to push aside dry soil to reach available moisture. However, a tall, hipped row reduces water infiltration and drains water from fields. A high row with no residue on the soil surface becomes an excellent drainage ditch. Rain sheets off the bed and runs off.
- A row is important for cotton. When planted in a hole, rain may wash soil on top of the seed and bury it too deep. Also, when planted flat, lower bolls may not be picked up and are left in the field at harvest.
- The economics of cotton production have shown there is little difference among the no-till, reduced-till and conventional tillage treatments.

## Wheat

Wheat is an excellent rotational crop and is one in which we do some rotational tillage. During the fallow period, it is also an excellent crop for cleaning up perennial weed problems, such as Johnsongrass and morning glory.

We recommend these as BMPs when growing wheat:

- Spray weeds after harvest to conserve moisture and avoid weed problems. Any time the soil is disturbed, it helps weed seed germinate and creates a continuous cycle of tillage and weed growth.
- Tillage can be delayed until rows are bedded in late fall and are sprayed during the winter to capture and hold as much water as possible.
- Leaving stubble on the soil surface keeps the soil from sealing over so that it remains porous and absorbs water.

- When following wheat, soil should be disturbed as little as possible so that the soil can be prepared for planting with a conventional grain drill. If a no-till drill is too expensive, tillage can be done with a chisel plow, field cultivator or disk when the soil is dry.

## BMPs and Conventional Tillage

Conventional tillage is changing. Over the years, most producers in the LLF area have reduced the amount of tillage in conventional plots by eliminating mold board plowing. We are trying to use best management practices such as these within each tillage system:

- With the adoption of Roundup Ready® technology, even in the conventional-till plots, we are substituting herbicide applications for some tillage to kill weeds, particularly early in the season. Late-season tillage with, for example, a chisel plow or a disk when soils are dry will replace herbicide applications. As a result, the economic differences in production costs are not as great.
- Summer fallow behind wheat is best accomplished with glyphosate rather than tillage. The soil is protected, weeds are controlled and weed seed are not disturbed for germination.
- Herbicides have replaced tillage as the preferred choice for winter weed control. Unlike tillage, herbicide applications can be made in wetter conditions and will not bring up weed seed. This practice also conserves moisture.

## Recommended Reading

“Management to Minimize and Reduce Soil Compaction.” Nebraska Cooperative Extension, G89-896.

“Soil Compaction — The Silent Thief.” University of Missouri, Bulletin G1630.

The information given herein is for educational purposes only. Reference to commercial products or trade names is made with the understanding that no discrimination is intended and no endorsement by Texas Cooperative Extension is implied.

Produced by Agricultural Communications, The Texas A&M University System  
Extension publications can be found on the Web at: <http://tcebookstore.org>; Visit Texas Cooperative Extension at <http://texasextension.tamu.edu>

Educational programs conducted by Texas Cooperative Extension serve people of all ages regardless of socioeconomic level, race, color, sex, religion, handicap or national origin.

Issued in furtherance of Cooperative Extension Work in Agriculture and Home Economics, Acts of Congress of May 8, 1914, as amended, and June 30, 1914, in cooperation with the United States Department of Agriculture. Edward G. Smith, Director, Texas Cooperative Extension, The Texas A&M University System. 3M, New

# *WATER QUALITY ISSUES*



## **Salinity Management**

**Protecting Water Resources from Contamination**



# Salinity Management

## In this Section

Overview: Salinity Management

Reference: Irrigation Water Quality Critical Salt Levels for Peanuts, Cotton, Corn and Grain Sorghum (L-5417)

Reference: Irrigation Water Quality Standards and Salinity Management Strategies (B-1667)

Reference: Irrigation Salinity Management Information on the Internet

## Overview

### Objectives:

- Increase familiarity with terminology and interpretation of water quality analysis and soil salinity analysis reports.
- Increase understanding of how salts affect soils and plants.
- Apply these concepts to management of lightly to moderately saline water in crop production.

### Key Points:

1. Salts occur naturally in water. The concentrations and specific ion species depend upon the water source. Some groundwater sources can have naturally high levels of some salts.
2. Some salts can affect soil properties or can interfere with availability of plant essential nutrients.
3. Salt accumulation in the root zone can hurt soil productivity.
4. Some salts in high concentrations can be toxic to plants.
5. Plants' susceptibility to salt injury may vary with growth stage.
6. Leaching of salts is often recommended for removing excess accumulations from the root zone. This requires sufficient water; it may be facilitated with soil additives, depending upon the specific salt species.
7. Irrigation methods that limit leaf wetting may reduce risk of foliar salt injury.



# *Salinity Management*

## **Assess your knowledge:**

1. What is meant by each of the following acronyms? What are the common units of measure for each? What is the significance of each?

SAR

EC

TDS

ESP

2. Rank the following crops according to their relative tolerance to soil salinity (EC).

\_\_\_\_\_ barley      \_\_\_\_\_ corn      \_\_\_\_\_ cotton      \_\_\_\_\_ sorghum

3. What are the criteria for describing a soil as sodic? Saline?
4. Why are sodium salts of particular concern for irrigation management?
5. How can fertilizers or composts contribute to a salinity problem?





# Salinity Management

One of the most common water quality concerns for irrigated agriculture is salinity. Recommendations for effective management of irrigation water salinity depend upon local soil properties, climate, and water quality; options of crops and rotations; and irrigation and farm management capabilities.

## What Is Salinity?

All major irrigation water sources contain dissolved salts. These salts include a variety of natural occurring dissolved minerals, which can vary with location, time, and water source. Many of these mineral salts are micronutrients, having beneficial effects. However, excessive total salt concentration or excessive levels of some potentially toxic elements can have detrimental effects on plant health and/or soil conditions.

The term “salinity” is used to describe the concentration of (ionic) salt species, generally including: calcium ( $\text{Ca}^{2+}$ ), magnesium ( $\text{Mg}^{2+}$ ), sodium ( $\text{Na}^+$ ), potassium ( $\text{K}^+$ ), chloride ( $\text{Cl}^-$ ), bicarbonate ( $\text{HCO}_3^-$ ), carbonate ( $\text{CO}_3^{2-}$ ), sulfate ( $\text{SO}_4^{2-}$ ) and others. Salinity is expressed in terms of **electrical conductivity (EC)**, in units of millimhos per centimeter (mmhos/cm), micromhos per centimeter (mmhos/cm), or deciSiemens per meter (dS/m). The electrical conductivity of a water sample is proportional to the concentration of the dissolved ions in the sample; hence EC is a simple indicator of total salt concentration.

Another term frequently used in describing water quality is **Total Dissolved Solids (TDS)**, which is a measure of the mass concentration of dissolved constituents in water. TDS generally is reported in units of milligrams per liter (mg/l) or parts per million (ppm). Specific salts reported on a laboratory analysis report often are expressed in terms of mg/l or ppm; these represent mass concentration of each component in the water sample. Another term used to express mass concentration is normality; units of normality are milligram equivalents per liter (meq/l). The most common units used in expressing salinity are summarized in Table 1.

\* Compiled by Dana Porter, PhD, PE, Department of Biological and Agricultural Engineering and Texas A&M AgriiLife Research and Extension Center – Lubbock. This section is adapted from Porter, Dana and Thomas Marek. 2006. *Irrigation management with Saline Water*. 2006. In: *Proceedings of the 2006 Central Plains Irrigation Conference*, Colby, KS, February 21-22, 2006.



# Salinity Management

Table 1. Units commonly used to express salinity\*

<p><u>Mass Concentration (Total Dissolved Solids):</u>  mg/l = milligrams per liter  ppm = parts per million  ppm @ mg/l</p>
<p><u>Electrical Conductivity (increases with increasing TDS):</u>  conductivity = 1/resistance expressed as “mho = 1/ohm = 1 Siemens”  millimhos/cm = millimhos per centimeter  mmhos/cm = micromhos per cm  dS/m = deciSiemens per meter  1 dS/M = 1 mmho/cm = 1000 mmho/cm</p>
<p><u>Salinity Conversions:</u>  0.35 X (EC mmhos/cm) = osmotic pressure in bars  651 X (EC mmhos/cm) = TDS in mg/l*  10 X (EC mmhos/cm) = Normality in meq/l  0.065 X (EC mmhos/cm) = percent salt by weight</p> <p>* Also has been related as:  TDS (mg/l) = EC (dS/m) X 640 for EC &lt; 5 dS/m  TDS (mg/l) = EC (dS/m) X 800 for EC &gt; 5 dS/</p>
<p><u>Normality</u>  meq/l = milligram equivalents per liter (aka milliequivalents per liter)  meq/l = mg/l , equivalent weight  equivalent weight = atomic weight , electrical charge</p>
<p>* Compiled from various sources</p>

**Example:** To convert 227 ppm calcium concentration to meq/l:

- ppm = mg/l; therefore 227 ppm = 227 mg/l
- Calcium atomic weight = 40.078 g/mol
- valence: +2 (charge = 2)
- equivalent weight = 40.078 / 2 = 20.04
- meq/l = 227 / 20.04 = 11.33
- Therefore 227 mg/l = 11.33 meq/l for calcium.



# Salinity Management

## Why Is Salinity a Problem?

High salinity in water (or soil solution) causes a high osmotic potential. In simple terms, the salts in solution and in the soil “compete” with the plant for available water. Some salts can have a toxic effect on the plant or can “burn” plant roots and/or foliage. Excessive levels of some minerals may interfere with relative availability and plant uptake of other micronutrients. Soil pH, cation exchange capacity (CEC) and other properties also influence these interactions.

High concentration of sodium in soil can lead to the dispersion of soil aggregates, thereby damaging soil structure and interfering with soil permeability. Hence special consideration of the sodium level or “sodicity” in soils is warranted.

## How Do You Know if You Have a Salinity Problem?

Water and soil sampling and subsequent analysis are key to determining whether salinity will present a problem for a particular field situation. If wastewater or manure is applied to a field regularly, or if the irrigation water source varies in quality, soil salinity should be monitored regularly for accumulation of salts.

Water quality and soil chemical analyses are necessary to determine which salts are present and the concentrations of these salts. Standard laboratory analyses include total salinity reported as electrical conductivity (EC) or as Total Dissolved Solids (TDS). Salinity indicates the potential risk of damage to plants. General crop tolerances to salinity of irrigation water and soil are listed in Table 2. These values should be considered only as guidelines, since crop management and site specific conditions can affect salinity tolerance.

*Table 2. Tolerance\* of selected crops to salinity in irrigation water and soil.*

Crop	Threshold EC in irrigation water in mmhos/cm or dS/m		Threshold EC in soil (saturated soil extract) in mmhos/cm or dS/m	
	0% yield reduction	50% yield reduction	0% yield reduction	50% yield reduction
Alfalfa	1.3	5.9	2.0	8.8
Barley	5.0	12.0	8.0	18.0
Bermudagrass	4.6	9.8	6.9	14.7
Corn	1.1	3.9	1.7	5.9
Cotton	5.1	12.0	7.7	17.0
Sorghum	2.7	7.2	6.8	11.0
Soybean	3.3	5.0	5.0	7.5
Wheat	4.0	8.7	6.0	13.0

\* After Rhoades, et.al. (1992); Fipps (2003) and various sources.



# Salinity Management

Additional information, including concentrations of specific salt components, indicates the relative risk of sodicity and toxicity. High sodium can present a risk of toxicity to plants. It can also indicate a risk of soil aggregate dispersion, which can result in breakdown of soil structure, and hence reduce the soil's permeability. Relative risk of soil damage due to sodicity is indicated by the **Sodium Adsorption Ratio (SAR)**, which relates the relative concentration of sodium [Na<sup>+</sup>] compared to the combined concentrations of calcium [Ca<sup>+</sup>] and magnesium [Mg<sup>+</sup>]. SAR is calculated by the following equation:

$$\text{SAR} = \frac{[\text{Na}^+]}{([\text{Ca}^+] + [\text{Mg}^+]) / 2}^{1/2}$$

## Managing Irrigation to Mitigate Salinity

### Minimize Application of Salts

An obvious, if not simple, option to minimize effects of salinity (when dealing with saline irrigation water) is to minimize irrigation applications and the subsequent accumulation of salts in the field. This can be accomplished through converting to a rain-fed (dryland) production system; maximizing effectiveness of precipitation to reduce the amount of irrigation required; adopting highly efficient irrigation and tillage practices to reduce irrigation applications required; and/or using a higher quality irrigation water source (if available). Since some salts are added through fertilizers or as components (or contaminants) of other soil additives, soil fertility testing is warranted to refine nutrient management programs.

### Crop Selection

Some crops and varieties are more tolerant of salinity than others. For instance barley, cotton, rye, and Bermudagrass are classified as salt tolerant (a relative term). Wheat, oats, sorghum, and soybean are classified as moderately salt tolerant. Corn, alfalfa, many clovers, and most vegetables are moderately sensitive to salt. Some relatively salt tolerant crops (such as barley and sugarbeet) are more salt sensitive at emergence and early growth stages than in their later growth stages. Currently crop breeding programs are addressing salt tolerance for several crops, including small grains and forages.

Some field crops are particularly susceptible to particular salts or specific elements or to foliar injury if saline water is applied through sprinkler irrigation methods. Elements of particular concern include sodium (Na), chlorine (Cl), and Boron (B). Tolerances to salinity in soil solution and irrigation water and tolerances to Na, Cl, and B are listed for various crops in references provided in this manual.



# Salinity Management

## Irrigation Leaching

The classical “textbook” solution to salinity management in the field is through leaching (washing) accumulated salts below the root zone. This is often accomplished by occasional excessive irrigation applications to dissolve, dilute and move the salts. The amount of excess irrigation application required (often referred to as the “leaching fraction”) depends upon the concentrations of salts within the soil and in the water applied to accomplish the leaching. A commonly used equation to estimate leaching fraction requirement (expressed as a percent of irrigation requirement) is:

$$\text{Leaching fraction} = \frac{\text{electrical conductivity of irrigation water}}{\text{permissible electrical conductivity in the soil}} \times 100 \%$$

Where irrigation water quantity is limited, sufficient water for leaching may not be available. The combined problem of limited water volume and poor water quality can be particularly difficult to manage.

Soil additives and field drainage can be used to facilitate the leaching process. Site specific issues, including soil and water chemistry, soil characteristics and field layout, should be considered in determining the best approach to accomplish effective leaching. For instance, gypsum, sulfur, sulfuric acid, and other sulfur containing compounds, as well as calcium and calcium salts may be used to increase the availability of calcium in soil solution to “displace” sodium adsorbed to soil particles and hence facilitate sodium leaching for remediation of sodic soils. In soils with insufficient internal drainage for salt leaching and removal, mechanical drainage (subsurface drain tiles, ditches, etc.) may be necessary.

## Irrigation Method Selection

Where foliar damage by salts in irrigation water is a concern, irrigation methods that do not wet plant leaves can be very beneficial. Furrow irrigation, low energy precision application (LEPA) irrigation, surface drip irrigation and subsurface drip irrigation (SDI) methods can be very effective in applying irrigation without leaf wetting. Of course, more advanced irrigation technologies (such as LEPA or SDI) can offer greater achievable irrigation application efficiency and distribution uniformity.

Wetting patterns by different irrigation methods affect patterns of salt accumulation in the seedbed and in the root zone. Evaporation and root uptake of water also affect the salt accumulation patterns. Often the pattern of salt accumulation can be detected by a visible white residue along the side of a furrow, in the bottom of a dry furrow, or on the top of a row. Additional salt accumulations may be located at or near the outer/lower perimeter (outer wetting front) of the irrigated zone in the soil profile.

## Seedbed and Field Management Strategies

In some operations, seed placement can be adapted to avoid planting directly into areas of highest salt accumulation. Row spacing and water movement within the soil can affect the amount of water available for seedlings as well as the amount of water required and available for the dilution of salts.



# Salinity Management

## Irrigation Scheduling

Light, frequent irrigation applications can result in a small wetted zone and limited capacity for dilution or leaching of salts. When salt deposits accumulate near the soil surface (due to small irrigation amounts combined with evaporation from the soil surface), crop germination problems and seedling damage are more likely. In arid and semi-arid conditions a smaller wetted zone generally results in a smaller effective root zone; hence the crop is more vulnerable to salt damage and to drought stress injury.

Although excessive deep percolation losses of irrigation are discouraged for their obvious reduction in irrigation efficiency and for their potential to contribute to groundwater contamination, occasional large irrigation applications may be required for leaching of salts. Managing irrigation schedules (amounts and timing) to support an extensive root zone helps to keep salt accumulations dispersed and away from plant roots, provides for better root uptake of nutrients, and offers improved protection from short-term drought conditions.

## Advantages of Organic Matter

Organic matter offers chemical and physical benefits to mitigate effects of salts. Organic matter can contribute to a higher cation exchange capacity (CEC) and therefore lower the **exchangeable sodium percentage (ESP)**, thereby helping to mitigate negative effects of sodium. By improving and preserving soil structure and permeability, organic matter helps to support ready movement of water through the soil and maintain higher water holding capacity of the soil. Where feasible, organic mulches also can reduce evaporation from the soil surface, thereby increasing water use efficiency (and possibly lowering irrigation demand). Because some organic mulch materials can contain appreciable salts, sampling and analysis for salt content of these products are recommended.

## Special Considerations: SDI maintenance

Some salts, including calcium and magnesium carbonates that contribute to water hardness, merit special consideration for subsurface drip irrigation systems. These salts can precipitate out of solution and contribute to significant clogging of drip emitters and other components (such as filters). Water quality analysis, including acid titration, is necessary to determine appropriate SDI maintenance requirements. Common maintenance practices include periodic acid injection (shock treatment to prevent and/or dissolve precipitates) and continuous acid injection (acid pH maintained to prevent chemical precipitation).

## References

- Fipps, Guy. 2003. *Irrigation Water Quality Standards and Salinity Management*. Fact Sheet B-1667. Texas Cooperative Extension. The Texas A&M University System, College Station, TX.
- Rhoades, J.D., A. Kandiah, and A.M. Mashali. 1992. *The Use of Saline Waters for Crop Production*. FAO Irrigation and Drainage Paper 48. Food and Agriculture Organization of the United Nations, Rome, 1992.



# Irrigation Water Quality Critical Salt Levels for Peanuts, Cotton, Corn and Grain Sorghum (L-5417)



Salinity is becoming a problem in many areas of Texas. As water quality and cropping patterns change, salinity may injure crops and reduce yield. Susceptibility to salt injury varies by crop. It is important that producers understand why and how to measure salts and how crop susceptibility to salts may differ.

*\*Associate Professor and Extension Soil Fertility Specialist; Associate Professor and Extension Agronomist; Associate Professor and Extension Agronomist*

# Irrigation Water Quality

*Critical Salt Levels for Peanuts, Cotton,  
Corn and Grain Sorghum*

*Mark McFarland, Robert Lemon and Charles Stichler\**

## Why well water can be salty

Irrigation water quality is determined by the total amounts of salts and the types of salts present in the water. A salt is a combination of two elements or ions. One has a positive charge (for example, sodium), and the other has a negative charge (such as chloride).

Water may contain a variety of salts including sodium chloride (table salt), sodium sulfate, calcium chloride, calcium sulfate (gypsum), magnesium chloride, etc. The types and amounts of salts in water, and thus the salinity of that water, depend on the source.



The quality of well water depends on the composition of the underground formations from which the water is pumped. When these are “marine” (ocean) formations, they usually will have higher salt levels and produce water that is more salty. The quality of surface water depends largely on the source of runoff. Drainage water from

irrigated land, saline seeps, oil fields, and city and industrial wastewaters generally has higher salt levels.

## What problems can salty water cause?

Salty irrigation water can cause two major problems in crop production—salinity hazard,



# Table 1 Critical Values for Salts in Irrigation Water for Major Crops

MEASUREMENT	PEANUTS	CORN	GRAIN SORGHUM	COTTON
<b><u>Total Dissolved Salts (Electrical Conductivity or Total Dissolved Solids*)</u></b>				
Micromhos per centimeter (umhos/cm)	2100	1100	1700	5100
Microsiemens per centimeter (uS/cm)	2100	1100	1700	5100
Millimhos per meter (mmhos/cm)	2.1	1.1	1.7	5.1
Decisiemens per meter (dS/m)	2.1	1.1	1.7	5.1
Parts per million (ppm)	1344	704	1088	3264
Milligrams per liter (mg/L)	1344	704	1088	3264
.....				
<b><u>Sodium Adsorption Ratio (SAR)</u></b>				
No units (just a number)	10	10	10	10
.....				
<b><u>Toxic Ions (Resulting in Foliar Injury)</u></b>				
<b>Boron</b>				
Parts per million (ppm)	0.75	2.0	3.0	3.0
Milligrams per liter (mg/L)	0.075	2.0	3.0	3.0
Milliequivalents per liter (meq/L)	0.075	0.2	0.3	0.3
<b>Chloride</b>				
Parts per million (ppm)	400-500	533	710	710
Milligrams per liter (mg/L)	400-500	533	710	710
Milliequivalents per liter (meq/L)	11-14	15	20	20
<b>Sodium</b>				
Parts per million (ppm)	400-500	533	710	710
Milligrams per liter (mg/L)	400-500	533	710	710
Milliequivalents per liter (meq/L)	17-21	23	31	31

**\*Different units of measurement for total soluble salts represent the same critical value**

and sodium hazard. When irrigation water is used by plants or evaporates from the soil surface, salts contained in the water are left behind and can accumulate in the soil. These salts create a salinity hazard

because they compete with plants for water. Even if a saline soil is water saturated, plant roots may be unable to absorb the water, and plants will show signs of drought stress. Foliar applications of salty water

often cause marginal leaf burn and, in severe cases, can lead to defoliation and significant yield loss. Sodium hazard is caused by high levels of sodium, which can be toxic to plants and damage medi-

um and fine-textured soils. When the sodium level in a soil becomes high, the soil will lose its structure, become dense and form hard crusts on the surface.

### What tests should be done on irrigation water?

To evaluate a salt hazard, a water sample should be analyzed for three major factors:

- Total soluble salts.
- Sodium hazard (SAR).
- Toxic ions.

**Total soluble salts** measures the salinity hazard by estimating the combined effects of all the different salts that may be in the water. It is measured as the electrical conductivity (EC) of the water. Salty water carries an electrical current better than pure water, and EC rises as the amount of salt increases. Many people make the mistake of testing only for chlorides, but chlorides are only one part of the salts and do not determine the entire problem.

**Sodium hazard** is based on a calculation of the sodium adsorption ratio (SAR). This measurement determines if sodium levels are high enough to damage the soil or if the concentration is great enough to reduce plant growth. Sometimes a factor called the exchangeable sodium percentage (ESP) may be listed or dis-



cussed on a water test; however, this is actually a measurement of soil salinity, not water quality.

**Toxic ions** include elements like chloride, sulfate, sodium and boron. Sometimes, even though the salt level is not excessive, one or more of these elements may become toxic to plants. Many plants are particularly sensitive to boron. In general, it is best to request a water analysis that lists the concentrations of all major cations (calcium, magnesium, sodium, potassium) and anions (chloride, sulfate, nitrate, boron) so that the levels of all elements can be evaluated.

### What are the critical levels?

Agricultural crops differ greatly in their ability to tolerate salts. Some crops have special methods for managing high salt levels inside the plant that allow them to continue to grow and produce. In most cases, critical levels have been established for each crop and

each type of salt test or problem. *One of the most confusing factors is that there can be many different units of measurement for the same test.* That is, the numbers have the same relative meaning, but the units of measurement used to express the value are different (much like saying 12 inches or 1 foot).

The Texas Cooperative Extension Soil, Water and Forage Testing Laboratory uses standard units of micromhos per centimeter (umhos/cm) for total soluble salts and parts per million (ppm) for individual ions. Other laboratories may use different units of measure that can be calculated by making simple conversions. Table 1 lists the different tests and corresponding critical values for different units of measurement. These values represent the maximum salt level in irrigation water that can be used without reducing crop yield. Keep in mind that these values are estimates. Actual crop response may vary depending on soil type, rainfall, irrigation frequency and weather conditions. Note cotton's ability to tolerate higher levels of salt than other common Texas crops.

### Management factors

Irrigation water with a salt level near the critical value is referred to as "marginal" quality water. In some cases, marginal quality water can be used

to produce a crop, recognizing that some loss in yield (10 percent to 75 percent) may occur. Plants can continue to grow in the presence of low salts, but the yield potential will not be maximized. Plants grown in salty soils or irrigated with salty water are always in a drought-stressed condition.

Management systems for marginal quality water must be carefully designed. Major factors that must be considered include soil type, internal drainage, irrigation system and methods (rates, frequency) and cropping systems. Growers should consult an experienced agronomist or irrigation specialist for assistance in planning a management strategy for using marginal quality irrigation water.

Educational programs of Texas Cooperative Extension are open to all people without regard to race, color, sex, disability, religion, age or national origin.

Issued in furtherance of Cooperative Extension Work in Agriculture and Home Economics, Acts of Congress of May 8, 1914, as amended, and June 30, 1914, in cooperation with the United States Department of Agriculture. Chester P. Fehlis, Deputy Director, Texas Cooperative Extension, The Texas A&M University System.

New, 5M

## HOW TO GET A WATER TEST

*Water analyses can be accurate only if the sample is taken correctly. Please use the following guidelines when collecting a well water sample for irrigation water quality analysis:*

### Containers

**S**amples should be collected in a clean, plastic bottle with a screw cap. Wash bottles thoroughly before taking samples to eliminate any contamination. An 8-ounce plastic, disposable baby bottle is the best kind of container to use. Rinse the container several times with the water to be tested before collecting the final sample. Always clearly identify each container with a specific sample identification (well site). When mailing samples, place the bottles in a box or pack them with a soft packing material (newspaper or styrofoam) to prevent crushing.

### Collecting the water sample

When testing well water, allow the pump to operate for at least 20 minutes before taking the sample to be sure the water is representative of what is being tested. Take the water sample at the pump so that residues from the lines do not contaminate the sample. If two or more wells supply an irrigation system, one sample may be taken from the system after pumping (flushing) for at least one hour. However, if a water test indicates a problem, all wells supplying the system will need to be tested individually to determine the source of the problem. Sometimes one poor quality well can dramatically reduce the quality of a mixture.

Testing should also be done on irrigation water from ponds, reservoirs, streams or other surface water sources. Samples can be obtained by collecting water from a faucet near the pumping station after operating for 20 minutes or longer. For irrigation water sources where no pump is present, obtain samples by attaching a clean bottle to a pole or extension and collecting and mixing several samples into a "composite," which is sent to the laboratory.

Package and mail all samples to the laboratory as soon as possible to prevent chemical changes in the water during storage. Keep good records of the date and location of each sample. This can best be done by keeping a copy of the Laboratory Information Sheet that must be submitted with each sample.

In most cases, a Routine Irrigation Water Analysis is the most appropriate test to request for irrigation water. Regardless of the laboratory selected, be certain that the analysis includes the three major factors—total soluble salts, sodium hazard (SAR) and individual potentially toxic ions. For special cases or if uncertain, contact your County Extension Office for information.

*For additional information, see our website at <http://soilcrop.tamu.edu>.*



# Irrigation Water Quality Standards and Salinity Management Strategies (B-1667)

---

---

# Irrigation Water Quality Standards and Salinity Management Strategies

---

---

# Irrigation Water Quality Standards and Salinity Management

Guy Fipps\*

Nearly all waters contain dissolved salts and trace elements, many of which result from the natural weathering of the earth's surface. In addition, drainage waters from irrigated lands and effluent from city sewage and industrial waste water can impact water quality. In most irrigation situations, the primary water quality concern is salinity levels, since salts can affect both the soil structure and crop yield. However, a number of trace elements are found in water which can limit its use for irrigation.

Generally, "salt" is thought of as ordinary table salt (sodium chloride). How-

ever, many types of salts exist and are commonly found in Texas waters (Table 1). Most salinity problems in agriculture result directly from the salts carried in the irrigation water. The process at work is illustrated in Figure 1, which shows a beaker of water containing a salt concentration of 1 percent. As water evaporates, the dissolved salts remain, resulting in a solution with a higher concentration of salt. The same process occurs in soils. Salts as well as other dissolved substances begin to accumulate as water evaporates from the surface and as crops withdraw water.

## Water Analysis: Units, Terms and Sampling

Numerous parameters are used to define irrigation water quality, to assess salinity hazards, and to determine appropriate management strategies. A complete water quality analysis will include the determination of:

- 1) the total concentration of soluble salts,
- 2) the relative proportion of sodium to the other cations,
- 3) the bicarbonate concentration as related to the concentration of calcium and magnesium, and
- 4) the concentrations of specific elements and compounds.

\*Associate Professor and Extension Agricultural Engineer, Department of Agricultural Engineering, The Texas A&M University System, College Station, Texas 77843-2117.

Table 1. Kinds of salts normally found in irrigation waters, with chemical symbols and approximate proportions of each salt.<sup>1</sup> (Longenecker and Lyerly, 1994)

Chemical name	Chemical symbol	Approximate proportion of total salt content
Sodium chloride	NaCl	Moderate to large
Sodium sulfate	Na <sub>2</sub> SO <sub>4</sub>	Moderate to large
Calcium chloride	CaCl <sub>2</sub>	Moderate
Calcium sulfate (gypsum)	CaSO <sub>4</sub> 2H <sub>2</sub> O	Moderate to small
Magnesium chloride	MgCl <sub>2</sub>	Moderate
Magnesium sulfate	MgSO <sub>4</sub>	Moderate to small
Potassium chloride	KCl	Small
Potassium sulfate	K <sub>2</sub> SO <sub>4</sub>	Small
Sodium bicarbonate	NaHCO <sub>3</sub>	Small
Calcium carbonate	CaCO <sub>3</sub>	Very Small
Sodium carbonate	Na <sub>2</sub> CO <sub>3</sub>	Trace to none
Borates	BO <sup>-3</sup>	Trace to none
Nitrates	NO <sup>-3</sup>	Small to none

<sup>1</sup>Waters vary greatly in amounts and kinds of dissolved salts. This water typifies many used for irrigation in Texas.

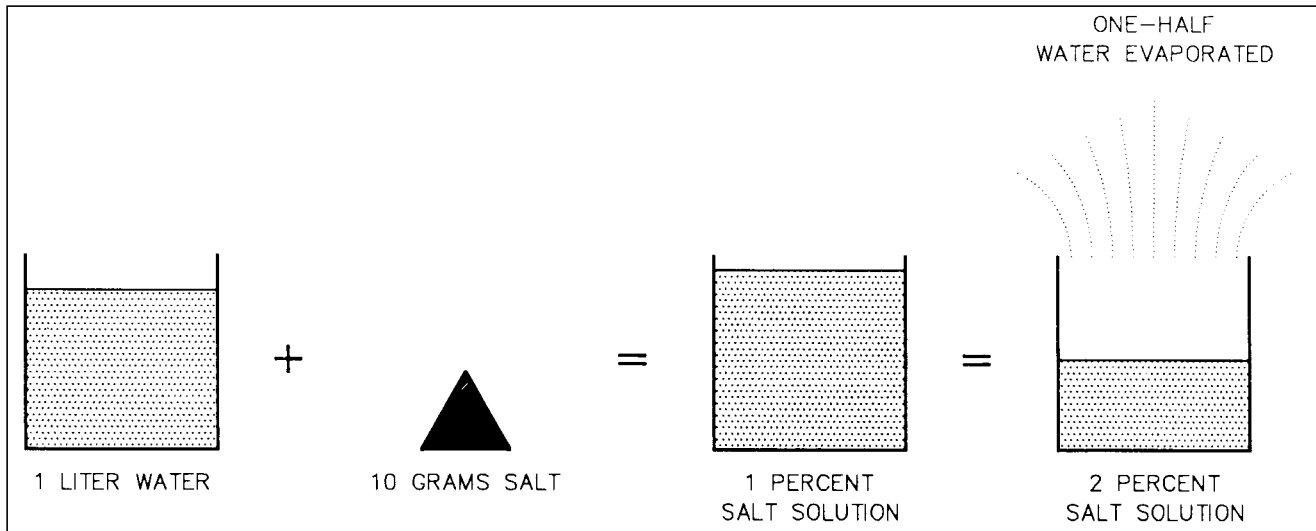

Figure 1. Effect of water evaporation on the concentration of salts in solution. A liter is 1.057 quarts. Ten grams is .035 ounces or about 1 teaspoonful.

The amounts and combinations of these substances define the suitability of water for irrigation and the potential for plant toxicity. Table 2 defines common parameters for analyzing the suitability of water for irrigation and provides some useful conversions.

When taking water samples for laboratory analysis, keep in mind that water from the same source can vary in quality with time. Therefore, samples should be tested at intervals throughout the year, particularly during the potential irrigation period. The Soil and Water Testing Lab at Texas A&M University can do a complete salinity analysis of irrigation water and soil samples, and will provide a detailed computer printout on the interpretation of the results. Contact your county Extension agent for forms and information or contact the Lab at (979) 845-4816.

## Two Types of Salt Problems

Two types of salt problems exist which are very different: those associated with the total salinity and those associated with sodium. Soils may be affected only by salinity or by a combination of both salinity and sodium.

### Salinity Hazard

Water with high salinity is toxic to plants and poses a **salinity hazard**. Soils with high levels of total salinity are called **saline soils**. High concentrations of salt in the soil can result in a "physiological" drought condition. That is, even though the field appears to have plenty of moisture,

the plants wilt because the roots are unable to absorb the water. Water salinity is usually measured by the TDS (total dissolved solids) or the EC (electric conductivity). TDS is sometimes referred to as the total salinity and is measured or expressed in parts per million (ppm) or in the equivalent units of milligrams per liter (mg/L).

EC is actually a measurement of electric current and is reported in one of three possible units as given in Table 2. Subscripts are used with the symbol EC to identify the source of the sample.  $EC_{iw}$  is the electric conductivity of the irrigation water.  $EC_e$  is the electric conductivity of the soil as measured in a soil sample (saturated extract) taken

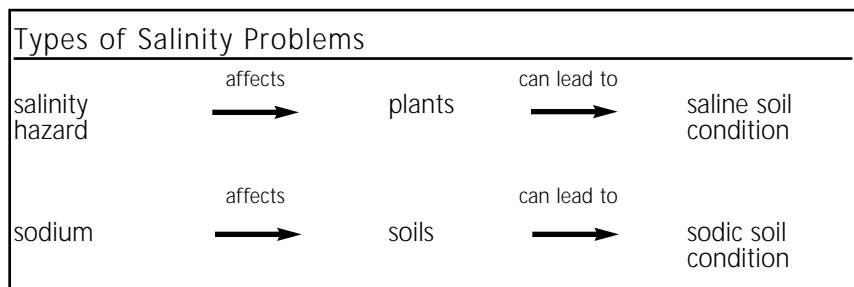

Table 2. Terms, units, and useful conversions for understanding water quality analysis reports.				
Symbol		Meaning		Units
Total Salinity				
a. EC		electric conductivity		mmhos/cm µmhos/cm dS/m
b. TDS		total dissolved solids		mg/L ppm
Sodium Hazard				
a. SAR		sodium adsorption ratio		—
b. ESP		exchangeable sodium percentage		—
Determination	Symbol	Unit of measure	Atomic weight	
Constituents				
(1) cations				
calcium	Ca	mol/m <sup>3</sup>	40.1	
magnesium	Mg	mol/m <sup>3</sup>	24.3	
sodium	Na	mol/m <sup>3</sup>	23.0	
potassium	K	mol/m <sup>3</sup>	39.1	
(2) anions				
bicarbonate	HCO <sub>3</sub>	mol/m <sup>3</sup>	61.0	
sulphate	SO <sub>4</sub>	mol/m <sup>3</sup>	96.1	
chloride	Cl	mol/m <sup>3</sup>	35.5	
carbonate	CO <sub>3</sub>	mol/m <sup>3</sup>	60.0	
nitrate	NO <sub>3</sub>	mg/L	62.0	
Trace Elements				
boron	B	mg/L	10.8	
Conversions				
1 dS/m = 1 mmhos/cm = 1000 µmhos/cm				
1 mg/L = 1 ppm				
TDS (mg/L) ≈ EC (dS/m) x 640 for EC < 5 dS/m				
TDS (mg/L) ≈ EC (dS/m) x 800 for EC > 5 dS/m				
TDS (lbs/ac-ft) ≈ TDS (mg/L) x 2.72				
Concentration (ppm) = Concentration (mol/m <sup>3</sup> ) times the atomic weight				
Sum of cations/anions (meq/L) ≈ EC (dS/m) x 10				
Key				
mg/L = milligrams per liter				
ppm = parts per million				
dS/m = deci Siemens per meter at 25° C				

from the root zone.  $EC_d$  is the soil salinity of the saturated extract taken from below the root zone.  $EC_d$  is used to determine the salinity of the drainage water which leaches below the root zone.

### Sodium Hazard

Irrigation water containing large amounts of sodium is of special concern due to sodium's effects on the soil and poses a **sodium hazard**. Sodium hazard is usually expressed in terms of SAR or the **sodium adsorption ratio**. SAR is

calculated from the ratio of sodium to calcium and magnesium. The latter two ions are important since they tend to counter the effects of sodium. For waters containing significant amounts of bicarbonate, the adjusted sodium adsorption ratio ( $SAR_{adj}$ ) is sometimes used.

Continued use of water having a high SAR leads to a breakdown in the physical structure of the soil.

Sodium is adsorbed and becomes attached to soil particles. The soil then becomes hard and compact when dry and increasingly impervious to water penetration. Fine textured soils, especially those high in clay, are most subject to this action. Certain amendments may be required to maintain soils under high SARs. Calcium and magnesium, if present in the soil in large enough quantities, will counter the effects of the sodium and help maintain good soil properties.

**Soluble sodium per cent (SSP)** is also used to evaluate sodium hazard. SSP is defined as the ration of sodium in epm (equivalents per million) to the total cation epm multiplied by 100. A water with a SSP greater than 60 per cent may result in sodium accumulations that will cause a breakdown in the soil's physical properties.

### Ions, Trace Elements and Other Problems

A number of other substances may be found in irrigation water and can cause toxic reactions in plants (Table 3). After sodium, chloride and boron are



Table 3. Recommended limits for constituents in reclaimed water for irrigation. (Adapted from Rowe and Abdel-Magid, 1995)

Constituent	Long-term use (mg/L)	Short-term use (mg/L)	Remarks
Aluminum (Al)	5.0	20	Can cause nonproductivity in acid soils, but soils at pH 5.5 to 8.0 will precipitate the ion and eliminate toxicity.
Arsenic (As)	0.10	2.0	Toxicity to plants varies widely, ranging from 12 mg/L for Sudan grass to less than 0.05 mg/L for rice.
Beryllium (Be)	0.10	0.5	Toxicity to plants varies widely, ranging from 5 mg/L for kale to 0.5 mg/L for bush beans.
Boron (B)	0.75	2.0	Essential to plant growth, with optimum yields for many obtained at a few-tenths mg/L in nutrient solutions. Toxic to many sensitive plants (e.g., citrus) at 1 mg/L. Most grasses relatively tolerant at 2.0 to 10 mg/L.
Cadmium (Cd)	0.01	0.05	Toxic to beans, beets, and turnips at concentrations as low as 0.1 mg/L in nutrient solution. Conservative limits recommended.
Chromium (Cr)	0.1	1.0	Not generally recognized as essential growth element. Conservative limits recommended due to lack of knowledge on toxicity to plants.
Cobalt (Co)	0.05	5.0	Toxic to tomato plants at 0.1 mg/L in nutrient solution. Tends to be inactivated by neutral and alkaline soils.
Copper (Cu)	0.2	5.0	Toxic to a number of plants at 0.1 to 1.0 mg/L in nutrient solution.
Fluoride (F <sup>-</sup> )	1.0	15.0	Inactivated by neutral and alkaline soils.
Iron (Fe)	5.0	20.0	Not toxic to plants in aerated soils, but can contribute to soil acidification and loss of essential phosphorus and molybdenum.
Lead (Pb)	5.0	10.0	Can inhibit plant cell growth at very high concentrations.
Lithium (Li)	2.5	2.5	Tolerated by most crops at up to 5 mg/L; mobile in soil. Toxic to citrus at low doses recommended limit is 0.075 mg/L.
Manganese (Mg)	0.2	10.0	Toxic to a number of crops at a few-tenths to a few mg/L in acid soils.
Molybdenum (Mo)	0.01	0.05	Nontoxic to plants at normal concentrations in soil and water. Can be toxic to livestock if forage is grown in soils with high levels of available molybdenum.
Nickel (Ni)	0.2	2.0	Toxic to a number of plants at 0.5 to 1.0 mg/L; reduced toxicity at neutral or alkaline pH.
Selenium (Se)	0.02	0.02	Toxic to plants at low concentrations and to livestock if forage is grown in soils with low levels of added selenium.
Vanadium (V)	0.1	1.0	Toxic to many plants at relatively low concentrations.
Zinc (Zn)	2.0	10.0	Toxic to many plants at widely varying concentrations; reduced toxicity at increased pH (6 or above) and in fine-textured or organic soils.

**of most concern. In certain areas of Texas, boron concentrations are excessively high and render water unsuitable for irrigations. Boron can also accumulate in the soil.**

**Crops grown on soils having an imbalance of calcium and magnesium may also exhibit toxic symp-**

**oms. Sulfate salts affect sensitive crops by limiting the uptake of calcium and increasing the adsorption of sodium and potassium, resulting in a disturbance in the cationic balance within the plant. The bicarbonate ion in soil solution harms the mineral nutrition of the plant through**

**its effects on the uptake and metabolism of nutrients. High concentrations of potassium may introduce a magnesium deficiency and iron chlorosis. An imbalance of magnesium and potassium may be toxic, but the effects of both can be reduced by high calcium levels.**

# Classification of Irrigation Water

Several different measurements are used to classify the suitability of water for irrigation, including  $EC_{iw}$ , the total dissolved solids, and SAR. Some permissible limits for classes of irrigation water are given in Table 4. In Table 5, the sodium hazard of water is ranked from low to very high based on SAR values.

## Classification of Salt-Affected Soils

Both  $EC_e$  and SAR are commonly used to classify salt-affected soils (Table 6). **Saline soils** (resulting from salinity hazard) normally have a pH value below 8.5, are relatively low in sodium and contain principally sodium, calcium and magnesium chlorides and sul-

fates. These compounds cause the white crust which forms on the surface and the salt streaks along the furrows. The compounds which cause saline soils are very soluble in water; therefore, leaching is usually quite effective in reclaiming these soils.

**Sodic soils** (resulting from sodium hazard) generally have a pH value between 8.5 and 10. These soils are called "black alkali soils" due to their darkened appearance and smooth, slick looking areas caused by the dispersed condition. In sodic soils, sodium has destroyed the permanent structure which tends to make the soil impervious to

water. Thus, leaching alone will not be effective unless the high salt dilution method or amendments are used.

## Water Quality Effects on Plants and Crop Yield

Table 7 gives the expected yield reduction of some crops for various levels of **soil salinity** as measured by EC under normal growing conditions, and Table 8 gives potential yield reduction due to **water salinity** levels. Generally forage crops are the most resistant to salinity, followed by field crops, vegetable crops, and fruit crops which are generally the most sensitive.

Table 9 lists the **chloride tolerance** of a number of agricultural crops. **Boron** is a major concern in some areas. While a necessary nutrient, high boron levels cause plant toxicity, and concentrations should not exceed those given in Table 10. Some information is available on the susceptibility of crops to **foliar injury** from spray irrigation with water containing sodium

Table 6. Classification of salt-affected soils based on analysis of saturation extracts. (Adapted from James et al., 1982)

Criteria	Normal	Saline	Sodic	Saline-Sodic
$EC_e$ (mmhos/cm)	<4	>4	<4	>4
SAR	<13	<13	>13	>13

Table 4. Permissible limits for classes of irrigation water.

Classes of water	Concentration, total dissolved solids	
	Electrical conductivity $\mu$ mhos*	Gravimetric ppm
Class 1, Excellent	250	175
Class 2, Good	250-750	175-525
Class 3, Permissible <sup>1</sup>	750-2,000	525-1,400
Class 4, Doubtful <sup>2</sup>	2,000-3,000	1,400-2,100
Class 5, Unsuitable <sup>2</sup>	3,000	2,100

\*Micromhos/cm at 25 degrees C.  
<sup>1</sup>Leaching needed if used  
<sup>2</sup>Good drainage needed and sensitive plants will have difficulty obtaining stands

Table 5. The sodium hazard of water based on SAR Values.

SAR values	Sodium hazard of water	Comments
1-10	Low	Use on sodium sensitive crops such as avocados must be cautioned.
10 - 18	Medium	Amendments (such as Gypsum) and leaching needed.
18 - 26	High	Generally unsuitable for continuous use.
> 26	Very High	Generally unsuitable for use.

Table 7. Soil salinity tolerance levels<sup>1</sup> for different crops.  
(Adapted from Ayers and Westcot, 1976)

Crop	Yield potential, EC <sub>e</sub>				Maximum EC <sub>e</sub>
	100%	90%	75%	50%	
<b>Field crops</b>					
Barley <sup>a</sup>	8.0	10.0	13.0	18.0	28
Bean (field)	1.0	1.5	2.3	3.6	7
Broad bean	1.6	2.6	4.2	6.8	12
Corn	1.7	2.5	3.8	5.9	10
Cotton	7.7	9.6	13.0	17.0	27
Cowpea	1.3	2.0	3.1	4.9	9
Flax	1.7	2.5	3.8	5.9	10
Groundnut	3.2	3.5	4.1	4.9	7
Rice (paddy)	3.0	3.8	5.1	7.2	12
Safflower	5.3	6.2	7.6	9.9	15
Sesbania	2.3	3.7	5.9	9.4	17
Sorghum	4.0	5.1	7.2	11.0	18
Soybean	5.0	5.5	6.2	7.5	10
Sugar beet	7.0	8.7	11.0	15.0	24
Wheat <sup>a</sup>	6.0	7.4	9.5	13.0	20
<b>Vegetable crops</b>					
Bean	1.0	1.5	2.3	3.6	7
Beet <sup>b</sup>	4.0	5.1	6.8	9.6	15
Broccoli	2.8	3.9	5.5	8.2	14
Cabbage	1.8	2.8	4.4	7.0	12
Cantaloupe	2.2	3.6	5.7	9.1	16
Carrot	1.0	1.7	2.8	4.6	8
Cucumber	2.5	3.3	4.4	6.3	10
Lettuce	1.3	2.1	3.2	5.2	9
Onion	1.2	1.8	2.8	4.3	8
Pepper	1.5	2.2	3.3	5.1	9
Potato	1.7	2.5	3.8	5.9	10
Radish	1.2	2.0	3.1	5.0	9
Spinach	2.0	3.3	5.3	8.6	15
Sweet corn	1.7	2.5	3.8	5.9	10
Sweet potato	1.5	2.4	3.8	6.0	11
Tomato	2.5	3.5	5.0	7.6	13
<b>Forage crops</b>					
Alfalfa	2.0	3.4	5.4	8.8	16
Barley hay <sup>a</sup>	6.0	7.4	9.5	13.0	20
Bermudagrass	6.9	8.5	10.8	14.7	23
Clover, Berseem	1.5	3.2	5.9	10.3	19
Corn (forage)	1.8	3.2	5.2	8.6	16
Harding grass	4.6	5.9	7.9	11.1	18
Orchard grass	1.5	3.1	5.5	9.6	18
Perennial rye	5.6	6.9	8.9	12.2	19
Sudan grass	2.8	5.1	8.6	14.4	26
Tall fescue	3.9	5.8	8.61	3.3	23
Tall wheat grass	7.5	9.9	13.3	19.4	32
Trefoil, big	2.3	2.8	3.6	4.9	8
Trefoil, small	5.0	6.0	7.5	10.0	15
Wheat grass	7.5	9.0	11.0	15.0	22

and chloride (Table 11). The tolerance of crops to sodium as measured by the exchangeable sodium percentage (ESP) is given in Table 12.

### Salinity and Growth Stage

Many crops have little tolerance for salinity during seed germination, but significant tolerance during later growth stages. Some crops such as barley, wheat and corn are known to be more sensitive to salinity during the early growth period than during germination and later growth periods. Sugar beet and safflower are relatively more sensitive during germination, while the tolerance of soybeans may increase or decrease during different growth periods depending on the variety.

### Leaching for Salinity Management

Soluble salts that accumulate in soils must be leached below the crop root zone to maintain productivity. Leaching is the basic management tool for controlling salinity. Water is applied in excess of the total amount used by the crop and lost to evaporation. The strategy is to keep the salts in solution and flush them below the root zone. The amount of water needed is referred to as the *leaching requirement* or the *leaching fraction*.

Excess water may be applied with every irrigation to provide the water needed for leaching. However, the time interval between leachings does not appear to be critical provided that crop tolerances are

Crop	Yield potential, EC <sub>e</sub>				Maximum EC <sub>e</sub>
	100%	90%	75%	50%	
Fruit crops					
Almond	1.5	2.0	2.8	4.1	7
Apple, Pear	1.7	2.3	3.3	4.8	8
Apricot	1.6	2.0	2.6	3.7	6
Avocado	1.3	1.8	2.5	3.7	6
Date palm	4.0	6.8	10.9	17.9	32
Fig, Olive, Pomegranate	2.7	3.8	5.5	8.4	14
Grape	1.5	2.5	4.1	6.7	12
Grapefruit	1.8	2.4	3.4	4.9	8
Lemon	1.7	2.3	3.3	4.8	8
Orange	1.7	2.3	3.2	4.8	8
Peach	1.7	2.2	2.9	4.1	7
Plum	1.5	2.1	2.9	4.3	7
Strawberry	1.0	1.3	1.8	2.5	4
Walnut	1.7	2.3	3.3	4.8	8

<sup>1</sup>Based on the electrical conductivity of the saturated extract taken from a root zone soil sample (EC<sub>e</sub>) measured in mmhos/cm.

<sup>a</sup>During germination and seedling stage EC<sub>e</sub> should not exceed 4 to 5 mmhos/cm except for certain semi-dwarf varieties.

<sup>b</sup>During germination EC<sub>e</sub> should not exceed 3 mmhos/cm.

not exceeded. Hence, leaching can be accomplished with each irrigation, every few irrigations, once yearly, or even longer depending on the severity of the salinity problem and salt tolerance of the crop. An occasional or annual leaching event where water is ponded on the surface is an easy and effective method for controlling soil salinity. In some areas, normal rainfall provides adequate leaching.

#### Determining Required Leaching Fraction

The leaching fraction is commonly calculated using the following relationship:

$$LF = \frac{EC_{iw}}{EC_e} \quad (1)$$

where

LF = leaching fraction - the fraction of applied irrigation water that must be leached through the root zone

EC<sub>iw</sub> = electric conductivity of the irrigation water

EC<sub>e</sub> = the electric conductivity of the soil in the root zone

Equation (1) can be used to determine the leaching fraction necessary to maintain the root zone at a targeted salinity level. If the amount of water available for leaching is fixed, then the equation can be used to calculate the salinity level that will be maintained in the root zone with that amount of leaching. Please note that equation (1) simplifies a complicated soil water process. EC<sub>e</sub> should be checked periodically.

Crop	Yield potential, EC <sub>iw</sub>			
	100%	90%	75%	50%
Field crops				
Barley	5.0	6.7	8.7	12.0
Bean (field)	0.7	1.0	1.5	2.4
Broad bean	1.1	1.8	2.0	4.5
Corn	1.1	1.7	2.5	3.9
Cotton	5.1	6.4	8.4	12.0
Cowpea	0.9	1.3	2.1	3.2
Flax	1.1	1.7	2.5	3.9
Groundnut	2.1	2.4	2.7	3.3
Rice (paddy)	2.0	2.6	3.4	4.8
Safflower	3.5	4.1	5.0	6.6
Sesbania	1.5	2.5	3.9	6.3
Sorghum	2.7	3.4	4.8	7.2
Soybean	3.3	3.7	4.2	5.0
Sugar beet	4.7	5.8	7.5	10.0
Wheat	4.0	4.9	6.4	8.7
Vegetable crops				
Bean	0.7	1.0	1.5	2.4
Beet	2.7	3.4	4.5	6.4
Broccoli	1.9	2.6	3.7	5.5

Table 8. Irrigation water salinity tolerances<sup>1</sup> for different crops. (continued)

Crop	Yield potential, EC <sub>IW</sub>			
	100%	90%	75%	50%
Cabbage	1.2	1.9	2.9	4.6
Cantaloupe	1.5	2.4	3.8	6.1
Carrot	0.7	1.1	1.9	3.1
Cucumber	1.7	2.2	2.9	4.2
Lettuce	0.9	1.4	2.1	3.4
Onion	0.8	1.2	1.8	2.9
Pepper	1.0	1.5	2.2	3.4
Potato	1.1	1.7	2.5	3.9
Radish	0.8	1.3	2.1	3.4
Spinach	1.3	2.2	3.5	5.7
Sweet corn	1.1	1.7	2.5	3.9
Sweet potato	1.0	1.6	2.5	4.0
Tomato	1.7	2.3	3.4	5.0
Forage crops				
Alfalfa	1.3	2.2	3.6	5.9
Barley hay	4.0	4.9	6.3	8.7
Bermudagrass	4.6	5.7	7.2	9.8
Clover, Berseem	1.0	2.1	3.9	6.8
Corn (forage)	1.2	2.1	3.5	5.7
Harding grass	3.1	3.9	5.3	7.4
Orchard grass	1.0	2.1	3.7	6.4
Perennial rye	3.7	4.6	5.9	8.1
Sudan grass	1.9	3.4	5.7	9.6
Tall fescue	2.6	3.9	5.7	8.9
Tall wheat grass	5.0	6.6	9.0	13.0
Trefoil, big	1.5	1.9	2.4	3.3
Trefoil, small	3.3	4.0	5.0	6.7
Wheat grass	5.0	6.0	7.4	9.8
Fruit crops				
Almond	1.0	1.4	1.9	2.7
Apple, Pear	1.0	1.6	2.2	3.2
Apricot	1.1	1.3	1.8	2.5
Avocado	0.9	1.2	1.7	2.4
Date palm	2.7	4.5	7.3	12.0
Fig, Olive, Pomegranate	1.8	2.6	3.7	5.6
Grape	1.0	1.7	2.7	4.5
Grapefruit	1.2	1.6	2.2	3.3
Lemon	1.1	1.6	2.2	3.2
Orange	1.1	1.6	2.2	3.2
Peach	1.1	1.4	1.9	2.7
Plum	1.0	1.4	1.9	2.8
Strawberry	0.7	0.9	1.2	1.7
Walnut	1.1	1.6	2.2	3.2

<sup>1</sup>Based on the electrical conductivity of the irrigation water (EC<sub>IW</sub>) measured in mmhos/cm.

cally and the amount of leaching adjusted accordingly.

Based on this equation, Table 13 lists the amount of leaching needed for different classes of irrigation waters to maintain the soil salinity in the root zone at a desired level. However, additional water must be supplied because of the inefficiencies of irrigation systems (Table 14), as well as to remove the existing salts in the soil.

### Subsurface Drainage

Very saline, shallow water tables occur in many areas of Texas. Shallow water tables complicate salinity management since water may actually move upward into the root zone, carrying with it dissolved salts. Water is then extracted by crops and evaporation, leaving behind the salts.

Shallow water tables also contribute to the salinity problem by restricting the downward leaching of salts through the soil profile. Installation of a subsurface drainage system is about the only solution available for this situation. The original clay tiles have been replaced by plastic tubing. Modern drainage tubes are covered by a “sock” made of fabric to prevent clogging of the small openings in the plastic tubing.

A schematic of a subsurface drainage system is shown in Figure 2. The design parameters are the distance between drains (L) and the elevation of the drains (d) above the underlying impervious or restricting layer. Proper spacing and

depth maintain the water level at an optimum level, shown here as the distance  $m$  above the drain tubes. The USDA Natural Resources Conservation Service (NRCS) has developed drainage design guidelines that are used throughout the United States. A drainage computer model developed by Wayne Skaggs at North Carolina State University, DRAINMOD, is also widely used throughout the world for subsurface drainage design.

### Seed Placement

Obtaining a satisfactory stand is often a problem when furrow irrigating with saline water. Growers sometimes compensate for poor germination by planting two or three times as much seed as normally would be required. However, planting procedures can be adjusted to

lower the salinity in the soil around the germinating seeds. Good salinity control is often achieved with a combination of suitable practices, bed shapes and irrigation water management.

In furrow-irrigated soils, planting seeds in the center of a single-row, raised bed places the seeds exactly where salts are expected to concentrate (Figure 3). This situation can be avoided using "salt ridges." With a double-row raised planting bed, the seeds are placed near the shoulders and away from the area of greatest salt accumulation. Alternate-furrow irrigation may help in some cases. If alternate furrows are irrigated, salts often can be moved beyond the single seed row to the non-irrigated side of the planting bed. Salts will still accumulate, but accumulation at the center of the bed will be reduced.

With either single- or double-row plantings, increasing the depth of the water in the furrow can improve germination in saline soils. Another practice is to use sloping beds, with the seeds planted on the sloping side just above the water line (Fig. 3b). Seed and plant placement is also important with the use of drip irrigation. Typical wetting patterns of drip emitters and micro-sprinklers are shown in Figure 4. Salts tend to move out and upward, and will accumulate in the areas shown.

### Other Salinity Management Techniques

Techniques for controlling salinity that require relatively minor changes are more frequent irrigations, selection of more salt-tolerant crops, additional leach-

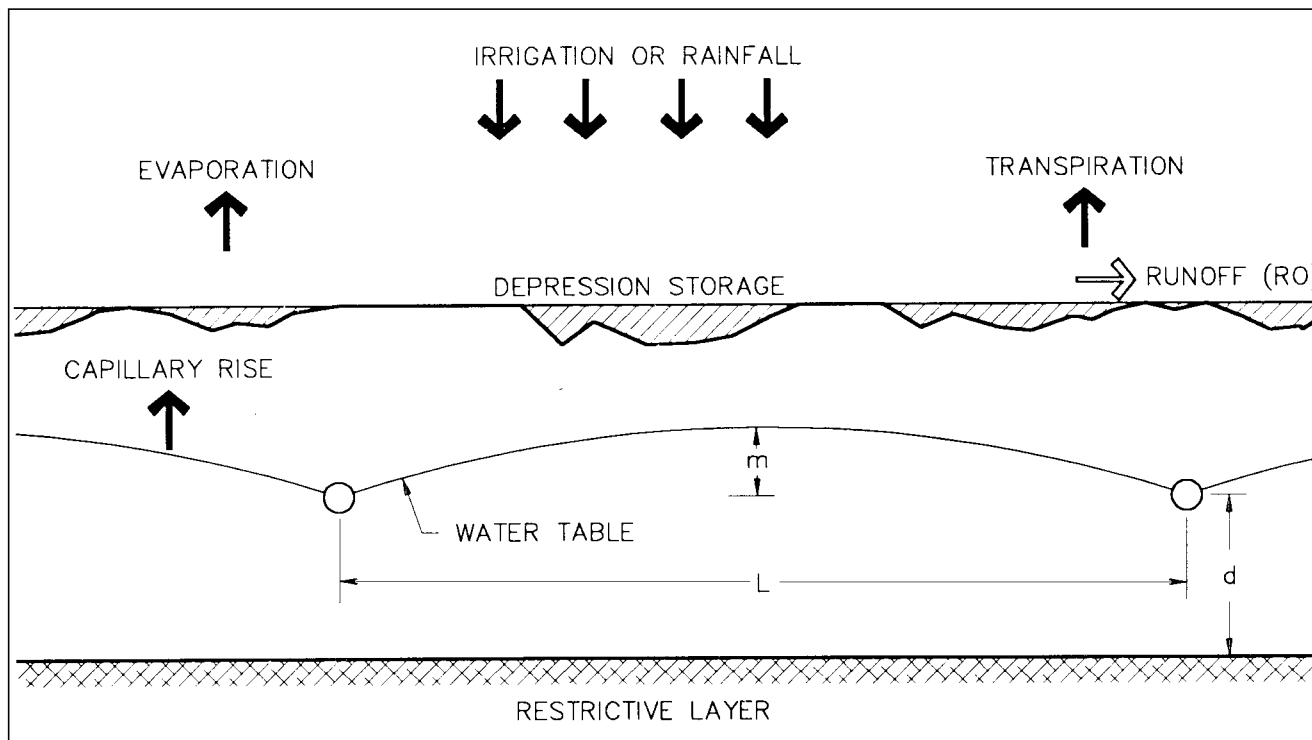

Figure 2. A subsurface drainage system. Plastic draitubes are located a distance ( $L$ ) apart.

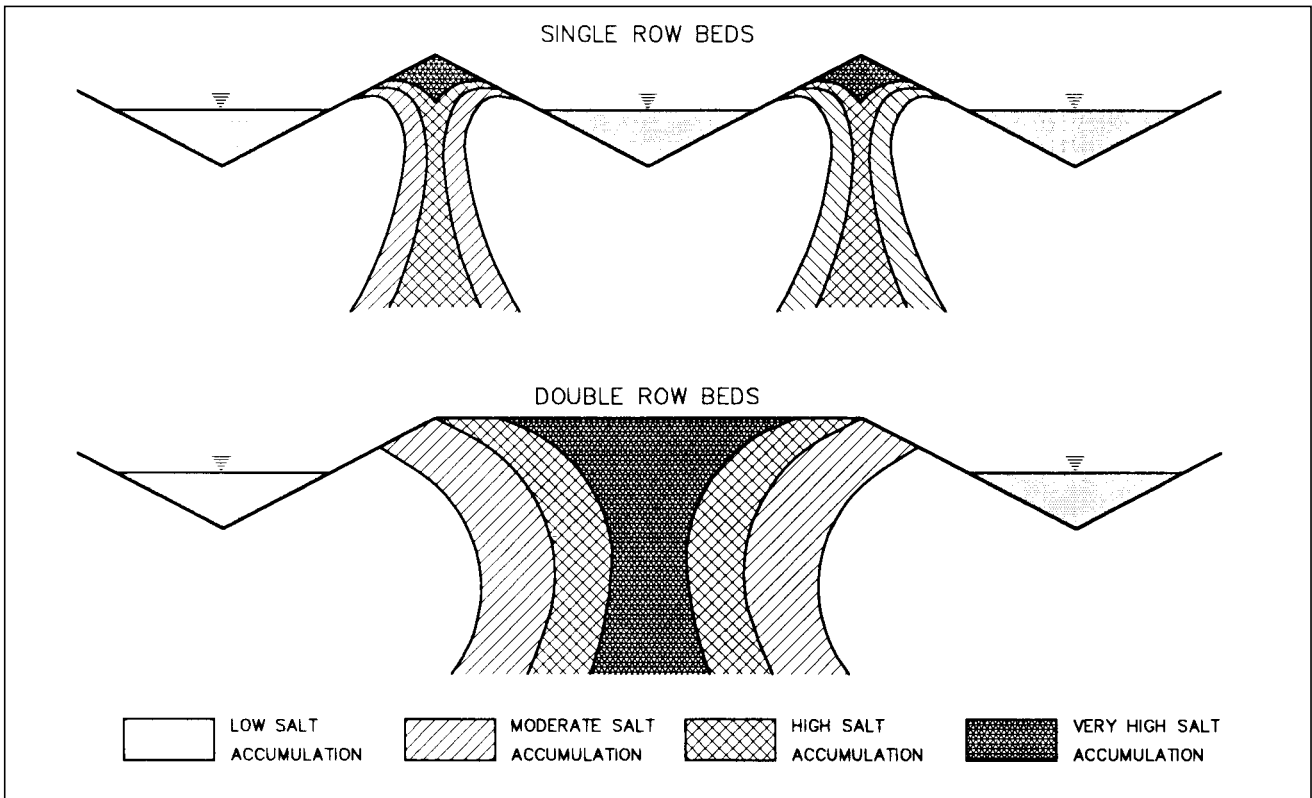

Figure 3a. Single-row versus double-row beds showing areas of salt accumulation following a heavy irrigation with salty water. Best planting position is on the shoulders of the double-row bed.

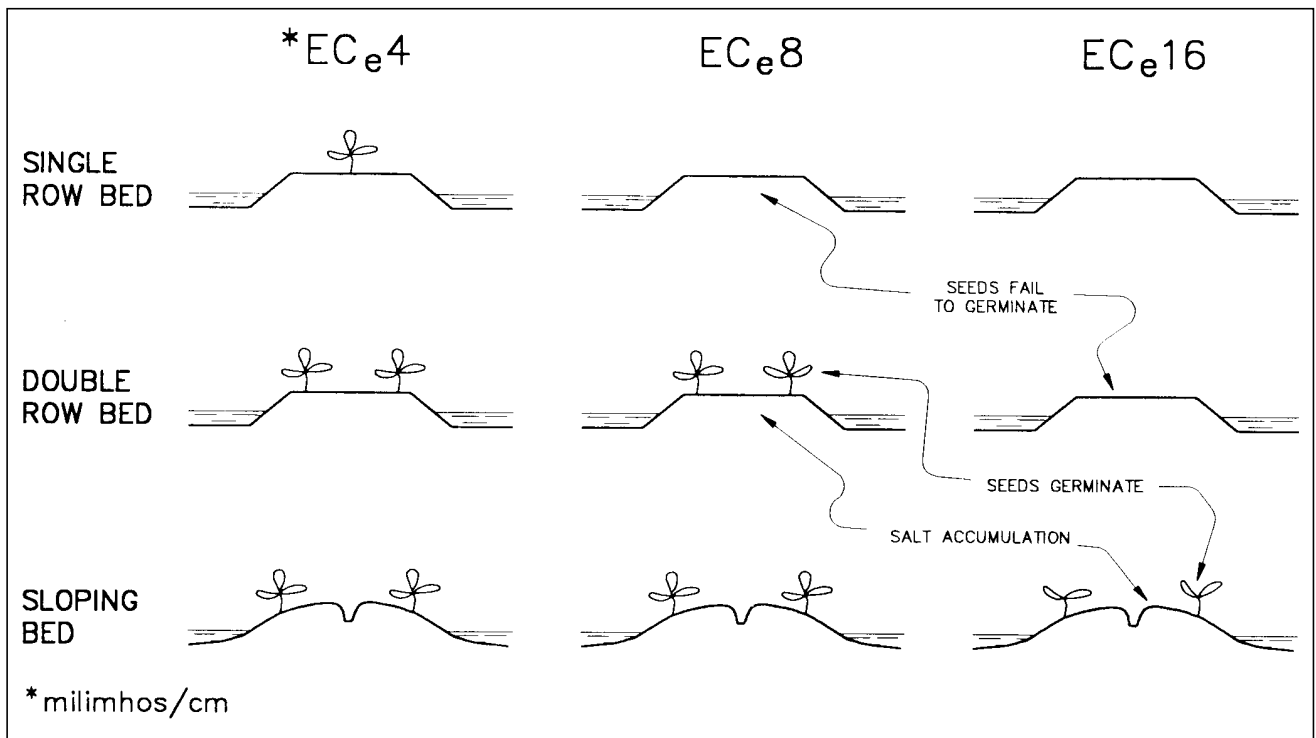

Figure 3b. Pattern of salt build-up as a function of seed placement, bed shape and irrigation water quality.

Table 9. Chloride tolerance of agricultural crops. Listed in order of tolerance<sup>a</sup>. (Adapted from Tanji. 1990)

Crop	Maximum Cl <sup>-</sup> concentration <sup>b</sup> without loss in yield	
	mol/m <sup>3</sup>	ppm
Strawberry	10	350
Bean	10	350
Onion	10	350
Carrot	10	350
Radish	10	350
Lettuce	10	350
Turnip	10	350
Rice, paddy <sup>c</sup>	30 <sup>d</sup>	1,050
Pepper	15	525
Clover, strawberry	15	525
Clover, red	15	525
Clover, alsike	15	525
Clover, ladino	15	525
Corn	15	525
Flax	15	525
Potato	15	525
Sweet potato	15	525
Broad bean	15	525
Cabbage	15	525
Foxtail, meadow	15	525
Celery	15	525
Clover, Berseem	15	525
Orchardgrass	15	525
Sugarcane	15	525
Trefoil, big	20	700
Lovegras	20	700
Spinach	20	700
Alfalfa	20	700
Sesbania <sup>c</sup>	20	700
Cucumber	25	875
Tomato	25	875
Broccoli	25	875
Squash, scallop	30	1,050
Vetch, common	30	1,050
Wild rye, beardless	30	1,050
Sudan grass	30	1,050
Wheat grass, standard crested	35	1,225
Beet, red <sup>c</sup>	40	1,400
Fescue, tall	40	1,400
Squash, zucchini	45	1,575
Harding grass	45	1,575
Cowpea	50	1,750
Trefoil, narrow-leaf bird's foot	50	1,750

ing, preplant irrigation, bed forming and seed placement. Alternatives that require significant changes in management are changing the irrigation method, altering the water supply, land-leveling, modifying the soil profile, and installing subsurface drainage.

### Residue Management

The common saying “salt loves bare soils” refers to the fact that exposed soils have higher evaporation rates than those covered by residues. Residues left on the soil surface reduce evaporation. Thus, less salts will accumulate and rainfall will be more effective in providing for leaching.

### More Frequent Irrigations

Salt concentrations increase in the soil as water is extracted by the crop. Typically, salt concentrations are lowest following an irrigation and higher just before the next irrigation. Increasing irrigation frequency maintains a more constant moisture content in the soil. Thus, more of the salts are then kept in solution which aids the leaching process. Surge flow irrigation is often effective at reducing the minimum depth of irrigation that can be applied with furrow irrigation systems. Thus, a larger number of irrigations are possible using the same amount of water.

With proper placement, drip irrigation is very effective at flushing salts, and water can be applied almost continuously. Center pivots equipped with LEPA water applicators offer similar efficiencies and control as drip



Table 9. Chloride tolerance of agricultural crops. Listed in order of tolerance<sup>a</sup>. (continued)

Crop	Maximum Cl <sup>-</sup> concentration <sup>b</sup> without loss in yield	
	mol/m <sup>3</sup>	ppm
Ryegrass, perennial	55	1,925
Wheat, Durum	55	1,925
Barley (forage) <sup>c</sup>	60	2,100
Wheat <sup>c</sup>	60	2,100
Sorghum	70	2,450
Bermudagrass	70	2,450
Sugar beet <sup>c</sup>	70	2,450
Wheat grass, fairway crested	75	2,625
Cotton	75	1,625
Wheat grass, tall	75	2,625
Barley <sup>c</sup>	80	2,800

<sup>a</sup>These data serve only as a guideline to relative tolerances among crops. Absolute tolerances vary, depending upon climate, soil conditions and cultural practices.

<sup>b</sup>Cl<sup>-</sup> concentrations in saturated-soil extracts sampled in the rootzone.

<sup>c</sup>Less tolerant during emergence and seedling stage.

<sup>d</sup>Values for paddy rice refer to the Cl<sup>-</sup> concentration in the soil water during the flooded growing conditions.

irrigation at less than half the cost. Both sprinkler and drip provide more control and flexibility in scheduling irrigation than furrow systems.

#### Preplant Irrigation

Salts often accumulate near the soil surface during fallow periods, particularly when water tables are high or when off-season rainfall is below normal. Under these conditions, seed germination and seedling growth can be seriously reduced unless the soil is leached before planting.

#### Changing Surface Irrigation Method

Surface irrigation methods, such as flood, basin, furrow and border are usually not sufficiently flexible to permit changes in frequency of

irrigation or depth of water applied per irrigation. For example, with furrow irrigation it may not be possible to reduce the depth of water applied below 3-4 inches. As a result, irrigating more frequently might improve water availability to the crop but might also waste water. Converting to **surge flow irrigation** may be the solution for many furrow systems. Otherwise a sprinkler or drip irrigation system may be required.

#### Chemical Amendments

In sodic soils (or sodium affected soils), sodium ions have become attached to and adsorbed onto the soil particles. This causes a breakdown in soil structure and results in soil sealing or "cementing," making it difficult for water to infil-

trate. Chemical amendments are used in order to help facilitate the displacement of these sodium ions. Amendments are composed of sulphur in its elemental form or related compounds such as sulfuric acid and gypsum. Gypsum also contains calcium which is an important element in correcting these conditions. Some chemical amendments render the natural calcium in the soil more soluble. As a result, calcium replaces the adsorbed sodium which helps restore the infiltration capacity of the soil. Polymers are also beginning to be used for treating sodic soils.

It is important to note that use of amendments does not eliminate the need for leaching. Excess water must still be applied to leach out the displaced sodium. Chemical amendments are only effective on sodium-affected soils. Amendments are ineffective for saline soil conditions and often will increase the existing salinity problem. Table 15 lists the most common amendments. The irrigation books listed under the References section present equations that are used to determine the amount of amendments needed based on soil analysis results.

#### Pipe Water Delivery Systems Stabilize Salinity

As illustrated in Fig. 1, any open water is subject to evaporation which leads to higher salt concentrations in the water. Evaporation rates from water surfaces often exceed 0.25 inch a day during summer in Texas. Thus, the salinity

content of irrigation water will increase during the entire time water is transported through irrigation canals or stored in reser-

voirs. Replacing irrigation ditches with pipe systems will help stabilize salinity levels. In addition, pipe systems, including gated pipe

and lay-flat tubing, reduce water lost to canal seepage and increase the amount of water available for leaching.

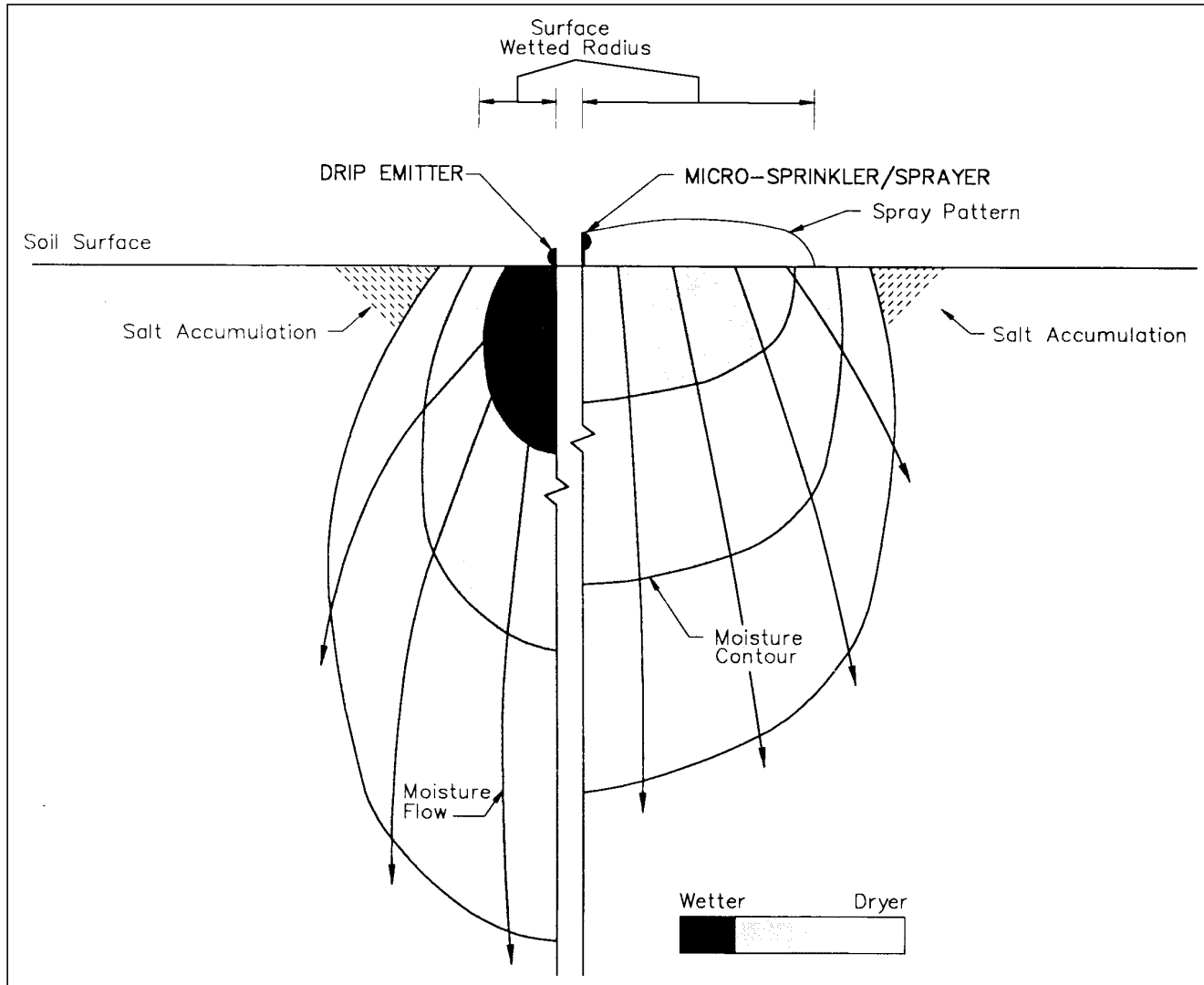

Figure 4. Typical wetting patterns and areas of salt accumulation with drip emitters and micro-sprinklers sprayers.

A. Permissible Limits (Boron in parts per million)			
Class of water	Crop group		
	Sensitive	Semitolerant	Tolerant
Excellent	<0.33	<0.67	<1.00
Good	0.33 to 0.67	0.67 to 1.33	1.00 to 2.00
Permissible	0.67 to 1.00	1.33 to 2.00	2.00 to 3.00
Doubtful	1.00 to 1.25	2.00 to 2.50	3.00 to 3.75
Unsuitable	>1.25	>2.5	>3.75

Sensitive (1.0 mg/L of Boron)	Semitolerant (2.0 mg/L of Boron)	Tolerant (4.0 mg/L of Boron)
Pecan	Sunflower (native)	Athel (Tamarix aphylla)
Walnut (Black, Persian, or English)	Potato	Asparagus
Jerusalem artichoke	Cotton (Acala and Pima)	Palm (Phoenix canariensis)
Navy bean	Tomato	Date palm (P. dactylifera)
American elm	Sweetpea	Sugar beet
Plum	Radish	Mangel
Pear	Field pea	Garden beet
Apple	Ragged Robin rose	Alfalfa
Grape (Sultania and Malaga)	Olive	Gladiolus
Kadota fig	Barley	Broad bean
Persimmon	Wheat	Onion
Cherry	Corn	Turnip
Peach	Milo	Cabbage
Apricot	Oat	Lettuce
Thornless blackberry	Zinnia	Carrot
Orange	Pumpkin	
Avocado	Bell pepper	
Grapefruit	Sweet potato	
Lemon	Lima bean	
(0.3 mg/L of Boron)	(1.0 mg/L of Boron)	(2.0 mg/L of Boron)

Na or Cl concentration (mol/m <sup>3</sup> ) causing foliar injury <sup>a</sup>			
<5	5-10	10-20	>20
Almond	Grape	Alfalfa	Cauliflower
Apricot	Pepper	Barley	Cotton
Citrus	Potato	Corn	Sugar beet
Plum	Tomato	Cucumber	Sunflower
		Safflower	
		Sesame	
		Sorghum	

<sup>a</sup>Foliar injury is influenced by cultural and environmental conditions. These data are presented only as general guidelines for daytime sprinkling.

Table 12. Tolerance of Various Crops to Exchangeable-Sodium Percentage. (James et al., 1982)

Tolerance to ESP (range at which affected)	Crop	Growth Responsible Under Field Conditions
Extremely sensitive (ESP = 2-10)	Deciduous fruits Nuts Citrus Avocado	Sodium toxicity symptoms even at low ESP values
Sensitive (ESP = 10-20)	Beans	Stunted growth at low ESP values even though the physical condition of the soil may be good
Moderately tolerant (ESP = 20-40)	Clover Oats Tall fescue Rice Dallisgrass	Stunted growth due to both nutritional factors and adverse soil conditions
Tolerant (ESP = 40-60)	Wheat Cotton Alfalfa Barley Tomatoes Beets	Stunted growth usually due to adverse physical conditions of soil
Most tolerant (ESP > 60)	Crested and Fairway wheatgrass Tall wheatgrass Rhodes grass	Stunted growth usually due to adverse physical conditions of soil

Table 13. Leaching requirement\* as related to the electrical conductivities of the irrigation and drainage water.

Electrical conductivity of irrigation water (mmhos/cm)	Leaching requirement based on the indicated maximum values for the conductivity of the drainage water at the bottom of the root zone			
	4 mmhos/cm	8 mmhos/cm	12 mmhos/cm	16 mmhos/cm
	Percent	Percent	Percent	Percent
0.75	13.3	9.4	6.3	4.7
1.00	25.0	12.5	8.3	6.3
1.25	31.3	15.6	10.4	7.8
1.50	37.5	18.7	12.5	9.4
2.00	50.0	25.0	16.7	12.5
2.50	62.5	31.3	20.8	15.6
3.00	75.0	37.5	25.0	18.7
5.00	—	62.5	41.7	31.2

\*Fraction of the applied irrigation water that must be leached through the root zone expressed as percent.

System	Overall efficiency (%)
Surface	50-80
a. average	50
b. land leveling and delivery pipeline meeting design standards	70
c. tailwater recovery with (b)	80
d. surge	60-90*
Sprinkler (moving and fixed systems)	55-85
LEPA (low pressure precision application)	95-98
Drip	80-90**

\*Surge has been found to increase efficiencies 8 to 28% over non-surge furrow systems.

\*\*Drip systems are typically designed at 90% efficiency, short laterals (100 feet) or systems with pressure compensating emitters may have higher efficiencies.

Amendment	Physical description	Amount equivalent 100% gypsum
Gypsum*	White mineral	1.0
Sulfur <sup>†</sup>	Yellow element	0.2
Sulfuric acid*	Corrosive liquid	0.6
Lime sulfur*	Yellow-brown solution	0.8
Calcium carbonate <sup>†</sup>	White mineral	0.6
Calcium chloride*	White salt	0.9
Ferrous sulfate*	Blue-green salt	1.6
Pyrite <sup>†</sup>	Yellow-black mineral	0.5
Ferric sulfate*	Yellow-brown salt	0.6
Aluminum sulfate*	Corrosive granules	1.3

\*Suitable for use as a water or soil amendment.

<sup>†</sup>Suitable only for soil application.

## References

- Ayres, R.S. and D.W. Westcot. 1976. *Water Quality for Agriculture. Irrigation and Drainage Paper No. 29. Food and Agriculture Organization of the United Nations. Rome.*
- Cuena, R.H. 1989. *Irrigation System Design.* Prentice Hall, Englewood Cliffs, NJ. 552pp.
- Hoffman, G.S., R.S. Ayers, E.J. Doering and B.L. McNeal. 1980. *Salinity in Irrigated Agriculture.* In: *Design and Operation of Farm Irrigation Systems.* M.E. Jensen, Editor. ASAE Monograph No. 3. St. Joseph, MI. 829pp.
- James, D.W., R.J. Hanks and J.H. Jurinak. 1982. *Modern Irrigated Soils.* John Wiley and Sons, NY.
- Jensen, M.E. (Editor). 1980. *Design and Operation of Farm Irrigation Systems.* American Society of Agricultural Engineers, St. Joseph MI. 829pp.
- Longenecker, D.E. and P.J. Lysterly. 1974. B-876 *Control of Soluble Salts in Farming and Gardening.* Texas Agricultural Experiment Station, Texas A&M University System, College Station. June. 36pp.
- Pair, C.H. (editor). 1983. *Irrigation.* The Irrigation Assoc., Arlington, VA. 680pp.
- Rowe, D.R. and I.M. Abdel-Magid. 1995. *Handbook of Wastewater Reclamation and Reuse.* CRC Press, Inc. 550pp.
- Stewart, B.A. and D.R. Nielsen. 1990. *Irrigation of Agricultural Crops.* American Society of Agronomy. 1,218pp.
- Tanji, K.K. 1990. *Agricultural Salinity Assessment and Management.* American Society of Civil Engineers. Manuals and Reports on Engineering Practice Number 71. 619pp.
- van der Leeden, F., F.L. Troise and D.K. Todd. 1990. *The Water Encyclopedia.* Lewis Publishers. 808pp.

Produced by Agricultural Communications, The Texas A&M University System

Extension publications can be found on the Web at: <http://tcebookstore.org>

*Educational programs of Texas Cooperative Extension are open to all people without regard to race, color, sex, disability, religion, age or national origin.*

Issued in furtherance of Cooperative Extension Work in Agriculture and Home Economics, Acts of Congress of May 8, 1914, as amended, and June 30, 1914, in cooperation with the United States Department of Agriculture. Chester P. Fehlis, Director, Texas Cooperative Extension, The Texas A&M University System.  
10M, Reprint



# Irrigation Salinity Management Information on the Internet



## Irrigation Salinity Management Information on the Internet

*This list of references, though not exhaustive on the subject, has been assembled to aid the reader in accessing additional information on salinity management in agricultural irrigation. It was compiled by Extension Agricultural Engineer Dana Porter; it was updated in September 2007.*

### **Texas Cooperative Extension and Texas Agricultural Experiment Station**

Irrigation Management with Saline Water

<http://www.oznet.k-state.edu/irrigate/OOW/P06/Porter06.pdf>

Irrigation water quality: Critical Salt Levels for Peanuts, Cotton, Corn and Grain Sorghum

<http://lubbock.tamu.edu/cotton/pdf/irrigwaterqual.pdf>

Irrigation Water Quality Standards and Salinity Management Strategies

<http://agnews.tamu.edu/drought/DRGHTPAK/SALINITY.HTM>

2001 Leaf Necrosis Problems in Drip-Irrigated Cotton Fields

<http://lubbock.tamu.edu/cotton/2001leafnecrosis/necrosis.html>

### **Colorado State University Cooperative Extension**

Irrigation Water Quality Criteria

<http://www.ext.colostate.edu/PUBS/CROPS/00506.html>

### **University of California Agriculture and Natural Resources**

Irrigation Water Salinity and Crop Production

<http://anrcatalog.ucdavis.edu/pdf/8066.pdf>

### **The University of Arizona Cooperative Extension**

Saline and Sodic Soil Identification and Management for Cotton

[http://cals.arizona.edu/crops/cotton/soilmgt/saline\\_sodic\\_soil.html](http://cals.arizona.edu/crops/cotton/soilmgt/saline_sodic_soil.html)

<http://cals.arizona.edu/pubs/crops/az1199.pdf>

Leaching for Maintenance: Determining the Leaching Requirement for Crops

<http://ag.arizona.edu/pubs/water/az1107.pdf>

### **USDA-ARS George E. Brown, Jr. Salinity Lab**

Handbook No. 60 Saline and Alkali Soils

<http://www.ars.usda.gov/Services/docs.htm?docid=10158>

### **USDA-NRCS National Water and Climate Center**

Salinity in Agriculture links

<http://www.wsi.nrcs.usda.gov/products/W2Q/Salinity/Salinity.html>

### **Food and Agriculture Organization (FAO) of the United Nations**

The use of saline waters for crop production - FAO irrigation and drainage paper 48

<http://www.fao.org/docrep/T0667E/T0667E00.htm>

Evolution, Extent and Economic Land Classification of Salt Affected Soils

Prognosis of Salinity and Alkalinity - FAO Soils Bulletin 31

<http://www.fao.org/docrep/x5870e/x5870e04.htm#TopOfPage>

Irrigation with wastewater

<http://www.fao.org/docrep/T0551E/t0551e07.htm>





# *Protecting Water Resources from Contamination*

## **In this Section**

Overview: Protecting Water Resources from Contamination

Reference: Pesticide Properties That Affect Water Quality (B-6050)

Reference: Chemigation Equipment and Safety (L-2422)

Reference: Reducing Herbicides in Surface Water Best Management Practices (L-5205)

Reference: Chemigation and Water Quality Protection Information on the Internet

## **Overview**

### **Objectives:**

- Increase awareness of the potential for contamination of groundwater and surface water resources as a result of irrigated agriculture.
- Increase familiarity with terminology, processes and pathways associated with common agricultural sources of water resource contamination.
- Increase understanding and application of best management practices to reduce risk of groundwater or surface water contamination.

### **Key Points:**

1. Water losses due to surface runoff or deep percolation can transport sediments, salts, and/or agricultural chemicals to groundwater or surface water.
2. Efficient irrigation and management to optimize rainwater can reduce runoff and deep percolation (leaching) losses.
3. Physical, chemical and other properties of the soil and potential contaminants affect the relative risk of water contamination.
4. Safe and appropriate storage, handling and application of agricultural chemicals and wastes are key to reducing risk of contamination.



## *Protecting Water Resources from Contamination*

### **Assess your knowledge:**

1. Briefly describe some best management practices that can reduce runoff losses and deep percolation losses of irrigation and/or rainfall.
2. What is the difference between a conservative constituent and a non-conservative constituent? List some examples of each.
3. Briefly describe some BMPs for agricultural chemical handling, and explain how they can prevent contamination of water resources.
4. What is the role of a chemigation check valve? How does it work?
5. How can soil fertility testing be a tool in preventing water contamination?



# *Protecting Water Resources from Contamination*

## **Best Management Practices to Prevent Pesticide Contamination of Water Resources\***

Groundwater and surface water resources are active components of a dynamically interrelated hydrologic system. In Texas, there are increasing demands on limited water resources, thus it is especially critical that they be protected from contamination.

Pesticides are important tools in controlling weed, disease, and insect pests in agricultural production, as well as in lawns, sports fields, landscapes and other green industry applications. Pesticides are also used to control insect and rodent pests in our living and working environments. Careful and appropriate handling and use minimize risk of environmental contamination and exposure to pesticides.

### **Pesticide properties that affect Risk of Contamination**

**Solubility** determines how readily a chemical dissolves in water.

**Adsorptivity** determines how strongly a chemical is adsorbed to soil particles.

**Volatility** determines how quickly a chemical will evaporate in air.

**Degradation** describes how quickly a chemical breaks down due to biological and environmental factors.

### **Local conditions that affect Risk of Contamination**

**Soil texture** affects how quickly water moves through soil, how much water can be stored in the soil, and relative particle surface area for chemical adsorption. Coarse (sandy) soils pose higher risk of groundwater contamination than finer textured soils (loam and clay soils).

**Organic matter** in soil reduces water pollution risk, because it increases chemical adsorption potential and supports higher populations of microorganisms for biodegradation of pesticides.

**Topography, soil structure, soil surface condition and soil moisture** affect water movement into and through the soil, influencing relative risks of leaching contaminants to groundwater or runoff of contaminated water to surface water.

**Distance** from groundwater and surface water resources, depth to groundwater, and the proximity of abandoned or poorly constructed water wells affect risk of contamination.

*\* Compiled by Dana Porter, PhD, PE, Department of Biological and Agricultural Engineering and Texas A&M AgriLife Research and Extension Center – Lubbock.*



# *Protecting Water Resources from Contamination*

## **Pesticides in the Environment**

After application, pesticides may be evaporated (volatilized), adsorbed onto soil particles, broken down by sunlight (UV degradation), broken down by microorganisms (biodegradation), taken up in or attached to plants, or dissolved in water.

Pesticides dissolved in water may be transported to groundwater through leaching or to surface water through runoff. Pesticides adsorbed to soil particles also may move to surface water through erosion and sedimentation.

Pesticides in water may also undergo evaporation, UV degradation or biodegradation. They may become diluted or dispersed in the water. They may even move within the groundwater or surface water.

## **Best Management Practices**

### **Integrated Pest Management (IPM)**

Optimize pest management strategies, chemical selection and application timing for efficient and effective control. Consider crop rotations, tillage practices, planting and harvest dates, and other strategies as applicable to achieve good crop results while minimizing the need for pesticide applications. Check with your County Extension IPM or Agriculture Agent for specific IPM recommendations.

### **Pesticide storage, handling and disposal**

- Read and follow the pesticide label.
- Store, handle, mix, apply and dispose of chemicals according to label instructions – not near water wells or water drainage areas.
- Purchase and mix only the amount of chemical that is required to minimize need for disposal.
- Contain and clean spills quickly to minimize risk of water contamination.
- Consider installing a concrete pad, detention storage or berms to contain chemicals, spills and rinsates in the mixing and tank filling area.
- Avoid spraying, mixing and rinsing tanks near a wellhead; use a longer hose or use a water spigot away from the wellhead, if possible.



## *Protecting Water Resources from Contamination*

### **Pesticide application**

- Read and follow label directions!
- Calibrate, clean and maintain all application equipment properly.
- Follow all label instructions regarding registered crops, application rates, methods and timing of pesticide application.
- Observe all restrictions on location, soil types, depths to water table and other limitations as noted on the label.

### **Additional Best Management Practices**

**Manage irrigation** to minimize potential for runoff or deep percolation (leaching) losses. Consider using conservation tillage, setback areas, vegetative filter strips, contour farming and other practices as appropriate to reduce runoff losses from irrigation or rainfall.

**Practice wellhead protection.** Prevent back-siphoning; use adequate backflow protection devices in mixing chemicals and filling tanks. Use backflow protection (chemigation check) valves in chemigation operations. Properly close abandoned water wells.

**Plan ahead to minimize risk.** Identify water wells, surface drainage and other potential pathways for contamination. Avoid using, storing or mixing pesticides near these areas.

**Identify potential sources of contamination,** including chemical storage and mixing areas. Secure these areas to minimize risk of accidental spills.

Prepare an **Emergency Response Plan.**



# Pesticide Properties That Affect Water Quality (B-6050)



Texas Agricultural Extension Service  
The Texas A&M University System

# Pesticide Properties That Affect Water Quality

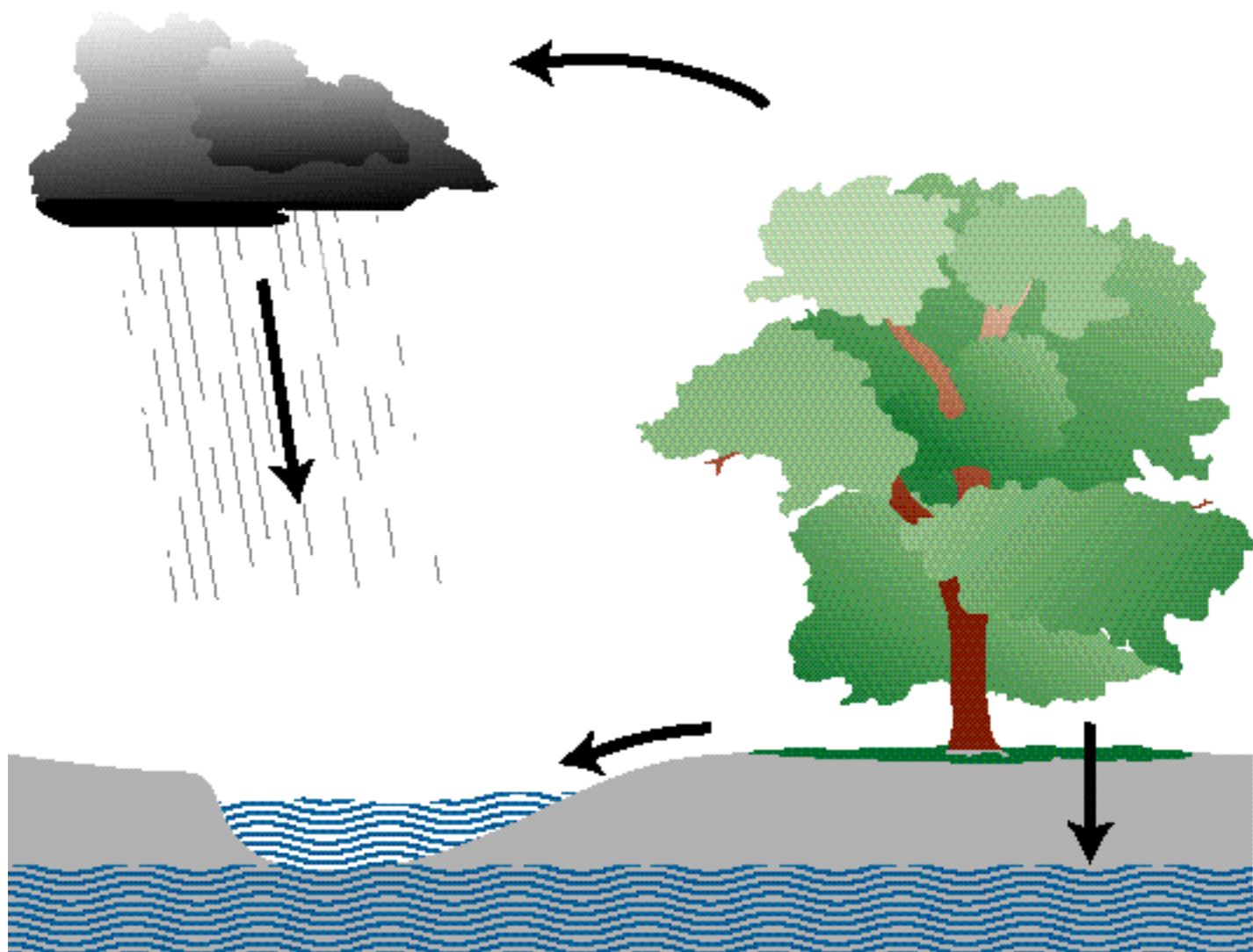

Douglass E. Stevenson, Extension Associate,  
Paul Baumann, Associate Professor and Extension Weed Specialist,  
and

John A. Jackman, Professor and Extension Entomologist,  
The Texas A&M University System

Research and manuscript preparation were performed under contract by Jerry L. Cook, Post Doctoral Research Associate, Department of Entomology, Texas A&M University.



**T**hree factors are necessary to all life on earth. These are an oxidizing agent (usually oxygen), nutrients and water. Water may be the universal chemical compound required by all living organisms. The chemical content of the water in a specific ecosystem determines what life forms can exist. Humans require water with low levels of minerals and organic material. We also require water with low concentrations of chemical toxins. We consider water with these properties to be high quality water.

Most people in the United States expect high quality water as one of the privileges of modern society. Technology makes it possible to turn on the faucet and have clean, clear water readily available. However, the technology that makes this possible also creates pressure on the very water resources that are now taken for granted.

## Why is Water Quality Important?

Water is a part of everyday life, yet it is not an unlimited resource. Fresh water accounts for less than 2.5 percent of all the earth's water. Of all the fresh water on earth, nearly 80 percent is ice in the polar ice caps and glaciers of the world. This leaves only about 0.2 percent of earth's fresh water available for our use (Environmental Protection Agency, 1990).

Since water is the currency of life, we can look at it in terms of money. If \$1,000 represented all the water on earth, only about \$2 would be available as fresh water. Most of this would be locked up in ice and other unavailable sources. Only a few pennies would

be available to spend. So, we can't afford to lose it or waste it.

We depend on water to sustain us, our domestic and wild animals, and the growing plants in forests, fields, yards and gardens. If water becomes contaminated by toxins, it can harm all life forms. Pollution affects all of us—office workers and housewives, the farmer and the field mouse.

Most of the available fresh water is ground water. A much smaller percentage is in rivers, lakes, soil moisture, and the atmosphere. This might appear inadequate. However, if it is of high quality, the amount we have is enough. At present, only about 2 percent of ground water in the United States shows pollution. However, an increasing amount of surface water is becoming at least somewhat contaminated (Environmental Protection Agency, 1990).

More than 600 million pounds of pesticides enter the environment each year in the United States. Pesticides control thousands of different weeds, insects and other pests; they protect crops, human health, property and domestic animals almost everywhere; and, they even protect our drinking water from contamination by algae and other dangerous organisms. However, information about the health and environmental effects of pesticides has increased public concerns and led to more regulation of these chemicals.

We must understand how pesticides can pollute water throughout the hydrologic system (Fig. 1).

The contamination of water is directly related to the degree of pollution of our environment. Rainwater flushes airborne pollution from the skies. It then washes

over the land before running into rivers, aquifers and lakes. It also seeps into underground aquifers. Irrigation and drinking water come from both surface and ground water. Eventually, all of the chemicals we use can pollute our water supplies (see Fig. 2).

There are many materials that endanger our water quality. Most come from urban and industrial activity. Some, however, come from agriculture. Whether in agricultural operations or in urban environments, the improper application, handling or disposal of pesticides can lead to water pollution. There is reason for optimism, however. Without being oppressive, the regulation of pesticides is reducing pesticide pollution of surface and ground water.

## Understanding Pesticides

Pesticides are poisons designed to destroy unwanted life forms. Used properly, modern pesticides can perform their functions without causing significant hazards to humans or the environment. Federal and state laws require the registration of any chemical that claims to control pests, and these laws specify how and where such pesticides can be used.

Pesticides have many uses in homes, gardens, farms, forests and public health. It is difficult to imagine what life would be like without modern pesticides. Yet, it has been less than half a century since they became widely used. Before modern pesticides, humanity was at nature's mercy.

The U.S. farmer, through use of the latest management technol-

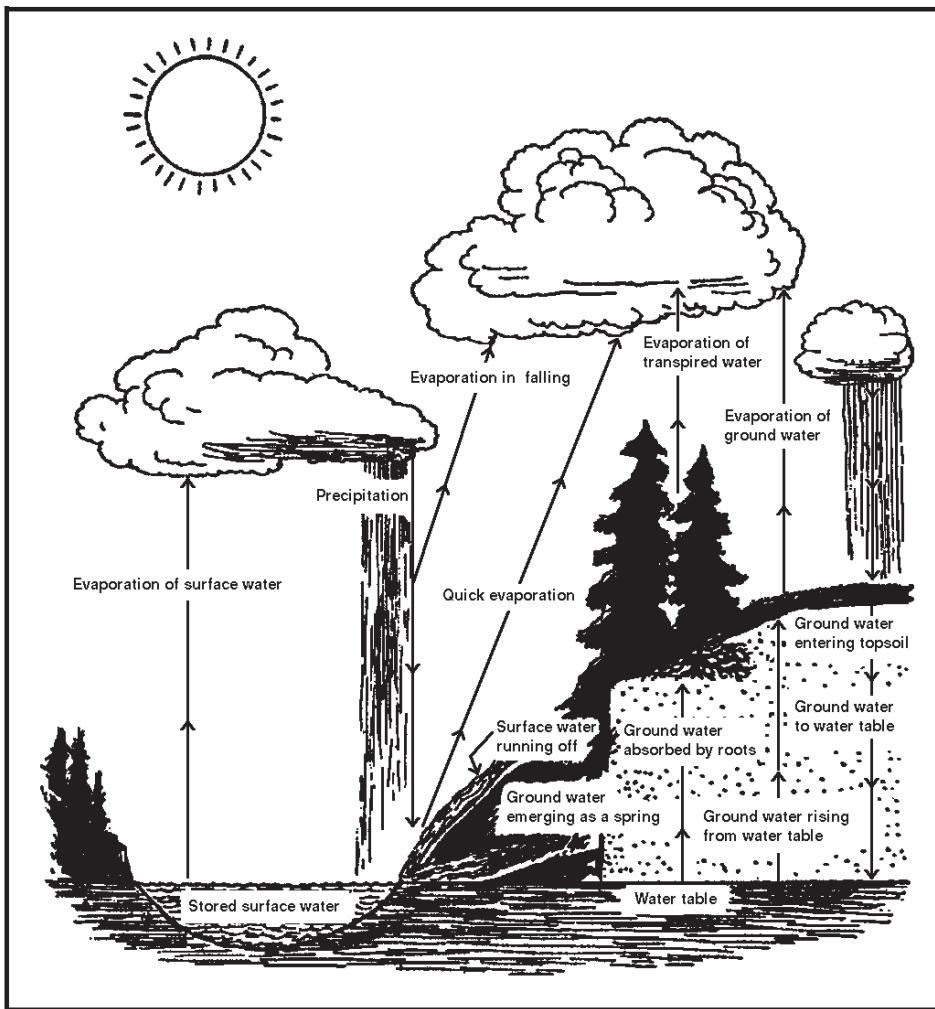

**Figure 1. The hydrologic cycle. Water also will flow to the lowest point allowed by the geologic and soil structures present in the environment. (Moon et al. 1957.)**

ogy, equipment, chemicals and improved hybrid varieties, produces food for this country and the world. In 1994, the average American farmer fed his family and 129 other people, including 97 people in the United States and 32 in other countries. Because most of us don't know much about how our food is produced on farms and ranches, pesticides often are a source of public fear and misunderstanding. Explaining what these chemicals are and what they do is not easy, because most consumers aren't interested in the details. However, it is important to understand both their benefits and hazards.

## Classes of Pesticides

Pesticides have several classifications. First, they fall into neat groups on the basis of their target pests—herbicides, insecticides, fungicides and several others. The three most widely used groups of pesticides are the herbicides, insecticides and fungicides. Herbicides eliminate unwanted and dangerous vegetation. Insecticides prevent injury and damage from harmful insects, mites and ticks. Fungicides protect our food supply from dangerous disease organisms.

The Environmental Protection Agency (EPA) classifies pesticides into two types. These are general-use and restricted-use pesticides. If the EPA believes a pesticide is hazardous to humans or the environment, it is placed in the restricted-use category. To use these chemicals, applicators must have training and acquire a special license. These regulations help prevent pollution.

Before a pesticide is registered for use, the EPA estimates its potential to pollute water. Pesticide manufacturers and the EPA use this information to develop specific precautions to prevent pesticides from entering water. These precautions are printed on the product's label. The EPA frequently cancels or restricts pesticides that have a record of contaminating water even when used according to the label.

Modern pesticides ordinarily do not get into water when used according to label directions. However, there is always a potential for water pollution if pesticide applicators do not follow label precautions. Table 1 shows a few common pesticides and their potential as water pollutants. The EPA develops this type of information for all pesticides that it registers.

It is not always possible to use pesticides that pose a low potential risk to water. There are few chemicals to choose from for controlling some pests. When you have to use a chemical that can easily contaminate water, always follow label precautions. Pay special attention to information about the water pollution potential of the chemical you are using. You can then plan your application to reduce the pollution risks. Follow label directions and guidelines at the end of this manual to avoid problems with pollution.

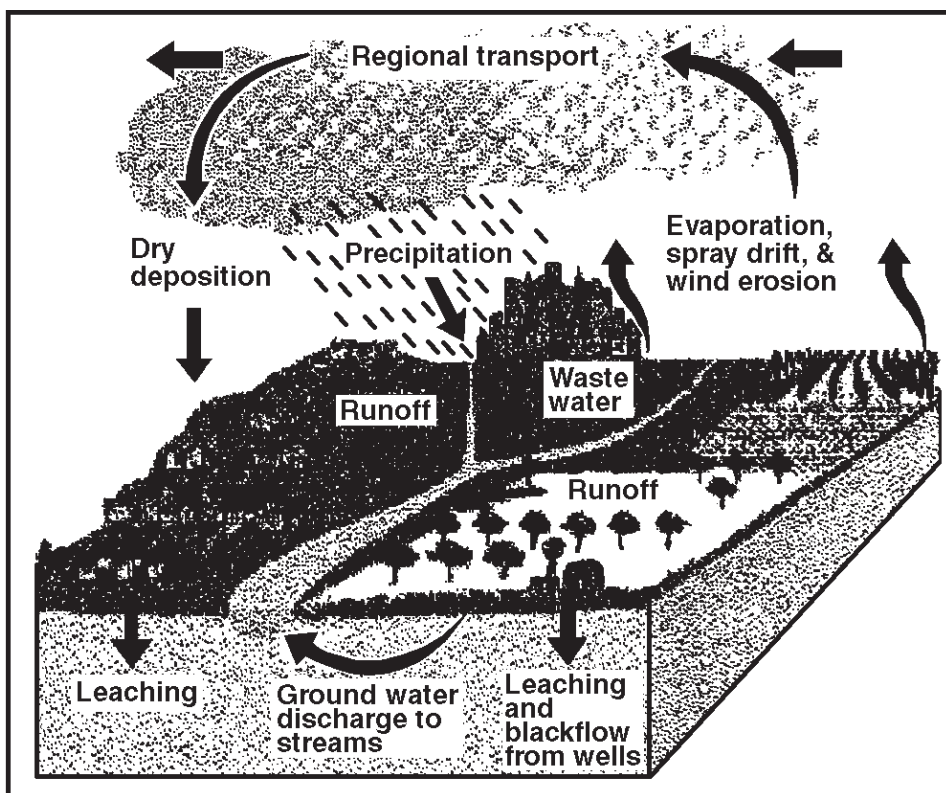

**Figure 2. Pathways of pesticide movement in the hydrologic cycle. (After USGS, 1996)**

streams. Using excessive amounts of chemicals on open or porous soils where there are shallow water tables can allow pesticides to leach or percolate into the ground water.

Improperly cleaning or disposing of containers, as well as mixing and loading pesticides in areas where residues or run-off are likely to threaten surface or ground water, are other potential sources of contamination. Some pesticide labels and some state statutes specify safe distances from well heads for pesticide mixing and loading.

Agricultural chemicals also can pollute surface water through irrigation return flow and rainfall runoff. Carefully following label directions about proper dosage and application methods can greatly reduce the possibility of water contamination.

**Table 1. Properties of some of the most commonly used pesticides in Texas.**

Chemical	Water Solubility	Half-life (days)
Methyl Parathion insecticide	low	5
Carbaryl insecticide	low	10
PCNB fungicide	very low	21
Disulfoton insecticide	low	30
Malathion insecticide	low	1
Chlorthalonil fungicide	very low	30
Phorate insecticide	low	60
Diazinon insecticide	low	40
Methamidophos insecticide	high	6

## Ways Agricultural Pesticides Can Contaminate Water

The over-application or misuse of pesticides and other agricul-

tural chemicals (such as fertilizers) can allow these chemicals to enter surface and ground water. Drift, evaporation and wind erosion can carry pesticide residues into the atmosphere. From there they can fall in rain or snow to contaminate lakes and

## Pesticide Properties

Properties that affect a pesticide's potential to pollute water include formulation, toxicity, persistence, volatility, solubility in water, and soil adsorption. Of course, pollution risk also is affected by soil characteristics, application methods, weather and other factors.

## Formulation

Pesticides come in several physical forms or formulations that make them easy to store, transport and apply, and that help in controlling target pests. Common formulations include water dispersible granules, wettable powders, dusts, aerosols, solid or liquid baits, granules, emulsifiable and flowable concentrates and solutions. There are other less common formulations designed

to give special properties to the pesticide mixture or to take advantage of properties of active ingredients or protect the environment. These include microcapsules, plastic beads, plastic membranes, plastic ropes, controlled release dispensers and others.

While most environmental hazards come from the active ingredient in a pesticide, the way its formulation interacts with the environment determines the overall hazard of a pesticide. Spray formulations can drift with the wind or vaporize into the air. Other formulations can leach into ground water or be carried into surface water by rainfall or irrigation runoff. Even pesticides in formulations that bind them to soil particles can find their way into surface waters if soil is eroded by wind or water.

## Toxicity

The active ingredient is the chemical compound in a pesticide that kills or otherwise affects the target pest. Other substances in a pesticide formulation are inert ingredients that act as carriers and preservatives for active ingredients, and also make mixing and application easier.

When determining whether and how to register a pesticide, the EPA considers the toxicity of the active ingredient. Toxicity is determined by the amount required to produce biological effects.

## Dose and Effective Dose

A *dose* is the amount of a substance used at one time. Most substances are toxic at large enough doses, but harmless or even beneficial at lower doses.

Drinking water is an example. People need to drink some water every day. However, drinking the equivalent of 15 percent of one's body weight can be fatal. Similarly, table salt is absolutely necessary for proper health, but as little as 1 ounce (2 Tablespoons) of table salt would deliver a lethal dose to a 1-year-old child. There is a lethal dose of caffeine in 100 cups of coffee. There is a lethal dose of alcohol in a quart of whiskey. There is a lethal dose of oxalic acid in 20 pounds of spinach. There is a lethal dose of aspirin in 100 tablets. We can compare aspirin with two chemical pesticides. Malathion is about half as toxic as aspirin. Parathion is 70 times more toxic than aspirin. The hazards of pesticide residues are negligible compared to the dangers from common household chemicals and medicines. Table 2 compares toxicities of common products with pesticides.

The effective dose is the amount of a substance needed to kill or otherwise affect a target pest. Amounts less than the effective dose will likely not kill the target pest. Amounts greater than the effective dose will not necessarily be more effective in killing the target pest. Instead, this larger dose may kill more non-target organisms, cost more, and pollute the environment.

Common measures of a chemical's toxicity are the LD<sub>50</sub> and LC<sub>50</sub>. These measures refer to doses that kill 50 percent of the animals in a test group. These toxicity terms can apply to target pests or non-target organisms, including humans. The toxicity of a substance determines its proper dosage.

The LD<sub>50</sub> is the dose of a particular material, taken through the mouth, skin, or inhaled, that is lethal to 50 percent of a group of test animals. The higher an LD<sub>50</sub> is,

**Table 2. Comparative toxicity of pesticides and natural products (1995 Farm Chemicals Handbook; Gosselin *et al.* 1984; SIPRI 1973).**

Pesticide	LD <sub>50</sub> (Rat) in mg/kg	Other product with about equal toxicity
TCDD (Dioxin®)	0.0002	Ricin (castor bean extract)
Saran (GB nerve gas)	0.2	Black widow spider venom
Flocoumafen (rodenticide)	0.25	Strychnine
Aldicarb (insecticide)	0.9	Nicotine alkaloid (free base)
Phorate (insecticide)	1.0	Heroin
Parathion (insecticide)	2.0	Morphine
Carbofuran (insecticide)	8	Codeine
Nicotine sulfate (insecticide)	50	Caffeine
Paraquat (herbicide)	150	Benadryl (antihistamine)
Carbaryl (insecticide)	250	Vitamin A
Acephate (insecticide)	833	Salt substitute (KCl)
Allethrin (insecticide)	1,160	Gasoline
Diazinon (insecticide)	1,250	Tobacco
Malathion (insecticide)	5,500	Castor oil
Ferbam (fungicide)	16,900	Mineral oil
Methoprene (hormone)	34,600	Sugar

the lower the toxicity of the substance. Items with low LD<sub>50</sub>s are extremely toxic. Basic measuring units used are milligrams of toxin per kilograms of body weight, or "mg/kg." Table 2 shows the LD<sub>50</sub> values in rats for various pesticides and other familiar chemicals. Aspirin, table salt and other common natural products provide comparisons.

EPA uses LD<sub>50</sub>s to determine the safe level of pesticide residues in water. The rat is a common test animal for LD<sub>50</sub>s, but certain environmental studies require LD<sub>50</sub>s for animals such as rabbits and mice, birds such as bobwhite quail and mallard ducks, fish such as trout and bluegill, and arthropods such as houseflies, honeybees and daphnia (a small fresh-water crustacean).

LC<sub>50</sub> is another measure of toxicity. LC<sub>50</sub> stands for the concentration of a material in air or water that will kill 50 percent of the animals tested.

The toxicity of a pesticide is different from the hazard it represents. Hazard refers to the likelihood that a substance will cause harm under certain conditions. For example, the pesticide paraquat is highly toxic. Just a few drops can kill an adult human. There is no antidote for paraquat poisoning. Used properly and stored in a tight container, paraquat has high toxicity and a low hazard. If the contents of the container spill, however, the toxicity remains the same but the hazard increases enormously.

## Regulating Toxins in Water

The EPA uses the properties of chemicals to establish standards for toxins in water. The standard for water is the *MCL* or Maximum

Contaminant Level. When drinking water exceeds the MCL set for a specific chemical, EPA must take action to increase regulation of the offending product.

EPA sets MCLs at a very low, very safe level. They are less than 1/1,000th of the dose required to have a measurable effect.

Scientists measure pesticide residues in water in parts per million (ppm), parts per billion (ppb), parts per trillion (ppt) and parts per quadrillion (ppq). One part per million is equivalent to one drop of pesticide in 21.7 gallons of water. This is enough to fill a small garbage can. One part per billion is equal to one drop in a 21,700-gallon swimming pool. One part per trillion is one drop in 1,000 swimming pools. One part per quadrillion (ppq) is equal to one drop in a million swimming pools. This is enough water to fill a volume 1 mile long, 1 mile wide and 1 mile deep.

Table 3 shows MCLs for several pesticides found in water. Water containing these amounts of the various pesticides shown is completely safe to drink. Furthermore, a 150-pound man would have to

drink at least 75 gallons of water daily to consume even these amounts of pesticides.

## Persistence

Persistence describes how long a pesticide remains active. Half-life is one measure of persistence. The half-life of a substance is the time required for that substance to degrade to one-half its original concentration. In other words, if a pesticide has a half-life of 10 days, half of the pesticide normally breaks down by 10 days after application. After this time, the pesticide continues to break down at the same rate. The half-life of a pesticide is not an absolute factor. Soil moisture, temperature, organic matter, available oxygen, microbial activity, soil pH, photodegradation and other factors may cause the half-life of a substance to vary. In general, the longer a pesticide persists in the environment, the more likely it is to move from one place to another and be a potential source of pollution.

**Table 3. MCLs for pesticides found in drinking water.**

Contaminant	Product type	MCL (ppm)
1,2 Dichloropropane	Fumigant	0.005
2,4-D	Herbicide	0.07
Alachlor	Herbicide	0.002
Aldicarb	Insecticide	0.003
Atrazine	Herbicide	0.003
Dibromochloropropane (DBCP)	Fumigant	0.0002
Ethylene dibromide (EDB)	Fumigant	0.00005
Glyphosate	Herbicide	0.7
Oxamyl	Insecticide	0.2
Picloram	Herbicide	0.5

## Volatility

Many pesticides, including several types of herbicides and soil fumigants can escape from soils as gases (see Fig. 2). Some can distill from soils and enter the atmosphere with evaporating water. Pesticide particles in the atmosphere can come back to earth in rain or snow, and then either leach into ground water or be carried by runoff into surface waters.

## Water Solubility

The water solubility of a pesticide determines how easily it goes into solution with water. When these compounds go into solution with water they can travel with it as it runs off the land or leaches through the soil. The solubilities of materials such as pesticides are usually given in parts per million (ppm), or in some cases as milligrams per liter (mg/l). The solubility of a substance is the maximum number of milligrams that will dissolve in 1 liter of water.

Simply being water soluble does not mean that a pesticide will leach into ground water or run off into surface water. However, solubility does mean that if a soluble pesticide somehow gets into water, it will probably stay there and go where the water goes. Some pesticides must be somewhat soluble in water to work properly. Others cannot be water soluble to work properly. Manufacturers and the EPA consider solubility carefully when registering a pesticide product. It is important not only to apply pesticides correctly, but also to mix, load, handle and dispose of pesticides and their containers according to label directions. Care with clean-up and disposal is critical when handling pesticides that are soluble in water.

## Soil Adsorption

Soil adsorption is the tendency of materials to attach to the surfaces of soil particles. If a substance is adsorbed by the soil, it stays on or in the soil and is less likely to move into the water system unless soil erosion occurs. A soil's texture, structure and

organic matter content affect its ability to adsorb chemicals. If you don't know what type of soil you have, send a sample to a laboratory for analysis. Once you know your soil type you can find out its potential risk for pollution by referring to a U.S.D.A. publication called "Soil Ratings for Determining Water Pollution Risks for Pesticides."

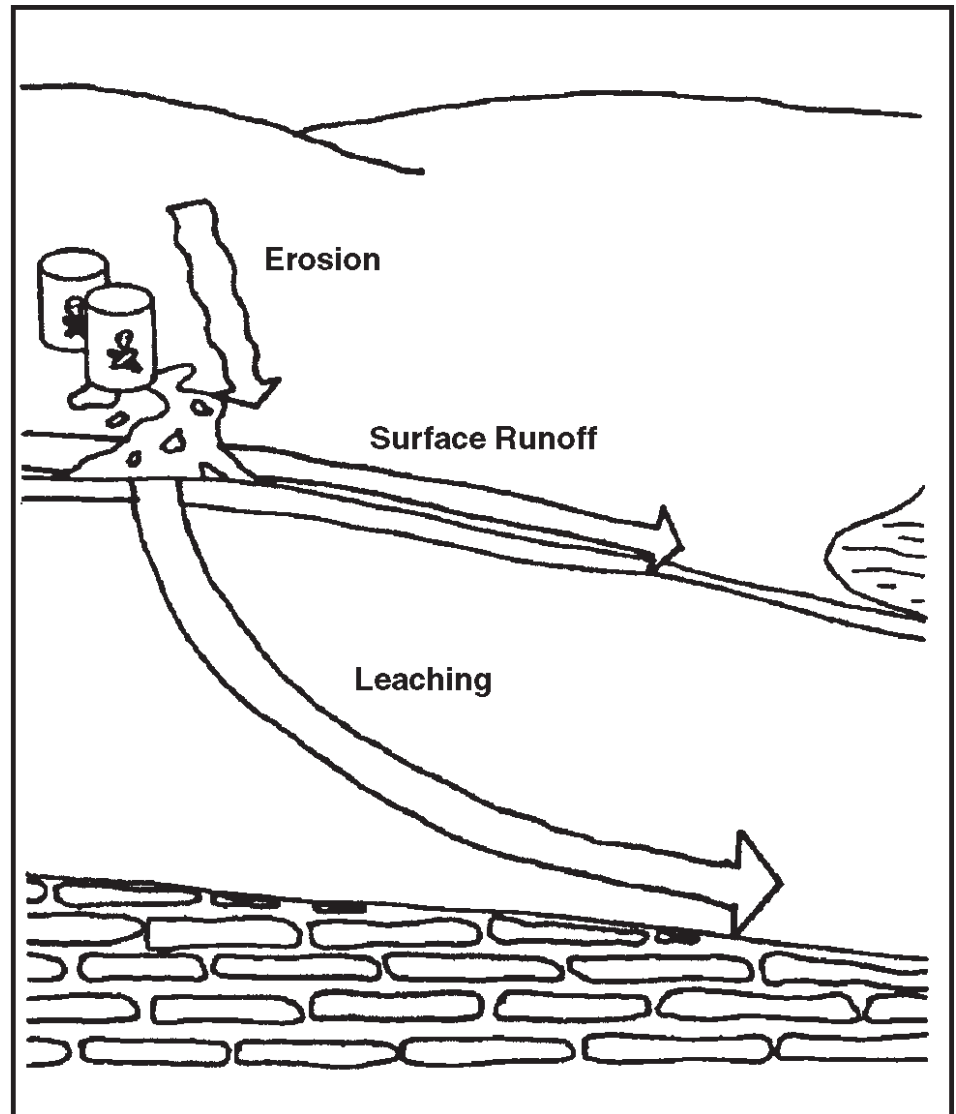

**Figure 3. Pesticides can pollute water through either surface runoff or leaching.**

## How Pesticides Enter Surface and Ground Water

Pesticides can enter water through surface runoff, leaching or erosion. Water that flows across the surface of the land, whether from rainfall, irrigation, snow melt or other sources, always flows downhill until it meets a barrier, joins a body of water, or begins to percolate into the soil. Some pesticides and fertilizers can be carried along with runoff.

Wind and water can erode soil that contains pesticide residues and carry them into nearby bodies of water. Even comparatively insoluble pesticides and pesticides with high soil adsorption properties can move with eroding soil.

With increasing frequency, soil-applied pesticides also are being found in ground water across the U.S., and regulating agencies are taking action to prevent this from occurring. Pesticides have to have several characteristics before they pose a risk to ground water. They have to be water soluble enough to move in the soil. They have to persist long enough to be carried beyond the region of bacterial activity in the soil. They have to be applied at rates high enough to allow them to persist. They have to be applied to soils that will not bind them tightly or deactivate them. They must be applied in regions where climatic factors, including precipitation, will allow them to move through the soil. And, they have to be applied in regions where ground water exists and where it is shallow enough for substances leaching from the surface to reach it.

Pesticides that enter water supplies can come either from point sources or from non-point sources (Fig. 4). Point sources are small, easily identified objects or areas of high pesticide concentra-

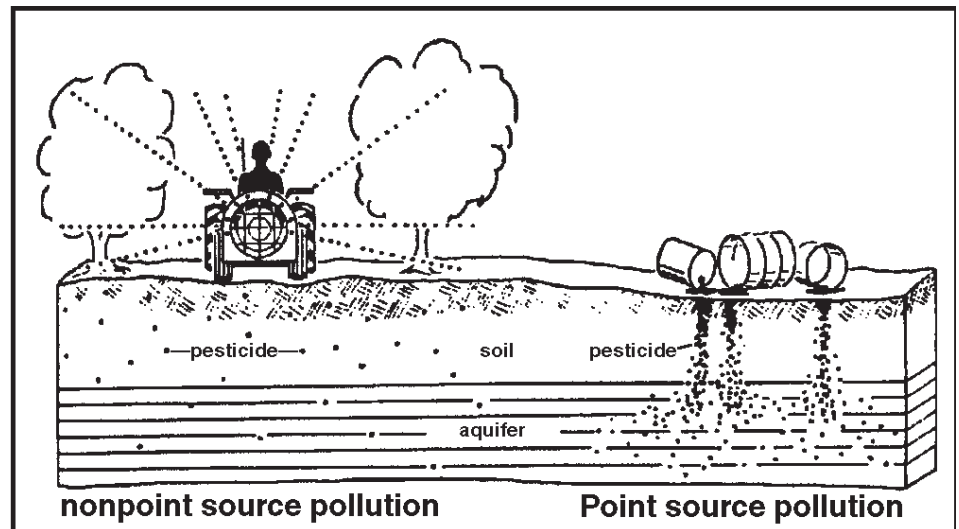

Figure 4. Point and non-point source pollution.

tion such as tanks, containers or spills. Non-point sources are broad, undefined areas in which pesticide residues are present.

## Insecticides

By far, insecticides are the largest group of pesticides. Insecticides are chemicals used to kill, repel, alter the growth patterns, or manipu-

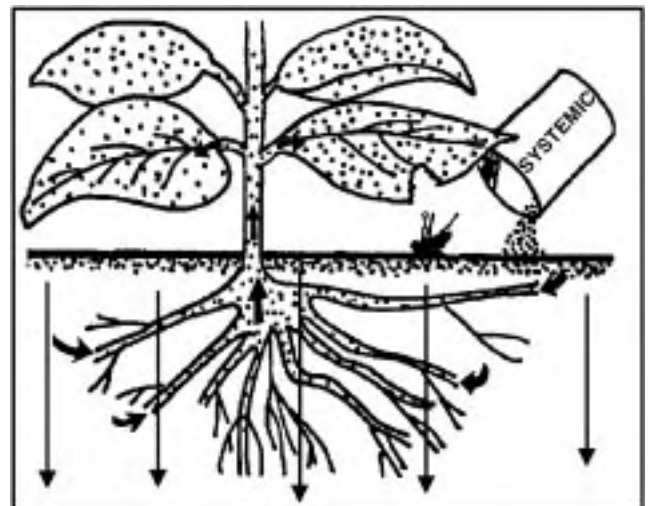

Figure 5. Water soluble pesticides leach more readily into ground water.

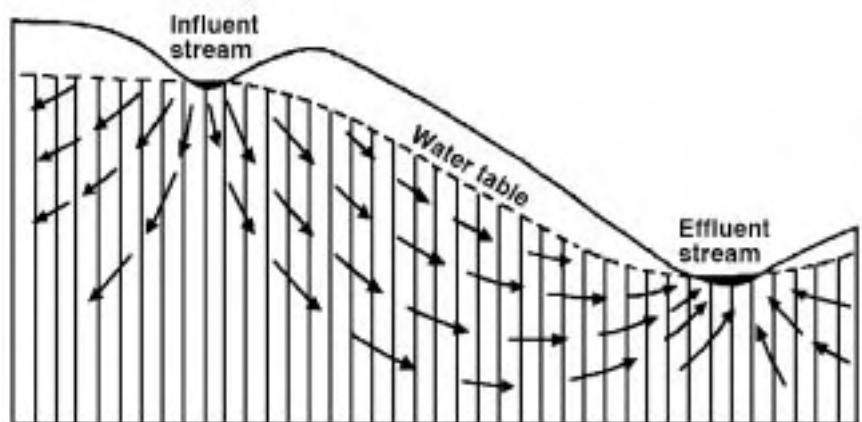

Figure 6. Percolation can transport water soluble pollutants from one body of water to another.

late the behavior of insects, other arthropods and nematodes. Insecticides include a wide variety of chemical compounds ranging from highly toxic nerve poisons to practically non-toxic pheromones.

Table 4 shows the four most used insecticides in the United States. Hundreds of others also have very wide use. Other pesticides that kill animals are the rodenticides for rodents, molluscicides for slugs and snails, piscicides for fish, avicides for birds, and predacides for predators. These are not as widely used as insecticides, but some of them have similar properties.

**Table 4. Approximate volumes of the most widely used insecticides in the United States (U.S. Environmental Protection Agency, 1992.)**

Insecticide	Usage in million pounds active ingredient (avg. 1991-1992)
Chlorpyrifos	15.0
Carbaryl	12.5
Malathion	12.5
Terbofos	10.0

Most insecticides applied to agricultural crops and in urban areas break down after a given time. However, some are very persistent and may remain in the environment for a long time. Persistence is a good quality for some insecticides, because it makes them effective in killing pests for a long time. However, persistent insecticides are more apt to find their way into water supplies at a level of toxicity that can cause problems. These substances can build up in invertebrates and fish. They can pass through the food chain to fish, birds, mammals, and even humans.

Insecticides have varying toxicity for aquatic organisms. Some can kill fish; some disrupt the food chain by killing aquatic insects and other organisms upon which fish depend for food. Table 5 shows the characteristics of several insecticides used in homes, gardens and agriculture. Some are general-use and others are restricted-use pesticides. Two restricted-use insecticides, aldicarb and oxamyl, have been reported in surface and ground water in several states.

## Insecticide Leaching and Solubility

Several systemic insecticides that are applied to the soil are water soluble to allow them to be taken up through plant roots. Many of these are highly toxic to mammals. Table 6 shows some of the soil-applied systemic insecticides, their LD<sub>50</sub>s and water solubility. Soluble systemic insecticides

such as aldicarb and oxamyl are used at heavy rates (more than 10 pounds per acre) for nematode control. They persist for weeks, sometimes months, in the soil. Erosion can carry them into surface waters where they dissolve readily. Leaching can drive them into ground water. The EPA and the U.S. Geological Survey have reported their presence in ground water in several eastern states since the 1970s. Aldicarb was the first pesticide to be regulated by the EPA in an attempt to protect ground water.

## Herbicides

Herbicides are among the most widely used chemicals in the U.S. They account for more than 70 percent of the total volume of pesticides applied in agriculture. Herbicides generally work by altering one or more of the following processes: seedling

**Table 5. Common insecticides with their chemical properties and toxicity to fish (Environmental Protection Agency, 1992).**

Insecticide	Solubility in runoff	Mobility in soil water	Half-life in days	Relative toxicity to fish <sup>1</sup>
Hydramethylnone	high	small	10	high
Diazinon	medium	high	30	high
Aldicarb	medium	high	>30	very high
Oxamyl	high	high	10	very high
Chlorpyrifos	high	small	30	very high
Malathion	small	small	1	very high
Acephate	small	small	3	very low
Carbaryl	medium	small	10	medium
Dimethoate	small	medium	7	medium
Trichlorfon	small	high	27	high
Dicofol	high	small	60	high
Propargite	high	small	56	high

<sup>1</sup>Fish toxicity based on catfish and bluegill. LC<sub>50</sub> categories are rated as follows: very low = more than 100 mg/l, low = 10 to 100 mg/l, medium = 1 to 10 mg/l, high = 0.1 to 1 mg/l, very high = less than 0.1 mg/l.



**Table 6. Some systemic insecticides leach into ground water because of their solubility, persistence, soil adsorption, rates of application, or widespread use. Weather, climate, precipitation and soil characteristics also can influence leaching.**

Systemic insecticide common name	Solubility (ppm)	Toxicity (LD <sub>50</sub> ) (rat) in mg/kg	Persistence in the soil	Soil adsorption
aldicarb	6,000	0.9	medium	low
phorate	500	1	medium	medium
disulfoton	25	2	medium	medium
terbufos	15	4.5	medium	low
fenamiphos	25	6	medium	low
oxamyl	28	4	medium	low
imidacloprid	soluble	5,000	low	medium
carbofuran	351	4	medium	medium
acephate	650,000	1,447	low	medium

growth, transport of water and nutrients, production of plant foods (photosynthesis), plant cell development, and plant protein or lipid synthesis. Most herbicides are not very toxic to mammals.

The range of plants affected by a particular herbicide may be broad or very narrow. Some herbicides are toxic to almost all plants. These chemicals are appropriately named non-selective herbicides. Non-selective herbicides are useful for controlling vegetation along roadsides and railroad rights-of-way, on parking lots, or around petroleum storage facilities and electric power stations. Non-selective herbicides also can be used to control weeds when the physical characteristics of the target weeds are different from those of desirable plants nearby.

Many herbicides are designed to kill only certain plants. These are called selective herbicides. Most of the herbicides presently registered are selective, and they are used most widely in agriculture.

Selective herbicides may affect only a few weeds or a wide variety of plants. Most selective

herbicides are very broad-spectrum plant killers. Some kill grasses and broadleaf plants and a few desirable plants. Others kill only broadleaf plants or only grasses. Some of the most highly selective herbicides kill only a single weed species, and only at one particular point in the plant's growth cycle. The usefulness of a selective herbicide lies not only in what it will kill, but also in what it will leave alive. One very broad-spectrum herbicide, clopyralid, is almost universally toxic to broadleaf plants, but does not affect seedling sugar beets.

The persistence of some herbicides can be looked upon as either a detriment or advantage. Obviously, the longer these materials remain active in the soil, the less appealing they are environmentally. However, to the farmer, weed control throughout the crop growing season (generally 3 to 6 months) is essential to ensure a good quality, profitable crop.

Sometimes the herbicide's active ingredient is not as toxic as its inert ingredients. Therefore, the formulation may have more impact on the toxicity of the product than the active herbicide

ingredient. Table 7 gives properties of some common herbicides.

## Herbicides in Surface and Ground Water

Herbicides vary widely. Some are water soluble enough to enter lakes or streams with rainfall or runoff irrigation water, but the hazard they represent depends on their persistence and interaction with the soil. They can also leach into ground water or move with eroding soil.

Many herbicides designed to be applied to emerged plants are inactivated once they reach the soil surface. Soil-applied herbicides, however, must be soluble in soil water in order to move into the root zones of target weeds. Some move deeply into the ground to kill deep-rooted perennials. Others don't move as deeply in order to kill shallow-rooted weeds and spare a deeper rooted crop.

Among the soil-applied herbicides that are taken up by plant roots are the triazines. Several of these have been detected in

**Table 7. Characteristics of some commonly used herbicides, with relative toxicity to fish (U.S. Environmental Protection Agency, 1992).**

Herbicide	Solubility in runoff	Mobility in soil water	Half-life in days	Relative toxicity to fish <sup>1</sup>
MSMA	high	high	100	very low
Benefin	high	low	30	very high
Dicamba Salt	low	high	14	low
2,4-D Amine Salt	low	medium	10	very low
MCPA Amine Salt	low	high	21	low
Pendimethalin	high	low	90	high
Glyphosate Amine Salt	high	low	47	very low
Metribuzin	medium	large	40	medium

<sup>1</sup>Fish toxicity based on catfish and bluegill. LC<sub>50</sub> categories are rated as follows: very low = more than 100 mg/l, low = 10 to 100 mg/l, medium = 1 to 10 mg/l, high = 0.1 to 1 mg/l, very high = less than 0.1 mg/l.

surface and ground waters across the United States at levels near the MCL. Triazine herbicides are of particular concern to the EPA. Some triazines are very stable in the environment and may persist for long periods in the soil. The discovery of two widely-used triazines in surface and ground waters prompted the EPA to start a special review of all triazines in 1994. Table 8 shows some triazine herbicides, both those reported and not reported in U.S. waters.

Many triazines that have found their way into water supplies are important herbicides in corn. They are applied at the rate of several pounds per acre on millions of acres of corn. Studies show that the half-life of atrazine can exceed 170 days. Although simazine is not as soluble, it also has found its way into the nation's water supplies. Other, more soluble, triazines have not been found in ground water for reasons that include soil adsorption, short persistence, use patterns, and the depth of the ground water where they are used (Table 8).

Several other herbicides such as alachlor, diquat, glyphosate, picloram, and 2,4-D also have been detected in surface and ground water, and the EPA has assigned MCLs to all of them (Table 3).

## Fungicides

Fungicides are used to control microorganisms. We could not feed this country without modern fungicides to control plant diseases. Moreover, toxic plant disease organisms would make food far more dangerous than fungicide residues at the maximum levels prescribed by the EPA. If you want to save your lawn, crops, garden or ornamental trees and shrubs, you must use fungicides.

Fungicides are of small concern in protecting water quality. They are used less frequently than other pesticides, and most are not persistent. However, they can be a possible source of pollution if applied, stored or disposed of improperly. Even when applied correctly, these substances can drift away from the application area, leach into ground water and be carried away by runoff. Table 9 lists some fungicides commonly used by homeowners and farmers, and in industry. Fungicides are seldom found in water, with the exception of some of the heavy metal fungicides that contained mercury. The EPA has cancelled most

**Table 8. The solubility, persistence and soil adsorption characteristics of triazines.**

Triazines - common name	Solubility (ppm)	Persistence (half-life)	Soil adsorption
metribuzin	1,200	medium	medium
prometon	620	high	low
hexazinone	330	medium	medium
ametryn	185	low	medium
atrazine	33	high	low
prometryn	33	medium	medium
cyanazine	16	low	medium
simazine	3.5	high	low

**Table 9. Risk factors of some commonly used fungicides.**

Fungicide	Hazards
Mancozeb	Cancer (Ethylenethiourea)
Thiram	Nerve poison, birth defects
Benomyl	Birth defects
Thiophanate	Mutations, birth defects
Pentachloronitrobenzine	Accumulates in food chains, hormone effects
Phenyl mercuric acetate	Heavy metal poisoning
Fixed Copper	Toxic to plants and phytoplankton
Kitazin-P	Nerve poison
Streptomycin	Allergic reaction

uses of these fungicides. When using a fungicide, always follow instructions on the label to minimize the risk of water pollution.

## Soil Fumigants and Ground Water

Soil fumigants are gaseous chemicals applied to the soil to control various pests such as plant disease organisms, insects and weed seeds. They are non-selective, and many are toxic to all life forms. They have various chemical properties. Fumigants are very nonpersistent. They last from a few days to a few weeks after application. With the exception of metam-sodium, most are only slightly soluble in water. Fumigants can move rapidly through the soil-gas interface and can dissolve in various amounts in soil water. The same factors that affect insecticides and herbicides also govern the movement of soil fumigants into ground and surface waters.

Soil fumigants such as ethylene dibromide, dibromochloropropane, metam-sodium and dichloropropane have been detected in ground and surface waters. The chlorinated fumi-

gants can produce serious chronic effects at low concentrations, and the EPA has assigned them very low MCLs (Table 3).

Soil fumigants are usually applied at much higher rates than other pesticides. Rates of several hundred pounds per acre are common. Most of this use occurs in California, Florida and Texas. Residues of dibromochloropropane in California's ground water influenced EPA to cancel that product. Dichloropropene also has been detected in ground water in the San Joaquin Valley of California. In October, 1996, the EPA levied heavy fines against an Idaho company for misapplication of the fumigant metam-sodium which caused contamination of the Snake river.

## Water Quality Protection

Most water pollution does not come from the normal, correct usage of pesticides. Problems arise from misuse or careless handling. Here is a checklist to use when applying any pesticide. These guidelines can help safeguard the future of our water quality.

- Read all product labels and follow label directions.
- When possible, use pesticides and fertilizers with less potential for surface runoff or leaching.
- Use integrated pest management (IPM) tactics to control pests, using pesticides only when necessary.
- Don't apply pesticides when conditions are most likely to promote runoff or excessive leaching.
- Have soil tested to determine the fertilizer needs of a given crop.
- Store potential water pollutants away from water sources such as wells, ponds and streams.
- Don't spray pesticides on a windy day (wind more than 4 mph).
- Calibrate all pesticide application devices to ensure that the correct dosage is being applied.
- Prevent pesticide spills and leaks from application equipment.
- Make sure product containers do not leak.
- Do not dispose of leftover materials by dumping them in drains or on the ground. Dispose of pesticides according to label directions.
- Use low-toxicity products when a choice is possible.
- Use narrow spectrum products when a choice is possible.
- Prevent back flow during mixing operations by maintaining an air gap between the water fill hose and the water level in the spray tank

- Always mix, handle and store pesticides down slope from and at least 150 feet from water wells.
- Consider the vulnerability of the site; be sure that weather and irrigation won't increase the risk of water pollution.
- Evaluate the location of water sources.
- Leave buffer zones around sensitive areas such as wells, irrigation ditches, ponds,

streams, drainage ditches, septic tanks, and other areas that lead to ground or surface water. Don't apply pesticides in these locations.

- If you use a spray system hooked to your hose, use a backup nozzle on your house connection to prevent pesticides from flowing back into your home water system.
- Use up pesticides on your shelf before buying more.

- Use up older pesticides before they exceed their shelf life.
- Do not water pesticide-treated areas immediately after application unless indicated on label instruction. Runoff could carry pesticides into storm drains that empty into lakes, rivers or streams.
- Do not use banned or canceled pesticides. Such materials should be stored safely until a hazardous waste disposal event is organized in your community.

# Glossary

---

**Adsorption** - The adhesion of materials to the surface of a solid.

**Bioaccumulation** - The storage or accumulation of materials in the tissues of living organisms.

**Broad spectrum** - A pesticide that will control a wide variety of organisms.

**Carcinogenic** - A property that makes a material more likely to cause cancer in humans or animals that are exposed to it.

**Efficacy range** - How many or how few organisms a pesticide will control.

**Ground water** - A region within the earth that is wholly saturated with water.

**Inert** - A substance that is not reactive in the environment and does not contribute to the action of the

active ingredient. Inert materials often function as carriers and dilutors of active ingredients.

**Leaching** - Dissolving and transporting of materials by the action of percolating water.

**Narrow spectrum** - A pesticide that will control only a few organisms.

**Non-selective** - A pesticide that will kill or control both target pests and desirable organisms.

**Non-target** - An organism towards which an application is not directed.

**Persistence** - The ability of a substance to remain in its original form without breaking down.

**Pesticide** - A material used to kill an unwanted pest.

**Selectivity** - The ability of a pesticide to control target pests but

not desirable or beneficial crops and organisms.

**Solubility** - The ability to be put into solution.

**Target pest** - An unwanted species toward which a pesticide application is directed.

**Target weed** - An unwanted weed species toward which an herbicide application is directed.

**Toxic** - Poisonous to an organism with which it comes in contact.

**Toxin** - A substance that is poisonous to a given organism.

**Water pollution** - A detrimental change in the chemical or physical properties of water.

**Water table** - the upper limit of the saturated level of the soil.

# References

---

- Adams, C.D., and Thurman, E.M. 1991. Formation and transport of deethylatrazine in the soil and vadose zone. *Journal of Environmental Quality*. 20:540-547.
- Cuello, C., et al. 1976. Gastric cancer in Colombia I. Cancer risk and suspect environmental agents. *Journal of the National Cancer Institute*. 57(5): 1015-1020.
- Dorsch, et al. 1984. Congenital malformations and maternal drinking water supply in rural South Australia: A case control study. *American Journal of Epidemiology*.119(4): 473-486.
- Eardley, A.J. 1965. Ground Water. *General College Geology*. Harper & Row. New York, N.Y. pp. 148-169.
- Farm Chemicals Handbook '95*. 1995. Meister Publishing Co., Willoughby, Ohio.
- Gosselin, R.E., H. C. Hodge, R.P. Smith and M.N. Gleason. 1976. *Chemical Toxicity of Chemical Products*. The Wilkins & Wilkins Co., Baltimore, Md.
- Knox, E.G. 1972. Anencephalus and dietary intakes. *British Journal of Preventive and Social Medicine*. 26:219-223.
- Mills, M.S. and Thurman, E.M., 1994. Reduction of nonpoint-source contamination of surface water and ground water by starch encapsulation of herbicides. *Environmental Science and Technology*. 28: 73-79.
- Molihagen, Tony, Lloyd Urban, R. Heyward Ramsey, A. Wayne Wyatt, Don McReynolds and J. Tom Ray. 1993. *Assessment of Non-Point Source Contamination of Playa Basins in the High Plains of Texas*. Water Resources Center, Texas Tech University.
- Moon, T.J., P.B. Mann and J.H. Otto. 1956. *Modern Biology*. Henry Holt and Company, New York, N.Y.
- National Research Council. Board on Agriculture. 1993. *Soil and Water Quality: An Agenda For Agriculture*. National Academy Press, Washington, D.C.
- National Academy of Sciences, Safe Drinking Water Committee. 1977. *Drinking Water and Health*. Washington, D.C.
- NRDC. (Natural Resources Defense Council). 1994. *Think Before You Drink: 1992-93 Update*. Washington, D.C.
- Paterson, K.G. and J. L. Schnoor. 1992. Fate of Alachlor and Atrazine in Riparian Zone Field Site. *Research Journal of the Water Pollution Control Federation*. 64:274-283.
- SIPRI (Stockholm International Peace Research Institute). 1973. J.P. Robinson, C.G. Heiden and H. von Schreeb, eds. *CB Weapons Today*. Humanities Press, New York, N.Y.
- Squillace, P. J., E.M. Thurman and E.T. Furlong 1993. Groundwater as nonpoint-source of atrazine and deethylatrazine in a river during base flow conditions: *Water Resources Research*. 29(6): 1719-1729.
- Stiegler, J.H., J.T. Criswell and M.D. Smoten. *Pesticides in ground water*. OSU Extension Facts, No. 7459: 1-4.
- Terry, et al. 1995. *Commercial Fertilizers 1995*. The Association of American Plant Food Control Officials/The Fertilizer Institute. Washington, D.C.
- Texas Agricultural Extension Service. 1993. Pesticide Use Survey Database.
- Texas Agricultural Extension Service. 1993. *Pesticide Applicator Training, General Manual, Commercial/Noncommercial*. B-5056.
- Texas Agricultural Extension Service. 1993. *Structural Pesticide Applicator Training, General Manual, Commercial/Noncommercial/Technician*. B-5073.
- Thomas, H.E. 1955. Underground sources of our water. *Water, The Yearbook of Agriculture*. United States Department of Agriculture.
- United States Office of the Federal Register. 1995. *Code of Federal Regulations, Title 40 part 143, Drinking Water*.
- United States Environmental Protection Agency. 1990. *The quality of our nation's water: A summary of the 1988 national water quality inventory*. EPA Pub. No.440/4-90-005.
- United States Environmental Protection Agency. 1992. *Pesticide industry sales and usage, 1990 and 1991 market estimates*. EPA Pub. No. 733-K-92-001.
- Ware, G.W. 1992. *Reviews of Environmental Contamination and Toxicology*. Springer-Verlag, New York, N.Y.

Funds for this publication were derived partially from support by the Cooperative State Research, Education and Extension Service, USDA under special project numbers 95-EHUA-1-0138, 95-EHUA-1-0139, 94-EWQD-1-9518, 94-EHUA-1-0109.

For Sale Only: \$1.00

*Educational programs of the Texas Agricultural Extension Service are open to all people without regard to race, color, sex, disability, religion, age or national origin.*

---

Issued in furtherance of Cooperative Extension Work in Agriculture and Home Economics, Acts of Congress of May 8, 1914, as amended, and June 30, 1914, in cooperation with the United States Department of Agriculture, Zerle L. Carpenter, Director, Texas Agricultural Extension Service, The Texas A&M University system.



# Chemigation Equipment and Safety (L-2422)

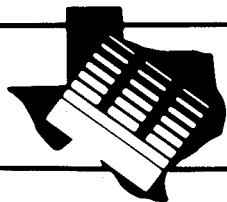

# Texas Agricultural Extension Service

## Chemigation Equipment and Safety

L. Leon New and G. Fipps

### Chemigation

*Chemigation* is the process of injecting an approved chemical into irrigation water and applying it through the irrigation system to a crop or field. Chemigation is not a new concept, but has been used for years. Recent progress in chemigation equipment and know how allows for more effective chemigation through drip and sprinkler irrigation systems, particularly center pivots.

The earliest work applying chemicals through sprinklers was with fertilizers, known as *fertigation*. *Herbigation* soon followed, which is the application of herbicides through an irrigation system. Next came *insectigation* with insecticides, *fungigation* with fungicides and *nematigation* with nematocides. The term chemigation describes the application of all these chemicals through the irrigation system.

### Advantages of chemigation

**Uniformity of application** - With a properly designed sprinkler irrigation system, both the water and chemicals can be uniformly applied, resulting in excellent distribution of the water-chemical mixture.

**Precise application** - Chemicals can be applied where they are needed and in the correct concentrations.

**Economics** - Applying chemicals through chemigation is usually less expensive than conventional application methods. Often, the amount of chemicals needed can be reduced.

**Timeliness** - Chemicals can still be applied when other methods cannot be used due to wetness, excessive wind, applicator availability or other factors.

**Reduced soil compaction and crop damage** - Conventional in-field spray equipment is not needed, often

resulting in less soil compaction from tractor wheels and crop damage.

**Operator safety** - Because the operator is not continuously in the field during applications, reduced human contact with the chemicals from drift, frequent tank fillings and other exposures occur.

### Disadvantages of chemigation

**High management** - Chemical application requires safe use of chemicals, skill in calibration, knowledge of the irrigation and chemigation equipment and understanding of irrigation scheduling concepts.

**Additional equipment** - Proper injection and safety devices are essential. Legal equipment requirements have been established and must be used.

### Legal Requirements

The U.S. Environmental Protection Agency's Label Improvement Program (LIP) became effective in April 1988. Pesticide labels must now state whether the product is approved to be applied through the irrigation system. If so, application instructions are provided. In addition, the label improvement program requires the use of specific safety equipment and devices designed to prevent accidental spills. These requirements also aid the grower by providing for consistent, precise and continuous chemical injection, thus reducing the amounts (and cost) of chemicals applied.

Figure 1 illustrates some of the required safety equipment. A summary of chemigation pumping and safety equipment requirements is shown in Table 1. A list of alternate chemigation equipment approved by EPA is provided in Table 2.



## CHEMICAL INJECTION SAFETY CONNECTIONS

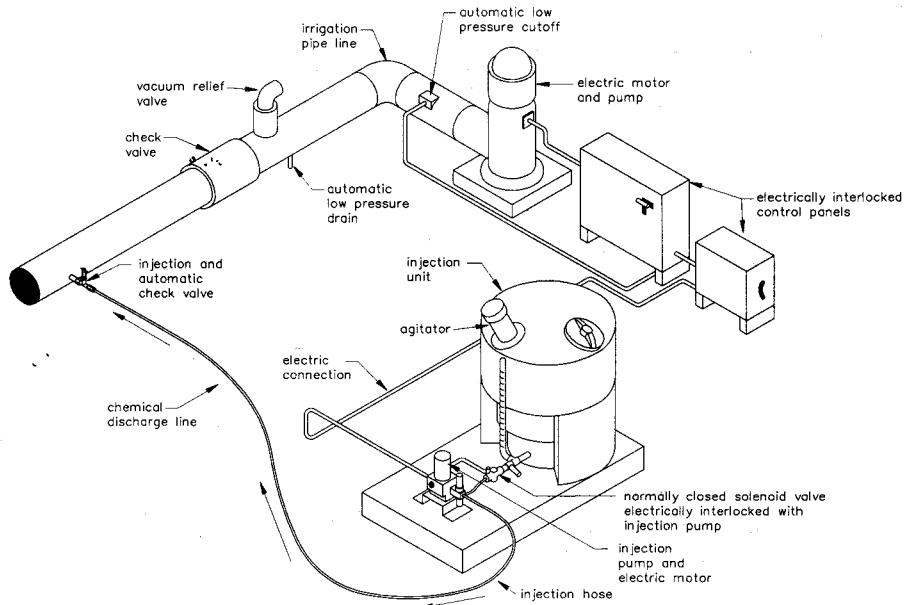

Figure 1. Chemical injection equipment for chemigation, showing some of the approved safety connections.

### Table 1. Summary of Chemigation Equipment Requirements.

Components must include:

#### 1. Irrigation Pipeline

- a. Check valve between well and injection points.\*
- b. Vacuum relief valve between check valve and well.
- c. Low pressure cut off.
- d. Low pressure drain.\*

#### 2. Injection Hose

- a. Anti-back flow injection valve - 10 psi.
- b. Normally closed solenoid valve between injection pump and chemical tank.\*
- c. A metering type injection pump.\*

#### 3. Power Interlock

- a. Interlock injection pump and water pump power.
- b. Interlock normally closed solenoid valve and injection pump power.

\* Alternative safety equipment may be substituted according to regulations approved by the EPA in March 1989. See Table 2.

The *check valve* in the irrigation pipeline prevents chemicals from going into the well if the irrigation pump inadvertently stops. The *vacuum relief valve* prevents a vacuum from being formed that could draw chemicals through the check valve. Small amounts of chemicals that may leak by the check valve are disposed of through the *low pressure drain*. The power

supply of the injection and irrigation pumps must be interlocked. When properly interlocked, the *low pressure cut off* will stop the injection pump should the irrigation pump's power fail.

The *anti-backflow injection valve* prevents water from flowing backward into the chemical tank should the injection pump fail. The *10 psi spring* prevents gravity flow of the chemical into the irrigation pipeline when both the injection pump and irrigation pump are shut down. The *normally closed solenoid valve*, or other alternatives, further ensure that no water will flow into the chemical tank and that no chemical will leave the tank unless it is pumped. *Power interlocks* ensure that all other power will be shut down should any equipment fail, including the center pivot.

### Management Practices for Chemigation

**Flushing injection system** - Flush the injection system with clean water after use to prevent accumulation of precipitates and contamination of the equipment, and to support future operation.

**Flushing irrigation system** - After injection is completed, operate the irrigation pump for at least 15 minutes to flush the chemical from the irrigation system. If the irrigation system stops automatically, flush the system as quickly as possible after the shutdown is

---

**Table 2. Alternative Chemigation Equipment Approved by the USEPA, March, 1989.**

---

**A. Original Device - Functional normally closed, solenoid-operated valve located on the intake side of the injection pump.**

**Alternative Device 1 - Functional spring-loaded check valve with a minimum of 10 psi cracking pressure.**

**Notes:** The valve must prevent irrigation water under operating pressure from entering the pesticide injection line and must prevent leakage from the pesticide supply tank on system shutdown. This valve must be constructed of pesticidal resistant materials. (Note: This single device can substitute for both the solenoid-operated valve and the functional, automatic, quick closing check valve in the pesticide injection line.)

**Alternative Device 2 - Functional normally closed hydraulically operated check valve.**

**Notes:** The control line must be connected to the main water line such that the valve opens only when the main water line is adequately pressurized. This valve must prevent leakage from the pesticide supply tank on system shutdown. The valve must be constructed of pesticidal resistant materials.

**Alternative Device 3 - Functional vacuum relief valve located in the pesticide injection line between the positive displacement pesticide injection pump and the check valve.**

**Notes:** This alternative is appropriate for only those chemigation systems using a positive displacement pesticide injection pump and is not for use with venturi injection systems. This valve must be elevated at least 12 inches above the highest fluid level in the pesticide supply tank and must be the highest point in the injection line. The valve must open at 6 inches water vacuum or less and must be spring loaded or otherwise constructed such that it does not leak on closing. It must prevent leakage from the pesticide supply tank on system shutdown. The valve must be constructed of pesticidal resistant materials.

**B. Original Device - Functional main water line check valve and main water line low pressure drain.**

**Alternative Device 1 - Gooseneck pipe loop located**

**in the main water line immediately downstream of the irrigation water pump.**

**Notes:** The bottom side of the pipe at the loop apex must be at least 24 inches above the highest sprinkler or other type of water emitting device. The loop must contain either a vacuum relief or combination air and vacuum relief valve at the apex of the pipe loop. The pesticide injection port must be located downstream of the apex of the pipe loop and at least 6 inches below the bottom side of the pipe at the loop apex.

**C. Original Device - Positive displacement pesticide injection pump.**

**Alternative Device 1 - Venturi systems including those inserted directly into the main water line, those installed in a bypass system, and those bypass systems boosted with an auxiliary water pump.**

**Notes:** Booster or auxiliary water pumps must be connected with the system interlock such that they are automatically shut off when the main line irrigation pump stops, or in cases where there is no main line irrigation pump, when the water pressure decreases to the point where pesticide distribution is adversely affected. Ventures must be constructed of pesticidal resistant materials. The line from the pesticide supply tank to the venturi must contain a functional, automatic, quick closing check valve to prevent the flow of liquid back toward the pesticide supply tank. This valve must be located immediately adjacent to the venturi pesticide inlet. This same supply line must also contain **either** a functional normally closed solenoid-operated valve connected to the system interlock **or** a functional normally closed hydraulically operated valve which opens only when the main water line is adequately pressurized. In bypass systems as an option to placing both valves in the line from the pesticide supply tank, the check valve may be installed in the bypass immediately upstream of the venturi water inlet **and** either the normally closed solenoid or hydraulically operated valve may be installed immediately downstream of the venturi water outlet.

**D. Original Device - Vacuum relief valve.**

**Alternative Device 1 - Combination air and vacuum relief valve.**

---

discovered, and extend the flushing period to a minimum of 30 minutes.

**Monitoring** - Periodic monitoring of the irrigation system and chemical injection equipment helps assure proper operation during any chemical application.

**Calibration check** - The pivot should be checked for uniform application and overall flow rate to make

sure the pivot system is performing as specified. A high uniformity coefficient is needed to ensure even coverage and to prevent either excessive or inadequate concentrations of chemicals in certain areas of the field.

**Drive units** - High speed center pivot drive units are desirable with some chemicals so lighter applications of water can be made.

**Chemical compatibility** - Check compatibility of the chemical with the water supply to prevent precipitate that could clog nozzles on the system.

**End guns** - Check the uniformity and application under the end gun, and shut it off if it is not desirable. Uniformity should match the system. However, in most cases, it is recommended to shut off the end gun during injections.

**Chemical labels** - Follow the label directions. Use only chemicals that are specifically labeled for chemigation. If a failure occurs, the user is liable.

**Runoff** - Manage the irrigation system to prevent runoff of the water-chemical mixture. If runoff occurs, take precautions to prevent it from leaving the field. With a given sprinkler package on a center pivot, reducing the amount or depth of application (i.e., making a faster revolution) reduces the potential for runoff.

**Application to surface water** - Avoid application of chemicals on fields with permanent or semi-permanent surface water areas. Such applications may affect wildlife, other nontarget plants and animals and groundwater quality.

## Chemigation Pumps

Three types of injection units are used for chemigation. The two types of *mechanical units* are piston (or positive displacement) pumps and diaphragm pumps. Both can be powered by belt drive or an electric or hydraulic motor and can be adjusted for various flow rates within a designed range.

Chemigation pumps should be selected so that chemicals can be applied at the appropriate rate. Injection pumps are commonly purchased with two heads, one for injection of low applications of insecticide and herbicide, and the other one for injection of 20 to 30 pounds of nitrogen per acre. With proper plumbing, both heads can be used simultaneously. Usually a single injection pump with two heads is available to apply appropriate quantities of two chemicals.

A single pump with two heads costs less than two injection pumps. When dual head pumps are used for simultaneous injection of two chemicals, install an injection and automatic check valve and injection hose for each head.

**Positive displacement pumps** are typically used to inject nitrogen fertilizer and usually cannot be easily adjusted to inject appropriate quantities of insecticide, fungicide and herbicide. There are various size pistons and pump arm assemblies available that can be

used to inject the correct amount of chemical and to accommodate the desired travel speed of the center pivot. Piston sizes 1/4 to 5/8 inch are more appropriate for low-rate injection and sizes 3/4 inch to 1 1/4 inches for intermediate and high chemical injection rates. Positive displacement pumps are stopped when changing injection rates, so more time may be required to set the accurate rate.

**Diaphragm pumps** are used extensively for low-rate chemical injection. Changes in injection rates can be made while running so accurate injection can be more conveniently established. In some cases, diaphragm pumps can be added to existing higher capacity injection units.

The third unit, the *venturi meter*, is a tube with a reduced diameter in the throat. Velocity changes in the throat create a vacuum that pulls the chemical into the water stream. Venturi meters require a constant water supply from an external water source, or may be equipped with a bypass and a small booster pump for use of water from the system. An additional pump or booster pump must be used for maintaining steady flow through the venturi at a higher pressure than the pivot. A small valve is used on the suction line to regulate the injection rate. Any variations in flow rate from the water supply will change the vacuum and the rate of injection.

All three pumps are satisfactory for injection of chemicals. Each should be calibrated and set for the volume of chemical to be injected and rechecked periodically. Clean carefully after use. If chemicals stay in the pumps, their useful life is short, and there are problems from failure of valves, seals, hoses or other mechanical parts. Diaphragm pumps are more popular because of ease of calibration, maintenance and the lack of external leaks.

Some important characteristics and components of chemigation pumps include:

1. Accuracy to within  $\pm 0.5$  percent
2. Calibration tube
3. Adjustable while running
4. Durable - stainless steel valve balls  
- Niton seals
5. Agitation capability
6. Accessibility of repairs
7. Appropriate size chemical tank/tanks

Injection pumps should operate within  $\pm 0.5$  percent accuracy, utilize stainless steel and other non corrosive material where there is direct contact with chemicals. Repair should be accessible. Appropriate

size chemical tanks equipped for agitation and a calibration tube are important to successful chemigation. Complete chemigation units that provide these features are available.

Many pump injection rates are available. It is essential that the pump selected has capacity to apply the appropriate amount of chemical. Injection pumps are usually rated in gallons per hour. The pump rating is the maximum injection rate. Typically, the minimum adjustable injection rate of a single pump is approximately 10 percent of the maximum rating. It is usually worthwhile to project the range of probable injection rates of likely chemicals prior to purchasing an injection pump.

## Calibration

Accurate calibration of injection equipment is essential for safe and proper application. Small differences in injection rates can make large differences in the total amount of chemical applied and could cause insufficient or excessive application. The following conversions and equations are useful for calibration of chemigation equipment:

450 gallons/minute = 1 acre-inch/hour

27,000 gallons = 1 acre-inch

### Amount of Irrigation Water

The amount of water applied during a single irrigation is determined by three factors:

- the water pumped or system flow rate in gallons per minute (gpm)
- time pumped in hours
- acres on which water is pumped during time (b), expressed as:

#### Equation 1

$$\frac{\text{depth of irrigation (inches)}}{\text{(inches)}} = \frac{\text{system flow rate (gpm)} \times \text{time (hours)}}{450 \times \text{acres irrigated}}$$

Conversely, the amount of time to apply a given amount of water is:

#### Equation 2

$$\text{hours} = \frac{(\text{inches of irrigation})}{(\text{system gpm})} \times 450 \times \text{acres}$$

## Injector Calibration

Correct injector calibration is necessary so that the chemical solution is injected at a rate that ensures that the proper amount of chemical will be applied (gallons per acre).

The total amount of chemical solution (gallons) is first calculated by multiplying the amount of chemical solution needed per acre (gallons) by the total number of acres; or

#### Equation 3

$$\frac{\text{total chemical solution needed (gallons)}}{\text{(gallons)}} = (\text{acre}) \times \frac{(\text{amount of chemical solution per acre})}{\text{(gallons)}}$$

The injection rate (gallons per hour) is then based on the total solution needed (gallons) divided by the irrigation time (hours) necessary to apply the targeted depth calculated in Equation (1) and (2); or

#### Equation 4

$$\frac{\text{injection rate (gal per hour)}}{\text{(gal per hour)}} = \frac{\text{total solution chemical and mix (gal)}}{\text{revolution or irrigation time (hours)}}$$

To set calibration, use a stopwatch and a tube or other container of known-volume graduations. Usually a graduated cylinder marked in milliliters or ounces is used. Convert the injection rate from gallons per minute using the following formulas:

#### Equation 5

If using a milliliter graduated cylinder:

$$(\text{gal per hour}) \times 63.09 = \text{ml per min}$$

#### Equation 6

If using an ounce graduated cylinder:

$$(\text{gal per hour}) \times 2.133 = \text{oz per min}$$

Example:

Use 32 percent urea ammonium nitrate to apply 10 pounds N per acre through a 1320 foot center pivot covering 125.5 acres at 900 gallons per minute. The fertilizer is applied with 0.50 inches of water. Note: 32 percent urea ammonium nitrate weighs 11.06 lb/gal and has 3.54 lb N/gal.

**Step 1.** Compute time to make one circle and apply 0.5 inches with equation (2).

$$\frac{(0.5 \text{ in}) \times 450 \times 125.5 \text{ ac}}{900 \text{ gpm}} = 31.4 \text{ hours per circle}$$

**Step 2.** Convert pounds of N per acre to gallons per acre:

$$10 \text{ lb N/ac} + 3.54 \text{ lb N/gal} = 2.82 \text{ gal solution/ac}$$

**Step 3.** Calculate total chemicals needed with equation (3).

$$125.5 \text{ ac} \times 2.82 \text{ gal N solution/ac} = 353.9 \text{ total gal fertilizer solution}$$

**Step 4.** Calculate injection rate with equation (4).

$$353.9 \text{ gal} \div 31.3 \text{ hours} = 11.3 \text{ gal/hour injection rate}$$

**Step 5.** Identify injection rate in ounces per minute with equation (6).

$$11.3 \times 2.133 = 24.12 \text{ oz/min of fertilizer solution}$$

**Step 6.** Set pump injection rate to 24.12 oz/min.

**Step 7.** Set center pivot speed control to 31.4 hours/per revolution or circle

### **For More Information**

More detailed information on chemigation regulations and calibration are given in TAEX publication B-1652, *Chemigation Workbook*.

Funding for this publication was provided by the Extension Service - USDA under the USDA Water Quality Initiative.

Educational programs conducted by the Texas Agricultural Extension Service serve people of all ages regardless of socioeconomic level, race, color, sex religion, handicap or national origin.

Cooperative Extension work in agriculture and home economics, The Texas A&M University System and the United States Department of Agriculture cooperative. Distributed in furtherance of the acts of Congress of May 8, 1914, as amended and June 30, 1914.



# Reducing Herbicides in Surface Water Best Management Practices (L-5205)



# Reducing Herbicides in Surface Waters

## Best Management Practices

Paul A. Baumann and Brent W. Bean\*

**H**erbicides have a proven record for cost effective weed control throughout Texas. They are applied to soils or plant surfaces and some control weeds for an extended period after application.

However, under some circumstances these herbicides may move from the application site into surface waters. Unfortunately, minute quantities of a few herbicides have been detected in Texas ground and surface waters.

The potential risks associated with the contamination of surface waters must and can be alleviated by the adoption of Best Management Practices. Many of these are common sense approaches that require relatively little time or money, while others may require significant amounts of both. How-

ever, we must act now if we are to keep effective herbicides available for future use.

The following practices will help eliminate or reduce the runoff of surface-applied residual herbicides into surface water. These management practices can help accomplish three major goals:

- Reduce herbicides in runoff;
- Reduce water and sediment runoff, and;
- Safely clean sprayers and dispose of containers.

### Reduce Herbicides in Runoff

#### Apply Herbicides Accurately

Properly calibrated sprayers are a must for preventing over-application of herbicides. Consultants, agri-chemical suppliers, and government and state agency personnel can advise



Properly calibrate sprayers.

you on the many calibration techniques available.

Calibration should be done regularly. Surveys indicate that 26 percent of private applicators are applying at least 10 percent more herbicide than they intend. Over-application of pesticides not only wastes money but also increases the chance of pesticides finding their way into surface waters.

Minimize the off-target drift of herbicides into open bodies of water such as creeks, rivers or lakes. Proper nozzle selection and pressure adjustment, and the use of drift control agents, are simple approaches to solving this problem.

\*Associate Professor and Extension Weed Specialist and Associate Professor and Extension Agronomist, The Texas A&M University System.

## Reduce Herbicide Rate

Apply only the minimum amount of herbicide necessary to control weeds. If the label allows, consider splitting the herbicide application into two treatments. One treatment can be applied early in the season and the second at a later date. In addition, the rate of any given herbicide may be reduced by combining it with other herbicides. Using herbicide combinations may broaden the spectrum of weeds controlled, and may reduce the need for additional applications later on.

## Use Alternative Herbicides

If possible, use herbicides that are less environmentally sensitive. There are a number of such products that can be applied “as needed” for effective post-emergence weed control. Most of these products do not have long residual activity and pose little threat to surface water. However, these herbicides usually are more expensive to use, and application timing is critical. Weeds can be controlled effectively only when treated in the early stages of growth. If windy or wet weather prevents timely application, weeds may become uncontrollable and the competition from them can be disastrous.

## Time Application Correctly

The potential for herbicide runoff and surface water contamination increases when a hard rain falls soon after herbicide application. When possible, apply herbicides early in the season before the typical early Spring rainy period. Some products are labeled for application up to 45 days before planting, and their residual activity ensures their effectiveness. Avoid applying

herbicides to wet soil when rainfall is expected within 24 hours. When rain falls on wet soil much of the water runs off the field rather than moving down into the soil profile. Any herbicide lying on the soil surface may be dissolved and move off the field in the runoff. It is important that the herbicide be moved into the soil during the first few minutes of a rainfall.

## Incorporate Herbicides Before Planting

The labels for some herbicides specify that they can be incorporated into the soil prior to planting. This may sometimes improve weed control, because with incorporation rainfall is not required to move the substance into the soil before weed seeds germinate. Incorporation dilutes the herbicide into the upper 2 to 3 inches of the soil, thus reducing the risk of surface water contamination. This is an especially useful option for farmers who till the land before planting anyway. Even a very light incorporation with a rotary hoe is beneficial.

## Use Integrated Weed Management

Minimize the use of herbicides by applying them on an as-needed basis along with cultural practices such as mechanical cultivation, crop rotation, narrow row spacing, rotary hoeing, and altered planting dates. Evaluate weed conditions on untreated areas of the field to determine whether you really need to use herbicides in a broad-scale, preventive approach. Apply residual herbicides only where weed infestations require their use, and use alternative herbicides elsewhere. County Extension agents and Extension specialists can recommend integrated weed management practices for various crops.

## Band Herbicides

Banding herbicides over the crop row places the product in the area where it is most needed, yet reduces the total amount applied by 50 to 66 percent in most cases. Untreated areas between rows can be shallowly tilled to control most annual weeds. This practice can dramatically reduce the amount of herbicide that could be carried off



Band herbicide applications.



Practice contour farming.

the field in soil erosion or water runoff. The money saved by applying less herbicide helps offset any increased tillage expense. In many cases, banding is the best application method in terms of both herbicide cost and effective weed control.

### Lightly Irrigate After Application

If possible, lightly irrigate soon after herbicide application to move the product into the top 2 inches of the soil and reduce the potential for runoff. Generally,  $\frac{1}{2}$  to  $\frac{3}{4}$  of an inch of water applied by sprinkler irrigation is enough to move most herbicides into the soil profile.

### Consider Site-Specific Factors

Certain cropland sites are more vulnerable to surface water runoff than others. For example, soils with high clay content on sloping sites with little plant residue on the surface are at high risk. Rain-fall or irrigation on such sites can easily transport herbicides, either on moving soil particles or in the surface water runoff itself. In such situations the best approach might be to apply herbicides that control weeds postemergence, and that have little residual activity. Such products could be used on an as-needed basis. Consult with your local NRCS personnel to get a site assessment based on soil texture, slope and residue parameters.



### Observe Setback Areas

Many herbicide labels require the applicator to observe spray setback distances from outlets to streams, rivers and lakes. A setback distance from wells for mixing and loading operations often is required. Any setback requirements on a herbicide label should be strictly followed. If specific directions are not given on the label, avoid spraying herbicides within 50 feet from wells, 66 feet from outlets to streams or rivers, and 200 feet from lakes. Do not mix or load herbicides within 50 feet of a well.

### Reduce Water and Sediment Runoff

Best management practices that reduce water and sediment (soil) runoff generally require more drastic changes in management and are more expensive than changing herbicide application methods. However, in areas where the soil type, land slope or land use cause great risk of surface runoff, these practices should be considered.

### Consider Contour Farming

Contour farming is the practice of planting and tilling a crop across a slope rather than up and down the slope. This practice can reduce the amount of soil lost from the field to as little as a third of that lost from clean till fallow. Adopting residue management practices further reduces soil loss. If end rows are left to run up and down the hill the benefits of contour farming are greatly reduced. Instead, use grass field borders as turn rows at the ends of your field.

### Terrace the Land

Land terracing is a more drastic form of contour farming. It consists of constructing a series of large, nearly parallel ridges that run at a slight grade across the slope. These ridges are permanently maintained and collect the runoff from most rains. The excess water that collects behind the ridges can be channeled off to appropriate areas to reduce the risk of environmental contamination.



## Safely Clean Sprayers and Dispose of Containers

Carefully follow all label directions for cleaning sprayers and disposing of herbicide containers. Disregarding these procedures can easily lead to concentrated doses of herbicide being deposited on the soil surface and possibly entering nearby surface waters. In the case of accidental spills, immediately clean up the site using appropriate procedures. Mixing and loading on an impervious pad will make clean up easier should spills occur during these operations.

This publication was produced by the Texas Agricultural Extension Service in cooperation with the Texas Department of Agriculture, USDA-Natural Resources Conservation Service, Texas State Soil and Water Conservation Board, and Texas Natural Resource and Conservation Commission.

### Try Furrow Diking

Furrow dikes are mounds of soil mechanically placed in the furrow between crop rows, creating a series of small dams. When rainfall exceeds the soil's infiltration rate, the dikes hold the water until it has time to soak into the soil. This practice is especially beneficial in dryland agriculture.

### Plant Grass Filter Strips or Grass Waterways

Placing grass filter strips between herbicide application sites and bodies of water helps reduce sediment runoff. Strips are effective if runoff spreads out evenly as it crosses the filter strip and is not concentrated into streams. Filter strips usually are 15 to 25 feet wide. Grass waterways reduce water and soil runoff that occurs during light rainfall, but are less effective when rainfall is heavy. Never plant crop rows up and down the side of the waterway. Where grass waterways are established, contour rows should enter the

grass areas nearly on the level, but directed into the waterway.

### Increase Surface Residue

Use cultural practices that increase the amount of plant residue remaining on the soil surface. This usually requires the adoption of no-tillage or reduced tillage practices, and may also mean changing crop rotation patterns. Increasing the amount of plant residue on the soil surface greatly reduces water runoff from fields. Practices that increase surface residue can be used alone or in combination with other Best Management Practices.



Clean containers properly.

Produced by Agricultural Communications, The Texas A&M University System

Educational programs of the Texas Agricultural Extension Service are open to all people without regard to race, color, sex, disability, religion, age or national origin.

Issued in furtherance of Cooperative Extension Work in Agriculture and Home Economics, Acts of Congress of May 8, 1914, as amended, and June 30, 1914, in cooperation with the United States Department of Agriculture. Edward A. Hilier, Interim Director, Texas Agricultural Extension Service, The Texas A&M University System.



# Chemigation and Water Quality Protection Information on the Internet

## Chemigation and Water Quality Protection Information on the Internet

*This list of references, though not exhaustive on the subject, has been assembled to aid the reader in accessing additional information on subsurface drip irrigation in agriculture. It was compiled by Extension Agricultural Engineer Dana Porter; it was updated in September 2007.*

### **Texas A&M University – Texas Cooperative Extension**

Chemigation Equipment and Safety

<http://itc.tamu.edu/documents/extensionpubs/L-2422.pdf>

Center Pivot Irrigation

<http://itc.tamu.edu/documents/extensionpubs/B6096.pdf>

Chemigation Presentation

<http://gfipps.tamu.edu/Educational%20Seminars/index.html>

### **American Society of Agricultural Engineers** <http://www.asabe.org/>

ASAE Standard EP409.1 Safety Devices for Chemigation

<http://asae.frymulti.com/abstract.asp?aid=15998&t=2>

### **University of Minnesota Extension Service**

Chemigation Safety Measures

<http://www3.extension.umn.edu/distribution/cropsystems/DC6122.html>

Nitrogen Application with Irrigation Water—Chemigation

<http://www3.extension.umn.edu/distribution/cropsystems/DC6118.html>

### **Colorado State University Cooperative Extension**

Applying Pesticides with Center-Pivot Irrigation

<http://www.ext.colostate.edu/pubs/crops/04713.html>

Fertigation

<http://www.ext.colostate.edu/pubs/crops/00512.html>

<http://www.ext.colostate.edu/pubs/crops/00512.pdf>

### **University of Florida Cooperative Extension**

Chemical Injection Methods for Irrigation

<http://edis.ifas.ufl.edu/WI004>

Injection of Chemicals into Irrigation Systems: Rates, Volumes, and Injection Periods

<http://edis.ifas.ufl.edu/AE116>

### **Mississippi State University Extension Service**

Chemigation

<http://msucares.com/pubs/publications/p1551.htm>

### **United States Environmental Protection Agency**

National Management Measures to Control Nonpoint Source Pollution from Agriculture

<http://www.epa.gov/nps/agmm/>

# *CROP-SPECIFIC GUIDELINES*



**Corn Production**

**Cotton Production**

**Sorghum Production**

**Forage Production**

**Wheat Production**

**Vegetable Production**

**Citrus Production**

**Sugarcane Production**



# *Irrigation Management for Corn Production*

## **In this Section**

Overview: Irrigation Management for Corn Production

Reference: Predicting the Final Irrigation for Corn, Sorghum and Soybeans (MF-2174)

## **Overview**

Corn is a relatively drought-sensitive crop with a relatively high water demand. Corn responds well to irrigation. Where water from irrigation and rainfall are insufficient or unreliable, extra care in risk management assessment is recommended.

### **Objectives:**

- Increase understanding of water requirements (peak water use, seasonal water use, critical growth stages, drought sensitivity/tolerance, and water quality requirements) of corn produced for grain or for silage.
- Increase water use efficiency and profitability in corn production through application of appropriate best management practices.

### **Key Points:**

1. Corn is relatively sensitive to drought and salinity.
2. Seasonal water use for corn in the Texas High Plains is approximately 28 to 32 inches per season.
3. Peak water use rates occur a few days before; water demand begins to decline about midway through the grain-fill period (dent stage).
4. The most critical period during which water stress will have the greatest effect on yield corresponds with the maximum water demand period, approximately two weeks before and after silking.
5. Best Management Practices with regard to irrigation method and management (timing, rate, etc.) can minimize risk, optimize water use efficiency and minimize risk of water resource contamination.



# *Irrigation Management for Corn Production*

## **Assess your knowledge:**

1. What is the peak water use of corn in your area? When (growth stage and calendar range) does this occur?
2. How do peak water use and seasonal water use of full season corn compare to those of short-season corn?
3. What is the maximum effective root zone depth for corn? Are there other factors in your field or management program that you would expect to limit this effective root zone depth? What practical significance do these limitations have with respect to your irrigation and nutrient management programs?
4. Are there water quality (salinity) concerns for corn production on your farm? If so, what are they? How can they be managed?
5. What irrigation method do you currently use to irrigate corn? What best management practices (BMPs) are you using to optimize water use efficiency? Identify other methods and BMPs that would be applicable to your operation.



# *Irrigation Management for Corn Production*

## **Corn Water Demand and Irrigation Management\***

Corn is a relatively high water use crop, with relatively high sensitivity to drought. Seasonal water use for corn in the Texas High Plains is approximately 28 to 32 inches per season. Peak water use rates occur a few days before tasseling (concurrent with maximum leaf area index); water demand begins to decline about midway through the grain-fill period (dent stage). The most critical period during which water stress will have the greatest effect on yield potential corresponds with the maximum water demand period, approximately two weeks before and after silking. The general trend of crop water demand during the season is shown in the Figure on the next page.

The **root zone** of corn can be as deep as 5-6 feet, if soil conditions allow. Roots are generally developed early in the season, and will grow in moist (but not saturated or extremely dry) soil. Like most crops, corn will extract most (70% - 85%) of its water requirement from the top one to two feet of soil, and almost all of its water from the top 3 feet of soil, if water is available. Deep soil moisture is beneficial primarily when the shallow moisture is depleted in high water demand periods.

Soil moisture profile (moist, but not saturated zone), plow pans, caliche layers, etc. often limit the effective root zone depth. A shallow-rooted crop is more susceptible to drought and related injury.

### **Irrigation capacity to meet peak water demand**

Where irrigation system capacity is limiting, planted acreage may be limited to that which can be supplied by the irrigation capacity and soil moisture storage. Peak water demand for corn can exceed 0.35 inches per day (6.4 gpm/acre) in some areas of the state. Because soil moisture storage (3 to 6 inches of water in the top 3 ft. of soil) can help meet water need during the high demand period, irrigation capacities of 5 to 6 gpm/acre are generally adequate for corn production, provided highly efficient irrigation equipment and management are used.

### **Irrigation water quality: salinity**

Corn is moderately sensitive to salinity in soil and irrigation water. Grain yield is adversely affected by irrigation water salinity above 1.1 dS/m electrical conductivity (EC), or soil salinity above 1.7 dS/m EC. A 50% yield reduction is expected with irrigation water EC of 3.9 dS/m. Corn is also moderately sensitive to foliar injury from sodium (tolerance between 230 and 460 ppm) and chloride (tolerance between 350 and 700 ppm) in irrigation water. Spray irrigation applications present a higher risk of foliar damage from marginal quality waters. Periodic excess applications of water (irrigation and/or precipitation) can facilitate leaching of accumulated salts from the root zone.

*\* Compiled by Dana Porter, PhD, PE, Department of Biological and Agricultural Engineering and Texas A&M AgriLife Research and Extension Center – Lubbock.*





# Irrigation Management for Corn Production

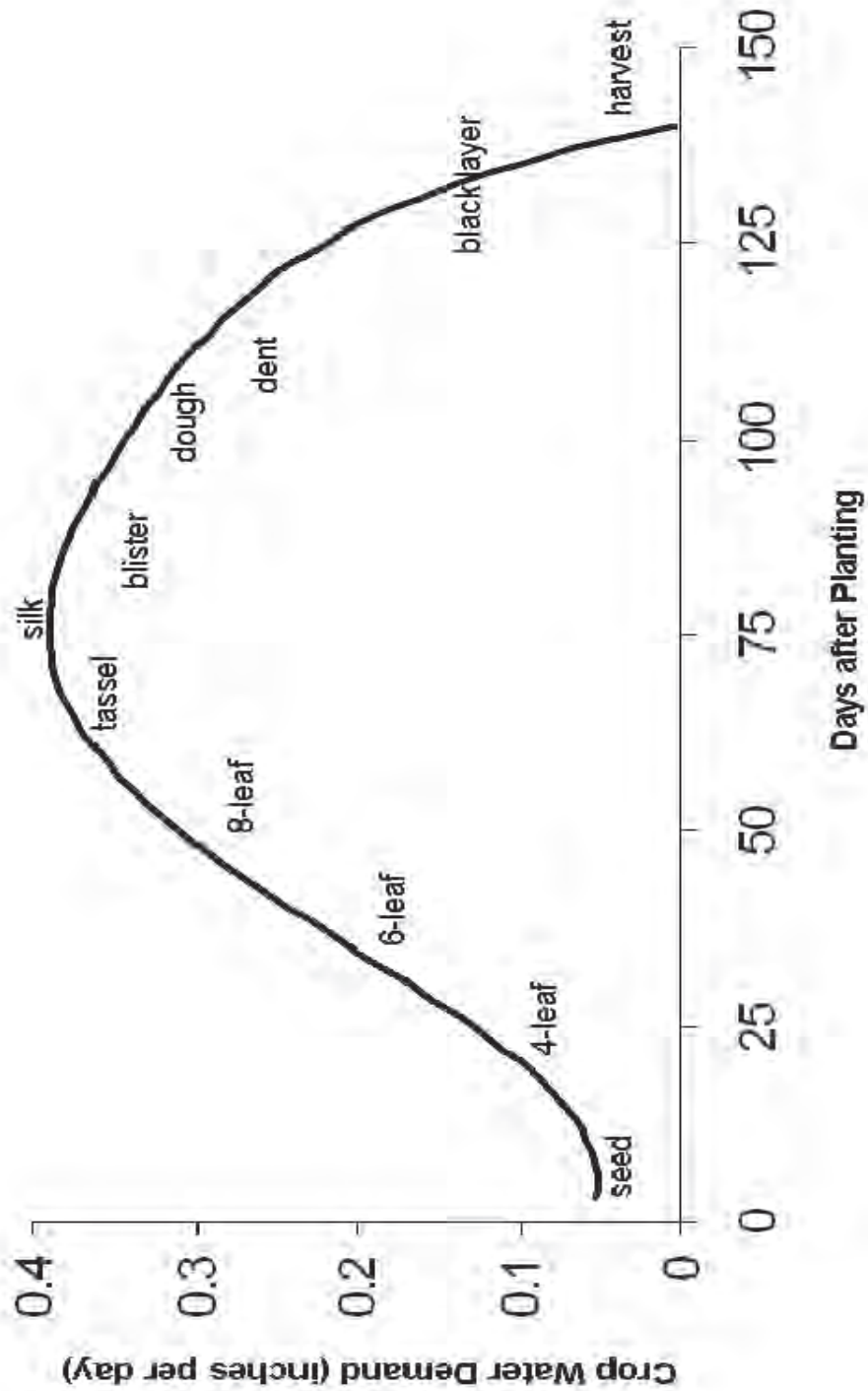
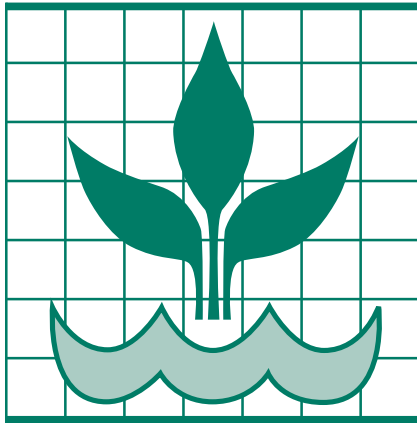

Figure. Approximate corn water demand, (inches per day), Texas High Plains.



# Predicting the Final Irrigation for Corn, Sorghum and Soybeans (MF-2174)



# IRRIGATION MANAGEMENT S E R I E S

## PREDICTING THE FINAL IRRIGATION FOR CORN, GRAIN SORGHUM, AND SOYBEANS

**Danny H. Rogers**  
Extension Agricultural Engineer

**William M. Sothers**  
Extension Assistant

Adapted from  
Neb-Guide G91-1021  
University of Nebraska-Lincoln

Water-use efficiency is becoming an important concern for irrigators, state water officials, and Kansas citizens. Deciding when to apply the last irrigation is an important crop and water-management decision. Water, as well as expenses associated with its delivery, can be saved by closely monitoring the soil water levels and scheduling the last irrigation. Applying one extra irrigation may mean wasting 1 to 4 inches of water and the fuel needed for pumping. Other reasons for scheduling the final irrigation are to prevent harvest delays and soil compaction due to wet fields late in the season. However, early cutoff of irrigation water may result in unnecessary yield loss. Determining when to apply the final irrigation is an important management decision.

### REQUIREMENTS FOR PREDICTING THE FINAL IRRIGATION

When scheduling the final irrigation of a season, there are two goals to keep in mind:

- 1) Provide enough water to the root zone to carry the crop to maturity and to maintain yields.
- 2) Reduce the soil water levels as far as possible to provide room for off-season precipitation, to minimize costs associated with irrigation, and to minimize risks of soil compaction during harvest.

These goals seem to conflict, but irrigators can accomplish them by scheduling the final irrigation. To schedule the final irrigation, the following information is needed:

- a) Current crop stage of growth.
- b) Predicted water use to maturity.
- c) Amount of usable water in the root zone.

For the purpose of predicting the final irrigation, it will be assumed that no precipitation occurs. In the event of precipitation, the procedures presented in this bulletin should be repeated.

### SCHEDULING THE FINAL IRRIGATION

Scheduling of the final irrigation may be performed in Table 1 to estimate how much additional water will be necessary to finish the season.

Table 1 also shows an example. To complete this form, follow these steps.

1. Record the date, field, crop type, soil type, and the stage of growth. Refer to the local NRCS County Soil Survey to determine the soil type and to Tables 2–4 to determine the stage of growth.
2. Determine the Water Required to reach Crop Maturity (WRCM). Table 5 gives approximate values for appropriate stages of growth.
3. Determine the Available Soil Water Holding Capacity (ASWHC) for the soil type listed in Step 1. The ASWHC can be found for general soil descriptions in Table 6.
4. Find the Total Available Water (TAW) in the root zone by multiplying the ASWHC from Step 5 by the root zone depth.
5. Calculate the Allowable Soil Water Depletion by multiplying the TAW found in Step 4 by allowable soil depletion.
6. Measure the Current Soil Water Depletion (CSWD).
7. Calculate the Remaining Usable Water (RUW) in the root zone by subtracting the CSWD found in Step 6 from the ASWD calculated in Step 5.
8. Determine the Irrigation Requirement (IR) by subtracting the RUW found in Step 7 from the WRCM determined in Step 2.

When the value determined for the remaining usable water is greater than the amount of water required to reach crop maturity, no irrigation is required. Additional information on how to fill each part of the table is also included in this bulletin.

### STAGES OF CROP DEVELOPMENT (STEP 1)

For best yields, crops should be provided with water up to the time of physiological maturity. Since some of the required water can come from the soil water reserves, the final irrigation can usually be applied several weeks before crop maturity. To help determine the approximate number of days left and subsequently the water use until crop maturity, it is helpful to recognize the stages of growth for the crop of interest. Tables 2–4 describe relevant growth stages for corn, grain sorghum, and soybeans. A more

**Table 1. Estimating Remaining Irrigation Requirement Steps**

	Example	Your Field
1. Date		
Field	North 80	
Crop	Corn	
Soil Type	Silty clay loam	
Stage of Growth (Tables 2–4)	Dent	
2. Water Required to Crop Maturity (WRCM from Table 5)	2.5in	
3. Available Soil Water Holding Capacity (ASWHC from Table 6)	2.1 in/ft.	
4. Total Available Water (TAW = ASWHC x Root Zone)	6.3 in.	
5. Allowable Soil Water Depletion (ASWD = Deplete x TAW)	3.8 in.	
6. Current Soil Water Depletion(measured value)	2.0 in.	
7. Remaining Usable Water (RUW = ASWD – CSWD) (RUW = STEP 5 – STEP 6)	1.8 in.	
8. Irrigation Requirement (IR = WRCM – RUW) (IR = STEP 2 – STEP 7)	0.7 in.	

NOTE: If RUW is greater than WRCM, no more irrigation is needed.

**Table 2. Reproductive Stages of a Corn Plant**

Stage	Description
Silking	Silks visible outside the husks; pollen shedding.
Blister	Kernels are white and resemble a blister in shape.
Milk	Kernels are yellow and inner fluid is milky white.
Dough	Inner fluid has a pasty consistency.
Dent	Kernels are dented or denting; cob is dark red.
Physiological maturity	All kernels achieving maximum dry weight.

Source: How a Corn Plant Develops, Special Report No. 48, Iowa State University, 1989

**Table 3. Reproductive Stages of a Sorghum Plant**

Stage	Description
Boot	Head extended into flag leaf sheath.
Half-bloom	Half of plants at some stage of bloom.
Soft dough	Grain forming rapidly, culm losing weight.
Hard dough	3/4 of grain dry weight accumulated.
Physiological maturity	Maximum dry weight of the plant reached.

Source: How a Sorghum Plant Develops, S-3 Revised, Kansas State University, 1993

detailed discussion on plant development can be found in the source listed with each respective table.

**PREDICTING WATER USE TO MATURITY (STEP 2)**

Determining the amount of water use to crop maturity involves estimating and summing the amount of daily evapotranspiration (ET) from the time of interest until crop maturity. ET is the amount of water used by a

growing crop. Each day water is evaporated from the soil and plant surfaces, and transpired through the plants. ET is this combination of evaporation and transpiration. Transpiration is the last step in a plant’s continuous water–use cycle. Water is pulled from the soil into plant roots, then delivered through plant stems and leaves, where it eventually evaporates from leaf and plant surfaces.

ET demand is influenced by such factors as temperature, relative humidity, wind, and solar radiation. This ET value is referred to as reference ET (E<sub>r</sub>). To find the crop ET, crop conditions such as the stage of growth must be considered. To obtain the water use for a particular crop during a particular growth stage, the reference ET must be multiplied by a crop coefficient (K<sub>co</sub>):

$$\text{Crop ET} = \text{ET}_r \times K_{co}$$

Table 5 gives approximate crop water use to maturity values for different stages of crop development. The prediction procedure can be repeated to increase reliably as the end of the season approaches.

**DETERMINING THE REMAINING USABLE WATER IN THE ROOT ZONE (STEPS 3–7)**

To determine the remaining usable water in the root zone, first determine the allowable soil water deficit (ASWD) and the current soil water deficit (CSWD). The remaining usable water in the root zone can then be found by subtracting the CSWD from the ASWD.

**Determine Available Soil Water Holding Capacity (Step 3)**

Different soil types have different water holding capacities, it is impor-

types along with their ASWHC. The NRCS Soil Survey is probably the easiest way to determine soil types for individual fields.

#### Determine Total Available Water (Step 4)

The root depth for the crop of interest needs to be determined. All three of the crops being discussed in this bulletin have root depths of 4 to 6 feet deep if no soil restrictions plant growth. The KSU Extension bulletin *Soil, Water and Plant Relationships L-904* gives more information on plant root depth. However, 70 percent of the water is taken from the top half of the root system. Therefore a general recommendation is to use a rooting depth of 3 feet. Calculate the TAW by multiplying the root zone depth (RZD) or:

$$\text{TAW} = \text{ASWHC} \times \text{RZD}$$

#### Determine Allowable Soil Water Depletion (Step 5)

Another general irrigation management guideline is to maintain soil water levels at or above 50 percent depletion, especially during the initiative of grain reproductive stages of growth. There are some research indications that as the crop approaches maturity, a higher percentage depletion (DEplete) could be used and not reduce the grain yield. In the example, ASWD was calculated using 60 percent depletion. Be certain to use a decimal fraction for the value of DEplete in Table 1.

$$\text{ASWD} = \text{TAW} \times \text{DEplete}$$

#### Measure Current Soil Water Depletion (Step 6)

There are many methods available to help determine the current soil water depletion. (CSWD) These methods include making electronic measurements with neutron probes or resistance blocks, making a physical measurement with tensiometer, estimating the soil water by appearance and feel, or through the use of irrigation scheduling with ET data. KSU Extension bulletin L-795, *Soil Water Measurement*; L-901, *Scheduling Irrigation by Electrical Resistance Block*; or L-796, *Tensiometer Use in Scheduling Irrigation* may be useful for additional information.

**Table 4. Reproductive Stages of a Soybean Plant**

Stage	Description
Beginning bloom	One open flower at any node on main stem.
Full bloom	Open flower at two uppermost nodes with leaf.
Beginning pod	3/16-inch pod at one of the four uppermost nodes with leaf.
Full pod	3/4-inch pod at one of the four uppermost nodes with leaf.
Beginning seed	1/8-inch seed in pod at one of the four uppermost nodes.
Full seed	Green seed that fills pod cavity at one of the four uppermost nodes.
Beginning maturity	One normal pod on main stem that has reached mature color.
Full maturity	95 percent of the pods have reached their mature pod color.

Source: How a Soybean Plant Develops, Special Report No. 53, Iowa State University, 1988

**Table 5. Normal Water Requirements for Corn, Grain Sorghum, and Soybeans Between Various Stages of Growth and Maturity**

Stage of growth	Approximate number of days to maturity	Water use to maturity (inches)
<b>Corn</b>		
Blister	45	10.5
Dough	34	7.5
Beginning dent	24	5.0
Full dent	13	2.5
Physiological maturity	0	0.0
<b>Grain Sorghum</b>		
Half bloom	34	9.0
Soft dough	23	5.0
Hard dough	12	2.0
Physiological maturity	0	0.0
<b>Soybeans</b>		
Full pod	37	9.0
Beginning seed	29	6.5
Full seed	17	3.5
Full maturity	0	0.0

**Table 6. Soil Types and Their Available Soil Water Holding Capacities (ASWHC)**

General Soil Description	NRCS Intake Family	ASWHC (in/ft)
clay loam	0.1	2.0
silty clay loam	0.3	2.1
silt loam	0.5	2.4
sandy loam	1.0	2.0
fine sandy loam	1.5	1.9
loamy fine sand	2.0	1.1
fine sand	3.0	0.8

### Remaining Usable Water (Step 7)

Once the ASWD and the CSWD are known, the remaining usable water (RUW) in the root zone is found by subtraction:

$$RUW = ASWD - CSWD$$

### Irrigation Requirement (Step 8)

The remaining irrigation requirement is found by subtracting the remaining usable water (RUW) (Step 7) from the water required to reach crop maturity. (WRCM) (Step 2)

$$IR = WRCM - RUW$$

If IR is negative, that is RUW is greater than WRCM and no irrigation is needed.

Acknowledgment: This material is based upon work supported by the U.S. Department of Agriculture Cooperative State Research Service under Agreement No. 93-34296-8454. Any opinions, findings, conclusions or recommendations expressed in this publication are those of the authors and do not necessarily reflect the views of the U.S. Department of Agriculture.



Cooperative Extension Service, Kansas State University, Manhattan

MF-2174

May 1996

Issued in furtherance of Cooperative Extension Work, acts of May 8 and June 30, 1914, as amended. Kansas State University, County Extension Councils, Extension Districts, and United States Department of Agriculture Cooperating, Richard D. Wootton, Associate Director. All educational programs and materials available without discrimination on the basis of race, color, national origin, sex, age, or disability.

File Code: Engineering 4-3 Irrigation

MS 5-96-3M



# *Irrigation Management for Cotton Production*

## **In this Section**

Overview: Irrigation Management for Cotton Production

Reference: Irrigation Management Strategies for High Plains Cotton -  
*An excerpt from Texas Cotton Production Emphasizing Integrated Pest Management*

Reference: Late Season Issues in 2006

## **Overview**

Cotton is a relatively drought-tolerant and salt-tolerant crop that generally responds well to irrigation. Cotton can be produced over a range of irrigation levels, from rain-fed (dryland) to deficit to full irrigation. Cotton water use efficiency is generally higher under managed deficit irrigation than under full irrigation; however excessive water deficit or drought stress at critical growth stages can have a considerable negative impact on yield potential for the crop.

### **Objectives:**

- Increase understanding of water requirements (peak water use, seasonal water use, critical growth stages, drought sensitivity/tolerance, and water quality requirements) of cotton.
- Increase water use efficiency and profitability in cotton production through application of appropriate best management practices.

### **Key Points:**

1. Cotton is relatively tolerant to drought and salinity.
2. Seasonal water use for cotton in the Texas High Plains is approximately 13 to 27 inches per season. Seasonal water demand is generally 24 to 28 inches. Deficit irrigation management (water available is less than crop demand) is common practice, often due to limited water supply.
3. Peak water use occurs during flowering and boll development.
4. The most critical period during which water stress will have the greatest effect on yield is early in the season when drought stress can cause square shedding.
5. Excessive irrigation and excess available nitrogen can encourage excessive vegetative growth, necessitating use of plant growth regulators.



# *Irrigation Management for Cotton Production*

## **Assess your knowledge:**

1. What is the peak water use of cotton in your area? When (growth stage and calendar range) does this occur?
2. What is the maximum effective root zone depth for cotton? Are there other factors in your field or management program that you would expect to limit this effective root zone depth? What practical significance do these limitations have with respect to your irrigation and nutrient management programs?
3. Are there water quality (salinity) concerns for cotton production on your farm? If so, what are they? How can they be managed?
4. What irrigation method do you currently use to irrigate cotton? What best management practices (BMPs) are you using to optimize water use efficiency? Identify other methods and BMPs that would be applicable to your operation.





# *Irrigation Management for Cotton Production*

## **Pre-Plant, Planting and Stand Establishment**

Roots grow in moist soil (not in saturated or dry soil); hence good moisture conditions in the root zone are key to establishment of a good root system early in the season. An extensive root system improves the crop's access to moisture and nutrients from a larger area of the soil profile.

In West Texas, fields are often pre-irrigated because of limited rainfall in the winter and spring. The timing of pre-irrigation depends on water availability, soil texture and the time required for the soil to drain adequately before planting. The amount of water applied depends on rooting depth, available moisture-holding capacity and current soil moisture.

## **Emergence to First Bloom**

During the emergence to first bloom growth stage, decisions on water, fertilizers and plant growth regulators are important. Water use increases dramatically, from less than 1 inch per week at emergence to 2 inches per week at first bloom. The goal is to avoid water stress early in the season and to have a full soil water profile as the plant reaches peak bloom (usually 3 weeks after bloom for most regions of Texas).

## **First Bloom to First Open Boll**

The plant's water use increases dramatically during the stage from first bloom to open boll. Estimated evapotranspiration (water used by the plant and evaporated from soil) water use can be as high 0.4 inches per day or 2.8 inches per week. Because the soil is the storage site for water available to the plant, the primary factors in determining water-holding capacity are soil texture and root zone depth. Soils with coarse (sandy) textures tend to hold less water than loam and clay soils. Rooting depth is affected by both chemical and physical soil characteristics; water tables, dry layers, hard pans, caliche layers and salt accumulation zones limit rooting depth. Once blooming starts, cotton prefers frequent, low-volume applications of water rather than large, less frequent amounts. This strategy minimizes the degree of water stress between rain or irrigation events and thus increases fruit retention.

In West Texas, very few producers have the irrigation capacity to satisfy crop demands (0.3 to 0.4 inches per day). Highly efficient advanced irrigation technologies, including low pressure center pivot irrigation (LEPA-low energy precision application and LESA- low elevation spray application) and subsurface drip irrigation have proven to be excellent tools in these water-limited production systems. Research indicates that cotton responds very well to high-frequency deficit irrigations, even with amounts as low as 0.20 to 0.25 inch applied every 2 days. When irrigation capacities are above 0.2 inch per day, the frequency of irrigation is not as critical.



# Irrigation Management for Cotton Production

## First Open Boll to Harvest

At peak bloom, cotton requires about 0.3 inch of water per day. By harvest, the rate will drop considerably, to less than 0.1 inch per day. Ideally dryland producers would have a full profile of moisture at the third week of bloom, followed by a couple of timely rain showers. Producers with furrow irrigation have more control than dryland producers but still must make the last irrigation before bolls open. Late applications of excessive water can lead to many problems, including boll rot, late season re-growth, an increase in late-season insect pests, added harvest aid inputs and possible grade reductions from late-season re-growth. In West Texas, furrow irrigation should be terminated before September 1. Sprinkler or drip irrigation should be continued for 1 to 2 weeks after open boll or until 20 percent of the bolls are open. The goal is to provide adequate moisture for the last harvestable bolls to mature.

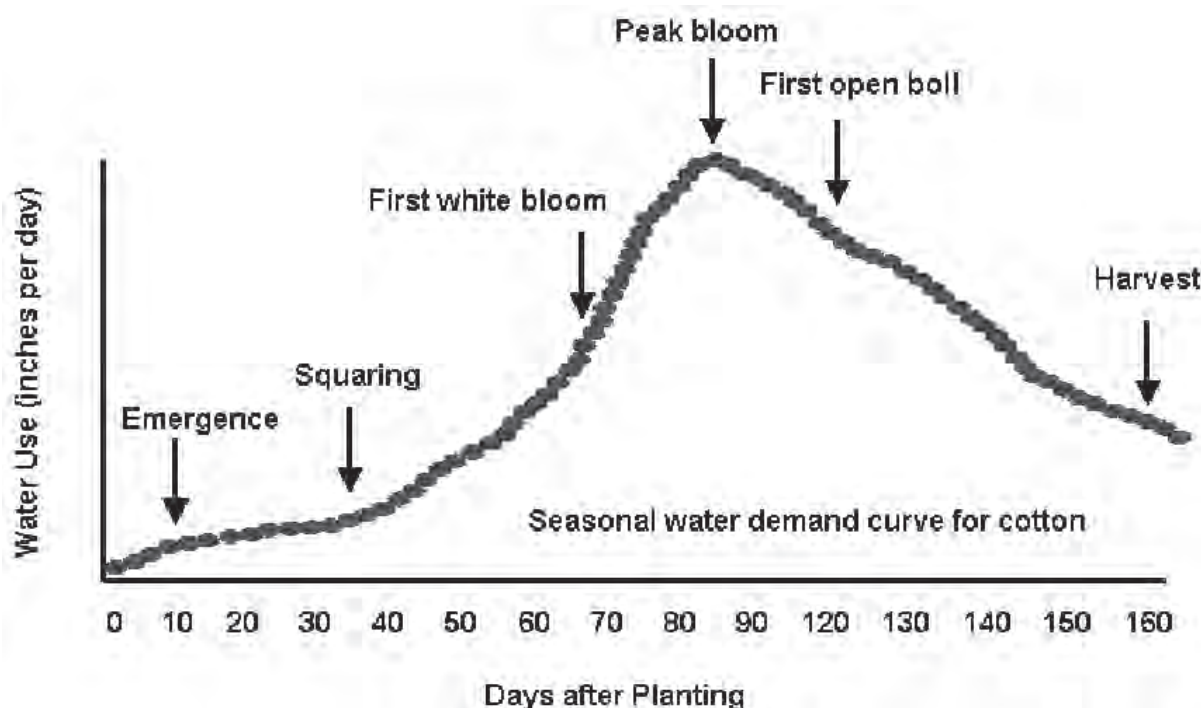

Adapted from: Sansone, Christopher, Thomas Isakeit, Robert Lemon, and Billy Warrick. *Texas Cotton Production Emphasizing Integrated Pest Management*. Texas AgriLife Extension Service (formerly Texas Cooperative Extension). Available at: <http://lubbock.tamu.edu/cottondvd/content/cottondvd/General%20Production/texas cotton production/tcpemhipm.html> (Accessed 12-21-07)



*An Excerpt from Texas Cotton Production  
Emphasizing Integrated Pest Management*

*The following includes excerpts from*

Sansone, Christopher; Thomas Isikiet; Robert Lemon; Billy Warrick. Texas Cotton Production Emphasizing Integrated Pest Management. Texas Cooperative Extension. College Station, Texas.

The full manual is available at <http://lubbock.tamu.edu/cottondvd/>

# Texas Cotton Production

---

Emphasizing Integrated Pest Management



**Christopher Sansone**

Assistant Professor and Extension Entomologist

**Thomas Isakeit**

Associate Professor and Extension Plant Pathologist

**Robert Lemon**

Associate Professor and Extension Agronomist

**Billy Warrick**

Associate Professor and Extension Agronomist

---

## Contributors and Acknowledgments

This book was produced with the financial assistance of the Texas Department of Agriculture's Integrated Pest Management Grant Program. The authors would also like to thank Tom Fuchs, Extension Entomologist and Statewide Integrated Pest Management Coordinator, for originating the idea and for his encouragement and support.

The information in this manual is from the collected knowledge of many people and from publications from many sources in Texas. This publication would not be possible without the collaboration of research and Extension workers throughout the state. The following is a list of scientists whose ideas and work were incorporated into the manual.

***Agricultural Economics:*** Jason Johnson and John Robinson.

***Agricultural Engineering:*** Guy Fipps and Dana Porter.

***Agronomy:*** Todd Baughman, Randy Boman, Paul Baumann, John Bremer, Mike Chandler, Tom Cothren, Kamal El-Zik, Kater Hake, Juan Landivar, Robert Lemon, Stephen Livingston, Mark McFarland, Robert Metzger, James Supak, Wayne Smith, Charles Stichler and Billy Warrick.

***Plant Pathology and Microbiology:*** Larry Barnes, Tom Isakeit and Terry Wheeler

***Entomology:*** Brant Baugh, John Benedict, Stephen Biles, Emory Boring, Ray Frisbie, Dan Fromme, Tom Fuchs, Kevin Heinz, Allen Knutson, Jim Leser, Rick Minzenmayer, Pat Morrison, Warren Multer, John Norman, Roy Parker, Chris Sansone, Kerry Siders, Jim Smith, Jr., Alton Sparks and Knox Walker.

The authors would also like to thank Diane Blake Bowen, associate editor in Agricultural Communications, Texas Cooperative Extension, for editing assistance. Other contributors from Agricultural Communications were Vera Johnson, typesetting; Lori Colvin, graphic design; Cornelia Blair, copy editing; and Jerry Nucker, cover design.

---

---

The information given herein is for educational purposes only. Reference to commercial products or trade names is made with the understanding that no discrimination is intended and no endorsement by Texas Cooperative Extension is implied.

---

**A**lthough successful cotton crop production depends on many factors, it is basically the integration of grower management and weather. The key for producers is to develop a workable system or strategy.

In a systems approach, no single cultural practice can be separated from the others. Each practice affects the others, so that problems or successes in one area will influence all other aspects of production.

To formulate a system and produce an economical crop, farmers should be familiar with several key factors of cotton production, including plant development, irrigation options and management of pests, especially diseases, weeds and insects.

### Plant development

In its native tropical habitat, cotton is a perennial shrub that may live for many years. As a perennial, it is genetically programmed to survive from year to year, not necessarily to reproduce every year. Therefore, by planting and harvesting each year, cotton producers are forcing a perennial plant to perform as an annual.

Cotton plants will limit fruit production unless all their needs for survival are being met. To produce acceptable yields, crop managers must make sure that the cotton plants' basic needs for nutrients, water, temperature and sunlight are satisfied so that the plants can produce squares (flower buds) and bolls (fertilized fruit).

Producers can determine whether the cotton crop's needs are being met by monitoring plant development throughout the season. To make good management decisions, producers need to know the stage of development of the cotton plant. This information is vital to those making decisions on irrigation, fertilization, pest management and harvest.

To assess a cotton crop's development, producers should use several types of measurements – calculating heat units, noting the progression of fruiting, determining the ratio of plant height to internode length, calculating fruit retention and monitoring the nodes above white flower.

### Heat units

After moisture, the most important factor in the development of squares and bolls is temperature. For a cotton plant to mature, it must accumulate a certain amount of heat energy from the sun. Researchers have devised a way to describe and measure the relationship between cotton development and temperature – the heat unit concept, or DD60 (degree days using 60 degrees F).

Heat units measure the amount of useful heat energy a cotton plant accumulates each day, each month and for the season. The plant must accumulate a specified level of heat units for it to reach each developmental stage and to achieve complete physiological maturity (Table 2.1). From planting to harvest, cotton plants need a total of about 2,600 heat units to develop to full maturity.

Several systems have been developed to calculate heat units, but the most universal approach is to use the formula:

$$\frac{(\text{Degrees F Maximum} + \text{Degrees F Minimum})}{2 - 60}$$

Example: If the high temperature (degrees F Maximum) on a given day is 90 degrees F and the low temperature (degrees F Minimum) is 75 degrees F, then for that day, the plant will accumulate 22.5 DD60s. The calculation:

$$(90 \text{ degrees F} + 75 \text{ degrees F}) / 2 - 60 = 22.5 \text{ DD60s}$$

Cotton plants will not develop if the temperature is too low. The lowest temperature at which cotton will continue to develop (also known as



the base temperature) is considered to be 60 degrees F. Temperatures lower than 60 degrees F will not reduce heat unit accumulations in the plant (unless the temperatures actually kill the plant), nor will they subtract from the plant's physiological maturity. For calculation purposes, the upper temperature limit should be 95 degrees F.

### Node development

Node development is a reliable indicator of plant maturity. Before bloom, node development depends primarily on temperature.

One way to estimate the number of DD60s a plant has accumulated is to count its nodes. A node is the site where a new true leaf arises from the main stem. A cotton plant develops a new node every 50 to 60 DD60s, whether the heat unit accumulation occurs in 2 days or 10 days.

To determine how many DD60s a plant has amassed, count the number of nodes along the main stem and multiply that number by 50 or 60.

### Fruiting

Another way to determine a cotton plant's development is to check the progression of fruiting on its branches. Flowers appear up the main

stalk and along each fruiting branch at set intervals.

On adjacent branches, first-position flowers appear about every 3 days (at 50 to 60 DD60s). This is termed the vertical fruiting interval (VFI).

On a single branch, the flowers (first, second, third positions) appear 6 days apart (100 DD60s). This is called the horizontal fruiting interval (HFI).

Therefore, bolls set on the same fruiting branch are 6 days apart in age, while bolls set at similar positions on succeeding fruiting branch are 3 days apart in age.

### Plant size

Two other indicators of crop development are plant height and internode length. Plant height reflects general growth conditions. The height can be affected by many factors, including early- season temperatures, wind, cotton variety, water, fertility, plant type, row spacing and plant density.

Internode length is also important. An internode is the part of the stem between two nodes. Because internodes are very sensitive to environmental conditions and plant health, their length is a very reliable indicator of growth conditions.

**Table 2.1. Accumulated heat units (DD60s) required for different developmental stages of cotton.**

Growth Stage	Number of Days (range)	Heat Units (range)
Planting to seedling emergence	4-9	50-60
Emergence to first square	27-38	425-475
Square to white flower <sup>2</sup>	0-25	300-350
Planting to first flower	60-70	775-850
White flower to open boll	45-66	850
Planting to cutout	80-100	1,000-1,600
Planting to harvest	130-170	2,600
Between nodes		
Up the main stem	2-34	0-60
Out the branch	5-7	80-120



A long internode (3 to 5 inches) indicates favorable growth and good potential for rank (excessive growth) plants to develop. A shorter internode (0.5 to 1 inch) tells us the plant was stressed while that node was developing, perhaps by a shortage of water or insects attacking the plant.

Using plant height and internode length, you can calculate the height-to-node ratio (HNR), which reflects the sum total of a particular plant's experience – the availability of water, nutrients, heat, sunlight, etc.

A plant's height is measured from its cotyledons (seedling leaves) to the terminal. Calculate the node number by counting the number of main stem nodes or true leaves. The uppermost node to count is the one with an unfurled leaf at least 1 inch in diameter (the size of a quarter).

To calculate the HNR, divide the height of the plant by the number of nodes. According to this formula, a plant 20 inches tall with 15 nodes would have a HNR of 1.33:

$$20 \text{ inches} / 15 \text{ nodes} = 1.33$$

Height-to-node ratios should range from 1.3 to 2.0, especially during the bloom period.

This ratio will change as the season progresses. After emergence, the leaf area is small and temperatures are generally cooler. This limits both the development of nodes and the length of the internodes.

However, after bloom, the space between internodes should shorten as developing bolls progressively demand more of the plant's carbohydrates and nutrients. At this point, the plant should be using its energy to develop bolls, not to produce excessive vegetative growth. If internode length increases after bloom, then the plant resources are not being fully used for boll development.

If the HNR increases above 2.0 after flowering starts, inspect the fields promptly to see if the cause is insect damage. If insects are not the problem, managers may need to reduce growth

by applying plant growth regulators containing mepiquat chloride (Pix<sup>®</sup>, Pix Plus<sup>®</sup>, etc.).

### Fruit retention

Once the plants start fruiting (setting flower buds), growers should start monitoring fruit retention (the percentage of fruit [squares] remaining on the plant) up to the appearance of the first bloom.

Divide the number of fruit by the number of fruiting sites. The number of fruiting sites should be equal to or greater than the number of fruit (squares and bolls).

For example, if you counted 10 plants and found 12 squares and 20 fruiting sites, the fruit retention would be 60 percent:

$$(12 \text{ squares} / 20 \text{ fruiting sites}) \times 100 = 60 \text{ percent}$$

### Nodes above white flower

After flowering begins, you should start monitoring the number of nodes above white flower (NAWF). Find the white bloom at the highest first position (fruiting site closest to the main stem) on a plant and count the nodes above that bloom.

The NAWF number will give you an idea of how healthy the crop is and whether you need to irrigate or apply fertilizer to extend the boll-setting period.

### Interpreting crop information

A number of computer models (GOSSYM, TEXCIM, PMAP, CALEX/Cotton, ICEMM, MEPRT, CROPMAN, etc.) have been developed to manage the information gathered during crop monitoring. Growers should evaluate these models based on the ease of use and information provided.

One of the most popular and widely evaluated crop models is COTMAN, which is being refined by the University of Arkansas and Cotton





Incorporated. COTMAN can help determine when to stop applying late-season insecticides and initiating harvest aids. COTMAN is available from Cotton Incorporated.

Another new technique for monitoring crop development is the combination of global positioning and remote sensing.

The most common type of remote sensing used in Texas is infrared photography, in which fields are photographed by satellite on different dates. Producers can compare the photos and note color changes in the fields from one date to the next. The color differences can indicate a change in the health of the crop.

To pinpoint exactly where crop health has been compromised (where the colors differ from one date to another), producers can use global positioning technology, which indicates the exact longitude and latitude of the areas in question.

This technology has helped farmers locate perennial weed infestations, nematode infestations and plant diseases in their crops.

## Irrigation

Irrigation is another valuable cotton management tool that varies across the state. The irrigation systems used in Texas include furrow, sprinkler and subsurface drip irrigation systems.

**Furrow irrigation** is popular in areas where fields are level and which have predominantly clay loam soil textures and abundant supplies of relatively inexpensive water. These comparatively simple systems discharge water into an open earthen ditch with siphon tubes that apply water to the field from the ditch.

Producers have modified these systems by lining the ditches with concrete or plastic to limit water losses. They have also begun replacing the siphon tubes with gated pipe, and the more advanced systems have surge valves.

**Sprinkler systems** have been developed for land that is poorly suited to furrow irrigation. Most of them are now mobile, and the most com-

mon is the center pivot. These systems are being modified to improve water use efficiency.

Of the current sprinkler irrigation technologies, the low energy precision application (LEPA) system is considered the best to use in Texas. Instead of broadcasting water over the crop, this type of system delivers it directly to the ground via a drop hose with a nozzle or sock attached.

**Subsurface drip irrigation** is the newest development in irrigation technology in Texas. The main disadvantages of this technology are its high initial capital costs and inability to move water up to the surface of soils that have an appreciable sand content (sandy loams to loamy sands).

Producers are using this technology where water is limited and/or expensive to apply.

Because of limited water resources, producers have been forced to shift from furrow to other, more efficient irrigation methods (Table 2.2). These more efficient irrigation systems have

**Table 2.2. Irrigation system efficiencies.**

System	Overall Efficiency
Surface	0.50-0.80
Average	0.50
Land leveling and delivery pipeline	0.70
Tail water recovery combined with above	0.80
Surge valves	0.60-0.90 <sup>1</sup>
Sprinkler	0.55-0.73 <sup>2</sup>
Center pivot	0.55-0.90 <sup>2</sup>
LEPA	0.90-0.95
Drip	0.80-0.90 <sup>3</sup>

1. Surge has been found to increase efficiency 8 to 28 percent over non-surge furrow irrigation
2. Under low wind conditions
3. Drip systems are typically designed at 90 percent efficiency. Short laterals (less than 100 feet) or systems with pressure compensating emitters may have higher efficiencies.



enabled crop managers to reduce production costs as well as stretch their water resources.

Irrigation efficiencies can be increased with proper scheduling. Crop managers should know how much water the crop is using in order to supply adequate water for good growth.

Water is lost both by evaporation and by transpiration (the loss of water through plant tissues, primarily leaves). The combined water loss from these two processes is called evapotranspiration. For cotton, the standard method to estimate losses by evapotranspiration is to use potential evaporation (PET). PET depends on climate and varies from location to location. PET calculations are available from <http://texaset.tamu.edu>.

The water requirements of specific crops are calculated as a percentage of the PET. To determine how much water your crop needs, multiply the PET in your area at that time by the crop coefficient (K<sub>c</sub>). Crop coefficients differ by crop and according to the various stages of plant development.

Crop coefficients for cotton in the Texas Northern High Plains are shown in Table 2.3. These values should be adequate for other production regions in Texas. However, crop managers in each production region should check them against their local conditions.

**Table 2.3. Cotton crop coefficients (K<sub>c</sub>) for the Texas North High Plains.**

Growth Stage	K <sub>c</sub>	Days after Planting
Seedling	0.07	0-10
First square	0.22	27-38
First bloom	0.44	60-70
Peak bloom	1.10	70-90
First open boll	1.10	105-115
25% open bolls	0.83	115-125
50% open bolls	0.44	135-145
95% open bolls	0.44	140-150
Harvest	0.10	140-150

For example, if the 5-day PET is 1.5 inches and cotton is at peak bloom, the crop coefficient is 1.10 (Table 2.3).

$$1.5 \text{ inches} \times 1.10 = 1.65 \text{ inches}$$

The water requirement for this crop is 1.65 inches; that is, 1.65 inches of water needs to be applied to replace the water used by cotton in the previous 5 days.

When using PET, be sure to monitor soil moisture using gypsum blocks, watermark sensor tensiometer, the “feel” method or other devices for measuring the current water status in the root zone.

You may need to increase the amount of irrigation water in order to compensate for the efficiency rate of your irrigation system. To adjust for irrigation efficiency, use this equation:

$$\text{PET} \times K_c / \text{Efficiency} = \text{irrigation water requirements}$$

Using the above example, if 1.65 inches is needed by the crop and the irrigation system is a sprinkler system (Table 2.2), then the calculation would be

$$(1.5 \times 1.10) / 0.73 = 2.26 \text{ inches}$$

The total water needed would be 2.26 inches. You would apply 2.26 inches of water to the crop if you wanted to replace 100 percent of the water lost to evapotranspiration.

## Pest management

Pest management is a system or strategy to control diseases, weeds and insect and mite pests. Many tools are available to use against cotton pests. To devise a pest management system, growers should use a combination of pest suppression techniques that are the most compatible and ecologically sound.

The pest management concept depends on the assumption that pests will be present to some degree in a production system and that at some levels, these pests may not lower production significantly. The level at which the pests begin



**D**ecisions made in the off-season are vital to cotton production. During this period, growers must make decisions on stalk destruction, tillage practices, fertility, crop rotation, variety selection and pest management.

### Stalk destruction

The cotton plant can continue to grow even after harvest aid applications. Regrowth occurs when heat, soil moisture and nutrients are in excess of the developing fruit's demands for carbohydrates.

Because of the potential for regrowth, stalk destruction is an important component of cotton production in Texas. After harvest, stalks must be destroyed to prevent the development of regrowth and fruiting structures (flower buds) for insects to feed upon.

Stalk destruction is more important in the south and eastern parts of the state, where higher rainfall and warmer temperatures occur. In West and North Texas, freezing temperatures often kill the stalk before new fruit is produced.

When field conditions and weather are favorable for tillage, stalks can be shredded and then disked or plowed to destroy the plant. Stubble stalk pullers can also be used to uproot stalks.

Although these mechanical methods are highly successful, many growers are implementing reduced tillage systems to conserve soil moisture and surface residues. Consequently, these producers are using chemicals to terminate plant regrowth. Two methods are being developed for chemical stalk destruction.

Several herbicides are approved for cotton stalk destruction and produce favorable results. Growers must consider these factors when using chemicals to destroy stalks:

- Good spray coverage is essential. You must use the proper spray volume and nozzle orientation over the row.
- The plants must have adequate regrowth so there is enough surface area to absorb the herbicide. This minimal surface area can range from 2 to 8 inches of new stem growth, which can occur within 2 to 3 weeks after stalk shredding.

Shred the cotton crop to a 4- to 8-inch height above the soil surface to allow uniform regrowth. The maximum regrowth allowable is 8 inches from the base of the stubble to the attachment of the last leaf present. At this point, new leaves should be big enough to receive treatment but not so big that they develop fruiting forms that could host boll weevils.

Recent research in the Rio Grande Valley indicates that if the bark is roughened at harvest, the percentage of dead plants increases after treatment with 2, 4-D. The 2, 4-D applications should be made as soon as possible after harvest.

- Apply the chemicals only when environmental conditions are favorable. Conditions should encourage rapid growth so that the cotton plants are more susceptible to treatment. Conditions should also be favorable to discourage off-target spray drift.
- The product must not cause problems with successive crops in a crop rotation system. Although many approved chemicals have relatively short soil residuals, others may last for months. This is especially true if the soil stays cool and dry after the herbicide application.
- Because pesticide application is regulated in certain counties, you may need to obtain a permit from the Texas Department of

Agriculture before applying 2,4-D or dicamba to a field during harvest.

The Texas Department of Agriculture currently approves only 2,4-D (Barrage<sup>®</sup>, Salvo<sup>®</sup> and Savage<sup>®</sup>) dicamba (Banvel<sup>®</sup>, Clarity<sup>®</sup> and Weedmaster<sup>®</sup>) and Harmony<sup>®</sup> Extra for cotton chemical stalk destruction. This was the approved list in 2001 and may change in the future. Producers should be sure to have the most current labels before applying any pesticide.

## Tillage practices

Three types of tillage systems are used in Texas: conventional, reduced and conservation. Each system offers advantages and disadvantages. The best system for a particular site depends on soil type, environmental conditions, weed pressure and availability of specialized equipment.

In conventional tillage systems, stalks are usually shredded and then plowed under. In the southern production regions, bolls and squares that are shredded should remain on the ground for 2 to 3 days to dry out. Daytime heating will desiccate (dry out) squares, limiting the survival of developing boll weevils, especially the early instars (immature stages).

The advantages of conventional (clean) tillage systems are that they:

- Provide for good seedbed conditions and allow the use of mechanical tillage to help control weeds.
- Help with disease and insect management at post harvest.
- Destroy food sources and reproduction sites for microorganisms responsible for cotton diseases as the residue is incorporated and decomposed.
- Reduce populations of tobacco budworm, bollworm and pink bollworm. These insects overwinter as pupae (the stage between larva and adult) underground. Disturbing the soil can reduce winter survival and insect emergence in the spring.

A disadvantage of conventional tillage systems is that the residue may encourage the growth of the seedling pathogen *Rhizoctonia solani*. This pathogen is a strong saprophytic (dead plants) colonizer of crop debris, so that in some environments, the presence of cotton crop residue could increase seedling disease in later crops.

Even though conventional tillage approaches have been used for years, economic conditions are causing many producers to shift to reduced tillage systems. Reduced tillage systems allow producers to farm large acreage while minimizing equipment and labor costs. Reduced tillage in this book refers to making fewer trips with tillage tools (moldboard plows, chisel plows, cultivators, etc.) than in a conventional system.

The benefits of reduced tillage systems include protection of the soil from wind and water erosion, reduced fuel and labor inputs, fewer equipment requirements and increased soil moisture retention.

On the other hand, reduced tillage systems may increase the risk of seedling disease in fields where residues do not decompose. Growers can minimize this risk by applying in-furrow granular or liquid fungicides to supplement fungicide treatment on seed.

Conservation tillage is similar to reduced tillage, but the goal is to have 30 percent or more of the field surface covered with crop residue.

One conservation tillage approach used in many irrigated farms in the High Plains is called the terminated small grain system. Rye or wheat is drilled into prepared seedbeds after cotton harvest, and the small grain is terminated with herbicide 2 to 4 weeks before planting the cotton. The standing small grain stubble reduces wind and water erosion and protects the young cotton from wind and sandblasting.

## Fertility

A strong cotton fertility program provides the foundation for high yields and good fiber quality. Without adequate nutrients, plant performance will suffer.



Compared to many other crops, cotton has a lower nutrient demand, which generally results in lower annual fertilizer expenditures. Relatively small amounts of nutrients are removed from the field at harvest. However, during the reproductive stages of development, proper fertility is extremely important. Once cotton begins fruiting, nutrient needs increase dramatically.

The primary goal of a cotton fertility program should be to achieve optimum fertilizer use efficiency (FUE), which is the conversion of applied nutrients into harvestable yield.

The first step in attaining a high FUE is to determine what nutrients the plants need to achieve the production level desired. The key to nutrient management and a high FUE is soil testing.

A soil test is an estimate of the nutrient-supplying power of a soil. The test identifies the degree of deficiency or sufficiency of a given nutrient. Although soil testing is not an exact science, it is the best tool available for determining the proper amounts of nutrients necessary to attain a given yield.

However, the information and recommendations provided by any laboratory are only as good as the samples collected. Consequently, good sampling techniques are critical.

The best method for taking soil samples is to collect soil from 12 to 15 locations in each field, mix them together thoroughly and ship the mixture immediately to a soil-testing laboratory.

In conventional tillage systems, collect a standard 0- to 6-inch soil sample. However, in reduced and no-tillage fields, some plant nutrients can become stratified (accumulate in the upper 1 to 3 inches of soil).

For instance, phosphorus (P) is highly subject to stratification in these systems because:

- P is a very immobile, especially in clay soils.
- Reduced tillage limits soil mixing and nutrient incorporation.

- Fertilizer is often applied at or near the surface.
- Crop residues and the nutrients they contain (which have been mined from throughout the rooting zone) are placed on the surface rather than incorporated back into the soil.

Conventional soil sampling techniques (0- to 6-inch depth) do not account for stratification. They may indicate that enough P is available for production, when in fact it may be located in a position in the soil that makes it inaccessible to the plant.

Consequently, to determine if the nutrients have become stratified, take two soil samples. Collect one sample from the 0- to 3-inch depth and another from the 3- to 9-inch zone. Test the soil layers every 3 to 5 years to track nutrient placement in the field.

Growers can eliminate stratification by deep tillage operations and subsurface banding of fertilizer.

The primary nutrients of interest in cotton production are nitrogen (N), P and potassium (K). Secondary nutrients include calcium, magnesium, sulfur and the micronutrients iron, zinc, manganese and copper.

The production of one bale of cotton removes about 50 pounds N, 40 pounds P, 30 pounds K, 2 pounds calcium, 4 pounds magnesium and 3 pounds of sulfur (Table 3.1). Only very small amounts of the micronutrients are required.

Nitrogen is, by far, the most important nutrient for cotton production. If the soil lacks nitrogen, the crop may suffer reduced growth and development, early cutout, lower fruit retention, reduced root health and limited water and nutrient uptake.

Excess N also causes problems, such as delayed maturity, excessive growth, reduced boll retention, greater incidence of boll rot, higher pest insect populations and reduced fiber quality.

When calculating the amount of nitrogen to apply to a field, base your estimates on realistic yield goals. Test the soil every year, and collect

**Table 3.1. Typical nutrient content of a bale of cotton.**

	Above-Ground Plant (leaves, stems, fruit)	Seed Cotton	Lint
	Pounds per Bale		
Oxygen	2,100	700	250
Carbon	1,650	550	190
Hydrogen	360	120	35
Nitrogen	62	35-40	1
Potash (K <sub>2</sub> O)	61	15	3
Phosphate (P <sub>2</sub> O <sub>5</sub> )	22	13-20	0.3
Calcium	27-62	1	0.2
Magnesium	11-27	5	0.3
Sulfur	8-16	1-2	trace

Source: K. Hake et al. 1991. Cotton Nutrition-N, P and K. Cotton Physiology Today. National Cotton Council Physiology Education Program Newsletter 2 (3): 1-4.

deep samples (0 to 12 inches and/or 12 to 24 inches) when possible to account for N that has accumulated deeper in the soil profile.

Although the deep-sampling approach is uncommon, recent research indicates that N can accumulate with depth. Crediting this N to the total for the field could reduce overall N fertilization needs.

Apply nitrogen fertilizer in a tandem approach by applying 20 to 30 percent of the total N required at preplant and the rest side-dressed at

squaring. If the crop is irrigated, you can apply N through the pivot.

In addition to commercial fertilizer, producers can use manures, municipal sludges and other organic amendments to supply nutrients for crop production (Table 3.2).

Along with nutrients, these manures supply valuable organic matter that helps improve soil structure, tilth and workability, as well as water- and nutrient-holding capacities. Manures also increase the activity of beneficial soil microbes (microorganisms).

**Table 3.2. Average nutrient values for manure at the time of land application**

Source	Dry Matter	Nitrogen	Phosphorus	Potassium
	%	Pounds per Ton		
Cow (fresh)	25	15	8	10
Beef (feedlot)	65	27	24	36
Dairy (corrals)	65	28	11	26
Dairy (stockpile)	80	28	12	23
Broiler (litter)	65	58	51	40
Layer	35	30	40	20
Swine	18	10	9	7

Sources: A. C. Mathers, et al. 1973. Effects of cattle feedlot manure on crop yields and soil conditions. Technical Report No. 11. USDA Southwest. Great Plains Research Center. Bushland, TX.



Cotton plants grow in an orderly manner, producing new nodes, internodes, leaves and squares from meristems (growing points) over the course of the season. The plant growth stage of cotton from emergence to first bloom requires 7 to 9 weeks.

The growth rate of cotton vegetation follows an S-shaped curve pattern (Figure 5.1). Recently emerged seedlings grow slowly until the squares (flower buds) reach the match-head stage (3/16 inch in diameter). Then the growth speeds up substantially.

During this period, growers need to continue monitoring plant development; control insects, weeds and diseases; and make decisions on the use of water, fertilizers and plant growth regulators.

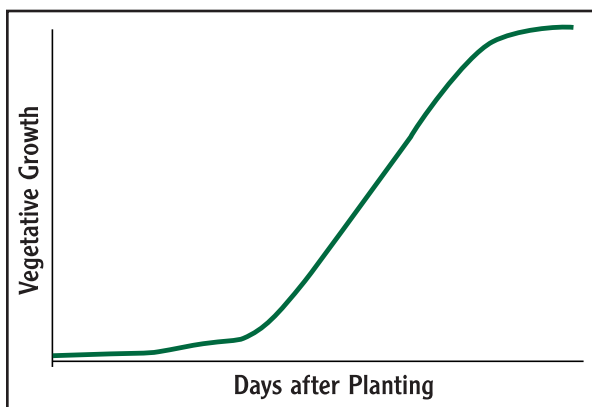

**Figure 5.1. Vegetative growth curve for cotton.**

## Plant development

Cotton plants grow slowly at emergence (the lag phase) because of the plants' limited leaf area, cooler temperatures early in the season and pests.

The first leaves that emerge are the cotyledon or seed leaves, the only leaves on the plant that grow directly opposite each other. Cotyledon leaves are primarily storage tissues; they have minimal ability to produce photosynthates (food).

If both cotyledons are lost within the first week after emergence, plant maturity will be delayed because the leaves do not have time to transfer their stored nutrients to other plant parts. After the cotyledons emerge, the plant develops main-stem or true leaves. Later in the season, subtending leaves develop on fruiting branches, which are critical to boll set and boll fill.

Through the process of photosynthesis, leaves produce carbohydrates that the plant uses to survive, grow and produce fruit. A leaf's ability to produce carbohydrates is closely related to its age. Leaves that are 16 to 25 days old are prime producers and exporters of carbohydrates to other parts of the plant. After this age, they become less able to supply photosynthates. A 60-day-old leaf is unable to supply food reserves for developing fruit.

During the early stages of plant development, the roots grow faster than the plant parts above-ground. A young taproot may extend 6 inches into the soil by the time the first true leaf is visible. Soon after the first true leaf appears, the roots begin developing an extensive lateral system.

Roots grow where moisture, oxygen and temperature are optimum. As these three factors decline, root growth slows and, as a consequence, the plant takes up less water and nutrients.

To provide more oxygen to the roots, producers using conventional tillage systems (clean tillage) can aerate the soil with shallow cultivation. This can break up any crusting that has developed and speed surface drying. Because drier soils are usually warmer, aeration can also warm the soil.

Minimum or conservation tillage systems do not offer this option, but the surface residue left by these systems usually minimizes soil crust formation. Root channels and increased organic matter in minimum tillage systems also promote better soil aeration.

## Plant development

Growers must begin monitoring the crop early and continue throughout the growing season until harvest. Before bloom, plant development depends primarily on temperature.

**Node development:** A new node, which is the point along the main stem at which a vegetative or fruiting branch arises, develops every 50 DD60s. Early in the season, a cotton plant can accumulate 50 DD60s in 3 to 10 days, depending on the temperature.

Through early bloom, the number of nodes on a plant is a good indicator of its age. Node development is not affected by environmental stresses at this stage, making it a valuable index to the plant's development.

At the base of each node are two buds designated the first and second axillary buds. At the first five to seven nodes, the first axillary buds are vegetative (producing leaves and stems). The cotton plant will establish a root system and an adequate vegetative structure before it starts fruiting.

The plant usually starts to flower at the seventh node. At that time, the first axillary bud starts to produce fruit. The second axillary bud remains dormant. Fruit initiation (development of the first flower buds) can be delayed by cool temperatures, high plant populations and high pest densities. Plants very rarely revert to producing vegetative branches after a plant starts to produce fruiting branches. Hormones (plant chemicals) prevent other vegetative meristems from growing below nodes six or seven.

If insects or hail damages the plant terminal, one or more of the lower vegetative meristems will begin growing to produce new main stems. This is how plants damaged early in the season recover to produce a crop, even though it will mature late. Table 5.1 shows a time line of square progression to open flower.

Unlike nodes, the internode (the portion of stem between the nodes) is very sensitive to environmental and plant conditions, making the length of the internodes a reliable indicator of plant growth. A long internode (more than 3 inches) indicates favorable growth conditions and

**Table 5.1. Time line of fruit formation of a cotton plant.**

Days Before Bloom	Bud Height (25 mm=1 inch)	Comments
40	Microscopic	Square initiation can occur, as early as the 2 <sup>nd</sup> true leaf expansion. Hot, spring weather induces 4-bract squares. Cool or very hot weather delays square initiation.
32	Microscopic	Lock number determined, carbohydrate stress decreases number of locks from 5 to 4.
23	2 mm, Pinhead	Ovule number determined, carbohydrate stress decreases potential seed number
22	2 mm, Pinhead	Pollen cells divide
19	3 mm, Matchhead	Pollen viability reduced by night temperatures > 80 °F
5	13 mm	Square starts to expand rapidly
3	17 mm	Fibers begin to form
0	Flower opens	Pollen sheds and fibers start to elongate. Extremes of humidity or water disrupt pollen function.
+1	Fertilization of ovule	Ovule now called seed





the potential for excessive growth. A short internode (less than 1.5 inches) shows that the plant was stressed when that internode was developing.

Cells in a developing internode stop elongating between the fourth and fifth node from the terminal (the dominant, upper main stem part of the plant). The fifth internode from the terminal is the last fully mature internode and is the best indicator of plant vigor.

**Fruiting:** Once fruiting begins, growers have to make many more management decisions. Squares form at the first axillary bud after the first fruiting branch develops. The location of the node is determined by the cotton variety and environmental conditions during the first weeks after emergence.

After the first 3 weeks of plant growth, the only way to increase the number of squares is to protect against pests and to sustain plant growth, which produces sites for additional fruiting branches and adds fruiting sites to existing branches. Under optimum growing conditions, a new fruiting site will develop every 3 to 5 days moving up the plant (vertical fruiting interval) and every 5 to 7 days moving horizontally along the fruiting branch (horizontal fruiting interval).

The objective at early fruiting is to retain the most squares possible. Because of the different weather characteristics and pest problems across Texas, the optimum number of squares retained differs by region.

In West Texas, fruit initiation usually occurs during warm temperatures and sunny days. The goal in that region is to have 90 percent square set in the first week of squaring, 85 percent in the second week and 75 percent in the third week up to first bloom.

This goal is more difficult to reach in the eastern part of the state because of pest problems and environmental stresses (cool temperatures and cloudy conditions).

## Fruit shed

Fruit shed is unavoidable in the life of a cotton plant (Figure 5.3). It is caused by environmental, physiological and pest influences. Although growers generally view it as detrimental, some fruit shed is necessary, especially when the plant is adjusting its fruit load to accommodate growing conditions.

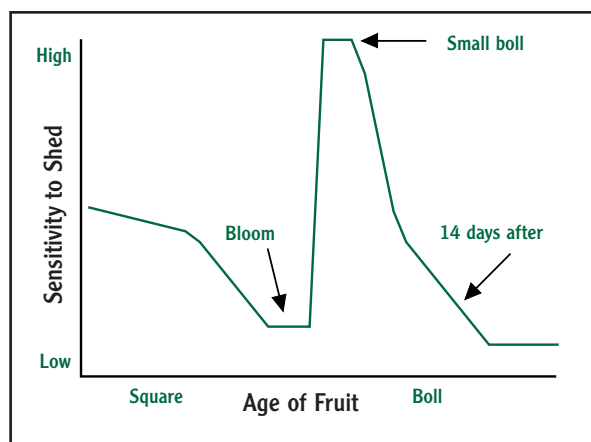

Figure 5.3. Fruit age sensitivity to shed.

Fruit shed is most harmful when cotton is planted late or during short growing seasons. Nonirrigated cotton has a higher risk of shedding because mid-season drought substantially reduces boll set.

A plant's response to fruit shed varies with local conditions and can vary from field to field. The most obvious symptoms are delayed flowering and increased vegetative growth. If fruit loss occurs early, more mid- and late-season bolls are often retained, but crop maturity will be delayed.

Under certain conditions, these plant responses can be favorable because they produce larger plants that are less prone to premature cutout during longer growing seasons. However, time is lost with delayed squaring, and the weather is unfavorable in most growing regions in Texas at the end of the bloom period. Consequently, in Texas, early fruit set is critical to successful production of high-quality cotton.

Several insecticide applications may be needed if traps show continued movement into the field from overwintered sites (wooded or brushy areas).

Natural enemies play a limited role in controlling boll weevils. Parasites of third-instar larvae also play a minor role. Although effective parasites are present in Mexico, they cannot survive Texas winters. Therefore, annual periodic releases are necessary. Rearing these boll weevil parasites is costly and so releasing parasites is cost prohibitive for producers.

Predators such as the red imported fire ant have a greater effect than do parasites, but these are limited to the eastern production region. In the west, the main reason for boll weevil deaths is the desiccation of larvae in aborted squares. This is important in nonirrigated acres but less important where irrigation is available.

Plant breeders and entomologists have identified plant characteristics that provide some protection of the fruit from boll weevils. Cotton characteristics such as frego bracts (small, twisted bracts that expose the flower bud), red plant color, okra leaf characteristics and leaf hairiness provide a level of resistance or tolerance to the boll weevil. Problems with adequate yield (red color), susceptibility to other insects (okra leaf and frego bract) and harvesting concerns (leaf hairiness) have limited the use of these characteristics in new varieties.

Other potential fruit-feeders in cotton before bloom are the bollworm/tobacco budworm complex and beet armyworms. These rarely cause economic damage before blooming. The thresh-

holds for these pests are high early in the season because few of them survive to feed on developing fruit.

Treatment decisions for caterpillar pests are made when 15 to 25 percent of the squares are damaged. To determine this, pull 100 green squares from different areas of the field and count the damaged ones.

When making insect management decisions early in the season, also consider natural enemies. Conserving natural enemies is the most cost-effective way to control insects. Start managing the natural enemy populations early so that enough remain later in the season to attack pest populations.

Multiple applications of insecticides reduce natural enemy populations. Try to maintain an adequate square set while limiting the effects of insecticide use on natural enemies.

The importance of setting early squares cannot be overemphasized. As cotton moves closer to first bloom, producers should place more emphasis on maintaining natural enemies. Table 5.3 shows how reducing insecticide rates can provide control of pests and still conserve natural enemies.

## Water, fertilizers and plant growth regulators

During this growth stage, decisions on water, fertilizers and plant growth regulators become important. Water use increases dramatically, from less than 1 inch per week to 2 inches per week at first bloom (Figure 5.4).

**Table 5.3. Impact of changing insecticide rates to conserve natural enemies. Mitchell Co., TX. 1985.**

Treatment	Rate (oz/ac)	% Fleahopper Control	% Square Set	Predators/Acre	Bollworm Larvae/Acre
Untreated		0	68	52,500	4,000
Orthene <sup>®</sup> 75 S	2	93	81	47,750	3,750
Orthene <sup>®</sup> 75 S	4	94	79	16,500	13,250



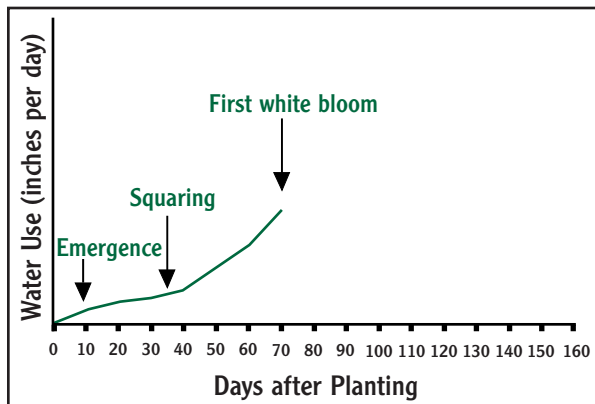

Figure 5.4. Water use for cotton up to first bloom.

Producers with adequate water should start making management decisions soon after the first bloom appears. The goal is to avoid any water stress early in the season and to have a full soil water profile as the plant reaches peak bloom (usually 3 weeks after bloom for most regions of Texas).

### Nitrogen

Fertilizer requirements at this stage are much like water requirements. In much of Texas, residual nitrogen from previous crops is adequate for early-season growth until the squares appear. Research indicates that the vegetative stage requires less than 25 percent of the plant’s nitrogen needs for the season.

Figure 5.5 shows that the plant has used 50 percent of the nitrogen by first bloom. After first

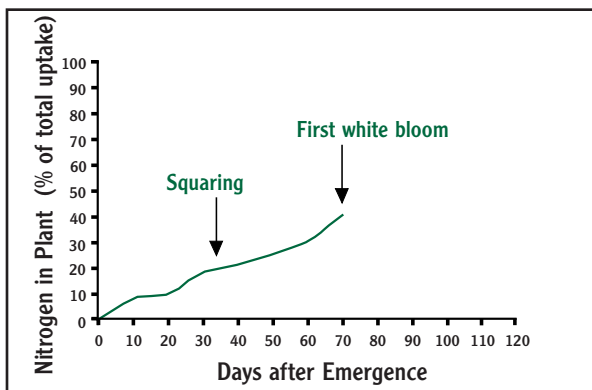

Figure 5.5. Nitrogen uptake for the period up to white bloom.

bloom, nitrogen uptake increases dramatically. The goal for producers is to have all the nitrogen applied before peak bloom.

Early in the growing season, nitrogen deficiency symptoms include lighter green foliage, slowed growth rate and smaller overall leaf area. In mid to late season, the symptoms are discolored, yellow to red leaves, smaller plants and reduced boll set.

Excess nitrogen also presents problems for cotton production. If there is too much nitrogen, the plant develops too much vegetative growth and becomes rank (excessively vigorous). This reduces its ability to cope with dry conditions, delays maturity, increases the incidence of boll rot and creates difficult defoliation conditions. Excess nitrogen also increases the risk of problems from cotton aphids.

If nitrogen is needed, apply it as a side-dress before the first white blooms appear. If more nitrogen is needed later, apply it without disturbing the root system (through irrigation or foliar sprays).

### Plant growth regulators

Cotton producers use plant growth regulators to slow plant growth and, therefore, improve harvest efficiency. In some parts of Texas, growth regulators also reduce boll rot.

One plant growth regulator used in cotton is mepiquat chloride (Pix® Plus, etc.). In cotton, it reduces the production of gibberellic acid, a plant hormone that promotes cell expansion.

Applications of mepiquat chloride suppress cell enlargement and promote shorter internodes; smaller, thicker, darker-green leaves; and ultimately shorter plants. This overall reduction in plant growth makes harvest more efficient and reduces boll rot in the eastern part of the state.

Because environments and management levels vary across Texas, no one approach to using plant growth regulators will work in all regions. However, for best results, make the first applica-

tion of mepiquat chloride early (at the matchhead square stage) and then let growing conditions and fruit retention dictate the strategy for the remainder of the season, especially in fields that historically produce rank growth.

The strategy of making early applications of a plant growth regulator provides the best chance of success. Once a cotton plant has begun to grow rapidly, especially under irrigated or good rainfall conditions, it is difficult to slow it down. Reducing growth is difficult, costly and usually unsuccessful.

Use mepiquat chloride if the plants undergo excessive early growth caused by early-season

square loss, good growing conditions and ample nitrogen fertilization. Mepiquat chloride treatments are also used on varieties that tend to produce larger, ranker plants.

Because mepiquat chloride reduces plant growth, do not apply it if the plants are already under stress. Low heat unit accumulation and water stress can reduce plant growth, and applications of mepiquat chloride during these periods can be harmful.

Once good growing conditions return, monitor plant growth to determine future use of the chemical.



**M**anagement decisions and weather conditions early in the growing season have a direct influence on boll set and yield potential. Because the eastern part of Texas has a long growing season, the cotton plant may be able to recover if fruit set is below average. In the west, however, the first 3 weeks of fruiting determine 80 percent or more of the final yield.

During this period, cotton producers need to monitor and make decisions on plant development, fruit shed, water use, nutrients, insect management and late-season disease control.

### Plant development

The period of first bloom to open boll places the greatest demands on the plant. Any shortage of carbohydrates, water or nutrients at this time will reduce yield.

Through photosynthesis, plants produce the carbohydrates (sugars) that provide the energy for plant growth and development. Cotton leaves that produce more carbohydrates than they need are called “sources.” These source leaves supply the carbohydrates for other plant parts, termed “sinks.” Sinks include developing fruit, leaves, stems and roots.

During the first 16 days after a leaf unfurls, the carbohydrates produced by that leaf are used

for its own growth. Between days 16 to 25, the leaf reaches its prime as a source and exports its carbohydrates to other developing plant parts, such as bolls. At 4 weeks old, a leaf’s carbohydrate production begins to slow until about day 60, when the leaf can no longer export sugars.

During the bloom period, the most active main stem leaf is five nodes below the terminal. At this time, the leaf 13 nodes below the terminal is non-functional.

Young squares can support themselves with carbohydrates from the bracts (triangular leaves immediately surrounding the flower bud). However, once the boll reaches 10 days old, it demands a tremendous amount of nutrients and carbohydrates. It becomes a very strong sink.

A young boll derives most of its food from the leaf immediately below it, which is termed the subtending leaf (Table 6.1). If the subtending leaf of a 4- to 7-day-old boll is shaded – for example, because of cloudy weather or a thick stand – the boll may shed from lack of carbohydrate supply.

Of the final weight of the boll, the subtending leaf contributes 50 percent and the nearest main stem leaf 35 percent. The remaining 15 percent comes from leaves elsewhere on the plant.

By the time a boll reaches peak carbohydrate demand, it is usually buried in the canopy and

**Table 6.1. Carbohydrate sources to a first-position fruit.**

1st Position Fruit Stage	Major Food Sources	Function of Stem Leaf	Function of Main Subtending Leaf
Pinhead Square	Bracts	Unfurling	Microscopic
Large Square	Bracts + Main stem leaf	Source	Unfurling
Small Boll	Bracts + Main stem leaf + Subtending leaf	Source	Source
Medium Boll	Bracts + Subtending leaf	Declining	Source
Large Boll	Leaves at top of plant + Subtending leaf	Declining	Declining

Source: D. Oosterhuis et al. 1990. Leaf Physiology and Management. Cotton Physiology Today. National Cotton Council Physiology Education Program Newsletter 1 (8): 1-6.

the leaves surrounding it are in dense shade. Bolls in this position must rely on leaves farther away at the top of the plant for carbohydrates.

Water stress, cloudy weather and nutrient deficiencies can all decrease photosynthesis and therefore reduce the carbohydrate-supplying power of the plant.

First bloom is a good time to evaluate the overall status of the plant. At 7 to 14 days after first bloom, check square retention and the number of nodes above white flower (NAWF). NAWF at early bloom will vary, depending on management and the level of stress encountered by the crop. NAWF provides a good estimate of the potential boll sites.

Studies conducted in the Coastal Bend indicate that crops produce average yields if they retain 60 to 70 percent of first- and second-position fruit (squares, flowers and bolls). Table 6.2 shows potential management guidelines for cotton production in the Coastal Bend based on fruit retention.

Drought, disease and pests can reduce terminal growth and NAWF at early bloom. Insects that remove squares, such as cotton fleahoppers and Lygus bugs, may actually increase NAWF at early bloom.

To determine NAWF, count the nodes above a first-position white flower. If the NAWF count at early bloom is below seven, the plant may reach cutout prematurely unless the plant stress is relieved. Much of the dryland production in the

western part of Texas enters early bloom at this stage.

To maintain growth, producers must carefully manage inputs. An NAWF count above 10 at early bloom may indicate reduced fruit retention or rank growth. You will need to monitor the fields continually to determine the proper management strategies.

A rapid decline in NAWF can be good or bad. It may signify excellent boll retention and high demands for nutrients and water. However, it may also indicate severe drought stress, which should be alleviated with irrigation where possible.

If NAWF remains above 10 or increases rapidly, a more significant problem may exist. This indicates that there are not enough bolls to prevent additional terminal growth. You will need to respond immediately to avoid rank growth and delayed maturity.

The plant continues to add squares and develop bolls at early bloom. The ovary (where the seed develops) is compound in domesticated cotton. A Pima cotton ovary averages three to four carpels (sections) or locules (locs) per boll. An upland cotton ovary averages four to five locs per boll.

The number of locs is determined early in square formation (3 weeks before flower opening). Although the number is strongly influenced by genetics, environment also plays a role. Most studies indicate that the carbohydrate status of

**Table 6.2. Management guidelines based on plant mapping at early bloom. Corpus Christi, TX.**

Factors Affected	Fruit Retention at First and Second Position Fruiting Sites	
	Below 60%	Above 70%
Yield potential	Below average	Above average
Potential for rank growth	Higher	Lower
Need for Pix®	Higher	Lower
Need for nutrients	Lower	Higher

Source: J.A. Landivar and J.H. Benedict. 1996. Monitoring System for the Management of Cotton Growth and Fruiting. Bulletin B-2. TAES, Corpus Christi. 16pp.



the plant influences the relative formation of four or five loc bolls. Moisture stress plays a relatively minor role. Factors such as shading and limiting resources produce bolls with fewer locs.

A cotton flower opens in the morning and then sheds its pollen. Cotton is generally considered a self-pollinating plant (if there are no insects, 95 to 99 percent of the flowers are self-pollinated). Cotton pollen is sensitive to moisture and can rupture upon contact with water (rainfall or irrigation) within 30 to 60 seconds.

The cotton fibers begin to elongate from the surface of the ovule (unfertilized seed) and can elongate for a few days even if the ovule is not fertilized. The unfertilized ovules are called notes.

Fiber initiation is sensitive to temperature. Hot weather during initiation produces shorter fibers, fewer seeds per boll, smaller seeds and smaller bolls. An average seed has 13,000 to 21,000 lint fibers, and the average loc has six to nine seeds.

Young seeds produce hormones that increase the flow of nutrients and carbohydrates to them. Bolls that produce fewer than 10 to 15 seeds are not strong sinks and are ultimately shed. High temperatures are the major cause of low seed counts.

As the fiber is lengthening and the seed expanding, the boll wall enlarges. The boll reaches maximum size and fiber reaches its maximum length in about 20 days. A lack of potassium or water can limit boll size, seed size and fiber length.

During the remainder of boll development, micronaire, maturity and strength are determined. Cellulose is laid down in winding sheets around the inside of the cotton fiber. Warm weather favors cellulose deposition and may increase micronaire values. Cool weather reduces cellulose deposition and can reduce micronaire values.

Fiber strength is related to the average length of the cellulose molecules deposited inside the cotton fiber. The longer the cellulose chains, the

stronger the fiber. Genetics controls about 80 percent of strength development, although environment does have some influence. Excessive weathering and over-ginning can weaken fiber.

Seed quality is determined in the later stages of development. Seeds reach maximum size 4 weeks after pollination. After day 25, the embryo begins to accumulate protein and oil. The same factors that decrease the maturity of the fibers also lower seed quality.

## Fruit shed

Square and boll shed are common and can be attributed to numerous factors. Large squares, blooms and medium to large bolls are generally resistant to environmental shed. Small boll shed may be an important natural process by which the plant adjusts its fruit load to match the supply of inorganic and organic nutrients.

Shedding is controlled by a series of plant hormones that regulate growth, fruiting, flowering and abscission. Boll retention declines throughout the boll-loading period as the overall nutrient “sink” demand increases.

Boll position also influences boll retention. First-position sites (bolls closest to the main stem) have a higher retention rate. Because of shading, pest pressure, light, water and nutrient availability, bolls located at second and third positions are less likely to be retained.

Although these second- and third-position bolls contribute more to yield in the eastern part of Texas because of the longer growing season, the first-position bolls generally contribute the most to the overall yield.

## Water

The plant’s water use increases dramatically during the stage from first bloom to open boll. Measured as evapotranspiration (water lost from the soil and the plant), water use can be as high 0.4 inches per day or 2.8 inches per week (Figure 6.1).



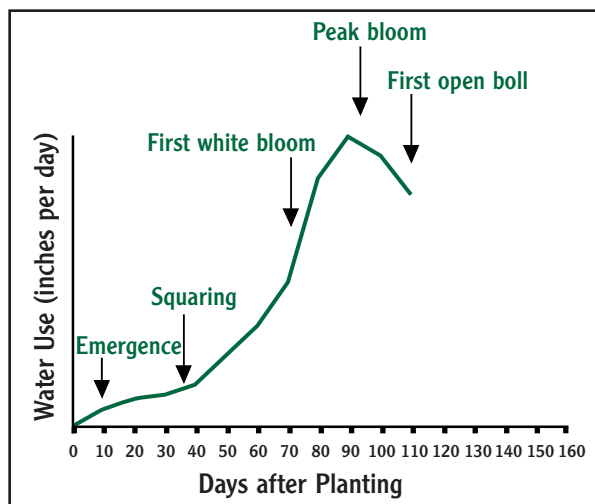

Figure 6.1. Water use for cotton up to first open boll.

Because the soil is the storage site for water available to the plant, the primary factor in determining water-holding capacity is soil texture.

The more surface area per unit volume of soil, the more water it can hold (Table 6.3). Sand particles have the largest diameter and the least surface area per unit weight. Therefore, sand retains the least water. Clay particles have the most surface area and thus retain the most water.

The total amount of water available to the growing crop is determined by the texture of

each soil zone in the effective rooting depth. Rooting depth is affected by both chemical and physical soil characteristics.

Once blooming starts, cotton prefers frequent, low-volume applications of water rather than large, less frequent amounts. This strategy minimizes the degree of water stress between rain or irrigation and thus increases fruit retention.

In the western part of Texas, very few producers have the irrigation capacity to satisfy crop demands (0.3 to 0.4 inches per day). Table 6.4 shows the relationship between irrigation water supply and a crop water demand of 0.3 inches per day.

Because center pivot irrigation systems are so prevalent in west Texas, irrigation studies have focused on making these systems more efficient and on optimizing production with limited irrigation. Low energy precision application (LEPA) irrigation systems (circle rows, dragging socks in alternate furrows, furrow diked) will extend water because of increased application efficiency.

Research indicates that cotton responds very well to high-frequency deficit irrigations, even with amounts as low as 0.20 to 0.25 inch applied every 2 days (Table 6.5). When irrigation capacities are above 0.2 inch per day, the frequency of irrigation is not as critical.

Table 6.3. Inches of water held per foot of soil depth.

Textural Class	Inches of Water Held Per Foot of Soil Depth			
	Clay loam	Loam	Sandy loam	Loamy sand
Field capacity	4.8	4.2	3.6	2.4
Permanent wilting point	2.4	2.1	1.8	1.2
Plant available water	2.4	2.1	1.8	1.2

Table 6.4. Relationship between irrigation water supply and crop water replacement when water use is an average of 0.3 inches per day. GPMA is gallons per minute per acre.

Irrigation, GPMA	1	2	3	4	5	6
Irrigation, inches/acre/day	0.052	0.104	0.155	0.207	0.259	0.311
% water replacement	17	34	52	69	86	104



**Table 6.5. Cotton lint yield using LEPA irrigation at three irrigation capacities and three frequencies of application. Halfway, TX. 1995-1997.**

Irrigation Capacity		Seasonal Irrigation	1 Day Frequency	2 Day Frequency	3 Day Frequency
Day	Per Acre	Pounds of Lint per Acre			
0.1	2	4.6	917 b	980 a	922 b
0.2	4	6.7	1142 a	1120 a	1110 a
0.3	6	7.1	1165 a	1142 a	1187 a

Values in a row followed by the same letter are not statistically different.

### Nutrient management

Cotton requires most of its nutrients during the fruiting stage. During this time, bolls are heavy consumers of nutrients, and any shortage will reduce yield (Figure 6.2). Nitrogen fertilizer should be applied before first bloom.

Growers can use irrigation systems to deliver nitrogen and other nutrients to the crop. This method is used extensively in west Texas, where center pivot irrigation comprises 50 percent of the acreage, and soils are very sandy.

Under most conditions, soil-applied nutrients are adequate to meet crop demands. However, in some situations, foliar fertilization can increase yields. Foliar feeding may be useful in exception-

al years when there is a very high boll set (above 70 percent) and not enough nitrogen was applied or in seasons when high rainfall has leached the nitrogen below the root zone. Keep in mind, however, that foliar fertilization increases yield only when there is a nutrient deficiency.

To increase yield, at least three applications totaling 15 pounds of actual N are usually required. Make applications at early bloom and then on 7- to 14-day intervals if the cotton is not under stress.

To avoid injuring the leaves, use feed-grade or low-biuret urea. A typical rate on irrigated cotton is 3 pounds of urea per gallon of water (equivalent to 1.38 pounds of actual nitrogen per gallon) and for dryland, 1.8 pounds of urea per gallon of water (equivalent to 0.84 pounds of actual nitrogen per gallon).

Each application should deliver a minimum of 5 pounds of actual nitrogen per acre. The urea solution will break down quickly, releasing ammonium. Because this ammonium is converted to ammonia, which is toxic to plant tissue, use the solutions immediately. Do not let the mixture stand overnight or serious plant injury could occur.

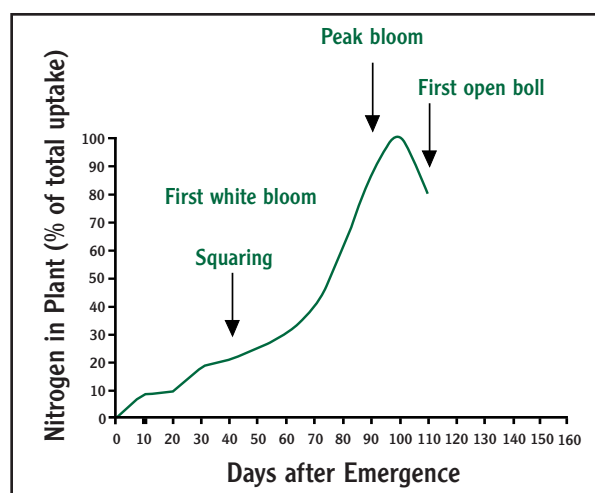

**Figure 6.2. Percent nitrogen in plant up to white bloom.**

### Insect management

Insects that attack cotton in this growth stage include boll weevils, bollworms/tobacco budworms, beet armyworms, pink bollworms,

This period reflects the results of weather conditions and management steps taken throughout the season. During this stage, growers should focus primarily on water and insect management. You will also need to manage disease and make decisions about harvest aids.

### Water use

At peak bloom, cotton requires about 0.3 inch of water per day. By harvest, the rate will drop considerably, to less than 0.1 inch per day (Figure 7.1).

In a “perfect environment,” dryland producers would have a full profile of moisture at the third week of bloom, followed by a couple of timely rain showers. Producers with furrow irrigation have more control than dryland producers but still must make the last irrigation before bolls open.

Late applications of excessive water can lead to many problems, including boll rot, late season regrowth, an increase in late-season insect pests,

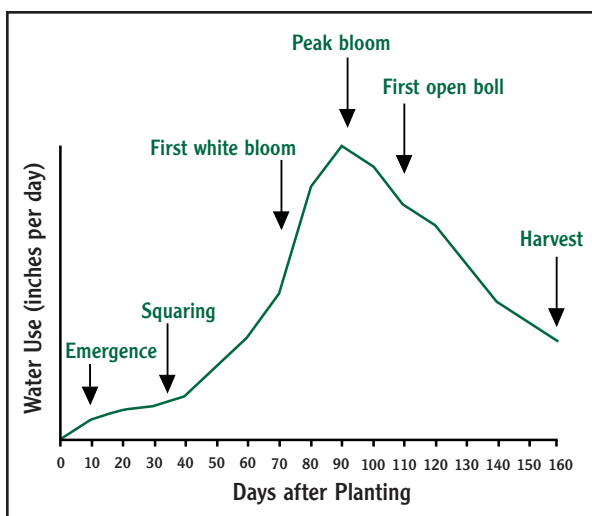

Figure 7.1. Water use for cotton up to harvest.

added harvest aid inputs and possible grade reductions from late-season regrowth.

In West Texas, furrow irrigation should be terminated before September 1. Sprinkler or drip irrigation should be continued for 1 to 2 weeks after open boll or until 20 percent of the bolls are open. The goal is to provide adequate moisture for the last harvestable bolls to mature.

### Nitrogen use

After boll opening, nitrogen uptake plummets (Figure 7.2). Although nutrient deficiencies are common during this period, it is too late to take corrective action. When boll growth peaks, so does demand for several nutrients, especially potassium.

The root system is no longer functioning at full capacity because of demands from developing bolls. Soil nitrogen needs to be in short supply by harvest. If there is too much nitrogen, regrowth problems will increase, as will harvest aid costs and potential late-season insect problems. Excessive nitrogen can also reduce lint quality.

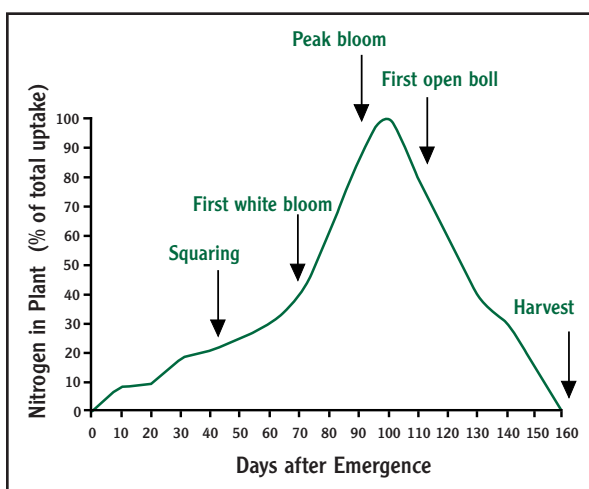

Figure 7.2. Percentage of nitrogen in the plant up to harvest.

### Plant development

During this period, it is still wise to monitor nodes above white flower (NAWF) by counting the nodes above the uppermost first position white flower (Figure 7.3). The terminal node is the one with an unfurled main stem leaf larger than a quarter (more than 1 inch in diameter).

NAWF measures the potential boll loading sites remaining. At this point in the season, all carbohydrates produced by the plant are committed to boll development. Monitoring NAWF is critical at this time because pest managers need to know when the last harvestable boll has been set.

Research indicates that the last effective flowers that need to be protected appear when NAWF is equal to five. This changes somewhat in the

western part of the state, where NAWF equal to four is a more reliable estimate.

Cotton physiologists define cutout to be when NAWF is equal to four or five. Before then, approximately 100 flowers will produce 1 pound of seed cotton. After cotton reaches cutout, the number of flowers needed to produce 1 pound of seed cotton increases dramatically.

In estimating when the plant has reached cutout, NAWF is a more reliable indicator than are calendar dates. Table 7.1 provides calendar dates for the last effective bloom period for some of the production regions in Texas.

The dates vary widely because of weather and location. Dates for the South, Central and Lower Rio Grande Valley are due to the effect of weather on harvest. The dates for the Rolling Plains

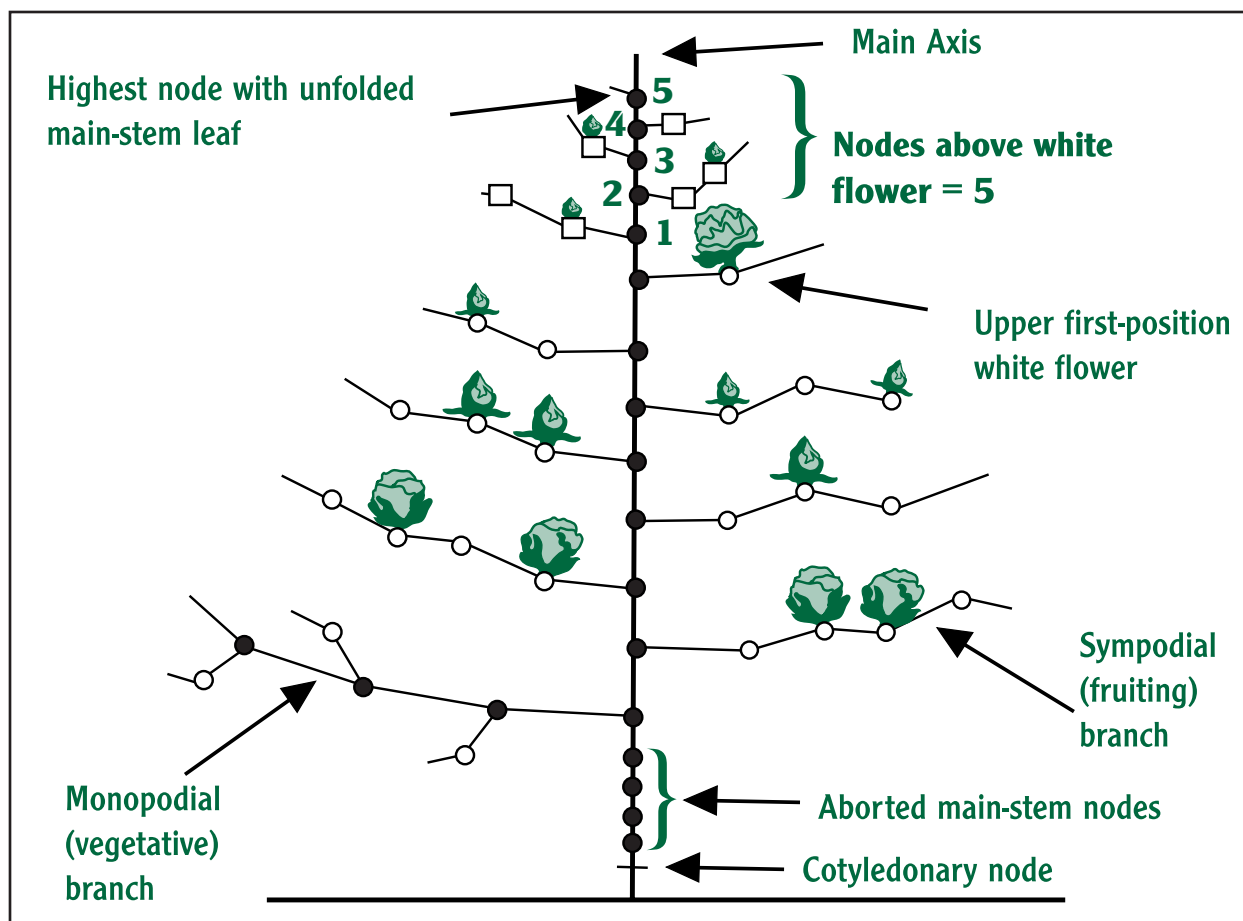

Figure 7.3. Nodes above white flower (NAWF) equal to five.

**Table 7.1. Estimate of effective bloom period for some growing regions of Texas.**

Lower Rio	
Grande Valley	June 1 to June 20
Coastal Bend	June 10 to July 5
Blacklands, Winter Garden	
	July 5 to July 15
Rolling Plains	August 20 to September 5
High Plains	August 15 to September 1

and High Plains are due to limited heat units. Although boll set can occur after these dates, bolls that set later generally have lower fiber quality.

### Insect control

Monitoring NAWF is also a key to making late-season insect decisions. The same fruit-feeding complex that causes problems during peak bloom will also lower yields later in the season. Although thresholds change little from peak bloom, the emphasis shifts from protecting squares and bolls to protecting developing bolls.

Recent studies using the computer model COTMAN have verified treatment termination rules for fruit-feeding insects. Once bolls accu-

mulate 350 to 450 heat units, they suffer less damage from bollworms and boll weevils (Figure 7.4).

NAWF, heat units and historical weather data can be used for more than predicting cutout. Table 7.2 is an example of using NAWF and historical weather to predict the dates when bolls are safe from insect damage in the High Plains.

In the above example, a bloom on August 1 would be safe from boll weevils on August 18 and would be a mature boll on September 19. A bloom on August 5 would mature 10 days later than a bloom on August 1.

The extra time is needed because fewer heat units accumulate later in the season. The reduced heat unit accumulation is also the reason that blooms on August 20 have a negligible impact on yield, because the chances of the bolls reaching maturity (750 DD60) are reduced in West Texas.

Blooms that accumulate 350 DD60 are safe from *Lygus* spp. feeding. Those that accumulate 450 DD60 are safe from newly hatched larvae, but larger larvae could penetrate bolls (Figure 7.4).

Insects with stronger mouthparts, such as stink bugs, can penetrate older bolls, so heat unit accumulations should reach 600 DD60 after cutout (NAWF = 5).

**Table 7.2. Heat unit (HU) events based on date of cutout (NAWF=4) and actual Lubbock, TX temperatures (August 1-29). Focus on Entomology, 2001.**

Heat Unit Accumulation	Date When Crop Achieved Cutout (NAWF=4)					
	August 1	August 5	August 10	August 15	August 20	August 25
+350 HU (safe from weevils)	Aug. 18	Aug. 22	Aug. 27	Sept. 2	Sept. 11	Sept. 19
+450 HU (safe from worm egg lay)	Aug. 22	Aug. 26	Sept. 3	Sept. 10	Sept. 20	Oct. 1
+750 HU (near mature boll)	Sept. 10	Sept. 18	Sept. 30	Oct. 16	N/A	N/A
+850 HU (fully mature boll)	Sept. 19	Sept. 29	Oct. 18	N/A	N/A	N/A

## Web sites

Diseases in Texas cotton

<http://plantpathology.tamu.edu/Textlab/Fiber/Cotton/cottop.html>

High Plains cotton information

<http://lubbock.tamu.edu/ipm/AgWeb/cotton/insect/cotindex.htm>

Links to cotton industry sites

<http://sanangelo.tamu.edu/agronomy/cotton.html>

National Cotton Council

<http://www.cotton.org>

Cotton Incorporated and links to COTMAN information

<http://www.cottoninc.com>

Texas Cooperative Extension:

Cotton information

<http://insects.tamu.edu/cotton/>

Entomology publications

[http://insects.tamu.edu/extension/ag\\_and\\_field.html](http://insects.tamu.edu/extension/ag_and_field.html)

Ordering and accessing publications

<http://texaserc.tamu.edu>

Soil and crop sciences cotton information

[http://soil-testing.tamu.edu/topics/Cotton/cotton\\_index.html](http://soil-testing.tamu.edu/topics/Cotton/cotton_index.html)

Irrigation information and moisture evaluation (University of Nebraska)

<http://www.ianr.unl.edu/pubs/irrigation/>

Potential evapotranspiration (PET) for Texas North Plains

<http://amarillo2.tamu.edu/nppet/petnet1.htm>

Pesticide applicator training

<http://www.aes.tamu.edu>

Texas Evapotranspiration Network

<http://texaset.tamu.edu>

Texas Plant Disease Diagnostic Laboratory

<http://plantpathology.tamu.edu/index4.html>

Texas Tech information on thrips and *Lygus* spp. in the High Plains

<http://www.pssc.ttu.edu/entomology>

Texas Department of Agriculture

<http://www.agr.state.tx.us/>

Texas Pest Management Association

<http://www.tpma.org>

## Publications

Texas Cooperative Extension publications

B-933, "Identification, Biology and Sampling of Cotton Insects"

B-1593, "Cotton Harvest-Aid Chemicals"

B-6046, "Guide to the Predators, Parasites and Pathogens Attacking Insect and Mite Pests of Cotton" (\$5.00)

B-6107, "Bt Cotton Technology in Texas: A Practical View"

E-5, "Managing Cotton Insects in the Southern, Eastern and Blackland Areas of Texas"

E-6, "Managing Cotton Insects in the High Plains, Rolling Plains and Trans Pecos Areas of Texas"

E-7, "Managing Cotton Insects in the Lower Rio Grande Valley of Texas"

E-5A, "Suggested Insecticides for Managing Cotton Insects in the Southern, Eastern and Blackland Areas of Texas"

E-6A, "Suggested Insecticides for Managing Cotton Insects in the High Plains, Rolling Plains and Trans Pecos Areas of Texas"





## Late Season Issues in 2006



## **Late Season Irrigation Issues in 2006**

**Dr. Randy Boman  
Extension Agronomist-Cotton  
Lubbock**

The 2006 growing season has been one of many challenges. Lack of rainfall has devastated our dryland crop and has made profitability of our irrigated crop difficult. Many fields have virtually no profile moisture, except in the irrigation zone, at this time. Many fields are now entering cutout. Some have crashed hard, and others are on the way down. This implies a lower yield than we may desire. It also indicates that this crop will mature much faster than what we have experienced in recent years.

Fruit shed is underway in some fields that can't keep up with crop moisture demands. Normally a boll will be retained once it reaches 10-14 days after bloom. Even though the boll may still be retained by the plant, it will likely be smaller and have shorter fiber length due to moisture stress. Many deficit irrigated pivot fields have soil profiles that are depleted of moisture. We would like to target the soil profile to be nearly depleted as we enter harvest aid season. One should keep the field with reduced stress at least until the final bloom to be taken to the gin becomes about a 10-14 day old boll. This will reduce the likelihood of small bolls shedding due to water stress. Fiber length is generally determined during the first 25 days or so in the life of the boll. This indicates that small amounts of irrigation should be applied to carry the boll through the important fiber length development phase. After that, late bolls can handle considerable stress. For a boll set on August 10th, it is apparent that the field should have reduced amounts of water stress probably at least through the end of the month, unless rainfall is obtained to offset irrigation. Otherwise moisture stress could limit quality of the uppermost bolls. A rod probe or other tool may be useful in determining the amount of moisture remaining in profiles in fields. Water holding capacities of major High Plains soils are found in Table 1.

When using the COTMAN program developed by the University of Arkansas, various investigators across the Cotton Belt have noted that irrigation termination at about 500-600 DD60 heat units past cutout (here defined as nodes above white flower = 5 on a steep decline) has been reasonable. Most of these project reports published in the Beltwide Cotton Conference Proceedings lacked information on soil profile moisture status in the trials at the time the irrigation was terminated. I suggest producers use this as a guide, not as the gospel. With center pivots, low amounts of irrigation can be applied if the cotton is severely stressed after initial termination. Many fields will likely reach wilting quickly. If the amount of wilting is unsuitable for the boll load, then the pivot can be passed over the field to apply an additional increment of water.



As we move into the boll opening growth stage of cotton, the crop coefficient decreases from about 1.0 at first open boll to about 0.8 at 30 percent open bolls and decreases rapidly after that. That implies that once we get to the boll opening phase, if reference ET is averaging 0.25 inches per day, the crop will use about 1.4 inches per week (0.25 x 0.8 x 7 days). The value of continued center pivot irrigation after bolls begin to open is probably questionable, unless record high temperatures and high reference ET is encountered and the field has a depleted moisture profile and a late boll load. Generally, we observe about 2-5 percent boll opening per day once bolls begin to open. This implies that if the last irrigation is made at a few percent open bolls, then it should take about 10 days to reach 30-60 percent open bolls. With the depleted soil profiles in many fields which have missed the rainfall, the rate of boll opening may be on the high side this year.

Table 1. Average available water holding capacities for typical High Plains soils.

<b>Soil series</b>	<b>Dominant texture</b>	<b>Available water holding capacity, inches/foot</b>
Amarillo fine sandy loam	sandy clay loam	1.8
Amarillo loamy fine sand	sandy clay loam	1.7
Arvana fine sandy loam	sandy clay loam	1.8
Brownfield fine sand	sandy clay loam	1.4
Portales fine sandy loam	sandy clay loam	1.6
Acuff loam	sandy clay loam	1.9
Olton loam	clay loam	2.0
Estacado clay loam	clay loam	1.6
Pullman clay loam	clay	1.8
Miles fine sandy loam	sandy clay loam	1.8
Ulysses clay loam	clay loam	1.6
Mansker loam	clay loam	1.8
Lofton clay loam	clay	1.9

Data from High Plains Underground Water Conservation District Number 1 and NRCS.

Table 2. Limited cotton irrigation for a 1/4 mile center pivot on 120 acres.

<b>GPM</b>	<b>GPM</b>	<b>LEPA</b>	<b>Percent deficit replacement</b>	<b>LEPA</b>	<b>Spray</b>
180	1.5	0.07	32	0.53	0.48
240	2.0	0.10	42	0.70	0.63
300	2.5	0.12	50	0.84	0.79
360	3.0	0.15	63	1.05	0.94
420	3.5	0.17	71	1.19	1.10
480	4.0	0.20	83	1.40	1.26
540	4.5	0.23	96	1.61	1.42
600	5.0	0.25	104	1.75	1.55

### **Nodes Above White Flower (NAWF)**

Nodes above white flower at first bloom gives an indication of crop vigor and yield potential. Typically, NAWF should be high at first bloom and then decrease as the boll load ties down the plant, and mainstem node production rate slows or ceases. For the High Plains region, greater than 8 NAWF could be considered excellent, 6-7 - reduced yield potential possible unless adequate irrigation is quickly initiated or rainfall obtained, 4-5 or less - cutout imminent on determinate varieties. Of course with so many varieties and many of the picker types being more indeterminate than many of our older stripper types, their ability to hang in there without cutting out is certainly worth consideration. Water (rainfall, irrigation) is the key with these variety types. In many years, we can enter bloom in irrigated fields at 8 or so. Last year, due to good early growing conditions and excellent rainfall distribution, many fields - even dryland fields entered first bloom with around 10 NAWF and thus the record crop production. Many fields that were stressed for moisture may have a short bloom period due to few NAWF at early bloom.



# *Irrigation Management for Sorghum Production*

## **In this Section**

Overview: Irrigation Management for Sorghum Production

Reference: Irrigating Sorghum in South and South Central Texas (L-5434)

## **Overview**

Sorghum is a relatively drought-tolerant crop that can be produced over a range of irrigation levels, from rain-fed (dryland) to deficit to full irrigation. It is often a feed grain of choice where irrigation capacity is limited.

### **Objectives:**

- Increase understanding of water requirements (peak water use, seasonal water use, critical growth stages, drought sensitivity/tolerance, and water quality requirements) of sorghum.
- Increase water use efficiency and profitability in sorghum production through application of appropriate best management practices.

### **Key Points:**

1. Sorghum is relatively resistant to drought and salinity. Grain sorghum has an extensive root system, and its drought tolerance makes it suitable for limited irrigation.
2. Seasonal water use for sorghum in the Texas High Plains is approximately 13 to 24 inches per season. Seasonal water demand is approximately 24 inches. Deficit irrigation management (water available is less than crop demand) is common practice, often due to limited water supply.
3. Peak water use occurs just before and during boot stage.
4. Late-season water stress during grain filling can result in shriveled seeds, which reduces yield.



## *Irrigation Management for Sorghum Production*

### **Assess your knowledge:**

1. What is the peak water use of sorghum in your area? When (growth stage and calendar range) does this occur?
2. What is the maximum effective root zone depth for sorghum? Are there other factors in your field or management program that you would expect to limit this effective root zone depth? What practical significance do these limitations have with respect to your irrigation and nutrient management programs?
3. Are there water quality (salinity) concerns for sorghum production on your farm? If so, what are they? How can they be managed?
4. What irrigation method do you currently use to irrigate sorghum? What best management practices (BMPs) are you using to optimize water use efficiency? Identify other methods and BMPs that would be applicable to your operation.



## *Irrigation Management for Sorghum Production*

Grain sorghum is a tropically adapted plant that can survive under drought and adverse conditions. Because of its ability to survive in unfavorable conditions, sorghum is often produced in poor soils and with poor management. However, profitable sorghum production requires sufficient water at critical points in the crop's development. Good crop management, including good irrigation management, is key to high yields and profitability.

Sorghum can produce an extensive fibrous root system as deep as 5-6 feet, but it generally extracts more than 75 percent of its water and nutrients from the top 3 feet of soil. As moisture is depleted from the top 3 feet, the crop will extract water (if available) from deeper in the root zone. Plants can use about 50 percent of the total available water without undergoing stress.

Water availability is most critical during the rapid growth stage and before the reproductive stage. If plant maturity is delayed due to water stress, the crop may face frost damage in the event of an early freeze. Late-season water stress during grain filling can result in shriveled seeds, which reduces yield.

Grain sorghum's peak use begins at approximately initiation of the reproductive stage; this peak can be 0.3 inches per day (or temporarily higher in hot, dry weather conditions). Seasonal water demand for grain sorghum is 24-28 inches (from rainfall, stored soil moisture and irrigation). Grain sorghum has an extensive root system, and its drought tolerance makes it suitable for limited (deficit) irrigation.

Irrigation of grain sorghum on sandy soils requires more frequent and smaller irrigation applications than on soils with higher water holding capacity. Center pivot irrigation is an excellent option for irrigating in these conditions. Irrigation scheduling using evapotranspiration or by maintaining a given soil water depletion balance may be especially useful where soils with low water holding capacity and/or restricted root zones present challenges to irrigation management.

### **Common mistakes affecting Sorghum Water Use**

- **Waiting too long to apply the first irrigation.** The head begins to form about 35 days after planting. If the plant is stressed during this period, the number of seeds per head will be reduced.
- **Irrigating too late.** Do not irrigate after the hard dough stage or after the plants have reached physiological maturity.
- **Over-planting.** For irrigated production, do not exceed 70,000 to 80,000 established plants per acre; dryland production should not exceed 50,000 to 60,000 plants per acre. Excessive plant population increases plant competition, reduces head size, increases the chance of charcoal rot and lodging, and reduces water use efficiency.



# *Irrigation Management for Sorghum Production*

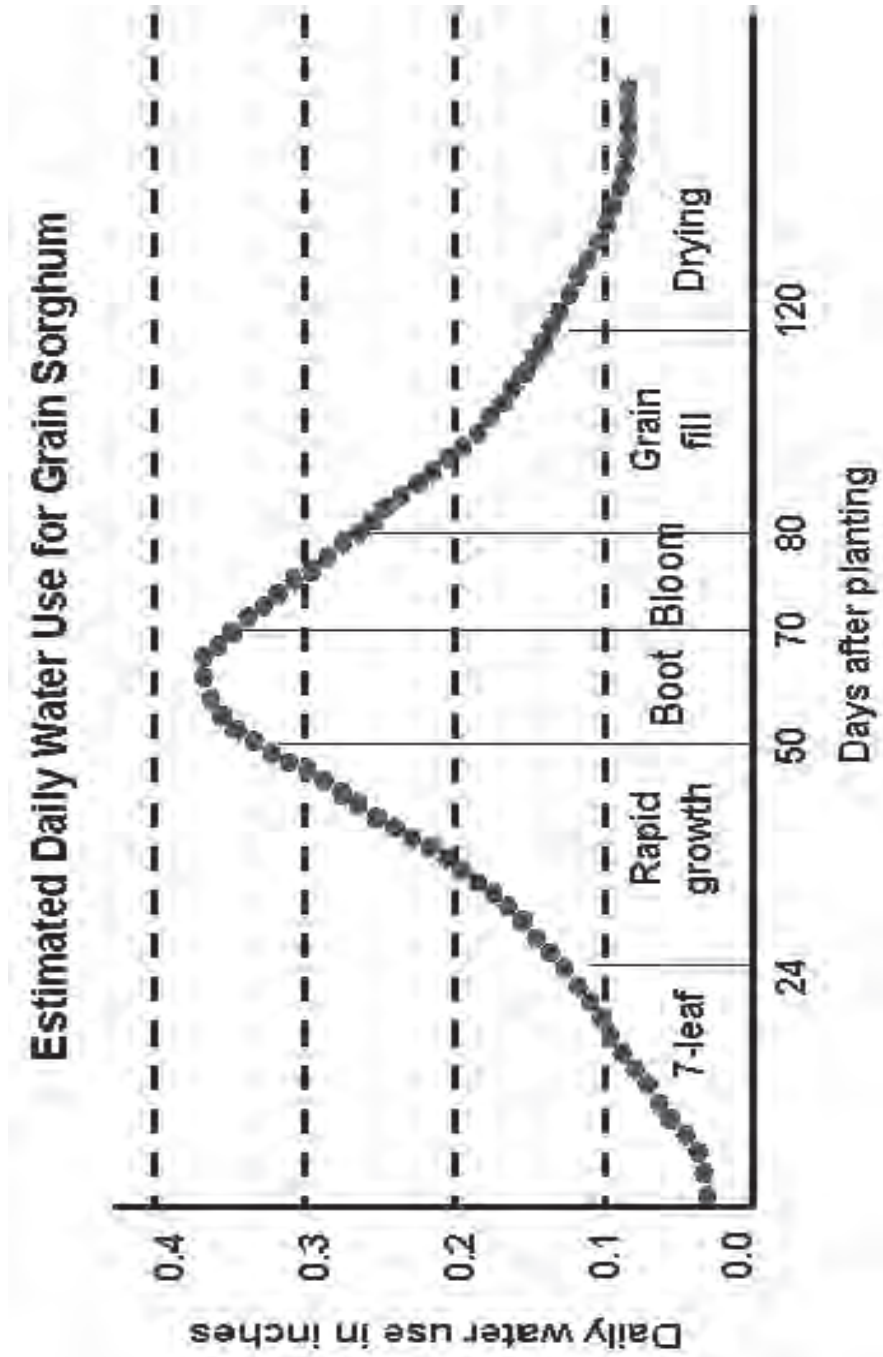



# Irrigating Sorghum in South and South Central Texas (L-5434)

# Irrigating Sorghum in South and South Central Texas

Charles Stichler and Guy Fipps\*

**“W**ATER IS ALL we sell in agriculture.” Whether the enterprise is corn, cattle, cauliflower, cotton, or grain sorghum, water is essential for its production and the single most important aspect of production that determines yield.

Grain sorghum is a tropically adapted plant that can survive under drought and adverse conditions. Because of its ability to survive in unfavorable conditions, sorghum is often relegated to poor soils and poor management.

However, to be profitable, a sorghum crop needs sufficient water at critical points in its development. Therefore it is vital that growers manage irrigation properly. If grain sorghum is managed well, it will produce profitable, high yields.

## Growth and development

Like other grains, the ultimate purpose of a sorghum plant is to produce seeds. Seed production is a singular event — the plant’s root, leaf and stem development are all directed toward this outcome.

Because yield is determined by both the number and weight of seeds, it is vital for growers to understand the plant processes that affect seed development. One such process is photosynthesis, in which green plant tissues take carbon dioxide from the air, water and nutrients from the soil and energy from sunlight and convert them into sugars or carbohydrates. The products of photosynthesis are also called photosynthates.

The more active, functioning leaves a plant has, the more photosynthates it will produce, and thus the greater its yield potential. To increase yield potential, growers need to take management steps that support leaf development, maximize photosynthesis and limit water loss.

A critical component of the photosynthesis process is water. Water can be said to be part of a plant’s circulatory system — water moves throughout the plant, carrying with it plant minerals, nutrients and plant chemicals such as enzymes, proteins, sugars and carbohydrates. Water evaporates from the leaf and is replaced with water from the soil in a process called transpiration.

A sorghum plant gets more than 75 percent of its water and nutrients from the top 3 feet of soil. Plants can use about 50 percent of the total available water without undergoing stress.

The availability of water is the key factor to consider when deciding on row spacing and plant population. Moisture dictates yield goals, which in turn dictate seeding rates and spacing. For irrigated production, growers should aim for between 70,000 and 80,000 established plants per acre; for dryland production, the total should be 50,000 to 60,000

---

\*Associate Professor and Extension Agronomist, and Professor and Extension Irrigation Engineer, The Texas A&M University System



established plants per acre. (For more information, refer to B-6048, *Irrigated and Dryland Sorghum Production*.)

Yields will be reduced if the plants are too crowded. The more plants that are established, the more water the crop will use. If too many are planted, much of the soil moisture will be used before the reproductive stage begins, rendering the plants unable to produce seeds.

Research has been conducted at Texas Tech University on the amount of water per acre required by sorghum. The studies have shown that sorghum at pre-bloom uses 8 to 10 inches of water per acre and that each additional inch will produce 385 to 400 pounds of grain.

For a grain yield of 7,000 pounds per acre, total water use — from both soil and plant evaporation — is about 28 inches of water per acre. However, water use varies greatly in sorghum, depending on the final yield, the maturity of the hybrid, planting date and weather conditions. For this reason, prior to planting, the soil profile should be filled to 24 inches deep if a grower desires a maximum yield.

## Water needs at different growth stages

Water needs for sorghum vary according to the different plant stages — different amounts are used in the seedling development phase, the rapid growth and development stage, and the bloom to harvest phase (Fig. 1).

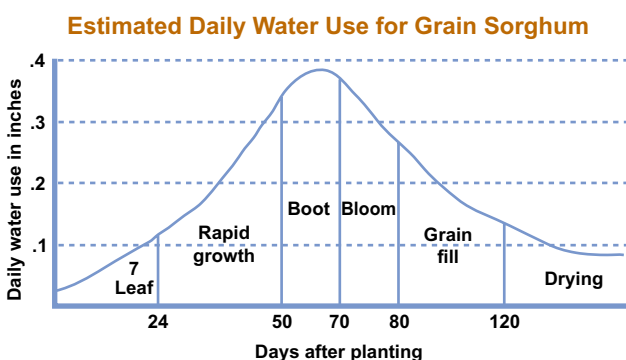

Figure 1. Water needs for sorghum rise sharply at the rapid growth stage, peak during the boot stage and then drop off afterward.

## Seedling development

The seedling development stage begins at germination and ends at about 26 days after planting,

when the plants have five to six mature (fully expanded) leaves. This early-growth stage does not directly affect the number of seeds produced, but it does set the direction of development.

Although water management is not critical during the seedling development period, minor stress does affect future growth, plant size and yield potential.

During the seedling stage when the soil is not shaded, more moisture is lost through soil evaporation than by transpiration from leaves. To minimize moisture losses from the soil, it is important that you adopt water-conserving practices, such as:

- Residue management
- Conservation tillage
- Narrow-row spacing
- Good weed control, and
- Proper planting date for rapid canopy establishment

## Rapid growth and early reproductive phase

The need for water is extremely critical during the rapid growth stage and before the reproductive stage. If the plants are water stressed during the rapid growth stage, it does not matter what steps a grower takes afterward — the number of flowers has already been determined and yield will be reduced.

After seedling development, water needs begin to increase as the leaves enlarge and expand. Because leaves are the part of the plant that collect energy from the sun, growers should adopt production practices (such as those listed above) that encourage early leaf development.

About 40 days after planting, the total number of leaves has been determined and one-third of the total leaf area has developed. During this period, the growing point changes from vegetative to reproductive, and the seed panicle begins to form inside the stalk.

During the next 30 to 35 days, the immature leaves continue to grow and the number of ovules that will develop into seed are formed until the flag leaf (final leaf) emerges and the plant begins to boot. The size of the panicle and number of seeds are determined between day 35 and 65 by adequate water, fertility and photosynthate production. Root formation is completed and the panicle (head) is

visible in the bottom of the plant inside the stalk.

The demand for water is extremely critical during this stage because the potential head size has already been determined before head exertion begins. The goal is to limit moisture stress during the rapid growth phase so that a robust plant structure and full panicle have been produced.

Growers should not wait too long to irrigate, else production will suffer. Water use will be about 0.2 to 0.3 inch per acre per day. Up to bloom, sorghum will use about 8 to 10 inches and any moisture stress during this period will reduce the yield potential.

### **Bloom to harvest (reproductive stage)**

In the next stage, the plant develops from bloom to physiological maturity, which is when the seeds are fully developed and no further weight is added. This phase requires about 45 days to complete. Sorghum blooms over a 5- to 9-day period. During this time, the proteins and photosynthates that are produced and stored in the leaves are moved into the developing grain.

During the period just before bloom and until early grain fill, sorghum will use about 0.35 inch of water per day, declining to 0.1 inch a day when the grain is dry. Anything that reduces leaf function — such as leaf loss, water or nutrient stress, or disease or insect damage — will eventually reduce yield.

Growers should time the final irrigation to carry the crop from the last irrigation to black layer, or physiological maturity. Any additional irrigation just before and after this point is wasted. From physiological maturity until harvest, the crop is just drying down. By harvest, the plant will have absorbed about 35 pounds of nitrogen and 11 pounds of phosphate for each 1,000 pounds of grain and stover produced. After the initial 8 to 10 inches of water to reach bloom, each additional 1 inch of water will produce 350 to 425 pounds of grain, bringing the total to 28 inches of water for a 7,000-pound yield.

### **Furrow irrigation**

Furrow irrigation is best timed according to the plants' stage of growth. Furrow irrigation is not as exact as is sprinkler irrigation. If furrow irrigation is managed well, most water applications will be about 3 to 4 inches per irrigation.

A good guide is to apply irrigations at key growth stages if there is no rain and additional soil moisture is needed:

1. If the soil profile is full at planting, the stored soil moisture should supply the water requirements until the first irrigation at the reproductive stage.
2. The onset of the reproductive stage is 30 days after planting. One 4-inch irrigation will last the 25 days until flag leaf.
3. At flag leaf or boot stage, two 3-inch irrigations about 2 weeks apart will last until soft dough in the grain fill period.
4. The last irrigation will maximize yield, but is generally not economical and does not pay for the water. One 3- or 4 inch-irrigation is needed at soft dough to complete grain fill, which takes about 45 days from bloom to reach black layer.

Using this schedule, the appropriate amount of irrigation water will be applied during each growing period if rainfall is not received. If those amounts are totaled for the entire growing period, the amount need by the crop will approximate the following:

$$\begin{aligned} &6 - 8 \text{ inches} && \text{rainfall or pre-irrigation to fill} \\ &&& \text{the soil profile if totally dry} \\ &+ 4 \text{ inches} && \text{30 days after planting} \\ &+ 6 \text{ inches} && \text{in two 3-inch irrigations at flag} \\ &&& \text{leaf or boot stage} \\ &+ 3 \text{ inches} && \text{at soft dough} \\ &= 19 - 21 \text{ inches} && \text{of total water} \end{aligned}$$

The 19 to 21 inches is the amount of water needed to produce a crop without stress. The total amount needed will vary somewhat, depending on weather conditions such as heat, low humidity, cloud cover and wind.

### **How much replacement water is needed?**

The amount of water a crop uses is known as evapotranspiration (ET), which is the water lost through a combination of two processes: evaporation, which is the water removed from the soil, and transpiration, which is the water removed from the plant leaves. The amount (in inches) of water used by a crop in a day is called daily ET.

ET varies by weather conditions (such as wind, humidity, temperature, cloud cover or solar radiation) and by plant characteristics (such as canopy

closure). Because it is related to the leaf surface area, smaller plants transpire less than do larger plants, and ET is lower.

Growers can minimize evaporation from the soil by:

- Spacing the plants equally in narrow rows. Narrow-row crop production reduces the amount of bare soil, which loses more moisture through evaporation than do shady and mulched soil surfaces.
- Leaving crop residues, which can reduce soil evaporation by 1 to 3 inches during the season.

### Irrigation scheduling based on potential evapotranspiration

Researchers have developed a simple way for growers to calculate the water requirements of their crops. First, the water requirements of a standard plant were developed to use as a reference. That plant's water requirements are referred to as **PET** (potential evapotranspiration).

Growers can now use PET to calculate the estimated water needs of their crops. To determine the amount of water being used by their crop, growers multiply the PET by the crop coefficient (Kc) for the specific crop being grown and for that crop's growth stage. For sorghum, the crop coefficients in the North High Plains are listed by stage of growth in Table 1. Researchers at the Uvalde Research and Extension Center are working to determine the sorghum crop coefficients for South Texas.

PET can be obtained for different parts of the state on the Internet at <http://texaset.tamu.edu/> where weather stations across much of south Texas will give producers weather information to calculate PET for a day or several days.

Please note that the dates listed are provided only as a general guide, as crop growth rate is affected by many factors, including location, variety, current weather and soil moisture conditions.

### How to Use PET

To calculate the water requirements of your crop, multiply the PET by the crop coefficient using the following equation:

$$PET \times Kc = \text{Crop water requirements}$$

PET is the sum of daily PET over the period of interest, such as the 3-day or weekly total.

**Table 1. Sorghum crop coefficients in the North High Plains.**

Growth Stage <sup>1</sup>	Crop Coefficient (Kc)	Days After Planting <sup>2</sup>
Seeding	0.40	3 - 4
Emergence	0.40	5 - 8
3-leaf	0.55	19 - 24
4-leaf	0.60	28 - 33
5-leaf	0.70	32 - 37
GPD	0.80	35 - 40
Flag	0.95	52 - 58
Boot	1.10	57 - 61
Heading	1.10	60 - 65
Flower	1.00	68 - 75
Soft dough	0.95	85 - 95
Hard dough	0.90	95 - 100
Black layer	0.85	110 - 120
Harvest	0.00	125 - 140

<sup>1</sup>Sorghum will bloom at different times, depending on location, planting date and maturity of the variety.

<sup>2</sup>The days after planting are for a medium-early to medium-late variety.

Kc is the crop coefficient for the current stage of crop growth.

*Example 1:* The 5-day PET total is 1.32 inches. Your sorghum is in the "heading" growth stage. What are the water requirements? (Note: From Table 10, the "heading" crop coefficient is 1.10.)

$$1.32 \text{ inches} \times 1.10 = 1.45 \text{ inches}$$

Thus, to irrigate the sorghum adequately during this period, apply 1.45 inches to replace the water used by the sorghum in the past 5 days.

### Adjusting for irrigation system efficiency

If your irrigation system is inefficient, you may need to compensate for it by increasing the amount of water you irrigate. See Table 2 for the typical efficiency ranges of on-farm irrigation systems. To adjust for irrigation system efficiency, use the following equation:

$$PET \times Kc = \text{Eff} = \text{Irrigation water requirements}$$

Eff is the overall efficiency of the irrigation system.

*Example 2:* You are irrigating with a low-pressure center pivot. You estimate that your overall system efficiency is 85 percent. What are the irrigation water requirements for the sorghum in Example 1?

$$1.32 \text{ inches} \times 1.10 = 0.85 = 1.71 \text{ inches}$$

You will need to irrigate 1.71 inches to meet the plants' water requirements for that period.

**Table 2. Typical overall on-farm efficiencies for various types of irrigation systems.**

System	Overall Efficiency
<u>Surface</u>	<u>0.50 - 0.80</u>
Common	0.50
Land leveling and water volume per row meeting design standards	0.70 - 0.80
Surge	0.60 - 0.90 <sup>1</sup>
<u>Sprinkler</u>	<u>0.55 - 0.75<sup>2</sup></u>
Center Pivot	0.55 - 0.90 <sup>2</sup>
LEPA	0.90 - 0.95
Drip/Trickle	0.80 - 0.90 <sup>3</sup>

<sup>1</sup>Surge has been found to increase efficiencies 8 to 28% over non-surge furrow systems.

<sup>2</sup>Higher efficiencies are for low wind conditions.

<sup>3</sup>Trickle systems are typically designed at 80 to 90% efficiency.

## Adjusting for rainfall and soil moisture

Rainfall reduces the amount of irrigation water needed to meet plant requirements. However, not all rainfall can be used by plants and crops. Some of the rainfall will be lost to evaporation from the top 2 to 3 inches of soil, runoff and deep percolation (water moving below the root zone), depending on such factors as soil type and slope, soil moisture levels and the duration and intensity of rainfall.

In irrigation scheduling, the term *effective rainfall* refers to the part of the rainfall that can be used by

plants — the part that infiltrates into and is stored in the root zone. Growers must estimate the effective rainfall for each field and for each rainfall. Generally, do not record rainfall of less than 1/4 inch because it evaporates so quickly. Then subtract the amount of effective rainfall from the irrigation requirement determined with Equation 1 or 2.

You may use soil moisture monitoring devices to determine soil moisture levels and the date to restart irrigations after rains. For more information on this procedure, see Texas Cooperative Extension publications B-1670, *Soil Moisture Management*, and B-1610, *Soil Moisture Monitoring*.

## Common mistakes

Growers need to avoid these common mistakes affecting water usage:

- **Waiting too long to put on the first irrigation.** The head begins to form about 35 days after planting. If the plant is stressed during this period, the number of seeds per head will be reduced.
- **Irrigating too late.** Do not irrigate after the hard dough stage. Also do not irrigate after the plants have reached physiological maturity, which is 45 days after flowering or at black layer. After that point, the individual seed's "umbilical cord" is sealed off and stops functioning. It will not gain any more weight after this event, which occurs at about 30 percent moisture.
- **Over-planting.** For irrigated production, do not exceed 70,000 to 80,000 established plants per acre; dryland production should not exceed 50,000 to 60,000 established plants per acre. Over-planting reduces head size, increases the chance of charcoal rot and lodging, increases plant competition, and increases water use with little increase in yield.

Proper irrigation management is critical for profitable yields. If you pay attention to timely and adequate irrigation, you can keep costs to a minimum while maximizing production.

Produced by Agricultural Communications, The Texas A&M University System  
Extension publications can be found on the Web at: <http://tcebookstore.org>

Educational programs of Texas Cooperative Extension are open to all people without regard to race, color, sex, disability, religion, age or national origin.

Issued in furtherance of Cooperative Extension Work in Agriculture and Home Economics, Acts of Congress of May 8, 1914, as amended, and June 30, 1914, in cooperation with the United States Department of Agriculture. Chester P. Fehlis, Director, Texas Cooperative Extension, The Texas A&M University System.  
2.5M, New



# *Irrigation Management for Forage Production*

## **In this Section**

Overview: Irrigation Management for Forage Production

Reference: Irrigation of Forage Crops (B-6150)

Reference: Forage Bermuda Grass: Selection, Establishment and Management (E-179)

Reference: Managing Annual Winter Grass in South and Southwest Texas (L-5238)

## **Overview**

### **Objectives:**

- Increase understanding of water requirements (peak water use, seasonal water use, critical growth stages, drought sensitivity/tolerance, and water quality requirements) of key forage crops.
- Increase water use efficiency and profitability in forage crops production through application of appropriate best management practices.

### **Key Points:**

1. Crop and variety selection should include consideration of available water supplies and crop water (quantity and quality) requirements.
2. Alfalfa is well adapted to arid regions, but it requires more water for profitable production than most agricultural crops. Alfalfa can develop a very deep root system. It can tolerate periods of drought stress, but this stress will result in yield loss. Similarly, alfalfa can tolerate some salinity, but poor quality irrigation water will result in yield loss. With efficient irrigation methods and management, alfalfa requires 5-7 acre-inches of water per ton of alfalfa produced. Peak water use can be 0.35" per day (and occasionally as high as 0.5"/day) in the High Plains.



# *Irrigation Management for Forage Production*

## **Assess your knowledge:**

1. What is the peak water use of key forage crops in your area? When (growth stage and calendar range) does this occur?
2. What is the maximum effective root zone depth for the crop? Are there other factors in your field or management program that you would expect to limit this effective root zone depth? What practical significance do these limitations have with respect to your irrigation and nutrient management programs?
3. Are there water quality (salinity) concerns for forage production on your farm? If so, what are they? How can they be managed?
4. What irrigation method do you currently use to irrigate forages? What best management practices (BMPs) are you using to optimize water use efficiency? Identify other methods and BMPs that would be applicable to your operation.



# Irrigation of Forage Crops (B-6150)

# Irrigation of Forage Crops

Juan Enciso, Dana Porter, Guy Fipps and Paul Colaizzi\*

**I**rrigation can increase the production of forages where rainfall is limited. In planning an irrigation system it is important for farmers to know how to determine the water requirements of the crops they are growing.

Geographic location, soil type, time of the season, and the way a crop responds to water all affect the amount of water a particular crop needs. Farmers should also know the characteristics of different irrigation systems.

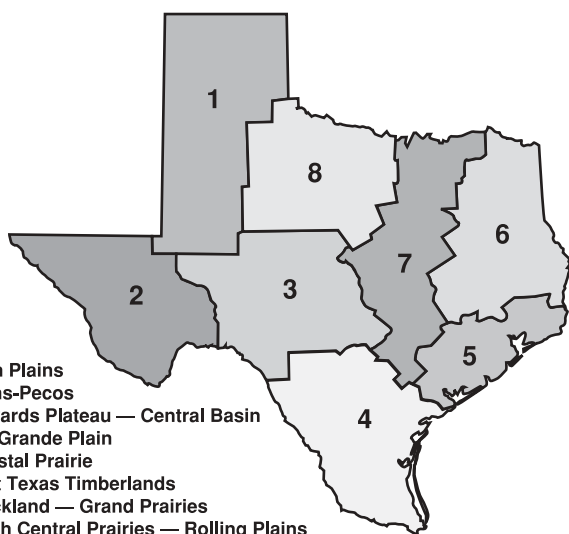

1. High Plains
2. Trans-Pecos
3. Edwards Plateau — Central Basin
4. Rio Grande Plain
5. Coastal Prairie
6. East Texas Timberlands
7. Blackland — Grand Prairies
8. North Central Prairies — Rolling Plains

Figure 1. Land resources divisions and irrigated areas. Source: Durwood, 1960. Texas Water Board of Engineers.

## Seasonal and Peak Water Requirements

Forage crops include:

- cool-season annuals (wheat, oats);
- warm-season annuals (corn, sorghum and hay grazers, which are crosses of sorghum, sorgo and sudan grasses); and
- perennials (alfalfa and grass pastures).

Table 1 shows seasonal and peak water requirements of common forage crops in the various regions of Texas. Water requirements vary during the growing season, as is shown in Figure 2. The peak water requirement is defined as the amount of water the plant needs each day during the month of the highest demand, which is usually July in Texas. Peak

Table 1. Water requirements for selected forage crops.

Location	Alfalfa and pastures		Sorghum		Corn	
	Seasonal (in.)	Daily (GPM/ac.)	Seasonal (in.)	Daily (GPM/ac.)	Seasonal (in.)	Daily (GPM/ac.)
1. High Plains	58-66	6.6	21-26	6.2	27-31	6.7
2. Trans-Pecos	65-67	6.7	27	6.6	31	8.5
3. Edwards Plateau – Central Basin	59-67	6.7	23-26	6.1	27-31	8.8
4. Rio Grande Plain	50-67	6.8	17-23	5.6	20-27	7.7
5. Coastal Prairie	47-49	4.7	18	4.8	21.5	6.5
6. East Texas Timberlands	46-49	4.9	19	4.7	21	5.7
7. Blackland – Grand Prairies	49-51	4.9	20	4.9	23	6.5
8. North Central Prairies – Rolling Plains	58-62	5.2	25	4.8	27-30	7.3

Durwood, M. R. M. Dixon and O. Dent. 1960. Bulletin 6019. "Consumptive use of water by major crops in Texas." Texas Board of Water Engineers.

\* Respectively, Assistant Professors and Extension Agricultural Engineers, The Texas A&M University System; Professor and Extension Agricultural Engineer, The Texas A&M University System; and Agricultural Engineer, USDA-ARS.



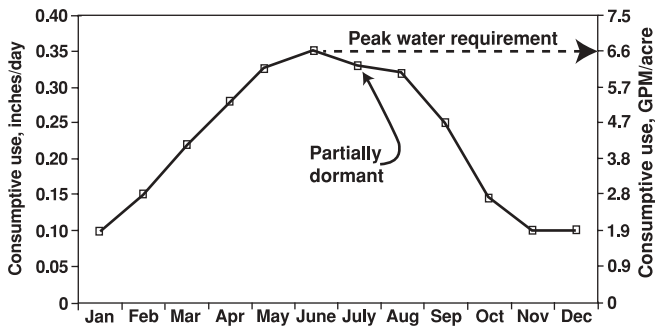

Figure 2. Alfalfa peak and seasonal water requirements. Source: Pair, et al. 1983. Irrigation.

water requirements help determine how many acres can be irrigated with a particular canal or well capacity. The peak water requirement is generally expressed in gallons per minute required per acre, or the inches required per day.

**Example 1.** How many acres of fully irrigated alfalfa can be supported with a well yielding 800 GPM if the alfalfa has a peak daily demand of 6.6 GPM per acre in the High Plains?

$$\text{acres} = \frac{800 \text{ GPM}}{6.6 \text{ GPM/acre}} = 121 \text{ acres}$$

## Forage Yield and Water Used

Forage yield is influenced by the amount of water the crop receives and by the length of the growing season. In some areas of Texas the growing season allows six to seven cuttings of alfalfa. Alfalfa needs 5 to 6 inches of water to produce 1 ton per acre. With irrigation it may be possible to obtain 12 tons per acre of alfalfa in some years.

Water use efficiency is the crop yield per unit of water applied. The more water applied to a crop, the lower the water use efficiency because some water will be lost through runoff or deep percolation into the soil. The type of irrigation system used and its management greatly influence water use efficiency.

Studies in the High Plains have shown that forage sorghum, grain sorghum, and hay grazers can produce 1.1 tons of fresh matter per inch of water applied (including rainfall and irrigation), when the silage contains 65 percent moisture at harvest.

## Irrigation Methods

Irrigation water can be applied by sprinkler, surface and subsurface drip irrigation systems. Each method has advantages and disadvantages. Water is distributed through these systems by gravity flow (as in surface irrigation) or by pressurized flow (as in sprinkler irrigation and subsurface drip irrigation).

### Sprinkler Systems

When sprinklers are properly designed and managed so that the amount of water applied does not exceed the amount the soil can hold, runoff and water logging problems can be avoided. A disadvantage of all sprinklers is the foliar damage that can occur in some crops (including alfalfa) if the water has a high concentration of salt. Sodium (Na+) or chloride (Cl-) concentrations greater than 350 ppm may cause this problem. Irrigation must be managed more carefully if the salt concentration is high.

Sprinklers can be classified as permanent, portable, and continuous movement.

#### Permanent sprinklers

Permanent sprinklers are used on small plots of less than 10 acres. They might also be used where labor costs need to be reduced, on small ranchettes with pastures for horses, or in areas where household waste water is being reused.

#### Portable sprinklers

The portable systems are either laterals that can be moved manually or mechanically or single big sprinklers commonly called big guns.

Systems with **hand-moved laterals** are assembled from pipe sections of aluminum tubing connected by quick couplings. Each pipe has a riser pipe supporting a sprinkler head. The application rate depends on the sprinkler size and spacing. The mainline is usually buried in the soil and the laterals take the water from a riser with a hydrant valve (Fig. 3, left). The change of sprinkler position is facilitated by quick coupling pipe sections at the end of the pipe (Fig. 3, right). Pipe sections

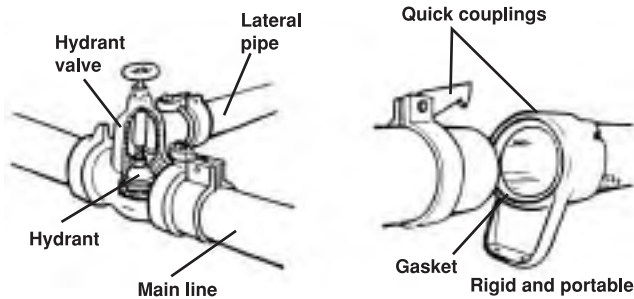

Figure 3. Hydrant valves (left) and quick coupling aluminum pipe (right).

Source: Soil Conservation Service, 1971.

usually are 30 or 40 feet long and 2, 3 and 4 inches in diameter. The pressure in the pipe is usually 75 psi. Irrigation times are 12 to 24 hours. Hand-moved sprinkler sets are moved manually from one irrigation position to another as illustrated in Figure 4.

**Mechanically moved** sprinklers include side-roll and power-roll systems (Fig. 5). The main lines are usually buried and have hydrants in strategic points to connect the laterals (as in Fig. 4). The system remains connected in one position for some time. After irrigation is completed in this position, the line is unhooked and moved to the next position. Typical systems are up to 1/4 mile (1,320 feet) long and they are moved every 60 feet, so an area of 1.8 acres is irrigated in one set time. One of the problems with these systems is that

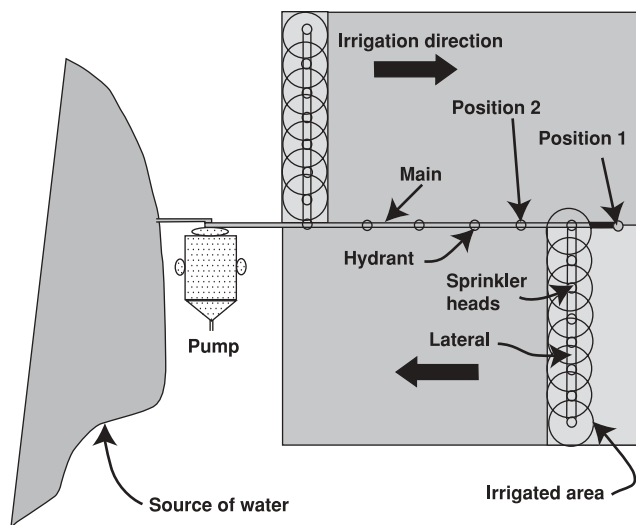

Figure 4. Movement of a hand-moved lateral system from one position to another.



Figure 5. Side-roll sprinkler system.

a lot of labor is required to change positions and to keep them aligned.

**Hand-moved big guns** are sprinklers with large diameter nozzles ( $5/8$  inch or more) that discharge at least 100 GPM. These sprinklers are rotated with a rocker arm drive and can irrigate an arc. Because they operate under high pressure (generally more than 80 psi), the energy requirements and operating costs are relatively high. That makes them best suited for supplemental irrigation. A single big gun sprinkler and a common change of irrigation positions are shown in Figure 6. This is one of the least efficient kinds of sprinkler systems.

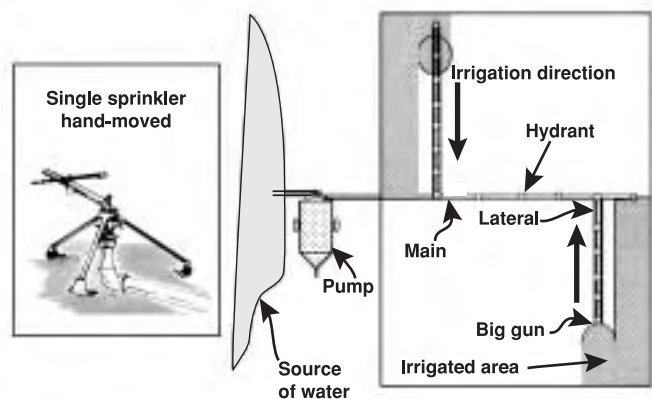

Figure 6. Big gun (left) and changing positions with two big gun sprinklers (right).

Source: Soil Conservation Service, 1971.

### Continuous movement sprinklers

The continuous movement systems are the center pivots (Fig. 7), linear systems (Fig. 8) and traveler big guns (Fig. 9).

**Center pivot** irrigation systems are generally preferred over other sprinkler systems because of their low labor and maintenance

requirements and easy operation. Center pivots sprinkle water from a continuously moving overhead pipeline that is supported by towers. The towers are driven by electric or oil hydraulic motors located at each end tower; these are controlled by a central panel (Fig. 7). The typical distance between towers is 90 to



Figure 7. Center pivot sprinkler system.



Figure 8. Linear moving system with a flexible hose.

Source: Texas A&M University Research and Extension Center at Weslaco.



Figure 9. Traveler big gun irrigation system.

Source: Mexican Institute of Water Technology.

250 feet. The most common overall length of a pivot system is 1,320 feet ( $\frac{1}{4}$  mile); this is about the radius of the circular area of approximately 126 acres, often inscribed within a square section of 160 acres. A system this size usually has 6-inch diameter laterals (for a capacity of up to 900 GPM). Pivots can be 2,640 feet long ( $\frac{1}{2}$  mile) and cover a circular area of 503 acres. These half-mile pivots are inscribed in a 640-acre square (1 section, or 1 square mile of land) and usually require 10-inch pipe laterals. Some smaller systems are now available for smaller fields. While full-scale systems can be shortened, the unit cost (cost per acre) of cut-down systems is often higher. Corners of square areas can be irrigated with a special corner apparatus attached to the pivot. Most pivots are permanently installed in the field. However, some "towable systems" can be moved between fields. Properly designed and maintained center pivots have very uniform water distribution (more than 90 percent), making them well suited for fertigation and chemigation.

**Linear moving lateral systems** can be self-propelled with diesel motors and directed by guidance systems. These systems are used to irrigate rectangular fields with uniform topography. The distribution uniformity of these systems can be very high (more than 95 percent). Linear systems can take the water from an open channel or from a hydrant with a flexible hose (Fig. 8).



**Center pivot and linear moving sprinkler systems** can be equipped for MESA (mid-elevation spray application), LESA (low elevation spray application), or LEPA (low energy precision application). LEPA systems are more expensive initially because nozzle spacing is much closer. However, energy costs are lower and water application efficiency is high with LEPA systems. A variety of spray nozzles (with different spray patterns, delivery rates, etc.), drop hoses and drag hoses (for LEPA application) are available to accommodate different crops, cropping systems, and water management strategies. The MESA system requires 6 to 30 psi, while LESA and LEPA systems can work with 10 to 15 psi. Pressure regulators can make distribution more uniform on fields with sloping or undulating topography. Water application rates are adjusted by changing the speed of travel of the overhead lateral, which makes these systems adaptable to the permeability of the soil and the water needs of the crop. They are suited to many topographic conditions and soils.

A **traveler big gun** is a high-capacity sprinkler mounted on a self-propelled vehicle or on a vehicle dragged by the hose as it winds up in a reel (Fig. 9). The self-propelled type pulls itself along by winding in a cable as it drags the hose. The cable is anchored at one end. The hose-drawn traveler has a hose reel at the water supply end; a pump supplies the water to the gun and gives the hydraulic energy to the reel to pull it. Both types irrigate a semi-circular area. They do not wet the towpaths in which they are moving, but irrigate a strip of the field as they move along the towpath. As with portable big guns, they have relatively high energy requirements, have low efficiency, and are generally used for supplemental irrigation.

### Surface Irrigation

Surface irrigation systems are suited to deep soils (more than 4 feet deep) of clay to loam texture. Surface irrigation efficiency can be improved by using either gated pipe or concrete delivery channels. This also reduces weed problems on field borders. The soil should have good water storage capacity because of the relatively long interval between

irrigations. The most common surface irrigation systems are 1) sloping or graded furrows and borders and 2) level basins.

#### *Sloping furrows and borders*

Furrows are used to irrigate row crops such as corn, vegetables, cotton and sorghum, while borders are used to irrigate cover crops such as pastures and alfalfa. With sloping furrows and borders, it is important to balance the speed of water advance and inflow to apply the desired depth of water uniformly. If water advances too quickly there will be excessive runoff or deep percolation at the downstream end. If water advances too slowly there will be too much deep percolation at the upstream end. Deep percolation losses can be managed by irrigating alternate furrows, compacting furrows with tractor wheels before irrigating, or using surge irrigation. Runoff losses can be reduced by using runoff recovery systems, shorter furrow lengths, and dams at the lower ends of furrows. The components of a sloping border irrigation system are shown in Figure 10.

#### *Level basin irrigation and level furrows*

The development of laser-controlled grading in the 1970s promoted the adoption of level basin irrigation. The objective of level basin irrigation is to deliver a uniform depth of water to a level field by flooding it very quickly. The size of the basin and the infiltration rate of the soil determine the flow rate. Usually 3 to 5 inches of water are applied, depending on the soil conditions. A basin must be properly designed and leveled so that it applies water efficiently and uniformly (Fig. 11).

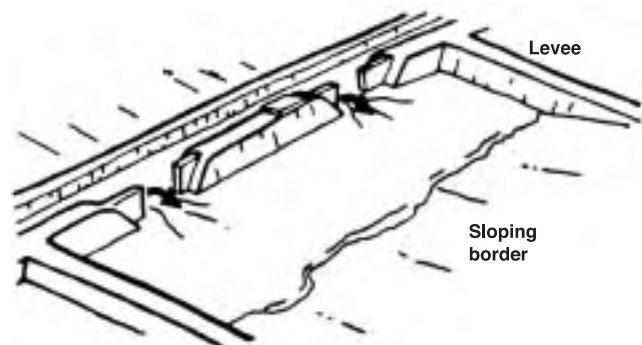

Figure 10. A sloping border irrigation system.

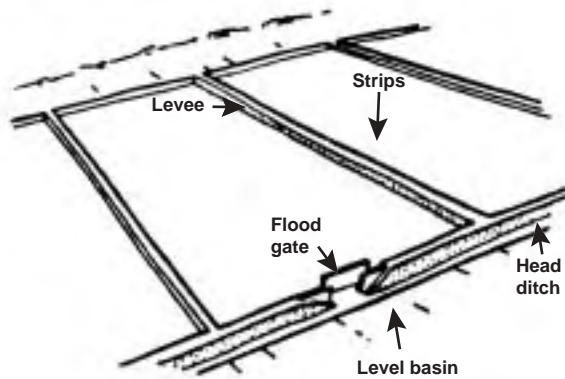

Figure 11. A level basin system.  
Source: Soil Conservation Service. 1971.

### Subsurface Drip Irrigation

Subsurface drip irrigation (SDI) applies water through buried drip tapes spaced uniformly so that a uniform amount of water is applied between the drip lines. The spacing between drip tapes and the depth at which they are buried are important factors in system design. Soil texture, cultural practices, crops and economics will affect the spacing between drip lines. Sandy soils usually require a closer spacing than clay soils. Good results have been observed in pastures, hay and forage crops when lines are spaced 30 inches apart in sandy soils and 40 to 80 inches apart in medium-texture soils. Tapes are usually buried 13 to 20 inches deep for forage crops. One of the advantages of SDI is that irrigation can continue during hay cutting and baling, which often increases productivity and quality. In fact, studies have shown that crop production can be higher with subsurface irrigation than with sprinkler irrigation.

SDI drip tapes can be clogged by soil or roots and damaged by gophers. Clogging usually can be prevented with proper filtration, maintenance, and mixing of fertilizers (if they are applied with irrigation water). To prevent roots from clogging the tapes, a chemical barrier can be created with the herbicides treflan or trifluralin. Figure 12 shows equipment used for the installation of an SDI system.

### Selecting an Irrigation System

One way to measure the performance of an irrigation system is to calculate its irrigation efficiency. The irrigation efficiency is the vol-



Figure 12. Installation of a subsurface drip irrigation system.

ume of water stored in the root zone compared to the volume delivered by the system. The efficiency must account for deep percolation, evaporation and wind drift, and is highly affected by the uniformity with which the water is applied over the field. Selecting the right system and managing it well are the keys to good water use efficiency. When selecting a system, consider economics, site characteristics (soil, topography, water supply, etc.), crop requirements, and the overall farm operation. Table 2 lists various factors that affect the selection of an irrigation system, such as field slope, soil texture (infiltration and water-holding capacity), and cost.

To select the right system, analyze several options. For example, compare the cost of land grading for a surface system to the cost of installing a pressurized irrigation system. If the soil is shallow, some soil cuts during land leveling can diminish production. Another example is to consider whether the intake rate (rate of infiltration into the soil) for a surface system is so low that it will take several days to irrigate from one side of the field to the other. If so, there could be substantial water stress in the crop and a sprinkler system might be more efficient.

### Summary

Remember that water requirements vary according to the location and time of the growing season, and that yields are affected by the amount of water applied. The irrigation system selected will influence the productivity per unit of water applied. Irrigation should be carefully managed along with other agronomic practices such as pest management and fertilization.

**Table 2. Factors considered in selecting an irrigation system.**

Factors	Sprinkler systems					Surface (gravity) irrigation systems			Drip
	Portable	Wheel roll	Solid set	Center pivot linear move	Gun	Graded border	Level border	Furrow	
<b>Slope limitations:</b>									
Direction of irrigation	20%	15%	None	15%	15%	0.5-4%	Level	3%	None
Cross slope	20%	15%	None	15%	15%	0.2%	0.2%	10%	None
<b>Soil limitations:</b>									
Intake rate (inches/hour)									
Minimum	0.1	0.1	0.05	0.3	0.3	0.3	0.1	0.1	0.02
Maximum	None	None	None	None	None	6.0	6.0	3.0	None
Texture	Medium to sandy	Medium to sandy	Medium to sandy	Fine to sandy	Medium to sandy	Fine to medium	Fine to medium	Fine to medium	Medium to sandy
Holding capacity (inches/feet)	3.0	3.0	None	2.0	2.0	2.0	2.0	2.0	None
Soil depth	None	None	None	None	None	Deep	Deep	Deep	None
<b>Water limitations:</b>									
Total Dissolved Solids (TDS)	Severe	Severe	Severe	Severe	Severe	Slight	Slight	Moderate	Slight
Rate of flow	Low	Low	Low	High	High	Moderate	Moderate	Moderate	Low
<b>Climatic factors:</b>									
Wind affected	Yes	Yes	Yes	Yes	Yes	No	No	No	No
<b>System costs (2001 data):*</b>									
Capital cost (\$/acre)	400-500	400-500	450-800	400-600	350-400	500-600	650-1000	500-600	800-1200
Labor cost (\$/acre)	>70	50	50	<10	>70	>70	50	>70	<10
<b>Irrigation efficiency*</b>									
	70-75	70-75	55-70	74-81	62-63	65-82	75-80	50-70	>90
<b>Energy requirements (feet)</b>									
Head required (feet)	140	140	140	45	185	5	5	5	45

\*The efficiency values for sprinkler and subsurface drip irrigation systems were reported by Cuenca, 1989. The irrigation efficiencies were reported by Clemmens, 2000.

Source: Irrigation Water Use in the Central Valley of California. 1987. Division of Agriculture and Natural Resources, University of California. Department of Water Resources, State of California.

## Additional Information

- "Center Pivot Irrigation." B-6096, Texas Cooperative Extension.
- Cuenca, Richard. 1989. Irrigation System Design: An Engineering Approach. Prentice Hall.
- Clemmens, A. J. 2000. Level Basin Irrigation Systems: Adoption, practices, and the resulting performance. 4<sup>th</sup> Decennial National Irrigation Symposium, Phoenix, Arizona.
- Durwood, M., R. M. Dixon and O. F. Dent. 1960. Consumptive use of water by major crops in Texas. Bulletin 6019, Texas Board of Engineers.
- Irrigation Water Use in the Central Valley of California. 1987. Division of Agriculture and Natural Resources, University of California. Department of Water Resources, State of California.
- Pair, C. H., W. Hinz, K. R. Frost, R. E. Sneed and T. J. Schilts. 1983. Irrigation. 5<sup>th</sup> edition. The Irrigation Association.
- Soil Conservation Service. 1971. Planning for an irrigation system. Ed. AAVIM.

Produced by Agricultural Communications, The Texas A&M University System  
Extension publications can be found on the Web at: <http://tcebookstore.org>  
Visit Texas Cooperative Extension at: <http://texasextension.tamu.edu>

Educational programs of Texas Cooperative Extension are open to all people without regard to race, color, sex, disability, religion, age or national origin.

Issued in furtherance of Cooperative Extension Work in Agriculture and Home Economics, Acts of Congress of May 8, 1914, as amended, and June 30, 1914, in cooperation with the United States Department of Agriculture. Chester P. Fehlis, Director, Texas Cooperative Extension, The Texas A&M University System.

500, New



# Forage Bermuda Grass: Selection, Establishment and Management (E-179)



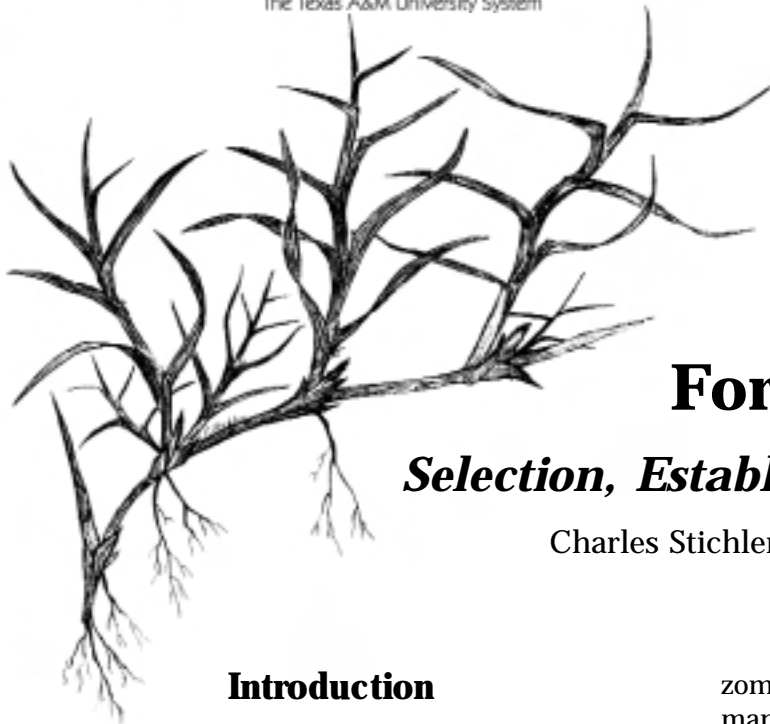

## Forage Bermudagrass:

### *Selection, Establishment and Management*

Charles Stichler and David Bade, Extension Agronomists  
The Texas A&M University System

#### **Introduction**

In April of 1943, with the introduction of Coastal bermudagrass (an F<sub>1</sub> hybrid between selections from Georgia and South Africa), forage production with perennial grasses changed dramatically and permanently. Hybrid bermudagrass is sterile and will not produce viable seed, so it must be vegetatively propagated and is usually planted by using "sprigs." Sprigs are made up of either root pieces or rooted stolons or runners.

Immediately after its introduction, extensive research began in many states to evaluate the forage potential of this hybrid grass under various management schemes. Experiments with nitrogen rates as high as 1,800 pounds of actual nitrogen per acre and other nutrients were conducted under dryland and irrigated conditions to determine just how much forage this new "miracle" grass could produce. Countless feeding trials were also conducted to determine the digestibility and nutritive value under various management practices. Since then, Coastal bermudagrass has become the standard by which other grasses are compared.

These trials have shown that Coastal bermudagrass is more drought- and grazing (defoliation)-tolerant than many grasses. These tolerance levels are due to its spreading growth by stolons and rhi-

zomes and its ability to reestablish itself if mismanaged or partially killed out. It responds well to adequate fertility and rainfall or irrigation and can grow under a variety of soils and climatic conditions in the South. However, Coastal bermudagrass is susceptible to freeze injury and will be killed in areas where the soil freezes. It is truly a "miracle grass" in many ways.

Since the introduction of Coastal bermudagrass, there have been many introductions of similar hybrid grasses: Coastcross-1, African Star, Alecia, Callie, Tifton 44, Tifton 78, Brazos, and recently, Grazer, Tifton 85, World Feeder, Russell and Jiggs. These newer selections are rapidly becoming very popular. Research is being conducted to evaluate their adaptability and forage production as compared to Coastal bermudagrass.

In addition to hybrid bermudagrass, selections were made from common bermudagrass and two varieties are most prevalent, Giant and NK-37. Although these two grasses generally produce less forage than the hybrids, they are seeded varieties and offer an advantage to owners of small acreages. These grasses do not spread as rapidly as the hybrids but have a more upright growth habit than common bermudagrass.

The following yield test results are from Bryan (sandy loam soil), Overton (sandy soil, East Texas), and Jackson (clay soil) Counties.

**Table 1. Yield as a Percentage of Coastal Bermudagrass.**

Variety*	Bryan (3 Years)	Overton (3 Years)	Jackson Co. (2 Years)	Average
Coastal	100	100	100	100
Tifton 85	146	134	146	142
Jiggs	125	144	120	130
Tifton 78	102	105	112	106
World Feeder	96	86	47	76

David Bade, Gerald Evers, S. Simecek and M. Hussey.

## Establishment

Establishment is a critical step. Considering the time, effort and expense involved in establishing any forage, attention to details is important to success. The ideal seed bed is smooth, firm, weed-free, moist and fertile; it is free of excess residue or “trash,” compaction zones, and harmful insects and plant diseases; it also has good soil structure.

### Land Preparation

For many people, grass is not a crop, it is just grass. But in order to get the full potential from any intensively managed crop, the crop should be planted on productive soils. Producers of hybrid bermudagrass should think of their “crop” as any other crop. Grass planted on low-potential, marginal soils will have a low yield potential.

Adequate seedbed preparation is important. It creates the proper environment in which to plant. Obviously, limiting factors such as stumps, pot holes or salt problems due to poor drainage should be eliminated before planting. Initial tillage may include moldboard plowing, heavy disking with an offset disk, chiseling or subsoiling. The soil should be worked with a disk to eliminate trash and reduce clod size. The seed bed should be as good as for any other crop. The seedbed should be free of clods, firm, and not “fluffy.” A fluffy seed bed will not allow water to move upward through capillaries in the soil. A weighted roller or “cultipacker” will do an adequate job. It is generally best to wait for a rain to settle the soil after initial preparation.

Producers who irrigate should prepare their land as they want it prior to planting. It should be uniform and set up in borders if flood irrigated. Flood irrigation is accomplished best when the soil

is not level, but uniformly sloping. Once established, it is difficult to “push” water through a stand of grass.

The land should be uniformly smooth to facilitate haying operations. Borders should be established under flood irrigation to match swathers and mower widths.

Preplant fertilizer should be incorporated as recommended by a soil test. In the absence of a soil test, incorporate about 100 to 200 pounds per acre of a product such as 18-46-0, 11-53-0 (dry fertilizer), or 10-34-0 (liquid), before planting, on soils that are generally medium to high in phosphorus. In soils low in phosphorus, incorporate 200 to 400 pounds of the same fertilizers. Soils in areas of Texas that are generally medium to high in potassium do not need additional fertilizer for planting. However, on soils that are low in potassium, apply 100 to 200 pounds per acre of 0-0-60. (Additional information on fertility follows in the management section.) During the establishment stage, grasses need only small amounts of nitrogen. However, once the grass is rooted and begins to grow, the demand for nitrogen increases rapidly in order for the plant to produce proteins for continued growth.

### Planting

Bermudagrass is commonly propagated by planting plant parts such as rhizomes or sprigs (underground storage roots), stolons (above-ground runners), or tops (mature stems). Only non-hybrids such as Giant and NK37 can be planted by seed. Sprigs or rhizomes are planted in late winter to early spring. Stolons and tops are planted in the late spring through early fall as moisture for “rooting” is critical. Stolons and tops are subject to desiccation or rapid drying in dry soils.

### Sprigging

The entire rhizome or “sprig” is planted in a furrow immediately behind an opening device, covered, and rolled in a single operation. The depth of planting is determined by the availability of moisture and the texture of the soil. Placed too deep, the new growth may die. Placed too shallow, the sprig may dry out without irrigation. Under dry-land conditions, 2 to 2 1/2 inches deep is generally adequate. Under irrigation, plant at a depth of 1 1/2 to 2 inches with occasional sprigs showing

above ground. The “ideal” sprig is 5 to 6 inches long, planted with one end 2 inches deep and the other end at the soil surface.

Tifton 85 is sensitive to deep planting. A portion of the sprig should be left above the soil.

If the soil is dry before planting, water should be applied **immediately** after planting to prevent desiccation. If planted in moist soil, irrigation may not be necessary or may be applied as needed.

Use fresh sprigs from a vigorous coastal field or a certified grower. Sprigs should be thick, tan to amber-colored, and crisp. After digging, it is important to keep sprigs moist and cool and to plant as soon as possible. Exposure of sprigs to the sun and wind after digging will increase desiccation and rapidly reduce their viability. If sprigs have been dug for more than 24 hours, they should be soaked in water for 12 to 15 hours before planting.

**Table 2. Relationship of Exposure Time to Percentage of Sprigs Alive at Planting.**

<b>Exposure time</b>	<b>% Sprigs alive at planting</b>
No exposure	100
2 Hours, 9 a.m. - 11 a.m.	94
4 Hours, 9 a.m. - 1 p.m.	72
2 Hours, 12 noon - 2 p.m.	30
4 Hours, 12 noon - 4 p.m.	3
8 Hours, 9 a.m. - 5 p.m. (shaded and moist)	100

Bermudagrass can be sprigged at many different rates. The faster a stand is desired, the more sprigs should be planted. The closer the spacing, the faster the sprigs will completely cover the area. The following table can help determine sprigging rates to use:

**Table 3. Sprigging Rates.**

<b>Bushels/Acre</b>	<b>Square feet for one sprig</b>
5	8.7
10	4.3
20	2.1
30	1.5
40	1.1
50	0.9

Controlling weeds is important because weeds compete for moisture, plant nutrients and light. Weeds can be controlled either by mowing or with herbicides. See B-5038, “Suggestions for Weed Control in Pastures and Forages” (Texas Cooperative Extension). Refer to the label for complete rate and timing instructions before using any pesticide.

Under dryland conditions, plant during the period when rainfall is most likely to occur, or shortly after a rain while the soil moisture is adequate.

Most failures in establishing hybrid bermudagrass are due to:

1. Poorly prepared seed bed.
2. Inadequate moisture at planting.
3. Using desiccated or dried sprigs.
4. Planting too few sprigs.
5. Planting sprigs too deep.
6. Not firming the soil around sprigs.
7. Severe weed competition.
8. Severe grazing before plants are established.

### ***Planting Tops Rather than Sprigs***

Planting tops is somewhat different from planting sprigs in establishing bermudagrass. Sprigs are underground roots that are dug and planted. Tops are above-ground, green, mature stems. Tops, unlike sprigs, must develop roots at the nodes to become plants. For a top (stem or runner) to root, it must be about 6 weeks old, 18 to 24 inches long, and have six or more nodes.

Planting tops allows producers to plant throughout the growing season as long as soil moisture is sufficient. Tops have been planted from late April through September. Fall-planted tops must have enough time to form roots and become well established before frost, or they will die during the winter. Tops planted in the late spring or early summer have the best chance to survive.

Planting tops has also allowed producers to establish a nursery and transplant runners to larger fields as they mature. This practice can decrease the cost of paying for complete sprigging and can be done by the producer.

The new Tifton 85 and Jiggs varieties are easier to root by tops than other hybrid grasses.

The following suggestions will increase the chances of success:

1. Plant 5 to 7 bales per acre.
2. Cut the tops with a sickle mower, bale **immediately**, and plant as soon as possible before the bale becomes hot enough to kill the grass. With small plantings, “pitching” the newly cut grass on a trailer and spreading is adequate.
3. Scatter and disk tops into moist soil before they wilt. Tops can die within minutes.
4. Pack the soil immediately (using a roller) around new runners to prevent excessive moisture loss and ensure good soil contact.

### **Renovation of Hybrid Bermudagrass**

Renovation is a practice or series of management practices for improving or restoring the vigor of a field. Pasture renovation implies almost making the field new again. It may involve testing the soil and fertilizing according to the nutrients needed, or destroying the sod and replanting, or anything in between. The level of renovation required depends on the reason for decreased grass vigor and the management goals and pasture usage of the producer. Table 4 summarizes renovation practices.

Although there are many reasons for pasture decline, the following symptoms would indicate that some kind of renovation should be considered:

- Reduced forage production.
- Thin stands with bare ground showing and a decrease in the number and vigor of rhizomes.
- Invasion of broadleaf weeds and undesirable grasses.
- Rough soil surfaces.
- Poor drainage.
- Poor water infiltration or penetration; soil compaction.
- Accumulation of nutrients such as phosphorus in the top 1 inch of soil.

**Table 4. Renovation Practices and Requirements.**

<b>Minimum Renovation</b>	<b>Extensive Renovation</b>
Soil testing	Subsoiling or chiseling
Fertilization	Disking or plowing
Weed control	Replanting
Prescribed burning	Heavy fertilization

**Soil testing and fertilizing** should be the first practice in any renovation. High forage production will remove many soil nutrients, not just nitrogen alone. Hay production removes all the nutrients when the forage is harvested. For each 6 tons of hay removed, the soil must provide approximately 300 pounds of nitrogen, 60 pounds of phosphorus, and 240 pounds of potassium, plus sulfur, calcium, magnesium, and all the other nutrients needed for plant growth. Continued hay removal will “mine” the soil until it is unproductive.

Nitrogen, sulfur, calcium and phosphorus are the primary nutrients removed by grazing, but animal manure returns only a part of the minerals to the soil. With both commercial fertilizer and manure applications, non-mobile nutrients (such as phosphorus) tend to accumulate in the top 6 inches of soil. Since nutrients need to be dissolved in water for best uptake, during droughty periods root uptake is minimal from the soil surface.

**Weed control** will be part of any renovation program. Weeds compete with bermudagrass for water, nutrients and sunlight. Weeds present during bermudagrass establishment prevent good stands and often result in plantings that take years to cover or never cover completely. Thin, weak bermudagrass stands resulting from low fertility, drought or heavy harvesting pressure cannot compete with weeds. Field experiments in Victoria County have shown that from 3 to 7 pounds of Coastal bermudagrass will be produced for every 1 pound of weeds controlled. (See B-5038, “Suggestions for Weed Control in Pastures and Forages,” Texas Cooperative Extension.)

**Prescribed burning** during the dormant period before spring growth will remove excess dead forage; warm the soil; destroy some insects, winter weeds and weedy grasses; and promote faster greenup. Disadvantages include fire hazards, the need for a burning permit, baring the soil for possible erosion, and removing protection from late freezes. Timing is critical; burning must be done

after weeds have emerged but before bermudagrass greenup. Waiting too long delays bermudagrass regrowth and allows emerging weeds to outgrow the grass. A suggested time for burning is about 1 week before the last average frost date. In Falls County, burning increased grass production by 143 percent while decreasing weed competition by 96 percent. The grass had a 4 percent increase in protein and 2 percent increase in mineral content (Ca, P, K, Mg) over non-burned areas.

**Subsoiling chiseling, disking and plowing** are operations that will partially destroy the sod, but are used to manage bermudagrass pastures needing complete renovation. Subsoiling and chiseling will eliminate compaction layers, loosen the soil, increase air movement and water penetration, and decrease water runoff for increased root development. Intensive disking or plowing will incorporate organic matter, fertilizer and lime (if needed in low pH soils); destroy grassy weeds; and replant bermudagrass. Often cultivation of hay pastures is desirable to smooth the soil surface, making haying easier. Any soil renovation work should be done in the early spring just before greenup and spring rains or irrigations. During droughty periods, major soil renovations should be delayed until there is adequate soil moisture to prevent killing bermudagrass rhizomes.

**Replanting** should be considered when there is an inadequate number of live rhizomes to rejuvenate the stand.

### **Management of Hybrid Bermudagrass**

Of the factors that limit forage production, water is the most important. Without water, plants will not grow, no matter how much fertility is available. Fertility, particularly nitrogen, is the second-most-important limiting factor to production. From a practical viewpoint, water and fertility and their interaction cannot be separated.

In comparison to other plants, hybrid bermudagrass is very water-efficient. Figure 1 shows the amount of water needed to produce a pound of dry matter.

The water efficiency of hybrid bermudagrass can be improved even more by adding plant fertilizer. Since plants use nitrogen to build amino acids and proteins, the number of new cells that a plant can produce is directly related to the amount of nitrogen it is able to absorb. Up to a point, the

more nitrogen and water available, the more the plant will grow. The following research was conducted in Crystal City, Texas.

**Figure 1. Effects of Nitrogen Rates on Percent Protein, Yield, and Inches of Water/Ton.**

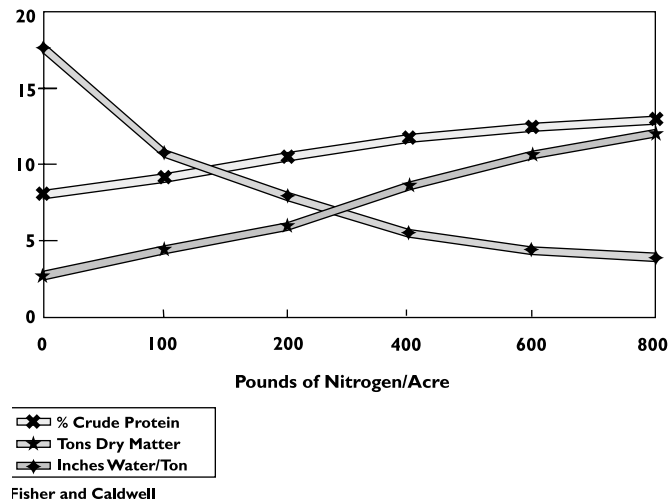

This graph shows three very important points that have been repeated in research throughout the South. Although the results will vary depending upon many factors, the general outcome will be similar. **As the rate of nitrogen increases, the percent crude protein and yield increase dramatically, while the amount of water used to produce a ton of forage goes down.** With low nitrogen rates, a high of 17.6 inches of water is needed to produce a ton of dry matter. With adequate nitrogen, only 3.9 inches of water is needed to produce a ton of dry matter. Adequate nitrogen fertility is necessary to fully utilize the amount of water received by a crop. Water without fertility will not produce new plant tissue.

Warm-season perennial grasses use nitrogen, phosphorus and potassium at a ratio of approximately 4-1-3. To produce 1 ton of dry forage, bermudagrass must absorb approximately 50 pounds of nitrogen per acre, 15 pounds of phosphorus and 42 pounds of potassium. If these numbers are multiplied by the number of tons of forage desired, the product will equal approximately the pounds of nutrients needed. For example, for 4 tons of production, it will take about 30 inches of water during the growing season, 200 pounds of nitrogen, 60 pounds of phosphorus, and 168 pounds of potassium.

Splitting the applications of fertilizer throughout the growing season improves efficiency, which means that a greater percentage of the nutrients, particularly nitrogen, is used by the plants.

It is important to test soil every 2 to 3 years to determine if the natural mineral content of the soil is changing. Many soils can provide some nutrients almost indefinitely. Fertilizer rates should be adjusted to maintain soil nutrients without excessive buildup.

In summary, the advantages for fertilization include:

- Increased forage production.
- Improved forage quality, especially protein.
- Improved root system and sod density.
- Reduced weed competition.
- Reduced soil erosion.
- Improved water-to-yield ratio.

## Stage of Harvest

Whether the grass is grazed by livestock or harvested mechanically, the stage or level of maturity of the plant tissue will also determine its quality. Without proper harvest timing, high-quality forage will rapidly turn into “cardboard.” Research conducted in Georgia on Coastal bermudagrass produced the results shown in Table 5.

Although the yield was higher for an individual cutting at 6 weeks, the amount of protein produced per acre was almost the same as the amount of protein produced after 3 weeks. In these tests, cutting twice at 3-week intervals would produce twice as much protein and almost twice as much forage per acre as cutting at 6-week intervals.

## Summary

Hybrid bermudagrass can produce high-quality forage. As with any other crop, proper variety selection, adequate soil preparation for planting, correct planting, adequate fertility, wise irrigation management, and proper timing of harvest are required for best results.

**Table 5. Effects of Cutting Intervals on Quality of Yield.**

Cutting interval (Weeks)	Yield (Tons per acre)	Percent protein	Lb. dry matter per acre	Percent leaf	Percent stem	Percent fiber	IV DVD
3	7.9	18.5	2442	83	17	27	65.2
4	8.4	16.4	2317	79	21	29.1	61.9
5	9.2	15.4	2329	70	30	30.6	59.3
6	10.3	13.3	2292	62	38	31.6	58
8	10.2	10.7	1898	56	44	32.9	54.1
12	10.4	9	1612	51	49	33.4	51

The information given herein is for educational purposes only. Reference to commercial products or trade names is made with the understanding that no discrimination is intended and no endorsement by Texas Cooperative Extension is implied.

Produced by Agricultural Communications, The Texas A&M University System  
 Extension publications can be found on the Web at: <http://tcebookstore.org>

*Educational programs of Texas Cooperative Extension are open to all people without regard to race, color, sex, disability, religion, age or national origin.*

Issued in furtherance of Cooperative Extension Work in Agriculture and Home Economics, Acts of Congress of May 8, 1914, as amended, and June 30, 1914, in cooperation with the United States Department of Agriculture. Chester P. Fehlis, Director, Texas Cooperative Extension, The Texas A&M University System.



# Managing Annual Winter Grass in South and Southwest Texas (L-5238)



# Managing Annual Winter Grasses in South and Southwest Texas

Charles Stichler and Steve Livingston\*

# W

inter annual pastures in South and Southwest Texas provide high-quality forage for cattle, sheep and goats when native and bermuda grass pastures are dormant. They offer high nutritional value from the time they start growing until heading in spring.

Because establishing winter pastures is costly, they are best suited for a stocker cattle system or high-profit animals. Small grains provide more nutrition than dry pregnant cows need. For maximum economic return, use winter forages for livestock with high profit potential.

Properly managed winter annuals are next to legumes in producing consistent high protein and highly digestible forage. Without proper management, they do not reach their full potential. Such decisions as irrigation management (if available), planting date, cultivar selection, fertilizer applications and grazing management greatly affect production.

Without healthy plants producing at maximum potential, forage (and grain) production is reduced and animal gains may be disappointing.

## Planting considerations

### Temperature

Although small grains are cool-season plants, they do require temperatures warm enough for the plants to maintain growth. When average temperatures drop below 50 degrees, plant processes and growth begin to slow. If early grazing is needed, begin planting in early October to make use of fall rains, to graze by mid-November under good growing conditions. Ear-

\* Associate Professor and Extension Agronomist, and Professor and Extension Agronomist; The Texas A&M University System.

Figure 1. Growth of winter forage at various temperatures.

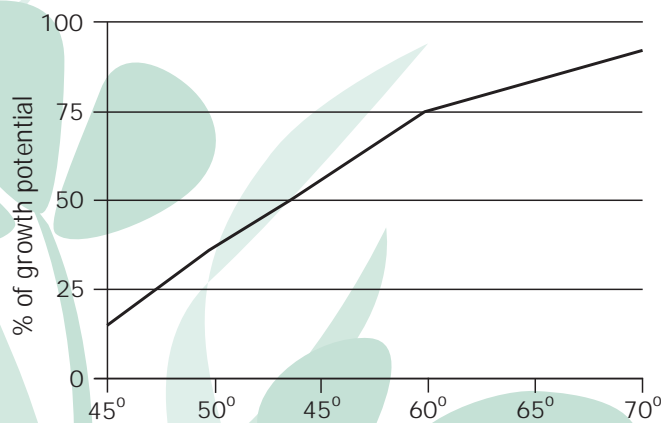

lier planted oats or wheat may try to head out before the onset of winter if not grazed. Armyworms can be a problem in early-planted small grains.

### Cultivar selection

Annual winter grasses include oats, barley, rye, wheat, triticale and annual ryegrass. Rye (Elbon rye) and oats generally provide the earliest grazing, but they also mature first, followed by wheat, barley and ryegrass. Because ryegrass matures late, it provides 4 to 6 weeks of extra grazing in the spring.

Wheat and oats have for many years been the small grains traditionally planted in southwest Texas. They offer the advantage of a grain crop har-



**Table 1. Characteristics of winter annual forages.**

Forage	Advantages	Disadvantages
Oats	Early fall grazing High forage quality - gains Germinates under limited moisture	Poor cold tolerance Poor disease tolerance in many cultivars
Ryegrass	Most popular cool-season grass Can be seeded by surface broadcast Few bloat problems Late maturing - long spring grazing	Limited fall grazing Poor winter grazing in cold weather Contamination of fields for other small grains
Wheat	Good cold tolerance Can be grazed or grained Drought tolerant "Beardless" cultivars available	Least productive cool-season grass Low disease tolerance Bloat and grass tetany problems
Rye	Most drought tolerant Most cold tolerant Rapid fall growth	Early maturity - early termination Unpalatable at boot stage Can become infested with ergot (poisonous)
Barley	Saline tolerant Good drought tolerance	Lower forage quality Awns (beards) on seed can cause sore mouth problems

vest in addition to livestock grazing. However, such plant diseases as Barley Yellow Dwarf Virus and new races of leaf rust in wheat and oats can reduce production considerably. Also, oats may freeze if a warm period is followed by very low temperatures and grazing is greatly reduced, leaving the producer looking for feed.

Where rainfall or irrigation is available, mixing ryegrass with oats or wheat offers considerable advantages over either one planted alone. Reduce oats or wheat by 50 percent and plant 10 to 15 pounds of ryegrass per acre.

Many annual ryegrass cultivars are available for purchase and are suitable for southwest Texas. Although many ryegrass cultivars perform similarly, gulf ryegrass is best adapted to wet, humid conditions. TAM 90 (developed by Texas A&M University), is more disease tolerant in humid regions.

Ryegrass seed is small and planted shallower than larger seeded small grains. In areas under irrigation or receiving frequent rains, ryegrass seed can be sown broadcast on top of the soil with good success. Ryegrass also requires more frequent rains or irrigation to establish a stand. It is not as susceptible to diseases, and bloating problems are almost eliminated. Ongoing research has shown that ryegrass produces as much forage as other small grains and

**Table 2. Comparable characteristics of winter pasture crops under irrigation or adequate rainfall.**

	Oats	Wheat	Ryegrass	Rye	Triticale
Fall <sup>1</sup>	Excellent	Fair	Good+	Good+	Good
Winter <sup>1</sup>	Fair	Good	Good	Good	Good
Spring <sup>1</sup>	Good	Good	Excellent	Fair	Good+
Late spring <sup>1</sup>	Poor	Poor	Good	Poor	Fair
Winter hardiness	Poor	Fair	Good	Excellent	Good
Disease tolerance	Poor	Fair	Excellent	Good	Fair
Grazing quality	Excellent	Excellent	Excellent	Excellent	Excellent
Hay quality	Good	Good	Excellent	Good	Good
Planting rate (lbs/acre)	75 - 100	75 - 100	15 - 25	75 - 100	75 - 100

<sup>1</sup> Production Times: Fall, October-December; Winter, January-February; Spring, March-April; Late spring, May-June.

higher quality forage. It is becoming a preferred forage for winter grazing where it is adapted.

A disadvantage of ryegrass is lack of fall grazing. Most of the forage is produced in spring, after February until early May if water is available. However, when seeding rates are increased to 25 to 30 pounds of seed per acre, early forage production increases greatly over the standard planting rate of 15 pounds per acre. Another alternative is a mixture with wheat or oats as suggested above.

Producers should not plant ryegrass in a field if they plan to use the field for small-grains production later. **Ryegrass is a very good seed producer and will become a weed in small-grain fields when grain production is desired.**

Figure 2. Forage production rates of ryegrass and small grains.

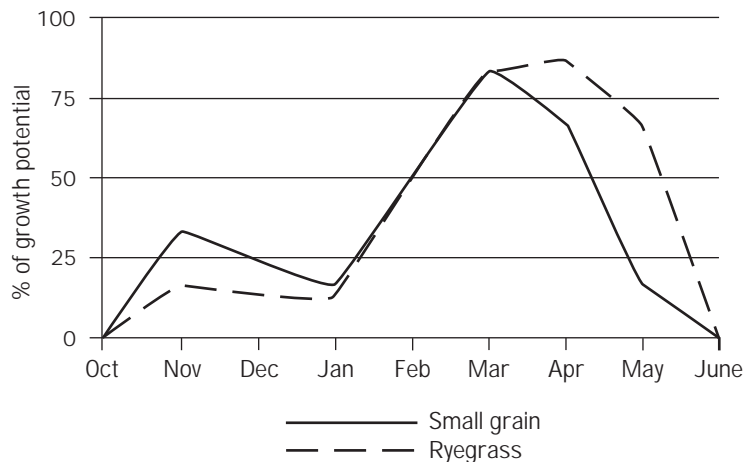

## Fertility

Testing a soil sample is the best way to determine which nutrients are adequate, which are lacking and at what amounts. With a soil analysis, a fertility program can be structured to add the insufficient nutrients. Without the analysis, nutrients may be wasted and add to ground or surface water pollution, or be insufficient for maximum production.

## Nitrogen and water

Just as in animals, nitrogen is the critical element of amino acids and proteins in plants. Without enough nitrogen, plants cannot produce new growth. Although the other elements are important, nitrogen is the only one that actually causes the plant to grow.

A good rule to remember is that it takes 0.36 pounds of nitrogen to produce 10 pounds of forage to produce 1 pound of gain in livestock. Fifteen inches of water will produce about 4,500 pounds of dry matter, which will use 165 pounds of nitrogen and will yield 450 pounds of gain in livestock.

Grasses generally use nitrogen (N), phosphorus (P) and potassium (K) in a 4-1-3 ratio. Although many soils in southwest Texas are medium to high in phosphorus, producers may need to add more to fields under intensive management. Potassium (K) is generally very high in most South Texas soils, and additional amounts are seldom needed. However, do not guess, soil test.

This fertility program is suggested for maximum production in fields to be irrigated and grazed heavily:

- Use 80-40-0 at planting;
- Add 60 pounds of nitrogen in late December or early January; and
- Apply 80 more pounds of nitrogen in early March just before early spring growth for maximum forage or grain yields.

For dry land production, apply about 75 to 100 pounds of nitrogen and 20 to 30 pounds of phosphorus. Additional rain raises the potential for more forage and the need for more fertility if grazed intensively.

## Phosphorus

Good seed-bed preparation includes providing enough nutrients for early growth. Phosphorus is essential for early root development, particularly in cold soils during fall and winter. Phosphorus is less available to plants in cold soils. If phosphorus is limited, tillering can also be reduced.

Recent research by Hagen Lippke at the Uvalde Research and Extension Center shows the importance of adequate phosphorus for maximum winter forage production. In the Uvalde area under irrigation, ryegrass production is most profitable with about a 250-40-0 total fertility rate.

Equally important is where the phosphorus is placed in the soil. For optimum return of phosphorus, place it 5 to 8 inches deep. Travis Miller, an Extension specialist in small grains, conducted phosphorus tests across Texas with varying rates and placements. He found that forage yields, especially early growth, were increased from 50 to 400 percent just by proper placement of the phosphorus.

The forage and grain yields responded better in dry years when fertilizer with P was banded 5 to 8 inches deep than in fields fertilized with P in the upper 2 to 3 inches or broadcast on the soil surface. In dry years, root development in the dry, top part of the soil is limited and roots do not absorb shallow-incorporated P. Grain yields increased an average of 15 percent.

Phosphorus moves very little in soils under the best of conditions. In dry soils, P does not move at all. If P is spread on the soil surface or even shallow incorporated 2 to 3 inches deep, the plant absorbs very little of it because very few active roots are in that region.

Placing phosphorus deep puts it in a region of active root absorption — increasing uptake. In addition, banding phosphorus reduces the soil-to-fertilizer contact, so that less P is tied up by calcium and more is available for a longer time.

## Grazing management

Consider the plant first when deciding on a grazing management plan. Plant leaves capture sunlight and convert it into energy. Without leaves, the plant cannot create energy. If the leaf area is reduced radically, plants start robbing the root system to replace the foliage. Moisture, fertility and the size of the plant above ground determine the size and depth of a plant's root system.

The root system starts to die if plants are not allowed to maintain sufficient foliage to develop or regrow after grazing. Without adequate foliage, growth spirals downhill, with shallow roots unable to absorb nutrients and water, and too little foliage to carry on photosynthesis to generate energy for additional growth.

Before turning livestock on the field, forage should be:

- At least 6 to 8 inches tall;

- 4 to 6 weeks after emergence; and
- Well tillered and well rooted.

To maintain enough leaf area for continued growth, do not allow animals to graze forage to below 3 to 4 inches. Rotational grazing is preferred, although it requires more management than continuous grazing. Managers must decide:

- How many animal units a rotation can maintain;
- When to move to another pasture;
- When and how much additional nitrogen to apply;
- When and how much additional water to apply;
- Whether to allow peak-hour grazing (i.e., 2 hours in the morning and 2 hours in the afternoon) only;
- Whether to drylot animals during wet periods to reduce plant injury; and
- How long to rest pastures before grazing.

Different growing conditions give each pasture different growth rates, forage accumulation and carrying capacity. It is important to balance the stocking rate with the amount of forage available. Formulas and techniques are available to estimate forage.

## Grazing and grain

If the market price for wheat or oat grain is high, a producer may decide to harvest the field for grain. Removing livestock at the proper time — before jointing — is critical to prevent grain yield losses.

Before jointing, the growing point of wheat is below the soil surface. When the stems begin jointing, the head or growth point rises above the ground. Grazing can reduce yields if the animals remove the growing point (head). Primary tillers usually have the largest heads; yields are reduced the most when they are removed.

No matter how favorable environmental conditions are or how much forage is available, excessive grazing reduces grain yield, especially if developing seed heads are grazed. It is also essential to leave a reasonable amount of green leaf area on the plant to produce energy to fill the individual grains.

## Summary

Winter annual pastures can provide an abundance of high-quality forage. Producers can earn the most profits when they use best-management practices that optimize water, fertility, variety and grazing management.

Produced by Agricultural Communications, The Texas A&M University System

Educational programs of the Texas Agricultural Extension Service are open to all people without regard to race, color, sex, disability, religion, age or national origin.

Issued in furtherance of Cooperative Extension Work in Agriculture and Home Economics, Acts of Congress of May 8, 1914, as amended, and June 30, 1914, in cooperation with the United States Department of Agriculture. Chester P. Fehlis, Deputy Director, Texas Agricultural Extension Service, The Texas A&M University System.  
5,000 copies, New



# *Irrigation Management for Wheat Production*

## **In this Section**

Reference: Late Season Wheat Irrigation for the Texas South Plains

Reference: Growth Stages of Wheat: Identification and Understanding  
Improve Crop Management (SCS-1999-16)



# Late Season Wheat Irrigation for the Texas South Plains

## Late-Season Wheat Irrigation for the Texas South Plains

Calvin Trostle, Extension Agronomy, Lubbock, 806.746.6101, [ctrostle@ag.tamu.edu](mailto:ctrostle@ag.tamu.edu)  
Original edition April 2001; updated April 2007

Wheat is at a wide range of development across the South Plains (23 April 2007). Most wheat south of Lubbock has headed in the past two weeks, and early heading is in progress to the north. There is also a lot of acreage that is still in early to mid boot due to late planting. What irrigation guidelines might we use on the irrigated wheat crop?

Due the ample rain and snow over the winter unirrigated wheat looks pretty good although due to the heavy vegetative growth and higher evaporative demand, this wheat may dry out quickly without further rain. If wheat can be irrigated how much should growers consider? Of course, if we knew it was going to be hot and dry with no rainfall, then only larger amounts of water would see the crop through to a decent harvest, but that wouldn't necessarily make any money.

**Wheat and Water Evapotranspiration:** The Texas High Plains Evapotranspiration Network, <http://txhighplainset.tamu.edu/statemap.jsp>, provides climatic and water use information for several crops including wheat. Click on a town on this website to access a nearby weather station's menu for daily climate and soil temperature data and especially the 'Daily Fax,' which provides a summary of predicted evaporative moisture demand for wheat and other crops. Recent data suggest, that most wheat fields in the Texas High Plains have water use of 0.25" or more per day.

Here are some grower guidelines for decisions on further irrigation:

1) How much nitrogen did you put down? (Aside: even if wheat is pre-boot, it's essentially too late for N, as the latest time for N we would recommend would be not after than when the first node is visible; fields with minimal N application could receive small amounts of N through boot, but it won't affect seed number). As a general rule of thumb, for wheat going to grain, Extension suggests 1.2 to 1.5 lbs. N/A (use the lower amount if the soil wasn't tested). So if 60 lbs. of N was applied, it should have the N fertility to go in the 50 bu./A range. If a farmer did not apply N (unless he has good residual soil fertility), then irrigating a lot would not make sense because the yield potential might not be there.

2) What does it cost you to pump 1" of irrigation water per acre? Many producers aren't sure... The rule of thumb for wheat is about 3-4 bu./A for each inch water though individual applications, especially boot stage, can give better response. I generally use 3.5 bu./A/inch for calculations (it might be higher as you move north into the Panhandle). Timing, however, can greatly influence the response to irrigation. Travis Miller, former statewide small grains specialist, has seen timely irrigation at boot stage result in yield increases up to 10 bu/A.

3.5 bu/A X \$4.70/bu = \$16.45 (23 April 2007). Irrigation costs per acre inch are highly variable based on fuel and pumping efficiency (have those pumps tested!), about \$8-12 per acre-inch.

Hopefully a grower will know this accurately for his pumps, fuel, and pricing structure.

3) What is my current yield potential? This is harder to estimate until you see how big the head will be after flowering. You may consult guidelines in "Estimating Wheat Yield Potential," available through local Extension offices or read/download at <http://lubbock.tamu.edu/othercrops/pdf/wheat/estwheatyield.pdf>

**Bottom line--What to advise?** Wheat has looked good but much of our crop is drying fast due to daily water use that exceeds 0.25" per day in late April. Make sure the flag leaf is healthy, as it provides up to 75% of the leaf area that provides photosynthate contributing to yield potential. This is according to "Growth Stages of Wheat: Identification and Understanding Improve Crop Management," available at <http://lubbock.tamu.edu/othercrops/pdf/wheat/wheatgrowthstages.pdf>

For modest irrigation of wheat in late-season I suggest that growers consider the following:

Wheat still in the pre-boot to late-boot stage:

1A) Water in two applications ~1.5" (\*see note at bottom) in mid- to late-boot stage. {The end of boot stage is when heads just start to emerge.} This is an optimum time to irrigate wheat where yield response is expected to be higher. You are just in front of flowering, and good moisture prior to flowering (wheat is mostly self-pollinated, thus by the time you see the anthers, it has actually already fertilized) will increase yield potential in the number of seeds per spikelet. Actual pollination should occur about 5-7 days after heading, and visual bloom (extruded anthers) should occur in a couple more days. Most tillers should bloom shortly after the main head even though they developed later.

1B) Irrigate again another ~1.5" about 14 days later in split applications (unless you receive a good rain). This will provide moisture to carry into grain fill and should enhance seed size, the final component of grain yield.

These are timely but limited irrigations where we believe crop response would be higher.

Wheat that is already headed:

2A) What stage is the crop in terms of heading? Pre-bloom or post-bloom? If the crop is past flowering then the window for beneficial additional watering is not that long as grain fill can occur as quickly as 30 days in a high stress environment. Benefit from irrigation is questionable when kernels are past watery ripe, especially if there is still some decent soil moisture. When kernels are milky ripe, then chances that economic yield responses may be achieved due to irrigation are greatly reduced (even if soil is about dried out). Once kernels are mealy ripe then the crop is starting to dry down, and irrigation would have little effect.

2B) Get your best estimate of the wheat yield potential (see resource above). If the yield potential is less than 25 bu./A at current wheat prices then I might suggest you consider not irrigating. The potential return may be minimal especially at current irrigation prices.

2C) If you decide that the crop has decent yield potential--a) pre-bloom heading, irrigate immediately with ~1.5"/A, then evaluate again whether one additional irrigation might be applied in another 10-14 days up to the watery ripe kernel stage; b) post-bloom, but prior to or at

watery ripe kernels, consider ~1.5" A irrigation. Yield response afterwards is not assured.

**What if the crop is already drying down and showing moisture stress?** This is a harder call. The water it would take to pull the crop back may not be justified if the crop is already stressed, especially for limited yield potential. You could irrigate ~1.5" but the crop will likely dry again in another 10 days. If growers have an otherwise good looking crop that is suffering moisture stress only, they might have a better indication of the yield potential of the field. If it appears to be low, then irrigation is less justified; otherwise refer to the suggestions in either 1A-1B or 2A-2C above.

**Summary–Limited but timely irrigation:** The discussion here targets limited but timely irrigation provided crop potential still exists. Although I noted above 3.5 bu/A for 1" of water in the calculation, I think that much of the wheat crop could surpass the response 3.5 bu/A in this timely but limited irrigation scenario.

\*The use of ~1.5" of irrigation as a target in the above examples is arbitrary, but I believe it is a realistic goal that could be achieved by many growers in a two-irrigation scenario.





Growth Stages of Wheat:  
Identification and Understanding Improve  
Crop Management (SCS-1999-16)

# Growth Stages of Wheat: Identification and Understanding Improve Crop Management

By Travis D. Miller

Texas Agricultural Extension Service  
The Texas A&M University System



*Understanding growth stages of wheat is important in matching management decisions and inputs with plant development. This article outlines characteristics and management decisions that may be associated with indicated stages of plant growth*

There are at least five scales commonly used worldwide to describe stages of growth of wheat and other small grains. The scale used is not important, as long as the grower has a thorough understanding of the growth habit of wheat and how management inputs at specific growth stages can affect forage and grain yield.

Probably the most widely used scale in the U.S. is the Feekes scale, although the Zadoks and Haun scales are more detailed and descriptive. Careful study of the developing crop and an intimate knowledge of factors which may have positive or negative effects on forage and grain yield potential can enhance management decisions. These decisions can make wheat production more profitable.

This article discusses management of the wheat crop in terms of the Feekes growth scale and provides visuals of those growth stages.



**Seedling Emergence - Feekes 1.0**

## Feekes 1.0 — Emergence, on shoot formed

If desired, number of leaves present on the first shoot can be designated with a decimal. For example, 1.3 is a single shoot with three leaves unfolded. Without a doubt, the most significant event in achieving high yield of grain and/or forage in wheat is stand establishment. Planting high quality seed of an adapted wheat variety in a fertile, well prepared seedbed with enough moisture to achieve a rapid, uniform stand is a significant step in achieving acceptable yields.

Late planted wheat has less time to tiller and should be planted at a higher rate to compensate for fewer tillers. If early forage production is a goal, producers should increase seeding rates and depend less on tiller formation to produce early forage growth.



**Beginning of tillering - Feekes 2.0**

## Feekes 2.0 — Beginning of tillering

A tiller is a shoot which originates in the axil of a leaf or at the coleoptilar node.

Tillers share the same root mass with the original shoot or main stem. Once established, secondary tillers may arise from the axils of the primary tillers; tertiary tillers may develop from the axils of secondary tillers, etc.

During tillering, the major management consideration is whether stands are adequate to achieve yield goals. Management inputs will not compensate for skippy or erratic stands caused by insects, poor seed quality, herbicide injury, etc. If stands are thin, but uniform, an early nitrogen (N) application may enhance the rate of tillering, potentially increasing the number of heads per square foot. Care must be taken with fall N application. If heat units are available, excess N applied at this time leads to a lush, vegetative growth which makes the crop more susceptible to winterkill, foliar fungal disease, and aphid injury. Adequate phosphorus (P) is strongly related to rooting and tiller development. If tiller development is a historic problem in a given field, close attention must be given to P soil test recommendations prior to planting.

## Feekes 3.0 — Tillers formed

Winter wheat can continue to tiller for several weeks. Depending upon plant-



**Tillers formed - Feekes 3.0**

ing date and weather conditions, tillering can either be interrupted by or completed prior to the onset of winter dormancy. Most of the tillers that contribute to grain yield potential are completed during this stage. Leaves begin to twist spirally. Many winter wheats are prostrate or “creeping” at stage 3.

Major yield potential loss can occur from weed infestation during tiller formation, as weeds compete for light, water and nutrients. Once the wheat has achieved full canopy, little problem is experienced from weeds. Weed control decisions should be made before or during Feekes 3.0. The herbicide metribuzin may be applied for postemergence grass and broadleaf weed control during this growth stage on tolerance wheat varieties. In most cases, plants should have at least 4 tillers and be actively growing before application of this herbicide. The herbicide 2,4-D and similar phenoxy herbicides should not be applied until wheat is fully tillered, or after Feekes, 3.0

Growers should carefully scout for aphid and other insect infestations during Feekes 2.0 and 3.0, as stress from insect injury can reduce tiller formation. Control thresholds are much lower on small plants than later when plants are larger.



**Beginning of erect growth - Feekes 4.0**

#### **Feekes 4.0 — Beginning of erect growth, leaf sheaths lengthen**

Most tillers have been formed by this stage, and the secondary root system is developing. Winter wheats which may have a prostrate growth habit during the development of vegetative parts begin to grow erect. Leaf sheaths thicken. The key management step at Feekes 4.0 is continued scouting for insect and weed infestations. Some growers initiate grazing during Feekes 4.0

#### **Feekes 5.0 — Leaf sheaths strongly erect**

At this stage, the wheat plant becomes strongly erect. All meaningful tiller development has ceased. Many varieties of winter wheat which are creeping or low-growing during tillering, grow vertically at this stage. The vertical growth habit is caused by a pseudo or false stem formed from sheaths of leaves. In early planted wheat in southern areas of the U.S., this stage can occur prior to the onset of winter dormancy.



**Leaf sheaths strongly erect - Feekes 5.0**

Further development of the winter wheat plant requires vernalization, or a period of cool weather. After the appropriate amount of chilling, followed by the resumption of growth, the growing point (which is located below the soil level at the crown) differentiates. This means that all leaves have been formed and the growing point, which generates

new cells for the plant, will begin to develop an embryo head. At this stage of growth, the size of heads, or number of spikelets per spike, is determined. No effect on yield is expected from tillers developed after Feekes 5.0. Nitrogen applied at Feekes 5.0 can affect number of seed per head and seed size, but will not likely affect number of heads harvested. This is an ideal stage of growth for the spring topdress N application as later applications will not affect the potential number of seed per head.

Irrigation management can be critical during spikelet differentiation process. Extreme stress during this differentiation process can reduce potential number of seeds per head, which is an important component of yield. Wheat stressed during the head differentiation process of Feekes 5.0 will have blank portions of the head, frequently on the ends.

Take great care with grazing operations, particularly on short wheats, during this growth stage. Final plant size, leaf area, and yield are closely related to the severity of grazing. This is true of wheat harvested for grain and wheat intended for grazeout. Tall wheats are more tolerant of severe grazing at this stage of growth. Rotate cattle with a goal of leaving a minimum 3 to 4 inches of green leaf area going into Feekes 6.0

#### **Feekes 6.0 — First node visible**

This stage of growth is easy to identify. Feekes 6.0 will not occur prior to the onset of cold weather, as vernalization is required in winter wheat prior to spikelet differentiation. Prior to Feekes 6.0, the nodes are all formed, but are sandwiched together so that they are not readily distinguishable to the naked eye. At 6.0 the first node is swollen and appears above the soil surface. Above this node is the head, or spike, which is being pushed upwards to eventually be exerted from the boot. The true stem is now forming. The spike at this stage is fully differentiated, containing all potential spikelet and florets or seed forming branches.

Growers should look carefully for the first node to emerge. It can usually be seen and felt. A sharp knife or razor blade is useful to split stems to determine the location of the developing head. The stem is hollow in most wheat varieties behind this node. By Feekes 6.0, essentially all weed control applications have been made. Do not apply phenoxy herbicides such as 2,4-D, Banvel, or MCPA after Feekes 6.0, as these materials can be translocated into the developing spike, causing sterility or distortion. Sulfonyleurea herbicides are safe at this growth stage, but for practical reasons, weed control should have been completed by now.



**First node visible - Feekes 6.0**

All grazing should cease by Feekes 6.0. Mechanical injury by livestock to the spikes at this time means direct loss of grain yield. But a more significant effect on potential yield comes from loss of leaf area to grazing at this stage.

Small grains can still show good response to N topdressed at this time, although yield responses will be better at Feekes 5.0 as head size can no longer be affected by fertilizer application. Mechanical injury to wheat can occur from fertilizer applicators at this stage of growth, but response to applied N will usually more than compensate for the damage if soil N is deficient.



**Second node visible - Feekes 7.0**

#### **Feekes 7.0 — Second node visible next to last leaf visible**

This stage is characterized by the rapid expansion of the spike and the appearance of a second node above the soil surface.

#### **Feekes 8.0 — Flag leaf visible**

This growth stage begins when the last leaf (flag leaf) begins to emerge from the whorl. This stage is particularly significant because the flag leaf makes up approximately 75 percent of the effective leaf area that contributes to grain fill. When the flag leaf emerges, at least 3 nodes are visible above the soil sur-



**Flag leaf visible - Feekes 8.0**

face; occasionally a fourth node can be found. To confirm that the leaf emerging is the flag leaf, split the leaf sheath above the highest node. If the head and no additional leaves are found inside, stage 8.0 is confirmed.

At Feekes 8.0, the grower should decide whether to use foliar fungicides or not. This decision should be based upon the following considerations:

1. Is a fungal disease present in the crop?
2. Does the crop have resistance to the fungal disease, or is the disease spreading rapidly?
3. Does the crop yield potential warrant the cost of application of the fungicide in question to protect it?
4. Is the crop under stress?

If a positive answer applies to the first three questions, and a negative response to the last, plans would be made to protect the crop, especially the emerging flag leaf, from further damage. Check product labels and apply as soon as possible. In most situations, the greatest return to applied foliar fungicides comes from application at Feekes stage 8.0 to 9.0. There is a considerable debate about preemptive applications of fungicides to prevent further infestations of fungal diseases. In certain high disease and high yield environments, this may be justified.

Nitrogen applications at Feekes 8.0 and later can enhance grain protein levels, but are questionable with respect to added yield.

Irrigation scheduling becomes most critical between Feekes 8.0 and mid-grain (Feekes 11.1). The crop should not be stressed from about 10 days prior to bloom through the late milk stage. Feekes 8.0 marks a point in the development of the wheat plant beyond which every effort should be made to apply water to prevent loss in grain yield potential.

**Feekes 9.0 — Ligule of flag leaf visible**

Stage 9.0 begins when the flag leaf is fully emerged from the whorl. From this point on, leaves are referred to in relation to the flag leaf, i.e.; the first leaf below the flag leaf is F-1, the second leaf is F-2, etc. The wheat plant typically produces 7 to 9 true leaves, not inclusive of leaves not he tillers. After flag leaf emergence, army worms can seriously damage yield potential.



**Ligule of flag leaf visible - Feekes 9.0**

**Feekes 10.0 — Boot stage**

The head is fully developed and can be easily seen in the swollen section of the leaf sheath below the flag leaf. The Feekes growth scale at stage 10 is divided as follows:

- Feekes 10.0 boot stage
- 10.1 awns visible, heads emerging through slit of flag leaf sheath
- 10.2 heading 1/4 complete
- 10.3 heading 1/2 complete
- 10.4 heading 3/4 complete
- 10.5 heading complete
- 10.5.1 beginning flowering
- 10.5.2 flowering complete to top of spike
- 10.5.3 flowering complete to base of spike
- 10.5.4 kernels watery ripe

Wheat is largely self pollinating. Most florets are pollinated before anthers are extruded. Although tillers have developed over a several week period, bloom in a given wheat plant is usually complete in a few days. After Feekes stage 10.5.3, remaining growth stages refer to ripeness or maturity of the kernel.

**Feekes 11.0 — Ripening**

- Feekes 11.1 milky ripe
- 11.2 mealy ripe
- 11.3 kernel hard
- 11.4 harvest ready

Bloom occurs 4 to 5 days after heading. The grain fill period of wheat varies somewhat, depending upon climate. It is typically as little as 30 days in high stress



**Boot stage - Feekes 10.1**



**Beginning flowering - Feekes 10.5.1**

environments, and may exceed 50 days in high yield, low stress environments.



**Wheat mature and harvest-ready - Feekes 11.4**

Reprinted from *Better Crops with Plant Food*, Summer 1992. Published by the Potash & Phosphate Institute (PPI), 655 Engineering Drive, Suite 110, Norcross, GA 30092-2821.

The information given herein is for educational purposes only. Reference to commercial products or trade names is made with the understanding that no discrimination is intended and no endorsement by the Cooperative Extension Service is implied.

*Educational programs conducted by the Texas Agricultural Extension Service are open to all people without regard to race, color, sex, disability, age, or national origin.*



# *Irrigation Management for Vegetable Production*

## **In this Section**

Reference: Optimum Irrigation for Black-Eyed Peas in West Texas

Reference: Estimated Water Requirements for Vegetable Crops

Reference: Irrigation. An excerpt from TCE Vegetable Handbook



# Optimum Irrigation for Black-Eyed Peas in West Texas

## Optimum Irrigation for Black-Eyed Peas in West Texas

Calvin Trostle, Extension Agronomy, Lubbock, (806) 746-6101, c-trostle@tamu.edu  
20 July 2001

Black-eyed peas (cowpeas) are grown in several Texas South Plains counties. I'll use a recent question about mid-season inputs and foliar feeding for black-eyes and whether it might justify the expense as an opportunity to highlight the importance of optimum irrigation and avoiding crop moisture stress. The following discussion involves the cost and hoped-for return of extra inputs that are *unproven* vs. what the crop probably really needs most in typical summer heat.

A South Plains grower recognizes he has a very nice 2001 blackeye crop, and he is interested in applying a foliar feed of some sort to preserve his blooms so they don't abort and thus thwart potential pod fill. There isn't much foliar feed information on black-eyed peas, only perhaps a little experience. One basic industry production guide for black-eyed peas suggests that growers in the region could consider foliar feeding iron, zinc, manganese, and boron "on some soils."

Lets ask ourselves a couple of key questions to help us sort out how important something like a foliar feed (or other mid-season input) and its cost might be, relative to other possible mid-season inputs:

What is the greatest stress on black-eyes both now and in a typical Texas South Plains summer? **Heat!**What reduces this stress, and the many ways in which it affects the plant (pollination, pod set, fruit retention, pod fill)? **Water!** No foliar chemical, growth hormone, etc. can do the job as well.

My feeling - and a strong one - is this: as hot as it is, if a grower is willing to spend an extra \$5 to \$10/acre plus application costs for a foliar feed or some other input (for a possible benefit that is unknown and certainly unproven), the grower would be much better served to accelerate their irrigation schedule by one day. Thus on his irrigation cycle through the growing season that additional \$5 or \$10 per acre will pay for an extra 1.0 or 1.5" water per acre as additional irrigation.

### **Black-eyed pea development and yield potential**

The growth and development of black-eyed pea in West Texas is similar to but shorter in season than soybean. Maturity occurs in most varieties in about 75 to 90 days. Black-eyed peas are most sensitive to heat and moisture stress from just before initial flowering through bloom completion, which typically begins about 50 days after germination. Favorable conditions will influence a higher proportion of buds to develop and flower, hence a higher yield potential. Moisture stress during flowering will curtail pollination and fertilization.



## **Optimum irrigation timing for black-eyed pea**

Preplant soil moisture is very important. If black-eyes are planted in very good soil moisture conditions, irrigation at early flower will in most cases allow a yield potential of 1400-1800 lbs./acre. If rains come at the right time in this scenario, then 2000 lbs./acre is possible.

Black-eyed peas can utilize up to 15" of irrigation water depending on soil moisture at planting and in-season rainfall. As a rule of thumb growers can expect a yield response of about 100 to 150 lbs. per acre-inch of water.

If water is available, black-eyed peas should receive at least 1 inch of water per week, from pre-bloom through pod fill. Again, the most critical time is from just before initial flowering through bloom completion. Drought stress or a single missed irrigation during this time can hammer yields severely.

If a grower could irrigate black-eyed peas once, the optimal response is most likely at initial flowering. This is provided you can get the plant to this point, which may be difficult in a year like 2001. From this point forward black-eyed peas respond best to frequent irrigation to maintain good soil moisture, but for additional irrigations when limited water is available, irrigating at 7 to 10 day intervals, through early pod fill is best. Irrigations late in the development of the seed after the seed has reached full width in the pod will contribute little if any yield potential, particularly if adequate soil moisture remains.

## **Bottom-line: Irrigation vs. the expense of other mid-season inputs**

Returning again to the scenario posed above about mid-season foliar feeding, in this instance (and many ones similar to it on other crops), I think a grower can be much more confident in a little extra water than whether a foliar feeding or some other input is worth it. Most of these micronutrient or foliar feed concoctions are unproven, but we know that too often farmers are willing to throw \$5 or \$10 or even \$20 per acre at a product in hopes (and often thin hopes at that) of hitting a home run. When spending money, do it with as much confidence in potential return as possible.

For additional soil, crop production, insect, plant disease, and irrigation information for the Texas South Plains call you local county Texas Agricultural Extension Service office or visit the Texas A&M - Lubbock Research & Extension Center website at <http://lubbock.tamu.edu/>



# Estimated Water Requirements for Vegetable Crops



# Estimated Water Requirements of Vegetable Crops

Frank J. Dainello, Extension Horticulturist  
 Department of Horticultural Sciences, Texas A&M University

<b>CROP</b>	<b>INCHES /A</b>	<b>CRITICAL NEED STAGE</b>
Asparagus	10 - 18	establishment and fern development
Bean, green	10 - 15	bloom and pod set
Bean, pinto	15 - 20	bloom and pod set
Beet, table	10 - 15	establishment and early growth
Broccoli	20 - 25	establishment and heading
Cabbage	20 - 30	uniform throughout growth
Cantaloupe	13 - 20	establishment vining to first net
Carrot	10 - 15	emergence through establishment
Cauliflower	20 - 30	establishment and 6 - 7 leaf stage
Celery	30 - 35	uniform, last month of growth
Collards/kale	12 - 14	uniform throughout growth
Corn, sweet	20 - 35	establishment, tassel elongation, ear development
Cowpea	10 - 15	bloom, fruit set, pod development
Cucumber, pickle	15 - 20	establishment, vining, fruit set
Cucumber, slicer	20 - 25	establishment, vining, fruit set
Eggplant	20 - 35	bloom through fruit set
Garlic	15 - 20	rapid growth to maturity
Lettuce	8 - 12	establishment
Mustard green	10 - 15	uniform throughout growth
Okra	15 - 20	uniform throughout growth
Onion	25 - 30	establishment, bulbing to maturity
Pepper, bell	25 - 35	establishment, bloom set
Pepper, jalapeno	25 - 30	uniform throughout growth
Potato	20 - 40	vining, bloom, tuber initiation
Pumpkin	25 - 30	2-4 wks after emergence, bloom, fruit set and development
Radish, red globe	5 - 10	rapid growth and development
Spinach	10 - 15	uniform throughout growth, after each cut if needed
Squash	7 - 10	uniform throughout growth
Sweetpotato	10 - 20	uniform until 2 - 3 wks prior to anticipated harvest
Tomato	20 - 25	bloom through harvest
Turnip	10 - 15	uniform throughout growth
Watermelon	10 - 15	uniform until 10 - 14 days prior to anticipated harvest



*Irrigation. An excerpt from*  
TCE Vegetable Handbook

## Excerpt from TCE Vegetable Growers' Handbook

<http://aggie-horticulture.tamu.edu/extension/veghandbook/index.html>

### Chapter V

# Irrigation

**Guy Fipps and Frank J. Dainello**

Most growers recognize that agriculture is a very risky business. Irrigation is a means of reducing some of the risk in agriculture, and is necessary for vegetable production in many areas of the State. The hope is that additional revenue from improved quality and yields will not only pay for the costs of purchasing and operating the irrigation system, but also will result in greater profits. Choose the correct system for your particular situation. Consider carefully the initial costs of buying and installing the system, as well as the continuing costs for pumping, operation, labor and maintenance.

Good management practices are also very important. Correct irrigation timing and amounts of water often make the difference between profit and loss in an irrigation operation. Additionally, the use of pressure gauges and flow meters to monitor irrigation system performance allows for the timely detection of problems. This chapter will cover some of the basic factors that should be considered in selection and management of irrigation systems for vegetable production in Texas. Space limitations prevent detailed discussion of all the aspects of irrigation. Additional references and sources of information are provided for each topic.

## Irrigation System Selection

### Factors to Consider

There are many types of irrigation systems on the market that are suitable for vegetable production. Systems vary greatly in costs and have different operation and site requirements. Many factors determine which system is right for you. Some of the factors to consider and data needed for a proper irrigation system design are listed in Table V-1. Contact your local office of the USDA, Natural Resource Conservation Service (NRCS), irrigation dealer or county Extension agent for assistance in completing a site evaluation. The booklet "Planning for an Irrigation System" (Reference 1) contains a complete discussion of the factors to consider and types of systems. Another good source of information for general planning purposes is the "Soil Survey" by the USDA Soil Conservation Service (NRCS) for your county and specific site. It provides general recommendations on the suitability of soil types for the irrigation of specific crops.

### Critical factors to consider:

- Water Supply:** The amount of water available and the cost of the water (due to pumping or direct purchase) will determine the amount of land that can be irrigated and often the type of system you should use. Depending on location, climate, type of crop and irrigation system efficiency, a water supply (well yield or delivery rate) from 3 to 15 gallons per minute (GPM) is required for each acre to be irrigated. If the supply of water is limited or very expensive, then consider only the most efficient types of systems (Table V-2).

**Table V-1. Principal Data Needed for Farm Irrigation System Design**

<b>Data</b>	<b>Specific requirements</b>
Crop	Distribution and area of each crop to be grown; suitability of each crop to climate, soils, farming practices, markets, etc.; planting dates, etc., for each crop to be grown over the expected life of the project
Soils	Area distribution of soils; water holding and infiltration characteristics, depth, drainage requirements, salinity, erosion potential of each soil.
Water requirements	Data for estimating daily and seasonal water requirements for each crop
Water supply	Location of water source; amount of water or pumping capacity, water surface elevation; hydrologic and water quality information for assessing the availability, costs, and suitability of the water for irrigation; water rights information
Energy source	Location, availability, and type of source(s); cost information
Capital and labor	Capital available for system development, level of technical skill, and cost of labor
Other	Topographic map showing location of roads, buildings, drainways, and other physical features that influence design; financial situation of farmer, farmer preferences

**Table V-2. Typical Overall On-farm Efficiencies for Various Types of Irrigation Systems (adapted from James, 1988).**

<b>System</b>	<b>Overall Efficiency (%)</b>
Surface	50-80
a. average	50

b. land leveling and delivery pipe-line meeting design standards	70
c. tailwater recovery with (b)	80
d. combination level and graded flow irrigation (max 0.1% grade and block ends)	80-95
e. surge	60-90
Sprinkler	55-75
Center Pivot	55-75
LEPA	
a. bubble mode	95-98
b. spray mode	80-85
Drip	80-90

\* Surge has been found to increase efficiencies 8 to 28% over non-surge furrow systems.

\*\*Trickle systems are typically designed at 90% efficiency, short laterals (< 100') or systems with pressure compensating emitters may have higher efficiencies

- **Water Quality:** Is the water suitable? Be sure to have a water sample analyzed. The Soil and Water Testing Lab at Texas A&M University will provide recommendations on the suitability of your water for irrigation of specific crops. Contact your county Extension agent for forms and information. Also, water high in salts may cause foliar damage if sprayed directly on the plants. In these cases consider systems that deliver water directly on or below the surface such as drip, surface or LEPA systems. Special consideration is also needed in the placement of drip tubing and emitters when irrigating with saline water.
- **Soil Type:** Light sandy soils are not well suited to furrow or surface irrigation systems. Lateral water movement is restricted in these soil types. These soils are best irrigated by sprinkler or drip irrigation system.
- **Field Shape and Topography:** Odd shaped field not easily irrigated with certain types of sprinkler systems such as center pivots. Rolling topography prohibits the use of furrow or surface systems because water cannot run up hill.
- **Labor:** Labor availability and costs are prime considerations. The labor and skill required for operation and maintenance varies greatly between systems. For example, studies have shown that about one-man-hour per acre is required for a hand-move sprinkler system. Mechanical move systems require 1/10 to 1/2 as much labor. Automated systems are more expensive to purchase, but may be more profitable when the labor costs over the life of the system are considered.
- **Suitability:** Choose a system that is compatible with your farming operations, equipment, field conditions and crops and/or crop rotation plan.
- **Personal Preference:** Select a system that you can live with. If you do not like your system, chances are you will not operate or maintain it properly.

## Types of Systems

Irrigation systems may be grouped into three general types: surface, sprinkler and drip. Aspects of these systems are compared in Table V-3. Only a brief description of each type will be given here. For more information refer to Reference 1 and the other references at the end of this chapter. Other good sources of information are the county Extension agent, the area NRCS office and the local irrigation dealer.

**Table V-3. Comparison of Irrigation Systems in Relation to Site and Situation Factors**

<b>Site and Situation Factors</b>	<b>Well-designed Surface Systems</b>	<b>Level Basins</b>	<b>Intermittent Mechanical Move*</b>	<b>Continuous Mechanical Move**</b>	<b>Solid Set and Permanent</b>	<b>Emitters and Drip Tubing</b>
Infiltration rate	Moderate to low	Moderate	All	Medium to high	All	All
Topography	Moderate slopes	Small slopes	Level to rolling	Level to rolling	Level to rolling	All
Crops	All	All	Generally shorter crops	All but trees and vineyards	All	High value required
Water supply	Large streams	Very large streams	Small streams nearly continuous	Small streams nearly continuous	Small streams	Small streams continuous and clean
Labor requirement	High, training required	Low, some training	Moderate, some training	Low, some training	Low to seasonal high, little training	Low to high, some training
Capital requirement	Low to moderate	Moderate	Moderate	Moderate	High	High
Energy requirement	Low	Low	Moderate to high	Moderate to high	Moderate	Low to moderate
Management skill	High	Moderate	Moderate	Moderate	Moderate	High
Windy conditions	Good	Good	Poor	Poor to excellent***	Fair	Fair to excellent

\* Side roll, big guns, etc.

\*\* Center pivot, 1

\*\*\* Depends on type of water applicators



Adapted from: G.O. Schwab, R.K. Frevert, T.W. Edminster, and K.K. Barnes, Soil and Water Conservation Engineering, 1981. John Wiley & Sons, Inc., New York, pp 430-431.

## Surface

*Surface irrigation* uses gravity flow to spread water over a field. A good supply of water (stream size) in GPM (gallons per minute) is needed. Surface systems are the least expensive to install, but have high labor requirements for operation. Skilled irrigators also are needed in order to obtain good efficiencies. Even if properly designed, surface systems tend to have low water application efficiencies. Low efficiencies result in higher pumping (or water costs) due to the increased amounts of water required. The NRCS has developed the design standards used for surface irrigation.

The two most common surface systems used for irrigating vegetables in Texas are level basin and furrow systems.

*Level basin* (or dead level irrigation): With this method, water is applied over a short period of time to a completely level area enclosed by dikes or borders. The floor of the basin may be flat, ridged or shaped into beds. Basin irrigation is most effective on uniform soils precisely leveled when large stream sizes (in GPM) relative to basin area are available. If properly designed and operated, level basin systems can attain high water application efficiencies.

*Furrows*: are small, evenly spaced, shallow channels formed in the soil. Optimal furrow lengths are primarily controlled by the soil intake rate, furrow slope, set time and stream size. For most applications the stream size should be as large as possible without causing erosion. NRCS has developed recommendations on maximum row length for specific soils and slopes. The major limitation of this system is the inability to apply small amounts of water at frequent intervals as needed by shallow rooted vegetable crops.

Combination level and graded flow irrigation systems are most commonly used in the Lower Rio Grande Valley. They have a maximum slope of 0.1 ft per 100 feet (0.1 percent) and block ends. With proper stream size, these systems can have good water application efficiencies.

*Advantages of surface systems are*: water deficits can be overcome rapidly; least expensive of the major types of irrigation systems; low maintenance, and, usually require the lowest level of management.

*Disadvantages of surface systems are*: possess the least water use efficiency; lack uniformity in water distribution, increase disease incidence especially in vining crops, and, periodic depletion of soil oxygen which can cause yield reduction

For furrow irrigation, you should consider the following:

- Precision land leveling - improves water application efficiency. Leveling land is cost effective on many sites, and will pay for itself by increasing yields and reducing water losses.

- Gated pipe - can result in a 35 to 60 percent reduction in water and labor costs. Gated pipe provides a more equal distribution of water into each furrow and eliminates seepage and evaporative losses which occur in unlined irrigation ditches. Gated pipe is available as the traditional aluminum pipe, the less expensive low-head PVC pipe, and the inexpensive "lay-flat" plastic tubing. The lay-flat tubing will last 3 to 5 seasons.
- Surge flow irrigation - is a variation of continuous-flow furrow irrigation. Water is usually applied in cycles of one to three hours of alternating on-off periods. Surge works by taking advantage of the natural surface sealing properties of many soils. Surge often results in increased irrigation efficiencies and gives the grower the ability to apply smaller amounts of water at more frequent intervals. The automatic surge valves are also appealing because of reduction in labor. Researchers have found that for the clay silt soils found on the Texas High Plains, surge requires a stream size of 12 to 16 GPM for each furrow. Some experts claim that generally a stream size from 20-25 GPM is necessary. For more information on surge see TAEX Publication L-2220 "Surge Flow Irrigation" (Reference 3).

## Sprinkler

Sprinkler irrigation is defined as a pressurized system where water is distributed through a network of pipe lines to and in the field and applied through selected sprinkler heads or water applicators. Sprinkler systems are more expensive than surface systems, but offer much more flexibility and control. They are suitable for most soil and topographic conditions, and can also be used for cooling and frost/freeze protection.

The basic components of sprinkler systems are illustrated in Figure V-1 and include a water source, a pump to pressurize the water, a pipe network to distribute the water through the field, sprinklers to spray the water over the ground, valves to control the flow of water, and flow meters and pressure gauges to monitor system performance. Many sprinkler systems are also very good for chemigation (see section below). There are many types of sprinkler devices available (only a few of the more common types of sprinkler systems are discussed here). For more information see References 1, 2, 4, 5 and 9.

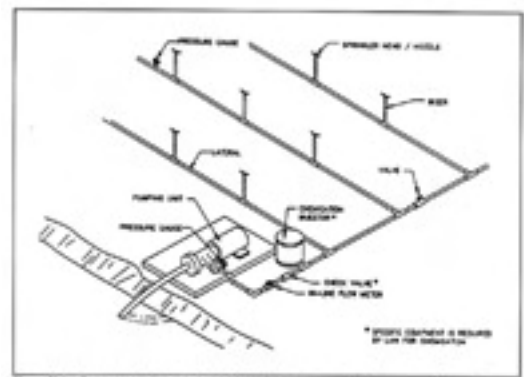

Figure V-1. Components of a typical sprinkler irrigation system. A flow meter and several pressure gauges are used to monitor system performance.

Figure V.1

Click on image to enlarge.

*Hand-move and portable sprinklers:* These systems employ a lateral pipeline with sprinklers installed at regular intervals. The lateral pipe is often made of aluminum and comes in 20, 30 or 40 foot sections with special quick-coupling connectors at each pipe joint. The sprinkler lateral is placed in one location and operated until the desired water application has been made. Then, the lateral line is disassembled and moved to the next position to be irrigated. The sprinkler nozzle is replaceable, and must be matched to the flow rate, riser height, spacing and area to be covered.

The manufacturer's specifications on height and spacing must be followed to ensure proper overlap of spray pattern and uniform application.

*Solid set or permanent sprinklers:* Such systems are not moved from location to location, thus reducing labor costs. However, solid set systems have much higher initial costs than portable systems. These systems require a larger number of mainlines, laterals, risers and nozzles. Mainlines and/or laterals are sometimes buried in order to prevent interference with mechanical field operations.

*Side roll system:* With side rolls, the lateral line is mounted on wheels with the pipe forming the axle. A drive unit, usually a gasoline engine, moves the system from one irrigation position to the next one. The side-roll system is best suited for rectangular fields and is limited to short crops (usually 4 feet or less). Water is supplied to the system through a flexible hose which may be connected to risers strategically located along the edge of the field.

*Portable (traveling) gun system:* Portable guns come in two types: hard hose or hose reel system and the cable tow or hose drag system. Both types are labor intensive and use large amounts of energy due to their high operating pressures. Guns generally are not used for vegetable crops due to their poor water application efficiency, large droplets, high operating pressures and high application rates.

*Center pivots:* Pivots consist of a single sprinkler lateral supported by a series of towers. The towers are self-propelled, so that the lateral rotates around a pivot point in the center of the irrigated area. They are best suited to the irrigation of large acreage where water supply is not limited. Quarter mile systems which irrigate 120 Acres are commonly nozzled for 400 to 1200 GPM. When considering labor, maintenance and purchase costs, pivots are very cost effective on a per acre basis. Center pivot equipped with LEPA heads are highly recommended because the costs on a per acre basis are relatively low (\$325 to \$400/ac), water application efficiency is very high and these systems offer unmatched flexibility due to their three modes of operation (bubble, spray and chemigation). For more information see TAEX Publication L-2219 "Center Pivot Irrigation Systems" (Reference 5).

*Advantages of sprinkler systems are:* readily automated, lend themselves to chemigation and fertigation, reduced labor requirements needed for irrigation; LEPA type systems can deliver precise quantities of water in a highly efficient manner, and, are adaptable to a wide range of soil and topographic conditions.

*Disadvantages of sprinkler systems are:* Initially high installation cost, and, high maintenance.

## **Drip**

Drip, trickle, irrigation is the slow, frequent application of water to the soil through emitters or tubing. As only a small area of the total field is wetted, drip irrigation is especially suited for

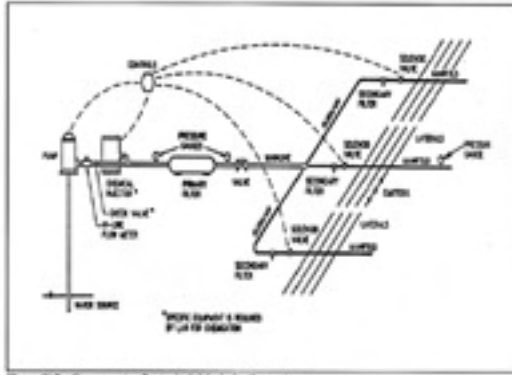

Figure V.2. Components of a typical drip irrigation system.

Figure V.2

Click on image to enlarge.

situations where the water supply is limited. Drip tubing is used frequently to supply water under plastic mulches. Drip systems tend to be very efficient and can be totally automated. Applying nutrients through the trickle system is very effective, and may reduce the total amounts of fertilizer needed. Of the irrigation systems available, drip is the most ideally suited to high value crops such as the vegetables. Properly managed systems enable the production of maximum yields with a minimum quantity of water. These advantages often help justify the high costs and management requirements.

A typical drip irrigation system is shown in Figure V-

2. There are many types of drip products on the market designed to meet the demands for just about any application. Your local irrigation dealer is the best source for specific product information. The Texas Water Development Board and your county Extension agent can provide general "trickle" information and publications. Drip systems are also covered in Reference 1.

**Some important trickle considerations and choices:**

- Drip tubing, emitters, or micro-sprinklers: Four types of drip tubing are shown in Figure V-3. Porous tubing such as "soaker hose" or "leaking pipe" has very poor uniformity and generally should not be used except in home gardens and landscape applications. Drip strip tubing is commonly used on row crops due to its low cost (3 to 20 cents per foot) and includes such products as double-walled tubing and drip tape (Figure V-3). These products deliver water from the center of the tubing to the outside using planned designs as shown in Figure V-4. Regulating tubes provide more uniform water application rates, especially for long laterals. Due to the wide variation in sites and designs, recommendations on the maximum lateral length cannot be made without manufacturer's specifications. In most cases, however, row length in the 500 - 700 feet range is suggested. Longer runs can be made but will require larger diameter, more expensive drip tape. With proper filtration and maintenance (periodic flushing of lines, etc.), 15 or 16 mil wall tubing can have life spans ranging from 3 to 7 years, depending on product chosen. The less expensive 4 to 6 mil wall tubing generally can be used to produce 2 - 3 crops if the system is well managed. More expensive in-line, barbed and thread- type emitters are used primarily for permanent systems on high value cash crops or as semi- annual systems that are removed from the field and stored following the irrigation season. They tend to give better uniformity, and are less prone to clogging than strip tubing due to their larger orifices. Micro-sprinklers are used in situations where a large soil area needs to be wetted, such as in orchards and vineyards. They are very effective for protection against frost/freeze injury of tree crops, but generally are not used on row crops due to their high costs.

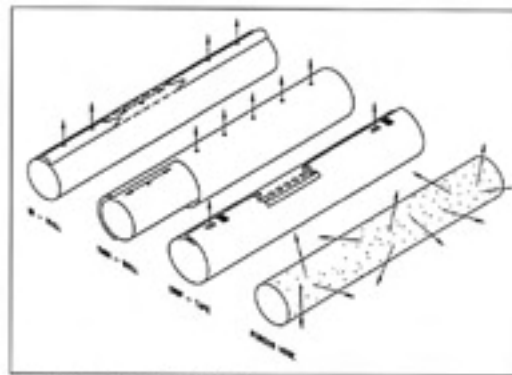

Figure V.3. Common types of drip strip tubing.

Figure V.3

Click on image to enlarge.

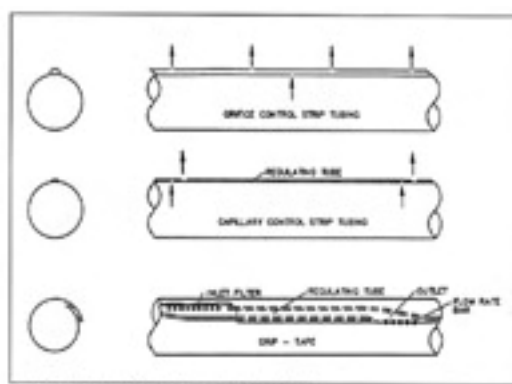

Figure V.4. Flow control design of common drip strip tubing.

Figure V.4

Click on image to enlarge.

- Buried or Surface:* Buried lines tend to have less clogging problems, do not interfere with field operations and are not damaged as often by rodents. However, clogging problems are more difficult to see than with surface lines. In some areas, much damage to buried lines is caused by gophers and ants. Ants can be controlled by injection of insecticides where it is approved (check labeling). Some manufacturers make a special ant resistant tubing. Clogging of buried emitters by roots is generally not a problem. A typical tool for installing strip tubing is

mounted on a tractor and is shown in Figure V-5. When burying, the emitter orifice should be facing upward toward the surface in order to reduce clogging problems and to allow soil particles to collect on the bottom of the tubing where they are easily flushed out. Most successful drip irrigators have found that surface applied tape creates serious management problems. The tape tends to "snake" in the field with changes in temperature and high wind speed can blow tape off of the beds or out of the rows. Shallow burying alleviates these problems. The depth at which tape is buried depends upon the crop grown. However, tape placed 4- 6 inches deep seems to work best in most cases for vegetable crops.

- *Pressure or Non-pressure Compensating:* Pressure compensating lines and emitters are used to maintain uniform discharges in spite of pressure changes caused by slope or high friction losses due to excessively long laterals. For many flat to small slope situations, adequate uniformity can be achieved with non-pressure compensating lines or emitters.
- *Filters:* One of the secrets to successful drip irrigation is proper filtration. Two types of filters are used: screen and media. Screen filters are the least expensive, and are used for relatively clean water sources such as wells or municipal supplies. Screen size needed depends on the size of the orifice of the emitter or drip line. Most drip strip tubing products require a 200 mesh screen. Media or sand filters are required where surface waters (streams, ponds, etc.) are used. Media filters are expensive, but may be equipped for automatic flushing, thus reducing maintenance. Manufacturers and irrigation dealers can supply the filtration requirements for particular products.

Although drip irrigation has been shown to increase yield, it is often difficult to justify their use based on yield increase alone due to the expense associated with these systems. Therefore, *the decision to purchase a drip system should be based only on one or both of the following situations:*

*Excessive water cost* - The most effective means of reducing water cost is to reduce the volume of water needed to produce a crop. The increased water use efficiency of drip enables a significant reduction in the total volume required to satisfy crop needs. Additionally, less energy use is required to pump water with drip systems as compared to surface, sprinkler or pivot systems. As a result, the cost of water per unit of product produced is reduced.

*Limited water supply* - To deal with limited water supplies, vegetable producers are forced to either reduce acreage or sacrifice crop yield. The reduced water volume required to produce a crop with drip affords the opportunity to optimally irrigate a crop or to expand irrigatable acreage.

***Note: It must be remembered that plant water requirements cannot be reduced with any type of irrigation system, but rather, the volume of water needed to be delivered to a crop can be reduced because the efficiency of the system is so much better.***

As with the other types of irrigation systems, there are advantages and disadvantages to the use of drip irrigation.

### *Advantages of drip irrigation:*

- Limited water sources can be used.
- Lower pressures are required to operate systems resulting in a reduction in energy for pumping.
- Precise water volume can be applied in the root zone (the area of use).
- Every plant in the field receives water nearly at the same moment.
- Other field operations such as harvesting and spraying can be done while irrigating.
- Reduced nutrient leaching, disease development, labor and operating costs are obtainable.
- Readily automated and well adapted to chemigation and fertigation.

### *Disadvantages of drip irrigation:*

- High initial investment.
- Insect, rodent and human damage to drip tape readily occurs.
- High management.
- Cannot recover from a moisture deficit situation as readily as other systems.
- Used tape disposal.

## **Determining Irrigation Costs and Return on Investment**

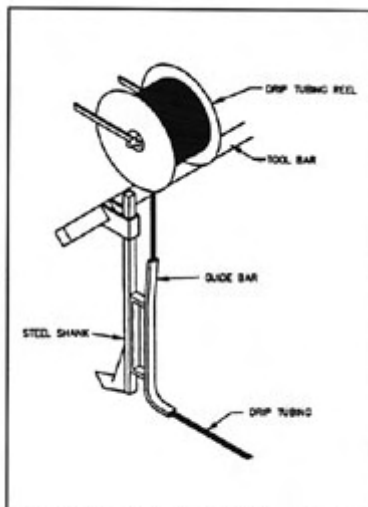

Figure V-5. Installation device commonly mounted on a tractor for burying drip strip tubing.

Figure V.5

Click on image to enlarge.

When deciding whether or not to irrigate, a sound and complete economic analysis should be made. The first step is to estimate the potential increase in profits with irrigation over dry land or in going to a more efficient irrigation system. Your county Extension agent can put you in touch with successful irrigators in your area; compare your yields to theirs. Next, estimate the cost of purchasing and operating the irrigation system. Your local irrigation dealer will provide cost estimates for different types of systems. Both the dealer and your local county Extension agent can assist you in estimating the operating costs of different systems. Be sure to consider pumping, labor, and maintenance. These costs vary widely between systems. Table V-4 gives the annual maintenance and repair costs as a percent of initial costs for some irrigation system components.

Reference 1 discusses in detail irrigation cost analysis. TAEX Publication L-2218 "Pumping Plant Efficiencies and Irrigation Costs" (Reference 6) is useful in evaluating pumping costs for different fuels and pumps. TAEX also has available a low cost PC software package entitled "Irrigated vs Dryland Crop Production" (AAU). This program is designed to take you step by step through the process of evaluating the costs and returns of irrigated versus dryland crop production including such factors as the cost of money and depreciation. Another program

"Pumping Plant Efficiency and Fuel Costs" (AAR) is helpful in estimating seasonal pumping costs for different fuels. These packages can be purchased from TAEX Software Distribution (979/845-3929). Most county Extension offices have TAEX software on their computers.

### Design Considerations

Design of an irrigation system should be done in a systematic and logical manner. The design process can be divided into 8 steps as listed below:

- Determine number of acres, types of crops and crop rotation plan.
- Estimate water supply required to meet crop needs. Be sure to adjust these rates for losses due to irrigation efficiencies (Table V-2) and other expected water losses. Also check with local growers, NRCS personnel and irrigation dealers for water delivery rates used in your area.

**Table V-4. Annual Maintenance and Repairs, and Depreciation Guidelines for Irrigation System Components.**

Component	Depreciation (hours)	Period (yr)	Annual Maintenance and Repair Percent <sup>a</sup>
Wells and casings	-	20-30	0.5-1.5
Pumping plant structure	-	20-40	0.5-1.5
Pump, vertical turbine			
Bowls	16,000-20,000	8-10	5-7
Column, etc.	32,000-40,000	16-20	3-5
Pump, centrifugal	32,000-50,000	16-25	3-5
Power transmission			
Gear head	30,000-36,000		5-7
V-belt	6,000	3	5-7
Flat belt, rubber and fabric	10,000	5	5-7
Flat belt, leather	20,000	10	5-7
Prime movers			
Electric motor	50,000-70,000	25-35	1.5-2.5
Diesel engine	28,000	14	5-8
Gasoline engine			
Air cooled	8,000	4	6-9
Water cooled	18,000	9	5-8
Propane engine	28,000	14	4-7
Open farm ditches (permanent)		20-25	0.5-1.0
Concrete structure		20-40	0.5-1.0



Pipe, asbestos-cement and PVC buried		40	0.25-0.75
Pipe, aluminum, gated surface		10-12	1.5-2.5
Pipe, steel, waterworks class, buried		40	0.25-0.50
Pipe, steel, coated and lines, buried		40	0.25-0.50
Pipe, steel, coated, buried		20-25	0.50-0.75
Pipe, steel, coated, surface		10-12	1.5-2.5
Pipe, steel, galvanized, surface		15	1.0-2.0
Pipe, steel, coated and line, surface		20-25	1.0-2.0
Pipe, wood, buried		20	0.75-1.25
Pipe, aluminum, sprinkler use, surface		15	1.5-2.5
Pipe, reinforced plastic mortar, buried		40	0.25-0.50
Pipe, plastic, trickle, surface		10	1.5-2.5
Sprinkler head		8	5-8
Drip emitters		8	5-8
Drip filters		12-15	6-9
Land grading <sup>b</sup>		none	1.5-2.5
Reservoirs <sup>b</sup>		none	2.0-2.0
Mechanical move sprinklers		12-16	5-8
Continuous moving sprinklers		10-15	5-8

Source: G.T. Thompson, L.B. Spiess, and J.N. Krider, Farm Resources and System Selection, In Design and Operation of Farm Irrigation, Systems, 1980, M.E. Jensen(Ed.) ASAE Monograph 3, St. Joseph, MI, p. 45

<sup>a</sup> Annual maintenance and costs are expressed as a percentage of the initial cost.

<sup>b</sup> Various stages of expected life, from 7-50 years have been applied to land grading and reservoir costs. If adequate maintenance is practiced, these items will remain unaffected by depreciation.

- Determine if water supply is adequate. Generally, irrigation systems are designed to meet peak consumptive water use.
- Determine if water source is suitable. Have a water sample analyzed by the TAEX Soil and Water Testing Lab.
- Select irrigation system.
- If using drip, select a filter system. For surface water sources, determine if settling ponds or screens are required.
- For sprinkler and drip systems, correctly size lateral, manifold and main pipelines. Improperly sized lines often result in excessive friction losses, increased pumping

costs and poor water application uniformity. For surface systems, have length of runs and irrigation canals sized by NRCS according to slope, soil type and water supply.

- Determine pump requirements include friction losses, operating pressure requirements and changes in elevation. Steps 6, 7 and 8 are very important, and often will determine the economics of operating the system. These should be done by a qualified irrigator or engineer.

The purchase, installation, operation and maintenance of irrigation systems is a major and significant capital expense. The long term economics of irrigation depends on the system being properly designed for your particular farm conditions.

### **Common problems that occur in improperly designed systems**

- System capacity is too low to meet crop water needs.
- Too much or too little water is applied per application.
- System application rates exceed soil intake rates.
- Improperly sized mainlines and laterals result in excessive friction losses and a significant increase in pumping costs.

### **Selecting a Dealer**

As in choosing any professional service, the selection of an irrigation dealer should be done carefully. Agricultural irrigation systems are exempt from regulation by the Texas Board of Irrigators (P.O. Box 12337, Capitol Station, Austin 78711, 512/463-7990). Thus, there is little recourse for the buyer of an improperly designed system. In selecting a dealer consider his qualifications, experience, reputation, knowledge, service record and references. Professional Agricultural Engineers do have the training for proper irrigation design and are on the staffs of several dealerships in Texas. The county Extension agent can help identify reputable dealers that service your area.

### **Irrigation Wells**

When sizing an irrigation well, you should consider the long term well costs and performance, not just the immediate or short term costs. Poorly designed or developed wells result in higher pumping costs and shorter pump life. Procedures exist that will ensure continuous sand-free water supply, large yields, long pump and well life, and which will produce the most water for every dollar invested. These procedures are discussed in an unnumbered manuscript "Irrigation Well Design and Construction" by Dr. Don Reddell which is available through Extension Agricultural Engineering.

All well drillers in the State of Texas must be licensed by the Texas Water Well Drillers Board through the Texas Water Commission (TWC). In addition, the TWC has established minimum well standards and reporting requirements. For more information on the program or on the filing of complaints, contact the Texas Well Drillers Board at the TWC in Austin (512/371-6252).

The data in Table V-5 can be helpful in determining if an irrigation well has the flow rate capacity to meet the intended crop acreage water demands. The numbers can also be used to evaluate irrigation capacity with various irrigation well flow rates for daily, weekly and 30, to 100 day increment periods of pumping time. Water volumes are applicable for all irrigation systems and irrigatable acreage. They include application losses. Numbers represent 100 percent of the water but reflect irrigation capacity with highly efficient systems such as LEPA or drip (98%). Figure on 20 % less for other conventional systems.

**Table V-5. Required irrigation well flow rate capacity**

GPM/A	In/week	In/day	Inches in irrigation days				
			30	45	60	80	100
1.5	.55	.08	2.4	3.8	4.8	6.4	8.0
2.0	.75	.11	3.2	4.8	6.4	8.5	10.6
2.5	.93	.13	4.0	6.0	8.0	10.6	13.3
3.0	1.10	.16	4.8	7.2	9.5	12.7	15.9
3.5	1.30	.18	5.6	8.3	11.1	14.8	18.6
4.0	1.50	.21	6.4	9.5	12.7	17.0	21.2
4.5	1.67	.24	7.2	10.7	14.3	19.1	23.9
5.0	1.85	.27	8.0	11.9	15.9	21.2	26.5
5.5	2.00	.29	8.7	13.1	17.5	23.3	29.2
6.0	2.25	.32	9.5	14.3	19.1	25.4	31.8
6.5	2.41	.34	10.3	15.5	20.7	27.5	34.4
7.0	2.60	.37	11.1	16.7	22.6	29.7	37.1

Prepared by Leon New, Agricultural Engineer-Irrigation, Texas Agricultural Extension Service, Amarillo, TX.

To determine flow rates required, multiply the gpm / A listed times the number of acres to irrigate to arrive at the flow rate needed to apply volume (inches) shown.

*Example:*

*120 acres to be irrigated  
x 4 gpm/A  
480 gpm flow rate required to apply 1.5 inches of water per week*

**Pump Selection**

Inefficient pumps and power units are major contributors to excessively high irrigation costs. To minimize fuel consumption and cost, pumping equipment must be carefully selected, properly maintained and replaced when necessary to maintain high efficiency. Efficient pumping plants, with their lower pumping cost combined with efficient application of carefully timed irrigations, can make the difference between profit and loss in irrigated crop production. For information on pumping plant selection and costs see Reference 1 and TAEX publication L-2218 "Pumping Plant Efficiency and Irrigation Costs" (Reference 6). You should have a pumping plant efficiency test made at least every 5 to 8 years. Some electric utility companies and under ground water conservation districts do pump efficiency testing at no charge.

### **Farm Water Delivery Systems**

On-farm water delivery systems include lined and unlined canals and pipelines. As with other irrigation system components, you should carefully weigh the initial construction or purchase price against the long-term costs of maintenance, pumping and/or the direct purchase costs of water. While earthen canals have low initial costs, the costs of the water lost to canal seepage may become significant over the canal's lifetime. Transporting irrigation water through pipelines has proven to be the most trouble free and economical method.

*Canals:* Losses from irrigation canals come from both seepage into the surrounding soil and direct evaporation. Seepage losses may cause a water logged area or a salinity problem which is difficult to manage. Costs of water lost to seepage often will more than pay for lining materials or replacement pipelines. Unlined canals are sometimes acceptable in heavy clay soils which have low infiltration rates. Canals put in other soils will have low water delivery efficiencies. The NRCS has developed guidelines for the design of canals.

*Irrigation Pipelines:* In sizing irrigation pipelines, the best size is not always the one with the lowest initial cost, but the size which minimizes the capital, pumping, maintenance and energy costs during the life of the system. Two factors are important: friction losses and water hammer; both of which are influenced by the relationship between flow rate (or velocity) and pipe size.

Water hammer results from turbulent flow in the pipe. Water hammer may be caused by shock waves created by sudden increases or decreases in the velocity of the water or the lack of pressure relief valves. To prevent waterhammer, a rule of thumb is to keep the water velocity at or below 5 feet/second. The exception is suction pipe lines for centrifugal pumps which should be kept between 2 and 3 feet/second. Table V-6 lists the maximum flow rates recommended for different pipe sizes using the 5 feet/second rule.

**Table V-6. Approximate maximum flow rate in different pipe sizes to keep velocity # 5 feet per second.**

<b>Pipe diameter (in)</b>	<b>Flow rate (GPM)</b>	<b>Pipe diameter (in.)</b>	<b>Flow rate (GPM)</b>
1/2	6	4	200

3/4	10	5	310
1	15	6	440
1 1/4	25	8	780
1 1/2	35	10	1225
2	50	12	1760
3	110	16	3140

Excessive friction losses translate directly into higher power and thus, pumping costs. Select a pipe size appropriate for your flow rate. Smooth pipe has less friction loss, hence, lower operating cost than rough pipes. Plastic pipe, such as PVC, is the smoothest, followed by aluminum, steel and concrete, in that order. Table V-7 lists typical friction losses in commonly used pipe; it can be used for estimating operating costs for pipelines. More precise figures from manufacturers' specifications should be used for design purposes.

**Table V-7. Approximate friction losses in feet of head per 100 feet of pipe**

Pipe size	<u>4-inch</u> Steel Alum. PVC	<u>6-inch</u> Steel Alum. PVC	<u>8-inch</u> Steel Alum. PVC	<u>10-inch</u> Steel Alum. PVC	<u>12-inch</u> Steel Alum. PVC
Flow rate (gpm)					
100	1.2 0.9 0.6	---	---	---	---
150	2.5 1.8 1.2	0.3 0.2 0.2	---	---	---
200	4.3 3.0 2.1	0.6 0.4 0.3	0.1 0.1 0.1	---	---
	-----				
250	6.7 4.8 3.2	0.9 0.6 0.4	0.2 0.1 0.1	0.1 0.1 -	---
300	9.5 6.2 4.3	1.3 0.8 0.6	0.3 0.2 0.1	0.1 0.1 -	---
400	16.0 10.6 7.2	2.2 1.5 1.0	0.5 0.3 0.2	0.2 0.1 0.1	0.1 --
		-----			
500	24.1 17.1 11.4	3.4 2.4 1.6	0.8 0.6 0.4	0.3 0.2 0.1	0.1 0.1 0.1
750	51.1 36.3 24.1	7.1 5.0 3.4	1.8 1.3 0.8	0.6 0.4 0.3	0.2 0.1 0.1
1000	87.0 61.8 41.1	12.1 8.6 5.7	3.0 2.1 1.4	1.0 0.7 0.5	0.4 0.3 0.2
			-----		
1250	131.4 93.3 62.1	18.3 3.0 8.6	4.5 3.2 2.1	1.5 1.1 0.7	0.6 0.4 0.3

1500	184.1 130.7 87.0	25.6 18.2 12.1	6.3 4.5 3.0	2.1 1.5 1.0	0.9 0.6 0.4
1750	244.9 173.9 115.	34.1 24.2 16.1	8.4 6.0 4.0	2.8 2.0 1.3	1.2 0.9 0.6
				_____	
2000	313.4 222.5 148.1	43.6 31.0 20.6	10.8 7.7 5.1	3.6 2.6 1.7	1.5 1.1 0.7

Note: Flow rates below horizontal line for each pipe size exceed the recommended 5-feet-per-second velocity.

## Water Requirements, Irrigation Capacity and Scheduling Water Demands of Vegetables

The primary purposes of irrigation are to provide a soil environment for seed germination, seedling emergence and root development, and to supply sufficient water for plant growth and development. Soil moisture ideally is maintained in a range that permits absorption of water by the plant roots at a rate comparable to the plant's consumptive use (or transpiration). The amount of water a plant uses is affected by many factors, the most important of which are leaf area, stage of crop growth, climate and soil. Most plants also have critical periods during which significant reduction in yield and/ or quality will occur if adequate water is not supplied. Critical periods for some vegetable crops are listed in Table 33 of the Appendix.

Unfortunately, little data is available on the water requirements of vegetables in Texas. The most extensive study of water requirements was conducted by the Texas Board of Water Engineers (Reference 7). The average daily consumptive water use of shallow and deep- rooted vegetables from this study are given in Tables 34 found in the Appendix for various regions of the State (Figure V-6). Estimates of peak consumptive water use, based on climatic conditions, are presented in Table 35 of the Appendix. Generally, irrigation systems are designed to supply the peak water demand of the plants. Peak water demand may be estimated from Tables 33 to 35. In some areas recommended rates may also be obtained from many local NRCS offices and county Extension agents.



Figure V.6. Land resource area and sub-divisions of irrigated areas.

Figure V.6

Click on image to enlarge.

## Water Quality

To determine whether a source of water is suitable for irrigation, the water must be analyzed for:

- the total concentration of soluble salts
- the relative proportion of sodium to the other cations
- the bicarbonate concentration as related to the concentration of calcium and magnesium
- the concentration of toxic elements.

In assessing water quality keep in mind that the water from the same source can vary in quality with time. Samples, therefore, should be tested at intervals throughout the year or during the potential irrigation period. The Soil and Water Testing Lab at Texas A&M University can do a complete analysis of irrigation water, and will provide a detailed computer printout on the interpretation of the analysis.

### **Salinity Hazard**

Excess salt increases the osmotic pressure of the soil solution which can result in a physiological drought condition. That is, even though the field appears to have plenty of moisture, the plants wilt because the roots are unable to absorb the water. The total soluble salt content is often determined by measuring the electrical conductivity (EC) in millimhos per centimeter (mmhos/cm) at 25 degrees C or in micromhos per centimeter (umhos/cm) (1 mmhos=1000 umhos) where  $\mu$  = the Greek letter "mu". In Table 36 of the Appendix the relative tolerance of some crops are listed by EC. Sometimes, the concentration of salt is measured directly and expressed in parts per million (ppm) or in the equivalent units of milligrams per liter (mg/l). Values for ppm, EC, and percent sodium are given in Table 37 of the Appendix.

### **Sodium Hazard**

The sodium hazard of irrigation water usually is expressed as the sodium absorption ratio (SAR). SAR is the relationship between sodium, calcium and magnesium. It is used to evaluate the effects of irrigation water on the soil. Continuously using water that has a high SAR leads to a breakdown in the physical structure of the soil due to the absorption of sodium onto the soil particles and the resulting dispersion of the clay particles. The soil then becomes hard and compact when dry and increasingly impervious to water penetration. Fine textured soils, especially those high in clay are especially subject to this action. Calcium and magnesium, if present in large enough quantities, will counter the effects of the sodium and help maintain good soil properties. Appendix, Table 39 gives classification of sodium hazard based on SAR. Gypsum can be economically used on some soils to maintain the soil, even with high SAR.

Sometimes the soluble sodium per cent (SSP) is used to evaluate sodium hazard. SSP is defined as the ratio of sodium in epm (equivalents per million) to the total cation epm multiplied by 100. A water with a SSP greater than 60 per cent may result in sodium accumulations that will cause a breakdown in the soil's physical properties.

### **Toxic Elements**

The three major toxic elements of concern are; chlorides (Cl), sulfates (SO<sub>4</sub>) and boron (B). Good information is available on the toxicity of B on many crops (Appendix, Table 36). General permissible levels of Cl and SO<sub>4</sub> are given in Table 37 of the Appendix. Contact the TAEX Soil and Water Testing Lab (979/845- 4816) for more information.

### **Salinity Management Techniques**

The best management approach depends on many factors, including the nature and severity of the salinity problem, soil type and water intake rate. In many situations, water is applied in excess of the amounts used by the plants in order to keep the salts in solution and flush them below the root zone. The amount of water needed is referred to as the leaching fraction. In some areas natural rainfall over winter months provides adequate leaching. Table 38 in the Appendix, gives the number of one-inch irrigations possible with various salinity levels between leaching rains.

Salinity control procedures that require relatively minor changes in management are more frequent irrigations, selection of more salt-tolerant crops, additional leaching, pre-plant irrigation, bed forming and seed placement. Alternatives that require significant changes in management are changing the irrigation method, altering the water supply, land- grading, modifying the soil profile and installing artificial drainage. For more information see Reference 14. The county Extension agent also can put you in touch with Extension Agricultural Engineers and Soil Chemists for additional information and assistance.

### **Irrigation Scheduling**

Irrigation scheduling is the process of determining when to irrigate and how much water to apply per irrigation. Proper scheduling is essential for the efficient use of water, energy and other production inputs such as fertilizer. It allows irrigations to be coordinated with other farming activities including cultivation and chemical applications. Among the benefits of proper irrigation scheduling are improved crop yield and/or quality, conservation of water and energy, and, lower production costs.

Deficit irrigation is the practice of partially supplying the irrigation requirements of crops. Deficit irrigation with planned soil moisture storage is often used to reduce the needed irrigation amounts during peak consumptive use periods by taking advantage of the natural ability of soils to hold water. The concept is simple: excess water is applied during the early season and stored in the soil profile for later use. Using the planned soil moisture storage is an excellent strategy for situations where the water supply or the irrigation system is insufficient to meet peak water demands of crops. Soil moisture monitoring is recommended in order to prevent the application of too much water which would move below the root zone and become unavailable to the plants.

Deficit irrigation also is used in situations where reducing water applications causes production costs to decrease faster than revenues decline as a result of reduced yield and quality. Deficit irrigation is often unintentionally used when the irrigation system or water supply is inadequate to supply the plant's water requirements. Many vegetable crops are very sensitive to drought conditions, and will only produce adequately with proper amounts of water. In cases of limited water supply, be sure to irrigate during the most critical growth period (Appendix, Table 33).

### **Methods used to determine when to irrigate:**

- plant indicators
- soil moisture measurement
- water budget techniques



Plant indicators involve monitoring the plant's appearance for signs of water stress. Contact Extension Horticulture for more information. The water budget techniques normally use equations to predict irrigation requirements based on climatic and site factors. These methods are discussed in References 2 and 9.

Directly monitoring the moisture content of the soil in the root zone takes much of the guess work out of irrigation scheduling. Usually, either tensiometers or gypsum blocks (sometimes called porous or electrical resistance blocks) are used to measure the moisture content of the soil. Both have dial or digital readings which can be related to the water pressure in the soil. Table V-8 shows a suggested correlation between tensiometer readings and soil moisture levels for vegetable production. Gypsum block meters often have a scale of 0 to 100. Check the manufacturer's literature for the correct interpretation. Gypsum blocks tend to be more trouble-free, and are often more economical for large acreage. Details on soil moisture monitoring are in TAEX Publication B-1610 "Soil Moisture Monitoring" (Reference 10).

**Table V-8. Interpretation of Tensiometer Readings for Vegetables**

	<b>Dial Reading in Centibars</b>	<b>Interpretation</b>
Nearly saturated	0	Nearly saturated soil often occurs for a day or two following irrigation. Danger of water-logged soils, a high water table, poor soil aeration, or the tensiometer may have broken tension if readings persist.
Field capacity	10	Field capacity. Irrigations discontinued at field capacity to prevent waste by deep percolation and leaching of nutrients below the root zone.
Irrigation range	20	Usual range for starting irrigations. Most of the available soil moisture is used up in sandy loam soils. For clay loams, only one or two days of soil moisture remain.
Dry	30 80	This is the stress range for most vegetable crops. Top range of accuracy of tensiometer. Readings above this are possible but many tensiometers will break tension between 80 to 85 centibars.

Source: Dr. Roland E. Roberts, retired Extension Vegetable Specialist, Lubbock

The amount of water that should be applied during an irrigation depends on the current moisture content in the root zone and the amount of water it takes to "fill" the root zone (or bring it up to field capacity). These concepts are discussed in TAEX Publication "Soil Moisture Management" (Reference 11). Keep in mind that in addition to the crop consumptive use, the total irrigation amount must include enough water to make up for losses due to irrigation efficiency, deep percolation, wind drift, etc., as illustrated in Figure V-7. It is important to know the depth of the active root zone in order to make efficient use of the irrigation water. Field observations are best. Table 14 of the Appendix, gives approximate rooting depths of mature vegetable crops in a deep, well-drained soil. The soil infiltration rate plays a big role in determining how long the irrigation run time should be as well as the system delivery rate. Table V-9 lists the maximum water infiltration rates of various soil types.

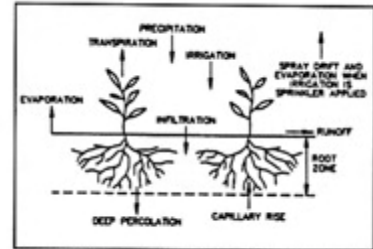

Figure V-7. Sources and losses of soil moisture.

Figure V.7

Click on image to enlarge.

**Table V-9. Maximum Water Infiltration Rate in various soil types.**

Soil type	Infiltration rate(in./hr) <sup>1/</sup>
Sand	2.0
Loamy sand	1.8
Sandy loam	1.5
Loam	1.0
Silt and clay loam	0.5
Clay	0.2

<sup>1/</sup>Assumes a full crop cover. Bare soil rate is 1/2.

### Drip Clogging Control

The biggest potential problem facing the operator of a drip irrigation system is emitter clogging. Because the water passages in most emitters are very small, they easily become clogged by minerals or organic matter. Clogging can reduce output and cause poor water distribution which may cause stress and damage to plants. Contaminants are often present in the irrigation water, such as soil particles, living or dead organic materials and scale from rusty pipes. Contaminants may also enter the system during the installation phase. These include insects, teflon tape, PVC pipe shavings and soil particles which should be flushed out of the lines before closing drip lines or attaching sprinkler heads.

Contaminants also may grow, aggregate or precipitate in water as it stands in the lines or evaporates from emitters or orifices between irrigations. Iron oxide, manganese dioxide, calcium carbonate, algae and bacterial slimes can form in drip systems under certain circumstances.

The solution to clogging must be based on the nature of the particular problem. The following procedures, taken from The Pecan Profitability Handbook (Reference 12) are helpful in correcting clogging problems in drip irrigation systems.

### **Mineral Deposits**

*Calcium and magnesium:* Minerals cannot be removed by filtration and some, particularly Ca, Mg and iron (Fe), often form precipitates in field lines and emitters. If the precipitates are not removed, serious emitter plugging will occur.

Periodic drip system acidification will aid in removing these precipitates. Technical grade sulfuric acid is relatively inexpensive and thus, is probably the most practical material. Phosphoric acid and hydrochloric (muriatic) acid also can be used.

Several guidelines on acidification are listed below:

- How often should acid be injected? When there is more than 10 percent flow reduction from mineral build-up in emitters. With regular use in an average system this will be about twice per year.
- How much acid should be injected? Enough to drop the pH of water in the field lines to about 3.5. This will usually require 1 part acid per 2,000 parts water.
- During what part of the cycle should acid be injected? Near the end. Allow enough time for all the lines to be acidified before the system is turned off. Leave the acidified water in the lines for at least an hour or over-night before turning the system back on to flush the lines.
- Where should acid be injected? Downstream from the filter.
- Where can acid be purchased? Thompson Hayward Chemical Company outlets in Houston, Dallas, San Antonio, Odessa and Beaumont sell sulfuric acid -- primarily in 200-pound carboys. Check local chemical dealers for other sources. Muriatic acid can usually be purchased from swimming pool companies and various lumber yards.

*Fe:* Control of stoppage caused by Fe deposits can be more difficult than simple acid injection if Fe levels in the water are high. Where Fe problems are suspected, water samples need to be analyzed to determine the Fe level. General stoppage control methods depend on the Fe level.

Fe less than 7 to 8 ppm: Use acidification as discussed for Ca and Mg. Ideally, inject acid at least every two weeks.

Fe 8 to 12 ppm: Use gaseous chlorination. This will require a sand filter to catch the precipitate. This cannot be done inexpensively; chlorine injectors and sand filters are relatively costly. Chlorine gas is dangerous and must be handled with extreme care.

Fe more than 13 ppm: Use a settling basin (pond) where exposure to air will oxidize and precipitate the Fe. At least 15 to 30 minutes of air exposure should be allowed for Fe to oxidize and precipitate.

### Algae and Bacteria

Algae, and in some cases, bacteria can cause severe emitter clogging. Algae can be particularly severe when surface water is used in drip systems. Chlorination can effectively stop the growth of algae and bacteria in drip systems.

Guidelines on chlorination are listed below. Additional guidelines for chemical treatment are given in Table V-10.

- What sources of chlorine can be used? Liquid bleach sodium hypochlorite at 5.25 percent is most common. Sodium hypochlorite Solutions with 10.5 and 15.0 percent also are available. Dry granular chlorine should not be used because of precipitate problems. In large systems (greater than 400 ppm) to save money, chlorine gas is often used. Chlorine gas is dangerous.

**Table V-10. Recommended Chemical Treatments for Selected Conditions**

Water Quality	Suggested Treatment
Ca > 50 ppm Mg > 50 ppm	Hard water, caused by high ppm concentrations of Ca or Mg, can reduce flowrates by the build-up of scales on pipe walls and emitter orifices. Periodic injection of an HCl solution may be required throughout the season. Lower concentrations of Ca and Mg may require HCl treatment every few years.
Fe > 0.5 ppm S > 0.5 ppm	Iron and sulfur, as well as other metal contaminants, provide an environment in water that is conducive to bacterial activity. The by-products of the bacteria in combination with the fine (less than 100-micron) suspended solids can cause system plugging. Bacterial activity can be controlled by chlorine injection and line flushing on a regular basis throughout the irrigation season. Bacterial activity is prevalent in concentrations of Fe and S over 0.5 ppm, but also occurs at lower concentrations.

Source: British Columbia Ministry of Agriculture, Water Treatment Guidelines for Trickle Irrigation, Engineering Reference Information R512.000, 1982. 2 pp.

- How often should chlorine be injected? Every time the system is operated if surface water is used. Well water does not normally require chlorination for algae, but bacteria can sometimes be a problem. If there are few problems, with experience, the frequency may be reduced.
- How much chlorine should be injected? Enough to leave at least 1.25 ppm free residual chlorine in the drip lines. To achieve 1 to 2 ppm free residual chlorine in

the lines will normally require injection of 10 to 12 ppm chlorine but this varies according to the amount of organic material and pH of the water. To test for free residual chlorine, a DPD chlorine testing kit is needed. These are inexpensive and are manufactured by Hatch Company, Ames, Iowa.

- During what part of the cycle should the chlorine be injected? Near the end. Allow enough time for all the lines to be chlorinated before the system is turned off.
- Where should chlorine be injected? Preferably upstream from the filter, since chlorine will help control algae in the filter.

## Chemigation

Chemigation is the application of fertilizer, herbicides, insecticides, fungicides and other chemicals through irrigation systems. Recent advances in chemigation equipment and know how have given growers a method of improving the effectiveness of chemicals while reducing the amounts applied. The U.S. Environmental Protection Agency has developed regulations on types of chemigation equipment allowed with the aim of preventing accidents, thereby, protecting both the grower and the environment. These are covered in "Chemigation Workbook" (Reference 13).

## Irrigating with Effluent

The Texas Water Commission has developed regulations on the use of municipal effluent water for irrigation. These regulations prohibit spray irrigation of effluent water on food crops. Also, fodder, fiber and seed crops may not be harvested within 30 days of application of reclaimed water. For more information, contact the TWC in Austin (512/463-8412).

## Monitoring System Performance

The well-designed irrigation system will have built-in diagnostic tools which allow the operator to monitor the performance of the system and to detect possible problems in early stages. The most important devices are flow meters and pressure gauges. System flow meters should be installed on the main supply lines, and should provide readings of both instantaneous and cumulative flow. These meters should be read regularly and the readings kept in a log book. Variations in the system flow rate may indicate that something in the system is amiss. Some possible causes of changes in irrigation system flow are given in Table V-11.

**Table V-11. Some Possible Causes of Changes in Irrigation System Flow.**

<b>Increased Flow</b>	Improperly adjusted gates, valves, checks Pipeline leaks and breaks Pressure downstream of pressure regulators is too high Worn or oversize sprinkler nozzles, emission devices, etc. System on too long (as indicated by higher than expected volumes of flow)
<b>Decreased flow</b>	Improperly adjusted gates, valves, checks

	Clogged sprinklers, emission devices, screens, filters, etc. Pressure downstream of pressure regulators too low. Existence of entrapped air in the system System not on long enough (as indicated by lower than expected volumes of flow)
--	--

Source: L.G. James and W.M. Shannon, Flow Measurement and System Maintenance. In: Trickle Irrigation for Crop Production, F.S. Nakayama and D.A. Bucks(Eds.), 1986. Elsevier Science Publishing Co., Inc., p. 280.

The system should have sufficient pressure testing points, so that an overall check of the system pressures can be made. Widely differing pressures in different sections of the system may indicate that some blockage, leaking or other problem has arisen in some section of the system. Pressure checks should be regularly made and the pressures recorded. Center pivots should have a pressure gauge at the end of the system (instead of only at the pivot point).

Annual maintenance and repairs should be incorporated into the normally expected operation expenses of the system. Worn components should be replaced as needed. Generalized depreciation and annual maintenance and repairs are listed in Table V-4. When it is possible, use data provided by manufacturers.

## References

1. Turner, J. H. and C. L. Anderson. 1980. *Planning for an Irrigation System*. American Assoc. for Vocational Instructional Materials, Athens, Georgia. 120 pp. (Available from Instructional Materials Services, Texas A&M University, 409/845- 6601, Order #4587, \$12).
2. James, L. G. 1988. *Principles of Farm Irrigation System Design*. John Wiley & Sons, New York. 543pp.
3. Henggeler, J. C., J. M. Sweeten and C. W. Keese. *Surge flow irrigation*. TAEX Publication L-2220.
4. Henggeler, J. C. *Irrigation systems for forage crops*. TAEX Publication B-1611.
5. New, N. *Center pivot irrigation systems*. TAEX Publication L- 2219.
6. New, L. *Pumping plant efficiency and irrigation costs*. TAEX Publication L- 2218.
7. Texas Board of Water Engineers. 1960. *Consumptive use of water by major crops in Texas*: Bulletin 6019. November.
8. *Control of soluble salts in farming and gardening*. TAES Publication B-876.
9. Jensen, M. E. 1980. *Design and Operation of Farm Irrigation Systems*. ASAE Monograph No. 3. ASAE, St. Joseph, MI. 829 pp.
10. Sweeten, J. M. and J.C Henggeler. *Soil Moisture Monitoring*. TAEX Publication B-1610.
11. Fipps, Guy. *Soil Moisture Management*. TAEX Publication, B-1670.
12. McEachern, George Ray and Larry A. Stein. *1990 Texas Pecan Profitability Handbook*. TAEX Publication.
13. *Chemigation Workbook*. TAEX Publication B-1652.
14. Fipps, Guy, *Managing Irrigation Water Salinity in the Lower Rio Grande Valley*. TAEX Publication B-1667.

15. Hanson, Blaine, Larry Schwankl, Stephen R. Grattan, and Terry Prichard. *Drip Irrigation for Row Crops*. University of California Irrigation Program. UC, Davis. Water Management Series publication #93-05
-



# *Irrigation Management for Citrus Production*

## **In this Section**

Reference: Impacts of Irrigation on Citrus (B-6205)





# Impacts of Irrigation on Citrus (B-6205)

*\*Spanish version available at the Texas AgriLife Extension Bookstore*

*Website: <http://agrilifebookstore.org/>*

# Impacts of Irrigation on Citrus



*in the Lower Rio Grande Valley*

Citrus is an important irrigated crop for South Texas. Grown on 27,000 acres primarily in the Lower Rio Grande Valley, the citrus crop has been subject to freezes, market conditions and urbanization since 1950. About 71 percent of the citrus area is planted with grapefruit and 29 percent with oranges. Texas grapefruit varieties are 72 percent Rio Red, 17 percent Ruby Red, 11 percent Henderson/Ray and 1 percent other varieties. The oranges are 59 percent Early, 28 percent Navel and 13 percent Valencias.

In the Lower Rio Grande Valley, reduced water supplies are a challenge to growers because citrus requires 35 to 48 inches of water each year and rainfall supplies only 22 to 26 inches.

Citrus growers in the Valley can increase fruit quality and production by scheduling irrigation according to soil moisture levels and crop needs and by using irrigation methods that are appropriate for local conditions.

### **Agronomic Characteristics of Citrus**

To manage irrigation properly, growers need to have a good understanding of how the soil type affects citrus growth. Citrus trees start bearing fruit from the third year after planting, but economic breakeven is usually delayed until the eighth year.

Citrus trees flower in February and March, but less than 6 percent of the flowers produce mature fruits. Fruits mature in 7 to 12 months after flowering, depending on such factors as the variety and water availability. Harvest in the Lower Rio Grande Valley starts in late September or October and ends in May or June.

During maturation, the amount of acid in the fruit decreases while sugar and aromatic substances increase, improving fruit quality. Because low temperatures increase the concentration of sugars within the fruit, many Valley growers do not begin harvest until after the first winter cold spell.

The color of the fruit is not an indicator of fruit maturity. Fruit is usually harvested "green," depending on market demand and price. Postharvest treatments can enhance ripening.

Citrus trees need a period of rest or reduced growth to flower. In the subtropics, cool winters induce flowering, but without sufficient chilling, flowering can be induced by water deficits. In the Valley, this chilling period generally occurs from November to January (Fig. 1) when temperatures and rainfall decrease.

**Juan Enciso,  
Julian W. Sauls,  
Robert P. Wiedenfeld  
and Shad D. Nelson**

Associate Professor and Irrigation Engineering Specialist;  
Professor and Extension Horticulturist;  
Professor, Department of Soil and Crop Sciences;  
Associate Professor of Horticulture,  
The Texas A&M System

## Citrus Yield and Water Use

Fruit yield is highly affected by the amount of water received in both current and previous growing seasons. When the plants do not get enough water, growth is

slowed, young fruits fall and the mature fruit lacks sugar and quality. Also, vegetative growth is reduced, limiting the number of new fruit-bearing branches. The roots and leaves do not develop properly, which affects the number and size of the fruit and accentuates alternate bearing, which is high production one year followed by lower production the next year.

Adequate water amounts are especially important during flowering and fruit set to achieve good production. Yield is reduced when water deficits of more than 33 percent occur during

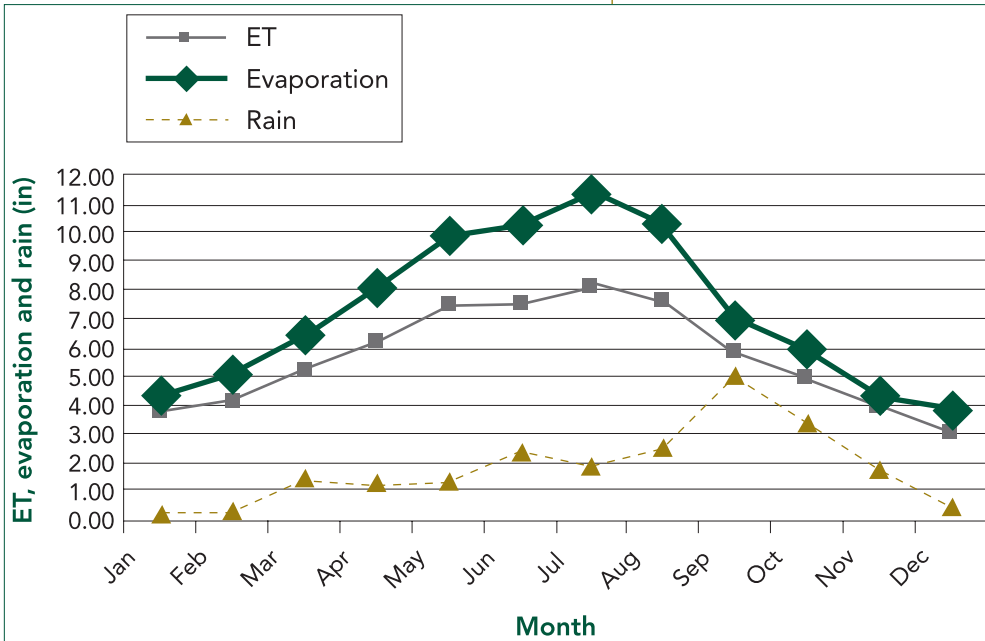

**Figure 1.** Average monthly evapotranspiration (ET), evaporation and rainfall between 1995 and 2003 in the Lower Rio Grande Valley.

bloom, fruit set and rapid vegetative growth in the spring; deficits of 66 percent can be tolerated during the summer, fall and winter. Therefore, water stress should be avoided from February to June but can be somewhat tolerated from June through January.

According to research in 1986 by the Food and Agriculture Organization of the United Nations, good yields of citrus are:

- Oranges: 400 to 550 fruits per tree per year, corresponding to 10.1 to 16.1 tons per acre per year.
- Grapefruit: 300 to 400 fruits per tree per year, corresponding to 16.2 to 24.3 tons per acre per year.
- Lemons: 12.1 tons to 18.2 tons per acre per year.
- Mandarin: 8.1 tons to 12.1 tons per acre per year.

Local conditions affect yields. The Texas AgriLife Extension Service reported typical yields for three management levels in the Valley for an orchard density of 115 to 120 trees per acre (Table 1).

**Table 1.** Tons of citrus produced per acre under three levels of management in the Lower Rio Grande Valley. Sauls, 2005.

Age (years)	Grapefruit			Early Oranges			Valencia		
	Fair	Average	Very good	Fair	Average	Very good	Fair	Average	Very good
3	1	3	6	1	2	4	1	2	3
4	3	6	10	2	5	7	2	3	4
5	5	9	14	4	7	11	3	4	7
6	7	14	19	5	10	13	4	7	10
7	8	18	23	7	13	16	5	9	13
8	10	20	26	8	15	19	6	11	15
9	11	22	27	9	17	22	7	13	17
10+	12	23	28	10	18	24	8	14	18

Water is the most limiting factor for crop production. A close relationship between production and water applied is called water use efficiency. The Food and Agriculture Organization reported that water use efficiency for citrus is 428 to 1,070 pounds per acre-inch with a fruit moisture content of about 85 percent.

### Impact of Water Requirements and Irrigation Scheduling

Depending on weather conditions and ground cover, citrus requires from 35 to 48 inches of water per year; grapefruit requires more water than do oranges, lemons or limes.

Water is removed from a crop by evapotranspiration (ET), which is the removal of water that evaporates or transpires from the plants and from the underlying soil. In the Valley, more water is lost through this process than is gained through annual rainfall. This means that supplemental irrigation is needed for citrus crops in the Valley.

A formula has been devised to estimate the amount of water needed by a particular crop under specific local conditions. The formula uses the rate of evapotranspiration from a standard "reference" crop, such as grass that is actively growing. This is called the reference evapotranspiration ( $ET_{ref}$ ).

To calculate the evapotranspiration from a specific crop such as citrus, multiply the reference evapotranspiration ( $ET_{ref}$ ) by the crop coefficient (Kc). Crop coefficients for citrus are shown in Table 2. The crop coefficient varies according to the crop's growth stage. The reference evapo-

Table 2. Citrus crop coefficients.

	Jan	Feb	Mar	Apr	May	June	July	Aug	Sep	Oct	Nov	Dec
<b>No ground cover</b>												
70% canopy	0.65	0.65	0.65	0.65	0.60	0.60	0.60	0.60	0.65	0.65	0.65	0.65
50% canopy	0.60	0.60	0.60	0.60	0.55	0.55	0.55	0.55	0.60	0.60	0.60	0.60
20% canopy	0.45	0.45	0.45	0.45	0.40	0.40	0.40	0.40	0.50	0.50	0.50	0.50
<b>Ground cover or weeds</b>												
70% canopy	0.75	0.75	0.75	0.75	0.70	0.70	0.70	0.70	0.75	0.75	0.75	0.75
50% canopy	0.75	0.75	0.75	0.75	0.75	0.75	0.75	0.75	0.75	0.75	0.75	0.75
20% canopy	0.80	0.80	0.80	0.80	0.80	0.80	0.80	0.80	0.85	0.85	0.85	0.85
<b>Locally developed crop coefficients</b>												
70% canopy	0.6	0.6	0.7	0.7	0.7	0.7	0.7	0.7	0.7	0.6	0.6	0.6

Table 3. Crop water requirements considering an average of 9 years of data (1995–2003) and using local crop coefficients in the Lower Rio Grande Valley.

Month	ET <sub>ref</sub> (inches)	Kc citrus	ETc citrus (inches)	Rain (inches)	ETc – Rain (inches)
Jan	3.4	0.6	2.1	0.2	1.9
Feb	3.7	0.6	2.2	0.4	1.8
Mar	5.0	0.7	3.5	1.5	2.0
Apr	5.9	0.7	4.1	1.3	2.8
May	7.1	0.7	5.0	1.3	3.7
June	7.2	0.7	5.0	2.4	2.6
July	7.8	0.7	5.5	1.9	3.6
Aug	7.5	0.7	5.2	2.5	2.7
Sep	5.8	0.7	4.1	5.0	0.0
Oct	4.9	0.7	3.4	3.4	0.0
Nov	3.8	0.6	2.3	1.8	0.5
Dec	3.1	0.6	1.9	0.4	1.5
<b>TOTAL</b>	<b>65.3</b>		<b>43.8</b>	<b>22.1</b>	<b>23.1</b>

transpiration varies throughout the year. Figure 1 shows the rainfall and evaporation during an average year in the Lower Rio Grande Valley.

If the soil has a ground cover such as grass or weeds, more water will be lost through evapotranspiration than that lost from bare soil, and the crop coefficient will rise (Table 2). Citrus in orchards with full grass cover can use 45 percent to 105 percent more water than can citrus in bare soil. The crop coefficients are slightly lower at mid-season than at the beginning and end of the season because the plants' stomata, or pores, close during periods of peak evapotranspiration (Table 2).

Table 3 lists irrigation guidelines for citrus that are based on average conditions for 9 years in the Lower Rio Grande Valley. In an average year in the Valley, citrus crops with 70 percent canopy and ground cover require about 44 inches of water; about half this amount is supplied by rainfall.

### Irrigation Scheduling

To schedule effective irrigation, producers must know the properties of the soil and the amount of water stored in it. A balance sheet approach similar to a check register can be used to keep track of the amounts added through rainfall and irrigation and removed through crop water use or evapotranspiration. Depletion percentages can be measured directly or estimated. Both methods require information about a crop's rooting depth and the soil's moisture holding capacity.

Citrus roots can extend to 6 feet and, in some cases, as much as 30 feet. Roots extract most of the water in the first 2 feet; they grow better in sandy soils that have less clay. Studies conducted in Spain found that citrus takes from 60 percent to 80 percent of its water from the upper 20 inches of the soil.

Table 4 shows the water-holding capacities for the top 4 feet of different soils in the Lower Rio Grande Valley. Water availability varies with soil depth. For example, the Hidalgo sandy clay loam soil can hold up to 0.17 inches of water per inch of soil to a depth of 28 inches; it can hold up to 0.20 inches of water per inch of soil between depths of 28 and 80 inches. The same soil can hold between 3.8 and 8.2 inches of water in 4 feet of soil.

Producers in the Lower Rio Grande Valley use various sensors to measure soil-moisture depletion levels. The most commonly used are granular matrix sensors, such as Watermark® soil moisture sensors from Spectrum Technologies, Inc., of Plainfield, Ill.; capacitance probes such as ECH<sub>2</sub>O® probes from Decagon Devices, Inc., of Pullman, Wash., and EnviroSCAN® soil moisture sensors from Sentek Sensor Technologies, Australia.

During 2004, two Valley farmers installed EnviroSCAN sensors, which relayed soil moisture information through a modem to the Internet. After the sensors scanned the soil to a depth of 4 feet, the growers could monitor the soil water levels, enabling them to manage their drip and micro-irrigation systems more precisely.

These technologies are being evaluated and offer good potential for practical use. The cost of these devices varies dramatically, with Watermark sensors at the low end and EnviroSCAN at the high end.

Other new technologies are less useful for growers. Neutron probes and time domain reflectometry instruments are used to measure the volume of water in the soil. These instruments have been used only for irrigation research in the Lower Rio Grande Valley. They are impractical for most growers because they usually require calibration and are expensive and complicated to operate. Also, neutron probes require radiation licensing and radiation monitoring for safety.

**Table 4.** Properties of soils in the Lower Rio Grande Valley.

Soil series	Soil horizons (inches)	Available water capacity (inches/inches)	Water available in the top 4 ft (inches/4 feet)
Lyford sandy clay loam	0–11	0.18–0.24	8.6–11.5
	11–48	0.16–0.21	
Raymondville clay loam	0–15	0.12–0.18	5.8–8.6
	15–65	0.10–0.18	
Willacy fine sandy loam	0–74	0.14–0.18	6.7–8.6
Hidalgo sandy clay loam	0–28	0.08–0.17	3.8–8.2
	28–80	0.08–0.20	
Rio Grande silty loam	0–63	0.15–0.24	7.2–11.5

However, growers throughout the Valley have used sensors to measure soil moisture tension. As soil moisture tension rises, plants have more difficulty extracting water. Tools such as tensiometers and Watermark sensors are relatively inexpensive.

Watermark sensors can measure a wider tension range (up to 200 centibars) than can tensiometers, which read only to 60 centibars. Centibars measure the tension in which the water is held by the soil. The higher the tension reading, the drier the soil. Inexpensive sensors such as Watermark can be installed at different depths and in different locations to test soil variability.

Because moisture availability includes the effects of soil texture, the readings need not be adjusted for soil type; however, the readings can be affected by soil salinity. Tension measurements tend to remain low for extended periods as plants absorb water from the soil, then rise rapidly as available moisture levels drop.

Irrigation becomes necessary when soil moisture tension in the root zone reaches between 30 and 60 centibars. The Watermark sensor has been observed to be slow, sometimes taking about 12 hours to show from dry to wet.

Another potential problem can be caused by the placement of the sensor in relation to the trunk of the tree and the irrigation emitter. Start irrigation when it is not yet completely dry to allow some time for the sensor to catch up and avoid tree stress.

To reliably measure conditions in the orchard, install the soil water sensors in several locations and at different depths, and record the sensor measurements regularly. The responsiveness of the Watermark sensors can vary, depending on the irrigation method used. These sensors respond faster to flood irrigation than to drip or microjet spray irrigation practices.

The management allowable depletion is the deficit point at which irrigation should be triggered. In citrus, irrigation can be triggered when the crop depletes about 55 percent to 60 percent of the soil water stored in the root zone. For example, for a Hidalgo sandy clay loam soil with water-holding capacity of 8.2 inches and a management allowable depletion of 60 percent, irrigation is needed at the point when 4.9 inches ( $8.2 \times 0.6 = 4.9$  in) has been used.

Table 5 shows the corresponding number of irrigations needed for a sandy clay loam in Hidalgo County with



holding capacities of 8.2 inches and 60 percent allowable depletion.

Citrus growers in the Lower Rio Grande Valley commonly flood irrigate from five to seven times per year. However, the number of irrigations will be affected by the weather, soil type and water availability.

The balance sheet approach assumes that a plant can equally access all available moisture between saturation and permanent wilting point. This is an accurate assumption when soils are wet. However, as soil dries, plants have more difficulty extracting water, which decreases growth rates.

### Salinity and Crop Production

Salinity is measured in millimhos per centimeter. Water from the Rio Grande has moderate salinity, ranging between 1.0 to 1.65 mmhos/cm (700 to 1,200 parts per million, or ppm). At Rio Grande City, the salinity is less than 1.2 mmhos/cm, with the highest values of 1.2 mmhos/cm occurring between April and June. The levels drop below 1.0 mmhos/cm (700 ppm) during the rest of the year.

Downstream, salinity levels increase: At the Mercedes Irrigation District, salinity ranges from 1.0 to 1.5 mmhos/cm, reaching 1.6 mmhos/cm during part of November.

Good soil drainage minimizes the effects of salinity. Heavy, slow-draining soils are poor for citrus production. To help the salt leach from the soil and improve drainage, some Lower Rio Grande Valley producers practice deep chiseling between citrus rows.

Bad drainage also can cause the accumulation of sodium or other salts including boron and chlorine. Citrus is sensitive to boron concentrations of 0.3 to 1.0 parts per million.

Citrus yields drop by 10 percent when soil salinity increases to 2.3. The soil salinity is measured by extracting water from a soil saturated paste. At higher soil salinity levels, the yields drop even more: by 25 percent at the 3.3 salinity level, 50 percent at the 4.8 level and 100 percent at 8 mmhos/cm.

Saline irrigation water also reduces citrus yields by 10 percent at 1.6 mmhos/cm.

### Irrigation for Freeze Protection

Citrus trees grow best when the temperature is 73.4 degrees F to 86 degrees F (23 to 30 degrees C). Growth

**Table 5.** Number of irrigations for citrus with 70 percent canopy in a Hidalgo sandy clay loam soil with 60 percent management allowable depletion and holding capacity of 8.2 inches in 4 feet of soil depth.

Month	ET citrus – Rain (inches)	Number of Irrigations
Jan	1.9	0
Feb	1.8	0
Mar	2.0	1
Apr	2.8	0
May	3.7	1
June	2.6	1
July	3.6	0
Aug	2.7	1
Sep	0.0	1
Oct	0.0	0
Nov	0.5	0
Dec	1.5	0
<b>TOTAL</b>	<b>23.1</b>	<b>5</b>



**Figure 2.** Traditional irrigation with sloping borders and earth canals. One of the main problems of earth ditches is that they can break, spilling water out of the area to irrigate.

slows in temperatures above 100.4 degrees F (38 degrees C) and below 55.4 degrees F (13 degrees C). Active root growth occurs when soil temperatures are higher than 53.6 degrees F (12 degrees C).

Most citrus species tolerate light frost for short periods only and can be injured by temperatures of 26.6 degrees F (-3 degrees C) over several hours. Temperatures of 17.6 degrees F (-8 degrees C) cause branches to wither, and 14 degrees F (-10 degrees C) generally kills the tree.

Flowers and young fruits, which are particularly sensitive to frost, are shed after very short periods of temperatures slightly below freezing. Dormant trees are less susceptible to cold injury. Strong wind causes flowers and young fruits fall to easily; provide windbreaks when necessary.

Microsprinklers can protect young trees during freezing nights, especially when water is continuously applied to the lower part of the trunk, because as water freezes, heat is released. When the application rate is high enough, the freezing water will maintain the trunk, the bud union and lower branches at temperatures near freezing.

To protect trees using microsprinklers, place the sprinklers 1 to 2.5 feet from the trunks in the upwind side of the trees. Place insulating tree wraps around the trunks of young trees to slow the rate of temperature decline and protect the trunks; use the wraps in combination with sprinkler irrigation.

A microsprinkler irrigation rate of 20 gallons per hour is more effective for cold protection. Turn on the water before the temperature reaches 32 degrees F (0 degrees C), making sure the microsprinkler is placed correctly.

Continue running the microsprinkler all night during the freeze. Evaporative cooling will cause greater damage if the irrigation system fails when the temperature is below freezing. Therefore, do not to turn on the system if the pumping system is unreliable. The system can be stopped once temperatures rise above 33.8 degrees F (1 degrees C).

## **Irrigation Practices in the Lower Rio Grande Valley**

Historically, producers in the Valley have used flood irrigation to water citrus crops. An extensive network of canals and large-diameter underground pipelines use

gravity flow to deliver large volumes of water from the Rio Grande to fields over short periods of time.

Because the Valley generally slopes toward the north-east, away from the river, little pumping is necessary except to lift the water from the river to the canals. Present water restrictions are causing interest in more efficient irrigation technologies.

Properly managed flood irrigation can be efficient. During delivery, losses occur because of evaporation and leaks in canals and pipelines. Irrigation canals that are unlined earthen ditches allow water to seep out. Lining canals and using pipe to deliver water can reduce these losses and provide better control of the irrigation.

The most common irrigation method for citrus on the farm is flood irrigation with graded borders (Fig. 2). To irrigate efficiently with flood irrigation, level the land to the appropriate grade before establishing the orchard and control water applications with valves or structures (Fig. 3). Citrus groves that are bordered and properly graded do not produce runoff.

To distribute water faster and more efficiently, install alfalfa or orchard valves at different locations in the orchard use gated or flexible pipes. Build permanent borders every two rows, with an irrigation valve between each pair (Fig. 3). Temporary borders may be single or double row, depending on the grower's preferences.

For better control and faster irrigation, build one border per row of trees. The border edge is about 1 foot high. To reduce the irrigated area, place temporary borders along one side of the rows of young trees. This method, called strip flooding or narrow-border flood, allows faster water advancement (Fig. 4).

A farmer can receive 1,346 gallons of water per minute or more to irrigate a field of 40 acres. One "head" of water per outlet is equivalent to 3 cubic feet per second, or 1,346 gallons per minute.

Weed control methods affect the choice of irrigation method. Permanent borders need trunk-to-trunk herbicidal weed control, while temporary border irrigation requires tillage to control weeds in the row middles.

In both cases, apply the herbicides beneath the tree canopies. Use herbicides or tillage implements to control weeds in the row middles of orchards that are irrigated with microsprayer or drip irrigation systems.



**Figure 3.** Border irrigation with alfalfa (orchard) valves. Each valve covers one border with two rows of trees.



**Figure 4.** Using a narrow-border flood can conserve more water than can traditional flood practices in the orchard.



**Figure 5.** Irrigation of citrus crops with drip irrigation. The top photo shows two drip lines per tree row and weeds that are climbing the tree. The bottom photo shows an implement used to apply herbicide close to the tree to control weeds.

In deciding when to irrigate, producers also must consider the need to order water several days in advance and the wait for the water delivery. Depending on the location and the irrigation district, a reservoir may be needed to store water for frequent irrigations using microsprinkler irrigation or drip irrigation systems.

### **Improving Citrus Irrigation Efficiency**

Periods of drought have reduced some water allocations in the Lower Rio Grande Valley. Pressurized irrigation systems can be used to increase production per unit of water applied and to maintain orchards during droughts.

These pressurized systems have one or more emitters at each tree, which allows for the uniform injection of fertilizers and some agrochemicals. This improves plant nutrition and increases productivity per unit of water applied, partly compensating for the higher initial cost of the system and the variable costs such as energy and maintenance. The most common pressurized systems are drip and micro-irrigation.

#### ***Drip Irrigation Systems***

On Lower Rio Grande Valley farms with drip irrigation systems, the most common method is to run the drip lines parallel to the tree rows. Young orchards can be irrigated with a single line per row, but older trees require two lines—one on each side of the row—because they need more water (Fig. 5).

The initial system design must allow for the additional line of emitters to ensure that enough water can be supplied to both lines in the future. The drip emitters are generally spaced every 3 feet and apply about 1 gallon per hour per emitter.

Drip irrigation systems require filtration to prevent emitter clogging. Many farms have settling ponds, where sediments and small particles from the pumped canal water can settle out. The water is then filtered before entering the irrigation lines.

A drip irrigation system can save water because it wets only about 33 percent to 50 percent of the surface area. In addition, a drip system can apply fertilizer quickly, efficiently and uniformly.

Weed control in the wetted area can be difficult because frequent irrigations cause the herbicides to leach below the soil surface, where they are needed. Vines growing into and covering the tree are a serious problem. A good

herbicide program is especially vital with these systems, and growers should include less soluble herbicides in the weed control program. Fortunately, some herbicides with reduced solubility can be applied through the irrigation system, placing the herbicide where it is most needed.

### **Micro-irrigation and Microsprayer Irrigation Systems**

A microsprinkler has moving parts, and it sprays one or two streams of water as it rotates. Its deflectors move as they are hit by the water being sprayed. In contrast, microsprayers have no moving parts; the water is deflected into several discrete streams as it is sprayed out. In the Valley, moving parts have a tendency to clog when fine, wind-blown soil particles accumulate on the emitter.

Microsprayers are connected to a polyethylene lateral line through a micro-tube, often referred to as “spaghetti tubing,” and are held in place by a plastic stake. They can apply from 3 to 30 gallons of water per hour; the higher the flow rate and pressure, the larger the wetted diameter (Fig. 6). However, large orchards may need to be subdivided into two or more zones and irrigated separately.

Microsprayer irrigation sprays a fan of water over the soil. The microsprayer can wet a diameter of 12 to 18 feet depending on the tree skirt. The spray or mist is produced by a flat spreader and a small orifice operating at high pressure.

Popular microsprinklers can apply 24 to 28 gallons per hour at a pressure of about 30 psi. These devices contain a deflector which allows water flow to be concentrated around young trees to a diameter of about 8 feet. Without the deflector the wetted diameter can be up to 22 feet to irrigate larger trees.

### **Summary**

The choice of irrigation technology and scheduling method depends on economic considerations as well as the location, situation and preferences of each grower. Producers should also seek input from their irrigation district about the feasibility of installing a particular system in their fields.

### **References**

Allen, R.G., L.S. Pereira, D. Raes and M. Smith. 1998. *Crop evapotranspiration - guidelines for computing crop water requirements*. Food and Agriculture Organization Irrigation and Drainage Paper 56. Rome.



Figure 6. Microsprinkler irrigation.

- Doorenbos, J. and A.H. Kassam. 1986. "Yield Response to Water." Food and Agriculture Organization of the United Nations, Irrigation and Drainage Paper No. 33, Rome, Italy.
- International Boundary and Water Commission United States and Mexico. 2002. *Flow of the Rio Grande and Related Data From Elephant Butte Dam, New Mexico to the Gulf of Mexico*. Water Bulletin Number 72. 135 p.
- Sauls, W. Julian. 2005. *Citrus Orchard Establishment*. Texas AgriLife Extension Service, the Texas A&M System, College Station. <http://aggie-horticulture.tamu.edu/citrus/L2306.htm>
- Sauls, W. Julian. 2005. *Citrus Water Management*. Texas AgriLife Extension Service, The Texas A&M System, College Station. <http://aggie-horticulture.tamu.edu/citrus/water/L2307.htm>

### **Acknowledgment**

The material in this publication is based on work supported by the Cooperative State Research, Education and Extension Service, U.S. Department of Agriculture, under Agreement No. 2005-34461-15661 and No. 2005-45049-03209 and by the Agricultural Water conservation Demonstration Initiative-Harlingen Irrigation District Project, under agreement 2007-01.

---

The information given herein is for educational purposes only. Reference to commercial products or trade names is made with the understanding that no discrimination is intended and no endorsement by the Texas AgriLife Extension Service is implied.

Produced by AgriLife Communications and Marketing, The Texas A&M University System

Extension publications can be found on the Web at: <http://AgriLifeBookstore.org>.

Visit Texas AgriLife Extension Service at <http://AgriLifeExtension.tamu.edu>.

*Educational programs of the Texas AgriLife Extension Service are open to all people without regard to race, color, sex, disability, religion, age, or national origin.*

---

Issued in furtherance of Cooperative Extension Work in Agriculture and Home Economics, Acts of Congress of May 8, 1914, as amended, and June 30, 1914, in cooperation with the United States Department of Agriculture. Edward G. Smith, Director, Texas AgriLife Extension Service, The Texas A&M University System.  
500 copies, New



# *Irrigation Management for Sugarcane Production*

## **In this Section**

Reference: Irrigation of Sugarcane (B-6156)





# Irrigation of Sugarcane (B-6156)

*\*Spanish version available at the Texas AgriLife Extension Bookstore*

*Website: <http://agrilifebookstore.org/>*



# *Irrigation of Sugarcane in Texas*



# *Irrigation of sugarcane in Texas*

Bob Wiedenfeld, Juan Enciso, Guy Fipps and John Robinson\*

\*Respectively, Professor, Assistant Professor and Irrigation Engineer Specialist,  
Professor and Irrigation Engineer; and Associate Professor and Extension Economist,  
The Texas A&M University System

This material is based upon work supported by the Rio Grande Basin Initiative  
of the Cooperative State Research, Education and Extension Service,  
United States Department of Agriculture under Agreement No. 2001-45049-00149.

Producers in Texas Lower Rio Grande Valley (LRGV) grow approximately 45,000 acres of sugarcane, a crop with high water requirements (about 65 inches per year). Rainfall in semiarid South Texas supplies only a third of this need, so producers must irrigate. As the Valley industry developed, producers historically enjoyed abundant, inexpensive irrigation water, but recently water available for agricultural use has become restricted. Although such restrictions will likely continue, water remains available for agricultural use even after South Texas' municipal and industrial requirements are met. If producers efficiently use such limited water resources, cultivation of sugarcane can continue to play a significant role in the Valley's agricultural economy.

## *Agronomic characteristics of sugarcane*

Cultivation of sugarcane (*Saccharum* spp.), which probably originated in New Guinea (southeast Asia), most likely began in the LRGV around the early 1900s. A perennial potentially harvestable for 10 or more years, the sugarcane plant matures over the course of just 1 year. Commercial producers generally grow sugarcane plantations for 4 to 5 years and, in the Valley, harvest their sugarcane crop every year, usually starting in September or October and ending in March. The second year after planting is called the first ratoon; producers generally can obtain two to four ratoon crops, depending on sugar levels. In South Texas, sugarcane beds are spaced every 60 inches.

Figure 1 shows the growth periods of sugarcane: establishment (germination and emergence), vegetative (tillering and canopy establishment), grand growth and ripening. During tillering (the second stage in Fig. 1), sugarcane produces multiple stalks. In the

grand growth period, sugarcane develops rapidly, and individual stalks start to grow. During ripening, producers cut off nitrogen applications and irrigation to slow down growth and enhance sugar production.

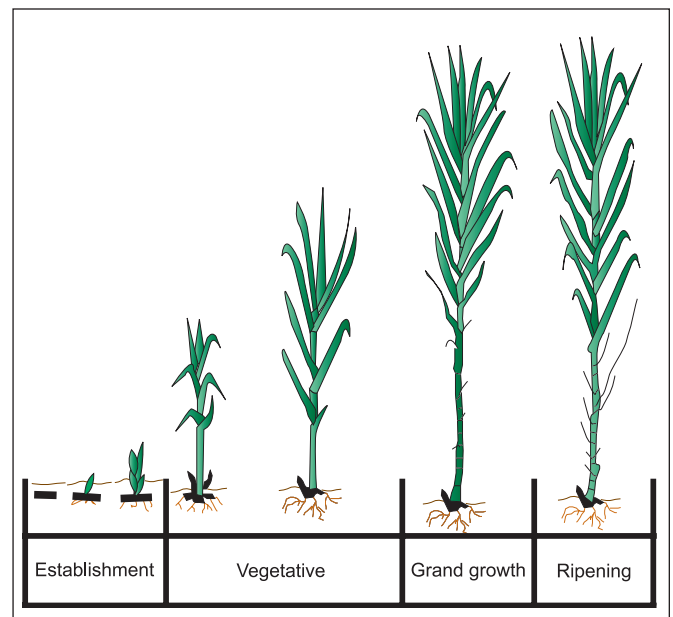

Fig. 1. Growth stages of sugarcane.

## General water requirements in sugarcane production

Around the world, sugarcane production varies from 45,000 to 134,000 lbs/ac (20 to 60 tons/ac). Average production for the LGRV is 38 tons/ac; production levels have increased year-by-year with adoption of better irrigation management practices.

Water-use efficiency is defined as production per unit of water applied. As determined by United Nations Food and Agriculture Organization researchers, worldwide average water-use efficiency for sugarcane at 80-percent moisture varies from 1130 to 1808 lbs/ac-in (5 to 8 kg/m<sup>3</sup>) and for sucrose, from 136 to 226 lbs/ac-in (0.6 to 1 kg/m<sup>3</sup>). In 2003, the following water-use efficiencies were obtained at the Texas A&M Research and Extension Center (research conducted by Dr. Robert Wiedenfeld):

- For total crop: 2540 lbs/ac-in for planting crop and 2883 and 2270 lbs/ac-in for first and second ratoons (11.2, 12.8, 10.0 kg/m<sup>3</sup>, respectively)
- For sucrose alone: 210, 383 and 276 lbs/ac-in for planting crop and first and second ratoons respectively (0.9, 1.7, and 1.2 kg/m<sup>3</sup>, respectively)

Production levels depend on the total amount of water available: barring other limiting factors, one acre-inch of water will produce about one ton of cane. Growers in the LRGV potentially could produce about 65 tons of cane per acre per year. However, problems with water distribution and irrigation timing, as well as other cultural factors such as fertility, salinity, pests and soil compaction, have limited Valley growers to production averages of only about 60 percent of this potential.

Sugarcane water use increases rapidly during canopy establishment, peaking during the grand growth stage when plant canopy cover increases from 10 to 100 percent. During the sugarcane plant's last developmental stage (ripening or yield formation), stalks grow and leaf area declines, so that the crop is less able to respond to sunlight and needs less water. At the same time, sugar content of the cane naturally increases, by harvest reaching levels of between 10 and 12 percent of fresh weight. To encourage cane dehydration and conversion from total sugars to recoverable sucrose during ripening, producers should limit nitrogen application and restrict water supply by extending irrigation intervals or stopping irrigation altogether. Too frequent irrigation during ripening may accelerate plant flowering, reducing sugar production.

## Sugarcane water requirements

To secure high yields, producers must provide adequate water to the sugarcane crop during its vegetative and yield formation stages. Producers can use reference ET (evapotranspiration) or class A pan evaporation data to estimate crop water requirements.

Depending on weather conditions, sugarcane evapotranspiration requirements vary from 55 to 65 inches. Reference ET more accurately related to actual plant water use is calculated based on temperature, humidity, wind speed and solar data gathered by automated weather stations. Then, this reference ET number (or the class A pan data) is multiplied by a crop-specific coefficient (Kc) to account for growth stage.

**Table 1. Researchers calculate crop coefficients by sampling the soil for water content over several growing seasons.**  
(ET ref – reference evapotranspiration; ET sc – evapotranspiration of sugarcane; Kc – crop coefficient)

Month	Days	Cumulative days	Potential ET	Stage	Kc	ET sc	Rainfall	ET – Rain
Jan	31	31	3.44	Tillering	0.40	1.4	1.6	0.0
Feb	28	59	3.74	Tillering	0.40	1.5	1.6	0.0
Mar	31	90	5.00	Tillering	0.40	2.0	0.5	1.5
Apr	30	120	5.91	25% canopy	0.64	3.8	1.6	2.2
May	31	151	7.11	50% canopy	1.15	8.2	2.6	5.5
June	30	181	7.20	Full canopy	1.25	9.0	2.9	6.1
July	31	212	7.79	Full canopy	1.25	9.7	2.9	6.8
Aug	31	243	7.47	Full canopy	1.25	9.3	2.3	7.0
Sep	30	273	5.82	Ripening	1.10	6.4	4.7	1.7
Oct	31	304	4.92	Harvest	0.70	3.4	2.2	1.3
Nov	30	334	3.82	Tillering	0.40	1.5	1.4	0.2
Dec	31	365	3.13	Tillering	0.40	1.3	1.4	0.0
			65.34			57.5	25.7	32.3

Crop coefficients and average ET and rainfall for the LRGV are presented in Table 1. Researchers calculate crop coefficients by sampling the soil for water content over several growing seasons.

**Table 2. Average monthly pan evaporation at Weslaco and pan coefficients for sugarcane water use in the Lower Rio Grande Valley of Texas.**

(ET sc – evapotranspiration of sugarcane)

Month	Class A Pan (inches)	K	ET sc (inches)
Jan	4.42	0.21	0.9
Feb	5.16	0.22	1.1
Mar	6.44	0.29	1.9
Apr	8.15	0.35	2.9
May	9.86	0.47	4.6
June	10.28	0.69	7.1
July	11.42	0.79	9.0
Aug	1.037	0.77	8.0
Sep	6.99	0.64	4.4
Oct	5.90	0.55	3.2
Nov	4.41	0.41	1.8
Dec	3.90	0.22	0.9
TOTAL	87.3	-----	45.8

Class A pan evaporation data correlates somewhat with plant water use. Researchers have developed coefficients related to class A pan values from various regions for different crops based on stage of growth (Table 2). The values estimated with reference ET generally differ from the ones estimated using the pan "A" evaporimeter.

## *Available soil water and irrigation scheduling*

To effectively schedule irrigation, producers must be able to determine the percent-depletion of available soil water by crop water use. A balance sheet approach (like a checkbook register) can be used to keep track of additions (through rainfall and irrigation) and removals (through crop water use) from a soil reservoir of a specific size. Depletion percentages then can be either measured directly or estimated. Both methods require information about a crop's rooting depth and the capacity of a particular soil to hold moisture.

Depending on soil type, sugarcane roots can extend as deep as 6 feet. Table 3 shows water-holding capacities for the top 4 feet of different soils in the LGRV. Water availability varies with soil depth. For example, Harlingen soil can hold 0.12 to 0.18 inch of water per inch of soil at depths from 0 to 11 inches; between 0.06 to 0.13 inch of water per inch of soil at depths between 11 and 35 inches; and 0.03 to 0.13 inch of water per inch of soil at depths between 35 and 72 inches. The same soil can hold between 3.5 to 6.8 inches of water in soil 4 feet deep.

Producers can use several different types of tools to directly measure soil-moisture depletion levels.

Neutron probes and time domain reflectometry (TDR) instruments measure actual volumetric moisture content. These instruments usually require calibration to relate data to available soil moisture. Such instruments are expensive and complicated to operate, so usually are used only in irrigation research.

Tensiometers and watermark sensors measure the tension at which soils hold water; as a soil's tension numbers rise, plants have an increasingly difficult time extracting water. These tools are relatively inexpensive and can be operated easily by growers.

Moisture availability estimations based on soil-moisture tension integrate the effects of soil texture, so readings need not be adjusted for soil type, but can be biased by soil salinity. Typically, tension measurements will remain low for extended periods as plants remove available water from the soil, then rise rapidly as available moisture levels approach lower limits. When soil moisture tension in root zones reaches between 30 and 60 centibars, it is usually time to irrigate.

In order to measure conditions reliably in large fields, producers need to install soil water sensors in several locations and at different depths, then regularly go into their fields to record sensor measurements.

Growers in various sugarcane regions have often gone to the effort and expense of installing sensors, but failed to continue the frequent measurements necessary to amass a database of useful information. Before deciding to use such sensors, producers should consider such ongoing monitoring needs.

Irrigation is generally triggered when the sugarcane crop depletes about 55 to 60 percent of the soil water stored in the root zone. This point is called the management allowable depletion (MAD). For example, for a Rio Grande silty loam soil with a water-holding capacity of 7 inches and a MAD of 60 percent, irrigation is needed at the point that 4.8 inches ( $7 \times 0.6 = 4.8$  in) of

**Table 3. Properties of soils in the LGRV.**

Series	Soil horizons	Available water capacity (in/in)	Water available in the top 4 ft. (in/4 ft)
Harlingen Fine Clay	0-11 in. 11-35 in. 35-72 in.	0.12-0.18 0.06-0.13 0.03-0.09	3.1-6.3
Mercedes Clay	0-74 in.	0.13-0.18	6.2-8.6
Olmito Silty Clay	0-63 in.	0.15-0.20	7.2-9.6
Laredo Silty Clay Loam	0-18 in. 18-72 in.	0.15-0.22 0.13-0.20	6.6-10.0
Lyford Sandy Clay Loam	0-11 in. 11-48 in.	0.18-0.24 0.16-0.21	7.9-10.4
Raymondville Clay Loam	0-15 in. 15-65 in.	0.12-0.18 0.10-0.18	5.1-8.6
Willacy Fine Sandy Loam	0-74 in.	0.14-0.18	6.7-8.6
Hidalgo Sandy Clay Loam	0-28 in. 28-80 in.	0.08-0.17 0.08-0.20	3.8-8.8
Rio Grande Silty Loam	0-63 in.	0.15-0.24	7.2-1.5

water have been used. Table 4 shows the corresponding number of irrigations needed for this kind of soil.

**Table 4. Number of irrigations needed for a Rio Grande Valley silty loam soil 2 ft deep**

Month	ET - Rain (in)	Irrigations
Jan	0.0	0
Feb	0.0	0
Mar	1.5	0
Apr	2.2	1
May	5.5	2
June	6.1	2
July	6.8	2
Aug	7.0	3
Sep	1.7	1
Oct	1.3	0
Nov	0.2	0
Dec	0.0	0
TOTAL	32.3	11

The balance sheet approach assumes that a plant can access equally all available moisture between saturation and wilting point. Researchers have shown such assumptions to be accurate for wet soils. However, as a soil dries, plants have increasing difficulty in extracting water, and their growth rates decline.



Fig. 2. Water canal lined with concrete in the Lower Rio Grande Valley.

## Sugarcane fertility

Sugarcane has high nitrogen and potassium needs and relatively low phosphate requirements. For a yield of 110,000 lbs/ac (55 tons/ac) of cane, typical application rates are:

- Nitrogen: 90 to 180 lbs/ac (100 to 200 kg/ha)
- Phosphorus: 25 to 100 lbs./ac. (29 to 90 kg/ha)

In South Texas, potassium application usually is not required, because soils contain high levels of this nutrient, with irrigation water supplying additional potassium.

For good sugar recovery, application of nitrogen should be kept low as possible, especially when ripening periods are moist and warm.

## Current irrigation practices in the Lower Rio Grande Valley

Historically, producers in Texas's Lower Rio Grande Valley have used flood or furrow irrigation for all their crops. An extensive network of canals (Fig. 2) and large diameter underground pipelines delivers large volumes of water from the Rio Grande River to fields, primarily by gravity flow, over short periods of time according to a rotational scheme. Because the Valley generally slopes toward the northeast, away from the river, little pumping is necessary. At present, water restrictions generate increasing concerns about using more efficient irrigation technologies.

At the delivery system level, losses occur due to evaporation and leaks caused by the age and condition of canals and pipelines.



For example, many irrigation canals are merely unlined earthen ditches which allow water to seep into their banks. Obviously, water lost to evaporation or leakage is not available to irrigate producers' crops.

Furrow irrigation efficiency has been increased dramatically by farmers that level fields and use proper furrow stream size and length. Historically, farmers moved water from turnout valve to furrows using open ditches and siphon tubes, losing water as it soaked into the ground during the transfer process. Producers currently reduce losses from valve to furrow by using gated aluminum pipe or poly pipe and by metering their water (Fig. 3). To further increase water-delivery efficiency, Valley



Fig. 3. In the Lower Rio Grande Valley, irrigation systems using soil ditches and siphon tubes have constantly been upgraded to poly pipe systems.



irrigation districts are lining canals and substituting pipe systems for old concrete pipe networks.

Water application is not metered in some Valley irrigation districts, so it is assumed that 6 inches of water is applied per irrigation; however, actual application rates vary by plus or minus 33 percent based on length of runs, degree of field uniformity and initial soil moisture content. Some districts are intensifying efforts to meter water and allocate it volumetrically.

Factors historically influencing scheduling of furrow irrigation for sugarcane have included standard recommendations, variability of and priority for water resources and a grower's experience and judgment. Norman Rozeff's irrigation guide for Texas sugarcane growers (early 1990s) recommended an average seven irrigations per year, with a range of from 4 to 11 irrigations annually. Both this publication and *South Texas Sugarcane Production Handbook* (1998) recommend determining crop moisture requirements using the balance sheet approach discussed above.

In deciding when to irrigate, producers also must consider nonagronomic factors, including:

- The need to order water several days in advance;
- The fact that since several growers may share a supply line, they will have to take turns using it; and
- The water, personnel and equipment needs of other crops and fields.

Ultimately, when choices must be made, the grower will allocate scarce resources in such manner as to produce the greatest return.

## Improving sugarcane irrigation efficiency

Producers can choose a number of irrigation techniques to meet crops' water requirements more efficiently, including:

- Tailoring furrow irrigation methods to maximize their efficiency;
- Scheduling irrigation to insure that water is being applied at the maximum intervals to meet crop requirements; and
- Using more efficient application systems.

### **Efficient Furrow Irrigation**

1. Adequate drainage: Because water tables are frequently high and salty, Valley producers usually must install subsurface drainage (Fig. 4). Good crop growth requires adequate aeration to remove water-table salt from roots and to leach away salts that accumulate from irrigation water out of the Rio Grande River, which typically contains 900 ppm or more total dissolved solids.



Fig. 4. Subsurface drainage used to control high water tables in the Lower Rio Grande Valley.

2. Proper grade: Cropland also must be leveled properly so that water will flow evenly across fields. Drainage installation and land leveling require specialized, laser-guided equipment, and producers typically contract out these jobs.
3. Efficient water transport: Transporting irrigation water from turnout valve to furrow head is accomplished most efficiently using gated aluminum or PVC pipe or collapsible poly pipe. Aluminum or PVC pipe lasts for many seasons, but it costs more than poly pipe, and its set-up and removal are labor intensive. Poly pipe is rolled out and can be left in place, collapsing to be driven over safely when empty. However, since poly pipe is easily damaged, it has a short lifespan. A few growers still use open ditches and siphon tubes to accomplish transport from turnout valve to furrow head, but such methods result in high water losses.
4. Optimum furrow water velocity: For uniform distribution and minimal waste, water should flow down the furrow as quickly as possible. As it flows down the furrow, water leaches into and through the soil; the longer water must flow to push to the far end of a field, the more infiltration and the more loss occur. Therefore, so that water will move more quickly, producers should irrigate the fewest possible number of rows at one time, based on the available head. Then when the first rows are finished, the next set of rows can be started, and so on. Such an irrigation strategy requires careful attention. Sometimes, irrigators run large numbers of rows simultaneously, so the water will take longer to reach the other end of the field, allowing irrigation to left unattended for long periods (often overnight).

Surge irrigation uses valves at regular intervals in the irrigation line to divert water flow first in one direction, then the other, directing water into only half the furrows at any one time. Such intermittent quick shots of water seem to seal the soil, with each subsequent shot infiltrating less. While the mechanism of this effect is not known, the benefits of surge irrigation have been proved and are widely accepted.

5. Tillage: Used to control weeds, to incorporate fertilizers and to shape beds, cultivation also results in moisture loss due to evaporation from the freshly tilled soil. In the short term, however, it increases infiltration rates and stimulates decomposition of organic matter that contributes to the soil's moisture-holding capacity. So, to reduce irrigation requirements, producers should design production practices to minimize cultivation as much as possible.

### **Drip and Spinkler Irrigation Systems**

Alternate irrigation systems such as drip and overhead (sprinkler) systems allow producers more precise control over amounts and distribution of irrigation water than is possible with furrow or flood irrigation. Both drip and sprinkler systems have been used successfully for sugarcane production in the LGRV. Compared to furrow irrigation, these systems reduce water use and increase crop yields.

1. General advantages and disadvantages of drip and overhead systems: Drip and overhead systems reduce water use through uniform distribution of desired amounts of water at frequent intervals

over entire fields. These systems increase crop yields by maintaining soil moisture conditions optimum for growth, applying water as often and in amounts necessary to accomplish this goal. Drip and overhead irrigation also reduce costs associated with controlling weeds, diseases and pests; permit precise application of plant nutrients and ripeners using chemigation; and enhance sucrose content.

On the other hand, installation cost is an obvious major disadvantage of drip or overhead irrigation. Currently growers pay \$12 to \$20 per acre for each irrigation, with costs for the water applied to an acre of sugarcane each year averaging \$84 to \$140 (depending on the number of irrigations). Drip and overhead irrigation systems have been found to reduce sugarcane water use in the Valley by about 25 percent, while maintaining or increasing yields. The water saved by increased efficiency can be used to grow crops on additional acres. The other benefits previously listed also help to offset the cost of a drip or overhead system, and investment in such irrigation systems can be spread out over the equipment's lifetime.

2. Drip irrigation systems: To be effective, drip systems require care and maintenance by knowledgeable operators. Because drip irrigation systems typically are designed to meet peak demand, they will operate almost continuously during a crop's period of most rapid growth. To get uniform water distribution, producers must operate such systems within design specifications; mistakes can be costly. Rodents and other pests, dirty water sources and vandalism can damage such systems. Periodic flushing with

H<sub>2</sub>SO<sub>4</sub> and HCl is necessary to prevent clogging of emitters by precipitates or algae. Adaptation to these system requirements is not always easy for growers accustomed to low-tech furrow irrigation.

3. **Overhead irrigation systems:** LRGV producers likely will have to use more expensive lateral-move overhead irrigation machines (Fig. 5), rather than center-pivot models, because the linear systems can be configured to match field layouts already in place in this region. Drag hoses using sprinkler heads apply irrigation water to the soil, instead of to foliage where it may increase disease and insect problems. Lateral-move machines also may prove more durable, with lower filtration requirements than drip systems and longer life expectancies under rugged south Texas field conditions.



Figure 5. Linear-moving system with water supplied by a hose.

When Valley producers begin green cane harvesting, they can incorporate overhead irrigation into production systems that handle trash left in the soil, using sprinkler heads to keep the trash moist and stimulate decomposition following harvesting. The trash blanket conserves soil moisture and retards weeds, while providing soil-enhancing humus to improve physical properties and furnish nutrients. The trash blanket will not interfere with overhead system irrigation as it does with furrow irrigation.

## *Economics of different irrigation methods*

The three irrigation systems (drip, linear and flood) differ in both magnitude and types of costs. Fixed costs for furrow irrigation in the LRGV are negligible, while drip and sprinkler irrigation require substantial fixed investment. The typical sugarcane field is 30 acres or less, implying a large fixed cost per acre for the sprinkler system (Table 5).

The key variables to consider in comparing irrigation systems are acreage size (because of fixed costs), energy and labor. Table 6 shows the differences in total irrigation costs per acre between sprinkler and furrow irrigation systems, using data collected at the Weslaco Research and Extension Center. Because of their higher

**Table 5. Typical sugarcane irrigation parameters for an irrigation system on 30 acre field.**

Irrigation system	Yield (tons/ac)	Water applied (in/ac)	Variable irr. cost (\$/ac)	Fixed irr. cost* (\$/ac)	Total irr. cost (\$/ac)	Net returns** (\$/ac)
Flood	36	63	\$129	\$0	\$129	\$519
Sprinkler	50	58	\$108	\$559	\$667	\$233
Drip	50	52	\$174	\$210	\$384	\$516

\*Note: This assumes a 30-acre field; for different acreages, the sprinkler fixed cost/acre would change significantly. Fixed costs are annualized over period of 10 years with 9% interest.

\*\*Note: Gross return (i.e., tons/acre\*\$18/ton) net of irrigation costs only.

fixed costs, sprinkler and drip irrigation systems are more expensive for smaller acreages than furrow systems. For example, with furrow irrigation labor costs of \$20 per acre, a sprinkler irrigation system will be \$280 more expensive for an area of 50 acres. However, as shown in Table 6, as the area and labor costs increase, the difference in cost between overhead sprinkler and furrow becomes smaller.

**Table 6. Difference in irrigation costs per acre between overhead sprinkler and furrow irrigated sugarcane, over a range of field sizes and furrow irrigation labor costs.**

<i>Costs of labor for furrow irrigation per growing season (\$/ac)</i>				
Acres	\$20	\$30	\$40	\$50
10	\$1,332	\$1,322	\$1,312	\$1,302
20	\$674	\$664	\$645	\$644
30	\$455	\$445	\$435	\$425
40	\$346	\$336	\$326	\$316
50	\$280	\$270	\$260	\$250
60	\$236	\$226	\$216	\$206
70	\$205	\$195	\$185	\$175
80	\$181	\$171	\$161	\$151
90	\$163	\$153	\$143	\$133
100	\$149	\$139	\$129	\$119

\*Note: As field size increases, fixed costs of overhead sprinkler system shrink, making it more competitive with furrow irrigation.  
 \*\*Note: As the cost of labor per acre for furrow irrigation increases, overhead sprinkler system is more competitive.

Drip or sprinkler systems may be more productive than furrow systems, due to higher water use efficiency. In order to offset the cost differences shown in Table 5, production needs to be increased as shown in Table 7 (7a, sprinkler irrigation; 7b, drip irrigation). In general, drip systems are more competitive with furrow irrigation.

**Table 7a. Yield gain (tons/ac) from overhead sprinkler irrigation required to break even with furrow irrigation.**

<i>Seasonal cost per acre for furrow irrigation labor</i>				
Acres	\$20	\$30	\$40	\$50
10	74.0	73.4	72.9	72.3
20	37.5	36.9	36.4	35.8
30	25.3	24.7	24.2	23.6
40	19.2	18.7	18.1	17.5
50	15.6	15.0	14.4	13.9
60	13.1	12.6	12.0	11.5
70	11.4	10.8	10.3	9.7
80	10.1	9.5	9.0	8.4
90	9.1	8.5	8.0	7.4
100	8.3	7.7	7.1	6.6

\*Note: Assumes return of \$18 per ton to grower.

**Table 7b. Yield gain (tons/ac) from drip irrigation required to break even with furrow irrigation.**

<i>Seasonal cost per acre for furrow irrigation labor</i>				
Acres	\$20	\$30	\$40	\$50
10	8.2	7.6	7.1	6.5
20	6.3	5.8	5.2	4.7
30	5.7	5.2	4.6	4.1
40	5.4	4.9	4.3	3.8
50	5.2	4.7	4.1	3.6
60	5.1	4.6	4.0	3.4
70	5.0	4.5	3.9	3.4
80	5.0	4.4	3.8	3.3
90	4.9	4.3	3.8	3.2
100	4.9	4.3	3.8	3.2

\*Note: Assumes return of \$18 per ton to grower.

## Conclusion

The challenge for sugarcane growers in the LRGV is to increase production at the lowest costs, while using less water, through management strategies such as irrigation scheduling, frequent irrigation applications at light depths, applying correct amounts of fertilizer, optimum stream size selection and proper leveling of land. Farmers' use of these strategies should be complemented by irrigation districts' efforts to achieve greater flexibility and reliability in canal networks through modernizing canal systems and upgrading irrigation systems at the farm level. Levels of technology selected should be adapted to characteristics of a particular farm and must be economically justified.

## Sugarcane Irrigation Resources

Allen, R.G., L.S. Pereira, D. Raes and M. Smith. 1998. Crop evapotranspiration - guidelines for computing crop water requirements. *FAO Irrigation and Drainage Paper 56*. Rome: Food and Agriculture Organization (FAO) of the United Nations.

Doorenbos, J., and A.H. Kassam. 1986. Yield response to water. *FAO Irrigation and Drainage Paper No. 33*. Rome: Food and Agriculture Organization (FAO) of the United Nations.

Fipps, G. Irrigation Water Quality Standards and Salinity Management. Texas Agricultural Extension Service. Publication B-1667.

Rozeff, N. 1998. Sugarcane irrigation management. In: N. Rozeff, J.M. Amador and J.E.Irvine. (eds.). *South Texas Sugarcane Production Handbook*. Texas A&M University Agricultural Research and Extension Center at Weslaco and Rio Grande Valley Sugar Growers, Inc., Santa Rosa, TX. (Excerpt available from Research and Extension Center, Weslaco.)



The information given herein is for educational purposes only. Reference to commercial products or trade names is made with the understanding that no discrimination is intended and no endorsement by Texas Cooperative Extension is implied.

Produced by Agricultural Communications, The Texas A&M University System  
Extension publications can be found on the Web at: <http://tcebookstore.org>

Visit Texas Cooperative Extension at <http://texasextension.tamu.edu>

Educational programs conducted by Texas Cooperative Extension serve people of all ages regardless of socioeconomic level, race, color, sex, religion, handicap or national origin.

Issued in furtherance of Cooperative Extension Work in Agriculture and Home Economics, Acts of Congress of May 8, 1914, as amended, and June 30, 1914, in cooperation with the United States Department of Agriculture. Edward G. Smith, Interim Director, Texas Cooperative Extension, The Texas A&M University System.

500, New

# *ADDITIONAL RESOURCES*



**Agricultural Water Conservation Practices  
Propeller Flow Meters (L-5492)**

**Irrigation Formulas and Conversions**

**Irrigation Information Resources Available on the Internet**

**Publications Referenced in the Irrigation Training Program Manual**





## *Additional Resources*

### **In this Section**

Reference: Agricultural Water Conservation Practices

Reference: Propeller Flow Meters (L-5492)

Reference: Irrigation Formulas and Conversions

Reference: Irrigation Information Resources Available on the Internet

Reference: Publications Referenced in the Irrigation Training Program Manual



# Agricultural Water Conservation Practices



*Low Elevation Spray Application (LESA) System*

# **Agricultural Water Conservation Practices**

# AGRICULTURAL WATER CONSERVATION PRACTICES

## Introduction

According to the 2002 Texas State Water Plan, agricultural irrigation water demand is expected to decline by 12% in the next fifty years. It will, however, continue to be the largest water user in the State, accounting for 42% of the State's total projected water demand. Between 1986 and 2000, about 7 to 10 million acre-feet of water was used for irrigation per year. Eighty percent of agricultural water use in Texas comes from groundwater supplies, and existing groundwater supply is expected to decrease 18% by 2050. Available supply from the Texas portion of the Ogallala Aquifer, a major source of irrigation water for the heavily agricultural Panhandle/South Plains region, is expected to decrease 24% by 2050. Twelve counties in Texas are among the top 100 U.S. counties in farm product sales. Most of these counties are heavily dependent on irrigation and more than 30% of their income is from farming. Texas' economy relies on the continued viability of agriculture, which depends on reliable water sources. Conservation is an important part of meeting agricultural water demand in the next fifty years. On-farm water use can be reduced substantially without decreasing productivity through improved irrigation technologies and efficient water management practices.

Accurate water measurement and soil moisture monitoring are key components of efficient on-farm water management practices. Irrigation flow meters can be used to help calculate the efficiency of irrigation systems, identify water loss from leaks in conveyance systems, and to accurately apply only the necessary amount of water based on soil moisture levels and weather conditions. Soil moisture monitoring is used in conjunction with weather data and crop evapotranspiration requirements to schedule irrigation. Fields

should be designed for efficient water use by grading land with laser equipment, creating furrow dikes to conserve rainwater, and by retaining soil moisture through conservation tillage.

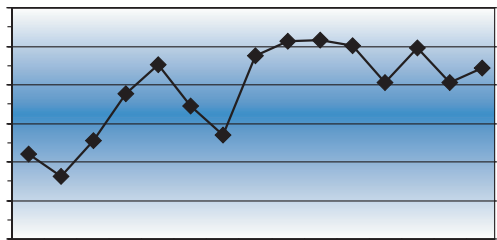

There are three basic types of irrigation: surface (gravity), sprinkler, and drip irrigation. Using surge flow valves and reusing tailwater can increase water use efficiency of gravity irrigation systems. Modifying older high pressure sprinkler systems using the LEPA or LESA methods (see page 8) can increase sprinkler water use efficiency by 20 to 40%. Drip irrigation is a very water efficient method of irrigation that can be effective with certain crops and on uneven terrain. This brochure outlines each of these agricultural water-efficiency measures and explains how they can help save water, energy and money, and possibly even increase crop yields.

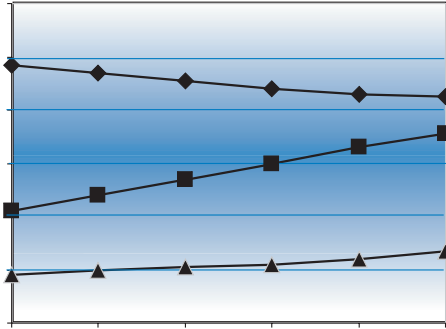

## AGRICULTURAL IRRIGATION SCHEDULING

Irrigation scheduling involves managing the soil reservoir so that water is available when the plants need it. Soil moisture and weather monitoring are used to determine when to irrigate, and soil capacity and crop type are used to determine how much water should be applied during irrigation.

### Soil moisture monitoring

Regardless of the irrigation system used, scheduling irrigation should be based on the crop's water needs. Crop water need is often assessed by monitoring soil moisture. There are many ways to measure soil moisture, each method having its own advantages and disadvantages, and varying degrees of accuracy. The most obvious and common method of soil moisture monitoring is to observe the soil **feel and appearance** at various soil depths within the crop root zone. The Natural Resource Conservation Service maintains a web site featuring photographs of soil feel and appearance for various levels of plant-available water contents in the four major soil textures from sand to clay (<http://nmp.tamu.edu/estimatingsoilmoisture.pdf>). Several sensors are available to measure soil water tension rather than soil water content. This is appropriate because soil water

tension relates to how easily a crop may take up water from the soil. **Gypsum blocks** are widely used and inexpensive devices that measure soil water tension through electrical conductivity. However, they require individual calibration, they are not accurate in very wet, or saline soil, readings are affected by soil temperature changes and fertilizer addition (which changes soil conductivity), and calibration gradually changes with time. New blocks may need to be installed every year. **Granular matrix sensors** provide more stable calibration and more accurate tension measurements in wet soil. Equipment is available for recording the readings from granular matrix sensors and plotting them over time (<http://www.cropinfo.net/OtherReports/HansenIA2000.htm>). **Tensiometers** also measure soil water tension. Unlike gypsum blocks, they are reusable, and do not require calibration. However, they do not work well in coarse sand and some clay soils. They fail to read at higher tensions associated with drier soils, even though many crops still do well at those water contents. Regular maintenance is required throughout the crop season to purge air that has entered the tensiometer. Tensiometers are most commonly used with vegetable crops. **Capacitance or frequency domain (FD) probes** estimate soil moisture by measuring soil electrical properties that are related to water content. They can be read immediately, but are affected by salinity, soil texture, and small scale variability in soil moisture. Some capacitance probes can be used in an access tube, while others are made to be buried or have stainless steel probe rods that can be inserted into the soil. They need to be calibrated before use. All soil moisture sensors except the neutron probe require excellent contact with the soil and will not give accurate readings if there are air pockets near the probes or access tube walls. The **Neutron probe** and the **gravimetric method** (calculating moisture as a percentage of soil weight) are the two most standard methods to obtain accurate soil moisture data. Like the capacitance sensors, the neutron probe must be calibrated for the particular soil in which it is used. However, access tube installation is much less critical with the neutron probe. The neutron probe requires training in radiation safety and a license to handle the low-level radioactive neutron source. It also requires the presence of a licensed operator in the field at all times during use. These factors combine to make the neutron probe expensive to use. For these reasons, neutron probes are usually not practical for individual farmers, but they are used by consultants and government agencies for irrigation scheduling and soil moisture monitoring. The High Plains Underground Water Conservation District No. 1 and the USDA-NRCS use the neutron probe to conduct an annual survey of pre-plant soil moisture conditions at 400 permanent monitoring sites located within the district's 15 county service area. The district

publishes maps illustrating soil moisture availability and deficits for three-foot and five-foot levels of the soil profile. In addition, maps of precipitation data are also published monthly during the growing season.<sup>1</sup> The gravimetric method does not require expensive equipment, but is time consuming both for acquiring soil samples in the field and for drying and weighing the samples. Although they do not measure soil water content or tension, **pressure bombs** and **infrared thermometry** are commonly used research methods of assessing plant water status. They are not commonly used by irrigation farmers, although the pressure bomb is sometimes used for scheduling tree crop irrigations in California.

## **Weather Monitoring**

Temperature, rainfall, humidity and crop evapotranspiration (ET) data should be collected to determine efficient irrigation scheduling. ET is the sum of evaporation (water lost outside of the plant) and transpiration (water lost through the plant itself). Weather stations or networks often collect weather and ET data, which is made available to irrigators. The Texas A&M University Agricultural Program website (<http://texaset.tamu.edu>) contains weather information, ET data, and crop watering recommendations. Weather information and ET data gathered from stations should be confirmed by monitoring soil moisture changes and rainfall as it may not accurately reflect on-farm conditions. Irrigation guides may also be available from local water districts. Irrigation scheduling software programs can be used to control and monitor water application. These programs can be linked directly to an irrigation system's flow-control valve and connected with ET data from the internet so that water applications can be continually adjusted to weather and soil conditions. The Texas A&M University Agricultural Program has irrigation scheduling software programs available free of charge at <http://achilleus.tamu.edu/software/software.asp>.

## **Soil Capacity**

Soil acts as a water reservoir between irrigations or rains. Soil is also a nutrient reservoir, and it mechanically supports and stabilizes plants. Each soil type has a different capability to hold moisture based on soil depth, soil texture (ratios of various soil particle sizes), soil structure (soil porosity) and soil water tension. A combination of these elements determines the amount of water available to the plant. Soil type may vary within the root zone, so it is important to know crop root depth and the soil type throughout the root zone. Soil surveys by county are available at local NRCS offices (<http://www.tx.nrcs.usda.gov/personnel/map5zone.htm>). These publications contain information about local soil types, local soil permeability

and available water capacity based on soil type. The table below estimates available water for various soil textures, including a margin of error of up to 25%. Each foot of soil in the root zone must be filled to water capacity (field capacity) before the next lower zone can be filled as shown in the figure below.

**Soil Texture    Inches of Water Available  
per Foot of Soil**

Coarse Sand	.50
Fine Sand	.75
Loamy Sand	1.00
Sandy loam	1.25
Loam	1.50-2.00
Clay or silt loam	1.75-2.50
Clay	2.0-2.4

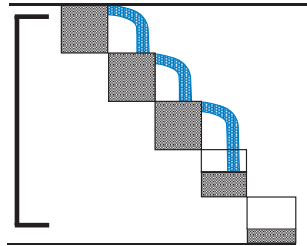

Source: *Ag-Irrigation Management* (Irrigation Training and Research Center, 2000)

**Crop Type**

Plants differ in their ability to withdraw water from soils, their water use rate, and their ability to withstand soil water stress. When the moisture content in the soil declines to a certain point, plants begin to irreversibly wilt. This point is called the permanent wilting point (PWP) and is measured by soil water tension. Plant available water (PAW) is expressed as the amount of water held between field capacity (FC) and the PWP ( $FC - PWP = PAW$ ). Each crop and/or crop variety will have a different PWP. PAW must be determined for the whole root zone. As shown in the table on page 6, different crops have different rooting depths. Water salinity may also influence PAW. A farmer should allow the plants to deplete a pre-selected percentage of the PAW before irrigating again. This percentage is called the managed allowable depletion (MAD), and may change depending on growth stage (e.g., cotton may need to be stressed at certain growth stages to maximize yields or crop quality). Soil moisture monitoring throughout the root zone should be used to determine the exact amount of water needed to manage PAW. Plants take 40% of the water they use from the top 25% of the root zone (see figure, page 6), so over-filling the soil beyond field capacity in the bottom 25% of the root zone will cause deep percolation rather than increasing yields. Crop rooting depth will be dependent on local conditions such as soil salinity, changes in soil type, compaction, shallow water tables, and fertility. Rooting depth is less in clay soils than in sandy soils.



<b>Crop</b>	<b>Approximate Root Depth (ft)</b>
Alfalfa	4-6
Citrus	2-5
Cabbage	1.5 - 3
Corn	2.5-4
Cotton	3-4
Grass	3-4
Melons	2-3
Oats	3-5
Onions	1.5
Peanuts	2-2.5
Potatoes	2-3
Sorghum	2-3
Soybeans	2-3
Sugar beet	2-4
Sugarcane	4-6
Tomatoes	2-4
Turf grass	.5 - 2.5
Wheat	3-4

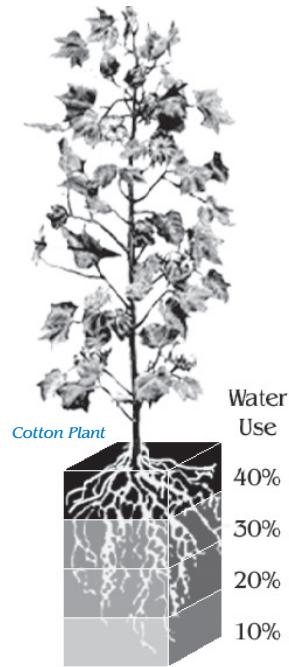

Source: *Ag-Irrigation Management* (Irrigation Training and Research Center, 2000) and Texas Agricultural Extension Service

## **Water Conservation and Farm Management**

Better management practices can be as effective as new technology in increasing water-use efficiency. Using the techniques mentioned above, farmers can determine how much water is needed to maximize productivity while minimizing water waste. After the field capacity of the soil in the root zone has been reached, the crops cannot utilize the excess water, and may be stressed from reduced oxygen levels of saturated soil. Furthermore, the water, the energy used to pump that water, and the money spent on energy costs will be wasted.

## **PREPARING FIELDS FOR EFFICIENT WATER USE**

### **Laser Leveling**

Laser-controlled land leveling equipment grades fields to contour the land for different irrigation practices. With sprinkler systems, a perfectly level field conserves water by reducing runoff, allowing uniform distribution of water. Furrow irrigation systems need a slight but uniform slope to use water most efficiently. Laser leveling can reduce water use by 20-30% and increase crop yields by 10-20%.

## **Furrow Diking**

Furrow diking conserves water by capturing precipitation or irrigation water in small earthen dams in the furrows. Water held between the dams can slowly infiltrate into the soil, increasing soil moisture and reducing or eliminating runoff. Furrow dikes can benefit dryland farmers, sprinkler irrigators and furrow irrigators who water alternate rows. Dikes should be made large enough to hold runoff during intense thunderstorms when the soil is not able to immediately absorb the intensity of rainfall. If the field has a slope, furrow diking is especially important to reduce excessive runoff. It is also an important part of LEPA irrigation systems, especially on less permeable soils. Water is applied directly to furrows by drop lines from the sprinklers.



*LEPA irrigation drop tube and furrow diking*

## **Conservation Tillage**

Conservation tillage helps preserve soil moisture by leaving at least 30% of the soil surface covered with crop stubble, thereby decreasing wind and water erosion. The crop stubble layer reduces evaporation in the soil profile by one-half compared to bare soil. Conservation tillage can also reduce pollution caused by runoff and enrich the soil with organic matter.

## **Tailwater Reuse**

Tailwater, or runoff water, should be minimized as much as possible through soil monitoring and irrigation methods that reduce runoff, such as surge flow irrigation and furrow diking. However, if field runoff is present, it should be captured at the lowest end of gravity-irrigated rows and reused. Reuse of runoff water works best with laser leveling, and is effective with soils that have high water holding capacity. It is not recommended for areas where soils contain high concentrations of salt, and it may spread chemicals, diseases and weed seeds.

## EFFICIENT IRRIGATION SYSTEMS

### **LEPA (Low Energy Precision Application) and LESA (Low Elevation Spray Application)**

LESA irrigation systems distribute water directly to the furrow at very low pressure (6-10 psi) through sprinklers positioned 12-18 inches above ground level. Conventional high pressure impact sprinklers are positioned 5-7 ft. above the ground, so they are very susceptible to spray evaporation and to wind-drift, causing high water loss and uneven water distribution. LESA systems apply water in streams rather than fine mists to eliminate wind-drift and to reduce spray evaporation, deep percolation and under watering. LEPA irrigation systems further reduce evaporation by applying water in bubble patterns, or by using drag hoses or drag socks to deliver water directly to the furrow. LEPA and LESA systems concentrate water on a smaller area and increase the water application rate on the area covered. Therefore, the application rate must be monitored closely to follow the soil intake curve, and furrow diking should be used to prevent runoff. In addition to water savings, these irrigation systems use much less energy (at least 30% less than conventional systems), which reduces fuel consumption and operating costs. Other advantages include reduced disease problems due to less wetting of foliage, and easier application of chemicals. Both lateral move (side roll) and center pivot systems can be readily converted to LEPA irrigation. Variable flow nozzles adjust flow from a computer to match microclimate conditions. Correct management of a LEPA system is essential to realize potential water savings. Farmers who replace older irrigation systems with LEPA sprinklers should adjust their management practices so that they do not continue to use excess water. If the pivot system does not have a digital control box showing the amount of water applied, meters should be installed or readings from portable meters should be requested from the local water district to accurately determine how much water is being applied. A center pivot evaluation spreadsheet designed to help farmers determine the efficiency of their pivot system can be downloaded from <http://www.twdb.state.tx.us/assistance/conservation/eval.htm>. When managed correctly, LEPA irrigation is 20-40% more efficient than typical impact sprinklers and furrow irrigation. While LEPA systems can be costly, this expense can be offset in 5 to 7 years through reduced energy savings of 35-50%, labor cost reduction of as much as 75%, and increased crop yields.<sup>1</sup>

### **Surge Flow**

Surge flow irrigation is a type of furrow irrigation that applies surges of water intermittently rather than in a continuous stream. These

surges alternate between two sets of furrows for a fixed amount of time. The alternate wetting and “resting” time for each surge slows down the intake rate of the wet furrow and produces a smoother and hydraulically improved surface. By doing so, the next surge travels more rapidly down the wet furrow until it reaches a dry furrow. Surge irrigation provides more uniform water distribution, limits deep percolation, and can reduce tailwater runoff. Water infiltration varies substantially based on the type of soil, soil compaction, and soil preparation. Surge flow does not work well on compacted soils, so it is more effective during pre-plant irrigation and the first seasonal irrigation following cultivation. Surge flow can cut water losses by up to 30% in clay soils and can save more than 35% of energy costs compared to simple furrow irrigation. Savings in energy and pumping costs can pay for the cost of surge irrigation valves within two years.<sup>1</sup> Monitoring soil moisture is important for establishing on-off cycles for surge irrigation, and cycle length should be adjusted according to soil type. To accurately determine how much water is being applied, meters should be installed or readings from portable meters should be requested from the local water district. Surge irrigation increases fertilizer application efficiency and lowers salt loading by reducing deep percolation. It may not, however, improve yields when used on short level furrows where irrigation is relatively efficient. Using a computer program, some surge valves allow irrigators to adjust the valve controller for individual farm characteristics such as soil type, moisture content, slope, furrow size, infiltration rate and compaction.

## **Drip Irrigation**

Drip irrigation applies small amounts of water frequently to the soil area surrounding plant roots through flexible tubing with built-in or attached emitters. Subsurface drip irrigation (SDI) delivers water underground directly to roots. Since water is applied directly to individual plant roots, SDI minimizes or eliminates evaporation, provides a uniform application of water to all crop plants, and applies chemicals more efficiently. Drip irrigation also reduces plant stress and increases crop yield. A carefully managed amount of water is applied, thereby avoiding deep percolation and runoff, while reducing salt accumulation. Since a constant level of moisture is maintained around the root zone, with less surface moisture present in between rows, weed growth is reduced. Water contact with crop leaves and fruit is also minimized, making conditions less favorable for disease. Drip systems reduce farm operation and maintenance costs through energy savings and automation. Also, drip systems are the only type of irrigation that can use water efficiently on steep slopes, odd-shaped areas, and problem soils.

Subsurface drip irrigation has allowed a Lubbock County producer to increase his crop yield from 650 pounds of cotton per acre (about 1.3 bales) to 1,200 pounds of cotton per acre (about 2.5 bales).<sup>1</sup> Research conducted by the Texas Agricultural Extension Center in Starr County found that drip irrigation under plastic mulch produced a 60% higher melon yield with only 33% of the water and 40% of the nitrogen required by a furrow irrigated field. In addition, the melons matured faster, so they could be harvested earlier.

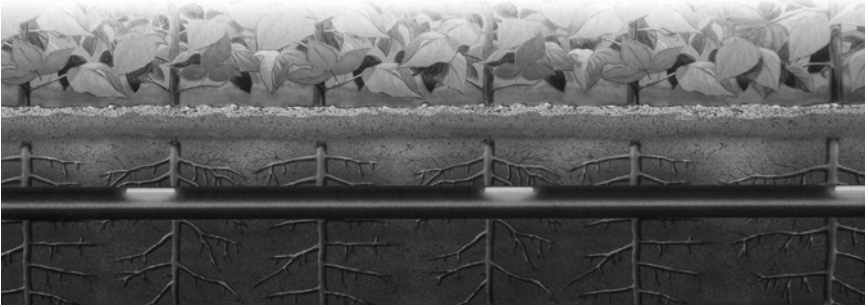

*Subsurface drip irrigation*

Although drip systems are very efficient, they do have some drawbacks. Because they may clog and are susceptible to damage by rodents, insects, and sedimentation, they must be checked regularly. A good filtration system is essential for proper performance of a drip system. Hard water should be treated to discourage mineral build-up. New systems are expensive, and must be designed to suit crops and local soil and climate conditions. A reliable, continuous water supply is necessary to run a drip system, and proper irrigation management and furrow shaping is necessary to prevent salt build-up. Rotating crops with different spacing requirements may be problematic after a drip system is installed. Drip irrigation may not be practical for closely spaced crops such as rice or wheat. If drip tapes are used, they are typically placed 10" below the surface. This may cause some difficulty in germinating seed without rainfall. Disposing of used tape may also be a problem. Selecting a small test plot area is a relatively inexpensive way to experiment with drip irrigation.

## Comparison between Irrigation Systems

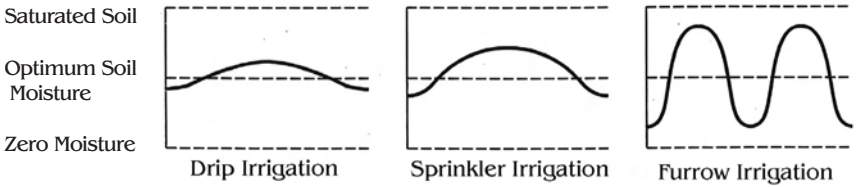

Relative moisture varies the most in furrow irrigation and the least in drip irrigation systems.

<b>Irrigation System</b>	<b>Range of Application Efficiency (percent)</b>
Drip Irrigation	90-98%
LEPA Center Pivots	90-95%
LESA Center Pivots	80-90%
Surge Valves with Furrow Application	50-70%
Furrow with Open Ditch	40-60%

*Source: High Plains Underground Water Conservation District #1, Lubbock, TX.*

## Canal and Conveyance System Management

Lining canals with concrete or other liners reduces water loss through seepage by 10-30%. Evaporation in canals can be reduced if irrigation districts provide water on demand rather than keeping the canals continuously filled. Using underground conveyance systems eliminates costly evaporation and deep percolation.

## Conclusion

Using the methods outlined in this brochure will not only conserve water, but will preserve water quality, reduce or eliminate drainage problems, conserve energy, often increase production, and save money. The stress of droughts, higher expenses and low commodity prices will continue to make efficient water management practices a necessary tool for farmers who wish to remain competitive in today's market. Efficient agricultural water conservation practices are essential to ensure the viability of Texas' agricultural industry.

*This brochure was developed by the Texas Water Development Board. Some reference material was adapted from "Handbook of Water Use and Conservation" by Amy Vickers (WaterPlow Press, 2001) and "Ag-Irrigation Management" (Irrigation Training and Research Center, 2000). <sup>1</sup>Additional information was provided by High Plains Underground Water Conservation District #1, Lubbock, TX and the Texas Agricultural Extension Service.*

[www.twdb.state.tx.us/assistance/conservation/agricons.htm](http://www.twdb.state.tx.us/assistance/conservation/agricons.htm)

**Be Water Smart  
For Today and Tomorrow**



**CONSERVATION**

Texas Water  
Development Board  
P.O. Box 13231  
Capitol Station  
Austin, Texas  
78711-3231

[www.twdb.state.tx.us](http://www.twdb.state.tx.us)

*Printed On Recycled Paper*







## Propeller Flow Meters (L-5492)

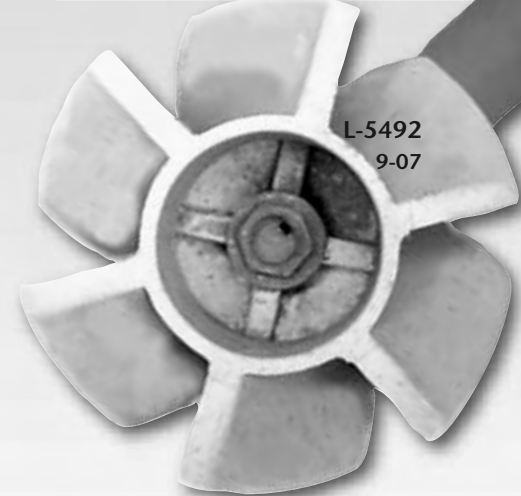

# Propeller flow meters

Juan Enciso, Dean Santistevan and Aung K. Hla\*

Propeller flow meters are the most common devices used in Texas for measuring water flow rate. Water meters help irrigators better manage and schedule irrigation. They are also a tool for estimating irrigation water use. This publication will help irrigators learn to select, install and maintain a

propeller flow meter, interpret the meter readings, and use the data.

### Selecting a meter

A propeller flow meter measures the velocity inside a pipe and shows the flow rate reading on a dial. Table 1 shows approximate sizes and minimum and maximum flow rates.

There are three main types of flow meters. The saddle type can be welded or clamped (Figs. 1A and 1B), open flow (1C), or flanged (1D). The weld in line flow meter of Figure 1B may also be fitted with straightening vanes.

Some of these meters are coupled to aluminum or PVC pipe, usually when they will be used in furrow irrigation (Fig. 1E). When there will be excessive trash in the water, the small propeller can be installed (Fig.1F).

### Installing a meter

The meter should be installed and placed correctly to ensure that readings will be accurate. It is also important to prevent debris from collecting on the propeller. Water should be clean, but if it contains sediment, the meter should be located properly so that settling sediment will not obstruct the flow.

**TABLE 1**

Sizes and flow rates			
Meter size (in)	Minimum flow (gpm)	Maximum flow (gpm)	Head loss (in)
3	35	250	29.5
4	50	600	23.0
6	90	1200	17.0
8	100	1500	6.75
10	125	1800	3.75
12	150	2500	2.75
14	250	3000	2.00
16	275	4000	1.75

\* Associate Professor and Extension Agricultural Engineer, The Texas A&M University System; Field Engineer, Natural Resource Conservation Service, United States Department of Agriculture; Program Specialist, Conservation Division, Texas Water Development Board.

FIGURE 1: Flow meter types

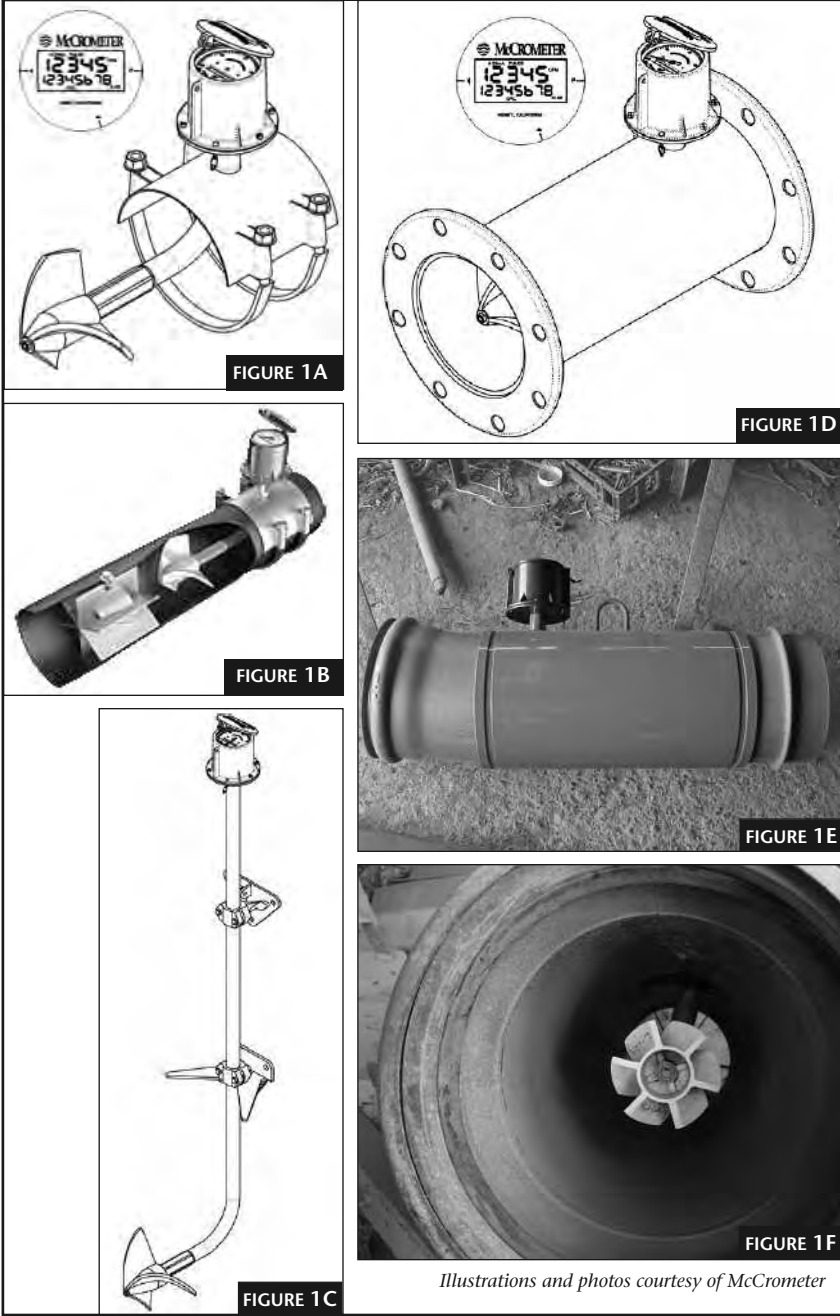

Illustrations and photos courtesy of McCrometer

Some obstructions before the meter, including elbows, valves, pumps or changes in diameter, can cause disturbances in the flow measurements. To avoid this, the meter should be minimum distances upstream and downstream of any obstructions, as shown in **Figure 2**. A minimum of five pipe diameters upstream from the propeller and one diameter downstream from the flange is usually sufficient, although the manufacturers' requirements may vary with different meter models and sizes. If five diameters are specified upstream and one diameter downstream, and if the pipe diameter is 10 inches, the length of the pipe upstream before any obstruction should be at least 50 inches and the length downstream should be 10 inches. If there is not enough length either upstream or downstream, meters should have straightening vanes as shown in **Figure 1B**. Adding vanes will reduce the undisturbed length requirement to about 1½ pipe diameters upstream and ½ diameter downstream.

**Reading flow meters**

Propeller meters are used to measure instant flow rate and the total volume over a period of time. The instant readings are in gallons per minute or cubic feet per second. The needle indicates the flow rate and the box below the needle indicates the total volume of water. The total volume can be measured in acre-inches, gallons, cubic feet or cubic meters. Some irrigators prefer the acre-inch because it

FIGURE 2: Distance requirements for installing flow meters

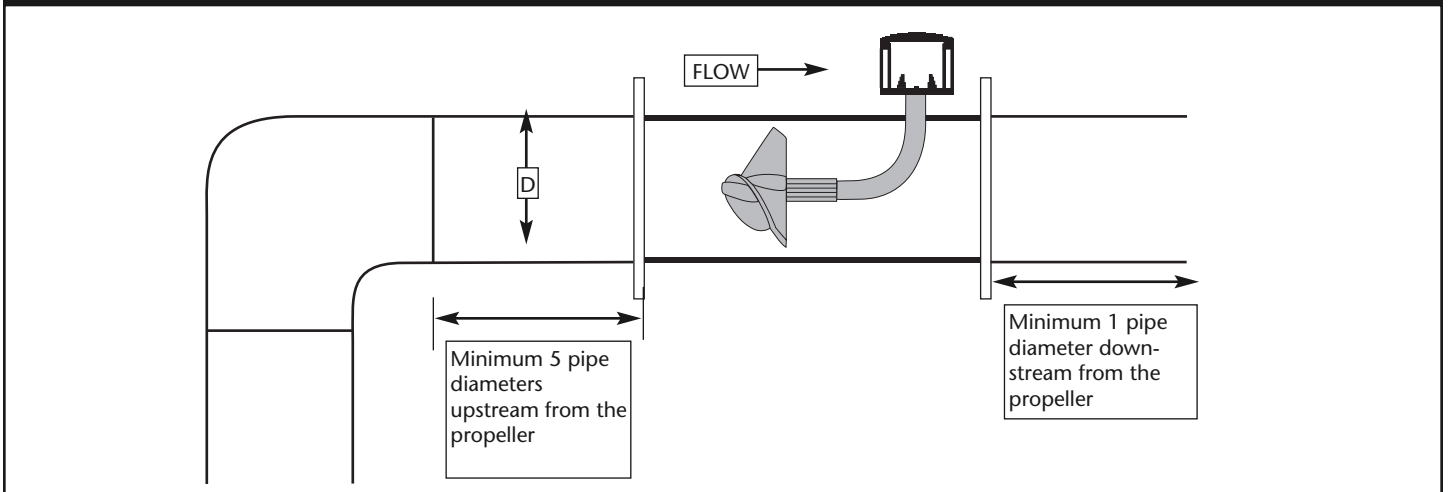

relates to their traditional terminology. On the dial faces shown in **Figures 3A** and **3B**, the flow rate is expressed in gallons per minute and the total volume in gallons. To obtain the volume, the reading is adjusted by a factor. In **Figure 3A** the factor is 100; in **Figure 3B** the factor is the three zeros to the right side of the dial. The readings for each flow meter are in the figure captions.

In **Figure 3C** the flow rate is measured in cubic feet per second and the total volume in acre-feet when

the reading is multiplied by the factor of 0.001 indicated on the dial face. In **Figure 3D** the flow rate is measured in gallons per minute and the total volume in acre-feet when the reading is multiplied by a factor of 0.01. In **Figure 3E** the flow rate is measured in gallons per minute, but the total volume is measured in acre-feet when the reading is multiplied by a factor of 0.001. The factor for adjusting the readings of each flow meter is shown in the captions.

### Common Conversions

A useful conversion table is given in **Table 2**.

FIGURE 3: Reading flow meters

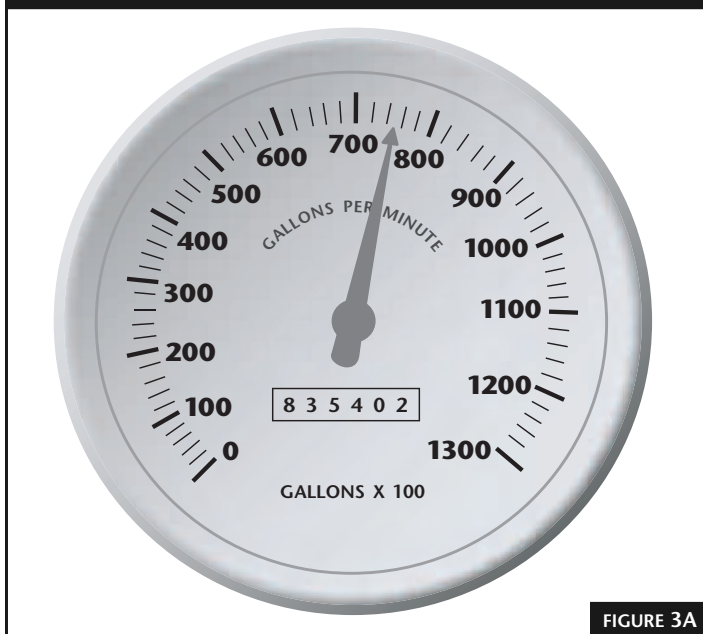

FIGURE 3A

Standard 8-inch dial face with gallons totalizer. Add two zeros to the six-digit number.  
Dial face reading = 83,540,200 gallons.

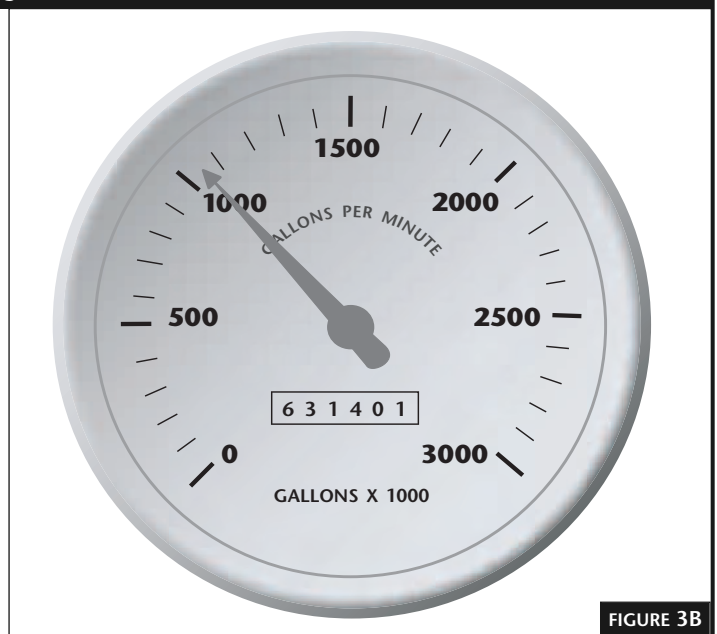

FIGURE 3B

A 10-inch dial face with gallons totalizer. Add three zeros to the six-digit number.  
Dial face reading = 631,401,000 gallons.

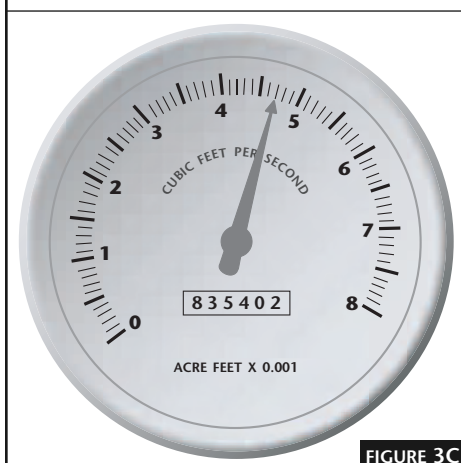

FIGURE 3C

Dial with cubic feet per second indicator and acre-ft totalizer. Place a decimal point three places to the left.  
Acre-ft = 835.402

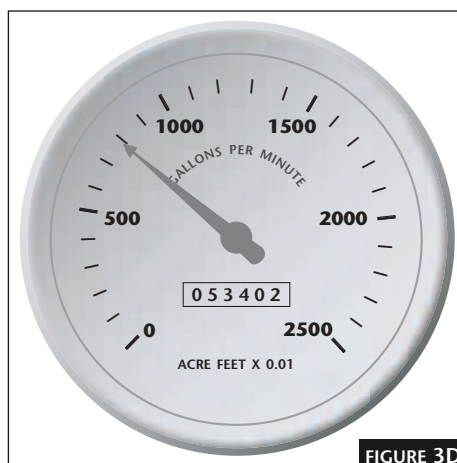

FIGURE 3D

Acre-ft totalizer. Place a decimal point two places to the left.  
Acre-ft = 534.02

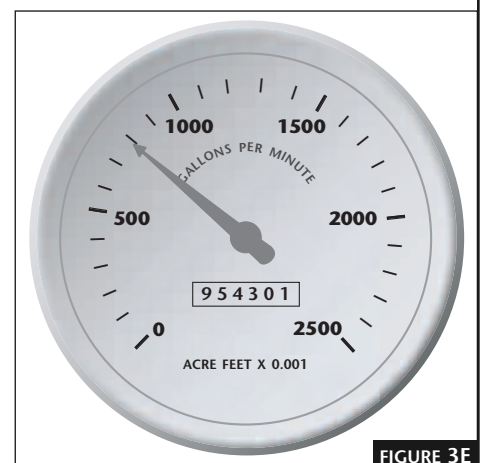

FIGURE 3E

Acre-ft totalizer. Place a decimal point three places to the left.  
Acre-ft = 954.301

**Conversion example 1:**

Suppose the volumetric reading before irrigation was 48,563,000 and after irrigation it was 89,057,200. Determine the irrigation depth applied in acre-feet and in acre-inches.

Actual reading = 89,057,200 gallons

Previous reading =  $-48,563,000$  gallons

40,494,200 gallons

Acre-feet used =  $40,494,200 \div 325,851 = 124.27$   
acre-feet

Acre-inches used =  $40,494,200 \div 27,154 = 1,491.28$   
acre-inches

**Conversion example 2:**

What is the end reading if irrigation is applied to a depth of 1.5 inches over 3 acres? Assume irrigation efficiency is 80 percent and the initial reading was 8,595,560.

Volume required =  $(1.5 \text{ inches} \times 3 \text{ acres} \times 27,154 \text{ gallons/acre-inch}) \div 0.80 = 152,741$

Reading = Initial meter reading + Volume required

Reading =  $8,595,560 + 152,741 = 8,748,301$

**Maintenance**

Flow meters should be inspected regularly to check for mechanical wear and for breakage of the moving parts. Mechanical failures will cause erratic readings. A fogging dial may indicate leakage from a bearing assembly. A quick way to check the mechanical soundness of a meter is to see if the total volume equals the instant flow rate times the interval of time of the measurement. A failing meter should be repaired or serviced.

**TABLE 2**

<b>Water volume and flow conversions and equivalents</b>	
<b>Volume</b>	<b>Equals</b>
1 gallon	8.33 pounds
1 cubic foot	7.48 gallons
1 acre-foot	325,851 gallons
1 acre-foot	43,560 cubic feet
1 acre-inch	27,154 gallons
1 acre-inch	3630 cubic feet
<b>Flow</b>	<b>Equals</b>
1 cfs	448.83 gpm
1 cfs	1 acre-inch per hour
1 gpm	0.00223 cfs
1 gpm	0.00221 acre-in per hour
1 liter/second	15.85 gpm
1 cubic meter/minute	264.2 gpm
1 cfs for 1 hour	1 acre-inch
452 gpm for 1 hour	1 acre-inch

*cfs - cubic feet per second, gpm - gallons per minute*

*Produced by Agricultural Communications, The Texas A&M University System*

**Extension publications can be found on the Web at: <http://tcebookstore.org>**

*Educational programs of Texas Cooperative Extension are open to all people without regard to race, color, sex, disability, religion, age or national origin.*

Issued in furtherance of Cooperative Extension Work in Agriculture and Home Economics, Acts of Congress of May 8, 1914, as amended, and June 30, 1914, in cooperation with the United States Department of Agriculture. Edward G. Smith, Director, Texas Cooperative Extension, The Texas A&M University System.

New, 500 copies



# Irrigation Formulas and Conversions

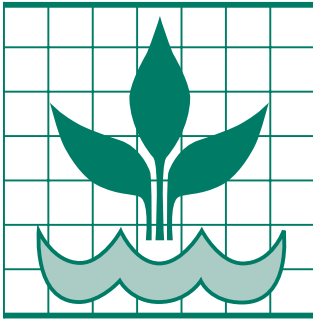

# IRRIGATION MANAGEMENT

# Irrigation Formulas and Conversions

**Danny H. Rogers**  
Extension Irrigation Engineer

**Mahub Alam**  
Extension Irrigation Specialist

## Water Measurement

- 1 cubic foot = 7.48 gallons = 62.4 pounds of water
- 1 acre-foot = 43,560 cubic feet = 325,851 gallons = 12 acre-inches
- 1 acre-foot covers 1 acre of land 1 foot deep; 1 acre-inch = 27,154
- 1 cubic meter = 1,000 liters = 264.18 gallons
- 1 acre-inch = 450 gallons per minute (GPM)  
hour or 1 cubic foot per second (cfs)
- 1 gallon = 128 ounces = 3,785 milliliters
- 1 pound = 454 grams

## Pressure

- 1 pound per square inch (psi) = 2.31 feet of water
- A column of water 2.31 feet deep exerts a pressure of 1 psi
- feet of head = psi x 2.31
- Total Dynamic Head (TDH) includes: Pumping Lift, Elevation Change, Friction Loss, and Irrigation System Operating Pressure
- TDH = Lift + Elevation + Friction + System Pressure

## Area/Length

- 1 acre = 0.405 hectare (ha) = 43,560 feet<sup>2</sup>
- 1 inch = 2.54 centimeters

## Horsepower

**Water Horsepower (WHP)** — power required to lift a given quantity of water against a given total dynamic head.

$$WHP = \frac{Q \times H}{3,960}$$

where: Q = flow rate, GPM  
H = total dynamic head, feet

**Brake horsepower (BHP)** — required power input at the pump.

$$BHP = \frac{WHP}{E}$$

where: E = pump efficiency

### Power Unit Horsepower

Electric Units: approximate name plate horsepower =  $\frac{BHP}{0.9}$

Internal combustion units:

- Must derate 20% for continuous duty
- 5% for right-angle drive
- 3% for each 1,000 feet above sea level
- 1% for each 10° above 60°F

Approximate Engine  
Horsepower Required =

$$\frac{BHP}{0.80 \times 0.95 \times 0.91 \times 0.96}$$

cont. drive 3,000' 100°F  
duty elevation

## Nebraska Performance Criteria (NPC)

Energy source	WHP-hours per unit of fuel
Diesel	12.5 WHP-hrs per gallon
Propane	6.89 WHP-hrs per gallon
Natural gas:	
925 BTU/ft <sup>3</sup>	61.7 WHP-hrs per 1,000 ft <sup>3</sup> (MCF)
1,000 BTU/ft <sup>3</sup>	66.7 WHP-hrs per 1,000 ft <sup>3</sup> (MCF)
Electric	0.885 WHP-hrs per kilowatt-hour

## Water Application

$$\text{Average Application (inches)} = \frac{QT}{A}$$

where: Q = Flow Rate, Acre-Inches/Hour or GPM/450

T = Length of Application, Hours

A = Area Irrigated, Acres

Set Size (Acres) is computed by the formula:

$$\frac{\text{No. of Rows} \times \text{Width of Row (Feet)} \times \text{Length of Run (Feet)}}{43,560 \text{ Feet}^2/\text{Acre}}$$

## Approximate Acreage Covered by Center Pivot

$$\text{Acres Covered} = \frac{(\text{Radius of wetted area, feet})^2 \times 3.14}{43,560}$$

For radius:

Without end guns — add 40 feet to length of machine

With end guns — add 75 feet to length of machine

## Irrigation Delivery Rate\* per Acre (gpm/acre)

Net irrigation application (inches/day)	System efficiency (percent)					
	50	60	70	80	90	100
	gpm/acre					
0.10	3.77	3.14	2.69	2.36	2.10	1.89
0.15	5.66	4.71	4.04	3.54	3.14	2.83
0.20	7.54	6.29	5.39	4.71	4.19	3.77
0.25	9.43	7.86	6.73	5.89	5.24	4.71
0.30	11.31	9.43	8.08	7.07	6.29	5.66
0.35	13.20	11.00	9.43	8.25	7.33	6.60
0.40	15.09	12.57	10.78	9.43	8.38	7.54
0.45	16.97	14.14	12.12	10.61	9.43	8.49
0.50	18.86	15.71	13.47	11.79	10.48	9.43

Field delivery rate = gpm/acre x acres irrigated

Net irrigation = gross irrigation x system efficiency

## Maximum Economical Pipe-flow Capacities

A rule of thumb for coupled and gated pipe:

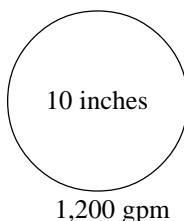
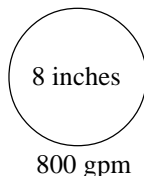
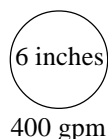

Kansas State University Agricultural Experiment Station and Cooperative Extension Service

MF-2404

November 1999

It is the policy of Kansas State University Agricultural Experiment Station and Cooperative Extension Service that all persons shall have equal opportunity and access to its educational programs, services, activities, and materials without regard to race, color, religion, national origin, sex, age or disability. Kansas State University is an equal opportunity organization. Issued in furtherance of Cooperative Extension Work, Acts of May 8 and June 30, 1914, as amended. Kansas State University, County Extension Councils, Extension Districts, and United States Department of Agriculture Cooperating, Marc A. Johnson, Director.





# Irrigation Information Resources Available on the Internet

## Irrigation Information Resources Available on the Internet

### Crop-Specific Irrigation Management

#### Corn

Texas Corn Production Emphasizing Pest Management and Irrigation. Texas AgriLife Extension Service publication B-6177. Texas A&M University System, College Station, TX. 72 pp. Companion Website: <http://lubbock.tamu.edu/cornIPM/>

#### Cotton

2005 Cotton Resource CD and Website <http://lubbock.tamu.edu/cottoncd/>  
2007 Cotton Resource DVD and Website <http://lubbock.tamu.edu/cottondvd/>  
Water Management Strategies for Cotton. Texas AgriLife Extension Service Publication L-2297

#### Sorghum

Texas AgriLife Research and Extension Center - Lubbock Sorghum web page  
<http://lubbock.tamu.edu/sorghum/>  
Grain Sorghum Irrigation. Texas AgriLife Extension Service publication B-6152. Texas A&M University System, College Station, TX. 8 pp  
[http://amarillo.tamu.edu/programs/irrigTexas AgriLife Extension Service/publications/Grain%20Sorghum%20Irrigation%20B-6152.pdf](http://amarillo.tamu.edu/programs/irrigTexas%20AgriLife%20Extension%20Service/publications/Grain%20Sorghum%20Irrigation%20B-6152.pdf).  
Irrigating Sorghum in South and South Central Texas. Texas AgriLife Extension Service publication L-5434. Texas A&M University System, College Station, TX. 6 pp.  
<http://itc.tamu.edu/documents/extensionpubs/L-5434.pdf>

#### Forage Crops

Irrigation of Forage Crops. Texas AgriLife Extension Service publication B-6150. Texas A&M University System, College Station, TX. 8 pp.  
[http://primera.tamu.edu/faculty/Juan\\_Enciso/Website/Exten%20pubs/B6150.pdf](http://primera.tamu.edu/faculty/Juan_Enciso/Website/Exten%20pubs/B6150.pdf)

#### Peanut

Texas Peanut Production Guide. Texas AgriLife Extension Service publication B-1514. Texas A&M University System, College Station, TX. 84 pp.  
<http://itc.tamu.edu/documents/extensionpubs/B-1514.pdf>  
Production of Virginia Peanuts in the Rolling Plains and Southern High Plains of Texas. Texas AgriLife Extension Service publication B -1514. Texas A&M University System, College Station, TX.

#### Wheat

Texas AgriLife Research and Extension Center - Lubbock Wheat web page  
<http://lubbock.tamu.edu/wheat/>

#### Turf

Aggie Horticulture <http://aggie-horticulture.tamu.edu/>  
Aggie Turf <http://aggieturf.tamu.edu/>  
Aggie Turf Tips <http://aggieturf.tamu.edu/turftips.htm>

Irrigation Technology Center <http://itc.tamu.edu/>  
Urban Water Conservation at Texas A&M University Agricultural Research and Extension  
Center, Lubbock, TX. <http://lubbock.tamu.edu/irrigate/homegarden.php> and  
<http://lubbock.tamu.edu/waterconservation/>  
Master Gardeners

## **Soil Moisture Management and Monitoring**

Irrigation Monitoring with Soil Water Sensors. Texas AgriLife Extension Service Fact Sheet B-6194. A&M University System, College Station, TX. 12 pp. <http://TexasAgriLifeExtensionServicebookstore.org/tmppdfs/18017893-2411.pdf>  
Pre-plant Irrigation Management. In: FOCUS on Entomology for South Plains Agriculture. S5-02/03. April 11, 2003. Texas A&M University Agricultural Research and Extension Center, Lubbock, TX.  
<http://lubbock.tamu.edu/irrigate/usefulPublications/prePlantIrrigation.pdf>  
Soil Moisture Management. Texas AgriLife Extension Service publication B-1670. Texas A&M University System, College Station, TX. 8pp.  
<http://itc.tamu.edu/documents/extensionpubs/B-1670.pdf>  
Measuring Soil Moisture. <http://Amarillo.tamu.edu/programs/irrigTexasAgriLifeExtensionService/publications/paper-.pdf>.  
Irrigation Management Using Electrical Resistance Blocks To Measure Soil Moisture .  
<http://agbiopubs.sdstate.edu/articles/FS899.pdf>  
USDA-NRCS Soil Moisture Resources  
[USDA-NRCS Soil Surveys  
Interactive Web Soil Survey <http://websoilsurvey.nrcs.usda.gov/app/WebSoilSurvey.aspx>  
Online Soil Surveys for Texas [http://soils.usda.gov/survey/online\\_surveys/texas/](http://soils.usda.gov/survey/online_surveys/texas/)]

**Texas High Plains Evapotranspiration (ET) weather station network** website and support materials and Texas AgriLife Extension Service publications

<http://txhighplainset.tamu.edu/>  
<http://txhighplainset.tamu.edu/usermanual.pdf>  
<http://txhighplainset.tamu.edu/terminology.jsp>  
GROWER'S GUIDE: Using PET for Determining Crop Water Requirements and Irrigation  
Scheduling  
<http://texaset.tamu.edu/growers.php>

Other regional weather data resources

National Weather Service; <http://www.srh.noaa.gov/>  
National Climate Data Center: <http://lwf.ncdc.noaa.gov/oa/ncdc.html>  
West Texas Mesonet (Texas Tech University): <http://www.mesonet.ttu.edu/>

## **Irrigation Best Management Practices**

Agricultural Water Conservation Practices (Texas Water Development Board)  
<http://www.twdb.state.tx.us/assistance/conservation/ConservationPublications/AgBrochure.pdf>  
Water Conservation Best Management Practices (BMP) Guide for Agriculture in Texas  
[http://www.tsswcb.state.tx.us/files/contentimages/water\\_conservation\\_bmp.pdf](http://www.tsswcb.state.tx.us/files/contentimages/water_conservation_bmp.pdf)  
USDA-NRCS National Conservation Practice Standards  
<http://www.nrcs.usda.gov/technical/Standards/nhcp.html>

### **Conservation Tillage**

Texas AgriLife Extension Service Conservation Tillage Website  
<http://conservationtillage.tamu.edu/>

Best Management Practices for Conservation/Reduced Tillage. Texas AgriLife Extension Service publication B-6189.

Best Management Practices for Conservation/Reduced Tillage. Texas AgriLife Extension Service Fact Sheet B-6189. Texas A&M University System, College Station, TX. 8 pp.  
<http://TexasAgriLifeExtensionServicebookstore.org/pubinfo.cfm?pubid=2313>

Southern Conservation Agricultural Systems Conference  
<http://www.ag.auburn.edu/auxiliary/nsdl/sctcsa/index.html>

USDA-NRCS National Conservation Practice Standards  
<http://www.nrcs.usda.gov/technical/Standards/nhcp.html>

## **Irrigation System Technologies**

### **Center Pivot Irrigation**

Center Pivot Irrigation. Texas AgriLife Extension Service Publication B-6096. Texas AgriLife Extension Service Fact Sheet L-5469. Texas A&M University System, College Station, TX. 20 pp.

<http://amarillo.tamu.edu/programs/irrigTexasAgriLifeExtensionService/publications/B-6096-CtrPivIrri.pdf>

Center Pivot Irrigation Workbook. Texas AgriLife Extension Service Fact Sheet B-6162. Texas A&M University System, College Station, TX. 35 pp.]

Economics of Irrigation Systems. Texas AgriLife Extension Publication B-6113  
<http://amarillo.tamu.edu/programs/irrigTexasAgriLifeExtensionService/publications/B-6113.pdf>

USDA-NRCS Conservation Practice Standards  
<http://www.nrcs.usda.gov/technical/Standards/nhcp.html>

USDA-NRCS Sprinkler Irrigation Standard:  
<ftp://ftp-fc.sc.egov.usda.gov/NHQ/practicestandards/standards/442.pdf>

### **Microirrigation**

Basics of Microirrigation. Texas AgriLife Extension Service Publication B-6160. Texas A&M University System, College Station, TX. 16 pp.]

Installing a Subsurface Drip Irrigation System for Row Crops . Texas AgriLife Extension Service Publication B-6151. Texas AgriLife Extension Service Fact Sheet B-6160. Texas A&M University System, College Station, TX. 7 pp.

Maintaining Subsurface Drip Irrigation Systems. Texas AgriLife Extension Service Publication L-5406. Texas A&M University System, College Station, TX. 6 pp.  
<http://itc.tamu.edu/documents/extensionpubs/L5406.pdf>

Planning and Operating Orchard Drip Irrigation Systems. Texas AgriLife Extension Service Publication B-1663 <http://amarillo.tamu.edu/programs/irrigTexasAgriLifeExtensionService/publications/paper-5.pdf>

USDA-NRCS Conservation Practice Standards  
<http://www.nrcs.usda.gov/technical/Standards/nhcp.html>

USDA-NRCS Microirrigation Standard:  
<ftp://ftp-fc.sc.egov.usda.gov/NHQ/practice-standards/standards/441.pdf>

## **Agricultural Water Conservation Practices**

Agricultural Water Conservation Practices

<http://www.twdb.state.tx.us/assistance/conservation/ConservationPublications/AgBrochure.pdf>

Water Conservation Best Management Practices (BMP) Guide for Agriculture in Texas

[http://www.tsswcb.state.tx.us/files/contentimages/water\\_conservation\\_bmp.pdf](http://www.tsswcb.state.tx.us/files/contentimages/water_conservation_bmp.pdf)

USDA-NRCS National Conservation Practice Standards

<http://www.nrcs.usda.gov/technical/Standards/nhcp.html>

Texas AgriLife Extension Service Conservation Tillage Website

<http://conservationtillage.tamu.edu/>

Best Management Practices for Conservation/Reduced Tillage. Texas AgriLife Extension Service Fact Sheet B-6189. Texas A&M University System, College Station, TX. 8 pp.

<http://TexasAgriLifeExtensionServicebookstore.org/pubinfo.cfm?pubid=2313>

Southern Conservation Agricultural Systems Conference

<http://www.ag.auburn.edu/auxiliary/nsdl/sctcsa/index.html>

USDA-NRCS National Conservation Practice Standards

<http://www.nrcs.usda.gov/technical/Standards/nhcp.html>

## **Irrigation Economics**

Economics of Irrigation Systems. Texas AgriLife Extension Service Fact Sheet Fact Sheet B-6050. Texas AgriLife Extension Service Fact sheet

<http://amarillo.tamu.edu/programs/irrigTexasAgriLifeExtensionService/publications/B-6113.pdf> Sheet B-6113. Texas A&M University System, College Station, TX. 20 pp

Calculating Horsepower Requirements and Sizing Irrigation Supply Pipelines. Texas AgriLife Extension Service Fact Sheet Fact Sheet B-6011. Texas AgriLife Extension Service Fact Sheet Fact Sheet B-6050. Texas AgriLife Extension Service Fact Sheet B-6113. Texas A&M University System, College Station, TX. 11 pp.

<http://itc.tamu.edu/documents/extensionpubs/B-6011.pdf>]

## **Water Quality**

### **Protecting water resources from contamination**

Pesticide Properties that Affect Water Quality. Texas AgriLife Extension Service Fact Sheet Fact Sheet B-6050. [Stevenson, Douglass E., Paul Baumann, and John A. Jackman. 1997. Pesticide Properties that Affect Water Quality. Texas AgriLife Extension Service Fact Sheet Fact Sheet B-6050. Texas AgriLife Extension Service Fact Sheet L-5417. Texas A&M University System, College Station, TX. 16 pp.

<http://publications.tamu.edu/publications/Water/b6050.pdf>]

### **Salinity Management**

Irrigation Water Quality Standards and Salinity Management Strategies. Texas AgriLife Extension Service Fact Sheet B-1667.

[Fipps, Guy. 2003. Irrigation Water Quality Standards and Salinity Management Strategies. Texas AgriLife Extension Service Fact Sheet B-1667. Texas A&M University System, College Station, TX. 20 pp. <http://itc.tamu.edu/documents/extensionpubs/B-1667.pdf>]

Irrigation Water Quality: Critical Salt Levels for Peanuts, Cotton, Corn and Grain Sorghum. Texas AgriLife Extension Service Fact Sheet L-5417.

[McFarland, Mark, Robert Lemon and Charles Stichler. 2003. Irrigation Water Quality: Critical Salt Levels for Peanuts, Cotton, Corn and Grain Sorghum. Texas AgriLife Extension Service Fact Sheet L-5417. Texas A&M University System, College Station, TX. 4 pp. <http://itc.tamu.edu/documents/extensionpubs/L-5417.pdf>]

Irrigation Management with Saline Water. [Porter, Dana and Thomas Marek. 2006. Irrigation Management with Saline Water. 2006. In: Proceedings of the 2006 Central Plains Irrigation Conference, Colby, KS, February 21-22, 2006.

<http://www.oznet.ksu.edu/irrigate/OOW/P06/Porter06.pdf> ]



# Publications Referenced in the Irrigation Training Program Manual

## **Publications Referenced in the Irrigation Training Program Manual**

Amosson, Steve; Leon New; Lal Almas; Fran Bretz; Thomas Marek. December 2001. Economics of Irrigation Systems. Texas Cooperative Extension. College Station, Texas. Publication Number B-6113.

Fipps, Guy. Calculating Horsepower Requirements and Sizing Irrigation Pipelines. Texas A&M University System Texas Agriculture Extension Service. College Station, Texas Publication Number B-6011.

Swanson, Charles and Guy Fipps. October 2008. The TexasET Network and Website User's Manual. Texas AgriLife Extension Service, Texas A&M University System.

Bynum, Josh; Tom Cothren; Tom Marek; Giovanni Piccinni. August 2007. Decision Support Systems: Tools for Implementing Best Management Practices in Texas. Texas Water Resources Institute. College Station, Texas. EM-100.

Fipps, Guy. Soil Moisture Management. Texas Agricultural Extension Service. College Station, Texas Publication Number B-1670.

Enciso, Juan M.; Dana Porter; Xavier Périès. January 2007. Irrigation Monitoring with Soil Water Sensors. Texas Cooperative Extension. Publication Number B-6194.

U.S. Department of Agriculture Natural Resources Conservation Service. April 1998. Estimating Soil Moisture by Feel and Appearance. Program Aid Number 1619.

Enciso, Juan M.; Xavier Périès. September 2005. Using Flexible Pipe with Surface Irrigation. Texas Cooperative Extension. Publication Number L 5469.

Rogers, Danny H.. July 1995. Managing Furrow Irrigation Systems. Kansas State University Cooperative Extension Service. Irrigation Management Series. Manhattan, Kansas. Publication Number L-913.

Fipps, Guy; Leon New. April 2005. Center Pivot Workbook. Texas Cooperative Extension. College Station, Texas. Publication Number B-6162.

U.S. Department of Agriculture Natural Resource Conservation Service. Utilizing Center Pivot Sprinkler Irrigation Systems to Maximize Water Savings.

Enciso, Juan; Dana Porter. January 2005. Basics of Microirrigation. Texas Cooperative Extension. Weslaco and Lubbock, Texas. Publication Number B-6160.

Enciso, Juan. July 2004. Installing a Subsurface Drip System for Row Crops. Texas Cooperative Extension. Publication Number B-6151.

Enciso, Juan; Dana Porter; Jim Bordvosky; Guy Fipps. July 2004. Maintaining Subsurface Drip Irrigation Systems. Texas Cooperative Extension. Publication Number L-5406.

Rogers, Danny H.; Freddie R. Lamm; Mahbub Alam. July 2003. Subsurface Drip Irrigation (SDI) Components: Minimum Requirements. Irrigation Management Series. Kansas State University Agricultural Experiment Station and Cooperative Extension Service. Publication Number MF-2576.

Rogers, Danny H. Rogers; Freddie R. Lamm; Mahbub Alam. July 2003. Subsurface Irrigation Systems Water Quality Assessment Guidelines. Irrigation Management Series. Kansas State University Agricultural Experiment Station and Cooperative Extension Service. Publication Number MF-2575.

Natural Resources Conservation Service. August 2006. Irrigation System, Microirrigation. Natural Resource Conservation Service Conservation Standard Publication Number 441-1.

Porter, Dana Porter. September 2007. Subsurface Drip Irrigation on the Internet. Ogallala Aquifer. Texas Cooperative Extension.

Stichler, Charles; Archie Abrameit; Mark McFarland. August 2006. Best Management Practices for Conservation/Reduced Tillage. Texas Cooperative Extension. Publication Number B-6189.

McFarland, Mark; Robert Lemon; Charles Stichler. March 2002. Irrigation Water Quality Critical Salt Levels for Peanuts, Cotton, Corn and Grain Sorghum. Texas Cooperative Extension. College Station, TX Publication Number L-5417.

Fipps, Guy. April 2003. Irrigation Water Quality Standards and Salinity Management Strategies. Texas Cooperative Extension. College Station, TX. Publication Number B-1667.

Porter, Dana. September 2007. Irrigation Salinity Management Information on the Internet. Ogallala Aquifer. Texas Cooperative Extension.

Stevenson, Douglass; Paul Baumann; John A Jackman. Pesticide Properties That Affect Water Quality. Texas Agricultural Extension Service. College Station, Texas Publication Number B-6050.

New, L. Leon; G. Fipps. Chemigation Equipment and Safety. Texas Agricultural Extension Service. Publication Number L-2422.

Baumann, Paul A.; Brent W. Bean. July 1998. Reducing Herbicides in Surface Water Best Management Practices. Texas Agricultural Extension Service. College Station. Publication Number L-5205.

Porter, Dana. September 2007. Chemigation and Water Quality Protection Information on the Internet. Ogallala Aquifer. Texas Cooperative Extension.



Rogers, Danny H.; William N. Sothers. May 1996. Predicting the Final Irrigation for Corn, Sorghum and Soybeans. Kansas State University Cooperative Extension. Manhattan, Kansas. Publication Number MF-2174.

Sansone, Christopher; Thomas Isikiet; Robert Lemon; Billy Warrick. *Excerpts from Texas Cotton Production Emphasizing Integrated Pest Management*. Texas Cooperative Extension. College Station, Texas.

Boman, Randy. Late Season Issues in 2006. Texas Cooperative Extension. Lubbock, Texas.

Stichler, Charles; Guy Fipps. February 2003. Irrigating Sorghum in South and South Central Texas. Texas Cooperative Extension. Publication Number L-5434.

Enciso, Juan; Dana Porter; Guy Fipps; Paul Colaizzi. May 2004. Irrigation of Forage Crops. Texas Cooperative Extension. Texas. Publication Number B-6150.

Stichler, Charles; David Bade. April 2003. Forage Bermuda Grass: Selection, Establishment and Management. Texas Cooperative Extension. Publication E-179.

Stichler, Charles; Steve Livingston. December 1998. Managing Annual Winter Grass in South and Southwest Texas. Texas Agricultural Extension Service. Publication Number L-5238.

Trostle, Calvin. April 2007. Late Season Wheat Irrigation for the Texas South Plains. Texas Cooperative Extension. Lubbock, Texas.

Miller, Travis D. Growth Stages of Wheat: Identification and Understanding Improve Crop Management. Texas Agricultural Extension Service. Publication Number SCS-1999-16.

Trostle, Calvin. July 2001. Optimum Irrigation for Black-Eyed Peas in West Texas. Texas Cooperative Extension. Lubbock, Texas.

Dainello, Frank J.. November 2003. Estimated Water Requirements for Vegetable Crops. Texas Cooperative Extension. College Station, Texas.

Fipps, Guy; Frank J. Dainello. Irrigation. *An excerpt from TCE Vegetable Handbook*. The Agriculture Program Texas Cooperative Extension, College Station, Texas.

Juan Enciso, Julian W. Sauls, Robert P. Wiedenfeld and Shad D. Nelson. 2008. Impacts of Irrigation on Citrus. Texas Cooperative Extension Fact sheet no. B-6205.

Bob Wiedenfeld, Juan Enciso, John Robinson, Guy Fipps. 2005. Irrigation of Sugarcane. Texas Cooperative Extension. Fact sheet No. B-6156.

Texas Water Development Board; Agricultural Water Conservation Practices.

Enciso, Juan; Steve Santistevan; Aung K Hla. August 2007. Propeller Flow Meters. Texas Cooperative Extension. Publication Number L-5492.

Rogers, Danny H.; Mahbub Alam. Irrigation Formulas and Conversions. Irrigation Management. Kansas State University.

Porter, Dana. February 2008. Irrigation Information Resources Available on the Internet. Texas AgriLife Extension Service.