

# Energy-Saving Design for Pressure Difference Control in Variable Flow Air Conditioning Systems

Yanhua Chen  
Senior Engineer  
Wuhan Architectural Design Institute, Wuhan, China, 430014  
Chenyh918@263.net

Zaipeng Zhang  
Postgraduate

**Abstract:** This paper analyzes energy-saving design for pressure-difference control in a variable flow air conditioning system, including the application of a pressure-difference control valve and the installation position of a pressure-difference transducer. The conclusion is that installing a pressure-difference control valve can increase hydraulic stability, and reduce pump head and pump energy consumption. The application of terminal control has the smallest energy consumption, but flow variation scope is narrower than everything else.

**Key words:** variable flow system; pressure difference control; valve authority; terminal control

## 1. FOREWARD

The traditional air conditioning water system usually adopts a constant flow system. As for this system, it is so wasteful that pump energy consumption with different loads all equals to that in the design service conditions. With the frequency conversion technology applied to air conditioning water system, people now find a better way for energy saving, i.e., to apply the variable flow technology to greatly reduce the pump energy consumption when an air conditioner is with partial load. However, variable flow air conditioning system is different from constant flow system, and the control methods that are applicable to constant flow system cannot be directly applied, otherwise the energy saving effect shall be weakened. The thesis makes some explanation for this in terms of pressure difference control and brings forward some rational energy-saving design measures of pressure difference control, which can be generally divided into two aspects: one is the energy-saving effect as obtained from adopting a pressure difference control valve to

keep the working pressure difference of control valve constant; the other is the energy-saving effect as obtained from setting pressure difference control points at different positions when making frequency-conversion and speed-conversion adjustment for pressure difference control pump.

## 2. ENERGY-SAVING EFFECT OBTAINED FROM ADOPTING PRESSURE DIFFERENCE CONTROL VALVES

The pump head of air conditioning water system is to overcome the resistance loss from cold and heat sources, end devices, pipes, control valves, various control and detection components, among which the resistance loss from control valves is increased manually and takes a considerable proportion, therefore, it is necessary to take measures to reduce this kind of resistance loss of valve.

The characteristic curve of heat exchangers usually is a salient curve. To achieve a linear relationship between the heat quantity exchanged of heat exchangers and the valve opening, a concave equal percentage or parabolic curve is expected. Refer to Figure 1 for such a relationship.

The characteristic curves of control valves can be divided into ideal characteristic curves and working characteristic curves. An ideal characteristic curve refers to the relationship between valve opening and the corresponding water flow when the pressure difference at both ends of the valve is constant. But due to water flow change, pressure difference at valve ends shall also change. Working characteristic curve shall deviates ideal characteristic curve to cause the valve control accuracy drop. In order to make working characteristic curve approaches ideal characteristic curve as close as

possible, pressure difference rate at valve ends shall be reduced. Valve authority can be used to describe this change which is defined as the ratio of the minimum pressure difference  $\Delta P_{min}$  on both ends of the valve when valve is full open and the maximum pressure difference  $\Delta P_{max}$  on both ends of the valve when the valve is completely closed. The closer to 1 valve authority is, the closer valve working

characteristic curve is to ideal characteristic curve and the more accurate the flow control with medium or small load is. Therefore,  $\Delta P_{min}$  is expected to be small whilst  $\Delta P_{max}$  to be large. For air conditioning water system, the valve authority is required to be over 50% and some documentation also requires the valve authority shall be no less than 30%.

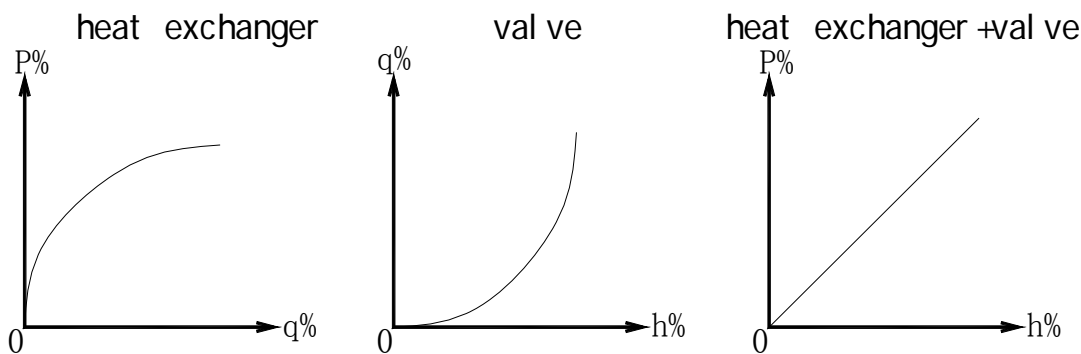

Fig.1 Relationship between heat quantity exchanged and valve opening

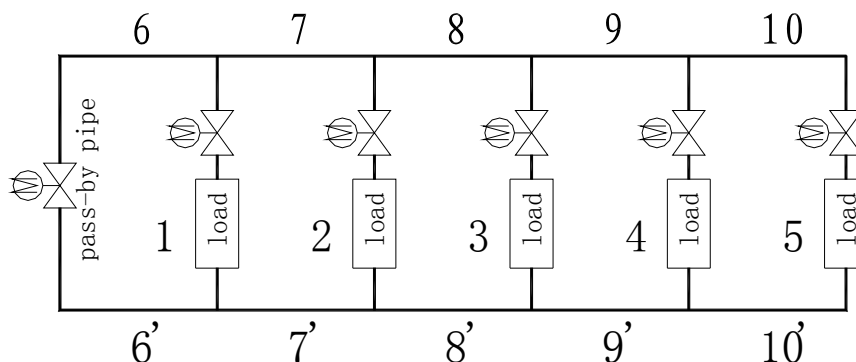

Fig.2 Map of air conditioning water system

The minimum pressure difference  $\Delta P_{min}$  of control valve is used in pump head calculation when valve is full open. The larger  $\Delta P_{min}$  is, the higher pump head shall be with the larger energy consumption. Therefore,  $\Delta P_{min}$  is expected to be as small as possible. It is clear from the above analysis that  $\Delta P_{min}$  must be reduced in order to have high control accuracy and low energy consumption. Examples shall be enumerated as follows to explain technical measures to reduce  $\Delta P_{min}$  and its energy-saving effect.

Figure 2 is an air conditioning water system map with by-pass pipe and pressure difference control device. The function of by-pass pipe is to bypass the flow difference between cold and heat source side and the client side, with the flow in by-pass pipe controlled by pressure difference control device installed at both ends of the by-pass pipe. From the

figure, it is clear that the maximum pressure difference  $\Delta P_{max}$  on both ends of every bypass at client side equals to the pressure set value of by-pass pipe. Therefore, at this time the minimum pressure difference  $\Delta P_{min}$  shall be 30%-50% of the pressure difference set valve which requires manually increasing the resistance loss when valve is full open which I turn shall increase the resistance loss of the whole system.

Install pressure difference control valve at both ends of the control valve, such as to adopt a self pressure difference control valve control or replace the control valve with dynamic equilibrium electric control valve can maintain the pressure difference at both ends of the valve. Valve authority becomes 1 with the most accurate flow control with medium or small load. Valve working characteristic curve coincides with ideal characteristic curve. The

maximum pressure difference  $\Delta P_{\max}$  equals the minimum pressure difference  $\Delta P_{\min}$  and reaches the minimum value. Meanwhile, the minimum pressure difference  $\Delta P_{\min}$  is no longer determined by pressure difference set value at both ends of the pass-by pipe which solves the contradiction between control accuracy and energy consumption. For example, a certain air conditioning water system with a head of a 35m water column, after subtracting the resistance loss of cold and heat source and the pipe on the side, the pressure difference set value of pass-by pipe is a 22m water column, thus the minimum pressure difference of control valve  $\Delta P_{\min}$  is about a 9m water column and that of a certain dynamic equilibrium electric control valve  $\Delta P_{\min}$  is a 3m water column. In the latter case, the pump head shall drop a 6m water column with distinct energy-saving effect.

### 3. PIPE NETWORK HYDRAULIC POWER CHARACTERISTIC CURVE OF AIR CONDITIONING WATER SYSTEM

Air conditioning water system is consist of chilled water system and cooling water system, the former is closed system, the latter is open-type system. As for open-type system, its pipe network hydraulic power characteristic curve is a generalized pipe network hydraulic power characteristic curve; as for closed system, no matter it is a constant flow air conditioning system or a variable flow air conditioning system, usually there sets a pressure difference control device whose pressure difference does not change with the flow change. Therefore, the hydraulic power characteristic curve of pipe network with pressure difference control device is also a generalized pipe network hydraulic power characteristic curve. Pump head depends not only on resistance  $S$  but also on pressure difference set value or position pressure difference, namely:

$$h = b + Sq^2 \quad (1)$$

In the formula  $h$  refers to pump head,  $q$  as pump flow,  $S$  as pipe line and  $b$  as pressure difference set value or position pressure difference.

Pipe network hydraulic power characteristic curve of air conditioning water system is shown in

figure 3 in which curve ① is the hydraulic power characteristic curve of heat source, end device and pipe while curve ② is the hydraulic power characteristic curve of pipe network. In fact, curve ② is generated by moving curve ① in parallel upwards by  $b$  units.  $b$  refers to pressure difference set value.

### 4. EFFECT OF PRESSURE DIFFERENCE RATE ON FREQUENCY-CONVERSION AND SPEED-CONVERSION SERVICES CONDITIONS FOR PUMPS

#### 4.1 Definition of Pressure Difference Rate

Definition: it refers to the ratio of pressure difference set value  $b$  against total system head, which is indicated as letter  $B$ , that is:

$$B = \frac{b}{h} \quad (2)$$

The pressure difference set value relates to the install position of system pressure difference control point. There are mainly two ways to set the position: ① to set pressure difference control point on the main backwater supply pipe of air conditioner, with the pressure difference set value as the total resistance loss of the most unfavorable bypass. The most unfavorable bypass here refers to the bypass with the maximum resistance installed in parallel on the main backwater supply pipe. Since this install position usually locates at the two ends of by-pass pipe, this control is known for short as pass-by control. ② to set pressure difference control point on the end device of the most unfavorable bypass and the two ends of control valve with the pressure difference set value as the total resistance loss of end device and control valve. This method of pressure difference control is called for short as terminal control.

Pressure difference rates in the two methods of pressure difference control are different. The pressure difference rate in terminal control is small while in pass-by control is large. Set the air conditioning system mentioned above as an example, after working out that the pressure difference rate with terminal control is approximately 21% whilst the pass-by control is 45%. Graphical methods shall be used in the following to analyze the influence of

pressure difference rate on the energy-saving effect in case of adjustment in frequency-conversion and speed-conversion services conditions for pumps.

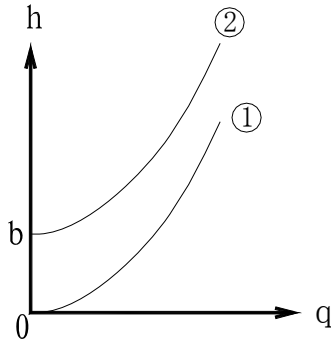

**Fig.3 Pipe network hydraulic characteristic curve of air conditioning water system**

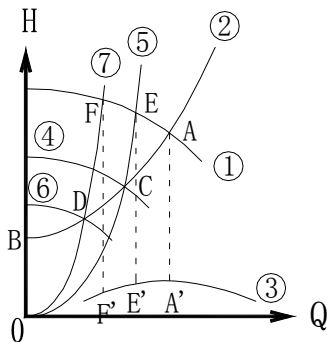

**Fig.4 Effect of pressure difference rate on pump efficiency**

4.2 Effect of Pressure Difference Rate on Pump Efficiency

As shown in figure 4, the horizontal coordinate indicates comparative flow  $Q$  while the longitudinal coordinate indicates comparative head  $H$ , curve ① is pump characteristic curve, curve ② is pipe network hydraulic power characteristic curve, curve ③ is pump efficiency curve and curve ④ and ⑥ are pump characteristic curve after frequency conversion. The design service condition at point  $A$  corresponds with pump efficiency  $A'$  where the efficiency is the highest. After pump frequency conversion, pump actual working point is  $C$ . Print a parabola ⑤ cross point  $C$  to intersect with curve ① at point  $E$ , then point  $C$  and point  $E$  has the same service condition with the equal efficiency. Since the corresponding pump efficiency point  $E'$  of point  $E$  is smaller than point  $A'$ , pump efficiency at service condition  $C$  is smaller than at service condition  $A$ . Likewise, after the further pump frequency conversion to point  $D$ , the efficiency at

point  $D$  service condition point  $F'$  reduces more. Therefore when there exists pressure difference rate in water system, after frequency conversion pump efficiency shall fall. The larger the frequency conversion is, the sharper the frequency drop is.

4.3 Effect of Pressure Difference Rate on Pump Efficiency

As shown in figure 5, when pressure difference rate is  $B$ , pump frequency conversion reaches curve ④, the service condition point is  $C$  and the corresponding efficiency is  $E'$ . When pressure difference rate reduces to  $B'$ ,  $D$  point has the same flow with point  $C$ . The corresponding efficiency point of  $E$  is  $F'$ . From the figure it is shown that under the same flow, along with the decrease of pressure difference rate, pump efficiency gradually approaches the designed service condition efficiency.

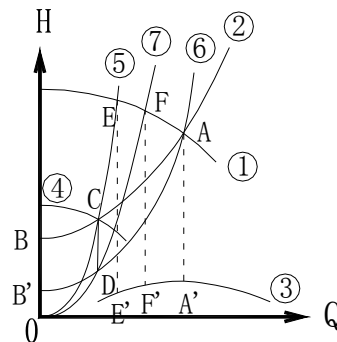

**Fig.5 Effect of pressure difference rate on pump efficiency**

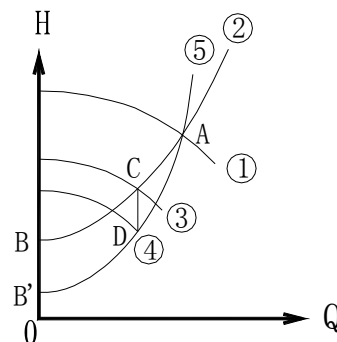

**Fig.6 Effect of pressure difference rate on pump head**

4.4 Effect of Pressure Difference Rate on Pump Head

As shown in figure 6, when pressure difference rate is  $B$ , pump frequency conversion reaches curve ④, the service condition point is  $C$ . When pressure difference rate reduces to  $B'$ ,  $D$  point has the same

flow with point C. The head of designed service condition point A is:

$$H_A = B + SQ_A^2 \quad (3)$$

From formula (3) it can be inferred that

$$S = \frac{H_A - B}{Q_A^2} \quad (4)$$

Then the heads at point C and point D are:

$$H_C = B + \frac{H_A - B}{Q_A^2} Q_C^2 \quad (5)$$

$$H_D = B' + \frac{H_A - B'}{Q_A^2} Q_D^2 \quad (6)$$

Since  $Q_C=Q_A$ , therefore the head difference of two pressure difference rates is:

$$\begin{aligned} \Delta H &= H_C - H_D = (B - B') + \frac{Q_C^2}{Q_A^2} (H_A - B - H_A + B') \\ &= \left(1 - \frac{Q_C^2}{Q_A^2}\right) (B - B') \quad (7) \end{aligned}$$

From formula (7) we can see that when  $Q_C$  reduces, the head difference shall increase. Therefore, with the same flow, along with the decrease of pressure difference rate, pump head shall gradually reduce. Along with the decrease of flow, head difference shall increase and the head of system with small pressure difference rate obviously surpasses that of system with large pressure difference rate.

#### 4.5 Effect of Pressure Difference Rate on Pump Energy Consumption

Pump energy consumption is

$$N = \frac{QH\rho g}{\eta} \quad (8)$$

In figure 6 the energy consumption difference of two back pressures is

$$\begin{aligned} \Delta N &= \frac{Q_C H_C \rho g}{\eta_C} - \frac{Q_C H_D \rho g}{\eta_D} = Q_C \rho g \left( \frac{H_C}{\eta_C} - \frac{H_D}{\eta_D} \right) \\ &> \frac{Q_C \rho g}{\eta_D} \left( 1 - \frac{Q_C^2}{Q_A^2} \right) (B - B') \quad (9) \end{aligned}$$

It can be inferred from formula (9) that the system with smaller pressure difference rate is more energy-saving.

#### 4.6 Effect of Pressure Difference Rate on the Scope of Pump Frequency Conversion

As shown in figure 7, when pressure difference rate is B, pump frequency conversion reaches curve ④, the service condition point is C. When pressure difference rate reduces to B', to reach the same water flow, the frequency must be converted to curve ⑥. Since pump frequency conversion has a limit, the smaller pressure difference rate is, the narrower the scope of system water flow change is.

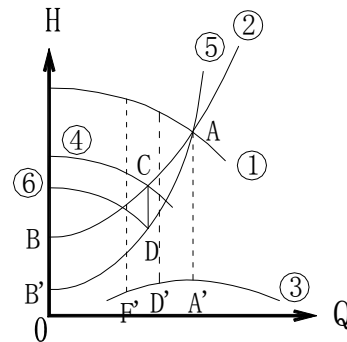

**Fig.7 Effect of pressure difference rate on pump frequency conversion scope**

### 5. CONCLUSIONS

1) Use pressure difference control valve to maintain the working pressure difference of control valve can not only improve pipe network hydraulic stability and the control accuracy of control valve, but also reduce the designed head of water system with distinct energy-saving effect.

2) When the pump applies terminal control, pressure difference rate shall be small and it has better effect on pump efficiency, pump head and pump energy consumption than pass-by control. It is recommended to use terminal control in variable flow air conditioning system.

3) Pay attention that the pump frequency conversion scope with small pressure difference rate is smaller than that with large pressure difference rate, therefore the flow control scope of terminal control is smaller than that of pass-by control.

## REFERENCES

- [1] Yongzheng FU, Keqi WU. Energy-Saving Effects of Back Pressure on Adjustment in Frequency-Conversion and Speed-Conversion of Pumps and fans. Heating and Ventilating & Air Conditioning, 2004, 34(3): 70-72.(In Chinese)
- [2] Zhaoyu SHI. Adjustment and Control of Operation of Heat Supply System. Beijing: Tsinghua University Press, 1994. (In Chinese)
- [3] Junliang SHI. Selection of Control Valves. Beijing: China Architecture & Building Press, 1986. (In Chinese)
- [4] LUTHER K. Variable volume pumping fundamentals. Heating Piping Air Conditioning, 1998 (8).
- [5] LUTHER K. Variable volume pumping fundamentals. Heating Piping Air Conditioning, 1998 (10).
- [6] Jianxing LI, Guangbei TU, Dai TU. A Discussion on Design and Control of Secondary Pumps, Heating and Ventilating & Air Conditioning, 2005, 35 (6): 91-94. (In Chinese)
- [7] Yijian SUN. Variable Flow Energy-Saving Control of Air Conditioning Water System. Heating and Ventilating & Air Conditioning, 2001, 31 (6): 21-25. (In Chinese)
- [8] LiWANG, Nianping LI, Shunxin LONG, etc. Application of Pressure Difference Control in Variable Flow Air-Conditioning System. China Water & Wastewater, 2003, 19 (3): 66-68.(In Chinese)