

**AN INTEGRATED APPROACH FOR TECHNO-  
ECONOMIC AND ENVIRONMENTAL ANALYSIS OF  
ENERGY FROM BIOMASS AND FOSSIL FUELS**

A Thesis

by

TANYA MOHAN

Submitted to the Office of Graduate Studies of  
Texas A&M University  
in partial fulfillment of the requirements for the degree of

MASTER OF SCIENCE

December 2005

Major Subject: Chemical Engineering

**AN INTEGRATED APPROACH FOR TECHNO-ECONOMIC  
AND ENVIRONMENTAL ANALYSIS OF ENERGY FROM  
BIOMASS AND FOSSIL FUELS**

A Thesis

by

TANYA MOHAN

Submitted to the Office of Graduate Studies of  
Texas A&M University  
in partial fulfillment of the requirements for the degree of

MASTER OF SCIENCE

Approved by:

Chair of Committee,  
Committee Members,  
Head of Department,

Mahmoud El-Halwagi  
Juergen Hahn  
Bruce A. McCarl  
Kenneth R. Hall

December 2005

Major Subject: Chemical Engineering

## ABSTRACT

An Integrated Approach for Techno-economic and Environmental Analysis of  
Energy from Biomass and Fossil Fuels. (December 2005)

Tanya Mohan, B.Eng., Thapar Institute of Engineering and Technology, India

Chair of Advisory Committee: Dr. Mahmoud El-Halwagi

Biomass conversion into forms of energy is receiving current attention because of environmental, energy and agricultural concerns. The purpose of this thesis is to analyze the environmental, energy, economic, and technological aspects of using a form of biomass, switchgrass (*panicum virgatum*), as a partial or complete replacement for coal in power generation and cogeneration systems. To examine the effects of such a substitution, an environmental biocomplexity approach is used, wherein the agricultural, technological, economic, and environmental factors are addressed. In particular, lifecycle analysis (LCA) and a three-dimensional integrated economic, energy and environmental analysis is employed. The effectiveness of alternate technologies for switchgrass preparation, harvest and use in terms of greenhouse gas impact, cost and environmental implications is examined. Also, different scenarios of cofiring and biomass preparation pathways are investigated. Optimization of the total biomass power generation cost with minimum greenhouse gas effect is undertaken using mathematical programming for various alternate competitive biomass processing pathways. As a byproduct of this work a generic tool to optimize the cost and greenhouse gas emissions for allocation of fuel sources to the power generating sinks is developed. Further, this work discusses the sensitivity of the findings to varied cofiring ratios, coal prices, hauling distances, per acre yields, etc.

Besides electricity generation in power plants, another viable alternative for reducing greenhouse gases (GHGs) is the utilization of biomass in conjunction with combined heat and power (CHP) in the process industries. This work addresses the utilization of biowaste or biomass source in a processing facility for CHP. A systematic

algebraic procedure for targeting cogeneration potential ahead of detailed power generation network design is presented. The approach presented here effectively utilizes the biomass and biowaste sources as external fuel, and matches it with the use and dispatch of fuel sources within the process, heating and non-heating steam demands, and power generation. The concept of extractable energy coupled with flow balance via cascade diagram has been used as a basis to construct this approach. The work also discusses important economic factors and environmental policies required for the cost-effective utilization of biomass for electricity generation and CHP.

## ACKNOWLEDGEMENTS

I would like to thank a number of people who have constantly encouraged me during the course of my graduate studies. First, I am very grateful to Dr. Mahmoud El-Halwagi, my advisor, who has endlessly encouraged, guided and supported me throughout my graduate studies at Texas A&M University. I highly appreciate his constant reviews and supervision. He has continuously shared his professional experiences in various fields with an open mind. I have learned greatly from his sense of perfection, his novel approach to dealing with various problems and an eye for the minutest details and depth.

I wish to express my gratitude to Dr. Bruce McCarl, my committee member, whose advice and suggestions on agricultural and economic aspects of the project were invaluable. My sincere thanks are due to Dr. Juergen Hahn, my committee member and project supervisor, for his valuable suggestions, advice and help. I am also thankful to him for hiring me as a part-time researcher on the US Department of Energy project that has helped me both professionally and financially.

I wish to thank all the members of my group for their constant cooperation and support. I am deeply indebted to Xiaoyun Qin and Dr. Gerald Cornforth, my co workers on this project, who have graciously assisted me in this work.

I am thankful to the US Department of Energy, US Department of Agriculture and the National Resources Conservation Service for the funding of this project.

Above all, I would like to thank my family and friends, especially my parents, Dr. Harsh Mohan and Dr. Praveen Mohan, my sister, Sugandha, and my friend, Vivek Siwatch, for their encouragement, support and inspiration. They have helped me pursue my dreams and it would not have been possible to complete my graduate studies and my thesis without their never-ending help and support.

## NOMENCLATURE

$BF_c$	Burning fraction of carbon which is 99% (as used by EPA)
$BF_{c,coal}$	Burning fraction of carbon in coal
$BF_{c,sw}$	Burning fraction of carbon in switchgrass
$C_{coal}$	National average cost of coal
$C_{GHG}$	Emission price of equivalent carbon dioxide
$C_{modi}$	Cost of modification of plant to cofire biomass with coal
$C_{SO_x}$	Cost of allowance for $SO_x$ reduction
$C_{sw}$	Cost of switchgrass (includes preparation and delivery)
$e$	Extractable energy
$E$	Extractable Power
$E_{CH_4,co}$	Emissions of $CH_4$ in cofiring
$E_{CO,co}$	Emissions of CO in cofiring
$EF_{CO_2}$	Emission factor for carbon dioxide
$EF_{SO_x,coal}$	Emission factor of $SO_x$ for coal
$EF_{SO_x,sw}$	Emission factor of $SO_x$ for switchgrass
$E_{GHG,co}$	Emissions of greenhouse gases during cofiring
$E_{GHG,co,lc}$	Greenhouse gas emissions during cofiring (lifecycle)
$E_{GHG,coal,bn,lc}$	Greenhouse gas emissions from coal burnt alone (lifecycle)
$E_{GHG,sw,lc}$	GHG Emissions from switchgrass burnt alone (lifecycle)
$E_{SO_x,co}$	Emissions of $SO_x$ during cofiring
$F$	Flow rate
$F_{sink}$	Flow going out of header interval
$F_{source}$	Flow from steam generated going into header interval
$H$	Enthalpy
$HHV_{fuel}$	High heating value of fuel
$HHV_{sw}$	High heating value of switchgrass
$H^{in}$	Inlet enthalpy

HP	High Pressure
LP	Low pressure
MP	Medium Pressure
$MW_c$	Molecular weight of C
$MW_{CaSO_4}$	Molecular weight of $CaSO_4$
$MW_{CO_2}$	Molecular weight of $CO_2$
$MW_s$	Molecular weight of sulfur
$MW_{SO_x}$	Molecular weight of $SO_x$
$NPHR_{fuel,co}$	Net plant heat rate of fuel cofired
$NPHR_{sw,bn}$	Net plant heat rate of switchgrass burned alone
$NPHR_{sw,co}$	Net plant heat rate of switchgrass cofired
$P_{ash,coal}$	Ash content in coal
$P_{ash,sw}$	Ash content in switchgrass
$P_c$	Carbon content in fuel
$P_{c,coal}$	Carbon content in coal
$P_{c,sw}$	Carbon content in switchgrass
$P_{s,coal}$	Sulfur content in coal
$Q_{elec}$	Electricity generated
$Q_{elec,co}$	Electricity generated by cofiring
$Q_{sw,bn}$	Electricity generated by burning switchgrass alone
$R_{CaCO_3/SO_x}$	Ratio of $CaCO_3$ to $SO_x$ in $SO_x$ treatment
$r_k$	Residual flow from the header k-1 going to header k
$R_{sw,co}$	Switchgrass cofiring ratio
$R_{sw,thermal}, \alpha$	Biomass cofiring ratio
$T_t$	Target temperature
VHP	Very high pressure
W	Power
w	Specific work
$W_{CaCO_3}$	Weight of $CaCO_3$

$W_{\text{CaSO}_4}$	Weight of $\text{CaSO}_4$
$W_{\text{coal,bn}}$	Weight of coal burnt alone
$W_{\text{coal,co}}$	Weight of coal used in cofiring
$W_{\text{fuel,co}}$	Weight of the fuel cofired
$W_{\text{SO}_x,\text{co,credit}}$	Weight of $\text{SO}_x$ used in cofiring that is credited
$W_{\text{SO}_x,\text{contr}}$	Weight of $\text{SO}_x$ controlled
$W_{\text{sw,bn}}$	Weight of switchgrass for switchgrass burnt alone
$W_{\text{sw,co}}$	Weight of switchgrass used in cofiring
$W_{\text{waste,co}}$	Total amount of waste from cofiring
$W_{\text{waste,reused}}$	Weight of waste that can be reused
$H_{\text{header}}^{\text{out}}$	Enthalpy at the header outlet temperature and pressure
$\eta$	Efficiency factor
$\delta_k$	Energy residual from interval k
$F_k$	Cumulative flow rate of interval k
$\dot{m}$	Mass flow rate
$\Delta H^{\text{header}}$	Enthalpy difference between headers
$\Delta H^{\text{real}}$	Actual enthalpy difference
$T_s$	Supply temperature
$\eta_{\text{header}}$	Header efficiency
$\eta_{\text{is}}$	Isentropic efficiency



## TABLE OF CONTENTS

	Page
ABSTRACT.....	iii
ACKNOWLEDGEMENTS.....	v
NOMENCLATURE.....	vi
TABLE OF CONTENTS.....	ix
LIST OF FIGURES.....	xi
LIST OF TABLES.....	xiv
I. INTRODUCTION.....	1
II. PROBLEM STATEMENT.....	5
III. LITERATURE REVIEW.....	8
Biomass: Energy and Greenhouse Gas Management.....	8
Process Optimization.....	13
Process Integration.....	15
Energy Integration.....	16
Cogeneration.....	22
IV. INTEGRATED SWITCHGRASS LIFE CYCLE ANALYSIS.....	28
Objectives.....	31
Methodology.....	31
Key Results.....	54
Sensitivity Analysis.....	56
Carbon-Dioxide-Equivalent Emission Price.....	58
Conclusions.....	68
V. OPTIMIZATION OF BIOMASS ELECTRICITY PRODUCTION COST.....	69
Objective.....	69
Methodology.....	69
Results and Discussion.....	76
Conclusions.....	83
VI. OPTIMUM ALLOCATION OF BIOMASS AND FOSSIL FUEL TO POWER PLANTS.....	84
Problem Statement.....	84

	Page
Methodology.....	85
Case Study.....	91
Conclusions.....	101
VII. BIOMASS IN COGENERATION SYSTEMS.....	102
Problem Statement.....	104
Methodology.....	105
Case Study 1: No External Biofuel Requirement.....	113
Case Study 2: External Biofuel Requirement.....	118
Biomass CHP: GHG Effects and Emission Pricing.....	123
Conclusions.....	127
VIII. CONCLUSIONS.....	128
IX. FUTURE WORK.....	131
REFERENCES.....	132
APPENDIX.....	137
VITA.....	185

## LIST OF FIGURES

FIGURE	Page
2.1 Biomass use for electricity generation and cogeneration .....	6
3.1 Temperature interval diagram.....	18
3.2 Cascade diagram.....	19
3.3 Revised cascade diagram.....	20
3.4 Grand composite curve.....	21
3.5 Mollier diagram with header and isentropic outlet conditions.....	24
3.6 Extractable power cogeneration targeting pinch diagram.....	26
4.1 Emission and energy pathways for switchgrass.....	33
4.2 Overall approach for switchgrass preparation including delivery to power plant.....	35
4.3 Structural monomer of cellulose.....	36
4.4 Structural monomer of hemi cellulose.....	36
4.5 Comparison of various combinations of alternative activities of switchgrass preparation for cost evaluation.....	38
4.6 Total machinery related GHG emissions for switchgrass preparation.....	40
4.7 Tracking model for losses of switchgrass.....	45
4.8 Effect of cofiring ratio on switchgrass net plant heat rate.....	49
4.9 GHG mitigation of switchgrass processing before combustion for different alternative activity combinations.....	57
4.10 GHG emissions as a function of cofiring ratio.....	58
4.11 Effect on switchgrass and coal cost as CO <sub>2</sub> emission price breaks even.....	61
4.12 Effect of cofiring ratio on cost of cofiring.....	63
4.13 CO <sub>2</sub> emission price as a function of cofiring ratio.....	64
4.14 CO <sub>2</sub> emission price as a function of the hauling distance of switchgrass.....	65
4.15 CO <sub>2</sub> emission price as a function of yield of switchgrass.....	66

FIGURE	Page
4.16 Cost of cofiring as a function of switchgrass thermal efficiency enhancement.....	67
5.1 Variation of biomass electricity cost as a function of emission price and cofiring ratio for biomass cost of \$35/ton.....	77
5.2 Variation of biomass electricity cost as a function of emission price and cofiring ratio for biomass cost of \$73/ton.....	78
5.3 Biomass electricity cost as a function of model pathways for 10% cofiring.....	79
5.4 Biomass electricity cost as a function of model pathways for 80% cofiring.....	80
5.5 Variation of emission price with cofiring ratio for lower and higher biomass costs.....	81
5.6 Effect of cofiring and biomass cost on biomass power generation cost with plant modification.....	82
6.1 Allocation network for biomass and fossil fuel to existing and new plants.....	86
6.2 Effect of power plant generation on the plant efficiency.....	88
6.3 Increase in net plant heat rate as a function of cofiring ratio.....	89
6.4 Effect of cofiring ratio on switchgrass required.....	92
6.5 Effect of cofiring ratio on coal required.....	92
6.6 Effect of cofiring ratio on electricity production cost.....	93
6.7 Effect of cofiring ratio on GHG emissions generated.....	93
6.8 Effect of cofiring ratio and plant size on the power demand.....	94
6.9 Effect of plant size on the power demand.....	94
6.10 Effect of plant efficiency on the electricity production cost.....	95
6.11 Allocation scheme for two switchgrass farms and a coal mine to two existing power plants.....	96
6.12 Allocation scheme for two switchgrass farms and a coal mine to two existing power plants and a new power plant.....	97
6.13 Alternate allocation scheme for two switchgrass farms and a coal mine to two existing power plants and a new power plant.....	99

FIGURE	Page
6.14 Allocation scheme for three switchgrass farms and a coal mine to two existing power plants.....	100
7.1 Biomass and biowaste use for cogeneration to meet steam demands.....	106
7.2 Flow balance around a header interval.....	107
7.3 Cascade diagram for cogeneration potential.....	108
7.4 Revised cascade diagram for cogeneration potential.....	109
7.5 Methodology for algebraic approach to target cogeneration potential and minimum bio fuel requirement.....	112
7.6 Cascade diagram for case study 1.....	114
7.7 Revised flow balance cascade diagram for case study 1.....	115
7.8 Validation of cogeneration potential by graphical technique.....	117
7.9 Flow balance cascade diagram for case study 2.....	119
7.10 Revised flow balance cascade diagram for case study 2.....	120
7.11 Net flows for case study 2.....	121
7.12 Biomass electricity production cost as a function of cofiring ratio.....	124
7.13 Biomass CHP cost as a function of cofiring ratio.....	125
7.14 Carbon dioxide emission price for biomass electricity production and biomass CHP.....	126

## LIST OF TABLES

TABLE	Page
4.1 Switchgrass ultimate analysis.....	34
4.2 Cell wall constituents of switchgrass.....	35
4.3 GHG emissions and energy consumption from preparation of switchgrass.....	39
4.4 GHG emissions and energy consumption from use of lime and chemicals.....	42
4.5 GHG emissions from lost switchgrass.....	44
4.6 Emission factor of biomass-fired boiler.....	46
4.7 Emissions from switchgrass-fired alone.....	47
4.8 Average emission factors of coal fired electric generation.....	51
4.9 GHG emissions from cofiring 10% switchgrass with coal.....	51
4.10 GHG emissions from post combustion activities of switchgrass-fired alone.....	52
4.11 GHG emissions from post combustion activities.....	53
4.12 Net energy gain of switchgrass as a bioenergy feedstock.....	54
4.13 GHG emissions from switchgrass alone and from 10% cofiring of switchgrass with coal.....	55
6.1 Data for two switchgrass and one coal mine sources to two existing plants.....	96
6.2 Data for two switchgrass and one coal mine sources to new and existing plants.....	98
6.3 Alternative scheme data for two switchgrass and one coal mine sources to new and existing plants.....	99
6.4 Data for three switchgrass and a coal mine sources to existing plants.....	101
7.1 Extractable power header interval diagram.....	111
7.2 Surplus data for case study 1.....	113
7.3 Deficit data for case study 1.....	114
7.4 Extractable power header interval diagram for case study 1.....	116

TABLE	Page
7.5 Surplus data for case study 2.....	118
7.6 Deficit data for case study 2.....	118
7.7 Extractable power header interval diagram for case study 2.....	122

## I. INTRODUCTION

Fossil fuel usage is the main contributor to the production of anthropogenic greenhouse gas (GHG) emissions. Of total 2002 U.S. carbon dioxide emissions, 98.0 percent, or 5,682 million metric tons, resulted from fossil fuel combustion (Mintzer et al., 2003). Overall, total U.S. GHG emissions have risen by 13 percent from 1990 to 2002 (Hockstad and Hanle, 2004). Expectations are that in the near term this will continue to rise. The Intergovernmental Panel on Climate Change indicates that continued emissions, will lead to a temperature increase of between 1.4°C to 5.8°C over the period 1990 to 2100, projecting a decadal increase of between 0.15°C and 0.35°C which is greater than the estimated maximum average temperature increase that the environment can withstand without damage (0.1°C per decade). Therefore, the IPCC and others suggest that CO<sub>2</sub> emissions must be decreased (Watson and Albritton, 2002). Several policies have been proposed to limit net GHG emissions. A key example is the Kyoto Protocol. In the US, despite rejecting the opportunity to ratify the Kyoto protocol, the “Clear Skies Initiative”, was announced by President Bush, which calls for an 18% reduction in the intensity of GHG emissions per unit GDP (Winters, 2002).

One mechanism that can be used to mitigate GHG emissions is substitution of alternative less emission intensive fuels for fossil fuels. Substitution of biomass replaces fossil fuels and their inherent emissions with recycling where carbon is withdrawn from the atmosphere via photosynthesis during feedstock growth and then is released upon combustion. Biomass fuels considered for cofiring include wood waste, short rotation woody crops, short rotation herbaceous crops (e.g., switchgrass), manure, landfill gas, wastewater treatment gas, etc. Use of switchgrass in electrical generation is one of the main alternatives and is considered in this analysis.

---

This thesis follows the style and format of *Chemical Engineering Communications*.



Studies for evaluating the feasibility and cost of replacing coal use with switchgrass appear promising (Boylan et al., 2000). The main questions regarding such a substitution are:

- How cost competitive is such an action?
- What are the environmental implications of this action?
- What is the net GHG balance considering the GHGs emitted across the life of the biofuel feedstock versus the replaced fossil fuel?
- How can biomass and coal be optimally allocated to existing or new plants?
- How can this action compete with biomass and conventional combined heat and power techniques?

This thesis summarizes the results of an investigation into these questions using a life cycle based environmental biocomplexity approach and, mathematical and algebraic optimization techniques that addresses agricultural, technological, economic, and environmental factors along with their interactions.

This thesis attempts to:

- Provide an economic, energy and environmental evaluation of the prospects for switchgrass as a bioenergy feedstock into electricity generation using lifecycle and environmental biocomplexity analysis.
- Examine how potential GHG emission pricing alternatives might influence the relative efficiencies of alternative technologies and other strategies as well as the power generation market penetration of biomass.
- Examine the sensitivity of the findings in the face of a wide spectrum of possibilities for switchgrass production, preparation and delivery as well as the degree of desirable cofiring in the power plants.
- Develop an optimization technique to screen alternative switchgrass preparation techniques.
- Formulate a mathematical programming model based on life cycle analysis of switchgrass to minimize total electricity cost and mitigate GHG emissions.

- Develop strategies to allocate biomass and fossil fuels so as to minimize GHG emissions and cost.
- Examine and compare the economics of biomass electricity generation and biomass combined heat and power.
- Develop an algebraic technique to target cogeneration potential using biomass as the external fuel.

Having provided a brief overview of the work completed in this thesis, it is important to lay out a format that will be presented in this work. The problem statement will be described in detail in Section II. Section III will provide literature reviewed for energy from biomass, and a brief mention of the policies for green house gas mitigation. Relevant concepts for process optimization via mathematical programming will be highlighted. Further, an overview of combined heat and power technology will be given. The life cycle and biocomplexity analysis of switchgrass will be presented in Section IV. The scope of the Biocomplexity/Life Cycle Analysis approach will include switchgrass production items, GHG emissions and energy consumption, carbon sequestration, loss of switchgrass that is scattered and embedded in the soil during transportation that leads to GHG emissions upon degradation, energy and emissions from switchgrass combustion versus coal consumption and energy consumed during the production and transport of inputs to switchgrass cultivation including lime, fertilizers and herbicides. Also, sensitivity of the findings in the face of a wide spectrum of possibilities for switchgrass production, preparation and delivery as well as the degree of desirable cofiring of power plants will be presented here. The optimization of the life cycle analysis to screen alternate biomass preparation techniques and minimize total electricity production and emission price will be discussed in Section V. Section VI will describe the optimal allocation strategies for routing of biomass and fossil fuel to direct combustion power plants. In this section, the engineering studies for cofiring, fuel supply and operational considerations are discussed. Then, Section VII will introduce the algebraic technique for targeting cogeneration potential and compare economics of biomass cogeneration

with energy from biomass and conventional sources. Conclusions and Future Work regarding this work will be contained in Section VIII and IX followed by the References and Appendix respectively.

## II. PROBLEM STATEMENT

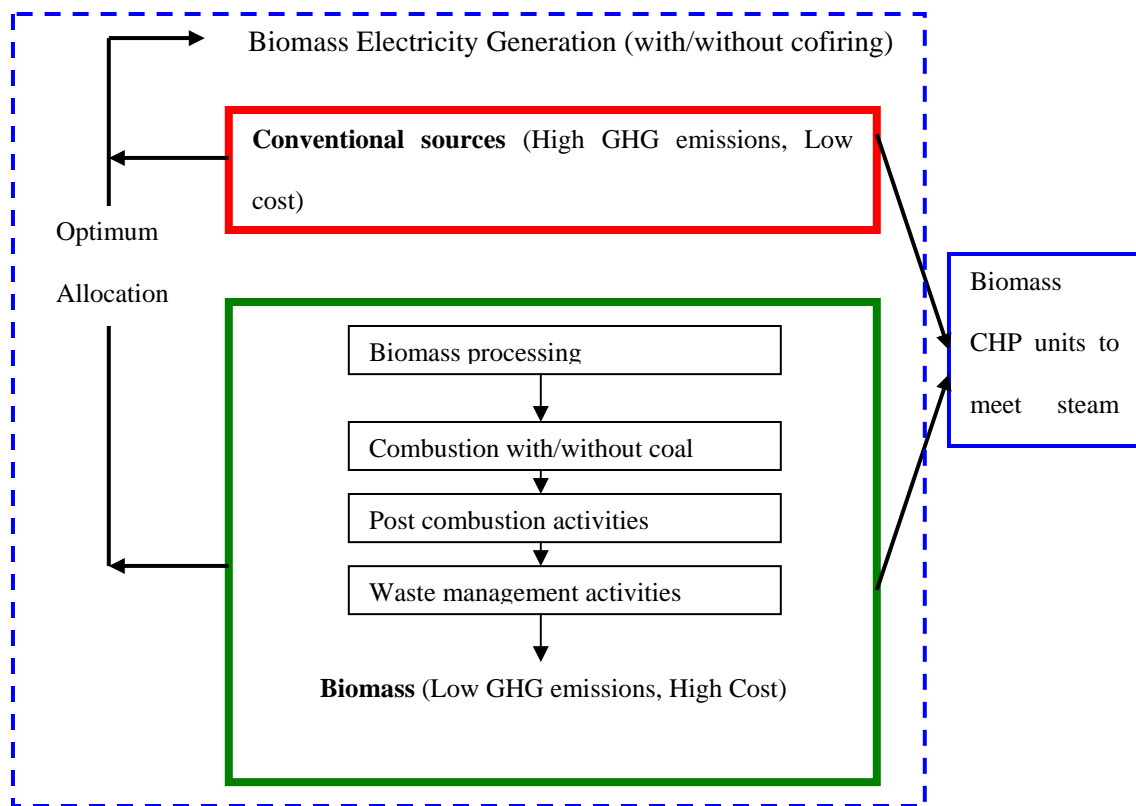
The problem to be addressed by this thesis can be stated as follows:

Given a process for electricity generation and cogeneration using conventional fuel sources and generating greenhouse gas emissions, it is conceptually desirable to partially or completely substitute fossil fuels with biomass to minimize cost and emissions.

The work in this thesis aims to address several compelling questions associated with this action.

- What is the environmental impact of this action across the entire solution?
- What alternative biomass preparation pathways should be followed for minimizing cost and emissions?
- How can biomass and coal be optimally allocated to existing or new plants?
- What are the economics of this action, and how does it compare with conventional techniques?
- What GHG emission price would be required for biomass to compete with conventional fuel sources?
- What role can biomass play as a fuel in combined heat and power techniques, and what are the economics of biomass CHP units?

The above set of questions is not comprehensive, but just gives an idea of the highly complex and combinatorial interactions associated with this problem. In order to answer the abovementioned questions, several important complex, interactive and combinatorial design challenges need to be addressed. Figure 2.1 provides an overview of electricity generation and cogeneration using biomass with/without fossil fuel.



**Figure 2.1.** Biomass use for electricity generation and cogeneration.

The overall objective is to evaluate the environmental impact and cost of substituting switchgrass for coal in biomass electricity generation units and biomass combined heat and power units by a life cycle based environmental biocomplexity analysis. The discussion will take into account various interactions among technological, agricultural, environmental and economic factors. GHG emission pricing alternatives and environmental policy options will be examined. A sensitivity analysis would be conducted to identify the significant effect of variation in one parameter on the overall assessment. Further, it is desired to optimize the alternative switchgrass processing pathways and decide on which pathway to choose for satisfying environmental, technical and economic constraints. The overall life cycle analysis needs to be optimized to

evaluate the minimum cost of electricity production and minimum emission price for mitigating GHG emissions.

Another problem to be tackled is the proper allocation of biofuel sources to biofacilities. For known total power requirement, existing and new plant sizes will be selected based on optimal criteria satisfying supply and demand constraints, and the performance equations for biomass and power plant. Further, cofiring ratio will be optimally selected to minimize cost and emissions.

Utilization of biomass and biowaste streams for cogeneration will also be analyzed. This would require determining the minimum heating and cooling utilities required by the processing plant and the steam header levels at which surplus and deficit exist in the process. Next, it is desired to compute the amount of energy that may be extracted from the biomass and biowaste streams to meet the minimum thermal requirement of the system. Additionally, the benchmark for maximum cogeneration potential by utilization of biomass and biowaste streams and minimum usage of external thermal utilities is required to be calculated.

The following sections will provide a systematic approach and specific tools to aid in answering the above questions and design challenges; and providing insights into the viability and policy options required for biomass electricity generation and biomass CHP projects.

### **III. LITERATURE REVIEW**

The work presented in this thesis requires a broad review of literature in the areas of life cycle analysis of biomass and environmental biocomplexity approach for generating energy from switchgrass, environmental policy actions pertaining to greenhouse gases and bioenergy, process economics for bioenergy production, process integration, mathematical programming for process optimization and cogeneration. This work is extensively aimed at conducting an integrated three dimensional life cycle assessment and environmental biocomplexity analysis for emissions, energy and economics of switchgrass as an alternate bioenergy feedstock and therefore, discussion of issues for energy from biomass will be highlighted. The concept of cogeneration and biomass CHP will be discussed.

#### **Biomass: Energy and Greenhouse Gas Management**

##### *Current U.S. Energy Picture*

Fossil fuel usage is a large contributor to the production of anthropogenic greenhouse gas (GHG) emissions. The bulk of U.S. primary energy comes from fossil fuels. Nearly 86% of the U.S. primary energy in 2001 is provided by fossil fuels. Non-fossil sources provided the remaining 14 percent; of which nuclear energy represented approximately 8 percent and renewable energy resources accounted for approximately 6 percent (about 40 percent of the renewable energy is hydropower) (USDOE/EIA-0573, 2002).

Nearly 82% of the GHG emissions are related to energy production. Net generation of electricity increased by 2.7 percent from 2001 to 2002, and total carbon dioxide emissions from the electric power sector increased by 1.0 percent, from 2,226.6 million metric tons in 2001 to 2,249.0 million metric tons in 2002. Of total 2002 U.S.

carbon dioxide emissions, 98.0 percent, or 5,682 million metric tons, resulted from fossil fuel combustion (Mintzer et al., 2003).

### *Environmental Impact*

In the last century in which most human production of GHG occurred, the temperature increase due to global warming is estimated to be about 0.3°C - 0.6°C. In 2002, total U.S. greenhouse gas emissions were 6,934.6 Tg CO<sub>2</sub> Eq., some of which are re-absorbed into the oceans, biomass, and soil; but the rest accumulates in the atmosphere. Overall, total U.S. emissions have risen by 13 percent from 1990 to 2002 (Hockstad and Hanle, 2004). Expectations are that in the near term this will continue to rise. This emission rate causes an atmospheric CO<sub>2</sub> concentration of 368 ppm, compared to a pre-industrial level of 280 ppm. The projected concentration of CO<sub>2</sub> in the year 2100 ranges from 540 to 970 ppm (Watson and Albritton, 2002). Further, as energy usage is increasing, this rate of increase of atmospheric CO<sub>2</sub> concentration is also increasing. The global mean surface temperature has increased by 0.6±0.2°C over the 20<sup>th</sup> century, and the global mean sea level has increased at an average annual rate of 1 to 2 mm during the 20<sup>th</sup> century. This would lead to a temperature increase of between 1.4°C to 5.8°C over the period 1990 to 2100. The resulting prediction of average temperature increase, in the absence of any emissions reductions, is estimated between 0.15°C and 0.35°C per decade; and the maximum that the environment can withstand without damage is about 0.1°C per decade. Therefore, the IPCC and others suggest that CO<sub>2</sub> emissions must be decreased (Watson and Albritton, 2002).

### *GHG Policy Issues*

Several policies and energy consumption related actions have been proposed to limit net GHG emissions. A key example is the Kyoto Protocol. Within the Kyoto Protocol, U.S. emissions were to be reduced to 7% below the 1990 levels by 2008-2012, which under the given projected emission growth ranged from 30-40% cutback in projected emissions. Kyoto faced long odds of ever coming into effect in the United



States as it is believed to be “fundamentally flawed” and unacceptable by the government. The president’s Cabinet-level global warming working group recommended replacing the Kyoto mandate of setting fixed targets for power plant emissions of carbon dioxide with “emission intensity” targets -- measures that would expand or contract with economic growth (Winters, 2002). Environmentalists, some scientists and state and federal politicians have proposed national and regional initiatives to reduce domestic greenhouse gas emissions. However, these would raise energy prices and would not stem the rise of greenhouse gases (Burnett, 2004).

Over a regional level, a number of Northeastern states are considering both individual and coordinated policies to limit greenhouse gas emissions: the “Climate Change Action Plan (CCAP)” developed in 2001. This proposal would reduce greenhouse gas emissions in three stages: capping emissions at 1990 levels by 2010; reducing emissions to 10 percent below 1990 levels by 2020; and cutting emissions by 75 percent to 85 percent of 2000 levels by 2050 (Burnett, 2004).

The “Clear Skies Initiative”, was announced by President Bush in 2002, which calls for an 18% reduction in the intensity of GHG emissions per unit gross domestic product (Winters, 2002). According to the Clear Skies Initiative sulfur dioxide (SO<sub>2</sub>) emissions would be cut by 73 percent, emissions of nitrogen oxides (NO<sub>x</sub>) would be cut by 67 percent and mercury emissions would be reduced by 69 percent, - the first-ever national cap on mercury emissions. Emission caps will be set to account for different air quality needs in the East and the West.

In 2003, the senate voted 43 to 55 to reject the “Climate Stewardship Act” (S. 139). The bill would have required greenhouse gas reductions from the commercial, industrial, utility and transportation sectors. It would set up a cap and trade system — a cap on total emissions, a government auction of allowances to the affected industries permitting them to emit carbon dioxide, and permission for companies to trade these allowances among themselves. S. 139 would have reduced emissions in two phases. In Phase I, ending in 2010, the affected economic sectors would have to reduce emissions

to 2000 levels; and in Phase II, by 2016, emissions would have to be reduced to their 1990 levels.

### *Biomass for Energy and Greenhouse Gas Management*

One mechanism that can be used to mitigate GHG emissions is substitution of alternative less emission intensive fuels for fossil fuels. Substitution of bioenergy feedstocks replaces fossil fuels and their inherent emissions with recycling where carbon is withdrawn from the atmosphere via photosynthesis during feedstock growth and then is released upon combustion.

The currently available alternative technologies for biomass electricity production are expensive, which has led to discussion on economic and policy dialogues for mitigation objectives with minimum costs and some carbon dioxide emission price. There have been discussions on cap and trade offset market in which the emitters would be allocated rights to particular emission levels and they can only exceed those rights if they buy rights from others (Ierland et al., 2003; Stavins, 2002). Such a move would allow processing facilities with high emissions and consequently higher emission costs to buy emission rights from those who can reduce emissions and/or produce emission offsets at lower costs. In this regard, biomass electricity generation and biomass CHP would help as they offset emissions by reducing carbon from the atmosphere.

Coal accounts for 56% of all the utility-produced electricity in the U.S. Thus, lifecycle assessment of coal is an important component to examine the present status quo of power generation, emissions and energy. Mann and Spath (1999) examined the life cycle analysis for currently operating coal-fired plants, new coal fired plant meeting new source performance standards and a highly advanced coal-fired power plant utilizing low emission boiler system.

On the biofuel economics front, Duffy and Nanhou (2001) have analyzed costs of producing switchgrass for biomass in Southern Iowa for seven different scenarios based on time of the year, type of land and machinery used. The costs vary considerably with

the major components affecting it as land charge and expected yield (Duffy and Nanhou, 2001). Several investigations and analyses have been conducted to evaluate the alternative pathways for biomass-to-electricity. Craig and Mann (1996) analyzed the cost and performance of biomass based integrated gasification combined cycle power generation systems.

Several efforts have been made to study the entire life cycle effects of biomass use for electricity production. Mann and Spath (1997) have worked on life cycle assessment of biomass gasification for power generation including all upstream production and downstream disposal processes. They evaluated the life cycle efficiency as 34.9%, which is not substantially less than the typical power plant efficiency of 37.2%. Impact assessment was conducted for biomass gasification power plant by taking toxicants, air pollutants, climate change, nutrients, resource depletion, etc as the stressors; and analyzing their effects on human and ecological health for local, regional and global areas (Mann and Spath, 1997). Ney and Schnoor (2002) analyzed the GHG reduction with cofiring 5% switchgrass with coal as 509,000 tons per year; which would lead to an annual income of \$2.5 million with an emission price of \$4.96 per ton CO<sub>2</sub>-Eq. Hartmann and Kaltschmitt (1999) conducted a life cycle analysis for a 10% blend of straw and residual wood with coal for electricity generation and found that co-combustion is a more environmentally sound energy system compared to using coal alone in existing power plants. Sami et al. (2001) have investigated several issues for biomass- to-electricity such as combustion, fuel properties, cofiring blends, efficiency and fouling. Biomass cofiring is advantageous as gaseous emissions are reduced; soil, water and air pollution is abated; waste accumulation is reduced; and biomass energy crop plantation would improve jobs and economy (Sami et al., 2001).

There have been few practical pilot scale demonstrations for switchgrass cofiring with coal. Testing of switchgrass cofired with coal (5-20% by weight) was conducted by the Madison Gas and Electric at Blount St. Station in a wall-fired pulverized coal boiler for 50 MW plant using Midwest bituminous coal (Tillman, 2000). Another large unit demonstrating cofiring was the Ottumwa Generating Station of Alliant Energy, in

Ottumwa, IA, using switchgrass and coal as the fuel for a 725 MW twin furnace tangentially-fired pulverized coal boiler. The switchgrass is delivered in bales, which are debaled and ground, using an equipment called eliminator which helps in dust control, to <37mm before pneumatically transporting and injecting into the boiler (Tillman, 2000; Amos, 2002).

There are several technology options for cofiring. Switchgrass can be blended with coal on the fuel pile and introduced into a cyclone or pulverized coal boiler. Another approach involves separately preparing the biomass and then firing it in the boiler (biomass bypasses the pulverizer). The direct combustion techniques for biomass cofiring with coal are ready for commercial deployment. Gasification based cofiring is flexible in terms of the fuel and the electricity generating system and also has significant potential (Tillman, 2000).

There has been some work on using process integration techniques to simultaneously mitigate greenhouse gas emissions and minimize cost for conventional power generation and cogeneration. Axelsson et al.(1999) developed graphical technique using composite curves to identify combination of enhanced heat exchanging and different heating techniques such as boiler, CHP, etc. which minimize cost at different emission constraints. Adahl et al. (2004) introduced systematic GHG emission baselines for improved heat exchange and integration of CHP by taking process, energy and market specific parameters into consideration.

### **Process Optimization**

The role of process optimization is to strike a proper balance between the holistic approach used in process synthesis and the deterministic approach used for process analysis. The goal of optimization is to identify the best performance of the system which satisfies the overall performance criterion while meeting all the design objectives.

The algorithms for optimization include an objective function which is subject to a number of feasibility constraints. The constraints are used to model the complex

interactions within the system and may include mass and energy balances, environmental constraints, efficiency requirements, supply and demand requirements and technical modeling equations. The objective is aimed at maximizing or minimizing a function.

An optimization problem can be formulated as a graphical, algebraic or mathematical problem. This work adopts mathematical programming through mixed integer nonlinear programming tools to optimize and integrate the complex interactions within the environmental biocomplexity system due to several reasons. First, it is effective for modeling highly complex and interactive systems rigorously. Secondly, the essence of the problem is captured by mathematical relationships describing the system which provides explicit comprehension of the various model parameters. Finally, this approach can effectively be used to examine the sensitivity of the findings by using computer-aided tools. However, mathematical programming inherent to this approach does result in some difficulties with regard to convergence and optimality issues. For problems with multiple optimization variables and constraints, it is quite tedious and complex to identify the global solution. Additionally, sometimes, it is difficult to provide a complete picture of the system that takes designer's insights and preferences into the process.

Optimization programs can broadly be classified into:

- Linear Programs (LP)
- Nonlinear Programs (NLP)

An optimization formulation which has the objective function as well as all the constraints as linear is termed as a Linear program (LP). A Nonlinear Program (NLP) has either the objective function or any constraint as a non linear function. Although, linear programs are easier to solve, but they can rarely describe the interactions occurring in a real problem. The classification of optimization programs is also affected by what the optimization variables are, for instance, if all variables in the problem are integers or discrete variables, the program is referred to as an Integer Program (IP). A Mixed Integer Program (MIP) is one which contains both continuous real variables as

well as integer variables. Further, based on the linearity or nonlinearity of the MIPs, they can further be subcategorized into Mixed Integer Linear Programs (MILPs) and Mixed Integer Nonlinear Programs (MINLPs).

A wealth of optimization theory and algorithms can be found in literature (Grossmann, 1996; Edgar and Himmelblau, 1988; Reklaitis et al., 1983; Beveridge and Schechter, 1970; El-Halwagi, 1997) and in commercially available software (LINGO, GINO, LINDO, etc.).

### **Process Integration**

Process Integration is a systematic approach that looks at the unity of the holistic system rather than individual units and streams that make-up the process. This technique emphasizes on analyzing the overall picture and system insights first and then delving into the details of equipment, simulation and other details. This framework helps in better understanding of the interactions in the system and results in sound decisions of performance targets. Process integration can be sub classified into three aspects: synthesis, analysis and optimization (El-Halwagi, 1997).

Process synthesis is a systematic approach that deals with generation of the flow sheet to meet certain objectives. Structure independent and structure based synthesis approaches are used to determine optimal solution from among numerous candidates. The structure independent approach determines the targets ahead of detailed design and without commitment to the system specifications; whereas the structure based approach is more robust technique that involves all potential configurations of interest. As opposed to synthesis, process analysis is aimed at predicting and verifying the detailed performance characteristics of the process using mathematical tools, empirical correlations, computer-aided simulation tools and experimental methods. Now that the process has been synthesized and its performance is analyzed, it is to be ascertained that the objectives are realized in an optimal fashion. Therefore, process optimization is aimed at identifying the best solution from the set of candidates that designs and

operates the process so as to enhance the profitability and yield, conserve resources, prevent pollution and improve the safety of the system. Process synthesis and analysis are iteratively continued until the objectives are met optimally. Process Integration techniques fall into three branches:

- Energy Integration
- Mass Integration
- Property Integration

The work in this thesis focuses around energy from biomass and cogeneration; hence only energy integration will be described in detail.

### **Energy Integration**

The concept of energy integration is aimed at minimizing the energy demands of the process. This is a rigorous and structured approach for identifying the inefficiencies in the process energy use. This technique helps in achieving heat recovery that minimizes both energy consumption as well as capital investment. Utilizing this technique, the minimum targets for utility requirement can be calculated ahead of detailed design. Energy Integration can be analyzed using graphical, algebraic or mathematical approaches. Algebraic technique will mainly be discussed here due to its application in the cogeneration work in this thesis.

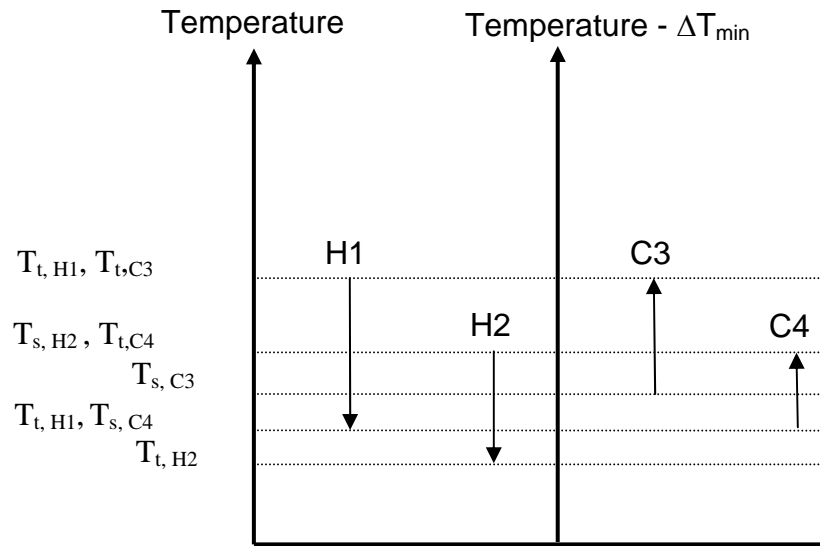
The first step in energy integration is to identify sources, sinks and hot and cold streams. A source here refers to any stream or unit that can give up energy and a sink as the one that can accept energy. A hot stream is one that needs cooling from a temperature  $T_s$  to a temperature  $T_t$ , and a cold stream is one that needs heating from a temperature  $T_s$  to a temperature  $T_t$ . The work in this thesis is based on algebraic approach; hence temperature interval diagram and grand composite curve are discussed for thermal pinch analysis.

*Algebraic Method with Temperature Interval Diagram*

Consider two hot streams H1 and H2 and two cold streams C1 and C2. The temperature interval diagram is constructed as shown in Figure 3.1. Two vertical axes are drawn, with the left axis indicating temperature and the right indicating temperature minus a  $\Delta T_{\min}$  (approach temperature). Both the hot streams are then plotted against the left axis from their respective  $T_s$  to  $T_t$  temperatures. Similarly, the cold streams are plotted on the right axis from their respective  $T_s$  to  $T_t$ .

Horizontal lines are drawn at all supply and target temperatures to define intervals where feasible heat transfer can occur between any upper interval and any lower interval. For instance, H1 can transfer heat to C3 in the first interval or to C3 or C4 in either of the next to lower intervals. Energy balances are performed at each interval to find out the pinch location and to determine the heating and cooling loads. For this, the flow rate and the heat capacity of each source is multiplied by the temperature difference of the interval and summed for all sources in that interval. This determines the energy available from the sources in this interval. Similarly, calculations for the sinks are carried out in the same interval, which give the energy needed by the sinks in this interval. Then, these calculations are repeated for all intervals.

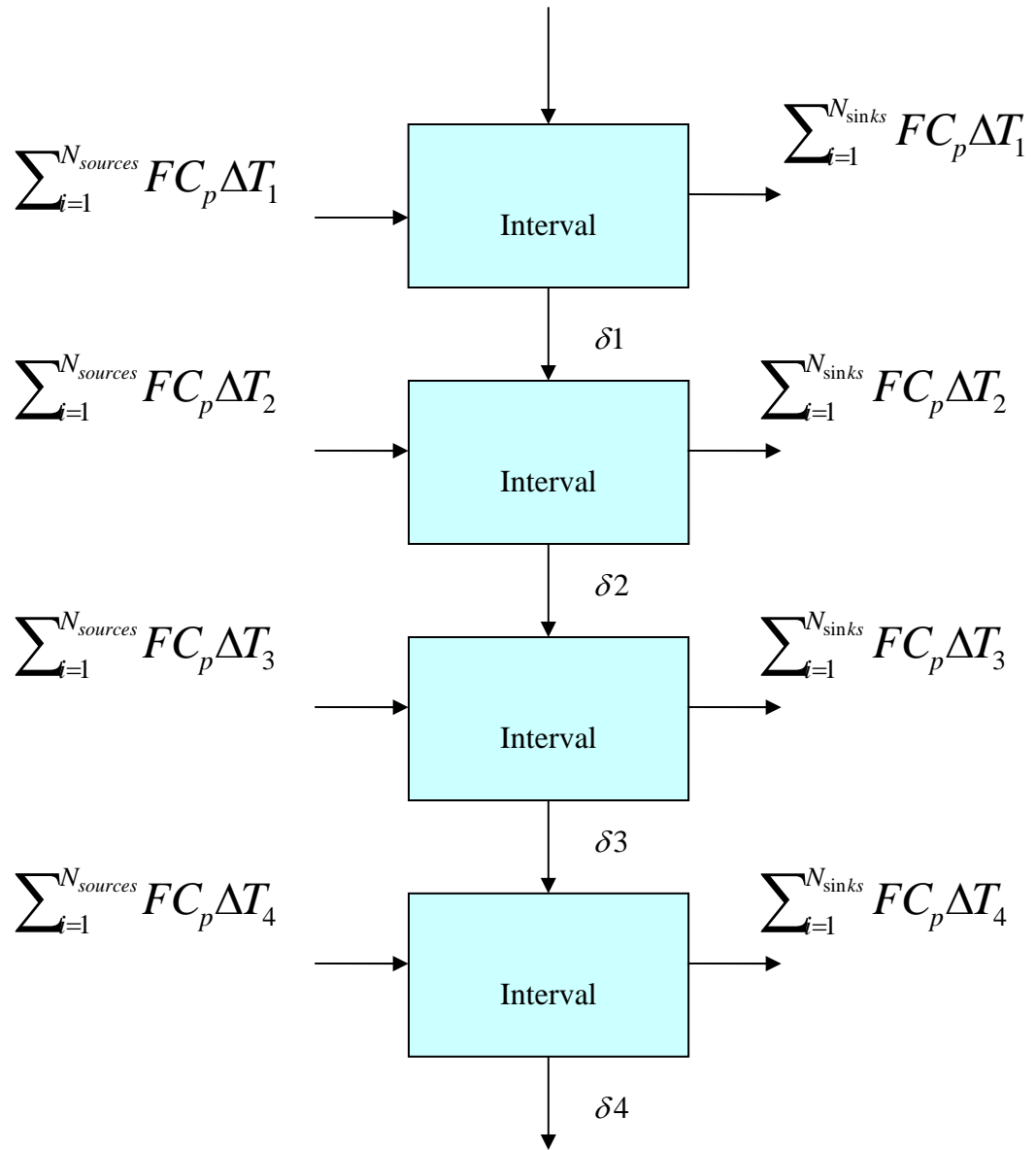




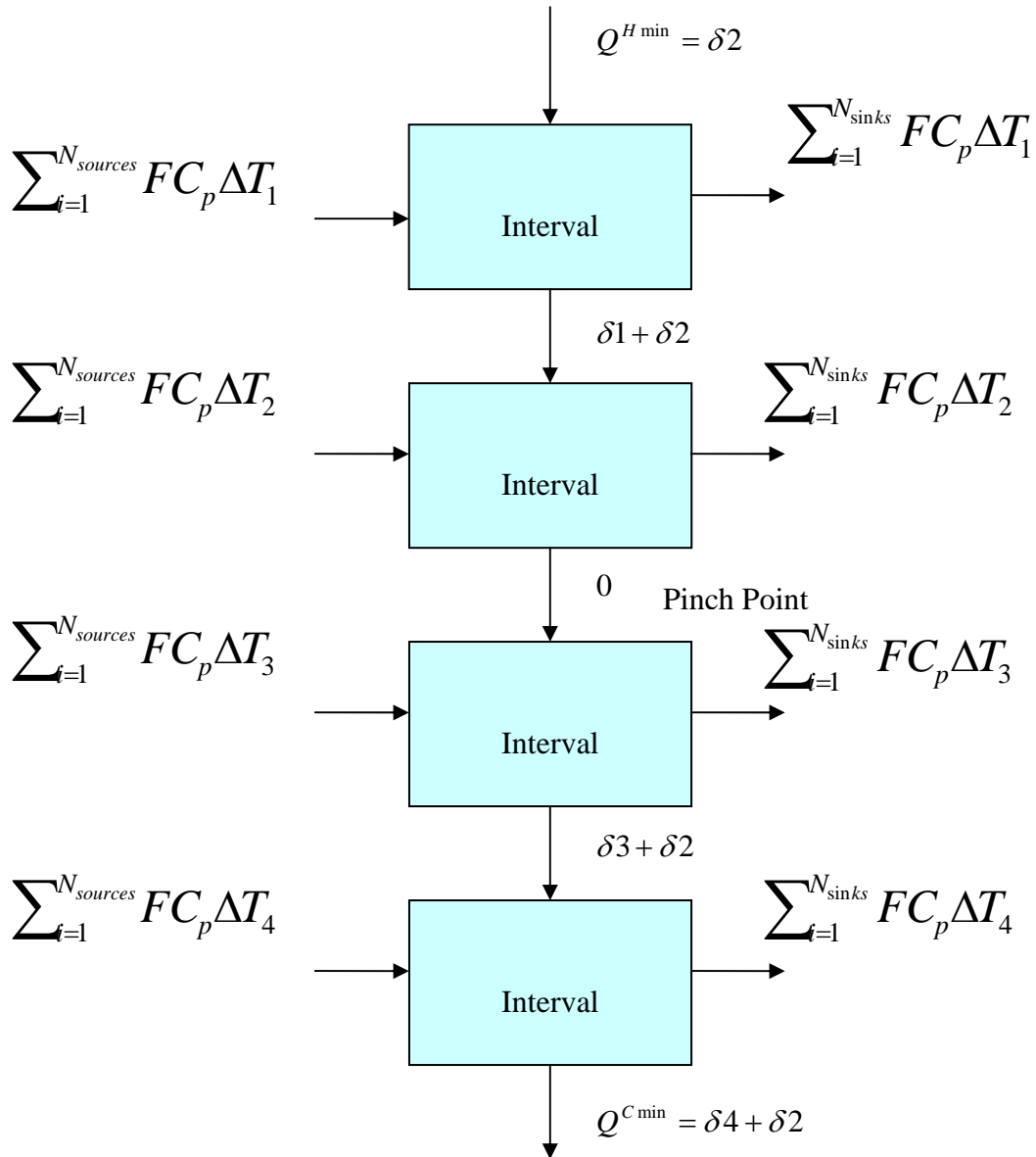
**Figure 3.1.** Temperature interval diagram.

Now, a cascade diagram is constructed as shown in Figure 3.2. Here, the energy available from the sources in the top interval is subtracted from the energy needed by the sinks in that interval with the difference being passed down to the next interval. In the next interval, the residual energy passed down from the above interval is added to the available energy in that interval and subtracted from the sink energy needs and the difference/residual again being passed down to the next interval. This calculation is repeated until all interval balances have been performed.

Then, feasibility is examined by looking at the energy being passed down from interval to interval. A negative value indicates an overall energy deficit in the preceding interval and implies that energy is being transferred from a lower temperature interval to a higher temperature interval, which is thermodynamically infeasible. This is corrected by feeding the most negative value at the top of the cascade, and revising the cascade diagram (Figure 3.3). The minimum heating duty is the energy added to the top interval; and the minimum cooling duty is the energy passing out of the last interval. Additionally, pinch point(s) are located at the interval(s) where no energy is transferred.



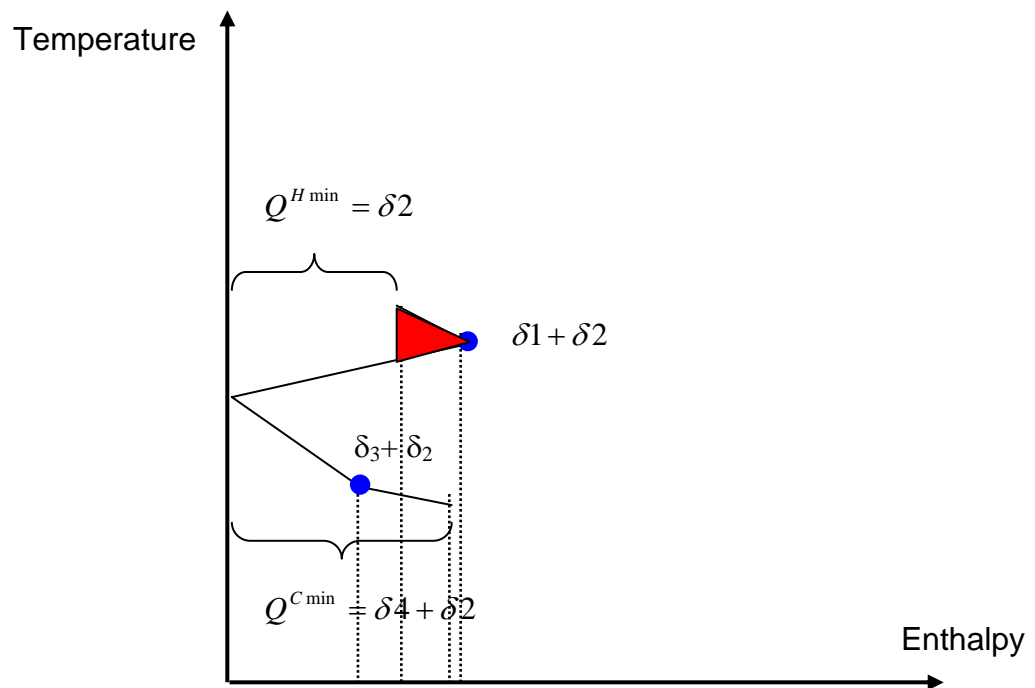
**Figure 3.2.** Cascade diagram.



**Figure 3.3.** Revised cascade diagram.

### Grand Composite Curve

Grand composite curve or GCC is another approach used for energy integration. The GCC provides the same information as the algebraic approach discussed above, but the presentation is different. To construct the grand composite curve, consider the revised cascade diagram shown in Figure 3.3. The heating and cooling duties along with the residual energies passed between intervals are used to plot the temperature-enthalpy curve, as shown in Figure 3.4. The heating and cooling duty are identified as the gaps in the curve at the top and the bottom. The pinch point(s) are located where the curve touches the vertical axis. Further, intraprocess heat transfer can be located in this diagram by the pockets, such as the shaded one shown in Figure 3.4.



**Figure 3.4.** Grand composite curve.

## Cogeneration

Cogeneration or combined heat and power is an efficient on-site energy supply option with simultaneous generation of power and heat using primary and recycled energy. Cogeneration uses energy for heat that is normally wasted in power generation, hence, it is efficient. It also reduces emissions, saves money, improves power infrastructure and is reliable. Hence, a process with thermal and power requirements should explore the potential of implementing cogeneration. The work in this thesis is focused on cogeneration for steam systems using biomass and biowaste as the fuel; thus, for this literature review, cogeneration involving steam systems will only be discussed.

Steam turbines are used in steam cogeneration system. In a process, the steam header system contains steam at different pressure levels. A steam turbine is used to let down steam from a higher level to a lower level (lower quality) which can be used to meet the thermal demands of the process, while also producing shaft work at the same time. Steam turbines can be utilized to generate electric power or produce shaft work through coupling with pumps or compressors. Steam turbines are available in various sizes, types and efficiencies and can reduce steam to one or more lower pressure levels or condense steam, based on which they are classified as backpressure, extraction or condensing turbines.

Numerous methods have been used for assessing the cogeneration capabilities of a process. Dhole and Linnhoff (1992) introduced a method of coupling the concept of exergy with existing graphical energy integration technique for cogeneration targeting. This method uses construction of overall composite source and sinks profiles by utilizing individual process grand composite curves (GCC's) to examine multiple processes at once. Raissi (1994) introduced TH-Shaftwork targeting model for cogeneration targeting. Mavromatis (1996) and Mavromatis and Kokossis (1998) introduced Turbine Hardware Model, which is based on Willians line and typical maximum efficiency plots and rules of thumb for targeting the cogeneration potential. Varbanov et al. (2004) introduced improved turbine hardware model by considering changes in turbine efficiency with the changing load. This model was improved and used in modeling and

optimization of utility systems. Later, Varbanov et al. (2004) utilized the improved turbine hardware model and industrial R-curve concept in analyzing the total site utility systems. The R-curve which utilizes the relationship between cogeneration efficiency vs. heat-to-power ratio was introduced by Kenney (1984) and later developed by Kimura and Zhu (2000). Wen and Shonnard (2003) developed environmental indices along with economic analysis for heat exchange network design. Harell and El-Halwagi (2003) introduced single stage graphical technique for the determination of optimum cogeneration potential before the detailed design. This method involved both heat and mass integration analyses to identify process potential for generating and using steam. This technique utilized the concept of extractable power to evolve an extractable power cogeneration targeting pinch diagram using surplus and deficit steam header composite curves. The work in this thesis introduces a novel algebraic technique for targeting cogeneration using the concept of extractable power, hence this literature review discusses in detail the graphical cogeneration targeting approach and the concept of extractable energy developed by Harell and El-Halwagi (2003).

The traditional technique for determining cogeneration potential is via Mollier diagram. However, the Mollier diagram is cumbersome because it requires the determination of the isentropic enthalpy of the turbine at the outlet pressure. A more convenient approach developed by Harell and El-Halwagi (2003) for determining the cogeneration potential of a turbine utilizes the actual outlet temperature and pressure of the turbine. Because turbines are placed in steam systems between headers, the inlet and outlet temperatures and pressures are known. Therefore, the extractable power concept is based off of the header level that the turbine is being outlet to, rather than the isentropic conditions at the outlet pressure. The difference between the traditional approach and the approach developed by Harell and El-Halwagi (2003) is shown in Figure 3.5.

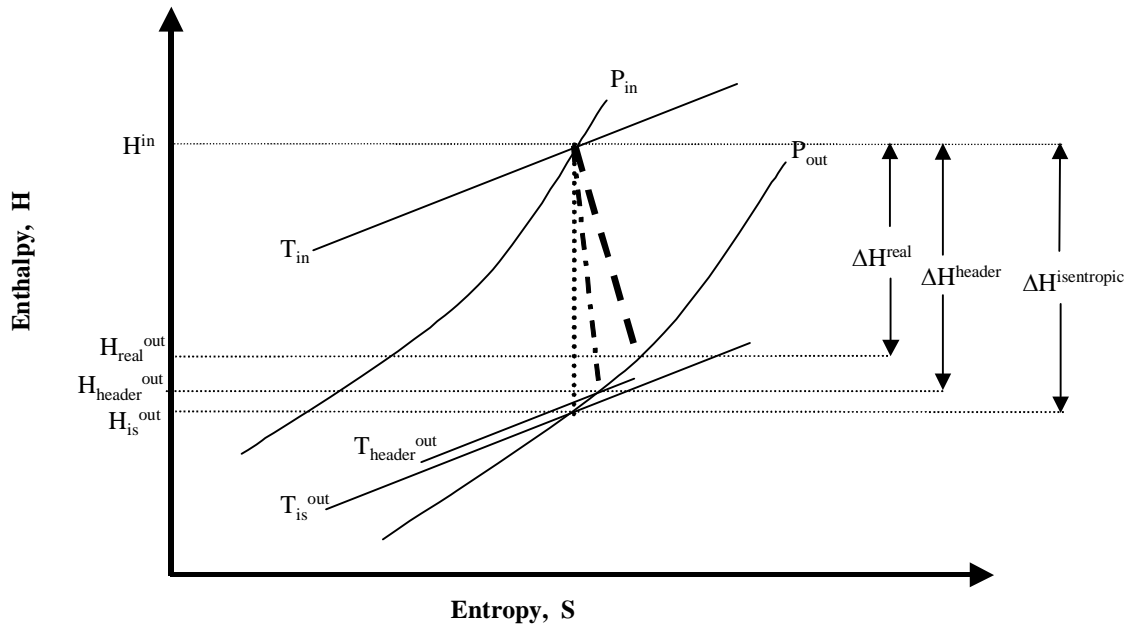


Figure 3.5. Mollier diagram with header and isentropic outlet conditions (Harell, 2004).

The enthalpy difference between turbine inlet and outlet is:

$$\Delta H^{header} = H^{in} - H_{header}^{out} \quad (3.1)$$

where  $\Delta H^{header}$  is the specific enthalpy difference between the turbine inlet and outlet header and  $H_{header}^{out}$  is the enthalpy at the header outlet temperature and pressure. An efficiency term ( $\eta_{header}$ ) is incorporated to relate the header difference to the actual enthalpy difference that occurs:

$$\eta_{header} = \frac{\Delta H^{real}}{\Delta H^{header}} \quad (3.2)$$

The specific power produced by a turbine is given by:

$$w = \Delta H^{real} = \eta_{header} (H^{in} - H_{header}^{out}) \quad (3.3)$$

The actual power generated from the turbine is then determined by multiplying the specific power by the mass flow rate of steam passing through the turbine:

$$W = \dot{m} \eta_{header} (H^{in} - H_{header}^{out}) \quad (3.4)$$

The concept of extractable energy is:

$$e = \eta H \quad (3.5)$$

where  $e$  is the extractable energy,  $\eta$  is an efficiency term and  $H$  is the specific enthalpy at a given set of conditions. Then, the power generation expression can be rewritten as:

$$W = \dot{m}(e^{in} - e_{header}^{out}) \quad (3.6)$$

The power generated by the turbine takes a convenient form as the difference between the inlet and outlet extractable power:

$$W = E^{in} - E_{header}^{out} \quad (3.7)$$

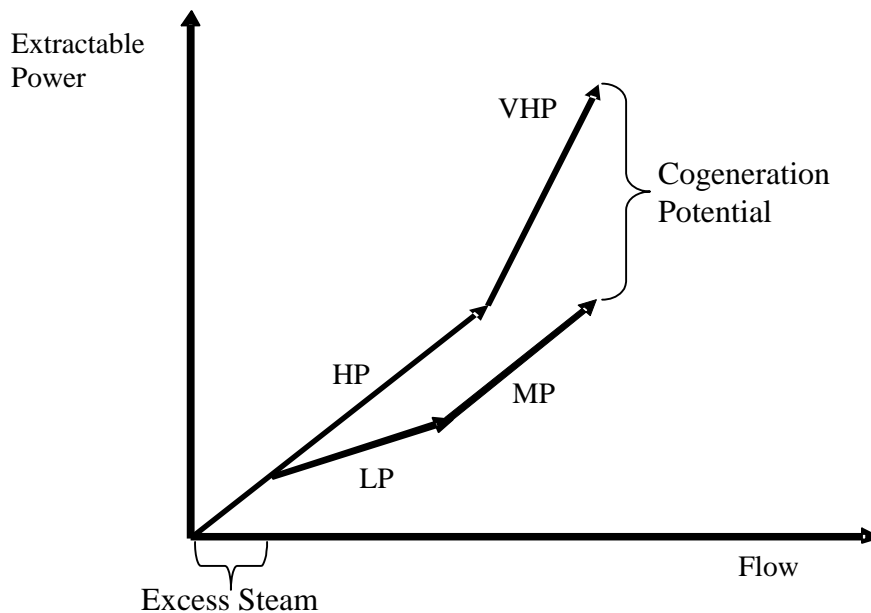
where  $E$  is defined as the extractable power at a given header condition.

In the graphical technique by Harell and El-Halwagi (2003), header balance is first performed to know the surplus and deficit at each header level. Within each header the temperature and pressure are known, allowing the calculation of the specific enthalpies. By combining the specific enthalpies with the surpluses and deficiencies and then applying an efficiency term, the extractable power at each header level can be determined. Then, the magnitude of the extractable power is plotted versus the steam mass flow rate for each surplus header in ascending order of pressure levels (making the surplus composite line), with a similar curve being constructed with the deficit headers (making the deficit composite line).

The cogeneration potential of the system is easily determined by shifting the deficit composite line to the right and up until it is directly below the termination point of the surplus line. Shifting the deficit line in this manner is possible since both the extractable power and the mass flow rates are relative quantities.

The gap between the surplus and deficit lines of Figure 3.6 represents the cogeneration potential of the system. The region for which there is no deficit line below the surplus line indicates the amount of excess steam available within the process.





**Figure 3.6.** Extractable power cogeneration targeting pinch diagram.

### *Biomass CHP*

Many processes with thermal and power demands and with the availability of biomass and biowaste can benefit from Combined Heat and Power (CHP) or cogeneration. For large scale biomass power generation, it is not always possible to find a local heat market. However, in the case of small scale biomass CHP plants, with presence of process thermal and power requirements, biomass CHP is a clean, viable and profitable option. Cogeneration in district heating system is the most energy-efficient method to convert biomass into heat and electricity (Gustavsson and Johansson, 1994).

A lot of work has been conducted in the area of biomass cogeneration and it has been found that at present, the costs from cogeneration are higher when using biomass than when using fossil fuels, but when environmental factors and emission prices are taken into consideration, biomass can compete with fossil fuels. Husain et al. (2003)

have analyzed the boiler and turbine performance for cogeneration systems using biomass residue as fuel in palm oil mills in Malaysia; and found that the system has low thermal efficiency compared to conventional ones, and that using condensing turbines can improve the power output by 60%. Bagasse energy cogeneration has become a norm in the sugarcane industry worldwide. It is technically feasible to implement cogeneration systems using bagasse in the crop season and coal in the off crop season, which generates extra power that can be fed to the grid; and would increase the revenue of the sugar industry while mitigating emissions (Mbohwa, 2003). Papadopoulos and Katsigiannis (2002) have developed a flexible computational tool that aids in identifying possible cogeneration or CHP unit installations in proper site locations based on techno-economic and geographical criteria for alternative combinations of solid biomass feedstocks. Duval (2001) has analyzed the environmental impact of reducing the greenhouse gases and criteria pollutant emissions by using modern biomass cogeneration systems for agro and food industries in Southeast Asian countries of Indonesia, Malaysia, The Philippines and Thailand. Bernotat and Sandberg (2004) have demonstrated the use of biomass fired small-scale district heating and combined heat and power units to meet different needs of heat and power for Sweden and three Baltic States. They came up with two factors that affect the performance of the system: the total heat demand of the area and the length of power network that can be regarded as efficient with regard to the costs and/or losses. Wahlund et al. (2002) have studied the concept of a bioenergy combine, where part of the heat generated by the biomass CHP unit is used for drying and pelletizing the biofuel, which can then be transported to areas with biofuel deficit so as to replace the fossil fuel. This system has great potential for reducing carbon dioxide emissions and increasing the efficiency (Wahlund et al., 2002). Sundberg and Henning (2002) have studied the influence of fuel price on minimizing the operational costs by using an energy system model MODEST (model for optimization of dynamic energy systems with time dependent components and boundary conditions); and found that a lower biofuel cost combined with governmental grants is the only way to make biomass fired cogeneration steam cycle profitable.

#### IV. INTEGRATED SWITCHGRASS LIFE CYCLE ANALYSIS\*

Biomass conversion into forms of energy is receiving current attention because of environmental, energy supply and agricultural concerns. This section reports on an environmental biocomplexity based analysis of the environmental, energy, economic, and technological aspects of using one form of biomass -- switchgrass (*panicum virgatum*) as a replacement for coal in power generation. The main questions regarding such a substitution pertain to the cost, environmental impact, and net balance of greenhouse gases. This work summarizes the results of an investigation into these questions using an environmental biocomplexity approach that addresses agricultural, technological, economic, and environmental factors along with their interaction.

Biomass conversion into forms of energy is an old idea but one that is receiving increasing attention largely because of environmental, energy supply and agricultural market condition concerns (McCarl and Schneider, 2001). Specifically, the wise use of biomass-based fuels, power, and products can make important contributions to U.S. energy security, agricultural welfare, and environmental quality. However, wise use is a challenging concept that must be based on a holistic consideration of the numerous agricultural, economic, technological, energy, and ecological elements. Wise use involves decisions on appropriate research strategies for biomass production and processing enhancement as well as policies to promote environmentally sound practices. Such decisions involve identification of the biomass strategies to emphasize the development and the formation of policies and rules that facilitate appropriate biomass production and use.

---

\*Reprinted with permission from “Switchgrass as an Alternate Feedstock for Power Generation: Integrated Environmental, Energy, and Economic Life-Cycle Assessment” by Qin, X., Mohan, T., El-Halwagi, M.M., Cornforth, G., and McCarl, B.A., *Journal of Clean Technologies and Environmental Policy*, in press.

It is important to recognize that despite being considered for more than 30 years, biomass still has not achieved a great deal of market penetration largely due to cheaply available fossil fuels and the relatively high costs and current low yields of biomass energy feedstocks. A mix of technological, market and policy developments are occurring that may make biomass feedstocks competitive. These involve

- A desire to manage GHG emissions globally and the role that biomass through carbon recycling or emissions management might play.
- A continued desire for rural income support and the bolstering of farm prices and or income opportunities as well as a desire to increase the stability of farm and rural incomes (Butt and McCarl, 2004).
- An enhanced desire for a cleaner environment and a move to reduce emissions from fossil fuels.
- Continued concern over the degree of energy dependency on foreign sources of petroleum.

If biofuel is to expand as a feedstock, society must be careful not to trade one environmental problem for another. In this regard, environmental biocomplexity provides an attractive approach, because it causes one to achieve a holistic understanding of biomass-to-energy alternatives. Environmental biocomplexity refers to highly interactive phenomena that arise through interactions among the biological, physical, and social components of the Earth's diverse environmental systems (El-Halwagi, 2003).

In order to be profitable, energy crops need to

- produce high yields of biomass,
- contain low concentrations of water, nitrogen and ash, and
- contain high concentrations of lignin and cellulose.

Perennial, herbaceous energy crops such as switchgrass can be used for developing bioenergy and bioproducts. In the United States, switchgrass is considered the most valuable native grass for biomass production on a wide range of sites. It is noted for its heavy growth in late spring and early summer. It is also valuable for soil stabilization, erosion control and as a windbreak. The energy that can be generated through the use of switchgrass depends on concentration of energy, primarily derived from cell walls and particularly from lignin and cellulose. Also, some elements such as potassium, sodium, chlorine, silica, etc. cause problems when burned (erosion, slagging and fouling), decreasing efficiency and increasing maintenance costs (Sami et al., 2001).

At present, the cost differences between using biomass versus coal as a power plant feedstock are generally not enough to cover the capital cost of plant conversion and still be profitable. However, two types of policy options are currently being considered that could promote biomass as an energy feedstock. One policy option involves the use of markets for GHG emission credits as a vehicle for reducing emissions of GHGs as manifest in the Kyoto Protocol. Such a market would improve biofuel competitiveness, as there is a large GHG offset relative to coal use. This would, in effect, create subsidies for biomass planting and, thus, enhance biomass growth and acceptance (Butt and McCarl, 2005). The second policy development that could favor biofuels production is legislation such as the four pollutants bill or the Clear Skies Initiative. That type of legislation proposes to limit  $\text{SO}_x$ ,  $\text{NO}_x$ , and mercury emissions from power plants. Burning switchgrass offers the potential to reduce these emissions as biomass has virtually no sulfur (often less than 1/100<sup>th</sup> of that in coal), low nitrogen (less than 1/5<sup>th</sup> of that in coal), low mercury, and low-ash content (Hughes, 2000). Additionally, switchgrass burning leads to cost savings as expensive emissions control equipment for  $\text{SO}_x$  and  $\text{NO}_x$  would no longer be required. Another action that would be helpful in commercialization of biomass would involve a relaxation of the standards for ash usage in cement manufacturing (Hughes, 2000). This would help plants cofiring up to 10 or 15% switchgrass provide ash for use in the cement industry.

## Objectives

The objectives that this section aims to address are as follows:

- To provide an economic, energy and environmental evaluation of the prospects for switchgrass as a bioenergy feedstock into electricity generation using lifecycle analysis.
- To develop an environmental biocomplexity, lifecycle-based approach that permits identification of most effective technological enhancement possibilities and alternative material handling procedures.
- To examine how potential GHG emission pricing alternatives might influence the relative efficiencies of alternative technologies and other strategies as well as the power generation market penetration of biomass.
- To examine the sensitivity of the findings in the face of a wide spectrum of possibilities for switchgrass production, preparation and delivery as well as the degree of desirable cofiring of power plants.

## Methodology

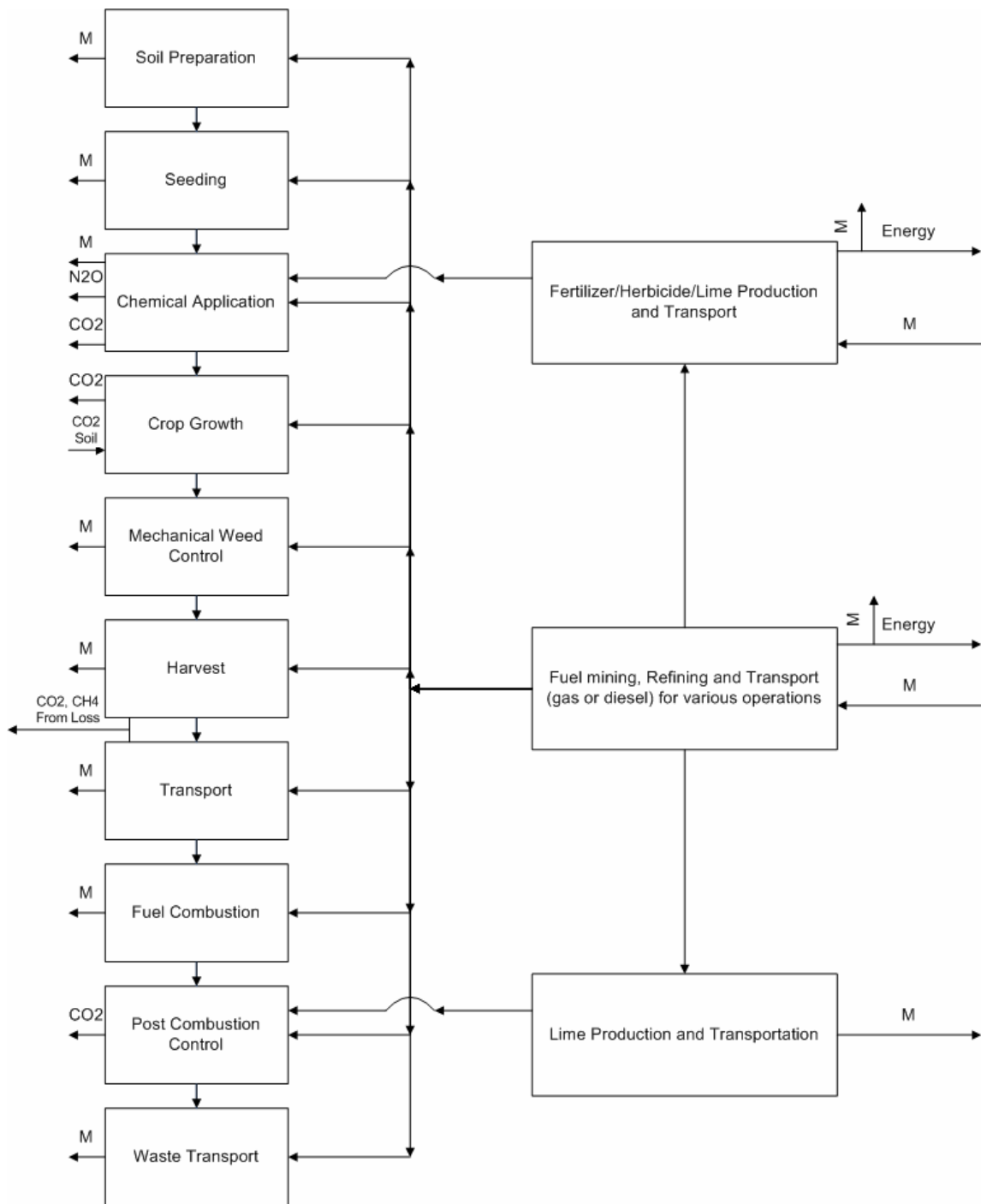
In order to assess cost, environmental impact, and net balance of greenhouse gases associated with the use of switchgrass as a biofuel, the life cycle of such application will be studied. Therefore, the work is based on a life cycle study of all the steps involved in the ecological cycle of switchgrass-to-power including growth, harvesting, pre-processing, power generation, post combustion, and disposal. This approach is based on developing a detailed study of the following elements involved: soil preparation, seeding, chemical application, crop growth, mechanical weed control, harvesting, hauling, power generation, and waste disposal. Figure 4.1 is a schematic representation of the sequence as well as the energy and the GHG inputs and outputs of these steps. For each one of these steps, the material and energy flows will be studied. In particular, the following issues will be studied:

- Switchgrass production items include plowing, disking, seeding, lime, herbicide and fertilizer application, and harvesting.
- GHG emissions and energy consumption associated with switchgrass cultivation.
- Lime soil reaction.
- Carbon sequestration in the soil.
- GHG emissions and energy consumption associated with hauling, storing, and moving switchgrass from the farm to the point of combustion. This includes loss of switchgrass that is scattered and embedded in the soil during transportation that leads to GHG emissions upon degradation.
- Energy and emissions from switchgrass combustion versus coal combustion. This includes the net carbon balance when combusting switchgrass along with the post combustion control of  $\text{SO}_x$  and transport of combustion waste to a landfill.

Various alternatives will be screened based on techno-economic as well as environmental factors (including GHG emissions). Next, tradeoffs will be established to aid in the selection of alternatives. Finally, sensitivity analysis will be conducted to identify key technological, environmental, and economic insights and to determine dominating factors in the analysis. The following sections present the details of the approach.

#### *Analysis of Switchgrass Lifecycle*

Lifecycle analysis on the production of electricity from switchgrass includes two stages: switchgrass preparation and power generation. Costs, emissions and energy consumption of all processes during the transformation of switchgrass to electricity were quantified using material and energy balances.



**Figure 4.1.** Emission and energy pathways for switchgrass (M refers to multiple gases).



### Pathways for Switchgrass Preparation

This stage is based on the model established by Smith and Bransby (2005). It includes processes for switchgrass establishment, growth, harvest and transportation to the power plant. The steps and alternatives for switchgrass preparation are shown in Figure 4.2.

Switchgrass chemical composition is a key input to computations of GHG and other emissions. The assumed composition used herein is shown in Table 4.1 (Sami et al., 2001; Aerts et al., 1997).

**Table 4.1.** Switchgrass ultimate analysis

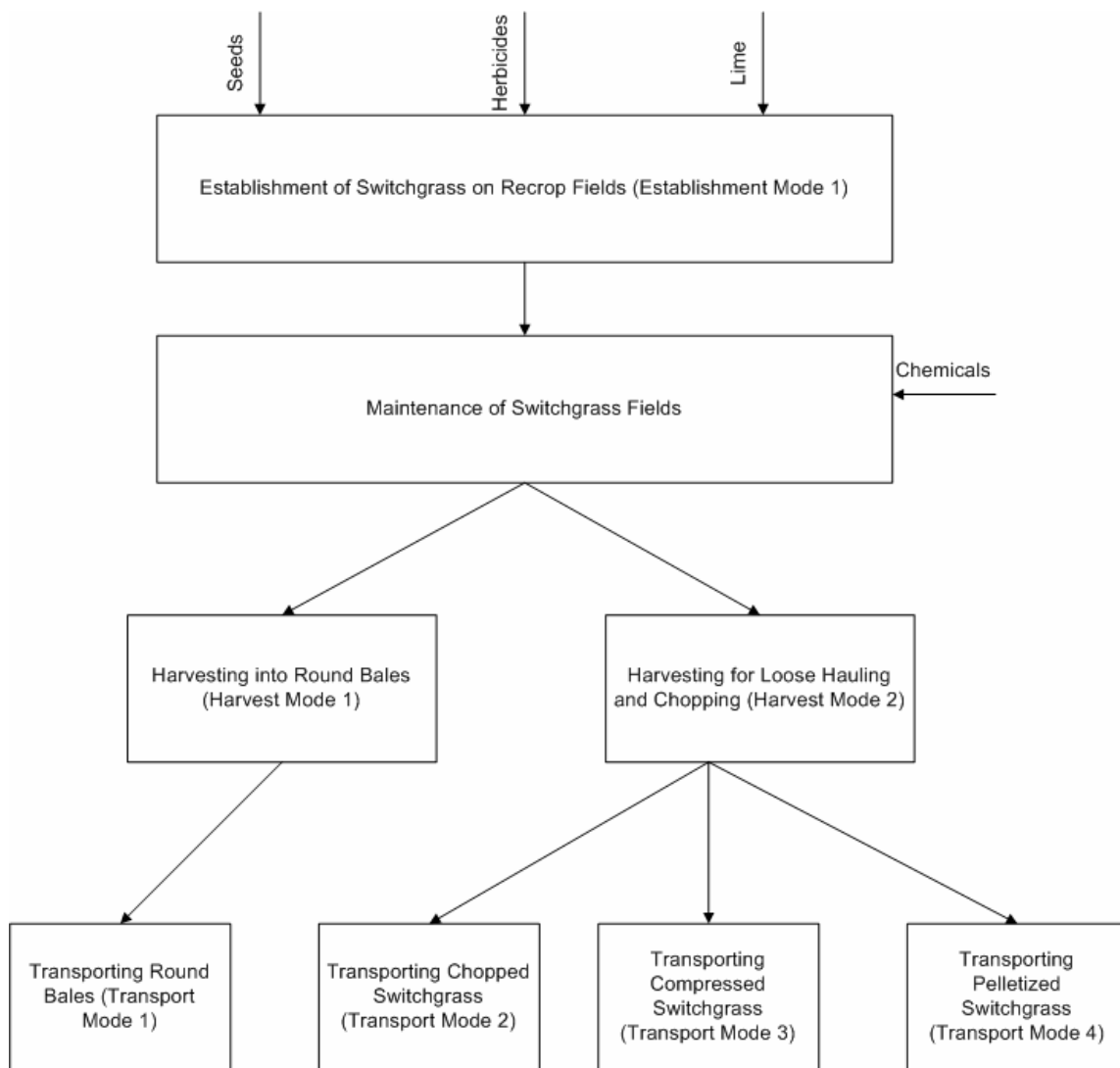
Component	% By weight (kg)
Water	11.99
Ash	4.61
Carbon	42.04
Hydrogen	4.97
Oxygen	35.44
Nitrogen	0.77
Sulfur	0.18

The tested HHV for switchgrass, which is employed in this model, is 15,991 kJ/kg (Sami et al., 2001; Aerts et al., 1997).

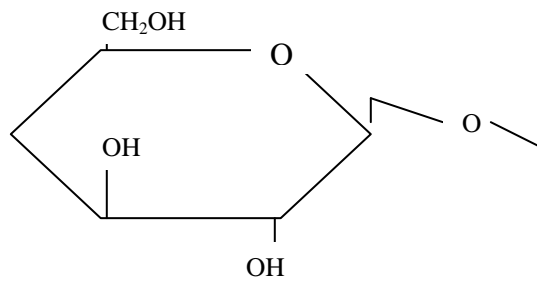
The agronomic traits and cell wall constituents for the switchgrass used for analysis are listed in Table 4.2 (Lemus et al., 2002).

**Table 4.2.** Cell wall constituents of switchgrass

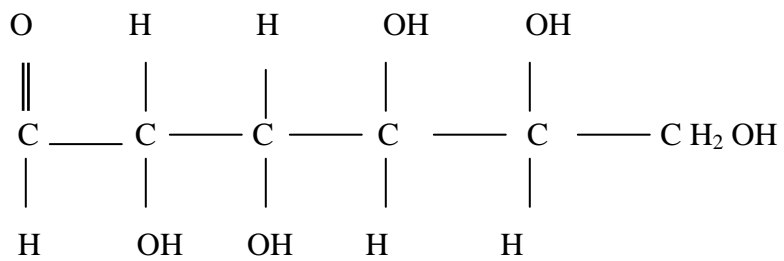
Constituent	% By bone dry weight base
Cellulose	37.10
Hemi cellulose	32.10
Fixed Carbon	13.60
Lignin	17.20

**Figure 4.2.** Overall approach for switchgrass preparation including delivery to power plant.

The carbon content of the cellulose and hemi cellulose is found by using their respective structural monomers as shown in Figures 4.3 and 4.4.



**Figure 4.3.** Structural monomer of cellulose.



**Figure 4.4.** Structural monomer of hemi cellulose.

The above characteristics were used in this analysis and provide the basis on which the yield, loss, and energy generation from the switchgrass feedstock were calculated. The switchgrass yield is assumed to be 10 tons per acre year, the stand life as 10 years and the transportation distance as 25 miles.

### *Economics of Switchgrass Preparation*

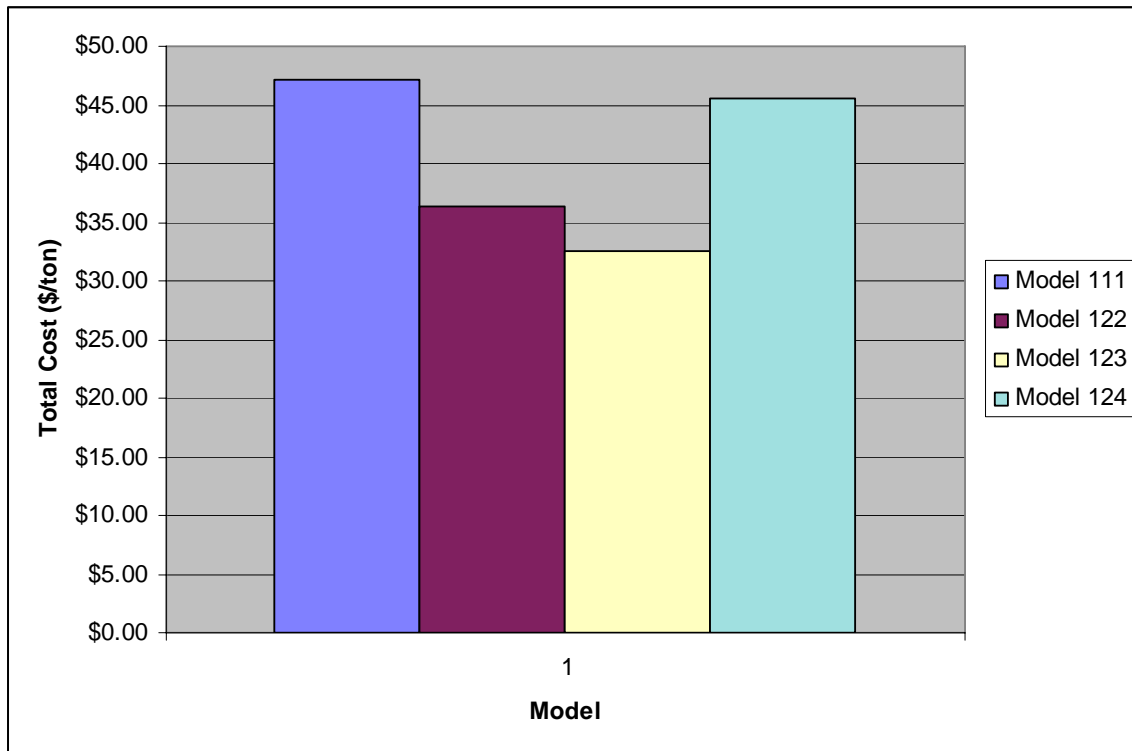
An economic analysis of switchgrass preparation for use in power generation was done following the work done by Sladden et al. (1991) and Smith and Bransby (2005). Machinery, fuel, and energy requirements for all farm operations were taken into consideration. Appropriate financial parameters such as interest rate, tax rate, insurance rate, cropland rental value, and fuel prices were used in cost calculations.

After calculating all the costs for establishment, growth, harvest and transportation (French, 1960), a total cost budget for switchgrass preparation was assembled. The total cost per ton of switchgrass for various combinations of alternative activities is shown in Figure 4.5.

During the study we examined various pathways for switchgrass production involved with land type used, harvest method and transport method. Each of these possibilities generated a case which we designate as "model abc" where

- 'a' gives the land type used (1 for recrop)
- 'b' gives harvesting method including round baling (1) or chopping and loose harvest (2) and
- 'c' gives hauling preparation and resultant transport method including moving round bales (1), or moving loose material (2); compressed loose material(3) or pelletized loose material (4).

Based on the analysis, the most cost effective switchgrass preparation method was to establish switchgrass on recrop fields, harvest loose for hauling and chopping, and transport by compression into modules (Model 123), an overall cost of \$32.53/ton.



**Figure 4.5.** Comparison of various combinations of alternative activities of switchgrass preparation for cost evaluation.

#### *Environmental and Energy Assessment for Pathways to Switchgrass Preparation*

The analysis of GHG emissions associated with switchgrass preparation needs to span activities for growing switchgrass and those for transporting it to a power plant. Such activities also cover the emissions incurred when manufacturing inputs such as fossil fuels, chemicals, fertilizers and herbicides. The carbon in plants and soils plus the carbon that would have been released by coal combustion are also considered. Finally, GHG emissions due to mining/production, refining and transportation of fossil fuels were included.

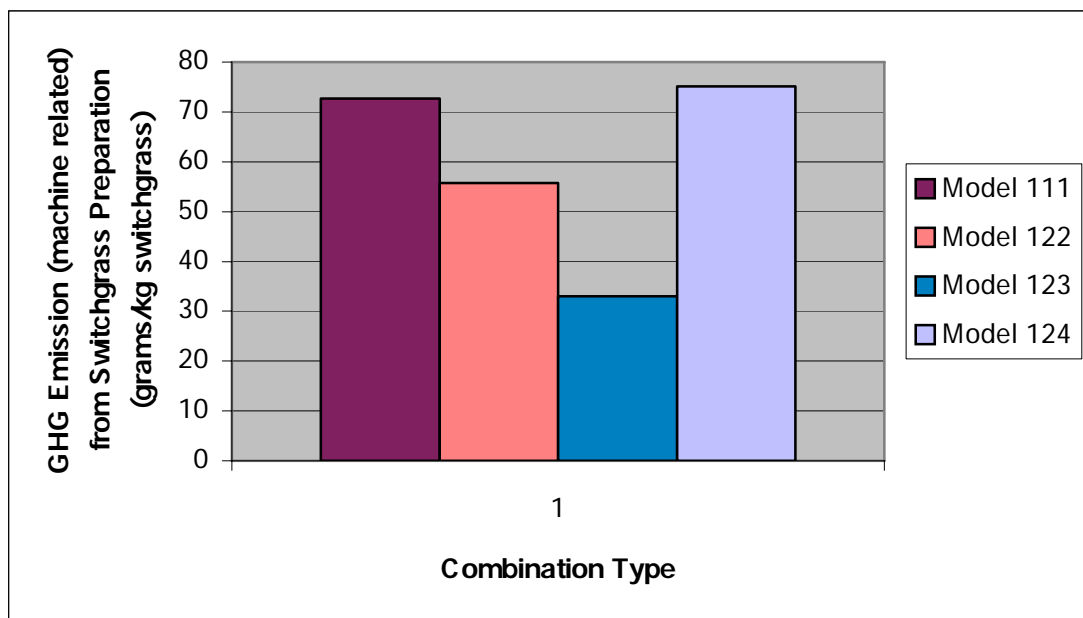
### Emissions and Energy Consumption from Machinery Operations for Switchgrass Preparation

The energy consumption and GHG emissions were calculated for four stages of switchgrass preparation; establishment, growth, harvest, and transport. Based on the machines used at each stage, the fuel consumed was calculated and used to calculate the GHG emissions by using the emission and energy factors.

**Table 4.3.** GHG emissions and energy consumption from preparation of switchgrass

Switchgrass preparation stage	Embodied operations	Energy Consumption (Btu/kg switchgrass)	CO <sub>2</sub> emissions (grams/kg switchgrass)	N <sub>2</sub> O emissions (grams/kg switchgrass)	CH <sub>4</sub> emissions (grams/kg switchgrass)	CO <sub>2</sub> -eq emissions (grams/kg switchgrass)
Establishment	Recrop Fields (1)	5	0.4	0.9E-5	0.5E-3	0.4
Growth	Growth	24	1.9	4.5E-5	2.4E-3	2.0
Harvest	Round Bales (1)	190	15.0	7.1E-4	2.0E-2	15.7
	Loose, hauling and chopping (2)	59	4.7	1.1E-4	0.5E-2	4.8
Transport	Round bales(1)	672	52.8	1.2E-3	6.4E-2	54.7
	Loose, chopped(2)	598	46.9	1.1E-3	5.7E-2	48.5
	Loose, compressed (3)	311	24.7	1.4E-3	2.9E-2	25.8
	Loose, pelletized (4)	963	65.6	0.9E-3	9.0E-2	68.0

Analyzing the various pathways for switchgrass production for the lowest GHG emissions, the optimal combination of activities was establishing switchgrass after existing cropping, harvesting switchgrass loose for hauling and chopping, then transporting after compression into modules (Model 123). Field chopping switchgrass is preferable to baling as it leads to savings in transportation costs (Boylan et al., 2000). Figure 4.6 below shows total GHG emissions from machinery operation for delivered switchgrass.



**Figure 4.6.** Total machinery related GHG emissions for switchgrass preparation.

### GHG Emissions and Energy Consumption of Production Inputs

During switchgrass establishment and growth, lime, fertilizers and herbicides are applied. GHG emissions are generated in their production. The net emissions from these activities are based on the annual recommended per acre usage rates for these materials from Smith and Bransby (2005) and Ney and Schnoor (2002) which are 2 lbs atrazine, 100 lbs nitrogen, 40 lbs P<sub>2</sub>O<sub>5</sub>, 40 lbs K<sub>2</sub>O fertilizer and 2 tons agricultural lime (CaCO<sub>3</sub>) (the latter only during the establishment stage).

The lifecycle emission and energy consumption factors for atrazine and fertilizer production are drawn from the GREET model (Wang and Santini, 2000).

The application of nitrogen fertilizer leads to the formation of nitrous oxide emissions from the soil. Based on assumptions by Ney and Schnoor (2002), 36.892 grams N<sub>2</sub>O are released from 1 kg fertilizer nitrogen used. This will lead to emissions of 0.203 grams N<sub>2</sub>O/kg switchgrass in the model.

Emissions and energy consumption from the manufacture and transportation of lime are calculated based on the limestone manufacture and transport processes. The reactions of lime in the soil will lead to direct CO<sub>2</sub> emission. The mechanism is summarized as follows:



The partial pressure of CO<sub>2</sub> in soil is high enough to force above reaction to the right.



Over time, the soluble Ca<sup>2+</sup> ions are removed from the soil by the growing crop or by leaching.

The overall GHG emissions due to the use of lime and chemicals are summarized in Table 4.4.



**Table 4.4.** GHG emissions and energy consumption from use of lime and chemicals

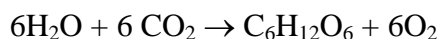
Emission species	Energy	CO <sub>2</sub>	N <sub>2</sub> O	CH <sub>4</sub>	CO <sub>2</sub> -Eq
Emissions and energy consumption from fertilizer and Atrazine (g or btu/kg switchgrass)	441	28.2	2.03E-1	6.5E-02	89.9
Emissions and energy consumption from agriculture lime (g or btu/kg switchgrass)	6	9.2	1E-05	5E-04	9.2
Emissions and energy consumption from all chemicals (g or btu/kg switchgrass)	447	37.4	2.03E-01	6.5E-02	99.1

### Carbon Uptake by Switchgrass and Soil

In tracking carbon uptake and release associated with the growth and preparation of switchgrass, the following issues must be considered: photosynthesis, sequestration in soil, and GHG emissions due to switchgrass losses. The following are key information associated with these steps.

#### *Photosynthesis*

Photosynthesis is the process by which plants use the energy from sunlight to produce sugar, which is then converted into ATP (adenosine triphosphate) by cellular respiration. ATP is the “fuel” used by all living things. The overall reaction of this process can be written as:



It is assumed that all the carbon in switchgrass is converted from CO<sub>2</sub>. Therefore, the CO<sub>2</sub> used by switchgrass can be calculated from the carbon content of switchgrass, i.e. 1540.5 g CO<sub>2</sub>/kg switchgrass in this model. This carbon will be released upon combustion but is assumed to result in zero net combustion related emissions because photosynthetic uptake matches combustion releases.

### *Carbon Dioxide Sequestration in the Soil*

Soil carbon sequestration is also associated with switchgrass production. McLaughlin et al. (1999) analyzed soil carbon gains in the soil surface horizon across a total of 13 research plots to document anticipated increases associated with root turnover and mineralization by switchgrass. These include measurements made after the first 3 years of cultivation in Texas, and after 5 years of cultivation in plots in Virginia and surrounding states. Their studies indicated that carbon accumulation is comparable to, or greater than the 1.1 tonne carbon per hectare-year reported for perennial grasses (McLaughlin et al., 1999). Several years of switchgrass culture are required to realize the benefit of soil carbon sequestration (Bransby et al., 1998; Ma et al., 2000a,b). Using a conservative estimation, the credit for soil carbon dioxide sequestration was 179.9 g/kg switchgrass. However, after growing switchgrass on the same fields for 15 years, CO<sub>2</sub> accumulation in the soil is likely to reach a saturation value as found in West and Post (2002), which should be taken into account for any long-term studies.

### **GHG Emissions due to Switchgrass Losses**

During harvest, transportation, and storage, some switchgrass will be lost. A series of experiments conducted by Texas A & M University show that baling losses from switchgrass including those gleaned from the stubble and collected at the baler ranged from 1.8% to 6%. Switchgrass losses during handling and transporting switchgrass over 11 miles were only 0.4% of the baled weight. Experiments also pointed out that these losses could be reduced by careful machine operation and management (Sanderson et al., 1997). These experiments show that switchgrass losses in bales stored outside either on sod or gravel were 5.6% and 4.0% of the original bale dry weight, respectively. No weight losses were detected in the bales stored inside. Based on these experiments, a total switchgrass lost 4% of the net yield (fired in the power plant) was assumed. Among the losses, 90% were assumed scattered on the field and road surface or lost during storage, and the rest were embedded in the soil.

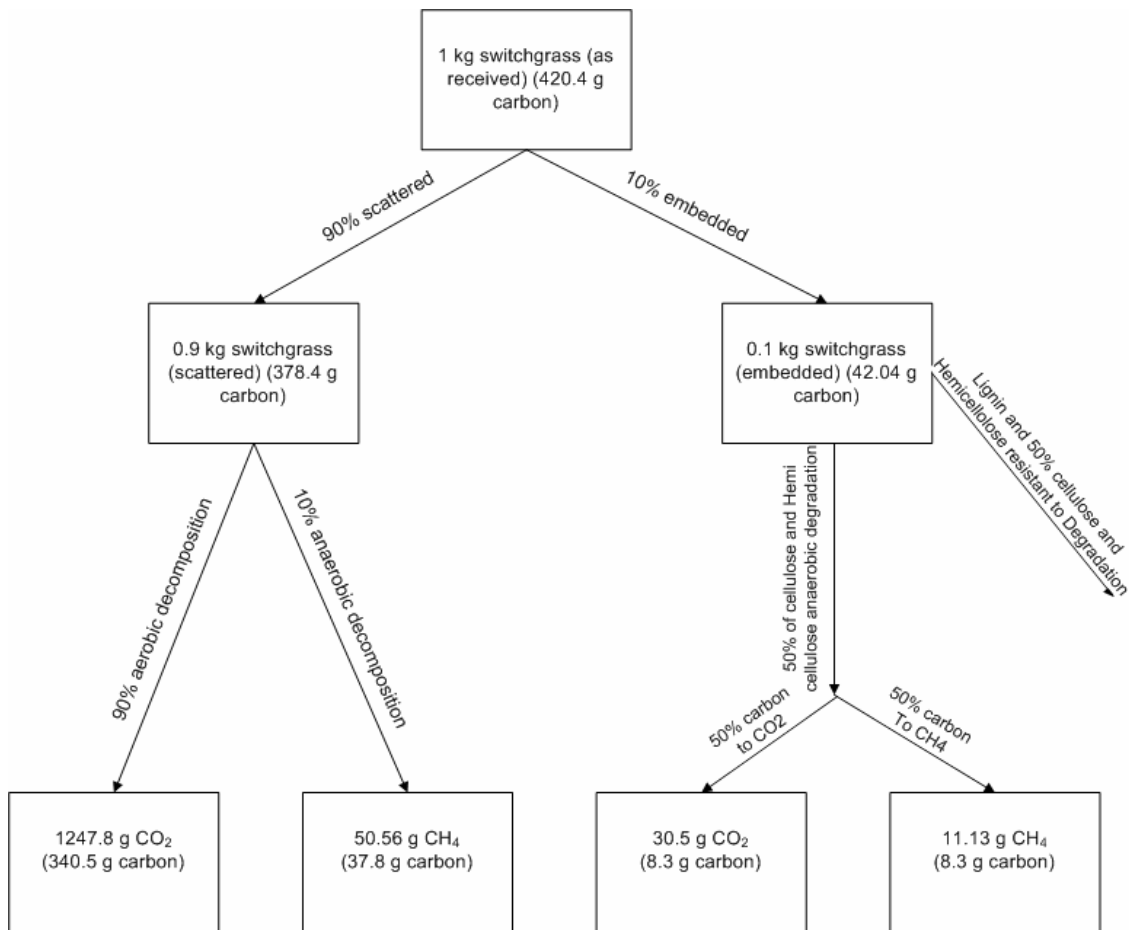
Although the degradation of the lost switchgrass may take a long time, GHG emissions from the degradation were considered as if they occurred in the same harvesting season. The mechanism of biomass degradation in Mann and Spath (2001) was adopted in this study.

The contents of cellulose and hemi cellulose in switchgrass were taken from the study of Lemus et al. (2002), 371g for cellulose and 321g for hemi cellulose (based on 1 kg bone dry switchgrass). The carbon contents of cellulose and hemi cellulose were calculated from the repeating unit. The rest of the carbon was assumed to link with lignin. Therefore, a tree model was used for analysis (Figure 4.7)

Taking the ratio of GHG emissions from the lost switchgrass to net switchgrass yield (fired in the power plant), the following emissions based on 1 kg switchgrass yield are obtained as shown in Table 4.5.

**Table 4.5.** GHG emissions from lost switchgrass

Emission species	CO <sub>2</sub>	N <sub>2</sub> O	CH <sub>4</sub>	CO <sub>2</sub> -Eq
Emission factors (g/kg switchgrass net yield)	51.1	0	2.47	107.9



**Figure 4.7.** Tracking model for losses of switchgrass.

## GHG Emissions from Power Generation

Only direct-fired and co-fired biomass power systems were considered in this analysis. Power generation using biomass or coal produces air-borne emissions including sulfur dioxide (SO<sub>2</sub>), nitrogen oxides (NO<sub>x</sub>), methane (CH<sub>4</sub>) and carbon dioxide (CO<sub>2</sub>). Further, after the combustion, part of the generated waste needs to be transported to a landfill and the SO<sub>x</sub> generated has to be treated or reduced. Power generation can be divided into two sections: combustion and post combustion activities.

### *Combustion*

Two alternatives were considered for combustion:

- switchgrass as the sole feedstock and
- switchgrass co-fired with coal.

Both alternatives are discussed in the following sections.

**Switchgrass fired alone.** Although switchgrass has not been used as the sole feedstock on a production basis for a commercial power plant, a case was constructed based on extrapolation of results from wood-fired power generation.

Emission factors due to switchgrass combustion were assumed to be the same as those for dry wood residue (moisture content less than 20%) combustion in boilers, which was adapted from the USEPA External Combustion Sources report (USEPA, 2003). The resultant emission factors are shown in Table 4.6.

**Table 4.6.** Emission factor of biomass-fired boiler

Emission species	N <sub>2</sub> O (lb/mmBtu)	CH <sub>4</sub> (lb/mmBtu)	SO <sub>x</sub> (lb/mmBtu)	NO <sub>x</sub> (lb/mmBtu)	CO (lb/mmBtu)
Emission factors	0.013	0.021	0.025	0.49	0.60

Emission factor for carbon dioxide ( $EF_{CO_2}$ ) was calculated as follows:

$$EF_{CO_2} = P_c * BF_c * MW_{CO_2} / MW_c / HHV_{sw} \quad (4.1)$$

In this model,  $EF_{CO_2} = 222$  lb/mmBtu.

The amount of switchgrass fired ( $Q_{sw,bn}$ ) and the corresponding electricity ( $Q_{elec}$ ) generated are a function of net plant heat rate (NPHR):

$$Q_{elec} = Q_{sw,bn} / NPHR_{sw,bn} = HHV_{sw} * W_{sw,bn} / NPHR_{sw,bn} \quad (4.2)$$

Existing biomass power plants have heat rates ranging from 13.7 to 21.1 MJ/kWhr or even higher, which correspond to high-heating-value (HHV) efficiencies from 25% to 17% or lower (Hughes, 2000). An average value of 17.4 MJ/kWhr was used as the default net plant heat rate (NPHR) of switchgrass fired alone case. The emissions from switchgrass combustion for electric generation are summarized in Table 4.7.

**Table 4.7.** Emissions from switchgrass-fired alone

Emission Species	CO <sub>2</sub>	N <sub>2</sub> O	CH <sub>4</sub>	SO <sub>x</sub>	NO <sub>x</sub>	CO
g/kg switchgrass	1525	0.09	0.14	0.17	3.37	4.12
g/kWhr by switchgrass	1660	0.10	0.16	0.19	3.66	4.49

**Switchgrass co-fired with coal.** Currently the application of biomass as the sole source of fuel for power plants with large capacity is not common or economical. The nature of biomass also brings other problems to power generation such as slagging and fouling. However, recent studies indicate that cofiring could overcome these problems and perhaps be environmentally beneficial (Boylan et al., 2000). In particular

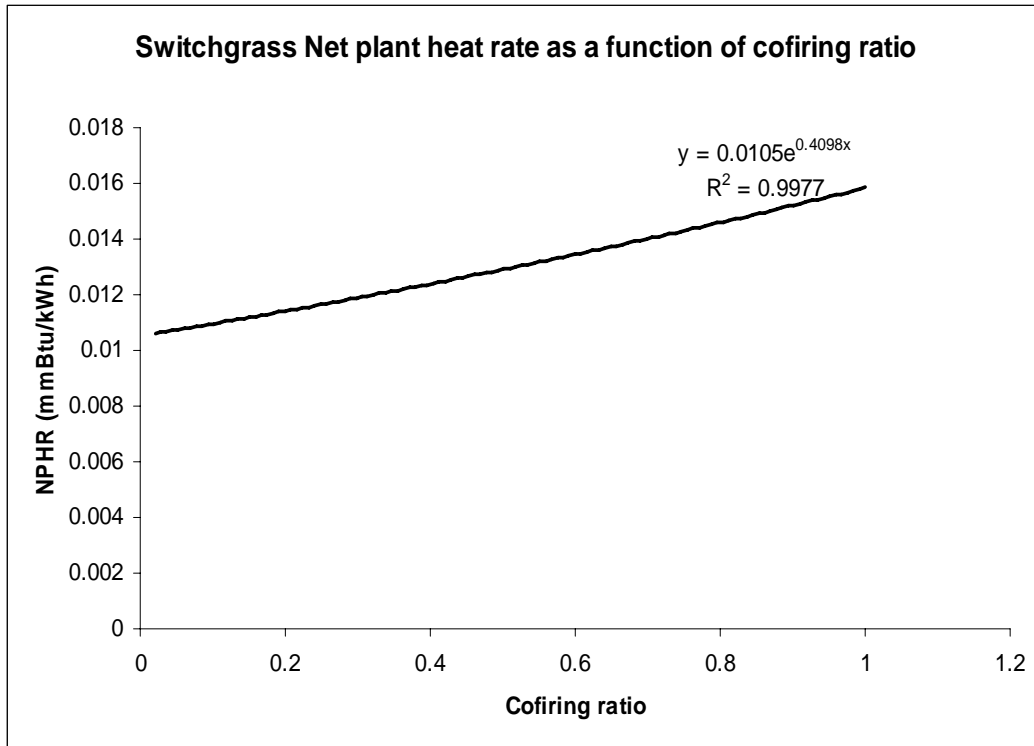
- Total CO<sub>2</sub> emissions can be reduced because the amount of CO<sub>2</sub> released in biomass combustion is largely recycled, being captured during biomass growth so net emissions are low compared to coal alone.
- Most biomass fuels have very little sulfur. Therefore, cofiring high sulfur coal reduces SO<sub>2</sub> emissions (Hughes, 2000). Moreover, because of the more alkaline

ash that arises when combusting biomass, some of the  $\text{SO}_2$  from the associated coal would be captured during combustion, which would lead to an additional reduction of  $\text{SO}_2$ .

- Typically, woody biomass contains very little nitrogen on a mass basis as compared to coal, which would lead to reductions in  $\text{NO}_x$  emissions (Tillman, 2000). The hydrocarbons released along with volatile matter during pyrolysis of biomass or coal can be used to further reduce  $\text{NO}_x$ . Another possible advantage of biomass cofiring stems from the potential catalytic reduction of  $\text{NO}_x$  by naturally present  $\text{NH}_3$  in biomass.

Most cofiring studies have been conducted with biomass percentage of less than 20% by mass of the total fuel. Within this range, the slagging and other problems brought by firing biomass alone are not as significant, but the synergetic effects of cofiring on emission reduction can be significant.

One other important feature of cofiring is that the simultaneous use of coal can improve the heat rate of co-fired biomass. Typical power plant coal thermal efficiency 34.13% was used in this work to calculate the switchgrass thermal efficiency in cofiring by assuming both total mechanical efficiency and coal thermal efficiency are constant. The relation of switchgrass thermal efficiency (1/NPHR) and cofiring ratio can be shown in Figure 4.8.



**Figure 4.8.** Effect of cofiring ratio on switchgrass net plant heat rate (mmBtu/kWh).

Compared to burning biomass alone which has a thermal efficiency falling between 25% and 17% or lower, the efficiency of biomass in cofiring is relatively high.

The relation of electricity generated and corresponding fuel needed ( $W_{\text{fuel,co}}$ ) was expressed by following equations from which the quantities of coal and switchgrass can be calculated.

$$Q_{\text{elec,co}} = \Sigma (\text{HHV}_{\text{fuel}} * W_{\text{fuel,co}} / \text{NPHR}_{\text{fuel,co}}) \quad (4.3)$$

$$R_{\text{sw,thermal}} = \text{HHV}_{\text{sw}} * W_{\text{sw,co}} / \Sigma (\text{HHV}_{\text{fuel}} * W_{\text{fuel,co}}) \quad (4.4)$$

Cofiring 10% switchgrass with coal to generate 1kWhr of electricity requires 0.419kg coal and 0.047kg switchgrass. Tests of cofiring switchgrass with coal have been conducted including cofiring switchgrass in a 50MW pulverized coal boiler at Madison Gas and Electric CO. (MG&E) (Aerts et al., 1997) and cofiring switchgrass in a



725MW gross (675MW net) tangentially-fired pulverized coal boiler at Ottumwa Generating Station (OGS) in Chillicothe, Iowa (Amos, 2002).

Unfortunately in these tests the GHG emissions from cofiring switchgrass were not well documented, and the NO<sub>x</sub> changes were inconsistent. However, the tests indicate SO<sub>x</sub> emission decreased compared with the coal-only firing. The OGS test also showed that switchgrass cofiring did not normally contribute to higher CO readings. Other biomass cofiring studies have confirmed this conclusion. For example Spliethoff and Hein (1998) found that compared with coal-only firing, CO emission did not show any change for biomass shares up to 50% of the thermal input.

Based on these test results and facts, following assumptions are made in the cofiring model:

- Carbon burning fraction of coal and switchgrass are both 99%.
- N<sub>2</sub>O emissions from cofiring are proportional to the emissions of coal fired alone and biomass fired alone according to their thermal input.
- The amount of CH<sub>4</sub> emission per unit electricity output arising from cofiring is the same as that arising from coal-only firing.
- SO<sub>x</sub> emission is proportional to that of coal-fired alone and switchgrass- fired alone according to their thermal input, and sulfur dioxide emission was calculated from sulfur content provided by USDOE/EIA report (USDOE/EIA-0348, 2002). Because switchgrass contains much less sulfur, the SO<sub>x</sub> emission of cofiring is lower.
- NO<sub>x</sub> emissions from switchgrass still remain uncertain.
- National average emission factors and properties of coal were adopted in this model as shown in Table 4.8. Emissions of carbon dioxide and HHV of coal were derived from USEPA report (Inventory of U.S. Greenhouse Gas Emissions and Sinks, 2004).

**Table 4.8.** Average emission factors of coal fired electric generation

Emission species	CO <sub>2</sub>	N <sub>2</sub> O	CH <sub>4</sub>	SO <sub>x</sub>	CO
Emission factors (g/kg coal)	2085	0.031	0.022	17.16	0.25
Emissions (g/kWhr)	935	0.014	0.010	7.69	0.11

Based on the aforementioned assumptions, cofiring 10% switchgrass with coal generates the following emissions per kilowatt hour of total electricity generated, as shown in Table 4.9.

**Table 4.9.** GHG emissions from cofiring 10% switchgrass with coal

Emission species	CO <sub>2</sub>	N <sub>2</sub> O	CH <sub>4</sub>	SO <sub>x</sub>	CO
Emissions (g/kWhr)	944	0.017	0.010	7.19	0.11

### *Post-Combustion Activities*

The activities involved in post-combustion include post-combustion control of SO<sub>x</sub> and waste transportation to a landfill. The following is a description of these activities.

**Switchgrass-fired alone.** Because of the low sulfur content in switchgrass, switchgrass alone firing generates very little SO<sub>x</sub>, (well below than the emission standards required by EPA). Therefore, no post-combustion SO<sub>x</sub> treatment is required when switchgrass alone is fired. Also, because of the ash characteristics of switchgrass, no waste from combustion was reused and all of it was transported 5 miles to a landfill. The following items were considered as waste in this model: all ash, unburned carbon and captured sulfur. These will result in waste of 51.9 g/kg switchgrass burned or 56.4 g/kWhr electricity generated by switchgrass-fired alone.

The waste was assumed to be transported by a heavy-duty truck with load capacity of 25 tons. Table 4.10 gives the calculated GHG emissions from post combustion activity (waste transport) of switchgrass-fired alone.

**Table 4.10.** GHG emissions from post combustion activities of switchgrass-fired alone

Emission species	CO <sub>2</sub>	N <sub>2</sub> O	CH <sub>4</sub>	CO <sub>2</sub> -Eq
Emission factors (g/kg switchgrass)	0.073	1.70E-6	8.37E-5	0.075
Emissions (g/KWh)	0.079	1.85E-6	9.10E-5	0.082

**Switchgrass co-fired with coal.** We assume cofiring will occur in an existing coal-fired power plant, so the equipment should have the same capacity for post-combustion control of SO<sub>x</sub>. The decrease of SO<sub>x</sub> emission due to switchgrass cofiring will be

regarded as a positive credit that can be used for SO<sub>x</sub> offset trading. Post combustion control of SO<sub>x</sub> will involve three activities that in turn have GHG emission implications, i.e. limestone production and transportation, chemical reaction of limestone and SO<sub>x</sub>, and transportation of generated waste. Table 4.11 lists all the GHG emission contributions of post combustion control of SO<sub>x</sub> emission from 10% switchgrass cofiring with coal.

The reused waste of cofiring is also assumed to be equal in amount to that of coal-fired alone. Waste has a steady market and the quality of cofiring waste is acceptable to the market. Thus, the total waste from cofiring ( $W_{waste,co}$ ) can be calculated as follows:

$$W_{waste,co} = (P_{ash,sw} + P_{c,sw} * (1 - BF_{c,sw}) + P_{s,sw} * MW_{SOx} / MW_s) * W_{sw,co} + [P_{ash,coal} + P_{c,coal} * (1 - BF_{c,coal}) + P_{s,coal} * MW_{SOx} / MW_s] * W_{coal,co} - E_{SOx,co} - E_{CH4,co} - E_{CO,co} + W_{CaSO4} + W_{CaCO3} * (R_{CaCO3/SOx} - 1) - W_{waste,reused} \quad (4.5)$$

$$\text{where } W_{CaSO4} = W_{SOx,contr} * MW_{CaSO4} / MW_{SOx} \quad (4.6)$$

The total waste of the 10% switchgrass cofiring would be 38.8 g/kWhr assuming it is transported 5 miles from the power plant. The GHG emissions due to this transportation are listed in Table 4.11.

**Table 4.11.** GHG emissions from post combustion activities

Emission Category	CO <sub>2</sub>	N <sub>2</sub> O	CH <sub>4</sub>	CO <sub>2</sub> -Eq
Emission from limestone production, transportation, reaction (g/kWhr)	2.2	2.5E-6	1.3E-4	2.2
Emission from waste transportation (g/kWhr)	0.1	2.1E-6	1.0E-4	0.1
Total emission from post combustion activities (g/kWhr)	2.3	4.6E-6	2.3E-4	2.3

## Key Results

### *Cost and Energy Evaluation*

The strategy of establishing switchgrass on recrop lands followed by loose harvest then transport after compression into modules is cost effective. Model 123 which is associated with establishment of switchgrass on recrop land leads to an overall production cost of \$32.53/ton. Hence an effective strategy would be to establish switchgrass on previously cropped fields, harvest it loose for hauling and chopping and then compress it into modules for transportation.

Before biomass arrives at the power plant, energy is consumed during the processes of establishment, growth, harvest, and transportation as well as the processes of production and transportation of chemicals used for switchgrass production. The total energy consumed in this process on a ton of delivered product basis is listed in Table 4.12 with the smallest value of 846 Btu/kg switchgrass for Model 123 and largest value of 1498 Btu/kg switchgrass for Model 124, which corresponds to a switchgrass net energy gain (based on HHV) of 94.4% and 90.1% respectively.

**Table 4.12.** Net energy gain of switchgrass as a bioenergy feedstock

Switchgrass processing model	123	111	122	124
Total energy consumption prior to power plant (btu/kg switchgrass)	846	1337	1132	1498
Used energy (based on tested HHV)	5.6%	8.8%	7.5%	9.9%
Net energy efficiency (based on tested HHV)	94.4%	91.2%	92.5%	90.1%

*Lifecycle GHG Emissions*

By analyzing the alternatives for their GHG emissions, the lifecycle GHG emissions from switchgrass-fired alone and co-fired to generate 1 kWhr of electricity can be found. The GHG mitigation during cofiring is better than switchgrass fired alone. The lifecycle analyses for GHG emissions of switchgrass as the energy feedstock for power generation with the Model 223 is listed in the Table 4.13. CO<sub>2</sub>-Eq emissions from 5% switchgrass firing of 965.9 g/kWhr overall life cycle CO<sub>2</sub> emissions can be compared with 997.5 g/kWhr overall life cycle CO<sub>2</sub>-Eq emissions from coal burnt alone. The GHG emission by varying the cofiring ratio to 10% is 935.1 g/kWhr and to 20% is 875.6 g/kWhr.

**Table 4.13.** GHG emissions from switchgrass alone and from 10% cofiring of switchgrass with coal

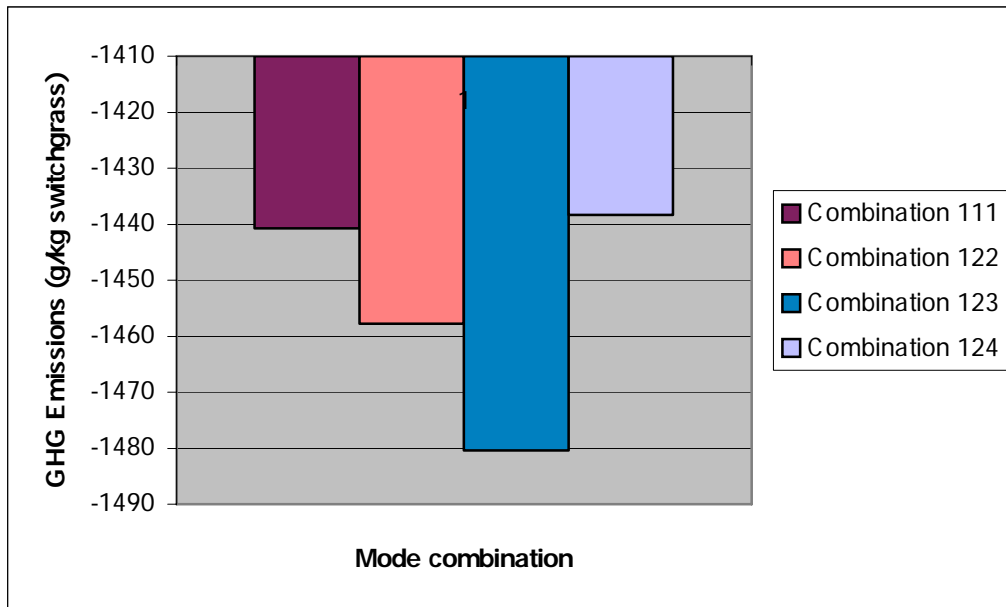
Emission species	CO <sub>2</sub>	N <sub>2</sub> O	CH <sub>4</sub>	CO <sub>2</sub> -Eq
GHG Emissions for switchgrass-fired alone model (g/kWhr)	-68.9	0.27	2.50	68.5
GHG Emissions for 10% switchgrass cofiring model (g/kWhr)	898.7	0.03	1.22	935.1
GHG Emissions assigned to switchgrass in 10% cofiring model (g/kWhr from switchgrass)	-53.0	0.21	1.82	50.4

## **Sensitivity Analysis**

The biocomplexity/lifecycle based analysis is quite complex with several interacting factors. This sensitivity analysis aims to identify the significant effect of variation in one parameter on the overall assessment. Additionally, carbon dioxide emission price has been discussed to provide an economic assessment for the future of switchgrass cofiring with coal to be cost competitive with firing coal alone.

### *Comparison of GHG Mitigation of Alternative Preparation Methods*

Assuming switchgrass from different preparation alternatives has the same quality and combustion characteristics, the effects of preparation method combination on GHG emissions can be examined by comparing GHG emissions. Another intuitive approach is to compare the GHG mitigation of switchgrass before combustion. The GHG mitigation data demonstrates how switchgrass performs as a GHG emissions mitigating energy feedstock. The advantage of Model 123 is obvious as shown in Figure 4.9.



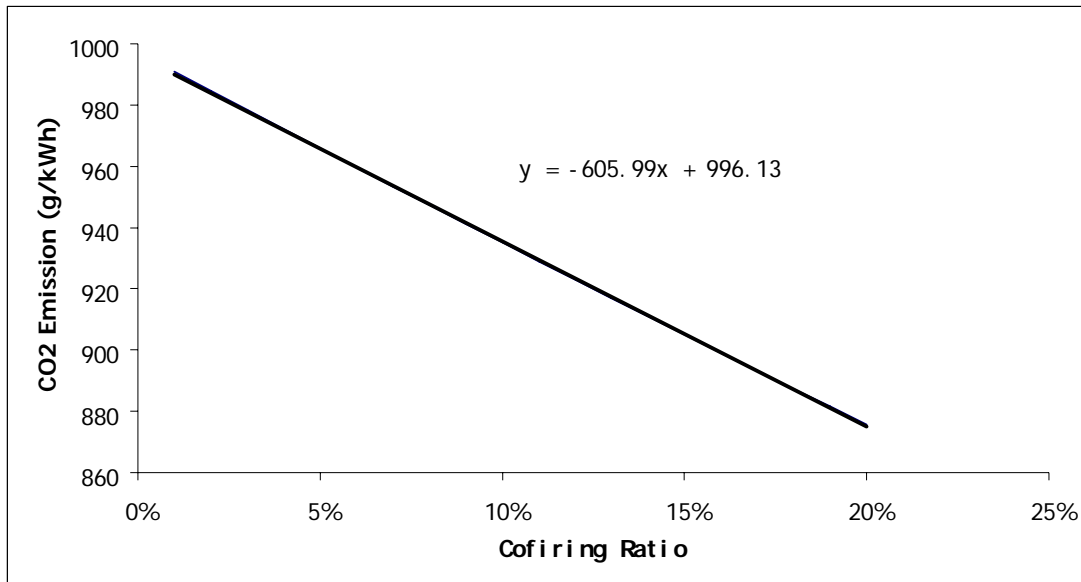
**Figure 4.9.** GHG mitigation of switchgrass processing before combustion for different alternative activity combinations.

#### *GHG Emission Relative to Switchgrass Cofiring Ratio*

Figure 4.10 shows the trend of GHG emissions ( $E_{GHG,co}$ ) with the cofiring ratio of switchgrass based on Model 123. The simulated relation gives a linear function during low cofiring ratios from 1% to 20% as

$$E_{GHG,co} = -606 * R_{sw,co} + 996.13 \quad (4.7)$$





**Figure 4.10.** GHG emissions as a function of cofiring ratio.

### **Carbon-Dioxide-Equivalent Emission Price**

Lifecycle analyses of biomass and coal as the energy sources for power generation indicate that biomass will generate less GHG emissions. But biomass cofiring would only be economical if the cost savings from replacing coal with switchgrass can more than offset the capital modification cost in the plant and any additional labor and maintenance costs to operate the cofiring plant. For biomass to become a practical method to mitigate GHG emissions from power generation, the high cost of biomass must be overcome.

Technical progress in biomass growth and transportation are crucial to reducing costs. Imposing a carbon cost on carbon emitters will make the commercialization of biomass even more practical. The major costs in the cofiring operation include the cost of fuel and the capital cost of modification of the power plant to enable biomass fuel to be co-fired with coal. The difference between the cost for switchgrass and the cost of

coal displaced by switchgrass is taken into account by evaluating the CO<sub>2</sub>-Eq emission price (offset subsidy). The calculation of CO<sub>2</sub>-Eq emission price is based on the idea that to generate equal amount of electricity, the cost of coal fired alone should be equal to the cost of switchgrass fired alone or the cost of switchgrass co-fired with coal after CO<sub>2</sub>-Eq emission price is added. Thus, to make switchgrass an economically viable biomass power generation fuel, the need for the CO<sub>2</sub>-Eq emission price would have to be eliminated. The sensitivity of CO<sub>2</sub>-Eq emission price to various factors will indicate which factors should be researched to make switchgrass economically viable.

For switchgrass fired alone:

$$C_{\text{coal}} * W_{\text{coal,bn}} + C_{\text{GHG}} * E_{\text{GHG,coal,bn,lc}} = C_{\text{sw}} * W_{\text{sw,bn}} + C_{\text{GHG}} * E_{\text{GHG,sw,lc}} \quad (4.8)$$

For switchgrass co-fired with coal:

$$C_{\text{coal}} * W_{\text{coal,bn}} + C_{\text{GHG}} * E_{\text{GHG,coal,bn,lc}} = C_{\text{coal}} * W_{\text{coal,co}} + C_{\text{sw}} * W_{\text{sw,co}} + C_{\text{GHG}} * E_{\text{GHG,co,lc}} \quad (4.9)$$

The delivered cost of coal is taken as \$28.13/tonne of coal based on the 2002 US national average data from USDOE/EIA-0348, 2002.

Besides the fuel costs and CO<sub>2</sub>-Eq emission price, the extra costs due to power plant modification for switchgrass cofiring in coal fired power plants and the allowance for SO<sub>x</sub> reduction were also taken into account. Theoretically, the change of NO<sub>x</sub> should be considered too, but because of the inconsistent conclusions about the NO<sub>x</sub> emissions of switchgrass cofiring and the trade of NO<sub>x</sub> offsets is not nationwide, this issue is left for future work. Thus the CO<sub>2</sub>-Eq emission price can be calculated from the following formulae:

For switchgrass fired alone:

$$C_{\text{coal}} * W_{\text{coal,bn}} + C_{\text{GHG}} * E_{\text{GHG,coal,bn,lc}} = C_{\text{sw}} * W_{\text{sw,bn}} + C_{\text{GHG}} * E_{\text{GHG,sw,lc}} + C_{\text{SOx}} \quad (4.10)$$

For cofiring switchgrass with coal:

$$C_{\text{coal}} * W_{\text{coal,bn}} + C_{\text{GHG}} * E_{\text{GHG,coal,bn,lc}} = C_{\text{coal}} * W_{\text{coal,co}} + C_{\text{sw}} * W_{\text{sw,co}} + C_{\text{GHG}} * E_{\text{GHG,co,lc}} + C_{\text{modi}} + C_{\text{SOx}} \quad (4.11)$$

where cost of power plant modification and allowance of SO<sub>x</sub> reduction can be calculated as shown in the following paragraphs.

The modification cost for cofiring capability is \$50-100/kW for blending feed and \$175-200/kW for separate feed (kW of biomass power capacity) (Hughes, 2000). A 100 MW boiler co-fired at 5%, which has a \$200/kW cost of capital modifications would cost \$ 943,764.94 to modify. A salvage value of 10% of initial value and a 10 year useful life were used in this analysis.

The reduction of SO<sub>x</sub> emissions due to switchgrass cofiring will be regarded as a positive credit as traded under the Acid Rain program. The credit for SO<sub>x</sub> is the difference between the amount of SO<sub>x</sub> generated from coal fired and co-fired power plants for a given amount of electricity generated. Dividing the credit by the electricity generated, the per unit electricity SO<sub>x</sub> reduction at this switchgrass cofiring ratio was determined. This reduction multiplied by the SO<sub>x</sub> trading price (\$250/ton SO<sub>x</sub> was used in this study (Tharakan et al., 2005)) gives the cost allowance for SO<sub>x</sub> reduction. The general formula for calculating the reduction of SO<sub>x</sub> emission is:

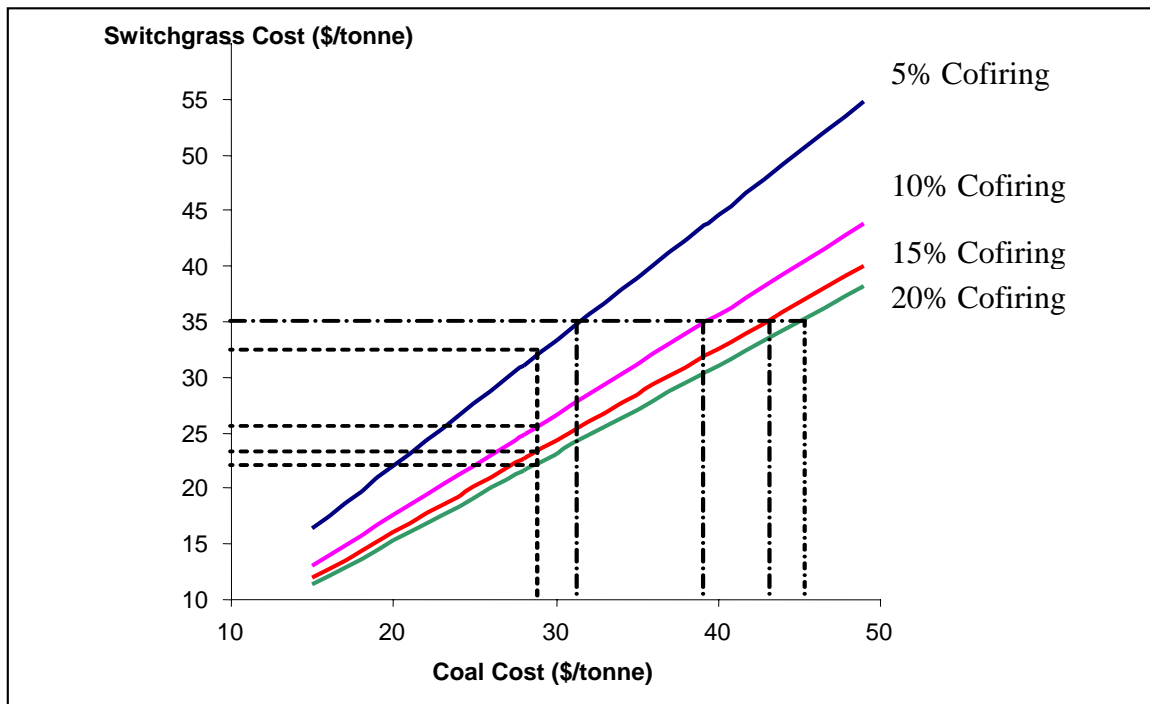
$$W_{SO_x,co,credit} = W_{sw,co} * HHV_{sw} / NPHR_{sw,co} * NPHR_{coal} * EF_{SO_x,coal} - W_{sw,co} * HHV_{sw} * EF_{SO_x,sw} \quad (4.12)$$

This formula can also be used for biomass fired alone plants to calculate the SO<sub>x</sub> credits due to the replacement of coal with biomass for electric generation.

#### *Relation of Breakeven Cost between Switchgrass and Coal Costs*

Economics is an important consideration in determining the commercial feasibility of biomass for power generation. Currently biomass is not competitive with coal on a cost basis. Cofiring can improve the situation, but the economic barrier is still unsurpassable without stimulating policy actions such as a CO<sub>2</sub> emission price or imposing CO<sub>2</sub> tax or an increase in coal prices. Figure 4.11 shows the breakeven cost of switchgrass and coal at 5%, 10%, 15% and 20% cofiring without CO<sub>2</sub> emission price. Taking the average coal cost of \$28.13/tonne, the breakeven switchgrass cost must be \$31.22/tonne, \$24.95/tonne, \$22.78/tonne and \$21.69/tonne at cofiring ratios of 5%, 10%, 15% and 20% respectively, which is much lower than the real switchgrass cost. Analysis also shows that even at the cheapest switchgrass cost (\$34.7/tonne in this

analysis), switchgrass can match up coal only when the cost of coal reaches \$32.5/tonne, \$39.4/tonne, \$44.5/tonne and \$47.2/tonne respectively for the various cofiring ratios, which is higher than current average coal cost.



**Figure 4.11.** Effect on switchgrass and coal cost as CO<sub>2</sub> emission price breaks even.

### *CO<sub>2</sub>-Eq Emission Price and Switchgrass Cofiring Ratio*

As mentioned above, cofiring is the most promising way to reduce GHG and other pollutants emission without serious technical and practical problems. The most important factor for this analysis is the cofiring thermal efficiency of power generation, which will directly influence the values of most other aspects. Although the efficiency implication introduced before is simulated based on tests of cofiring ratio up to about 20%, and experiments with cofiring ratio over 20% are very rare; to give an overall picture of this analysis, the application is extended to higher cofiring ratios. Cost of cofiring is analyzed as a function of cofiring ratio, which consists of fuel cost (including both coal and switchgrass), cost of equipment modification and SO<sub>x</sub> credits. Figure 4.12 shows the costs of the coal, switchgrass, plant modification, SO<sub>x</sub> credit which add up to give the overall cost of cofiring, with variation in cofiring ratio. With increase in cofiring ratio, the cost of switchgrass and the cost for plant modification go up, where as the cost of coal and SO<sub>x</sub> credit decrease. The overall composite cost of cofiring captures all these trends and is an exponential increase with cofiring ratio.

The resultant CO<sub>2</sub>-Eq emission price that would be required for cofiring to be cost competitive with coal is about \$13.2/tonne CO<sub>2</sub>, \$14.2/tonne CO<sub>2</sub>, and \$16.1/tonne CO<sub>2</sub> at switchgrass cofiring ratio of 5%, 10%, and 20% respectively as can be seen from Figure 4.13. Such a cost may be in the feasible range as current prices in the European markets are above these levels (\$20.83/tonne, Point Carbon, April 18, 2005).

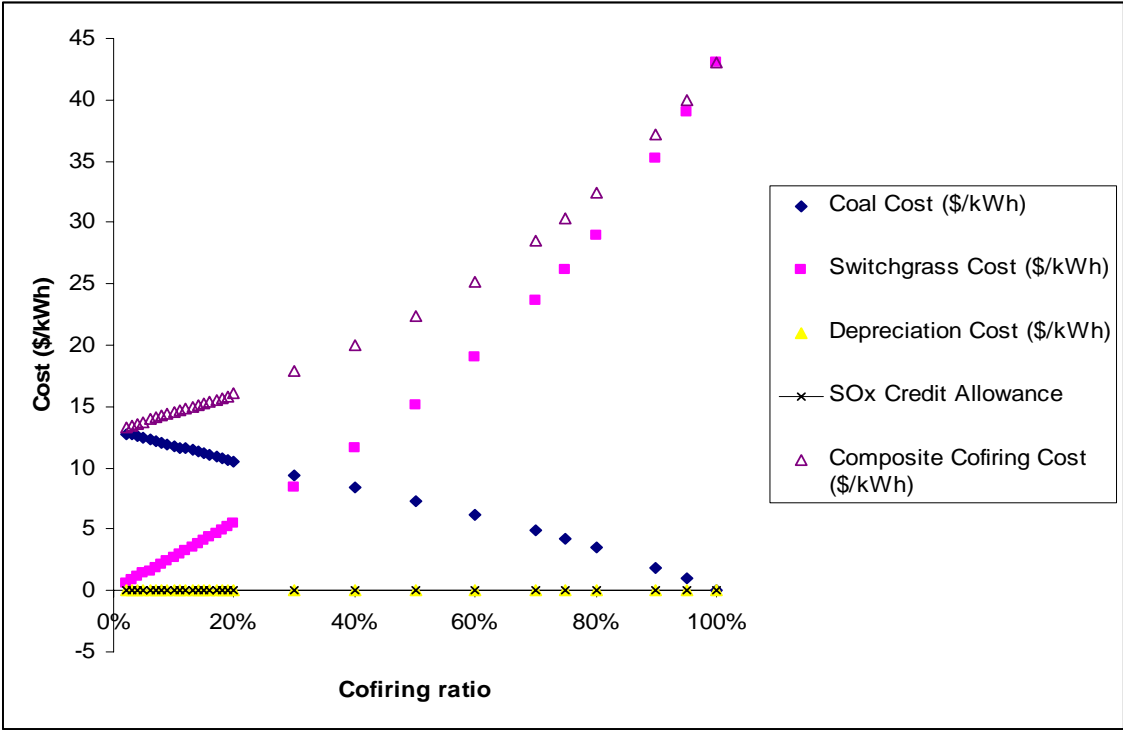
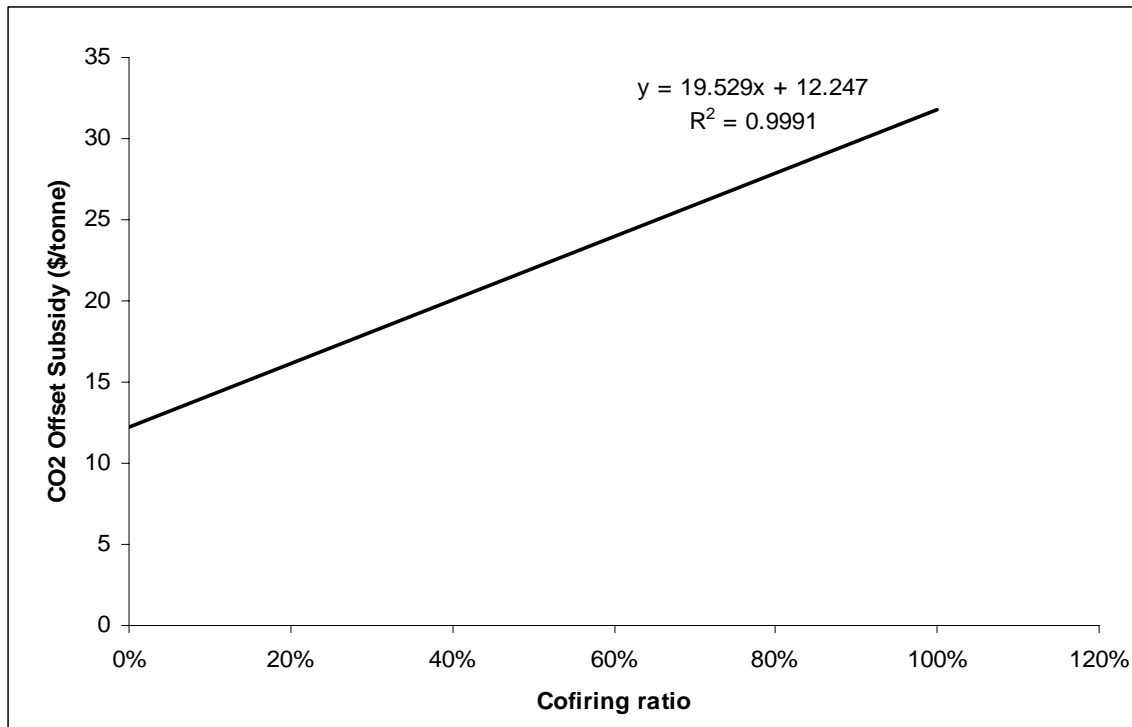


Figure 4.12. Effect of cofiring ratio on cost of cofiring.

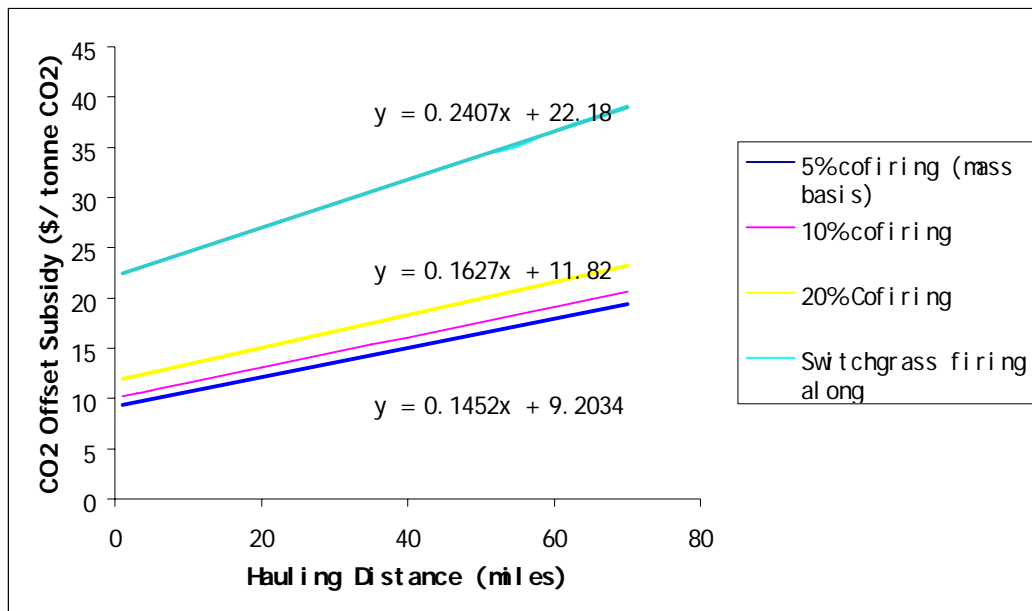


**Figure 4.13.** CO<sub>2</sub> emission price as a function of cofiring ratio.

#### *CO<sub>2</sub>-Eq Emission Price and Hauling Distance*

Hauling distance is one of the key barriers for biomass commercialization as an energy feedstock. Transportation costs depend on the distance between the production site and the power plant, and the road conditions. Noon et al. (1996) estimated that average cost of transporting switchgrass in Alabama is \$8.00/dry tonne for hauling distance of 25 miles. As the transportation cost changes with the hauling distance, the CO<sub>2</sub>-Eq emission price will also change with the distance. Model results, Figure 4.14, show that under the same parameters of yield and stand life, the CO<sub>2</sub>-Eq emission price appears as linear increase with the hauling distance. It also goes up with the increase of cofiring ratio, which is consistent with the result above. Further, the slopes of the equations gradually increase with the increase of cofiring ratios, indicating that cofiring

with higher ratio is even more sensitive to the hauling distance than a lower ratio cofiring.



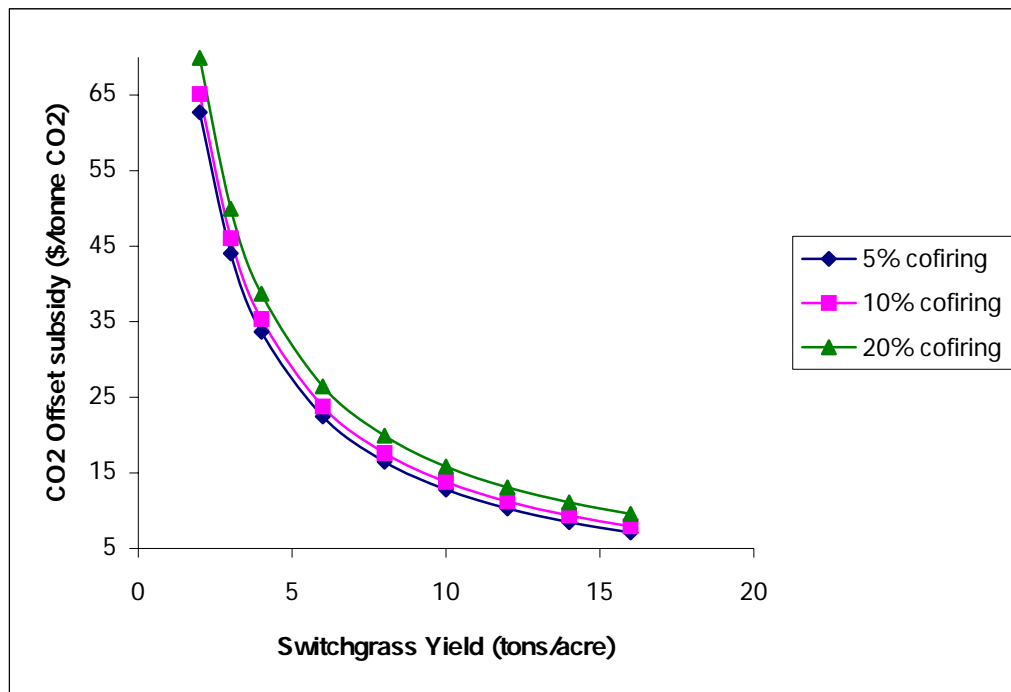
**Figure 4.14.** CO<sub>2</sub> emission price as a function of the hauling distance of switchgrass.

### *CO<sub>2</sub>-Eq Emission Price and Yield*

There is potential to increase the yield of switchgrass by decreasing the row spacing, increasing the nitrogen application rate (Ma et al., 2001) and doing plant breeding work. As the yield of switchgrass (tons/acre) is increased (keeping the plant capacity and the stand life fixed at 100 MWhr and 10 years, respectively), the breakeven CO<sub>2</sub> emission price decreases exponentially, almost independent of the cofiring percentage. The sensitivity analysis shown in Figure 4.15 illustrates that with lower yield, less than about 8 tons/acre, the CO<sub>2</sub> emission price would need to be relatively large, but as the yield is increased, the needed subsidy decreases. For switchgrass yields



above 12 tons/year, the decrease of CO<sub>2</sub> emission price is less than \$1/tonne CO<sub>2</sub>-Eq for each additional ton of yield. The high sensitivity of CO<sub>2</sub> emission price to the switchgrass yield, especially in the low yield situation, demonstrate that enhancing switchgrass yield is very important for commercializing biomass to power generation strategies.

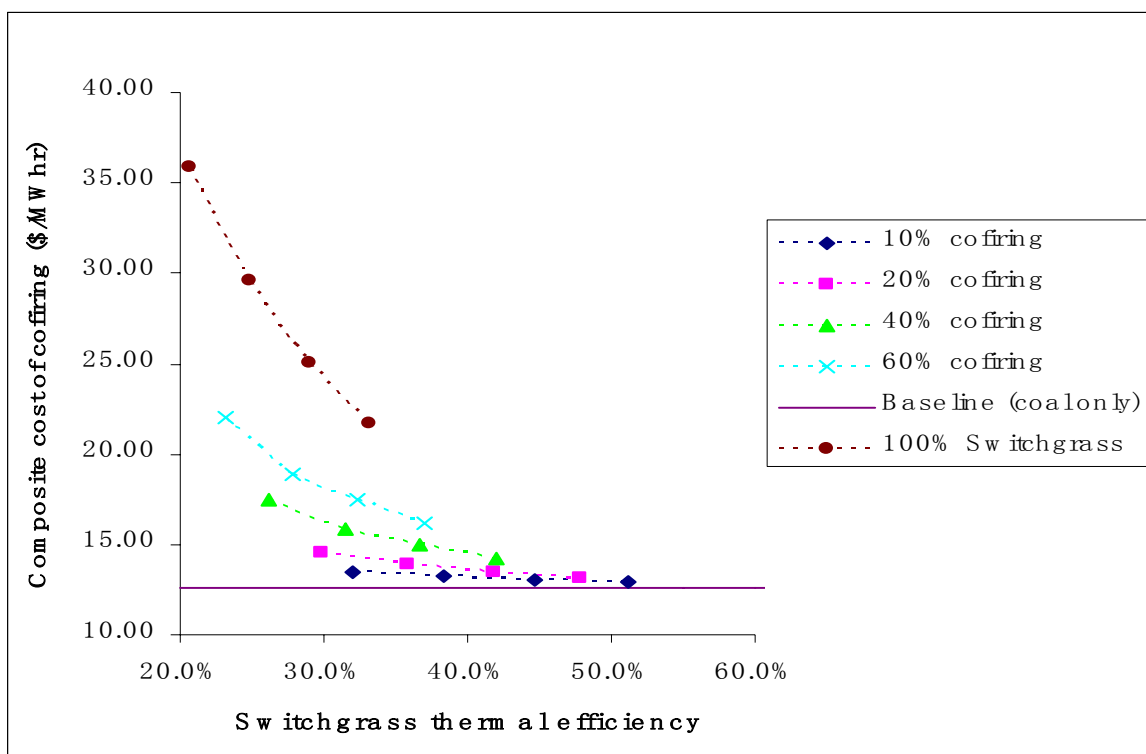


**Figure 4.15.** CO<sub>2</sub> emission price as a function of yield of switchgrass.

#### *Cofiring Cost as a Function of Switchgrass Efficiency Enhancement*

Assuming that switchgrass efficiency will be enhanced in the future by new, improved and efficient equipment, the cost of cofiring would decrease. Figure 4.16 demonstrates this concept. The left most point in the curves for all cofiring ratios is the current switchgrass thermal efficiency, which is about 32% for 10% cofiring, 30% for

20% cofiring, 26% for 40% cofiring, 23% for 60% cofiring and 20% for switchgrass fired alone. The switchgrass thermal efficiency is then assumed to increase (by 20%, 50% and 70% as shown by the points in the Figure 4.16) in the future decreasing the cofiring cost. The rate of decrease is less for lower cofiring ratios and is higher for higher cofiring ratios. The curves also illustrate that for lower cofiring ratios of up to about 20%, cofiring switchgrass can become competitive with firing coal alone with a small emission price for switchgrass. However, for higher cofiring ratios, large emission price would be required to breakeven with coal. Also, the cost of coal, assumed to be constant, would in practice increase over time. This would lead to cofiring being cost competitive, without any emission price, with a small enhancement in switchgrass thermal efficiency for cofiring ratios of up to about 40%.



**Figure 4.16.** Cost of cofiring as a function of switchgrass thermal efficiency enhancement.

## Conclusions

An integrated biocomplexity/lifecycle analysis approach was applied to examine the economic, energy and GHG issues of using switchgrass as an alternate or a supplementary feedstock for power generation. Costs and emissions were examined for alternatives from production to transport to power generation to waste disposal. The analysis shows that the most effective technology for switchgrass preparation is establishing switchgrass on previously cropped fields, harvesting loose for hauling and chopping, and then transporting by compression into modules, which cost \$32.53 per ton of switchgrass produced. The total energy consumed before switchgrass is sent for combustion into power generation ranges from 846 Btu/kg switchgrass to 1498 Btu/kg switchgrass, which corresponds to a switchgrass net energy gain (based on HHV) of 94.4% and 90.1% respectively. The GHG mitigation per ton of switchgrass used during cofiring is better than switchgrass fired alone with the GHG effects of 68.5 g CO<sub>2</sub>-Eq /kWhr for switchgrass fired alone and 50.4 g CO<sub>2</sub>-Eq /kWhr for 10% switchgrass cofired with coal. This work analyzed the CO<sub>2</sub>-Eq emission price as a function of cofiring ratio, hauling distance, and yield. Enhancing switchgrass yield is the most important way to reduce CO<sub>2</sub> emission prices needed to use switchgrass as a biofuel. Cofiring is more favorable than switchgrass firing alone for power generation. Reducing the hauling distance of switchgrass to the power plant will reduce needed CO<sub>2</sub> emission prices.

If switchgrass is to become competitive with coal for power generation fuel, either higher coal prices, a CO<sub>2</sub> offset market price or lower production costs are needed. In terms of production costs agronomic research is needed to improve switchgrass yields, develop lower cost establishment and growing practices, or determine lower cost harvest and transportation processes. Engineering research should be conducted into more efficient methods of cofiring and reducing the non-CO<sub>2</sub> emissions of switchgrass. Research should also explore potential uses for waste after cofiring.

## **V. OPTIMIZATION OF BIOMASS ELECTRICITY PRODUCTION COST**

The lifecycle environmental biocomplexity model developed in Section IV provides an insight into the multiple complex interactions among the technical, agricultural, environmental and economics factors. However, changing one parameter affects the overall assessment substantially as illustrated in the sensitivity analysis of Section IV. In the present section mathematical programming is employed to optimize the various parameters to obtain the minimum total biomass electricity cost and simultaneously mitigate GHG emissions for various scenarios.

### **Objective**

The overall objective is to minimize the total biomass and fossil fuel power generation cost while mitigating emissions at the same time for various alternate competitive biomass processing pathways. The total cost includes the cost of power generation and the emission price cost which might be required for biomass to compete with conventional fuels. Optimum values for various parameters such as cofiring ratio, plant size, distance, etc would be evaluated. The study of the effect of plant modification and retrofitting on the overall economics would be undertaken.

### **Methodology**

The focus of this section is to develop an optimization tool that minimizes the total power generation cost while mitigating emissions using switchgrass as the biomass feedstock and coal as the fossil fuel. The model described in Section IV for lifecycle biocomplexity analysis of switchgrass is utilized here to study the interactions and correlations among the various parameters and evaluate the optimum result.

The objective in this case can be written as:

$$\text{Min } (Total \text{ Electricity Production Cost}) \quad (5.1)$$

where the total electricity production cost is the sum of the power generation cost using switchgrass and coal in optimized cofiring ratio, and the emission price cost for biomass to be competitive with coal. The total electricity production can be written as:

$$Total \text{ Electricity Production Cost} = ((1 - \alpha) \times Coal \text{ Cost} \times Coal \text{ required} + \alpha \times Biomass \text{ cost} \times Biomass \text{ required}) - Emission \text{ Price Cost} \quad (5.2)$$

In the equation 5.2, there are several variables which need to be computed by optimization depending on their interactions within the lifecycle stages. The cofiring ratio,  $\alpha$ , is a variable within fixed known restrictions. The cost of coal is a known parameter, taken as \$28.13/tonne for this analysis. The cost of switchgrass is a variable and is computed depending on the processing pathway chosen by the optimization formulation. The coal and switchgrass required are also variables which are computed based on cofiring ratio and electricity generated. The emission price is calculated using integer programming depending on the reduction of greenhouse gases.

The mathematical programming technique is employed for formulation of the model using LINGO. This technique is beneficial as all possible pathways for biomass processing can be investigated. A MINLP is solved to choose for the minimum cost and minimum greenhouse gas alternative. Within this framework, it is possible for a plant to be solely coal fired or biomass fired, or a combination of both with optimized cofiring ratio. There are numerous modeling equations to describe the cost and GHG emission calculations for the various stages that are added to the program in the form of constraints. Formulation of the model using LINGO is relatively easy. But, enumeration of all possible pathways, modeling all the lifecycle stages and calculating the economics and GHG emissions of all the lifecycle stages makes the code quite lengthy. Several constraints add non linearity in the model, and solution convergence becomes increasingly more difficult. The model complexity and non linearity is reduced by modeling the processing pathways in practically feasible groups. Each of these groups are designated as "model abc" where

- ‘a’ gives the land type used (1 for pasture and 2 for recrop)
- ‘b’ gives harvesting method including round baling (1) or chopping and loose harvest (2) and
- ‘c’ gives hauling preparation and resultant transport method including moving round bales (1), or moving loose material (2); compressed loose material(3) or pelletized loose material (4).

The LINGO model and the solution are given in the appendices A.1 and A.2. The various constraints for the model formulation are described below.

The objective function that consists of minimizing the total electricity production costs is subject to a number of restrictions and limitations, pertaining to the cost, emissions, technical issues, performance criteria, mass and energy balance, etc., that are known as constraints. These constraints are subcategorized into three classes:

- General Constraints
- Constraints for Economic Calculations
- Constraints for GHG Emissions Calculations

#### *General Constraints*

The following are the general constraints used for the model:

- Prices of fuel, i.e. diesel, gas, LPG and electricity prices
- Financial Parameters, such as interest rate, insurance, tax, general overhead rate, land rental, etc.
- Variation in biomass yield and size of enterprise
- Reseeding fraction required for the establishment stages
- Capacity the loads truck can transport for various biomass forms such as bales, pellets, compressed material, etc.
- Variation in cofiring ratio
- Variation in density
- Plant efficiency
- Plant size

- Variation in distance

Distance = fn (*Plant size, Hours of operation, Plant efficiency, Biomass required, Yield, Density*)

- Standlife
- Fertilizer use

### *Constraints for Economic Calculations*

The economics of all the biomass processing pathways are investigated. The various constraints used for this are described here.

- Variable Cost = fn (*Repair cost, Lube cost, Fuel cost, Fertilizer use*)
- Repair Cost = fn (*Machine type, Estimated hours of use*)
- Fuel cost = fn (*Fuel type used, Fuel amount used, Horsepower of machine*)
- Lube cost = fn (*Fuel cost, Lube to fuel ratio*)
- Fixed Cost = fn (*Depreciation cost, Insurance cost, Interest cost, Tax cost, Number of passes*)
- Salvage cost = fn (*Machine factors, Years of use*)
- Depreciation cost = fn (*Salvage cost, Estimated hours of use*)
- Insurance cost = fn (*Salvage cost, Insurance rate, Annual hours of use*)
- Interest cost = fn (*Salvage cost, Interest rate, Annual hours of use*)
- Hours per acre of machine use = fn (*Width covered, Speed of machine, Efficiency*)
- Labor Cost = fn (*Hours per acre, Labor to machine ratio, Labor wage rate, Number of passes*)
- Total Cost for a processing stage = fn (*Fixed cost, Variable cost, Labor cost*)
- For establishment the cost is amortized over the stand life

$$\text{Establishment Amortized Cost} = \left( \frac{\text{Interest}}{(1 - (1/(1 + \text{Interest})^{\text{Standlife}}))} \right) \cdot \text{Establishment Total Cost} \quad (5.3)$$

The total cost for biomass processing stage is evaluated using the above constraints for all machines employed in that processing stage. The establishment cost is amortized over the stand life of biomass feedstock. The various stages for biomass preparation are establishment (on pasture or recrop lands), maintenance, harvest (bales or loose) and transportation (baled, chopped, compressed or pelletized); as discussed in Section IV. The establishment on pasture land is included in this analysis with the assumption that the yield is same as on the recrop lands, but the land rental is substantially lower. The modeling equations for this establishment stage can be dropped out to evaluate the cost of preparation using only recrop lands. After evaluating the cost for all stages and their subcategories, the processing pathways are grouped into eight pathways or models as discussed in the previous section (Model abc). The amortized establishment cost is included in the maintenance cost; and the harvest cost is included in the transportation cost depending on the optimized processing pathway.

#### *Constraints for GHG Emissions Calculations*

After the economic evaluation, the constraints for GHG emission due to various biomass processing stages as well as the combustion and post combustion are required to be added to the model. The following is the list of various constraints employed for this model:

- GHG emissions from biomass preparation activities

$\text{CO}_2$  Emissions = fn (*Machine horsepower, Hours per acre, Number of passes, Yield, Standlife, Reseeding*)

$\text{N}_2\text{O}$  emissions = fn (*Machine horsepower, Hours per acre, Number of passes, Yield, Standlife, Reseeding*)

$\text{CH}_4$  emissions = fn (*Machine horsepower, Hours per acre, Number of passes, Yield, Standlife, Reseeding*)

Total emissions from one stage of preparation =  $\text{CO}_2$  Emissions + 23.  $\text{CH}_4$  emissions + 296.  $\text{N}_2\text{O}$  emissions



All emissions from preparation stages are evaluated in similar manner by taking the machines for that stage and their respective factors.

- Emissions from loss of switchgrass

A total switchgrass loss of 4% of the net yield is assumed in this model based on experiments (Sanderson et al., 1997).

Net GHG from lost biomass = fn (*Loss ratio, Yield, Carbon content, Aerobic and Anaerobic degradation, Cellulose, Hemi cellulose, Lignin, Carbon mulched and embedded*)

- N<sub>2</sub>O Emissions due to nitrogen fertilizer use = fn (*Yield, Fertilizer use, Runoff, Volatized and non volatized N<sub>2</sub>O*)

- Emissions from soil accumulation = fn (*Soil CO<sub>2</sub>, Yield*)

- Emissions due to sequestration = fn (*Biomass carbon content, Sequestration energy, Amount of biomass*)

Soil accumulation and sequestration represent net negative emissions due to carbon uptake of soil and the plant.

- Emissions from chemicals

- Emissions from nitrogen = fn (*Nitrogen use, Production activities, Yield, Energy used, Transportation*)

- Emissions from phosphorus pentoxide= fn (*P<sub>2</sub>O<sub>5</sub> use, Production activities, Yield, Energy used, Transportation*)

- Emissions from potassium oxide = fn (*K<sub>2</sub>O use, Production activities, Yield, Energy used, Transportation*)

- Emissions from atrazine= fn (*Atrazine use, Production activities, Yield, Energy used, Transportation*)

- Emissions from lime = fn (*Fuel input, Energy used, Emissions from production, Emissions from fuel use, Truck and rail transportation emissions, Yield*)

- Emissions due to combustion = fn(*Ultimate analysis of biomass, Material balances*)

- Emissions due to cofiring =  $\text{fn}(\text{Cofiring ratio}, \text{Amount of fuel used}, \text{Thermal value}, \text{Electricity generated per unit fuel}, \text{Ultimate analysis}, \text{Emissions due to combustion})$
- Emissions due to post combustion =  $\text{fn}(\text{SO}_x \text{ control}, \text{Waste disposal})$
- Lifecycle emissions =  $\text{fn}(\text{Biomass preparation stage emissions}, \text{Chemicals production}, \text{Application and transportation}, \text{Accumulation and sequestration}, \text{Biomass loss}, \text{Combustion}, \text{Cofiring}, \text{Post combustion})$

Lifecycle emissions are computed for all the eight alternate biomass processing pathways.

Evaluation of the optimum combination of activities that yield the minimum total cost and minimum emissions is carried out using integer programming. Binary variable  $C_i$  are used for the cost and  $G_i$  for the GHG emissions for the option  $i$ , where  $i$  represents one of the eight combinations of practically feasible processing pathways. The following set of equations illustrates the technique employed.

$$\sum_{i=1}^8 C_i = 1 \quad (5.4)$$

$$@ \text{bin}(C_i) \quad (5.5)$$

$$\text{Cost of Production} = \sum_{i=1}^8 (C_i \cdot \text{Production Cost of } i\text{'th pathway}) \quad (5.6)$$

Similarly, GHG emissions are evaluated for all alternative pathways.

$$\sum_{i=1}^8 G_i = 1 \quad (5.7)$$

$$@ \text{bin}(G_i) \quad (5.8)$$

$$\text{GHG Alternative} = \sum_{i=1}^8 (G_i \cdot \text{GHG emissions of } i\text{'th pathway}) \quad (5.9)$$

$$\forall i; G_i = C_i \quad (5.10)$$

### *GHG Emission Price Calculation*

The per tonne GHG emission price for biomass to compete with coal is calculated based on a known amount of permissible emissions,  $N$ . The emission price

could be a credit ( $a$ ) to the power generation facility if the emissions are less than the permissible amount ( $N$ ), and it could be a penalty ( $b$ ) if the emissions are higher.

$$\text{If } GHG \text{ Alternative} > N; \text{ Emission Price} = b \quad (5.11)$$

$$\text{Else if } GHG \text{ Alternative} \leq N, \text{ Emission Price} = a$$

$$@ bin(i) \quad (5.12)$$

$$(N - (GHG \text{ Alternative})) \cdot (2i - 1) \geq 0 \quad (5.13)$$

$$\text{Emission Price Cost} = a \times i - b \times (1 - i) \cdot GHG \text{ Alternative} \quad (5.14)$$

The total electricity production cost is sum of the optimized fuel power generation cost based on the constraints, and the emission price cost. In this work, the total electricity production cost is analyzed from the perspective of a power generation company, and the emission price cost would be a credit to the power company for reducing emissions by using biomass. Thus, the emission price cost would be subtracted from the fuel power cost component. The cofiring ratio,  $\alpha$ , is employed in the formulation to decide on the optimum fuel combination.

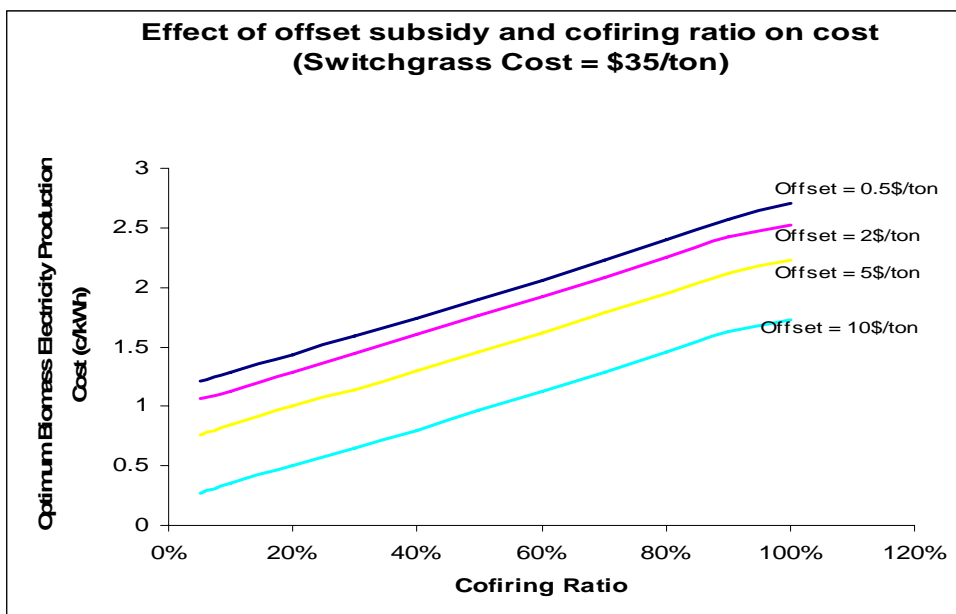
$$\text{Total Electricity Production Cost} = ((1 - \alpha) \times \text{Coal Cost} \times \text{Coal required} + \alpha \times \text{Biomass cost} \times \text{Biomass required}) - \text{Emission Price Cost} \quad (5.2)$$

## Results and Discussion

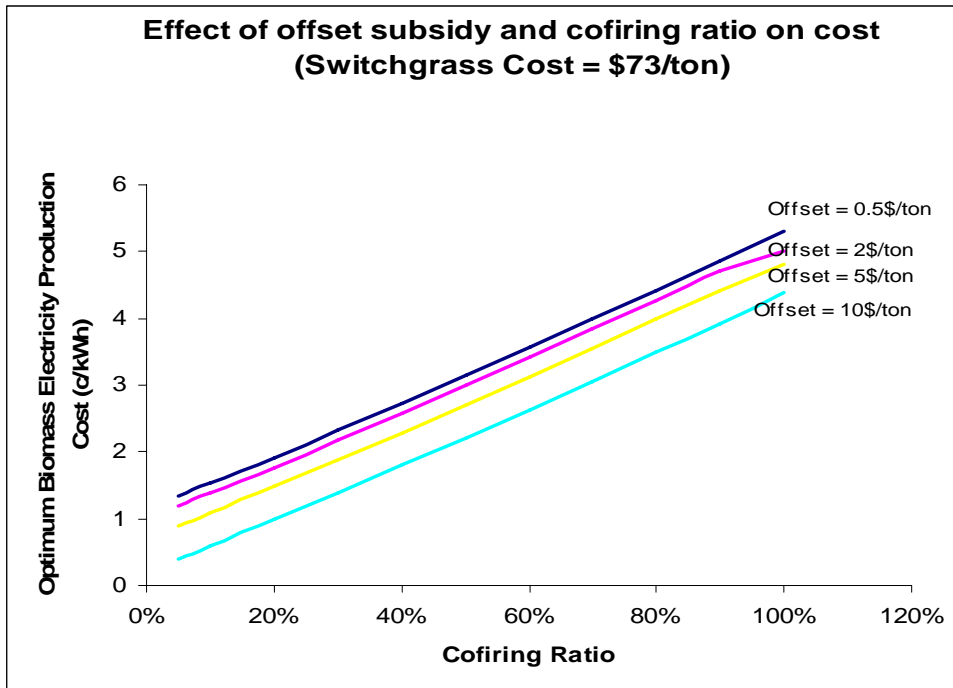
### *Electricity Cost as a Function of Emission Price, Cofiring Ratio and Biomass Cost*

There is a wide variation in biomass preparation cost from \$35/ton to \$100/ton, depending on several factors such as yield, efficiency, stand life, machines used, alternate preparation pathways, hauling distance and financial parameters. The emission price and the biomass electricity production cost are highly sensitive functions of biomass preparation cost as illustrated in Figures 5.1 and 5.2. For biomass cost of \$35/ton, the biomass electricity production cost goes to a maximum of 2.7 cents/kWh (with emission price of \$0.5/ton) and would compete with coal with a small emission price. However, if the biomass cost is increased to \$73/ton, the electricity production

cost rises to 5.3 cents/kWh for an emission price of \$0.5/ton. Even with a high emission price of \$10/ton, the electricity cost for biomass preparation cost of \$73/ton falls to only 4.4 cents/kWh. Hence, it is vital to reduce the biomass preparation cost for biomass to be competitive with coal.



**Figure 5.1.** Variation of biomass electricity cost as a function of emission price (offset subsidy) and cofiring ratio for biomass cost of \$35/ton.

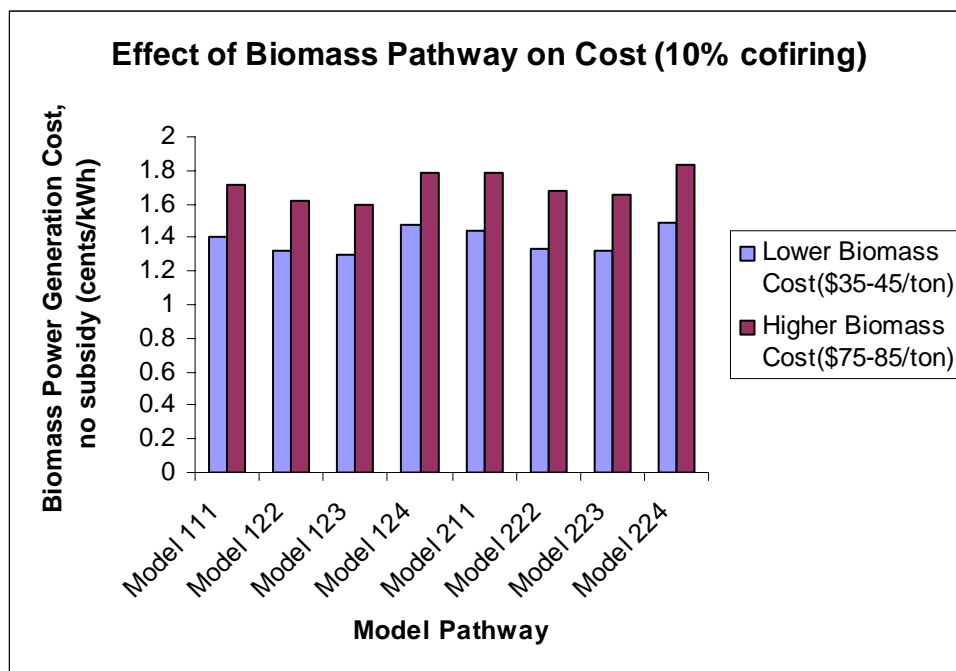


**Figure 5.2.** Variation of biomass electricity cost as a function of emission price and cofiring ratio for biomass cost of \$73/ton.

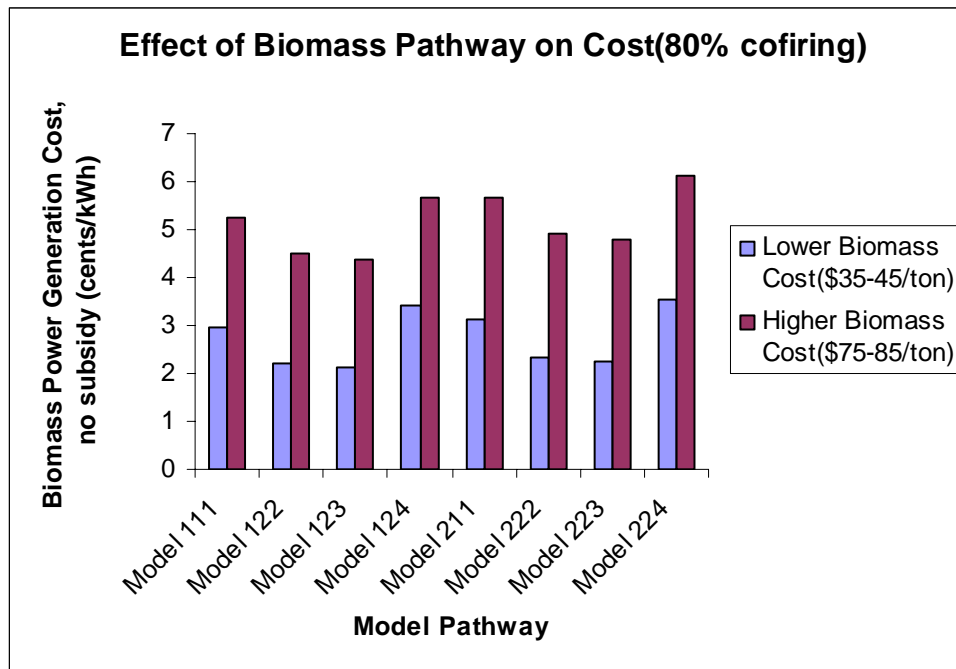
### *Alternate Biomass Pathway*

The total electricity production cost without any emission price is analyzed for all the possible biomass processing pathways. This analysis is carried out for varying biomass costs of \$30/ton to \$100/ton and multiple cofiring combinations. The power generation cost for lower biomass cost is lower for any cofiring ratio as shown in Figures 5.3 and 5.4. As the cofiring ratio is increased, the effect of increase in the biomass cost is more evident on the power generation cost, as shown in Figure 5.4. This illustrates the importance of agricultural work needed to develop lower costing biomass energy feed stocks. The trend followed by the power generation cost for the various alternate pathways is same in all the cases, with pathways using loose harvested material compressed or chopped for transportation yielding the minimum power generation cost

of 1.3 cents/kWh and 1.6 cents/kWh for lower and higher biomass cost scenarios for the 10% cofiring case. The costs rise to 2.1 cents/kWh and 4.4 cents/kWh respectively for the 80% cofiring case. The processing stages leading to baled material and/or pelletized material yield higher cost for any scenario. The reason for this behavior is that the machines employed for these activities are less efficient economically and environmentally.



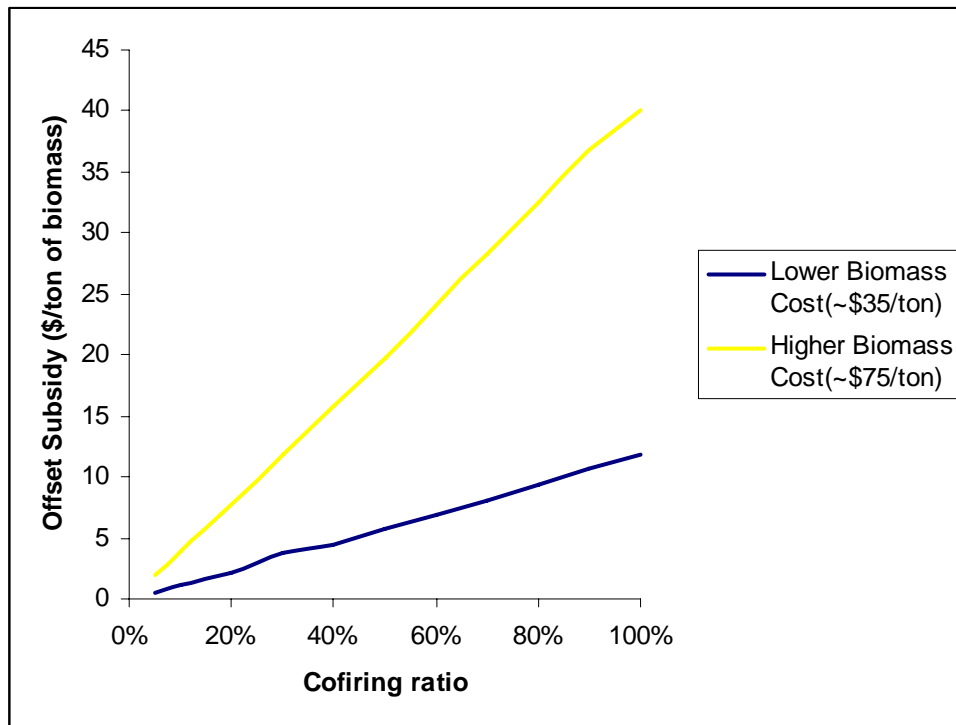
**Figure 5.3.** Biomass electricity cost as a function of model pathways for 10% cofiring.



**Figure 5.4.** Biomass electricity cost as a function of model pathways for 80% cofiring.

#### *Cofiring Ratio and Emission Price*

As the cofiring ratio is increased, more biomass is substituted for fossil fuel, and hence the cost increases due to the higher cost of biomass and GHG emissions decrease. The increase in the fuel component of the cost for power generation is balanced by the higher emission price to breakeven the total cofired biomass power cost with the total power cost from fossil fuel alone. Hence, on increasing the cofiring ratio the emission price goes up for any biomass cost, as illustrated in Figure 5.5. Further, the increase in the emission price is steeper in the case of higher biomass cost on increasing the cofiring ratio due to the same reasons discussed above. The emission price costs for both cases may be compared with the current prices in the European markets of \$ 20.83/ton (Point Carbon, April 18, 2005).



**Figure 5.5.** Variation of emission price with cofiring ratio for lower and higher biomass costs.

### *Plant Modification and Retrofitting*

Biomass feedstock such as switchgrass can be cofired with coal in pulverized coal boilers or cyclone boilers with some modification. All studies until now have been based on cofiring ratio of 15% or 20%; thus, it is not evident how much and what level of modification would be required for cofiring biomass in presently available boilers.

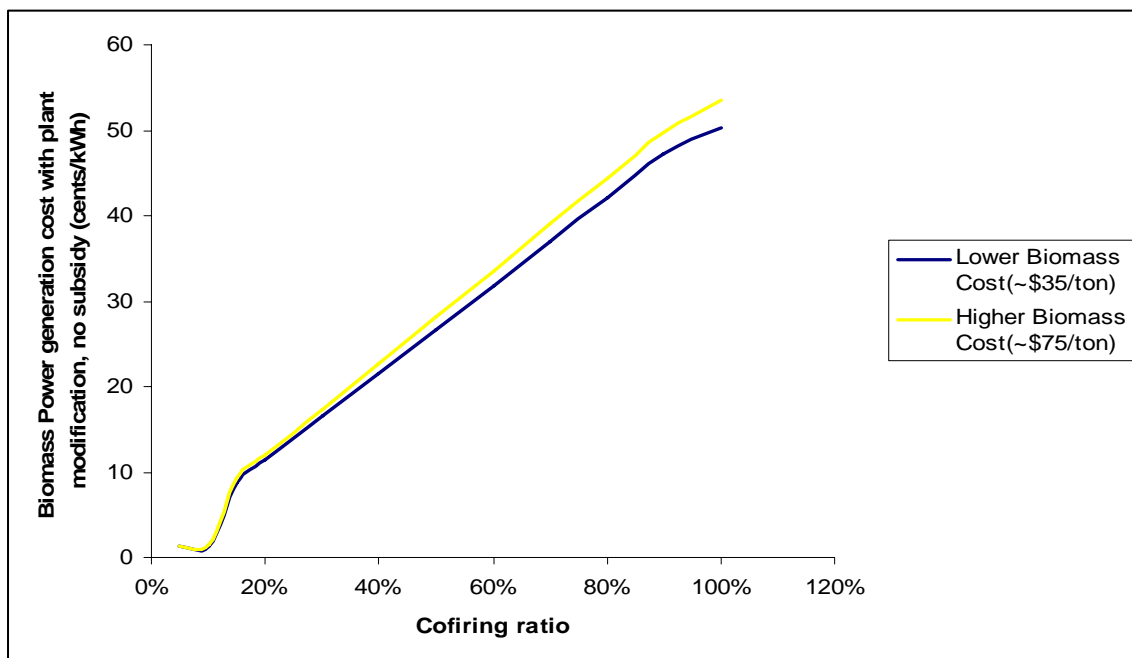
In this work, it is assumed that for cofiring ratio lower than or equal to 15%, the modification cost is constant at 0.03cents/kWh (based on modification cost of \$200/kW (Hughes, 2000)); which would take into consideration changes such as feeding equipment for the boiler. However, at cofiring ratio higher than 15%, it is assumed that



plant modification required would be larger in terms of the equipment and technology employed; hence a function linearly increasing with cofiring ratio is used for the model.

$$\begin{aligned} \text{If } \alpha < 0.15; \quad \text{Modification Cost} &= 0.03 \\ \text{Else if } \alpha > 0.15, \quad \text{Modification Cost} &= 0.5 \times \alpha \end{aligned} \quad (5.13)$$

Addition of the plant modification constraint into the model gives a cost of 1.26 cents/kWh for lower biomass cost and 1.4 cents/kWh for higher biomass cost with an optimum cofiring ratio of 5%. In this case, optimization chooses the minimum cofiring ratio as the optimum cofiring ratio, because the modification cost plays a dominant role in the overall cost, and on increasing the cofiring ratio, the modification cost increases rapidly. This is shown in Figure 5.6. As can be seen in Figure 5.6, the effect of higher modification cost is more visible than the higher biomass cost in this case. Thus, future engineering work is required to find effective ways to lower down the plant modification cost for higher ratios of biomass cofiring in the available boilers.



**Figure 5.6.** Effect of cofiring and biomass cost on biomass power generation cost with plant modification.

## **Conclusions**

Through this work, a generic computer-aided model for optimization of biomass electricity production cost is developed. The model describes the most effective biomass processing pathways as the ones using loose harvested material compressed or chopped for transportation. These pathways yield minimum power generation cost and are most environment friendly. In addition, the formulation is used to study the effect of a number of varying parameters such as cofiring ratio, emission price, biomass cost, etc. The model illustrates the need for future agricultural and engineering research in developing lower cost biomass feedstocks and reducing the plant modification costs. These steps would make the emission price lower and help in making biomass economically competitive with conventional fuels.

## **VI. OPTIMUM ALLOCATION OF BIOMASS AND FOSSIL FUEL TO POWER PLANTS**

The location of power plants with respect to the biomass and fossil fuel sources is an important consideration for economic feasibility. Hauling distance is of paramount importance for biomass and leads to significant economic variations. Hauling biomass to a farther distance would not only entail higher costs but also lead to more emissions due to the transportation processes. Further, storage, deterioration and special needs for some biomass transportation may lead to higher costs. The allocation of biomass and fossil fuel therefore takes into account the complex interactions of the lifecycle and environmental biocomplexity analysis for optimal routing of streams.

To effectively reduce the barrier for biomass to be competitive with coal, we need to optimize the usage and allocation of biomass to the generating stations. This work is aimed at developing a robust, yet generic, tool to effectively manage biofuel and conventional fuel sources in a holistic manner. The objective of this work is to develop a generic tool to optimize the cost and greenhouse gas emissions for allocation of fuel sources to the power generating sinks.

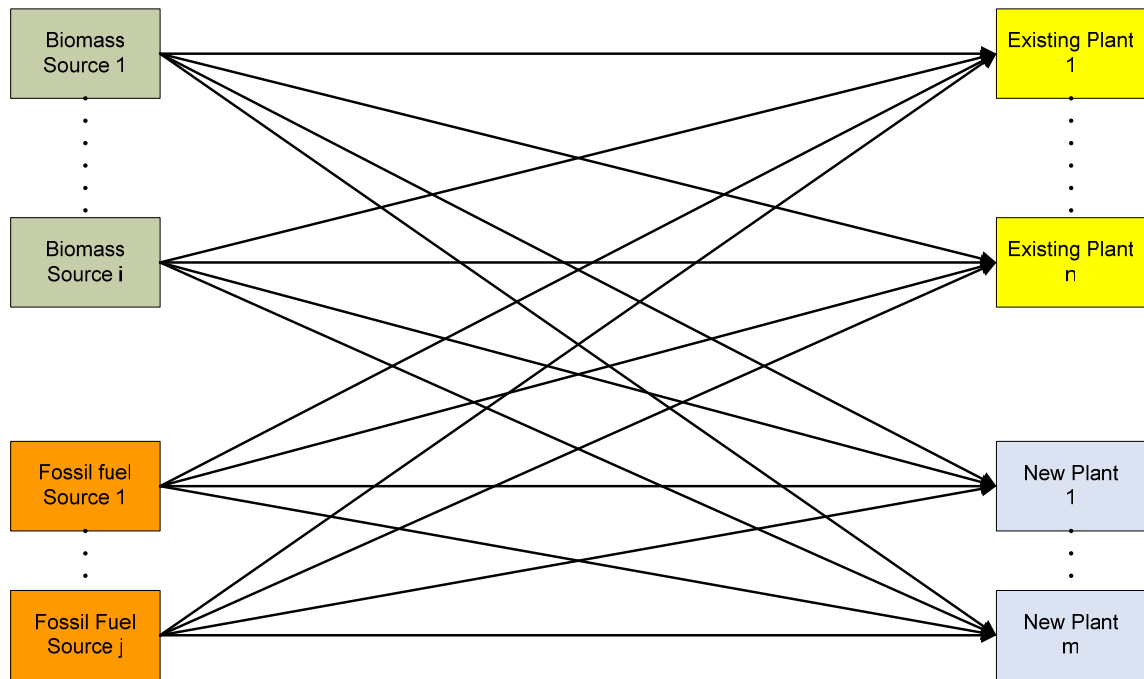
### **Problem Statement**

This work addresses the following problem: given a set of biomass sources ‘i’, fossil fuel sources ‘j’ and existing power plants ‘n’ with known locations and known supply and total demand, it is desired to formulate an allocation strategy that minimizes the total cost, emissions and distance while satisfying the performance, supply-demand, environmental and financial constraints; and determine if one or more new plants would be required to meet the demand and at what location(s). Also, determine the plant size, efficiency and cofiring ratio for individual plants.

## **Methodology**

A geographical area with biomass sources and fossil fuels is first selected. This site is analyzed for any existing power plants. Biomass sources could be wood waste, short rotation woody crops, short rotation herbaceous crops (e.g., switchgrass), manure, landfill gas, wastewater treatment gas, biowaste, biomass residue, etc. As discussed in previous sections, use of biomass is beneficial as being renewable, biomass is the first option that any country would exploit for domestic fuel resources; and biomass helps in mitigating GHG emissions due to closure of carbon cycle. However, there are numerous factors that need to be discussed for practical application of biomass technologies, such as issues pertaining to hauling, storage, deterioration and transportation of biomass.

The objective at hand is to allocate biomass and fossil fuel to the power plants so as to minimize the total cost, emissions and distance. The allocation task is demonstrated by the mixing-splitting network diagram shown in Figure 6.1.



**Figure 6.1.** Allocation network for biomass and fossil fuel to existing and new plants.

There are several complex interactions that affect the biomass-fossil fuel system performance. These interactions can be modeled as constraints for the optimization problem using mathematical programming. A MINLP is solved using LINGO. The various constraints are:

#### *Restrictions on Cofiring Ratio*

Biomass can be fed to the power plant with or without coal. Cofiring ratio is an important parameter that affects the overall system performance. Restrictions on the lower and upper bound of the cofiring ratio are set based on assumptions and practical considerations.

### *Plant Size and Total Capacity of All Plants*

The total demand for power generation is decided and that determines the total capacity of all plants; whether existing or new ones to be constructed. The total capacity is split into different power plant sizes depending on the plant efficiency, plant size, biomass efficiency, distance, cost and emissions.

### *Biomass and Fossil Fuel Required*

The requirements of the fuels for power generation comprise an integral part of the optimization task and are dependent on a number of variables. The amounts of biomass and fossil fuel sources required to meet the demand is computed based on the plant size, demand for power generation and biomass cofiring ratio.

### *Plant Efficiency and Plant Capacity*

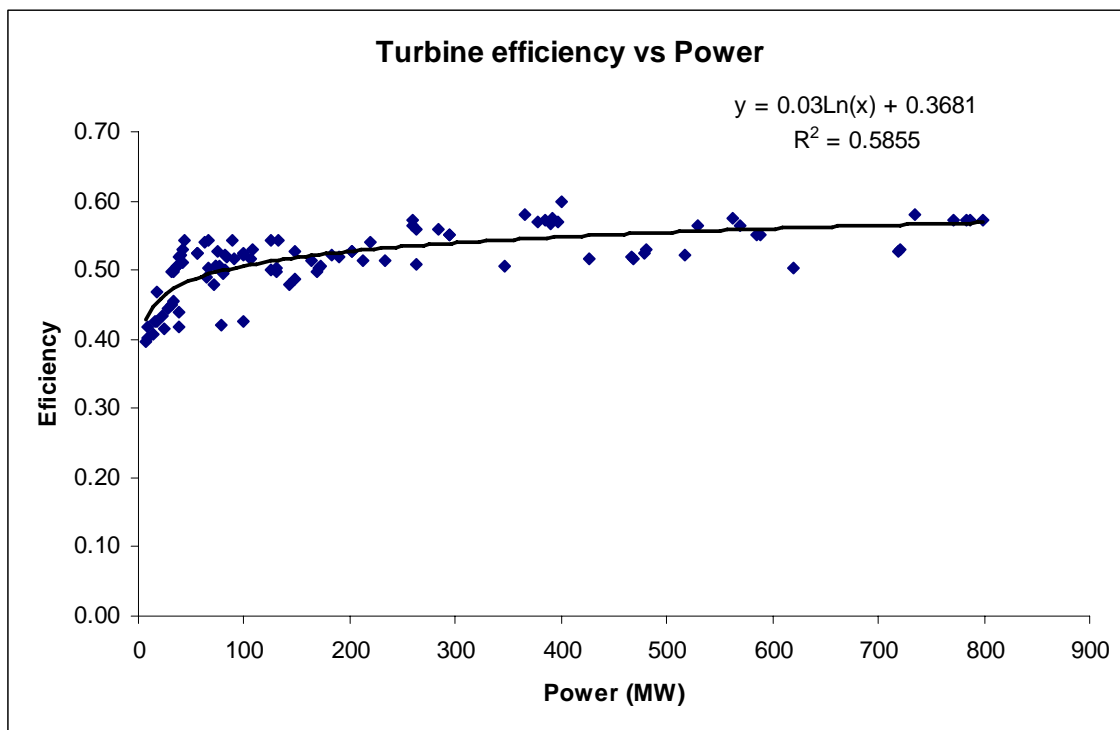
The power plant size and efficiency affect the results of the optimization problem. For analyzing these variables, the effect of plant size ( $p$ ) on the plant efficiency ( $\eta$ ) is examined. For the purpose of this work, data from the turbine manufacturer's data (Falcon Power Ltd.) is analyzed as shown in Figure 6.2.

There is a logarithmic increase in the efficiency when the power generation is increased. The relation between power (MW) and the efficiency is:

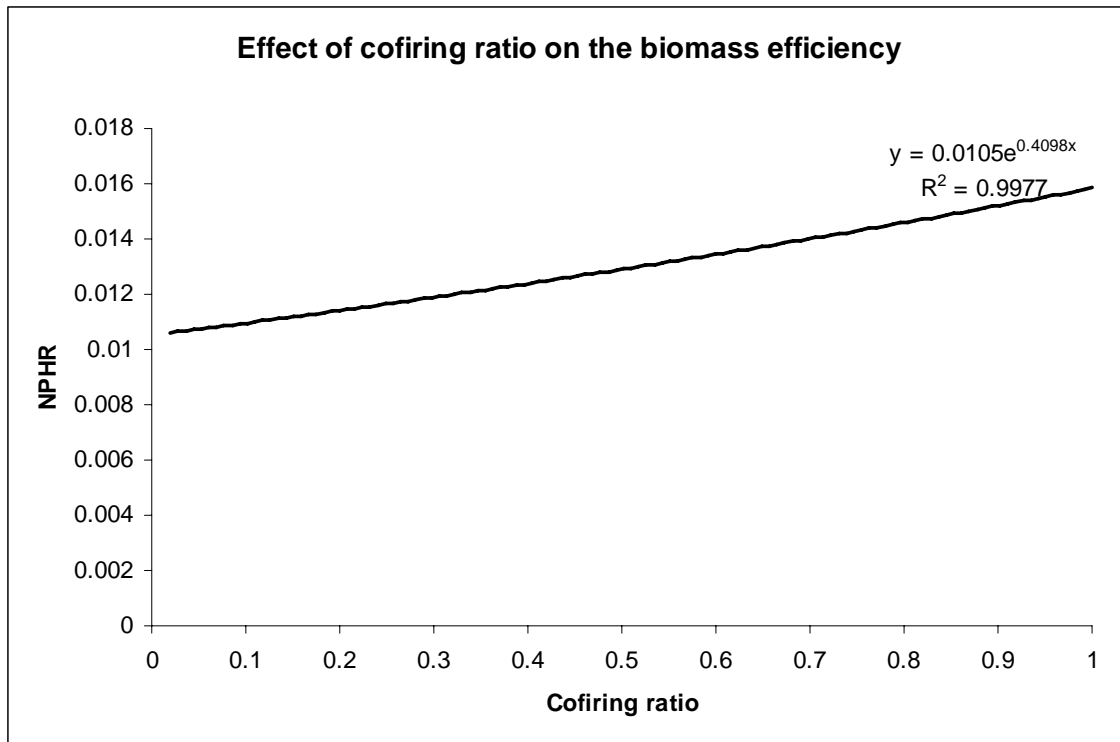
$$\eta = 0.03\ln(p) + 0.3681 \quad (6.1)$$

### *Biomass Efficiency and Cofiring Ratio*

On increasing the cofiring ratio, the biomass efficiency falls. The switchgrass net plant heat rate ( $1/\eta_s$ ) is analyzed as a function of cofiring ratio ( $c$ ), to take this variation into account.



**Figure 6.2.** Effect of power plant generation (MW) on the plant efficiency.



**Figure 6.3.** Increase in net plant heat rate (decrease in efficiency) as a function of cofiring ratio.

The simulation by varying cofiring ratios is illustrated in Figure 6.3. The following exponential relation is used for the model formulation:

$$1/\eta_s = 0.0105\exp(0.4098c) \quad (6.2)$$

#### *Cost as a Function of Cofiring Ratio*

On increasing the cofiring ratio, the biomass electricity production cost increases due to increase in biomass fuel usage and higher plant modification costs. The functionality between cost variations with cofiring ratio is evaluated from the electricity production cost model described in the previous section.



### *GHG as a Function of Cofiring Ratio*

As more biomass is cofired with coal, the carbon recycling effect due to biomass is higher and this consequently reduces the emissions. The relation between the extents of GHG decrease with increasing cofiring ratios is evaluated from the optimum electricity production cost model formulation described in Section V.

### *Demand as a Function of Cofiring Ratio*

For a particular plant size, as the cofiring ratio is increased, the demand for biomass power generation is going to increase. The functionality between these two variables is studied from the basic biomass lifecycle model formulation, and is included in the optimization task for proper allocation.

### *Demand as a Function of Plant Size*

The demand of power is a strong function of the power plant size. As the plant size is increased, the efficiency as well as the demand increases. This factor is taken into account while formulating the optimum allocation model for routing biofuels to biofacilities.

### *Splitting of Biomass and Fossil Fuels*

The biomass and fossil fuels are split to the power plants depending on the cofiring ratio, biomass and plant efficiency, emissions, cost and distance. The total fuels sent to the power generation facilities should satisfy the supply constraint.

### *Mixing to Meet the Demand*

The demand constraint for the existing and new plants (sinks) should be satisfied by the mix of sub streams and split streams from the biomass and fossil fuel sources.

Having described the objective and the various constraints for proper allocation and routing of given biomass and fossil fuel sources to existing and new plants, now the presented approach is applied to a case study.

### **Case Study**

Consider switchgrass as the biomass source and coal as the fossil fuel source. The power generation is assumed by direct combustion technique with any cofiring ratio. The location of switchgrass farms, coal mine and existing power plants are known. It is required to optimally allocate the switchgrass and coal from their respective locations to the power generation facilities.

The objective function is:  $\text{Min (Cost + Emissions + Distance)}$  (6.3)

For modeling the constraints, the model formulation for optimization of biomass electricity production cost is used to calculate the relations between the coal required, switchgrass required, electricity production cost, demand and greenhouse gases, by varying the cofiring ratio and the plant size. Possible locations for new plant are assumed, and optimum location is chosen by integer programming. The data is obtained from the MINLP formulation of the LINGO program for optimum electricity production cost (shown in Appendices A.1 and A.2) by varying these parameters. This data is analyzed for functionalities between various optimization variables and the relationships between switchgrass required vs cofiring, coal required vs cofiring, cost vs cofiring, GHG vs cofiring, demand vs cofiring, demand vs plant size and cost vs plant efficiency are obtained, as shown in Figure 6.4 to Figure 6.10.

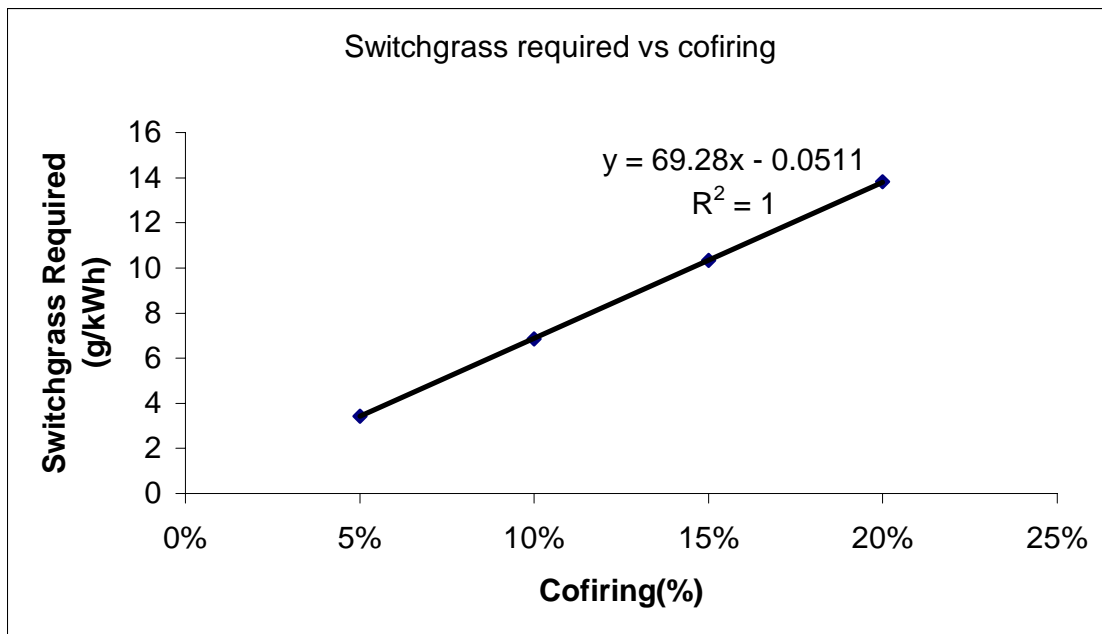


Figure 6.4. Effect of cofiring ratio on switchgrass required.

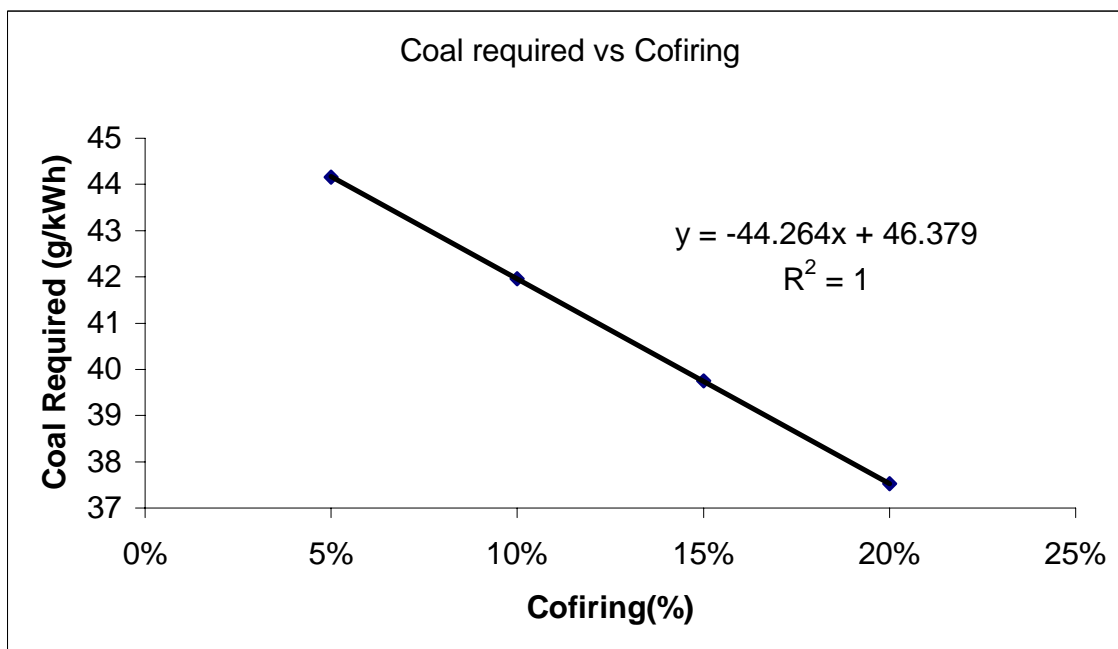
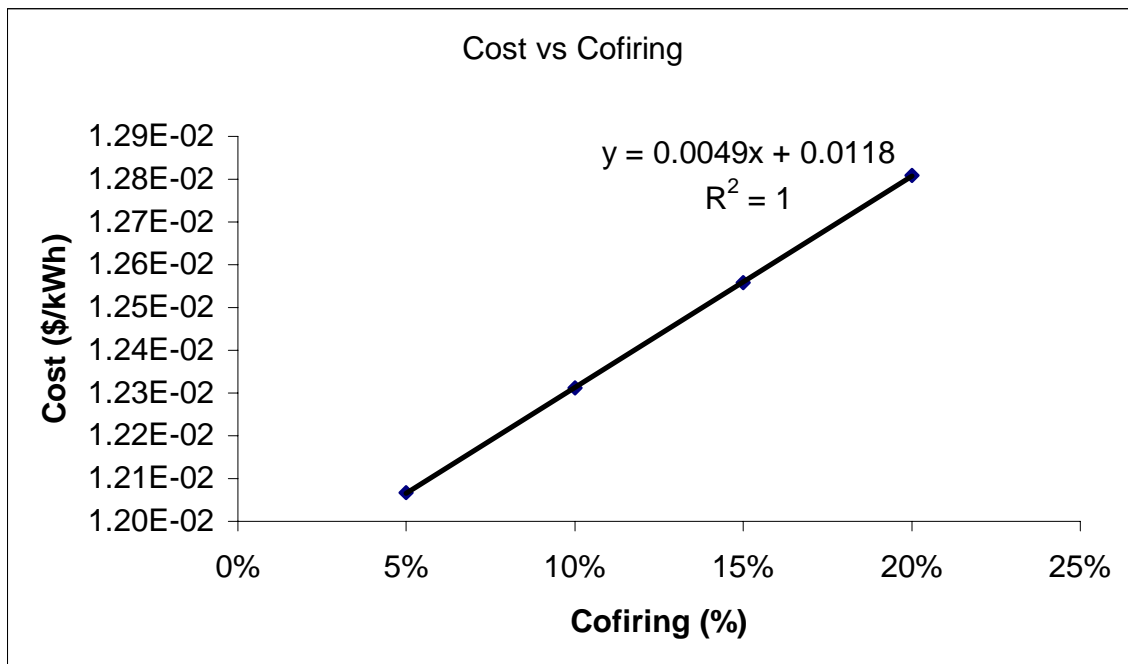
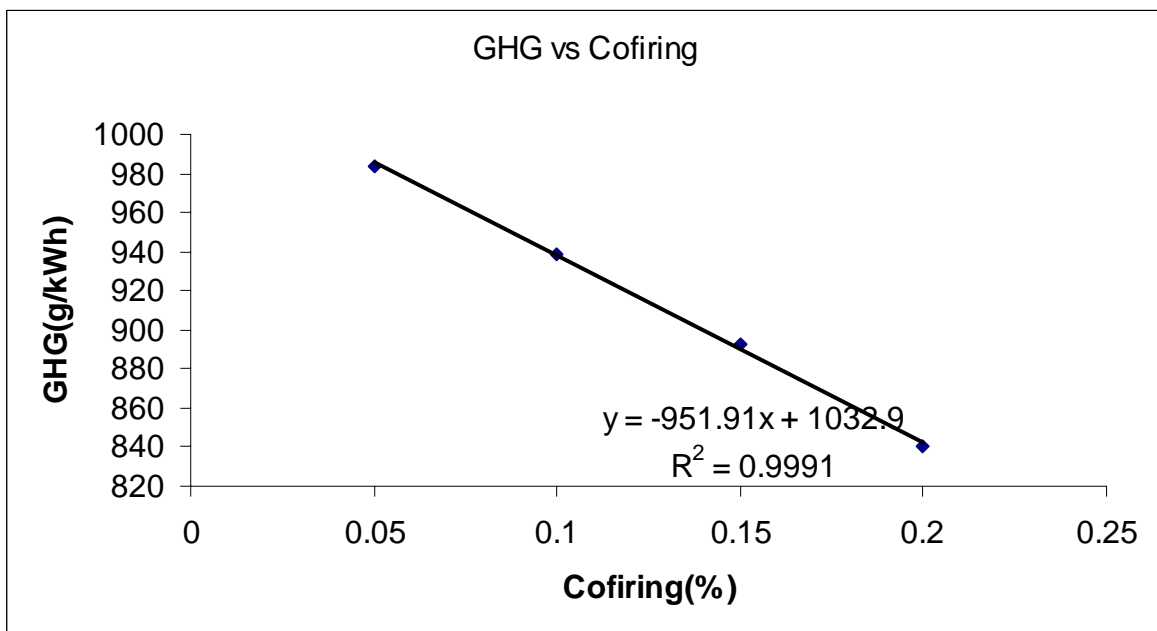


Figure 6.5. Effect of cofiring ratio on coal required.



**Figure 6.6.** Effect of cofiring ratio on electricity production cost.



**Figure 6.7.** Effect of cofiring ratio on GHG emissions generated.

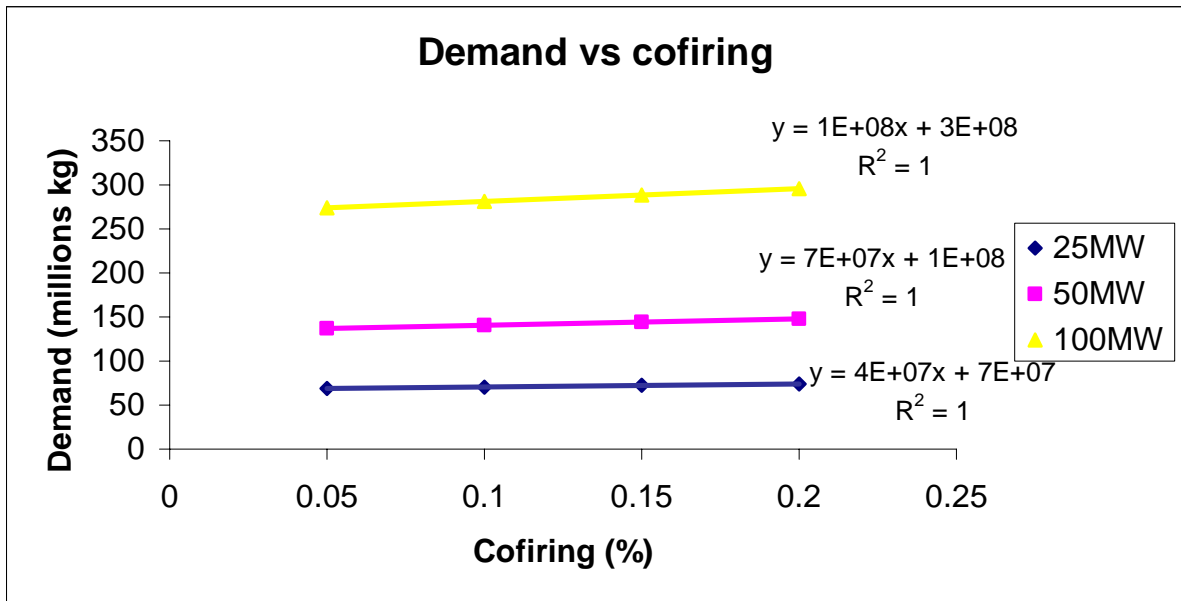


Figure 6.8. Effect of cofiring ratio and plant size on the power demand.

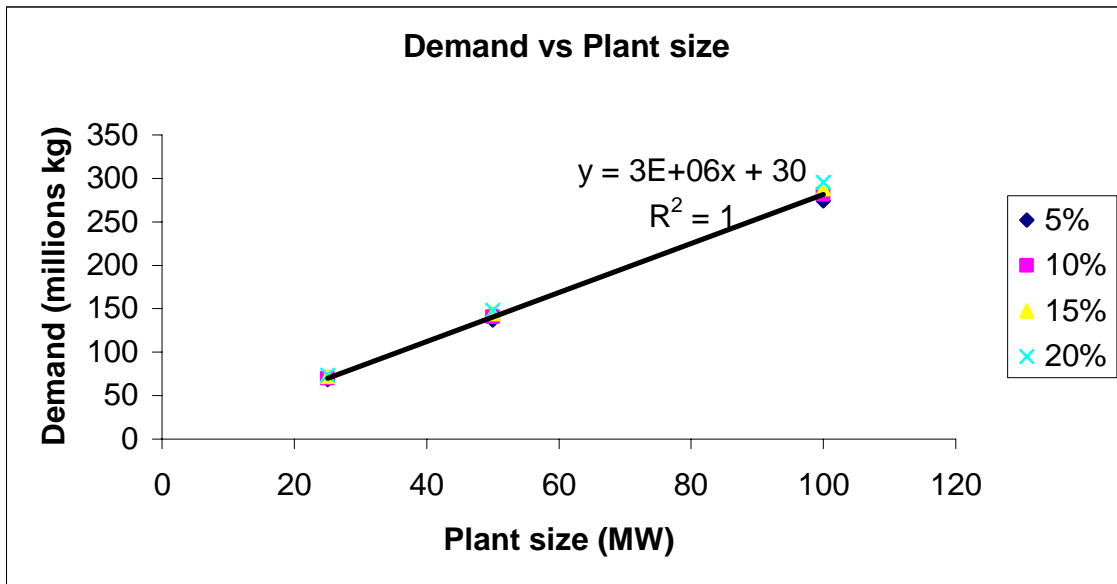
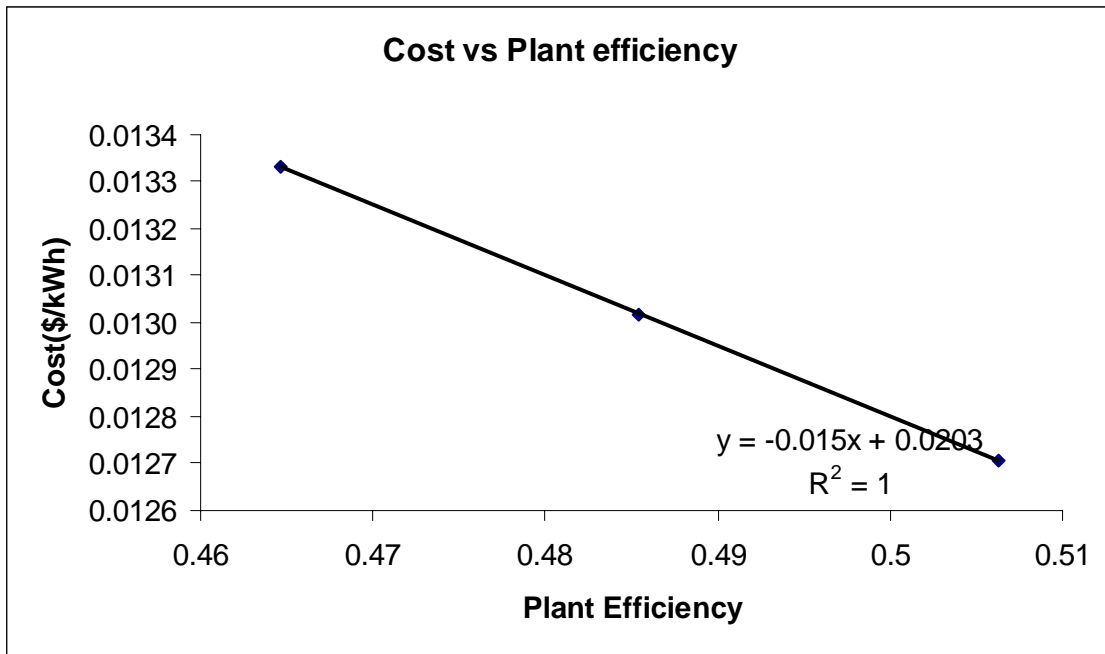


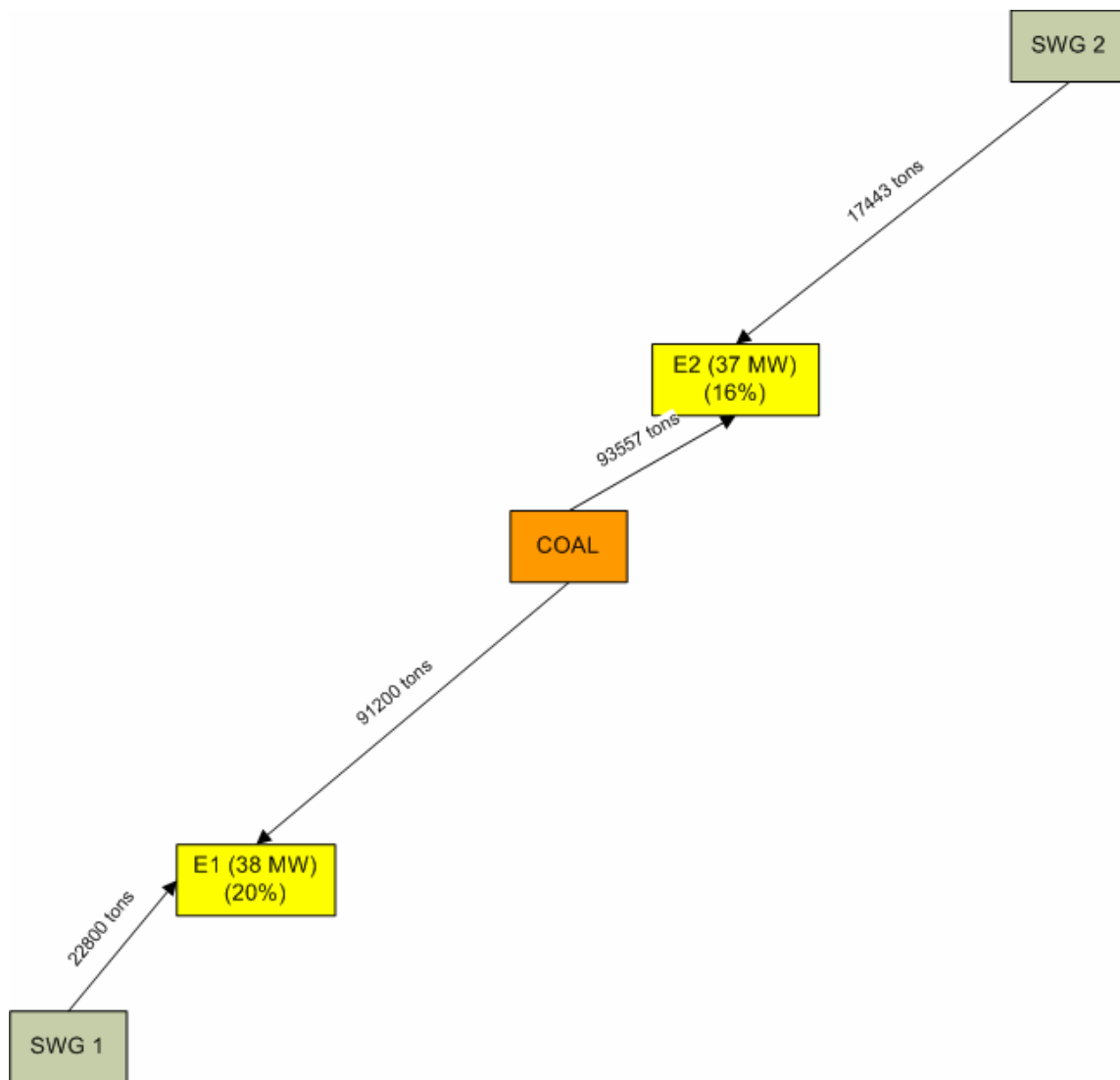
Figure 6.9. Effect of plant size on the power demand.



**Figure 6.10.** Effect of plant efficiency on the electricity production cost.

Mathematical programming technique using software LINGO is used to construct the MINLP model for proper allocation. An illustration of the model along with its solution is shown in Appendices A.3 and A.4. The results for various cases are summarized.

Figure 6.11 and Table 6.1 illustrates the case with two switchgrass farms, one coal mine and two existing plants (no new plant) to meet the total demand of 75 MW. The plant size, cofiring ratio, plant efficiency, electricity production cost and GHG emissions are shown in Table 6.1.

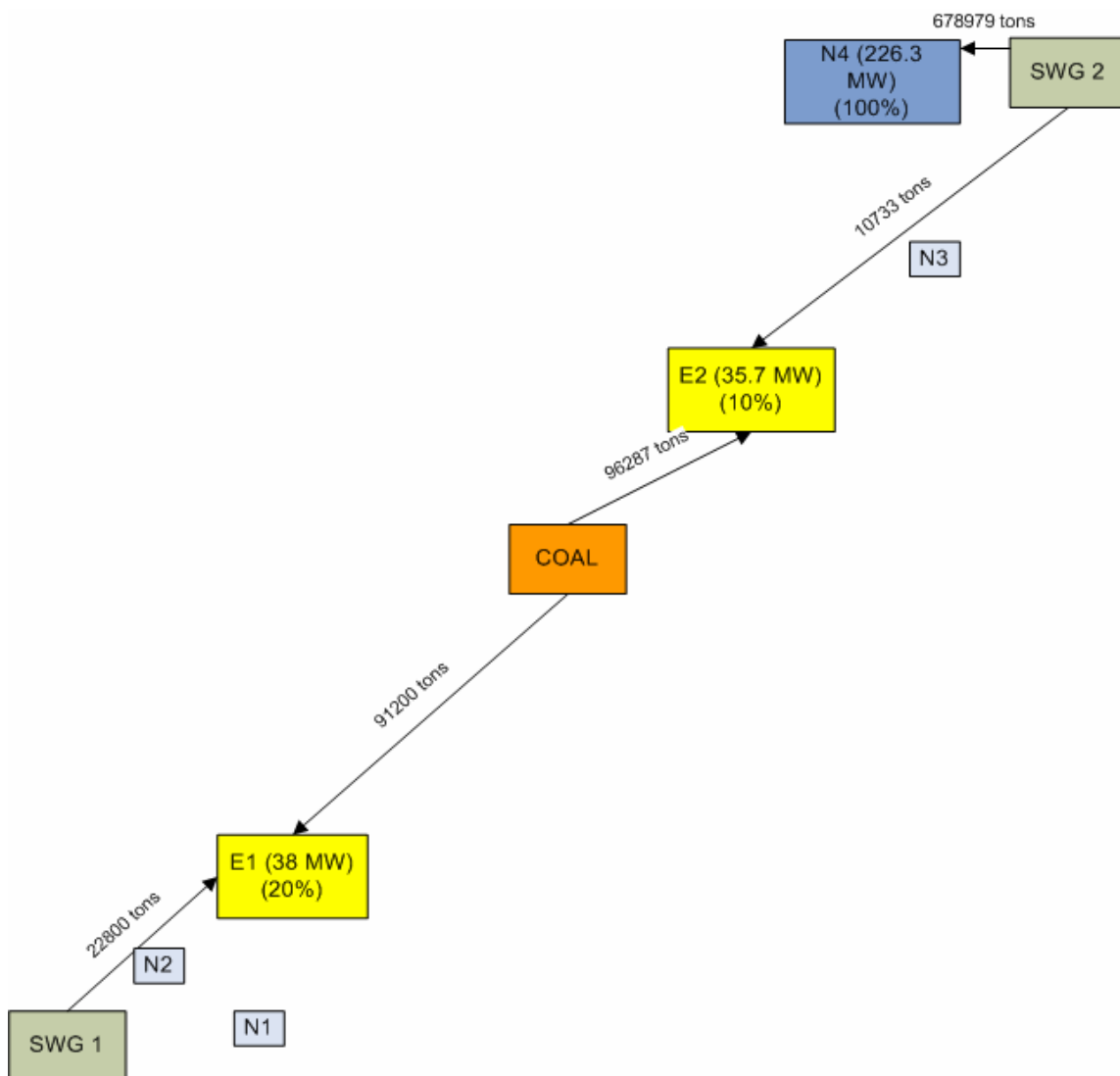


**Figure 6.11.** Allocation scheme for two switchgrass farms and a coal mine to two existing power plants.

**Table 6.1.** Data for two switchgrass and one coal mine sources to two existing plants

Plant	Demand (tons)	Cofiring Ratio	Plant Size(MW)	Plant Efficiency	Electricity Production Cost (c/kWh)	GHG Emissions(g/kWh)
E1	114000	0.2	38	0.477	1.3	842.52
E2	111000	0.16	37	0.476	1.28	883.31

Figure 6.12 and Table 6.2 illustrates the case where a new plant is required to meet the demand. Theoretically, it is possible to scan over the entire domain for the optimum location of the new plant, but for the work in this thesis, the model failed to converge. Thus, to resolve this issue, a certain number of possible new plant locations can be assumed. In this case, four possible locations of new plant are assumed and optimization is made to choose the optimum.



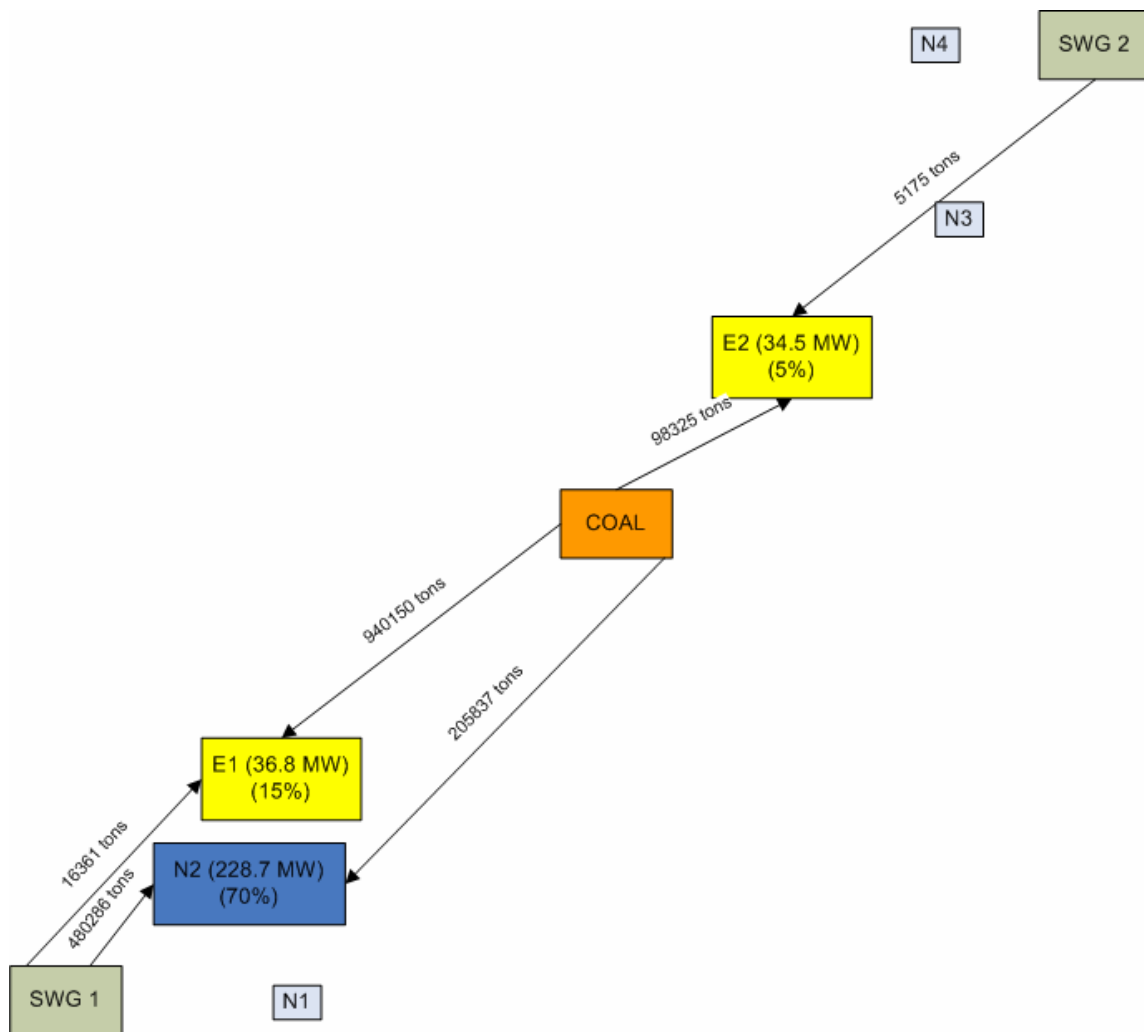
**Figure 6.12.** Allocation scheme for two switchgrass farms and a coal mine to two existing power plants and a new power plant.



**Table 6.2.** Data for two switchgrass and one coal mine sources to new and existing plants

Plant	Demand (tons)	Cofiring Ratio	Plant Size(MW)	Plant Efficiency	Electricity Production Cost (c/kWh)	GHG Emissions(g/kWh)
E1	114000	0.2	38	0.477	1.3	842.52
E2	107020	0.1	35.7	0.475	1.27	937.43
N4	678979	1	226.3	0.531	1.45	80.99

There are infinite locations possible for the new plant by varying the cofiring ratio, plant size, distance and cost. Figure 6.13 and Table 6.3 illustrate an alternative scheme for the case presented above but with a different location by changing the restrictions on the cofiring ratio.

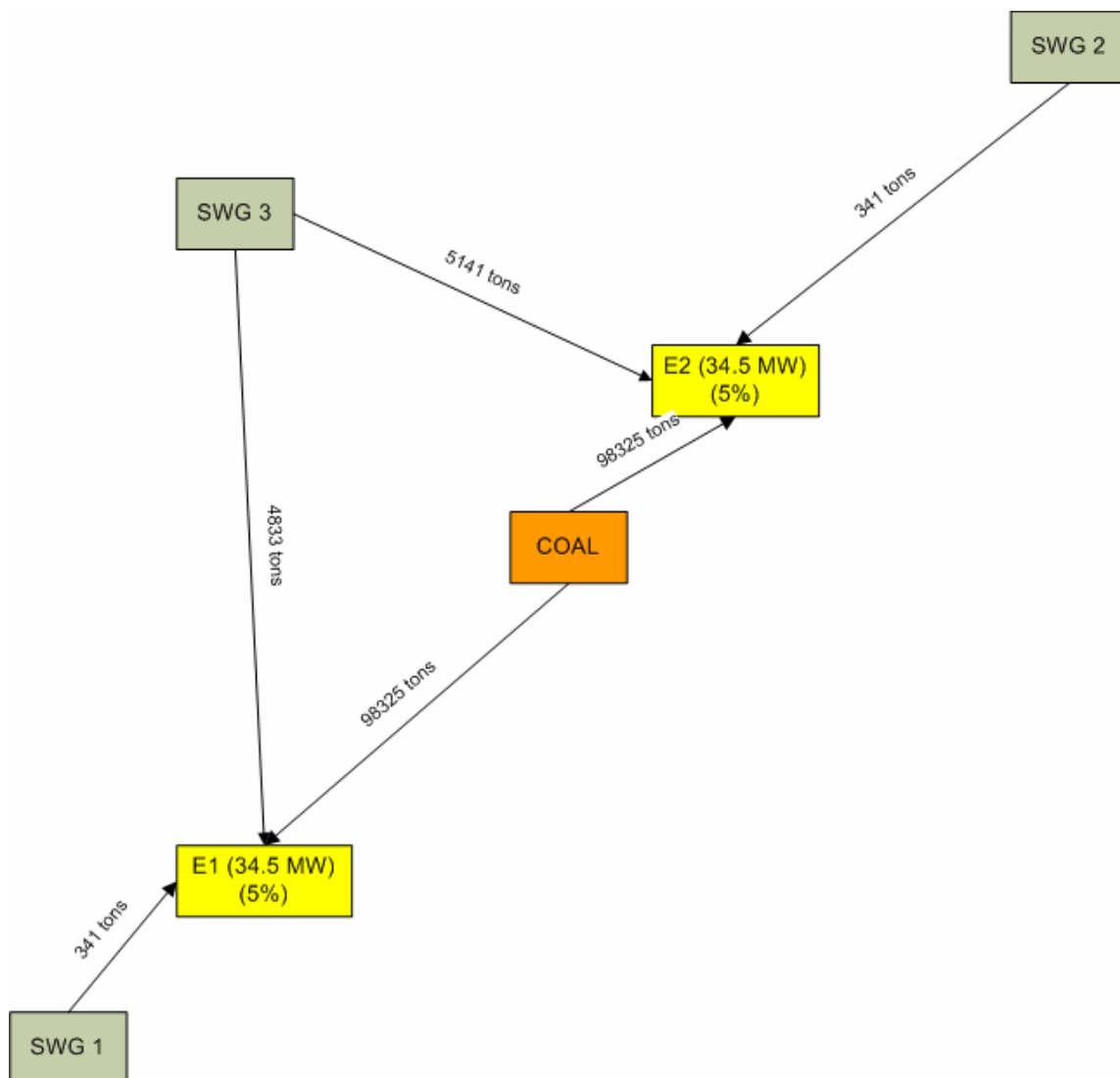


**Figure 6.13.** Alternate allocation scheme for two switchgrass farms and a coal mine to two existing power plants and a new power plant.

**Table 6.3.** Alternative scheme data for two switchgrass and one coal mine sources to new and existing plants

Plant	Demand (tons)	Cofiring Ratio	Plant Size(MW)	Plant Efficiency	Electricity Production Cost (c/kWh)	GHG Emissions(g/kWh)
E1	110376	0.15	36.8	0.476	1.28	891.80
E2	103500	0.05	34.5	0.4743	1.26	985.30
N4	686124	0.7	228.7	0.531	1.38	366.56

The cases shown above essentially make switchgrass go to a single power generation facility. Splitting and mixing between biofuels and fossil fuels to meet the demand of the power generation facilities is shown by another case with three switchgrass farms, one coal mine and two existing power plants, as shown in Figure 6.14 and Table 6.4.



**Figure 6.14.** Allocation scheme for three switchgrass farms and a coal mine to two existing power plants.

**Table 6.4.** Data for three switchgrass and a coal mine sources to existing plants

Plant	Demand (tons)	Cofiring Ratio	Plant Size(MW)	Plant Efficiency	Electricity Production Cost (c/kWh)	GHG Emissions(g/kWh)
E1	103500	0.05	34.5	0.4743	1.26	985.30
E2	103500	0.05	34.5	0.4743	1.26	985.30

### Conclusions

In conclusion, the research presented in this section has illustrated a technique for optimally allocating biomass and fossil fuel sources to power generation facilities to satisfy supply-demand and performance criteria. The analysis indicates that distance, GHG emissions, cost, cofiring ratio and efficiency play an integral part in deciding the routing and allocation schemes. Detailed and in-depth knowledge of the restrictions and functionality among these factors is required, and will affect the sensitivity of the findings.

## VII. BIOMASS IN COGENERATION SYSTEMS\*\*

Besides biomass use in electricity generation, another viable alternative for reducing GHGs is the utilization of biomass in conjunction with combined heat and power (CHP) in the process industries. The purpose of this work is to address the utilization of biowaste or a biomass source in a processing facility for CHP. In particular, the work in this section addresses the following questions:

- How to incorporate biomass in cofiring and energy production within an existing process?
- How to reconcile thermal demands with opportunities for power cogeneration through a process-integration framework?
- What are the economic factors that will insure the feasibility of biomass utilization and power cogeneration?
- What is the impact on GHG emissions and what are the necessary GHG offsets subsidies/emission prices?

It is of paramount importance to mitigate the greenhouse gas emissions. However, at current prices biomass can not compete with fossil fuel for combined heat and power or power generation without any emission price. A major opportunity for cost reduction and efficiency improvement in the process industries is associated with combined heat and power (CHP). The key idea of CHP lies in capturing the power generation potential available through pressure reduction in steam systems. This is often referred to as “cogeneration.” This potential can be realized through steam turbines which either generate electric power or produce shaft work through direct coupling with pumps or compressors.

---

\*\*Reprinted with permission from “An Algebraic Targeting Approach for Effective Utilization of Biomass in Cogeneration Systems through Process Integration” by Mohan, T. and El-Halwagi, M.M., *Chemical Engineering Communications*, in press.

Traditionally, CHP has been accomplished using fossil fuels. Nonetheless, it is desirable to consider the utilization of biomass for partial or total cogeneration. The viability of biomass utilization in cogeneration stems for its relation compared to fossil fuels and to its positive impact in reducing GHGs from a life-cycle perspective. At present, landfilling, composting, illegal dumping, recycling and incineration are popular ways to deal with biowaste, but most of these cause negative environmental effects like use of valuable land and generation of dangerous gases (Van Wyk, 2001).

Biowaste can be effectively utilized for combined heat and power where it replaces fossil fuels for production of clean energy through combustion. This waste to energy conversion process is safe and environment friendly. The ash generated can be used for roadbed material, as a landfill or in the cement industry. This technique reduces carbon dioxide due to carbon recycling. Burning biomass offers the potential to reduce emissions as biomass has virtually no sulfur (often less than 1/100<sup>th</sup> of that in coal), low nitrogen (less than 1/5<sup>th</sup> of that in coal), no mercury, and low-ash content (Hughes, 2000). The heat costs from cogeneration with biowaste and biomass are currently higher than the costs from fossil fuel. As discussed in the literature review (Section III), numerous methods have been used for assessing the cogeneration capabilities of a process, and a lot of work has been conducted in the area of biomass cogeneration. It has been found that at present, the costs from cogeneration are higher when using biomass than when using fossil fuels, but when environmental factors and emission prices are taken into consideration, biomass can compete with fossil fuels.

In spite of the usefulness of the previous work on targeting cogeneration potential and analyzing biomass cogeneration, none of the methods discusses the potential of biomass and biowaste sources as an external fuel for the process plant which would offer a renewable, green, clean and sustainable option to meet the process needs.

In a process, there exist headers at various levels in which the steam could be generated due to processes operations such as exothermic reactions, flash processes; and also by external fuel. This work analyses the interactions of mass, heat and power issues concerning biomass CHP by introducing an algebraic method for targeting cogeneration

potential and using biomass as an option for complete or partial substitution of fossil fuel for external fuel demand. This work also examines how potential GHG emission pricing alternatives might influence the relative efficiencies of alternative technologies as well as the market penetration of biomass.

### **Problem Statement**

Consider a process with:

- A set of specific heating and cooling demands
- Steam demands for non-heating purposes such as tracing, blanketing, stripping, injection, etc.
- A certain requirement of electric power
- A header system with steam generated by process operations and external fuel

The objective is to target for power cogeneration that effectively uses process sources and external biomass and biowaste streams while satisfying the process heating and non-heating steam demands, and to determine the GHG pricing options required to compete with fossil fuel cogeneration or electricity bought from external sources.

### *Design Challenges*

In order to meet the abovementioned objectives, the following important complex, interactive and combinatorial design challenges need to be addressed:

- What are the minimum heating and cooling utilities?
- What are the steam header levels at which surplus and deficit exist?
- How much energy may be extracted from the biomass and biowaste streams?
- What is the minimum thermal requirement of the system?
- At what pressure level should the thermal requirement be used?
- At what pressure level should steam from the external fuel be generated?
- What cofiring ratio should be used for external fuel steam generation?

- What is the benchmark for maximum cogeneration potential by utilization of biomass and biowaste streams and minimum usage of external thermal utilities?

The following section provides a systematic approach and specific tools to aid in answering these questions and providing insights into the viability and policy options required for biomass CHP projects.

### **Methodology**

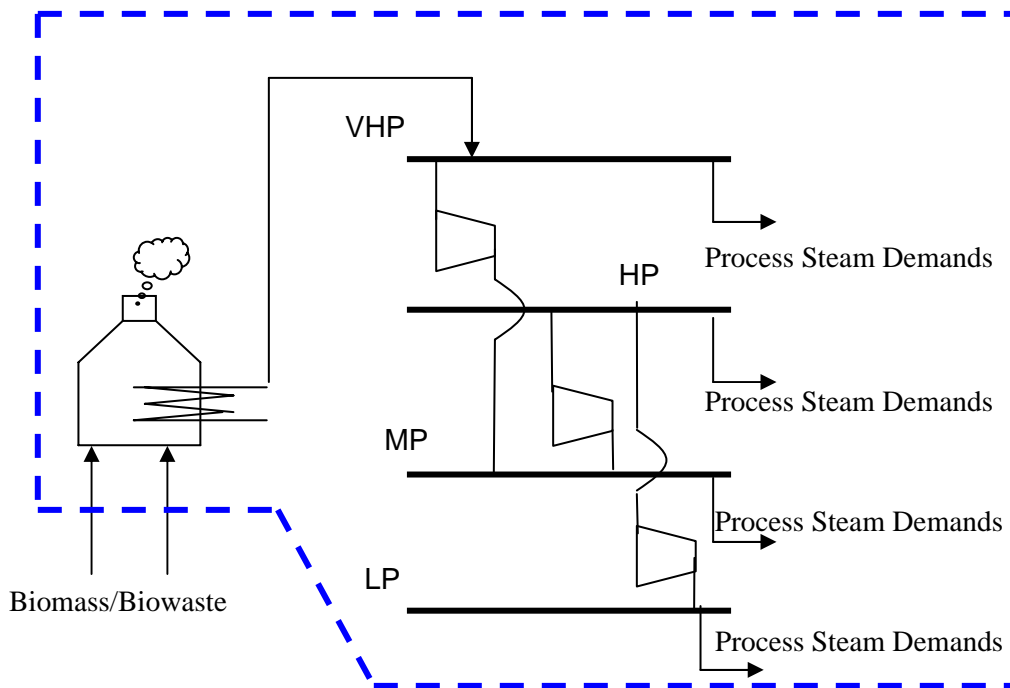
In a plant, steam would be generated by various processes such as hot processes that require cooling and generate steam, or processes that generate steam as a byproduct of a reaction. Additionally, steam is required for heating requirements as well as other uses such as steam blanketing, steam injecting, etc. On the other hand, several processes generate biowaste. At present, biowaste streams are dealt with in various ways such as landfilling, composting, recycling and illegal dumping. Landfills pose serious health risks as they generate green house gases such as methane, carbon dioxide, hydrogen, oxygen and nitrogen. Composting, although producing an excellent soil conditioner poses a problem due to some chemicals and pesticides present in biomass and biowaste streams which would make compost undesirable. Incineration destroys the resources for recycling and composting of biomass. So, the sensitive issue of use of biomass and biowaste streams as an external fuel for process steam demands needs to be tackled by a systematic approach.

#### *Steam Header System*

From the process data, mass and heat integration analysis is performed. Using the material and thermal integration studies, the total demand of steam for thermal, mass and other requirements are determined, which are used to generate the steam header balance of the system. Further, a balance around each steam header, such as VHP (very high pressure), HP (high pressure), MP (medium pressure) and LP (low pressure) is performed to know the surplus and deficit at each level. For each steam header level the



temperature and pressure are known, which is used to calculate the specific enthalpy of each header level. Figure 7.1 illustrates the header system with external fuel demand being met with biomass and biowaste streams burned in the boiler.



**Figure 7.1.** Biomass and biowaste use for cogeneration to meet steam demands.

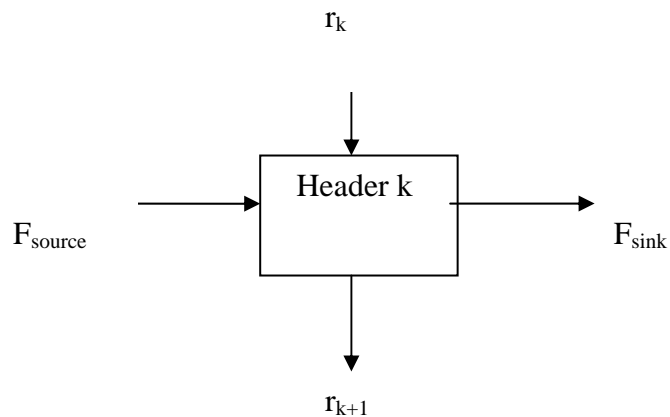
*Excess Steam and External Fuel Demand by Flow Balance*

From the header balance, the surplus and deficit flows at each header level are known. Using this data, a flow balance is performed at each header level to obtain the excess steam and the external fuel demand. A cascade diagram is utilized in this analysis for the purpose of conducting a flow balance. In a process, a typical header system will consist of headers at known pressure and temperatures, which can be arranged in cascade form according to decreasing pressure as steam can only be feasibly let down from a higher pressure to any lower pressure. Further, from header balance the surplus and deficit flows from each level are known.

At any header  $k$ , flow balance is performed. For this the sum of flow going into the header as  $F_{\text{source}}$ , which could be from steam generated by process operations or from external fuel, and  $r_k$ , which is the residual flow from the header above, is obtained. The flow going out of the header as  $F_{\text{sink}}$  is then subtracted from the sum of incoming flows to get the residual flowing down from the header  $k$ , i.e. for any header  $k$ :

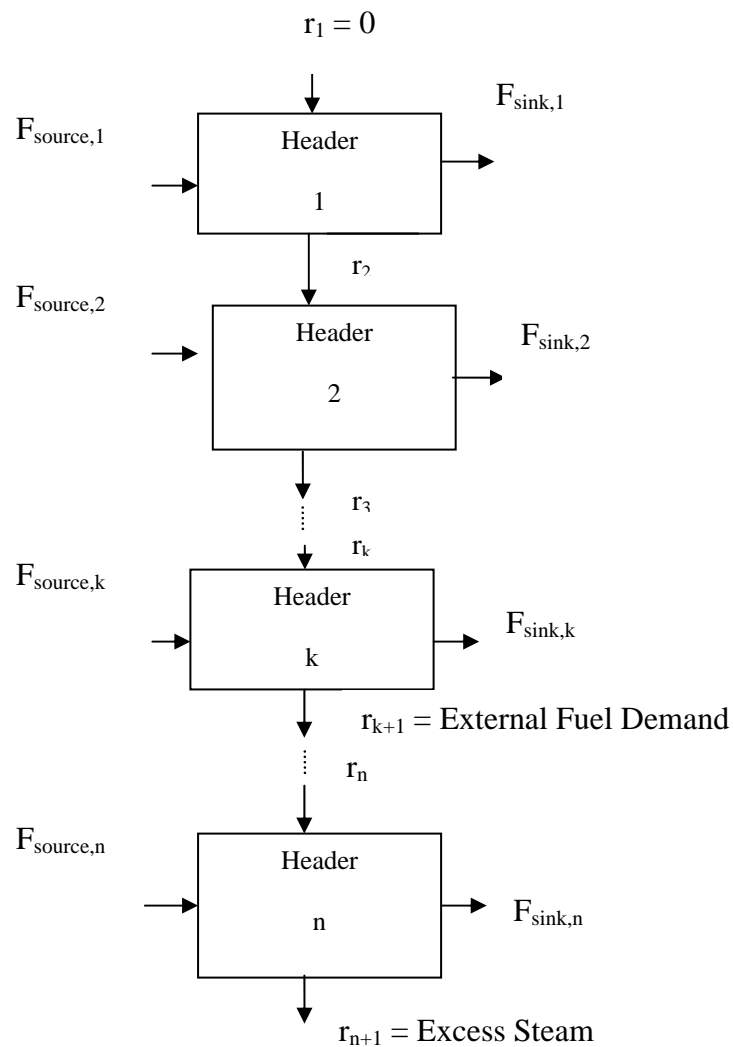
$$r_{k+1} = F_{\text{source}} + r_k - F_{\text{sink}} \quad (7.1)$$

This can be illustrated schematically by Figure 7.2.



**Figure 7.2.** Flow balance around a header interval.

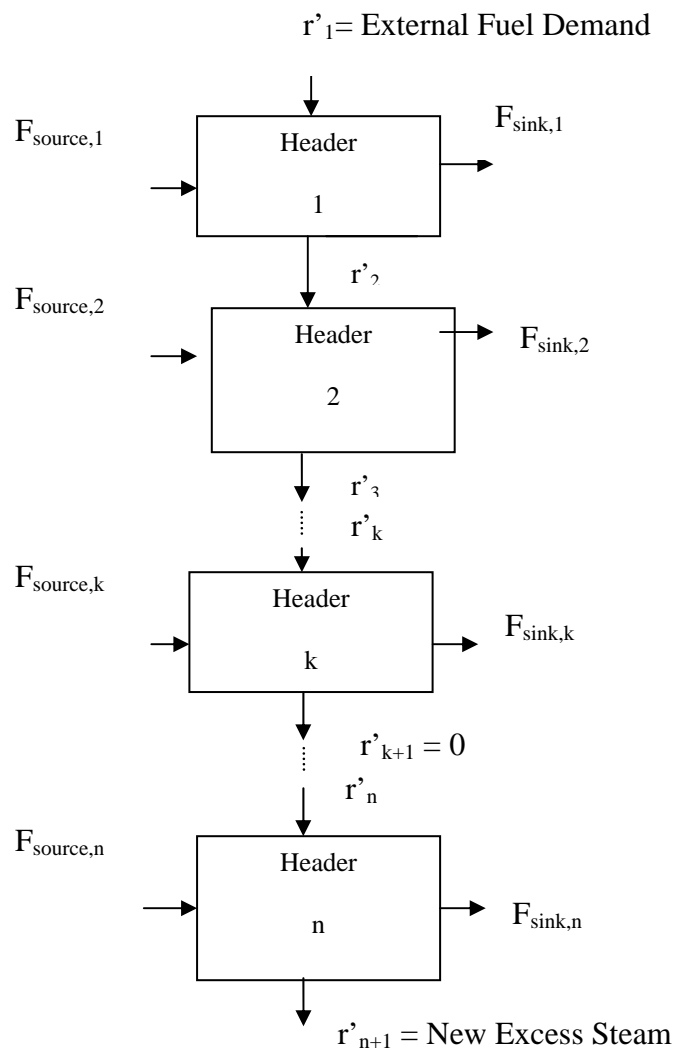
The flow balances for all headers can be carried out to generate the cascade diagram shown on Figure 7.3.



**Figure 7.3.** Cascade diagram for cogeneration potential.

From the cascade diagram shown in Figure 7.3, the external fuel demand is obtained as the most negative residual. Next, it is decided on the temperature and

pressure at which the steam from external fuel is generated. The steam from external fuel can be generated at any level above the maximum deficit header. For the purpose of flow balance, we can assume that steam from external fuel is generated at the highest header level. Following this, cascade diagram is revised by providing for the external and thus, the new excess steam is obtained as shown in Figure 7.4.



**Figure 7.4.** Revised cascade diagram for cogeneration potential.

The new excess steam is now removed from the lowest pressure surplus header. Next, using the revised cascade diagram and flow after removing excess steam, the net flows from each header level are computed

*Extractable Energy as a Basis for Targeting Cogeneration Potential*

The traditional technique for determining cogeneration potential is via Mollier diagram. However, the Mollier diagram is cumbersome because it requires the determination of the isentropic enthalpy of the turbine at the outlet pressure. A more convenient approach developed by Harell (2004) for determining the cogeneration potential of a turbine utilizes the actual outlet temperature and pressure of the turbine. Because turbines are placed in steam systems between headers, the inlet and outlet temperature and pressures are known. Therefore, the extractable power concept is based off of the header level that the turbine is being outlet to, rather than the isentropic conditions at the outlet pressure. The difference between the traditional approach and the approach developed by Harell and El-Halwagi (2003) is discussed in Literature Review (Figure 3.4).

The enthalpy difference between turbine inlet and outlet is:

$$\Delta H^{header} = H^{in} - H_{header}^{out} \quad (7.2)$$

where  $\Delta H^{header}$  is the specific enthalpy difference between the turbine inlet and outlet header and  $H_{header}^{out}$  is the enthalpy at the header outlet temperature and pressure. An efficiency term ( $\eta_{header}$ ) is incorporated to relate the header difference to the actual enthalpy difference that occurs:

$$\eta_{header} = \frac{\Delta H^{real}}{\Delta H^{header}} \quad (7.3)$$

The specific power produced by a turbine is given by:

$$w = \Delta H^{real} = \eta_{header} (H^{in} - H_{header}^{out}) \quad (7.4)$$

The actual power generated from the turbine is then determined by multiplying the specific power by the mass flow rate of steam passing through the turbine:

$$W = \dot{m} \eta_{header} (H^{in} - H_{header}^{out}) \quad (7.5)$$

The concept of extractable energy is:

$$e = \eta H \quad (7.6)$$

where  $e$  is the extractable energy,  $\eta$  is an efficiency term and  $H$  is the specific enthalpy at a given set of conditions. Then, the power generation expression can be rewritten as:

$$W = \dot{m} (e^{in} - e_{header}^{out}) \quad (7.7)$$

The power generated by the turbine takes a convenient form as the difference between the inlet and outlet extractable power:

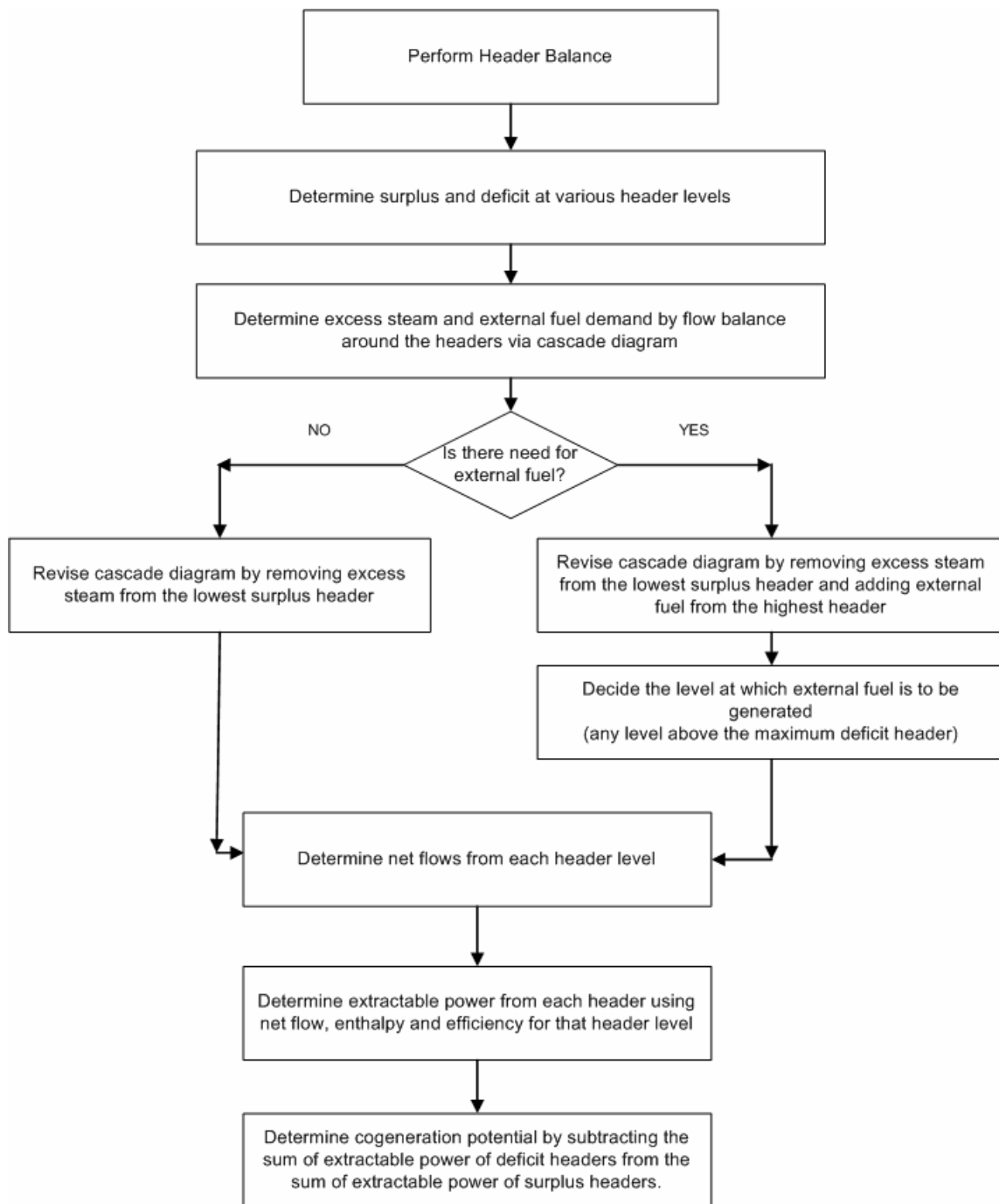
$$W = E^{in} - E_{header}^{out} \quad (7.8)$$

where  $E$  is defined as the extractable power at a given header condition.

Knowing the net flows from the flow balance, the enthalpy at each header level and efficiency term, the extractable power for each header level is computed. Further, from the header balance, the surplus and deficit are known. The cogeneration potential can now be easily determined from the difference between the sum of extractable power of the surplus headers and the sum of extractable power of the deficit headers. This is shown by the extractable power header interval diagram shown in Table 7.1.

**Table 7.1.** Extractable power header interval diagram

	Net Flow(lb/h)	Extractable Power (MMBtu/h)
Header 1	F1	E1
Header 2	F2	E2
Header k	F <sub>k</sub>	E <sub>k</sub>
Header n	F <sub>n</sub>	E <sub>n</sub>
<b>Cogeneration Potential</b>		$\sum E_{surplus} - \sum E_{deficits}$



**Figure 7.5.** Methodology for algebraic approach to target cogeneration potential and minimum bio fuel requirement.

Figure 7.5 shows the summarized methodology for implementing the algebraic method to target cogeneration potential and excess steam, and determine the minimum requirement of biomass and biowaste streams that can be used as external fuel for cogeneration.

Next, two case studies will be presented to illustrate the developed approach for cases with and without external fuel requirement.

### Case Study 1: No External Biofuel Requirement

In this case study two hot streams and two cold streams are being considered. The process is assumed to already have steam header system with the following four header levels: VHP (very high pressure), HP (high pressure), MP (medium pressure) and LP (low pressure). Further, it is assumed that the system is optimized by mass and heat integration techniques. Header balance is carried out, and it is found that VHP and HP are surplus and MP and LP are deficit. Tables 7.2 and 7.3 can be constructed for the surplus and deficit streams.

**Table 7.2.** Surplus data for case study 1

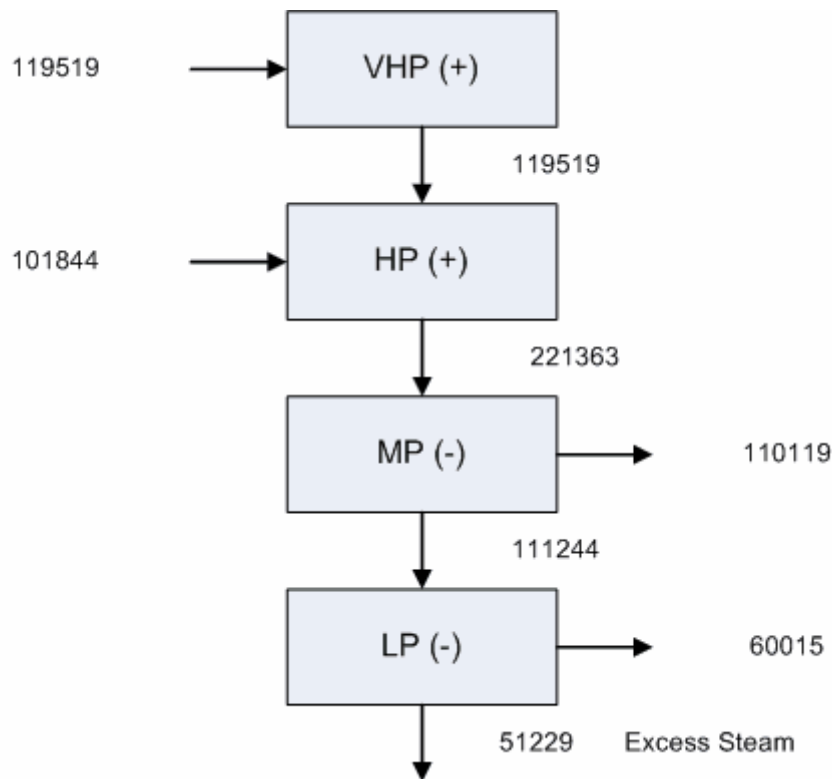
Pressure	Flow F, lb/h	Cumulative Flow, lb/h	Specific Enthalpy, Btu/lb	Extractable energy, Btu/lb	Extractable power, MM Btu/h
VHP	119519	119519	1356.31	949.41	113.47
HP	101844	221363	1305.60	913.92	93.077



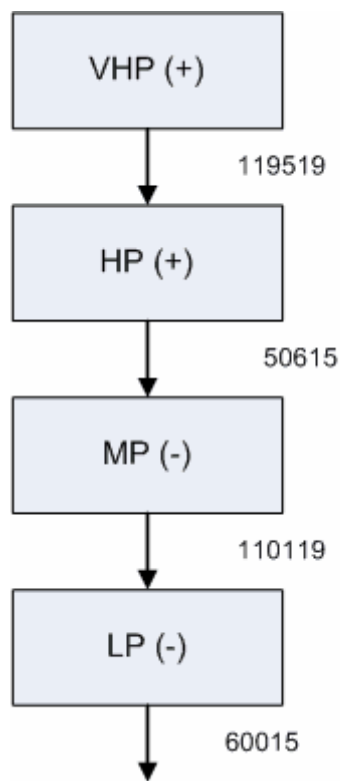
**Table 7.3.** Deficit data for case study 1

Pressure	Flow F, lb/h	Cumulative Flow, lb/h	Specific Enthalpy, Btu/lb	Extractable energy, Btu/lb	Extractable power, MM Btu/h
MP	110119	110119	1224.94	857.46	94.42
LP	60015	170134	1180.82	826.57	49.61

Here, the surplus streams are higher pressures than the deficit streams. Flow balance is carried out over the header system using the cascade diagram approach to determine the excess steam and external fuel demand (Figure 7.6).

**Figure 7.6.** Cascade diagram for case study 1 (surplus is denoted by (+) and deficit by (-)).

As seen from Figure 7.6, no external fuel is required for this case; and all the surplus steam from higher pressure headers can effectively be utilized to meet the process demands. Next, the excess steam is removed from the lowest pressure surplus header and the cascade diagram is revised to obtain the net flows, as shown in Figure 7.7.



**Figure 7.7.** Revised flow balance cascade diagram for case study 1.

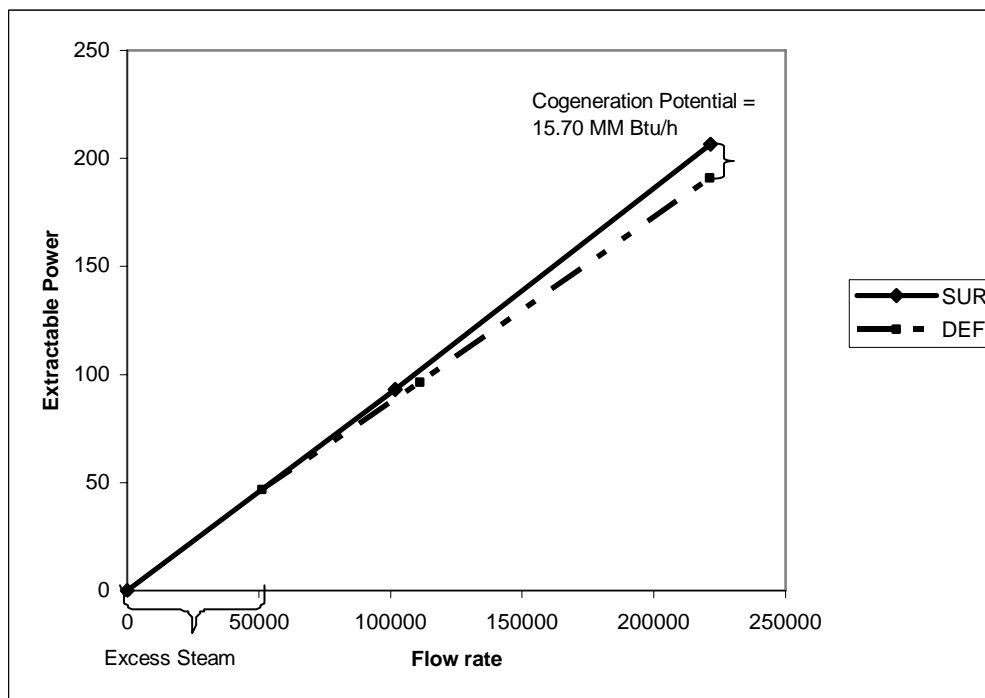
Using the temperature and pressure from header balance, the enthalpy at each header level can be computed. From the enthalpy and efficiency factor of  $\eta = 0.7$ , the extractable energy is calculated. Now, the net flows and extractable energy at each

header level are known, which is used to determine the extractable power for each level. After this, the cogeneration potential is determined by subtracting the sum of extractable power of surplus streams from that of the deficits, as shown in the extractable power header interval diagram (Table 7.4).

**Table 7.4.** Extractable power header interval diagram for case study 1

	Net Flow(lb/h)	Enthalpy (Btu/lb)	Extractable energy(Btu/lb)	Extractable power (MMBtu/h)
VHP(+)	119519.00	1356.31	949.42	113.47
HP(+)	50615.00	1305.60	913.92	46.26
MP(-)	110119.00	1224.94	857.46	94.42
LP(-)	60015.00	1180.82	826.57	49.61
<b>Cogeneration Potential</b>			<b>15.70</b>	

Therefore, 15.70 MM Btu/h is the target for cogeneration potential. The excess steam and the external fuel demand can also be determined by this method as shown in the flow balance via cascade diagrams. The excess steam in this case was 51229 lb/h and no external fuel was required. The excess steam can be let down via a condensing turbine to produce additional power, or the excess steam generation can be reduced. The results obtained by the developed algebraic targeting approach are validated with the graphical technique developed by Harell and El-Halwagi (2003) and are found to be consistent as shown in Figure 7.8.



**Figure 7.8.** Validation of cogeneration potential by graphical technique.

### Case Study 2: External Biofuel Requirement

In this case, the header balance shows that VHP and MP are surplus and HP and LP are deficit. Tables for the surplus and deficit (Tables 7.5 and 7.6) can be constructed as before for both surplus and deficit streams.

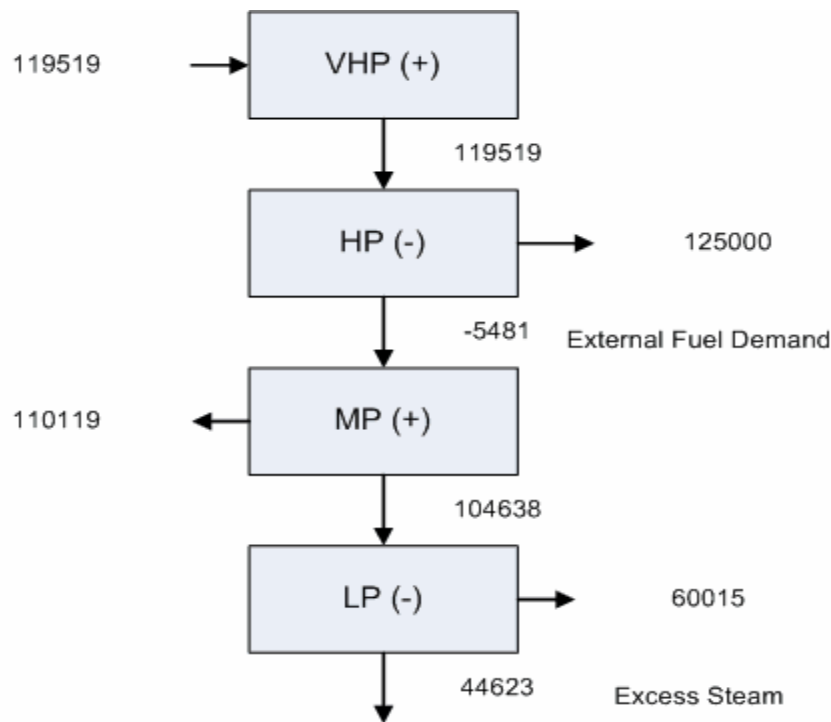
**Table 7.5.** Surplus data for case study 2

Pressure	Flow F, lb/h	Cumulative Flow, lb/h	Specific Enthalpy, Btu/lb	Extractable energy, Btu/lb	Extractable power, MM Btu/h
VHP	119519	119519	1356.31	949.41	113.47
MP	110119	229638	1224.94	857.46	94.42

**Table 7.6.** Deficit data for case study 2

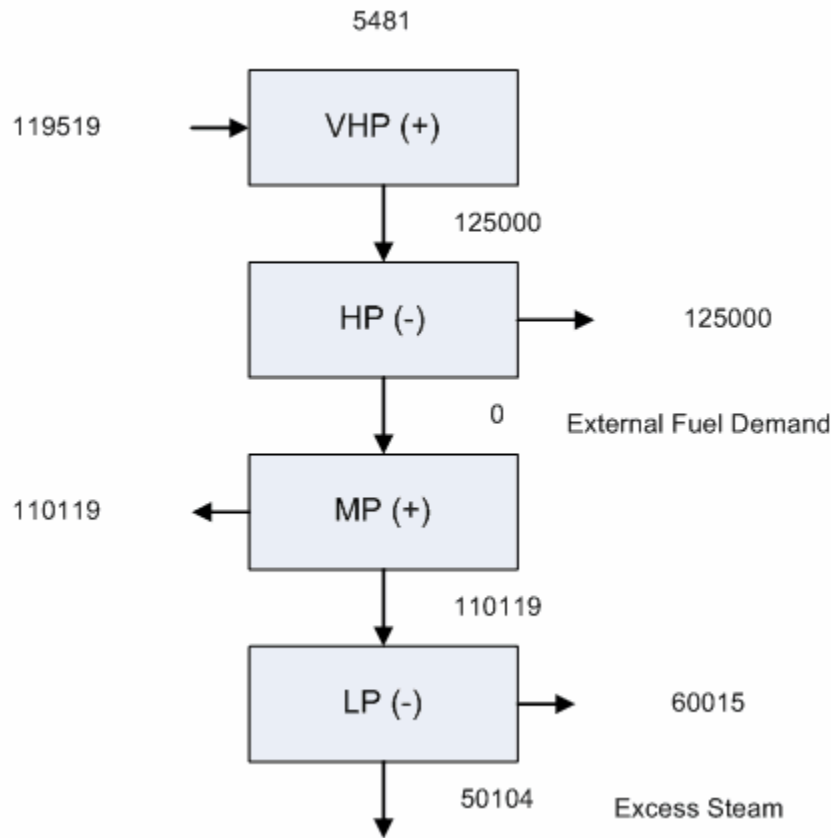
Pressure	Flow F, lb/h	Cumulative Flow, lb/h	Specific Enthalpy, Btu/lb	Extractable energy, Btu/lb	Extractable power, MM Btu/h
HP	125000	125000	1305.60	913.92	114.24
LP	60015	185015	1180.82	826.57	49.61

Following this, flow balance is performed to obtain the external fuel requirement and the excess steam (Figure 7.9).



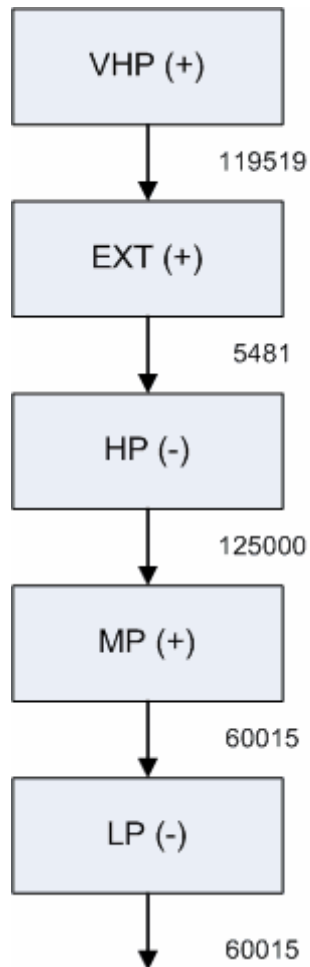
**Figure 7.9.** Flow balance cascade diagram for case study 2.

Next, the need for external fuel demand is satisfied by adding it from any header level above the maximum pressure deficit. For the purpose of flow balance, the external is added from the highest level, and the flow balance cascade diagram is revised to obtain the new excess steam (Figure 7.10).



**Figure 7.10.** Revised flow balance cascade diagram for case study 2.

The temperature and pressure of the external requirement are decided, which fixes its header level. The external can be generated at any level above the maximum pressure deficit, HP in this case; i.e. it can be generated at a level between HP and VHP, at VHP or any pressure above VHP depending on the economic analysis. For this case it is assumed that external is at a level between the VHP and HP, which would be most cost effective. The external is generated at 250psia and 700F, which implies an enthalpy of 1340 Btu/lb. The excess steam is removed from the lowest pressure surplus header, MP in this case. Next, the net flows can be obtained from the header system as shown in Figure 7.11.



**Figure 7.11.** Net flows for case study 2.

Similar to case study 1, using the net flows and extractable energy at each header level the extractable power for each level is determined. After this, the cogeneration potential is determined by subtracting the sum of extractable power of surplus, i.e. VHP, EXT and MP, from that of the deficits, i.e. HP and LP, as shown in the extractable power header interval diagram (Table 7.7).



**Table 7.7.** Extractable power header interval diagram for case study 2

	Net Flow(lb/h)	Enthalpy (Btu/lb)	Extractable energy(Btu/lb)	Extractable power (MMBtu/h)
VHP(+)	119519	1356.31	949.42	113.47
EXT(+)	5481	1340	938.01	5.14
HP(-)	125000	1305.60	913.92	114.24
MP(+)	60015	1224.94	857.46	51.46
LP(-)	60015	1180.82	826.57	49.61
<b>Cogeneration Potential</b>			<b>6.23</b>	

Hence, the developed algebraic approach effectively determines the target for cogeneration potential as 6.23 MMBtu/h, the excess steam in the system as 50104 lb/h and the external requirement as 5481 lb/h. Now, the external requirement of 5481 lb/h can either be satisfied by using the conventional technique of burning fossil fuels or by burning biomass and biowaste. Burning biomass and biowaste offers the significant advantage of reducing GHG emissions through net carbon recycling. Additionally, biomass can be cofired with coal, which would reduce emissions but at the same time does not increase the costs enormously. Assuming switchgrass as the biomass used with a preparation cost of \$35/ton, and for the required external demand of 5481 lb/h, the thermal energy required is computed as 47 MMBtu/h. Using this together with the environmental, economic, agricultural and performance factors, the optimum cofiring ratio, GHG emissions and electricity production cost can be found by a life cycle environmental biocomplexity MINLP formulation. For the data in this case study, the optimum cofiring ratio is found to be 20%, which results in electricity production cost of 1.34 cents/kWh (versus 1.18 cents/kWh for coal alone) and GHG emissions of 842.52 g/kWh CO<sub>2</sub>-Eq (versus 997.5 g/kWh CO<sub>2</sub>-Eq for coal alone).

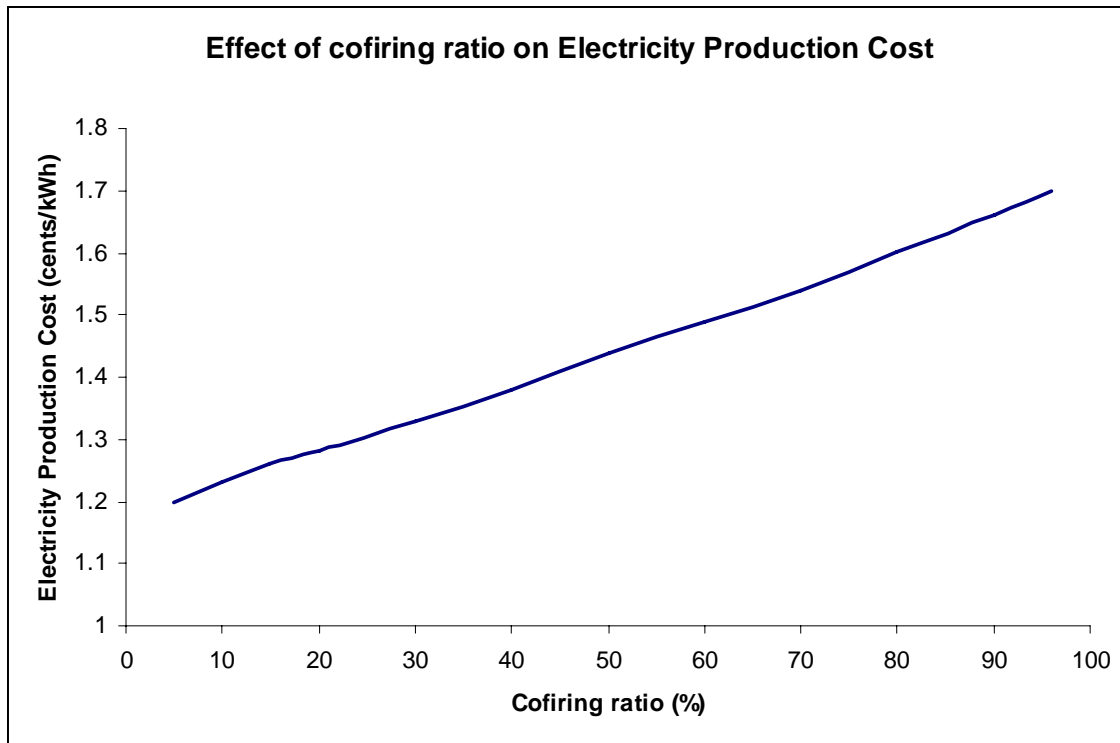
### **Biomass CHP: GHG Effects and Emission Pricing**

Having presented the algebraic approach for targeting cogeneration potential, it is important to analyze the issues for biomass as a fuel for cogeneration. In the present case, we have discussed the scenario when biomass and biowaste are utilized for the purpose of providing for external fuel requirement either as the sole fuel or as a cofired mixture with coal. For the purpose of this analysis, switchgrass with a preparation cost of \$35/tonne, and coal at a cost of \$28/tonne are assumed as the fuel under consideration to meet the external requirement of cogeneration systems.

Biomass can only compete with fossil fuels, for electricity generation or cogeneration, if other advantages such as environmental benefits are considered by examining their effect on GHG pricing options. The reduction of GHG emissions per amount of biomass or biowaste and the cost per unit of reduced GHG can be taken as a criterion for allocating the use of biomass. Cogeneration is the most energy efficient method for converting biomass into heat and electricity with nearly commercial technologies (Gustavsson and Johansson, 1994). There is a vast potential for biomass and biowaste fired small scale CHP units in comparison to large scale biomass power generation, as it is more economical, efficient and environment friendly.

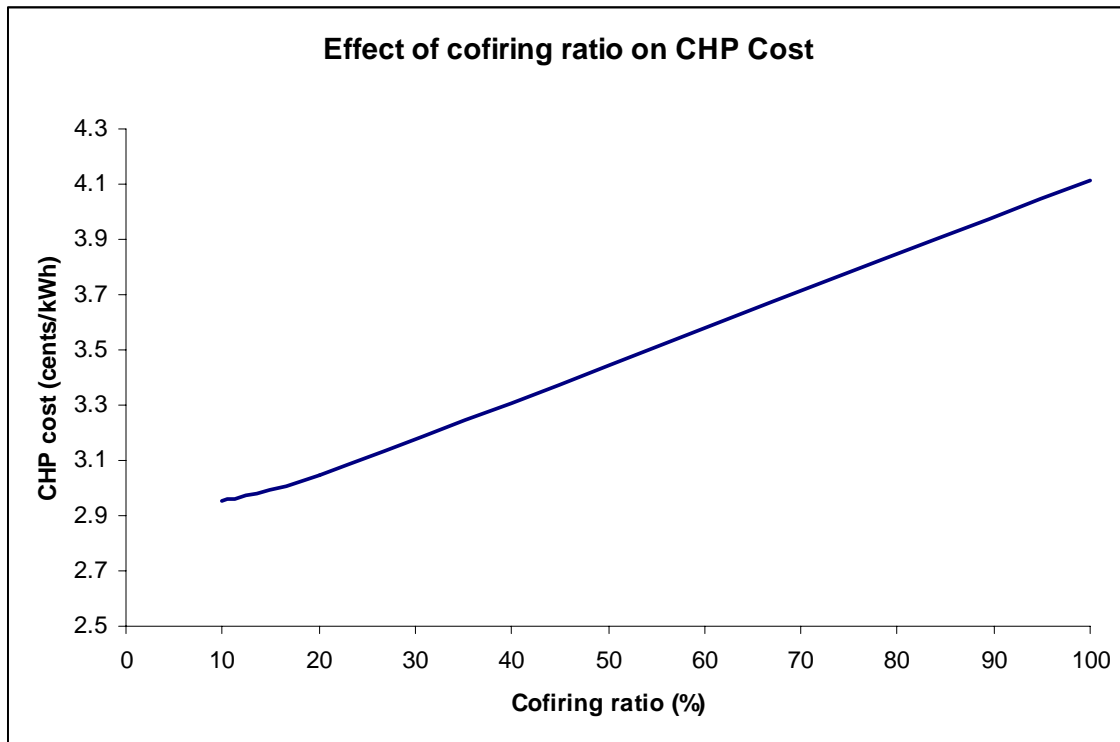
Consider a base case where coal is used for electricity generation, the optimum electricity production cost is 1.18 cents/kWh with GHG emissions of 997.5 g/kWh. With increasing use of biomass, the cost increases and the emissions decrease due to carbon recycling of biomass. Traditionally, biomass that has been considered for cofiring include wood waste, short rotation woody crops, short rotation herbaceous crops (e.g., switchgrass), manure, landfill gas, wastewater treatment gas, etc. Use of switchgrass is one of the main alternatives and is considered in this analysis, with switchgrass preparation cost of \$ 35/ton. The electricity production cost is highly sensitive to the biomass preparation cost. With 10% biomass, the cost is 1.23 cents/kWh and GHG emissions are 935 g/kWh; with 20% biomass the cost is 1.28 cents/kWh and the GHG emissions are 875.6 g/kWh. With biomass as the sole feedstock for electricity

generation, the optimum electricity production cost amounts to 1.7 cents/kWh. Figure 7.12 shows the electricity production cost with increasing biomass cofiring ratios.



**Figure 7.12.** Biomass electricity production cost as a function of cofiring ratio.

For the combined heat and power case, with increased cofiring ratio of biomass, the CHP cost goes up. The economic analysis shows that the CHP costs with 10%, 20% and 100% biomass are 2.95 cents/kWh, 3.05 cents/kWh and 4.11 cents/kWh. Figure 7.13 shows that the trend followed for CHP cost with increasing cofiring ratio is similar to the case of electricity alone.

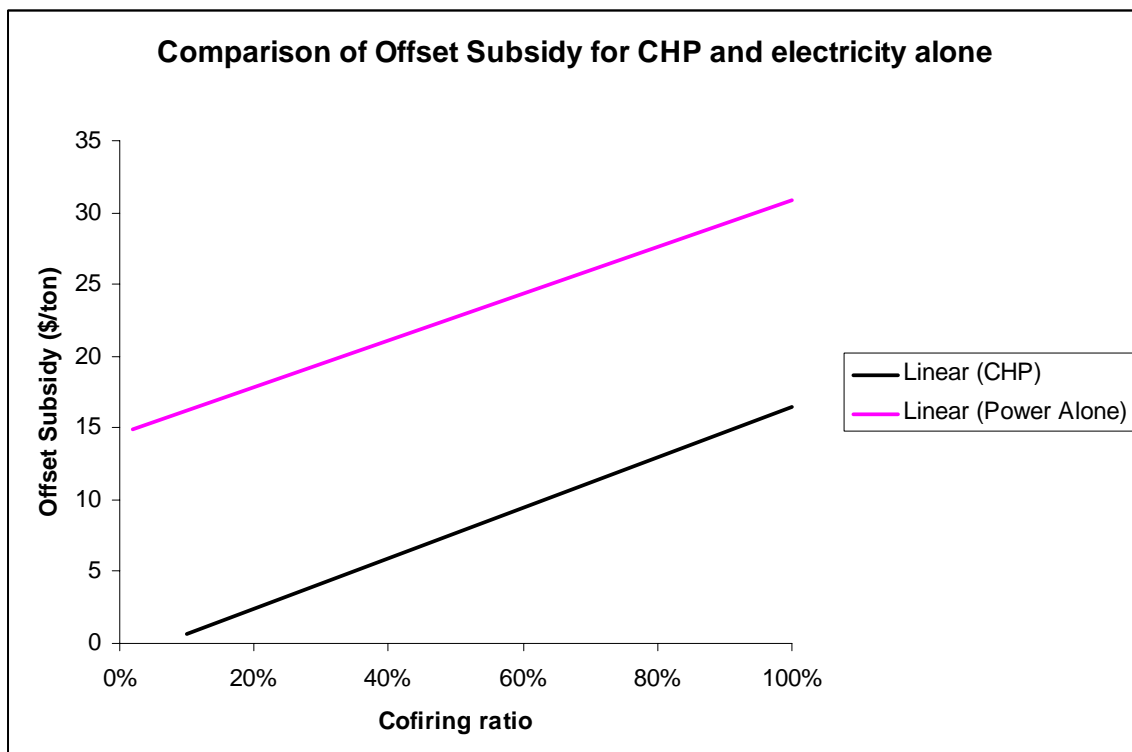


**Figure 7.13.** Biomass CHP cost as a function of cofiring ratio.

From the perspective of a processing plant, the cost shown in Figure 7.12 illustrates the cost that it would have to incur if it buys biomass power from external sources to meet its demand. The cost shown in Figure 7.13 is the cogeneration cost which is higher than the electricity generation plant as it includes the investment the processing plant would make for a turbine and the preparation cost for the fuel or biowaste streams. But, at the same time cogeneration unit would help to integrate the process and utility sections of the plant and make it more self sufficient, safe, reliable, clean and efficient.

The use of biomass and biowaste streams mitigates GHG emissions. Considering this GHG emission reduction by taking the ratio of the electricity or CHP cost with the

emission reduction for the particular cofiring ratio, the carbon dioxide emission price is evaluated. Figure 7.14 shows the relative CO<sub>2</sub> emission price for the case of biomass electricity generation and biomass CHP.



**Figure 7.14.** Carbon dioxide emission price for biomass electricity production and biomass CHP.

Analysis of Figure 7.14 shows that the emission price is reduced by 50% for the combined heat and power using biomass in comparison to biomass electricity generation. The emission price required for an electricity generation plant with biomass as the sole feedstock is \$32.09/ton CO<sub>2</sub>, whereas the emission price for a biomass CHP

unit would be \$16.45/ton CO<sub>2</sub>. Therefore, biomass CHP units would tremendously help in market penetration of biomass. Further, if policy options penalizing high GHG emitting processes come into effect, biomass CHP would be competitive with fossil fuels with out any subsidy as the penalty on the manufacturing unit for GHG emission would be balanced with the credits of using biomass in cogeneration systems.

### **Conclusions**

This section presented the prospect of utilizing biowaste and biomass as a partial or complete substitute for fossil fuels to satisfy the external fuel demand for cogeneration within a process. An algebraic approach for targeting cogeneration potential while minimizing the external fuel demand has been introduced. This technique is convenient and practical as temperature and pressure of the actual headers are employed, and spreadsheets can be used to readily evaluate the target for cogeneration potential, excess steam and the minimum external fuel required before detailed design. This work presented a methodology for simultaneous use of biomass and biowaste streams, thermal requirements of the process and electricity generation. Iterative flow balance cascade diagram and extractable power at each header interval are used to determine the target for cogeneration potential of the process. Two case studies were solved to validate the developed approach.

The economics and GHG pricing options for biomass use in CHP are examined to illustrate the importance of biomass CHP for market penetration of biomass. The carbon dioxide emission price is evaluated as \$16.45/ton CO<sub>2</sub> for biomass CHP and this is compared with the case of biomass electricity generation with an emission price of \$32.09/ton CO<sub>2</sub>. This reduction of about 50% in emission price by using biomass CHP would help drive biomass to come into picture as a renewable, green and clean substitute for fossil fuels. The analysis also illustrates the importance of reducing biomass processing costs to bring down the biomass electricity cost comparable to fossil fuel electricity costs with reasonable emission prices.

## VIII. CONCLUSIONS

This work presented an integrated approach for analysis of technical, economic and environmental aspects of using biomass in electricity production through sole biomass firing, cofiring with coal and in process industries via cogeneration systems. An integrated biocomplexity/lifecycle analysis approach was applied to examine the potential of switchgrass as an alternate or a supplementary feedstock for power generation. The analysis evaluated the most effective technologies for switchgrass preparation using loose harvested material compressed or chopped for transportation, which cost \$32.53 per ton of switchgrass produced. Net energy efficiency of switchgrass was found as 94.4% based on HHV of switchgrass. The minimum energy consumption for switchgrass processing was evaluated as 846 Btu/kg switchgrass for loose harvested material compressed or chopped before transportation. The model findings indicate that GHG mitigation per ton of switchgrass used during cofiring is better than switchgrass fired alone with the GHG effects of 68.5 g CO<sub>2</sub>-Eq /kWhr for switchgrass fired alone and 50.4 g CO<sub>2</sub>-Eq /kWhr for 10% switchgrass co fired with coal. CO<sub>2</sub>-Eq emission price was analyzed as a function of cofiring ratio, hauling distance, and yield, and it was found that for switchgrass to become competitive with coal for power generation fuel, either higher coal prices, a CO<sub>2</sub> offset market price or lower production costs are needed.

Although the analysis conducted in this research is quite rigorous; it suffers from some limitations. The lifecycle analysis was based on assumptions of yield as 10tons/acre, standlife of 10 years and a hauling distance of 25 miles. These conditions would vary depending on region, technology, economics and agricultural practices. Variation in these set of assumptions will lead to changes in the result. Further, the financial parameters such as interest rate, tax rate, cropland rental value, etc. are taken as average values for the Southeastern United States. These rates may vary with time and region and will result in a different set of values for the model and the subsequent analysis.

A generic computer-aided model for optimization of biomass electricity production cost was developed during the course of this research. The model was used to study the effect of cofiring ratio, biomass cost and alternate biomass processing pathways on the economics and GHG emissions. The limitations of the lifecycle analysis are overcome by this model. The yield, standlife and hauling distance, as well as the financial parameters for the location and time under consideration can be inputted into the program to get the corresponding set of numbers. The optimum electricity production cost was found as 1.23 cents/kWh for 11% cofiring with GHG emissions of 925 g/kWh. These numbers for cost and emissions can be compared with the case of coal burnt alone, which has a cost of 1.18 cents/kWh at GHG emission level of 997.5 g/kWh. The optimum cost and GHG alternative depends on a number of variations in the model, such as biomass cost, cofiring ratio, alternate pathway, etc. Analysis of the biomass electricity production cost by varying these parameters shows that the cost fluctuates between 1.3 cents/kWh to 7 cents/kWh. The sensitivity analysis of the model by varying the biomass production cost from lower range of about \$35/ton to higher range of about \$75/ton illustrated the need for future agricultural and engineering research in developing lower cost biomass feedstocks which would help in minimizing the emission price and making biomass cost competitive with coal. Also, the analysis of the effect of plant modification on the overall electricity production cost illustrated that it is imperative to reduce the plant modification costs.

A technique for optimal allocation of biomass and fossil fuel sources to power generation facilities has been developed. The approach uses mathematical programming to satisfy supply-demand and performance criteria while minimizing the economic and environmental effects.

Finally, the prospect of utilizing biowaste and biomass as a partial or complete substitute for fossil fuels to satisfy the external fuel demand for cogeneration within a process has been presented. An algebraic approach for targeting cogeneration potential while minimizing the external fuel demand has been introduced. This work presented a methodology for simultaneous use of biomass and biowaste streams, thermal



requirements of the process and electricity generation. The economics and GHG pricing options for biomass use in electricity production and CHP have been examined. Findings indicate a reduction of about 50%, from \$32.09/tonne to \$16.45/tonne, in emission price by using biomass CHP in comparison to biomass electricity generation which would help drive biomass to come into picture as a renewable, green and clean substitute for fossil fuels. Several case studies have been presented to illustrate the developed techniques.

## **IX. FUTURE WORK**

Future work based on this research can be expanded in a number of directions. There is scope for work in design and analysis of process equipment for bioenergy production and cofiring. There is need for reduction in plant modification costs for firing biomass along with coal. Hence, research in development of cost effective technologies for retrofitting and revamping of the existing units for cofiring biomass with coal needs to be explored. Biomass gasification might lead to higher efficiencies and lower costs. Therefore, biomass gasification is another area in which research is needed. Further, time dependent biomass to energy systems in which a biomass power plant is fired with different feedstocks depending on their harvesting seasons is another direction which could be explored. Also, the life cycle analysis conducted in this thesis mainly focused on greenhouse gas emissions. Addition of other environmental pollutants ( $\text{NO}_x$ ,  $\text{SO}_x$ , Hg, etc.), and other ecological affects such as effects on bird migration, food cycle, etc. need investigation. Additionally, it is imperative to increase biomass yields while reducing the production costs. Thus, research in biomass breeding and production work is required.

## REFERENCES

- Adahl, A., Harvey, S. and Berntsson T. (2004). *Energy Policy*, **32**, 1375-1388.
- Aerts, D.J., Bryden, K.M., Hoerning, J.M. and Ragland, K.W. (1997). In *Proceedings of the 1997 59<sup>th</sup> Annual American Power Conference*, vol. 59(2), 1180-1185.
- Amos, W. A. (2002). Summary of Chariton Valley Switchgrass Co-Fire Testing at the Ottumwa Generating Station in Chillicothe, Iowa, NREL/TP-510-32424, National Renewable Energy Laboratory, Golden, Colorado.
- Axelsson, H., Asblad, A. and Berntsson, T. (1999). *Applied Thermal Engineering*, **19**, 707-731.
- Bernotat, K. and Sandberg, T. (2004). *Biomass and Bioenergy*, **27**, 521-530.
- Beveridge, G.S.G. and Schechter, R. (1970). Optimization: Theory and Practice. McGraw Hill, New York.
- Boylan, D., Bush, V. and Bransby, D.I., (2000). *Biomass and Bioenergy*, **19**, 411-417.
- Bransby, D.I., McLaughlin, S.B. and Parrish, D.J. (1998). *Biomass and Bioenergy*, **14** (4), 379-384.
- Burnett H.S. (2004). Regulating Greenhouse Gas Emissions, National Center for Policy Analysis, <http://www.ncpa.org/pub/ba/ba494/ba494> (accessed December, 2004).
- Butt, T.A., and McCarl, B.A. (2004). *Choices*, **19**(3), 27-32.
- Butt, T.A., and McCarl, B.A. (2005). *Journal of Farm Managers and Rural Appraisers*, In press.
- Craig, K.R. and Mann, M.K. (1996). Cost and Performance Analysis of a Biomass-Based Integrated Gasification Combined Cycle (BIGCC) Power Systems, NREL/TP-430-21657, National Renewable Energy Laboratory, Colorado.
- Dhole, V.R. and Linnhoff, B. (1992). *Comp. Chem. Eng.*, **17**, S101-S109.
- Duffy, M. and Nanhou, V.Y. (2001). Costs of Producing Switchgrass for Biomass in Southern Iowa, Iowa State University: University Extension, PM 1866.
- Duval, Y. (2001). *Biomass and Bioenergy*, **20**, 287-295.

- Edgar, T.F. and Himmelblau, D.M. (1988). *Optimization of Chemical Processes*. McGraw Hill, New York.
- El-Halwagi, M.M. (1997). *Pollution Prevention through Process Integration Systematic Design Tools*, Academic Press, New York.
- El-Halwagi, M. M. (2003). *J. Clean Technologies and Environmental Policy*, **4**(3), 135.
- French, B.C. (1960). *Journal of Farm Economics*, **XLII**, 767-778.
- Grossmann, I.E., Ed. (1996). *Global Optimization in Engineering Design*, Kluwer Academic Pub., Dordrecht, The Netherlands.
- Gustavsson, L. and Johansson, B. (1994). *Heat Recovery Systems and CHP*, **14**(2), 117-127.
- Harell, D.A. (2004). *Resource Conservation and Allocation via Process Integration*, Ph.D. Thesis, Texas A&M University, College Station.
- Harell, D., and El-Halwagi, M. (2003). In *Proceedings of the AIChE Spring Meeting*, New Orleans, Louisiana.
- Hartmann, D. and Kaltschmitt, M. (1999). *Biomass and Bioenergy*, **16**, 397-406.
- Hockstad, L. and Hanle, L. (2004). *U.S. Greenhouse Gas Emissions and Sinks*, U.S. Environmental Protection Agency, Washington, DC, EPA 430-R-04-003.
- Hughes, E. (2000). *Biomass and Bioenergy*, **19**, 457-465.
- Husain, Z., Zainal, Z.A. and Abdullah, M.Z. (2003). *Biomass and Bioenergy*, **24**, 117-124.
- Ierland, V.E., Gupta, J., and Kok, M. (2003). Options for international climate policies: Toward an effective regime. In E. Van Ierland, J. Gupta, & M. Kok (Eds.), *Issues in international climate policy: Theory and policy* (1-16). Cheltenham, UK: Edward Elgar.
- Kenney, W. F., *Energy Conservation in the Process Industries*, Academic Press, Orlando, 1984.
- Kimura, H., and Zhu, X. X. (2000). *Ind. Eng. Chem. Res.*, **39**, 2315-2335.
- Lemus, R., Brummer, E.C., Moore, K.J., Molstad, N.E., Burras, C.L. and Barker, M.F. (2002). *Biomass and Bioenergy*, **23**, 433-442.

- Ma, Z., Wood, C.W. and Bransby, D.I. (2000a). *Biomass and Bioenergy*, **18**, 105-112.
- Ma, Z., Wood, C.W. and Bransby, D.I. (2000b). *Biomass and Bioenergy*, **18**, 469-477.
- Ma, Z., Wood, C.W. and Bransby, D.I. (2001). *Biomass and Bioenergy*, **20**, 413-419.
- Mann, M.K. and Spath, P.L. (1997). Life Cycle Assessment of a Biomass Gasification Combined-Cycle Power Plant, Midwest Research Institute, DE-AC36-83CH10093.
- Mann, M.K. and Spath, P.L. (1999) Life Cycle Assessment of Coal-fired Power Production. NREL/TP-570-25119. National Renewable Energy Laboratory, Golden, Colorado.
- Mann, M.K. and Spath, P.L. (2001). *Clean. Prod. Processes*, **3**, 81-91.
- Mavromatis, S.P. (1996). Conceptual Design and Operation of Industrial Steam Turbine Networks, Ph.D. Thesis, University of Manchester Institute of Science and Technology, Manchester, UK.
- Mavromatis, S. P. and Kokossis, A. C. (1998). *Chemical Engineering Science*, **53**(8), 1609-1630.
- Mbohwa, C. (2003). *Renewable Energy*, **28**, 191-204.
- McCarl, B.A. and Schneider, U.A. (2001). *Science*, **294** (21 Dec), 2481-2482.
- McLaughlin, S., Bouton, J., Bransby, D., Conger, B., Ocumpaugh, W., Parrish, D, Tailiaferro, C., Vogel, K., and Wullschleger, S. (1999). Perspectives on new crops and new uses, ASHS Press, Alexandria, Virginia.
- Mintzer, I., Leonard, J.A. and Schwartz, P. (2003). U.S. Energy Scenarios for the 21<sup>st</sup> Century, Pew Center on Global Climate Change, Arlington, Virginia.
- Mohan, T. and El-Halwagi, M.M. (2005). *Chemical Engineering Communications*, in press.
- Ney, R.A. and Schnoor, J.L. (2002). Greenhouse Gas Emission Impacts of Substituting Switchgrass for Coal in Electric Generation: The Chariton Valley Biomass Project, Center for Global and Regional Environmental Research, University of Iowa.

- Noon, C.E., Daly, M.J., Graham, R.L. and Zahn, F.B. (1996). In *Proceedings of bioenergy '96- the seventh national bioenergy conference*, Nashville, TN, 15-20 Sep., Southeastern Regional Biomass Energy Program, 487-493.
- Papadopoulos, D.P. and Katsigiannis, P.A. (2002). *Biomass and Bioenergy*, **22**, 105-124.
- Point Carbon, EUA Price Assessment, <http://www.pointcarbon.com> (accessed April 18, 2005)
- Qin, X., Mohan, T., El-Halwagi, M.M., Cornforth, G., and McCarl, B.A. (2005). *Journal of Clean Technologies and Environmental Policy*, in press.
- Raissi, K. (1994). Total Site Integration. Ph.D. Thesis, University of Manchester Institute of Science and Technology, Manchester, UK.
- Reklaitis, G.V., Ravindran, A., and Ragsdell, K.M. (1983). *Engineering Optimization*. Wiley, New York.
- Sami, M., Annamalai, K., and Wooldridge, M. (2001). *Progress in Energy and Combustion Science*, **27**, 171-214.
- Sanderson, M.A., Egg, R.P., and Wiseloge, A.E. (1997). *Biomass and Bioenergy*, **12** No.2, 107-114.
- Sladden, S.E., Bransby, D.I. and Aiken, G.E. (1991). *Biomass and Bioenergy*, **1** No. 2, 119-122.
- Smith, H.A. and Bransby, D.I. (2005). Southeastern Switchgrass Production, Preparation and Delivery Budgets, Auburn University, Alabama (personal communication).
- Spliethoff, H. and Hein, K.R.G. (1998). *Fuel Processing Technology*, **54** Iss. 1-3, 189-205.
- Stavins, R.N. (2002). Lessons From the American Experiment with Market-Based Environmental Policies, *Harnessing the Hurricane: The Challenge of Market-Based Governance*, J. Donahue and J. Nye, eds. Brookings Institution Press, Cambridge, Massachusetts.
- Sundberg, G. and Henning, D. (2002). *Energy Conversion and Management*, **43**, 639-650.
- Tharakan, P.J., Volk, T.A, Lindsey, C.A, Abrahamson, L.P., and White, E.H. (2005). *Energy Policy*, vol. **33**, Issue 3, 337-347.

- Tillman, D.A. (2000). *Biomass & Bioenergy*, vol. **19**, 365-384.
- United States Environmental Protection Agency (USEPA). Inventory of U.S. Greenhouse Gas Emissions and Sinks: 1990-2002, 2004, Washington, DC.
- United States Environmental Protection Agency (USEPA). (2003). AP-42, Fifth Edition, Volume I, Chapter 1: External Combustion Sources, <http://www.epa.gov/ttn/chief/ap42/ch01/> (accessed July, 2004).
- United States Department of Energy, Energy Information Administration (USDOE/EIA). (2002). Emissions of Greenhouse Gases in the United States 2002, DOE/EIA-0573, Washington, DC.
- United States Department of Energy, Energy Information Administration (USDOE/EIA). (2002). Electric Power Annual 2002, DOE/EIA-0348, Washington, DC.
- Varbanov, P. S., Doyle, S., and Smith, R. (2004). *Chemical Engineering Research and Design*, **82**(A5), 561-578.
- Van Wyk, J.P.H., (2001). *TRENDS in Biotechnology*, **19** No. 5.
- Wahlund, B., Yan, J. and Westermarck, M. (2002). *Biomass and Bioenergy*, **23**, 271-281.
- Wang, M. and Santini, D. (2000). GREET transportation fuel cycle analysis model, version 1.5. Center for Transportation Research, Argonne National Laboratory, Argonne, Illinois.
- Watson, R.T., Albritton, D.L., editors. (2002). Climate Change 2001: Synthesis Report, Summary for Policymakers (Third IPCC Assessment Report), An Assessment of the Intergovernmental Panel on Climate Change, United Kingdom: Cambridge University Press, Cambridge, United Kingdom.
- Wen, Y. and Shonnard, D. (2003). *Comp. Chem. Eng.*, **27**(11), 1577-1590.
- West, T.O. and Post, W.M. (2002). *Soil Society of America*, **66**, pp. 1930-1946.
- Winters, T. (2002). *The Electricity Journal*, vol. **15**, Issue 6, 56-66.

## APPENDIX

### A.1 - Lingo code for optimization of biomass electricity cost

```

MIN = COST_DOLLAR_PER_KWH;
!PRICES OF FUEL;
DIESEL_P = 1.45;
GAS_P = 1.48;
ELECT_P = 0.075;
LIQ_PET_P = 1.05;
!FINANCIAL PARAMETERS;
GENERALOVERHEAD = 0.07;
INTEREST = 0.07;
TAX = 0;
INSURANCE = 0.006;
LABOR_WAGE = 7.25;
LABOR_TO_MACHINE = 1.1;
UNALLOCATED_LABOR_TO_MAC = 1.25;
LUBE_TO_FUEL = 0.15;
RENTAL_PASTURE = 8.20;
RENTAL_RECROP = 24;
!YIELD VARIATION;
YIELD <12;
YIELD>4;
!YIELD = 10;
RESEED = 0.25;
SIZE_OF_ENTERPRISE = 1;
!LOAD OF TRUCKS;
ROUNDBALES = 20;
LOOSECHOP = 15;
MODULES = 14;
PELLETS = 30;
GROUND = 15;
!DISTANCE VARIATION CONSTRAINT;
COFIRE > 0.05;
COFIRE < 0.5;
!COFIRE = 0.05;
DENSITY>0.05;
DENSITY <0.7;
DAYS_OF_OPERATION = 300;
HRS_OF_OPERATION = 24;
PLANT_EFFICIENCY = 0.8;
NPHR_COAL = 0.010338;
NPHR_SW_COFIRE = 0.0105*@EXP(0.4098*COFIRE);
!NPHR_SW_COFIRE = 0.01078;
HHV_COAL = 0.022305893;
HHV_SW = 0.015144857;
PLANT_SIZE_MW >25;
PLANT_SIZE_MW < 300;
SW_KG = COFIRE * HHV_COAL/((1-COFIRE)*HHV_SW+COFIRE*HHV_COAL)* 1 *
907.1847;
COAL_KG = (1-(COFIRE * HHV_COAL/((1-COFIRE)*HHV_SW+COFIRE*HHV_COAL)))*
1 * 907.1847;

```



```

SW_THERMAL = SW_KG*HHV_SW;
COAL_THERMAL =COAL_KG *HHV_COAL;
SW_ELEC = SW_THERMAL/NPHR_SW_COFIRE;
COAL_ELEC = COAL_THERMAL/NPHR_COAL;
TOTAL_ELEC = SW_ELEC + COAL_ELEC;
SW_REQD = SW_KG /TOTAL_ELEC;
COAL_REQD = COAL_KG/TOTAL_ELEC;
M
PLANT_SIZE_MW*1000*DAYS_OF_OPERATION*HRS_OF_OPERATION*PLANT_EFFICIENCY*
SW_REQD;
M_coal
PLANT_SIZE_MW*1000*DAYS_OF_OPERATION*HRS_OF_OPERATION*PLANT_EFFICIENCY*
COAL_REQD;
DIST = ((M/1000)/((640*YIELD*0.9071847*DENSITY))^0.5*0.4714;
DIST >=0;
DIST <=150;
!DIST = 50;
TRUCK_SPEED = 45;
!STANDLIFE VARIATION CONSTRAINT;
STANDLIFE >= 2;
STANDLIFE <= 15;
!STANDLIFE = 10;
!AMOUNT OF FERTILIZERS USED;
HERBICIDE = 2.20;
NITROGEN = 110;
P2O5 = 44;
K2O = 44;
LIME = 2;
SOIL = 0.03;
SEEDS = 5;
TRACTOR = 1;
! TRACTOR COST CALCULATIONS;
SETS:
VAR/1..5/:RC1_T,
RC2_T,COST_T,ESTIMATED_HOURS_T,HOURS_LIFE_T,D_T,HP_T,YEARS_OF_LIFE_T,RF
V1_T,RFV2_T,ANNUAL_HOURS_USE_T,REPAIR_COST_T,FUEL_COST_T,INTEREST_COST_
T,INSURANCE_COST_T,TAX_COST_T,LUBE_COST_T,VARIABLE_COST_T,SALVAGE_COST_
T,DEPRECIATION_COST_T,FIXED_COST_T;
ENDSETS

DATA:
RC1_T = 1.2 1.2 1.2 1.2 1.2 ;
RC2_T = 2 1.6 1.6 1.6 1.6;
COST_T = 21120 34550 43325 57280 71411 ;
ESTIMATED_HOURS_T = 6000 6000 6000 6000 6000;
HOURS_LIFE_T = 12000 12000 12000 12000 12000 ;
D_T = 2 0.9 0.9 0.9 0.9 ;
HP_T = 55 75 95 115 135 ;
YEARS_OF_LIFE_T = 10 10 10 10 10 ;
RFV1_T =0.68 0.68 0.68 0.68 0.68 ;
RFV2_T = 0.92 0.92 0.92 0.92 0.92 ;
ANNUAL_HOURS_USE_T = 600 600 600 600 600 ;
ENDDATA

```

```

@FOR(VAR(i):REPAIR_COST_T(i) = ((RC1_T(i)
*COST_T(i))*(ESTIMATED_HOURS_T(i)/HOURS_LIFE_T(i))^RC2_T(i))/ESTIMATED_
HOURS_T(i));
@FOR(VAR(i):FUEL_COST_T(i) = (@IF(D_T(i) #LT#
1,HP_T(i)*0.048*DIESEL_P,HP_T(i)*0.068*GAS_P));
@FOR(VAR(i):LUBE_COST_T(i) = FUEL_COST_T(i)*LUBE_TO_FUEL);
@FOR(VAR(i):VARIABLE_COST_T(i) = REPAIR_COST_T(i) + FUEL_COST_T(i) +
LUBE_COST_T(i));
@FOR(VAR(i):SALVAGE_COST_T(i) =
RFV1_T(i)*COST_T(i)*(RFV2_T(i)^YEARS_OF_LIFE_T(i));
@FOR(VAR(i):DEPRECIATION_COST_T(i) = (COST_T(i) -
SALVAGE_COST_T(i))/(ESTIMATED_HOURS_T(i));
@FOR(VAR(i):INSURANCE_COST_T(i) = (((COST_T(i) + SALVAGE_COST_T(i))/2)*
INSURANCE) / ANNUAL_HOURS_USE_T(i));
@FOR(VAR(i):INTEREST_COST_T(i) = (((COST_T(i) +
SALVAGE_COST_T(i))/2)/ANNUAL_HOURS_USE_T(i))*INTEREST/100));
@FOR(VAR(i):TAX_COST_T(i) = (COST_T(i)/ANNUAL_HOURS_USE_T(i))*TAX);
@FOR(VAR(i):FIXED_COST_T(i) = (DEPRECIATION_COST_T(i) +
INSURANCE_COST_T(i) + INTEREST_COST_T(i) + TAX_COST_T(i));
!MACHINE COST CALCULATIONS;
SETS:
VARMAC/1..26/:RC1_M,
RC2_M,COST_M,ESTIMATED_HOURS_M,HOURS_LIFE_M,D_M,HP_M,YEARS_OF_LIFE_M,RF
V1_M,RFV2_M,ANNUAL_HOURS_USE_M,REPAIR_COST_M,FUEL_COST_M,INTEREST_COST_
M,INSURANCE_COST_M,TAX_COST_M,LUBE_COST_M,VARIABLE_COST_M,SALVAGE_COST_
M,DEPRECIATION_COST_M,FIXED_COST_M;
HOURS/1..10/:HRS_PER_AC_M,WIDTH_M,SPEED_M,EFFICIENCY_M,EX_VARIABLE_COST
_M,EXT_FIXED_COXT_M;
EX/1..10/:HRS_PER_AC_MAC,VARIABLE_COST_MAC,FIXED_COST_MAC,EX_VARIABLE,E
X_FIXED;
ENDSETS

DATA:
RC1_M = 0.7 0.65 0.5 0.8 0.7 0.80 1.00 1.80 1 0.67 1.20
1.20 1 1 1.2 0.67 1.2 1.2 0.5 1.2 1.2 1.2
1.2 1.8 1.2 1.20 ;
RC2_M = 1.80 1.80 1.80 1.80 2.10 1.80 2.10 1.80 1.30 1.30 1.30
2.00 2.00 1.30 1 2.00 1.30 2.00 2.00 1.30 2.00 2.00
2.00 2.00 2.00 2.00 2.00;
COST_M = 3164.60 8309.78 1548.96 11644.00 3164.60
29462.34 3718.05 2714.48 18500.00 23000.00
30000.00 24500.00 18500.00 1 90000.00 12000.00
24500.00 145000.00 2581.60 24500.00 22000.00
150000.00 145000.00 250000.00 24500.00 145000.00 ;
ESTIMATED_HOURS_M = 800.00 1000.00 1500.00 975.00
800.00 975.00 500.00 500.00 1000.00
800.00 6000.00 9000.00 1000.00 1.00 6000.00
8000.00 9000.00 6000.00 1000.00 9000.00
4000.00 10000.00 6000.00 32000.00 9000.00
6000.00;

HOURS_LIFE_M = 1000.00 2000.00 2500.00 1200.00 1000.00
1200.00 1000.00 1000.00 2000.00 2000.00
12000.00 12000.00 2000.00 1 12000.00 8000.00

```

```

12000.00 12000.00 1000.00 12000.00 12000.00
12000.00 12000.00 32000.00 12000.00 12000.00 ;
D_M = 2.00 0.9 2.00 0.9 2.00 0.9 2.00 0.9 0.9 0.9 2.00
2.00 0.9 0.9 0.9 0.9 2.00 0.9 0.9 2.00 2.00 2.00 0.9
3.00 2.00 0.9;
HP_M = 0.00 0.00 0.00 0.00 0.00 0.00 0.00 0.00 0.00 0.00
125.00 55.00 0.00 0.00 400.00 0.00 55.00 400.00
0.00 55.00 130.00 65.00 140.00 200.00 55.00
400.00 ;
YEARS_OF_LIFE_M = 10.00 10.00 30.00 13.00 10.00 13.00 10.00 10.00 10.00
8.00 15.00 15.00 10.00 1.00 15.00 10.00 15.00 15.00 10.00 15.00
20.00 10.00 15.00 8.00 15.00 15.00 ;
RFV1_M = 0.60 0.60 0.60 0.60 0.60 0.60 0.56 0.60 0.56 0.56
0.68 0.68 0.56 1.00 0.68 0.56 0.68 0.68 0.50 0.68 0.68
0.68 0.68 0.68 0.68 0.68 ;
RFV2_M = 0.89 0.89 0.89 0.89 0.89 0.89 0.89 0.89 0.89 0.89 0.89
0.92 0.92 0.89 1.00 0.92 0.89 0.92 0.92 0.90 0.92 0.92
0.92 0.92 0.92 0.92 0.92 ;
ANNUAL_HOURS_USE_M =
80.00 100.00 50.00 75.00 80.00 75.00 50.00 50.00 100.00
100.00 400.00 600.00 100.00 1.00 400.00
800.00 600.00 400.00 100.00 600.00
200.00 1000.00 400.00 4000.00 600.00
400.00 ;
WIDTH_M = 12.00 13.00 13.00 13.00 12.00 13.00 20.00 9.00 14.00 14.00
;
SPEED_M = 5 4.5 4.5 5 5 5 5 4.3 4.3 3.475 ;
EFFICIENCY_M = 0.90 0.85 0.70 0.80 0.90 0.80 0.67 0.81 0.77
0.67;

```

ENDDATA

```

@FOR(VARMAC(i):REPAIR_COST_M(i) = ((RC1_M(i)
*COST_M(i))*(ESTIMATED_HOURS_M(i)/HOURS_LIFE_M(i))^RC2_M(i))/ESTIMATED_
HOURS_M(i));
@FOR(VARMAC(i):FUEL_COST_M(i) = (@IF(D_M(i) #LT#
1,HP_M(i)*0.048*DIESEL_P,HP_M(i)*0.068*GAS_P));
@FOR(VARMAC(i):LUBE_COST_M(i) = FUEL_COST_M(i)*LUBE_TO_FUEL);
@FOR(VARMAC(i):VARIABLE_COST_M(i) = REPAIR_COST_M(i) + FUEL_COST_M(i) +
LUBE_COST_M(i));
@FOR(VARMAC(i):SALVAGE_COST_M(i) =
RFV1_M(i)*COST_M(i)*(RFV2_M(i)^YEARS_OF_LIFE_M(i)));
@FOR(VARMAC(i):DEPRECIATION_COST_M(i) = (COST_M(i) -
SALVAGE_COST_M(i))/(ESTIMATED_HOURS_M(i));
@FOR(VARMAC(i):INSURANCE_COST_M(i) = (((COST_M(i) +
SALVAGE_COST_M(i))/2)* INSURANCE) / ANNUAL_HOURS_USE_M(i));
@FOR(VARMAC(i):INTEREST_COST_M(i) = (((COST_M(i) +
SALVAGE_COST_M(i))/2)/ANNUAL_HOURS_USE_M(i))*INTEREST/100);
@FOR(VARMAC(i):TAX_COST_M(i) = (COST_M(i)/ANNUAL_HOURS_USE_M(i))*TAX);
@FOR(VARMAC(i):FIXED_COST_M(i) = (DEPRECIATION_COST_M(i) +
INSURANCE_COST_M(i) + INTEREST_COST_M(i) + TAX_COST_M(i));
@FOR(HOURS(j): HRS_PER_AC_M(j) = ((43560/(5280*WIDTH_M(j) * SPEED_M(j)
* EFFICIENCY_M(j)))));
WIDTH_MI_13 = 14;
WIDTH_MI_14 = 14;

```

```

WIDTH_MI_19 = 14;
WIDTH_MI_21 = 14;
SPEED_MI_13 = 4.3;
SPEED_MI_14 = 3.475;
SPEED_MI_19 = 3.475;
SPEED_MI_21 = 3.475;
EFFICIENCY_MI_13 = 0.77;
EFFICIENCY_MI_14 = 0.4;
EFFICIENCY_MI_19 = 0.7;
EFFICIENCY_MI_21 = 0.4;
HRS_PER_AC_M_11 = 0.2*(YIELD/2);
HRS_PER_AC_M_12 = (1+1.5 *(YIELD/20));
HRS_PER_AC_M_13 = ((43560/(5280*WIDTH_MI_13 * SPEED_MI_13 *
EFFICIENCY_MI_13)));
HRS_PER_AC_M_14 = ((43560/(5280*WIDTH_MI_14 * SPEED_MI_14 *
EFFICIENCY_MI_14)));
HRS_PER_AC_M_15 = (1+(2*DIST/45)*(YIELD/ROUNDBALES));
HRS_PER_AC_M_16 = YIELD/3;
HRS_PER_AC_M_17 = HRS_PER_AC_M_12;
HRS_PER_AC_M_18 = (1+(2*DIST/45)*(YIELD/GROUND));
HRS_PER_AC_M_19 = ((43560/(5280*WIDTH_MI_19 * SPEED_MI_19 *
EFFICIENCY_MI_19)));
HRS_PER_AC_M_20 = HRS_PER_AC_M_12;
HRS_PER_AC_M_21 = ((43560/(5280*WIDTH_MI_21 * SPEED_MI_21 *
EFFICIENCY_MI_21)));
HRS_PER_AC_M_22 = YIELD/14;
HRS_PER_AC_M_23 = (1+(2*DIST/45)*(YIELD/MODULES));
HRS_PER_AC_M_24 = 67*YIELD/HP_M(24);
HRS_PER_AC_M_25 = HRS_PER_AC_M_12;
HRS_PER_AC_M_26 = HRS_PER_AC_M_15;

@FOR(EX(i):HRS_PER_AC_MAC(i) =( HRS_PER_AC_M(i)));
@FOR(EX(i):VARIABLE_COST_MAC(i) =( VARIABLE_COST_M(i)));
@FOR(EX(i):FIXED_COST_MAC(i) =( FIXED_COST_M(i)));
@FOR(EX(i): EX_VARIABLE(i) = (HRS_PER_AC_MAC(i) *
VARIABLE_COST_MAC(i)));
@FOR(EX(i): EX_FIXED(i) = (HRS_PER_AC_MAC(i) * FIXED_COST_MAC(i)));
EX_VARIABLE_11 = HRS_PER_AC_M_11 * VARIABLE_COST_M(11);
EX_VARIABLE_12 = HRS_PER_AC_M_12 * VARIABLE_COST_M(12);
EX_VARIABLE_13 = HRS_PER_AC_M_13 * VARIABLE_COST_M(13);
EX_VARIABLE_14 = HRS_PER_AC_M_14 * VARIABLE_COST_M(14);
EX_VARIABLE_15 = HRS_PER_AC_M_15 * VARIABLE_COST_M(15);
EX_VARIABLE_16 = HRS_PER_AC_M_16 * VARIABLE_COST_M(16);
EX_VARIABLE_17 = HRS_PER_AC_M_17 * VARIABLE_COST_M(17);
EX_VARIABLE_18 = HRS_PER_AC_M_18 * VARIABLE_COST_M(18);
EX_VARIABLE_19 = HRS_PER_AC_M_19 * VARIABLE_COST_M(19);
EX_VARIABLE_20 = HRS_PER_AC_M_20 * VARIABLE_COST_M(20);
EX_VARIABLE_21 = HRS_PER_AC_M_21 * VARIABLE_COST_M(21);
EX_VARIABLE_22 = HRS_PER_AC_M_22 * VARIABLE_COST_M(22);
EX_VARIABLE_23 = HRS_PER_AC_M_23 * VARIABLE_COST_M(23);
EX_VARIABLE_24 = HRS_PER_AC_M_24 * VARIABLE_COST_M(24);
EX_VARIABLE_25 = HRS_PER_AC_M_25 * VARIABLE_COST_M(25);
EX_VARIABLE_26 = HRS_PER_AC_M_26 * VARIABLE_COST_M(26);

```

```

EX_FIXED_11 = HRS_PER_AC_M_11 * FIXED_COST_M(11);
EX_FIXED_12 = HRS_PER_AC_M_12 * FIXED_COST_M(12);
EX_FIXED_13 = HRS_PER_AC_M_13 * FIXED_COST_M(13);
EX_FIXED_14 = HRS_PER_AC_M_14 * FIXED_COST_M(14);
EX_FIXED_15 = HRS_PER_AC_M_15 * FIXED_COST_M(15);
EX_FIXED_16 = HRS_PER_AC_M_16 * FIXED_COST_M(16);
EX_FIXED_17 = HRS_PER_AC_M_17 * FIXED_COST_M(17);
EX_FIXED_18 = HRS_PER_AC_M_18 * FIXED_COST_M(18);
EX_FIXED_19 = HRS_PER_AC_M_19 * FIXED_COST_M(19);
EX_FIXED_20 = HRS_PER_AC_M_20 * FIXED_COST_M(20);
EX_FIXED_21 = HRS_PER_AC_M_21 * FIXED_COST_M(21);
EX_FIXED_22 = HRS_PER_AC_M_22 * FIXED_COST_M(22);
EX_FIXED_23 = HRS_PER_AC_M_23 * FIXED_COST_M(23);
EX_FIXED_24 = HRS_PER_AC_M_24 * FIXED_COST_M(24);
EX_FIXED_25 = HRS_PER_AC_M_25 * FIXED_COST_M(25);
EX_FIXED_26 = HRS_PER_AC_M_26 * FIXED_COST_M(26);

```

!NOW DEPENDING ON THE TRACTOR USED, THAT COST IS TO BE ADDED;

```

IN_VARIABLE_1      =      (VARIABLE_COST_M(1)      +VARIABLE_COST_T(1))*
HRS_PER_AC_M(1);
IN_VARIABLE_2      =      (VARIABLE_COST_M(2)      +VARIABLE_COST_T(4))*
HRS_PER_AC_M(2);
IN_VARIABLE_3      =      (VARIABLE_COST_M(3)      +VARIABLE_COST_T(1))*
HRS_PER_AC_M(3);
IN_VARIABLE_4      =      (VARIABLE_COST_M(4)      +VARIABLE_COST_T(5))*
HRS_PER_AC_M(4);
IN_VARIABLE_5      =      (VARIABLE_COST_M(5)      +VARIABLE_COST_T(1))*
HRS_PER_AC_M(5);
IN_VARIABLE_6      =      (VARIABLE_COST_M(6)      +VARIABLE_COST_T(5))*
HRS_PER_AC_M(6);
IN_VARIABLE_7      =      (VARIABLE_COST_M(7)      +VARIABLE_COST_T(1))*
HRS_PER_AC_M(7);
IN_VARIABLE_8      =      (VARIABLE_COST_M(8)      +VARIABLE_COST_T(2))*
HRS_PER_AC_M(8);
IN_VARIABLE_9      =      (VARIABLE_COST_M(9)      +VARIABLE_COST_T(2))*
HRS_PER_AC_M(9);
IN_VARIABLE_10     =      (VARIABLE_COST_M(10)     +VARIABLE_COST_T(3))*
HRS_PER_AC_M(10);
IN_VARIABLE_13     =      (VARIABLE_COST_M(13)     +VARIABLE_COST_T(2))*
HRS_PER_AC_M_13;
IN_VARIABLE_14 = 15.87;
IN_VARIABLE_16     =      (VARIABLE_COST_M(16)     +VARIABLE_COST_T(2))*
HRS_PER_AC_M_16;
IN_VARIABLE_19     =      (VARIABLE_COST_M(19)     +VARIABLE_COST_T(2))*
HRS_PER_AC_M_19;

```

```

IN_FIXED_1 = (FIXED_COST_M(1) +FIXED_COST_T(1))* HRS_PER_AC_M(1);
IN_FIXED_2 = (FIXED_COST_M(2) +FIXED_COST_T(4))* HRS_PER_AC_M(2);
IN_FIXED_3 = (FIXED_COST_M(3) +FIXED_COST_T(1))* HRS_PER_AC_M(3);
IN_FIXED_4 = (FIXED_COST_M(4) +FIXED_COST_T(5))* HRS_PER_AC_M(4);
IN_FIXED_5 = (FIXED_COST_M(5) +FIXED_COST_T(1))* HRS_PER_AC_M(5);
IN_FIXED_6 = (FIXED_COST_M(6) +FIXED_COST_T(5))* HRS_PER_AC_M(6);

```

```

IN_FIXED_7 = (FIXED_COST_M(7) +FIXED_COST_T(1))* HRS_PER_AC_M(7);
IN_FIXED_8 = (FIXED_COST_M(8) +FIXED_COST_T(2))* HRS_PER_AC_M(8);
IN_FIXED_9 = (FIXED_COST_M(9) +FIXED_COST_T(2))* HRS_PER_AC_M(9);
IN_FIXED_10 = (FIXED_COST_M(10) +FIXED_COST_T(3))* HRS_PER_AC_M(10);
IN_FIXED_13 = (FIXED_COST_M(13) +FIXED_COST_T(2))* HRS_PER_AC_M_13;
IN_FIXED_14 = 15.87;
IN_FIXED_16 = (FIXED_COST_M(16) +FIXED_COST_T(2))* HRS_PER_AC_M_16;
IN_FIXED_19 = (FIXED_COST_M(19) +FIXED_COST_T(2))* HRS_PER_AC_M_19;

!ESTABLISHMENT 1;
EST_PASS_M1 = 2;
EST_PASS_M2 = 2;
EST_PASS_M3 = 1;
EST_PASS_M4 = 1;
EST1_MAC_HOURS = HRS_PER_AC_M(1)*EST_PASS_M1
+HRS_PER_AC_M(2)*EST_PASS_M2 + HRS_PER_AC_M(3)*EST_PASS_M3
+HRS_PER_AC_M(4)*EST_PASS_M4;
LABOR_1 = HRS_PER_AC_M(1) * LABOR_TO_MACHINE;
LABOR_2 = HRS_PER_AC_M(2) * LABOR_TO_MACHINE;
LABOR_3 = HRS_PER_AC_M(3) * LABOR_TO_MACHINE;
LABOR_4 = HRS_PER_AC_M(4) * LABOR_TO_MACHINE;
PASS_L1 = LABOR_1 * EST_PASS_M1;
PASS_L2 = LABOR_2 * EST_PASS_M2;
PASS_L3 = LABOR_3 * EST_PASS_M3;
PASS_L4 = LABOR_4 * EST_PASS_M4;
EST1_LAB_HOURS = PASS_L1 + PASS_L2 + PASS_L3 + PASS_L4;
EST1_VARIABLE = IN_VARIABLE_1*EST_PASS_M1 +IN_VARIABLE_2*EST_PASS_M2 +
IN_VARIABLE_3*EST_PASS_M3 + IN_VARIABLE_4*EST_PASS_M4;
EST1_FIXED = IN_FIXED_1*EST_PASS_M1 +IN_FIXED_2*EST_PASS_M2 +
IN_FIXED_3*EST_PASS_M3 + IN_FIXED_4*EST_PASS_M4;
EST1_UNALLOCATED_LAB = EST1_LAB_HOURS *UNALLOCATED_LABOR_TO_MAC ;

!VARIABLE COSTS FOR ESTABLISHMENT 1;
ATRAZINE_EST1 = 9.69*HERBICIDE*SIZE_OF_ENTERPRISE ;
NITROGEN_EST1 = 0.32*NITROGEN*SIZE_OF_ENTERPRISE;
P2O5_EST1 = 0.27*P2O5*SIZE_OF_ENTERPRISE;
K2O_EST1 = 0.15*K2O*SIZE_OF_ENTERPRISE;
LIME_EST1 = 22.50*LIME*SIZE_OF_ENTERPRISE;
SOIL_EST1 = 7*SOIL*SIZE_OF_ENTERPRISE;
SEED_EST1 = 7*SEEDS*SIZE_OF_ENTERPRISE;
TRACTOR_EST1 = EST1_VARIABLE*TRACTOR*SIZE_OF_ENTERPRISE;
EST1_TOTAL_VARIABLE = ATRAZINE_EST1 + NITROGEN_EST1 + P2O5_EST1 +
K2O_EST1 +LIME_EST1 +SOIL_EST1 +SEED_EST1 +TRACTOR_EST1;

!FIXED COSTS FOR ESTABLISHMENT 1;
TRACTOR_EQUIP_EST1 = EST1_FIXED*TRACTOR*SIZE_OF_ENTERPRISE;
EST1_GENERALOVERHEAD = EST1_TOTAL_VARIABLE*GENERALOVERHEAD;
EST1_TOTAL_FIXED = TRACTOR_EQUIP_EST1 + EST1_GENERALOVERHEAD;

!LABOR COSTS FOR ESTABLISHMENT 1;
EST1_TOTAL_LABOR = (EST1_LAB_HOURS+EST1_UNALLOCATED_LAB)*SIZE_OF_ENTERPRISE*LABOR_WAGE;

!TOTAL OF ALL COSTS FOR ESTABLISHMENT 1;

```

```

EST1_TOTAL_COST      =      EST1_TOTAL_VARIABLE      +      EST1_TOTAL_FIXED      +
EST1_TOTAL_LABOR;
EST1_AMORITIZED_COST      =      ( INTEREST/(1-
(1/(1+INTEREST)^STANDLIFE)))*EST1_TOTAL_COST;

```

```
! GHG FROM ESTABLISHMENT 1;
```

```

EST1_CO2_M1      =      HP_T(1)*HRS_PER_AC_M(1)*EST_PASS_M1*      (2545
/128500/0.3)*128500 * 92614 /10^6;
EST1_CO2_M2      =      HP_T(4)*HRS_PER_AC_M(2)*EST_PASS_M2*      (2545
/115500/0.4)*115500 * 94495 /10^6;
EST1_CO2_M3      =      HP_T(1)*HRS_PER_AC_M(3)*EST_PASS_M3*      (2545
/128500/0.3)*128500 * 92614 /10^6;
EST1_CO2_M4      =      HP_T(5)*HRS_PER_AC_M(4)*EST_PASS_M4*      (2545
/115500/0.4)*115500 * 94495 /10^6;
EST1_CO2_TOTAL = EST1_CO2_M1 + EST1_CO2_M2 + EST1_CO2_M3 + EST1_CO2_M4;

```

```

EST1_N2O_M1      =      HP_T(1)*HRS_PER_AC_M(1)*EST_PASS_M1*      (2545
/128500/0.3)*128500 * 2.263 /10^6;
EST1_N2O_M2      =      HP_T(4)*HRS_PER_AC_M(2)*EST_PASS_M2*      (2545
/115500/0.4)*115500 * 2.201 /10^6;
EST1_N2O_M3      =      HP_T(1)*HRS_PER_AC_M(3)*EST_PASS_M3*      (2545
/128500/0.3)*128500 * 2.263 /10^6;
EST1_N2O_M4      =      HP_T(5)*HRS_PER_AC_M(4)*EST_PASS_M4*      (2545
/115500/0.4)*115500 * 2.201 /10^6;
EST1_N2O_TOTAL = EST1_N2O_M1 + EST1_N2O_M2 + EST1_N2O_M3 + EST1_N2O_M4;

```

```

EST1_CH4_M1      =      HP_T(1)*HRS_PER_AC_M(1)*EST_PASS_M1*      (2545
/128500/0.3)*128500 * 146.611 /10^6;
EST1_CH4_M2      =      HP_T(4)*HRS_PER_AC_M(2)*EST_PASS_M2*      (2545
/115500/0.4)*115500 * 108.266 /10^6;
EST1_CH4_M3      =      HP_T(1)*HRS_PER_AC_M(3)*EST_PASS_M3*      (2545
/128500/0.3)*128500 * 146.611 /10^6;
EST1_CH4_M4      =      HP_T(5)*HRS_PER_AC_M(4)*EST_PASS_M4*      (2545
/115500/0.4)*115500 * 108.266 /10^6;
EST1_CH4_TOTAL = EST1_CH4_M1 + EST1_CH4_M2 + EST1_CH4_M3 + EST1_CH4_M4;

```

```

EST1_CO2 = EST1_CO2_TOTAL/(YIELD * 907.1847);
EST1_N2O = EST1_N2O_TOTAL/(YIELD * 907.1847);
EST1_CH4 = EST1_CH4_TOTAL/(YIELD * 907.1847);

```

```

EST1_CO2_FINAL = EST1_CO2 /STANDLIFE *(1+RESEED);
EST1_N2O_FINAL = EST1_N2O /STANDLIFE *(1+RESEED);
EST1_CH4_FINAL = EST1_CH4 /STANDLIFE *(1+RESEED);
EST1_CO2_EQ = EST1_CO2_FINAL + 296 * EST1_N2O_FINAL + 23 *
EST1_CH4_FINAL;

```

```
!ESTABLISHMENT 2;
```

```

EST_PASS_M5 = 2;
EST_PASS_M6 = 1;
EST2_MAC_HOURS      =      HRS_PER_AC_M(5)*EST_PASS_M5
+HRS_PER_AC_M(6)*EST_PASS_M6;
LABOR_5 = HRS_PER_AC_M(5) * LABOR_TO_MACHINE;
LABOR_6 = HRS_PER_AC_M(6) * LABOR_TO_MACHINE;

```

```

PASS_L5 = LABOR_5 * EST_PASS_M5;
PASS_L6 = LABOR_6 * EST_PASS_M6;
EST2_LAB_HOURS = PASS_L5 + PASS_L6 ;
EST2_VARIABLE = IN_VARIABLE_5*EST_PASS_M5 +IN_VARIABLE_6*EST_PASS_M6;
EST2_FIXED = IN_FIXED_5*EST_PASS_M5 +IN_FIXED_6*EST_PASS_M6;
EST2_UNALLOCATED_LAB = EST2_LAB_HOURS *UNALLOCATED_LABOR_TO_MAC ;

!VARIABLE COSTS FOR ESTABLISHMENT 2;
ATRAZINE_EST2 = 9.69*HERBICIDE*SIZE_OF_ENTERPRISE ;
NITROGEN_EST2 = 0.32*NITROGEN*SIZE_OF_ENTERPRISE;
P2O5_EST2 = 0.27*P2O5*SIZE_OF_ENTERPRISE;
K2O_EST2 = 0.15*K2O*SIZE_OF_ENTERPRISE;
LIME_EST2 = 22.50*LIME*SIZE_OF_ENTERPRISE;
SOIL_EST2 = 7*SOIL*SIZE_OF_ENTERPRISE;
SEED_EST2 = 7*SEEDS*SIZE_OF_ENTERPRISE;
TRACTOR_EST2 = EST2_VARIABLE*TRACTOR*SIZE_OF_ENTERPRISE;
EST2_TOTAL_VARIABLE = ATRAZINE_EST2 + NITROGEN_EST2 + P2O5_EST2 +
K2O_EST2 +LIME_EST2 +SOIL_EST2 + SEED_EST2 +TRACTOR_EST2;

!FIXED COSTS FOR ESTABLISHMENT 2;
TRACTOR_EQUIP_EST2 = EST2_FIXED*TRACTOR*SIZE_OF_ENTERPRISE;
EST2_GENERALOVERHEAD = EST2_TOTAL_VARIABLE*GENERALOVERHEAD;
EST2_TOTAL_FIXED = TRACTOR_EQUIP_EST2 + EST2_GENERALOVERHEAD;

!LABOR COSTS FOR ESTABLISHMENT 2;
EST2_TOTAL_LABOR = (EST2_LAB_HOURS +
EST2_UNALLOCATED_LAB)*SIZE_OF_ENTERPRISE*LABOR_WAGE;

!TOTAL OF ALL COSTS FOR ESTABLISHMENT 2;
EST2_TOTAL_COST = EST2_TOTAL_VARIABLE + EST2_TOTAL_FIXED +
EST2_TOTAL_LABOR;
EST2_AMORITIZED_COST = (INTEREST/(1-
(1/(1+INTEREST)^STANDLIFE)))*EST2_TOTAL_COST;

! GHG FROM ESTABLISHMENT 2;
EST2_CO2_M5 = HP_T(1)*HRS_PER_AC_M(5)*EST_PASS_M5* (2545
/115500/0.3)*115500 * 92614 /10^6;
EST2_CO2_M6 = HP_T(5)*HRS_PER_AC_M(6)*EST_PASS_M6* (2545
/128500/0.4)*128500 * 94495 /10^6;
EST2_CO2_TOTAL = EST2_CO2_M5 + EST2_CO2_M6;
EST2_N2O_M5 = HP_T(1)*HRS_PER_AC_M(5)*EST_PASS_M5* (2545
/115500/0.3)*115500 * 2.263 /10^6;
EST2_N2O_M6 = HP_T(5)*HRS_PER_AC_M(6)*EST_PASS_M6* (2545
/128500/0.4)*128500 * 2.201 /10^6;
EST2_N2O_TOTAL = EST2_N2O_M5 + EST2_N2O_M6 ;
EST2_CH4_M5 = HP_T(1)*HRS_PER_AC_M(5)*EST_PASS_M5* (2545
/115500/0.3)*115500 * 146.611 /10^6;
EST2_CH4_M6 = HP_T(5)*HRS_PER_AC_M(6)*EST_PASS_M6* (2545
/128500/0.4)*128500 * 108.266 /10^6;
EST2_CH4_TOTAL = EST2_CH4_M5 + EST2_CH4_M6;
EST2_CO2 = EST2_CO2_TOTAL/(YIELD * 907.1847);
EST2_N2O = EST2_N2O_TOTAL/(YIELD * 907.1847);
EST2_CH4 = EST2_CH4_TOTAL/(YIELD * 907.1847);

```



```

EST2_CO2_FINAL = EST2_CO2 /STANDLIFE *(1+RESEED);
EST2_N2O_FINAL = EST2_N2O /STANDLIFE *(1+RESEED);
EST2_CH4_FINAL = EST2_CH4 /STANDLIFE *(1+RESEED);
EST2_CO2_EQ   = EST2_CO2_FINAL   + 296 * EST2_N2O_FINAL   + 23 *
EST2_CH4_FINAL;

```

```
!MAINTENANCE;
```

```

MAN_PASS_M7 = 1;
MAN_PASS_M8 = 1;
MAN_MAC_HOURS           =           HRS_PER_AC_M(7)*MAN_PASS_M7
+HRS_PER_AC_M(8)*MAN_PASS_M8;
LABOR_7 = HRS_PER_AC_M(7) * LABOR_TO_MACHINE;
LABOR_8 = HRS_PER_AC_M(8) * LABOR_TO_MACHINE;
PASS_L7 = LABOR_7 * MAN_PASS_M7;
PASS_L8 = LABOR_8 * MAN_PASS_M8;
MAN_LAB_HOURS = PASS_L7 + PASS_L8 ;
MAN_VARIABLE = IN_VARIABLE_7*MAN_PASS_M7 +IN_VARIABLE_8*MAN_PASS_M8;
MAN_FIXED = IN_FIXED_7*MAN_PASS_M7 +IN_FIXED_8*MAN_PASS_M8;
MAN_UNALLOCATED_LAB = MAN_LAB_HOURS *UNALLOCATED_LABOR_TO_MAC ;

```

```
!VARIABLE COSTS FOR MAINTENANCE;
```

```

NITROGEN_MAN = 0.32*NITROGEN*SIZE_OF_ENTERPRISE;
P2O5_MAN = 0.27*P2O5*SIZE_OF_ENTERPRISE;
K2O_MAN = 0.15*K2O*SIZE_OF_ENTERPRISE;
SOIL_MAN = 7*SOIL*SIZE_OF_ENTERPRISE;
TRACTOR_MAN = MAN_VARIABLE*TRACTOR*SIZE_OF_ENTERPRISE;
MAN_INTEREST = (NITROGEN_MAN + P2O5_MAN + K2O_MAN + SOIL_MAN +
TRACTOR_MAN )*6/12 * INTEREST;
MAN_TOTAL_VARIABLE = NITROGEN_MAN + P2O5_MAN + K2O_MAN +SOIL_MAN
+TRACTOR_MAN + MAN_INTEREST;

```

```
!FIXED COSTS FOR MAINTENANCE;
```

```

TRACTOR_EQUIP_MAN = MAN_FIXED*TRACTOR*SIZE_OF_ENTERPRISE;
MAN_GENERALOVERHEAD = MAN_TOTAL_VARIABLE*GENERALOVERHEAD;
MAN_EST1 = EST1_AMORITIZED_COST *SIZE_OF_ENTERPRISE;
MAN_EST2 = EST2_AMORITIZED_COST *SIZE_OF_ENTERPRISE;
MAN_TOTAL_FIXED_PASTURE           =           TRACTOR_EQUIP_MAN           +
MAN_GENERALOVERHEAD+MAN_EST1 ;
MAN_TOTAL_FIXED_RECROP           =           TRACTOR_EQUIP_MAN           +
MAN_GENERALOVERHEAD+MAN_EST2 ;

```

```
!LABOR COSTS FOR MAINTENANCE;
```

```

MAN_TOTAL_LABOR           =           (MAN_LAB_HOURS           +
MAN_UNALLOCATED_LAB)*SIZE_OF_ENTERPRISE*LABOR_WAGE;

```

```
!LAND RENT FOR MAINTENANCE WHEN PASTURE IS USED;
```

```
MAN_LAND_PASTURE = SIZE_OF_ENTERPRISE * RENTAL_PASTURE;
```

```
!LAND RENT FOR MAINTENANCE WHEN RECROP IS USED;
```

```
MAN_LAND_RECROP = SIZE_OF_ENTERPRISE * RENTAL_RECROP;
```

```
!TOTAL OF ALL COSTS FOR MAINTENANCE;
```

```

MAN_TOTAL_COST_PASTURE = MAN_TOTAL_VARIABLE + MAN_TOTAL_FIXED_PASTURE +
MAN_TOTAL_LABOR + MAN_LAND_PASTURE;

```

```
MAN_TOTAL_COST_RECROP = MAN_TOTAL_VARIABLE + MAN_TOTAL_FIXED_RECROP +
MAN_TOTAL_LABOR + MAN_LAND_RECROP;
```

```
! GHG FROM MAINTENANCE;
```

```
MAN_CO2_M7 = HP_T(1)*HRS_PER_AC_M(7)*MAN_PASS_M7* (2545
/115500/0.3)*115500 * 92614 /10^6;
MAN_CO2_M8 = HP_T(2)*HRS_PER_AC_M(8)*MAN_PASS_M8* (2545
/128500/0.4)*128500 * 94495 /10^6;
MAN_CO2_TOTAL = MAN_CO2_M7 + MAN_CO2_M8;
MAN_N2O_M7 = HP_T(1)*HRS_PER_AC_M(7)*MAN_PASS_M7* (2545
/115500/0.3)*115500 * 2.263 /10^6;
MAN_N2O_M8 = HP_T(2)*HRS_PER_AC_M(8)*MAN_PASS_M8* (2545
/128500/0.4)*128500 * 2.201 /10^6;
MAN_N2O_TOTAL = MAN_N2O_M7 + MAN_N2O_M8 ;
MAN_CH4_M7 = HP_T(1)*HRS_PER_AC_M(7)*EST_PASS_M7* (2545
/115500/0.3)*115500 * 146.611 /10^6;
MAN_CH4_M8 = HP_T(2)*HRS_PER_AC_M(8)*EST_PASS_M8* (2545
/128500/0.4)*128500 * 108.266 /10^6;
MAN_CH4_TOTAL = MAN_CH4_M7 + MAN_CH4_M8;
MAN_CO2 = MAN_CO2_TOTAL/(YIELD * 907.1847);
MAN_N2O = MAN_N2O_TOTAL/(YIELD * 907.1847);
MAN_CH4 = MAN_CH4_TOTAL/(YIELD * 907.1847);
MAN_CO2_FINAL = MAN_CO2 ;
MAN_N2O_FINAL = MAN_N2O ;
MAN_CH4_FINAL = MAN_CH4 ;
MAN_CO2_EQ = MAN_CO2_FINAL + 296 * MAN_N2O_FINAL + 23 * MAN_CH4_FINAL;
```

```
!HARVEST1;
```

```
HAR1_PASS_M9 = 1;
HAR1_PASS_M10 = 1;
HAR1_PASS_M11 = 1;
HAR1_PASS_M12 = 1;
HAR1_MAC_HOURS = HRS_PER_AC_M(9)*HAR1_PASS_M9
+HRS_PER_AC_M(10)*HAR1_PASS_M10+HRS_PER_AC_M_11*HAR1_PASS_M11+0.3 *
HAR1_PASS_M12;
LABOR_9 = HRS_PER_AC_M(9) * LABOR_TO_MACHINE;
LABOR_10 = HRS_PER_AC_M(10) * LABOR_TO_MACHINE;
LABOR_11 = HRS_PER_AC_M_11 * LABOR_TO_MACHINE;
LABOR_12 = 0.3 * LABOR_TO_MACHINE;
PASS_L9 = LABOR_9 * HAR1_PASS_M9;
PASS_L10 = LABOR_10 * HAR1_PASS_M10;
PASS_L11 = LABOR_11 * HAR1_PASS_M11;
PASS_L12 = LABOR_12 * HAR1_PASS_M12;
HAR1_LAB_HOURS = PASS_L9 + PASS_L10+ PASS_L11 + PASS_L12 ;
HAR1_VARIABLE = IN_VARIABLE_9*HAR1_PASS_M9
+IN_VARIABLE_10*HAR1_PASS_M10 +EX_VARIABLE_11*HAR1_PASS_M11 +
VARIABLE_COST_M(12)*HAR1_PASS_M12;
HAR1_FIXED = IN_FIXED_9*HAR1_PASS_M9 +IN_FIXED_10*HAR1_PASS_M10 +
EX_FIXED_11*HAR1_PASS_M11 + FIXED_COST_M(12)*HAR1_PASS_M12;
HAR1_UNALLOCATED_LAB = HAR1_LAB_HOURS *UNALLOCATED_LABOR_TO_MAC ;
```

```
!VARIABLE COSTS FOR HARVEST 1;
```

```
TRACTOR_HAR1 = HAR1_VARIABLE*TRACTOR*SIZE_OF_ENTERPRISE;
HAR1_TOTAL_VARIABLE = TRACTOR_HAR1 ;
```

```

!FIXED COSTS FOR HARVEST 1;
TRACTOR_EQUIP_HAR1 = HAR1_FIXED*TRACTOR*SIZE_OF_ENTERPRISE;
HAR1_GENERALOVERHEAD = HAR1_TOTAL_VARIABLE*GENERALOVERHEAD;
HAR1_TOTAL_FIXED= TRACTOR_EQUIP_HAR1 + HAR1_GENERALOVERHEAD;

!LABOR COSTS FOR HARVEST 1;
HAR1_TOTAL_LABOR           =                (HAR1_LAB_HOURS           +
HAR1_UNALLOCATED_LAB)*SIZE_OF_ENTERPRISE*LABOR_WAGE;

!TOTAL OF ALL COSTS FOR HARVEST 1;
HAR1_TOTAL_COST           =                HAR1_TOTAL_VARIABLE       +                HAR1_TOTAL_FIXED+
HAR1_TOTAL_LABOR ;

! GHG FROM HARVEST 1;
HAR1_CO2_M9               =                HP_T(2)*HRS_PER_AC_M(9)*HAR1_PASS_M9*                (2545
/128500/0.4)*128500 * 94495 /10^6;
HAR1_CO2_M10              =                HP_T(3)*HRS_PER_AC_M(10)*HAR1_PASS_M10*                (2545
/128500/0.4)*128500 * 94495 /10^6;
HAR1_CO2_M11              =                125 *HRS_PER_AC_M_11*HAR1_PASS_M11*                (2545
/115500/0.3)*115500 * 95167.35 /10^6;
HAR1_CO2_M12              =                HP_T(1)*0.3*HAR1_PASS_M12* (2545 /115500/0.3)*115500 *
92614 /10^6;
HAR1_CO2_TOTAL            =                HAR1_CO2_M9      +                HAR1_CO2_M10      +                HAR1_CO2_M11      +
HAR1_CO2_M12;
HAR1_N2O_M9               =                HP_T(2)*HRS_PER_AC_M(9)*HAR1_PASS_M9*                (2545
/128500/0.4)*128500 * 2.201 /10^6;
HAR1_N2O_M10              =                HP_T(3)*HRS_PER_AC_M(10)*HAR1_PASS_M10*                (2545
/128500/0.4)*128500 * 2.201 /10^6;
HAR1_N2O_M11              =                125 *HRS_PER_AC_M_11*HAR1_PASS_M11*                (2545
/115500/0.3)*115500 * 5.249909 /10^6;
HAR1_N2O_M12              =                HP_T(1)*0.3*HAR1_PASS_M12* (2545 /115500/0.3)*115500 *
2.263 /10^6;
HAR1_N2O_TOTAL            =                HAR1_N2O_M9      +                HAR1_N2O_M10      +                HAR1_N2O_M11      +
HAR1_N2O_M12;
HAR1_CH4_M9               =                HP_T(2)*HRS_PER_AC_M(9)*HAR1_PASS_M9*                (2545
/128500/0.4)*128500 * 108.266 /10^6;
HAR1_CH4_M10              =                HP_T(3)*HRS_PER_AC_M(10)*HAR1_PASS_M10*                (2545
/128500/0.4)*128500 * 108.266 /10^6;
HAR1_CH4_M11              =                125 *HRS_PER_AC_M_11*HAR1_PASS_M11*                (2545
/115500/0.3)*115500 * 124.0215 /10^6;
HAR1_CH4_M12              =                HP_T(1)*0.3*HAR1_PASS_M12* (2545 /115500/0.3)*115500 *
146.611 /10^6;
HAR1_CH4_TOTAL            =                HAR1_CH4_M9      +                HAR1_CH4_M10      +                HAR1_CH4_M11      +
HAR1_CH4_M12;
HAR1_CO2                   =                HAR1_CO2_TOTAL/(YIELD * 907.1847);
HAR1_N2O                    =                HAR1_N2O_TOTAL/(YIELD * 907.1847);
HAR1_CH4                    =                HAR1_CH4_TOTAL/(YIELD * 907.1847);
HAR1_CO2_FINAL              =                HAR1_CO2 ;
HAR1_N2O_FINAL              =                HAR1_N2O ;
HAR1_CH4_FINAL              =                HAR1_CH4 ;
HAR1_CO2_EQ                 =                HAR1_CO2_FINAL      +                296 *                HAR1_N2O_FINAL      +                23 *
HAR1_CH4_FINAL;

```

```

!HARVEST 2;
HAR2_PASS_M13 = 1;
HAR2_PASS_M14 = 1;
HAR2_MAC_HOURS = HRS_PER_AC_M_13*HAR2_PASS_M13
+HRS_PER_AC_M_14*HAR2_PASS_M14;
LABOR_13 = HRS_PER_AC_M_13 * LABOR_TO_MACHINE;
LABOR_14 = HRS_PER_AC_M_14 * LABOR_TO_MACHINE;
PASS_L13 = LABOR_13 * HAR2_PASS_M13;
PASS_L14 = LABOR_14 * HAR2_PASS_M14;
HAR2_LAB_HOURS = PASS_L13 + PASS_L14 ;
HAR2_VARIABLE = IN_VARIABLE_13*HAR2_PASS_M13
+IN_VARIABLE_14*HAR2_PASS_M14;
HAR2_FIXED = IN_FIXED_13*HAR2_PASS_M13 +IN_FIXED_14*HAR2_PASS_M14 ;
HAR2_UNALLOCATED_LAB = HAR2_LAB_HOURS *UNALLOCATED_LABOR_TO_MAC ;

!VARIABLE COSTS FOR HARVEST 2;
TRACTOR_HAR2 = HAR2_VARIABLE*TRACTOR*SIZE_OF_ENTERPRISE;
HAR2_TOTAL_VARIABLE = TRACTOR_HAR2 ;

!FIXED COSTS FOR HARVEST 2;
TRACTOR_EQUIP_HAR2 = HAR2_FIXED*TRACTOR*SIZE_OF_ENTERPRISE;
HAR2_GENERALOVERHEAD = HAR2_TOTAL_VARIABLE*GENERALOVERHEAD;
HAR2_TOTAL_FIXED= TRACTOR_EQUIP_HAR2 + HAR2_GENERALOVERHEAD;

!LABOR COSTS FOR HARVEST 2;
HAR2_TOTAL_LABOR = (HAR2_LAB_HOURS +
HAR2_UNALLOCATED_LAB)*SIZE_OF_ENTERPRISE*LABOR_WAGE;

!TOTAL OF ALL COSTS FOR HARVEST 2;
HAR2_TOTAL_COST = HAR2_TOTAL_VARIABLE + HAR2_TOTAL_FIXED+
HAR2_TOTAL_LABOR ;

! GHG FROM HARVEST 2;
HAR2_CO2_M13 = HP_T(2)*HRS_PER_AC_M_13*HAR2_PASS_M13* (2545
/128500/0.4)*128500 * 94495 /10^6;
HAR2_CO2_M14 = HP_T(5)*HRS_PER_AC_M_14*HAR2_PASS_M14* (2545
/128500/0.4)*128500 * 94495 /10^6;
HAR2_CO2_TOTAL = HAR2_CO2_M13 + HAR2_CO2_M14 ;
HAR2_N2O_M13 = HP_T(2)*HRS_PER_AC_M_13*HAR2_PASS_M13* (2545
/128500/0.4)*128500 * 2.201 /10^6;
HAR2_N2O_M14 = HP_T(5)*HRS_PER_AC_M_14*HAR2_PASS_M14* (2545
/128500/0.4)*128500 * 2.201 /10^6;
HAR2_N2O_TOTAL = HAR2_N2O_M13 + HAR2_N2O_M14 ;
HAR2_CH4_M13 = HP_T(2)*HRS_PER_AC_M_13*HAR2_PASS_M13* (2545
/128500/0.4)*128500 * 108.266 /10^6;
HAR2_CH4_M14 = HP_T(5)*HRS_PER_AC_M_14*HAR2_PASS_M14* (2545
/128500/0.4)*128500 * 108.266/10^6;
HAR2_CH4_TOTAL = HAR2_CH4_M13 + HAR2_CH4_M14 ;
HAR2_CO2 = HAR2_CO2_TOTAL/(YIELD * 907.1847);
HAR2_N2O = HAR2_N2O_TOTAL/(YIELD * 907.1847);
HAR2_CH4 = HAR2_CH4_TOTAL/(YIELD * 907.1847);
HAR2_CO2_FINAL = HAR2_CO2 ;
HAR2_N2O_FINAL = HAR2_N2O ;
HAR2_CH4_FINAL = HAR2_CH4 ;

```

```
HAR2_CO2_EQ = HAR2_CO2_FINAL + 296 * HAR2_N2O_FINAL + 23 *
HAR2_CH4_FINAL;
```

```
!TRANSPORT 1;
```

```
TRAN1_PASS_M15 = 1;
TRAN1_PASS_M16 = 1;
TRAN1_PASS_M17 = 1;
TRAN1_MAC_HOURS = HRS_PER_AC_M_15 * TRAN1_PASS_M15 +
HRS_PER_AC_M_16*TRAN1_PASS_M16 + HRS_PER_AC_M_17*TRAN1_PASS_M17;
LABOR_15 = HRS_PER_AC_M_15 * LABOR_TO_MACHINE;
LABOR_16 = HRS_PER_AC_M_16 * LABOR_TO_MACHINE;
LABOR_17 = HRS_PER_AC_M_17 * LABOR_TO_MACHINE;
PASS_L15 = LABOR_15 * TRAN1_PASS_M15;
PASS_L16 = LABOR_16 * TRAN1_PASS_M16;
PASS_L17 = LABOR_17 * TRAN1_PASS_M17;
TRAN1_LAB_HOURS = PASS_L15 + PASS_L16 + PASS_L17 ;
TRAN1_VARIABLE = EX_VARIABLE_15*TRAN1_PASS_M15
+IN_VARIABLE_16*TRAN1_PASS_M16 + EX_VARIABLE_17 * TRAN1_PASS_M17;
TRAN1_FIXED = EX_FIXED_15*TRAN1_PASS_M15 +IN_FIXED_16*TRAN1_PASS_M16 +
EX_FIXED_17*TRAN1_PASS_M17 ;
TRAN1_UNALLOCATED_LAB = TRAN1_LAB_HOURS *UNALLOCATED_LABOR_TO_MAC ;
```

```
!VARIABLE COSTS FOR TRANSPORT 1;
```

```
TRAN1_HAR1 = SIZE_OF_ENTERPRISE* HAR1_TOTAL_COST;
TRACTOR_TRAN1 = TRAN1_VARIABLE*TRACTOR*SIZE_OF_ENTERPRISE;
TRAN1_TOTAL_VARIABLE = TRACTOR_TRAN1 +TRAN1_HAR1 ;
```

```
!FIXED COSTS FOR TRANSPORT 1;
```

```
TRACTOR_EQUIP_TRAN1 = TRAN1_FIXED*TRACTOR*SIZE_OF_ENTERPRISE;
TRAN1_GENERALOVERHEAD = TRAN1_TOTAL_VARIABLE*GENERALOVERHEAD;
TRAN1_TOTAL_FIXED= TRACTOR_EQUIP_TRAN1 + TRAN1_GENERALOVERHEAD;
```

```
!LABOR COSTS FOR TRANSPORT 1;
```

```
TRAN1_TOTAL_LABOR = (TRAN1_LAB_HOURS +
TRAN1_UNALLOCATED_LAB)*SIZE_OF_ENTERPRISE*LABOR_WAGE;
```

```
!TOTAL OF ALL COSTS FOR TRANSPORT 1;
```

```
TRAN1_TOTAL_COST = TRAN1_TOTAL_VARIABLE + TRAN1_TOTAL_FIXED+
TRAN1_TOTAL_LABOR ;
```

```
! GHG FROM TRANSPORT 1;
```

```
TRAN1_CO2_M15 = 400*HRS_PER_AC_M_15*TRAN1_PASS_M15* (2545
/128500/0.4)*128500 * 94234 /10^6;
TRAN1_CO2_M16 = HP_T(2)*HRS_PER_AC_M_16*TRAN1_PASS_M16* (2545
/128500/0.4)*128500 * 94495 /10^6;
TRAN1_CO2_M17 = HP_T(1)*HRS_PER_AC_M_17*TRAN1_PASS_M17* (2545
/115500/0.3)*115500 * 92614 /10^6;
TRAN1_CO2_TOTAL = TRAN1_CO2_M15 + TRAN1_CO2_M16 +TRAN1_CO2_M17 ;
TRAN1_N2O_M15 = 400*HRS_PER_AC_M_15*TRAN1_PASS_M15* (2545
/128500/0.4)*128500 * 2.201 /10^6;
TRAN1_N2O_M16 = HP_T(2)*HRS_PER_AC_M_16*TRAN1_PASS_M16* (2545
/128500/0.4)*128500 * 2.201 /10^6;
TRAN1_N2O_M17 = HP_T(1)*HRS_PER_AC_M_17*TRAN1_PASS_M17* (2545
/115500/0.3)*115500 * 2.263 /10^6;
```

```

TRAN1_N2O_TOTAL = TRAN1_N2O_M15 + TRAN1_N2O_M16 +TRAN1_N2O_M17 ;
TRAN1_CH4_M15    =      400*HRS_PER_AC_M_15*TRAN1_PASS_M15*      (2545
/128500/0.4)*128500 * 108.266 /10^6;
TRAN1_CH4_M16    =      HP_T(2)*HRS_PER_AC_M_16*TRAN1_PASS_M16*      (2545
/128500/0.4)*128500 * 108.266 /10^6;
TRAN1_CH4_M17    =      HP_T(1)*HRS_PER_AC_M_17*TRAN1_PASS_M17*      (2545
/115500/0.3)*115500 * 146.611 /10^6;
TRAN1_CH4_TOTAL = TRAN1_CH4_M15 + TRAN1_CH4_M16 +TRAN1_CH4_M17 ;
TRAN1_CO2 = TRAN1_CO2_TOTAL/(YIELD * 907.1847);
TRAN1_N2O = TRAN1_N2O_TOTAL/(YIELD * 907.1847);
TRAN1_CH4 = TRAN1_CH4_TOTAL/(YIELD * 907.1847);
TRAN1_CO2_FINAL = TRAN1_CO2 ;
TRAN1_N2O_FINAL = TRAN1_N2O ;
TRAN1_CH4_FINAL = TRAN1_CH4 ;
TRAN1_CO2_EQ = TRAN1_CO2_FINAL + 296 * TRAN1_N2O_FINAL + 23 *
TRAN1_CH4_FINAL;

!TRANSPORT 2;
TRAN2_PASS_M18 = 1;
TRAN2_PASS_M19 = 1;
TRAN2_PASS_M20 = 1;
TRAN2_MAC_HOURS =      HRS_PER_AC_M_18      *      TRAN2_PASS_M18      +
HRS_PER_AC_M_19*TRAN2_PASS_M19 + HRS_PER_AC_M_20*TRAN2_PASS_M20;
LABOR_18 = HRS_PER_AC_M_18 * LABOR_TO_MACHINE;
LABOR_19 = HRS_PER_AC_M_19 * LABOR_TO_MACHINE;
LABOR_20 = HRS_PER_AC_M_20 * LABOR_TO_MACHINE;
PASS_L18 = LABOR_18 * TRAN2_PASS_M18;
PASS_L19 = LABOR_19 * TRAN2_PASS_M19;
PASS_L20 = LABOR_20 * TRAN2_PASS_M20;
TRAN2_LAB_HOURS = PASS_L18 + PASS_L19 + PASS_L20 ;
TRAN2_VARIABLE =      EX_VARIABLE_18*TRAN2_PASS_M18
+EX_VARIABLE_19*TRAN2_PASS_M19 + EX_VARIABLE_20 * TRAN2_PASS_M20;
TRAN2_FIXED = EX_FIXED_18*TRAN2_PASS_M18 +EX_FIXED_19*TRAN2_PASS_M19 +
EX_FIXED_20*TRAN2_PASS_M20 ;
TRAN2_UNALLOCATED_LAB = TRAN2_LAB_HOURS *UNALLOCATED_LABOR_TO_MAC ;

!VARIABLE COSTS FOR TRANSPORT 2;
TRAN2_HAR2 = SIZE_OF_ENTERPRISE* HAR2_TOTAL_COST;
TRACTOR_TRAN2 = TRAN2_VARIABLE*TRACTOR*SIZE_OF_ENTERPRISE;
TRAN2_TOTAL_VARIABLE = TRACTOR_TRAN2 +TRAN2_HAR2 ;

!FIXED COSTS FOR TRANSPORT 2;
TRACTOR_EQUIP_TRAN2 = TRAN2_FIXED*TRACTOR*SIZE_OF_ENTERPRISE;
TRAN2_GENERALOVERHEAD = TRAN2_TOTAL_VARIABLE*GENERALOVERHEAD;
TRAN2_TOTAL_FIXED= TRACTOR_EQUIP_TRAN2 + TRAN2_GENERALOVERHEAD;

!LABOR COSTS FOR TRANSPORT 2;
TRAN2_TOTAL_LABOR =      (TRAN2_LAB_HOURS      +
TRAN2_UNALLOCATED_LAB)*SIZE_OF_ENTERPRISE*LABOR_WAGE;

!TOTAL OF ALL COSTS FOR TRANSPORT 2;
TRAN2_TOTAL_COST =      TRAN2_TOTAL_VARIABLE      +      TRAN2_TOTAL_FIXED+
TRAN2_TOTAL_LABOR ;

```

## ! GHG FROM TRANSPORT 2;

```

HRS_PER_AC_M_NEW_18 = (1+2*DIST/TRUCK_SPEED)*(YIELD/LOOSECHOP);
TRAN2_CO2_M18      = 400*HRS_PER_AC_M_NEW_18*TRAN2_PASS_M18*      (2545
/(128500*0.4))*128500 * 94234 /10^6;
TRAN2_CO2_M19      = HP_T(2)*HRS_PER_AC_M_19*TRAN2_PASS_M19*      (2545
/(128500*0.4))*128500 * 94495 /10^6;
TRAN2_CO2_M20      = HP_T(1)*HRS_PER_AC_M_20*TRAN2_PASS_M20*      (2545
/(115500*0.3))*115500 * 92614 /10^6;
TRAN2_CO2_TOTAL    = TRAN2_CO2_M18 + TRAN2_CO2_M19 +TRAN2_CO2_M20 ;
TRAN2_N2O_M18      = 400*HRS_PER_AC_M_NEW_18*TRAN2_PASS_M18*      (2545
/128500/0.4)*128500 * 2.201 /10^6;
TRAN2_N2O_M19      = HP_T(2)*HRS_PER_AC_M_19*TRAN2_PASS_M19*      (2545
/128500/0.4)*128500 * 2.201 /10^6;
TRAN2_N2O_M20      = HP_T(1)*HRS_PER_AC_M_20*TRAN2_PASS_M20*      (2545
/115500/0.3)*115500 * 2.263 /10^6;
TRAN2_N2O_TOTAL    = TRAN2_N2O_M18 + TRAN2_N2O_M19 +TRAN2_N2O_M20 ;
TRAN2_CH4_M18      = 400*HRS_PER_AC_M_NEW_18*TRAN2_PASS_M18*      (2545
/128500/0.4)*128500 * 108.266 /10^6;
TRAN2_CH4_M19      = HP_T(2)*HRS_PER_AC_M_19*TRAN2_PASS_M19*      (2545
/128500/0.4)*128500 * 108.266 /10^6;
TRAN2_CH4_M20      = HP_T(1)*HRS_PER_AC_M_20*TRAN2_PASS_M20*      (2545
/115500/0.3)*115500 * 146.611 /10^6;
TRAN2_CH4_TOTAL    = TRAN2_CH4_M18 + TRAN2_CH4_M19 +TRAN2_CH4_M20 ;
TRAN2_CO2           = TRAN2_CO2_TOTAL/(YIELD * 907.1847);
TRAN2_N2O           = TRAN2_N2O_TOTAL/(YIELD * 907.1847);
TRAN2_CH4           = TRAN2_CH4_TOTAL/(YIELD * 907.1847);
TRAN2_CO2_FINAL     = TRAN2_CO2 ;
TRAN2_N2O_FINAL     = TRAN2_N2O ;
TRAN2_CH4_FINAL     = TRAN2_CH4 ;
TRAN2_CO2_EQ        = TRAN2_CO2_FINAL + 296 * TRAN2_N2O_FINAL + 23 *
TRAN2_CH4_FINAL;

```

## !TRANSPORT 3;

```

TRAN3_PASS_M21 = 1;
TRAN3_PASS_M22 = 1;
TRAN3_PASS_M23 = 1;
TRAN3_MAC_HOURS = HRS_PER_AC_M_21 * TRAN3_PASS_M21 +
HRS_PER_AC_M_22*TRAN3_PASS_M22 + HRS_PER_AC_M_23*TRAN3_PASS_M23;
LABOR_21 = HRS_PER_AC_M_21 * LABOR_TO_MACHINE;
LABOR_22 = HRS_PER_AC_M_22 * LABOR_TO_MACHINE;
LABOR_23 = HRS_PER_AC_M_23 * LABOR_TO_MACHINE;
PASS_L21 = LABOR_21 * TRAN3_PASS_M21;
PASS_L22 = LABOR_22 * TRAN3_PASS_M22;
PASS_L23 = LABOR_23 * TRAN3_PASS_M23;
TRAN3_LAB_HOURS = PASS_L21 + PASS_L22 + PASS_L23 ;
TRAN3_VARIABLE = EX_VARIABLE_21*TRAN3_PASS_M21
+EX_VARIABLE_22*TRAN3_PASS_M22 + EX_VARIABLE_23 * TRAN3_PASS_M23;
TRAN3_FIXED = EX_FIXED_21*TRAN3_PASS_M21 +EX_FIXED_22*TRAN3_PASS_M22 +
EX_FIXED_23*TRAN3_PASS_M23 ;
TRAN3_UNALLOCATED_LAB = TRAN3_LAB_HOURS *UNALLOCATED_LABOR_TO_MAC ;

```

## !VARIABLE COSTS FOR TRANSPORT 3;

```

TRAN3_HAR2 = SIZE_OF_ENTERPRISE* HAR2_TOTAL_COST;
TRACTOR_TRAN3 = TRAN3_VARIABLE*TRACTOR*SIZE_OF_ENTERPRISE;

```

```

TRAN3_TOTAL_VARIABLE = TRACTOR_TRAN3 +TRAN3_HAR2 ;

!FIXED COSTS FOR TRANSPORT 3;
TRACTOR_EQUIP_TRAN3 = TRAN3_FIXED*TRACTOR*SIZE_OF_ENTERPRISE;
TRAN3_GENERALOVERHEAD = TRAN3_TOTAL_VARIABLE*GENERALOVERHEAD;
TRAN3_TOTAL_FIXED= TRACTOR_EQUIP_TRAN3 + TRAN3_GENERALOVERHEAD;

!LABOR COSTS FOR TRANSPORT 3;
TRAN3_TOTAL_LABOR = (TRAN3_LAB_HOURS +
TRAN3_UNALLOCATED_LAB)*SIZE_OF_ENTERPRISE*LABOR_WAGE;

!TOTAL OF ALL COSTS FOR TRANSPORT 3;
TRAN3_TOTAL_COST = TRAN3_TOTAL_VARIABLE + TRAN3_TOTAL_FIXED+
TRAN3_TOTAL_LABOR ;

! GHG FROM TRANSPORT 3;
TRAN3_CO2_M21 = 130*HRS_PER_AC_M_21*TRAN3_PASS_M21* (2545
/(115500*0.3))*115500 * 95167.35 /10^6;
TRAN3_CO2_M22 = 65*HRS_PER_AC_M_22*TRAN3_PASS_M22* (2545
/(115500*0.3))*115500 * 95167.35 /10^6;
TRAN3_CO2_M23 = 140*HRS_PER_AC_M_23*TRAN3_PASS_M23* (2545
/(128500*0.4))*128500 * 95337.84 /10^6;
TRAN3_CO2_TOTAL = TRAN3_CO2_M21 + TRAN3_CO2_M22 +TRAN3_CO2_M23 ;
TRAN3_N2O_M21 = 130*HRS_PER_AC_M_21*TRAN3_PASS_M21* (2545
/(115500*0.3))*115500 * 5.249909 /10^6;
TRAN3_N2O_M22 = 65*HRS_PER_AC_M_22*TRAN3_PASS_M22* (2545
/(115500*0.3))*115500 * 5.249909 /10^6;
TRAN3_N2O_M23 = 140*HRS_PER_AC_M_23*TRAN3_PASS_M23* (2545
/(128500*0.4))*128500 * 5.587299 /10^6;
TRAN3_N2O_TOTAL = TRAN3_N2O_M21 + TRAN3_N2O_M22 +TRAN3_N2O_M23 ;
TRAN3_CH4_M21 = 130*HRS_PER_AC_M_21*TRAN3_PASS_M21* (2545
/(115500*0.3))*115500 * 124.0215 /10^6;
TRAN3_CH4_M22 = 65*HRS_PER_AC_M_22*TRAN3_PASS_M22* (2545
/(115500*0.3))*115500 * 124.0215 /10^6;
TRAN3_CH4_M23 = 140*HRS_PER_AC_M_23*TRAN3_PASS_M23* (2545
/(128500*0.4))*128500 * 106.7175 /10^6;
TRAN3_CH4_TOTAL = TRAN3_CH4_M21 + TRAN3_CH4_M22 +TRAN3_CH4_M23 ;
TRAN3_CO2 = TRAN3_CO2_TOTAL/(YIELD * 907.1847);
TRAN3_N2O = TRAN3_N2O_TOTAL/(YIELD * 907.1847);
TRAN3_CH4 = TRAN3_CH4_TOTAL/(YIELD * 907.1847);
TRAN3_CO2_FINAL = TRAN3_CO2 ;
TRAN3_N2O_FINAL = TRAN3_N2O ;
TRAN3_CH4_FINAL = TRAN3_CH4 ;
TRAN3_CO2_EQ = TRAN3_CO2_FINAL + 296 * TRAN3_N2O_FINAL + 23 *
TRAN3_CH4_FINAL;

!TRANSPORT 4;
TRAN4_PASS_M24 = 1;
TRAN4_PASS_M25 = 1;
TRAN4_PASS_M26 = 1;
TRAN4_MAC_HOURS = HRS_PER_AC_M_24 * TRAN4_PASS_M24 +
HRS_PER_AC_M_25*TRAN4_PASS_M25 + HRS_PER_AC_M_26*TRAN4_PASS_M26;
LABOR_24 = HRS_PER_AC_M_24 * LABOR_TO_MACHINE;
LABOR_25 = HRS_PER_AC_M_25 * LABOR_TO_MACHINE;

```



```

LABOR_26 = HRS_PER_AC_M_26 * LABOR_TO_MACHINE;
PASS_L24 = LABOR_24 * TRAN4_PASS_M24;
PASS_L25 = LABOR_25 * TRAN4_PASS_M25;
PASS_L26 = LABOR_26 * TRAN4_PASS_M26;
TRAN4_LAB_HOURS = PASS_L24 + PASS_L25 + PASS_L26 ;
TRAN4_VARIABLE = EX_VARIABLE_24*TRAN4_PASS_M24
+EX_VARIABLE_25*TRAN4_PASS_M25 + EX_VARIABLE_26 * TRAN4_PASS_M26;
TRAN4_FIXED = EX_FIXED_24*TRAN4_PASS_M24 +EX_FIXED_25*TRAN4_PASS_M25 +
EX_FIXED_26*TRAN4_PASS_M26 ;
TRAN4_UNALLOCATED_LAB = TRAN4_LAB_HOURS *UNALLOCATED_LABOR_TO_MAC ;

!VARIABLE COSTS FOR TRANSPORT 4;
TRAN4_HAR2 = SIZE_OF_ENTERPRISE* HAR2_TOTAL_COST;
TRACTOR_TRAN4 = TRAN4_VARIABLE*TRACTOR*SIZE_OF_ENTERPRISE;
TRAN4_TOTAL_VARIABLE = TRACTOR_TRAN4 +TRAN4_HAR2 ;

!FIXED COSTS FOR TRANSPORT 4;
TRACTOR_EQUIP_TRAN4 = TRAN4_FIXED*TRACTOR*SIZE_OF_ENTERPRISE;
TRAN4_GENERALOVERHEAD = TRAN4_TOTAL_VARIABLE*GENERALOVERHEAD;
TRAN4_TOTAL_FIXED= TRACTOR_EQUIP_TRAN4 + TRAN4_GENERALOVERHEAD;

!LABOR COSTS FOR TRANSPORT 4;
TRAN4_TOTAL_LABOR = (TRAN4_LAB_HOURS +
TRAN4_UNALLOCATED_LAB)*SIZE_OF_ENTERPRISE*LABOR_WAGE;

!TOTAL OF ALL COSTS FOR TRANSPORT 4;
TRAN4_TOTAL_COST = TRAN4_TOTAL_VARIABLE + TRAN4_TOTAL_FIXED+
TRAN4_TOTAL_LABOR ;

! GHG FROM TRANSPORT 4;
HRS_PER_AC_M_NEW_26 = (1+(2*DIST/TRUCK_SPEED))*(YIELD/PELLETS);
TRAN4_CO2_M24 = 200*HRS_PER_AC_M_24*TRAN4_PASS_M24* 0.746*1*
701.915956;
TRAN4_CO2_M25 = HP_T(1)*HRS_PER_AC_M_25*TRAN4_PASS_M25* (2545
/(115500*0.3))*115500 * 92614 /10^6;
TRAN4_CO2_M26 = 400*HRS_PER_AC_M_NEW_26*TRAN4_PASS_M26* (2545
/(128500*0.4))*128500 * 94234 /10^6;
TRAN4_CO2_TOTAL = TRAN4_CO2_M24 + TRAN4_CO2_M25 +TRAN4_CO2_M26 ;
TRAN4_N2O_M24 = 200*HRS_PER_AC_M_24*TRAN4_PASS_M24* 0.746*1*
0.005144952;
TRAN4_N2O_M25 = HP_T(1)*HRS_PER_AC_M_25*TRAN4_PASS_M25* (2545
/(115500*0.3))*115500 * 2.263 /10^6;
TRAN4_N2O_M26 = 400*HRS_PER_AC_M_NEW_26*TRAN4_PASS_M26* (2545
/(128500*0.4))*128500 * 2.201 /10^6;
TRAN4_N2O_TOTAL = TRAN4_N2O_M24 + TRAN4_N2O_M25 +TRAN4_N2O_M26 ;
TRAN4_CH4_M24 = 200*HRS_PER_AC_M_24*TRAN4_PASS_M24* 0.746*1*
1.009479863;
TRAN4_CH4_M25 = HP_T(1)*HRS_PER_AC_M_25*TRAN4_PASS_M25* (2545
/(115500*0.3))*115500 * 146.611 /10^6;
TRAN4_CH4_M26 = 400*HRS_PER_AC_M_NEW_26*TRAN4_PASS_M26* (2545
/(128500*0.4))*128500 * 108.266 /10^6;
TRAN4_CH4_TOTAL = TRAN4_CH4_M24 + TRAN4_CH4_M25 +TRAN4_CH4_M26 ;
TRAN4_CO2 = TRAN4_CO2_TOTAL/(YIELD * 907.1847);
TRAN4_N2O = TRAN4_N2O_TOTAL/(YIELD * 907.1847);

```

```

TRAN4_CH4 = TRAN4_CH4_TOTAL/(YIELD * 907.1847);
TRAN4_CO2_FINAL = TRAN4_CO2 ;
TRAN4_N2O_FINAL = TRAN4_N2O ;
TRAN4_CH4_FINAL = TRAN4_CH4 ;
TRAN4_CO2_EQ = TRAN4_CO2_FINAL + 296 * TRAN4_N2O_FINAL + 23 *
TRAN4_CH4_FINAL;

```

```

!EMISSIONS FROM LOST SWITCHGRASS;

```

```

LOST_TO_YIELD = 0.04;
LOST_SW = LOST_TO_YIELD*(YIELD*907.1847);
EMBED = 0.1*LOST_SW;!10% IS EMBEDDED;
CARBON = EMBED*0.333192;
CARBON_DEGR = 0.5*CARBON;
CARBON_TO_CO2 = 0.5*CARBON_DEGR;
E_CO2_LOST = CARBON_TO_CO2*44.01/12.01;
CARBON_TO_CH4 = 0.5*CARBON_DEGR;
E_CH4_LOST = CARBON_TO_CH4*16.05/12.01;
MULCHED = 0.9*LOST_SW;
CARBON_MULCHED = 42.04*MULCHED/100;
MULCHED_CO2 = 0.9*CARBON_MULCHED;
CO2_FORM_MULCH = 44.01/12.01*MULCHED_CO2;
MULCHED_CH4 = 0.1*CARBON_MULCHED;
CH4_FORM_MULCH = 16.05/12.01*MULCHED_CH4;
E_CO2_LOST_ACRE = E_CO2_LOST+CO2_FORM_MULCH;
E_CH4_LOST_ACRE = E_CH4_LOST+CH4_FORM_MULCH;
E_GHG_LOST_ACRE = E_CO2_LOST_ACRE+23*E_CH4_LOST_ACRE;
NET_E_CO2_LOST = E_CO2_LOST_ACRE/(YIELD*907.1847)*1000;
NET_E_CH4_LOST = E_CH4_LOST_ACRE/(YIELD*907.1847)*1000;
NET_E_N2O_LOST = 0;
NET_GHG_LOST = NET_E_CO2_LOST+23*NET_E_CH4_LOST;

```

```

!EMISSIONS DUE TO N2O BY FERTILIZER USE;

```

```

N_FERT = 1;
N_VOLATIZED = 0.1*N_FERT; !TAKING 1KG SWITCHGRASS AS BASIS;
N2O_VOLATIZED = 0.01*N_VOLATIZED*44.02/14.01*1000;
N2O_UNVOLATIZED = 12.5*N_FERT*0.9;
RUNOFF_N2O = 25*N_FERT*0.9;
TOTAL_N2O = N2O_VOLATIZED++N2O_UNVOLATIZED+RUNOFF_N2O;
TOTAL_CO2_SW = 0;
TOTAL_N2O_SW = NITROGEN_USE/(YIELD*907.1847)*TOTAL_N2O;
TOTAL_CH4_SW = 0;

```

```

!EMISSIONS FROM SOIL CARBON ACCUMULATION;

```

```

SOIL_CO2 = 1.1*1000000*44.01/12.01/2.47;
SOIL_ENERGY = 0;
SOIL_E_CO2 = (SOIL_CO2/(YIELD*907.1847));!THIS IS A NEGATIVE VALUE AS
ITS SEQUESTRATION;
SOIL_E_N2O = 0;
SOIL_E_CH4 = 0;

```

```

!EMISSIONS FROM SEQUESTRATION;

```

```

SEQ_ENERGY = 0;
SW_KGS = 1;

```

```

SEQ_CO2 = (42.04)/100*SW_KGS*1000*44.01/12.01;!THIS IS A NEGATIVE VALUE
AS ITS SEQUESTRATION;
SEQ_N2O = 0;
SEQ_CH4 = 0;

```

```

!EMISSIONS FROM CHEMICALS;
!EMISSIONS FROM NITROGEN;
ENRGY_N = 61412.6;
CO2_N_PROD = 3816.05;
N2O_N_PROD = 0.059523;
CH4_N_PROD = 9.7536;
N_GHG_PROD = CO2_N_PROD+296*N2O_N_PROD+23*CH4_N_PROD;
NITROGEN_USE = 49.896;
ENERGY_NIT = ENRGY_N*NITROGEN_USE;
E_CO2_NIT = CO2_N_PROD*NITROGEN_USE;
E_CH4_NIT = CH4_N_PROD*NITROGEN_USE;
E_N2O_NIT = N2O_N_PROD*NITROGEN_USE;
E_GHG_NIT = E_CO2_NIT+296*E_N2O_NIT+23*E_CH4_NIT;
ENERGY_NET_N = ENERGY_NIT/(YIELD*907.1847);
NET_E_CO2_NIT = E_CO2_NIT/(YIELD*907.1847);
NET_E_N2O_NIT = E_N2O_NIT/(YIELD*907.1847);
NET_E_CH4_NIT = E_CH4_NIT/(YIELD*907.1847);
NET_GHG_NIT = NET_E_CO2_NIT+296*NET_E_N2O_NIT+23*NET_E_CH4_NIT;

```

```

!EMISSIONS FROM P2O5;
ENERGY_P = 23138.88;
CO2_P_PROD = 1574.91;
N2O_P_PROD = 0.015023;
CH4_P_PROD = 2.4366;
P_GHG_PROD = CO2_P_PROD+296*N2O_P_PROD+23*CH4_P_PROD;
P_USE = 19.9584;
ENERGY_P2O5 = ENERGY_P*P_USE;
E_CO2_P = CO2_P_PROD*P_USE;
E_CH4_P = CH4_P_PROD*P_USE;
E_N2O_P = N2O_P_PROD*P_USE;
E_GHG_P = E_CO2_P+296*E_N2O_P+23*E_CH4_P;
ENERGY_NET_P = ENERGY_P2O5/(YIELD*907.1847);
NET_E_CO2_P = E_CO2_P/(YIELD*907.1847);
NET_E_N2O_P = E_N2O_P/(YIELD*907.1847);
NET_E_CH4_P = E_CH4_P/(YIELD*907.1847);
NET_GHG_P = NET_E_CO2_P+296*NET_E_N2O_P+23*NET_E_CH4_P;

```

```

!EMISSIONS FROM K2O;
ENERGY_K = 10409.41;
CO2_K_PROD = 735.15;
N2O_K_PROD = 0.007423;
CH4_K_PROD = 1.1246;
K_GHG_PROD = CO2_K_PROD+296*N2O_K_PROD+23*CH4_K_PROD;
K_USE = 19.9584;
ENERGY_K2O = ENERGY_K*K_USE;
E_CO2_K = CO2_K_PROD*K_USE;
E_CH4_K = CH4_K_PROD*K_USE;
E_N2O_K = N2O_K_PROD*K_USE;
E_GHG_K = E_CO2_K+296*E_N2O_K+23*E_CH4_K;

```

```

ENERGY_NET_K = ENERGY_K2O/(YIELD*907.1847);
NET_E_CO2_K = E_CO2_K/(YIELD*907.1847);
NET_E_N2O_K = E_N2O_K/(YIELD*907.1847);
NET_E_CH4_K = E_CH4_K/(YIELD*907.1847);
NET_GHG_K = NET_E_CO2_K+296*NET_E_N2O_K+23*NET_E_CH4_K;

!EMISSIONS FROM ATRAZINE;
ENERGY_A = 269077.3;
CO2_A_PROD = 19290.07;
N2O_A_PROD = 0.173623;
CH4_A_PROD = 28.3756;
A_GHG_PROD = CO2_A_PROD+296*N2O_A_PROD+23*CH4_A_PROD;
A_USE = 0.99792;
ENERGY_AT = ENERGY_A*A_USE;
E_CO2_A = CO2_A_PROD*A_USE;
E_CH4_A = CH4_A_PROD*A_USE;
E_N2O_A = N2O_A_PROD*A_USE;
E_GHG_A = E_CO2_A+296*E_N2O_A+23*E_CH4_A;
ENERGY_NET_A = ENERGY_AT/(YIELD*907.1847);
NET_E_CO2_A = E_CO2_A/(YIELD*907.1847);
NET_E_N2O_A = E_N2O_A/(YIELD*907.1847);
NET_E_CH4_A = E_CH4_A/(YIELD*907.1847);
NET_GHG_A = NET_E_CO2_A+296*NET_E_N2O_A+23*NET_E_CH4_A;

!EMISSIONS FROM LIME PRODUCTION;
DIESEL_INPUT = 26454.37032;
ELECT_INPUT = 3474.485405;
!EMISSIONS FROM DIESEL EQUIPMENT;
FUEL_DIESEL = 1.197559*DIESEL_INPUT;
CO2_EMIT_D = 0.094234*DIESEL_INPUT;
N2O_EMIT_D = 0.000002201*DIESEL_INPUT;
CH4_EMIT_D = 0.000108266*DIESEL_INPUT;
!EMISSIONS FOM ELECTRIC EQUIPMENT;
ELEC_ENERGY = 3.261903*ELECT_INPUT;
CO2_EMIT_E = 0.20587*ELECT_INPUT;
N2O_EMIT_E = 0.000001509*ELECT_INPUT;
CH4_EMIT_E = 0.000296075*ELECT_INPUT;
!TOTAL EMISSIONS FROM DIESEL AND ELECTRIC EQUIPMENT;
ENERGY_DE = FUEL_DIESEL+ELEC_ENERGY;
CO2_DE = CO2_EMIT_D+CO2_EMIT_E;
N2O_DE = N2O_EMIT_D+N2O_EMIT_E;
CH4_DE = CH4_EMIT_D+CH4_EMIT_E;
GHG_DE = CO2_DE+296*N2O_DE +23*CH4_DE ;
SOIL_EFFECIENCY = 1;
CO2_EMIT_LIME_APP = SOIL_EFFECIENCY*1000000*44.01/100.09;
!TOTAL EMISSIONS FROM LIME PRODUCTION;
ENERGY_LIME = ENERGY_DE;
CO2_DE_LIME = CO2_DE+CO2_EMIT_LIME_APP;
N2O_DE_LIME = N2O_DE;
CH4_DE_LIME = CH4_DE;
GHG_DE_LIME = CO2_DE_LIME+296*N2O_DE_LIME+23*CH4_DE_LIME;
!EMISSIONS FROM LIME TRANSPORTATION;
LIME_TONNES = 1;
RAIL = 0.6;

```

```

DIST_RAIL = 640/1.609334*2;
DIESEL_RAIL = LIME_TONNES*RAIL*DIST_RAIL*0.001692849*128500/1000000;
TRUCK = 0.4;
DIST_TRUCK = 100;
DIESEL_TRUCK = LIME_TONNES*TRUCK*DIST_TRUCK*0.018665806*128500/1000000;
ENERGY_RAIL = DIESEL_RAIL*1.197559*1000000;
CO2_RAIL = DIESEL_RAIL*93981;
N2O_RAIL = DIESEL_RAIL*2.201;
CH4_RAIL = DIESEL_RAIL*104.616;
ENERGY_TRUCK = DIESEL_TRUCK*1.197559*1000000;
CO2_TRUCK = DIESEL_TRUCK*94234;
N2O_TRUCK = DIESEL_TRUCK*2.201;
CH4_TRUCK = DIESEL_TRUCK*108.266;
!TOTAL EMISSIONS FROM RAIL AND TRUCK;
ENERGY_RT = ENERGY_RAIL+ENERGY_TRUCK;
CO2_RT = CO2_RAIL+CO2_TRUCK;
N2O_RT = N2O_RAIL+N2O_TRUCK;
CH4_RT = CH4_RAIL+CH4_TRUCK;
GHG_RT = CO2_RT+296*N2O_RT+23*CH4_RT;
!EMISSIONS FROM LIME PRODUCTION AND TRANSPORTATION;
FUEL_PROD_TRANS = ENERGY_LIME+ENERGY_RT;
CO2_PROD_TRANS = CO2_DE_LIME+CO2_RT;
N2O_PROD_TRANS = N2O_DE_LIME+N2O_RT;
CH4_PROD_TRANS = CH4_DE_LIME+CH4_RT;
GHG_PROD_TRANS = CO2_PROD_TRANS+296*N2O_PROD_TRANS+23*CH4_PROD_TRANS;
!EMISSIONS FROM LIME USE FOR 1KG SWITCHGRASS;
LIME_FUEL_ENERGY = FUEL_PROD_TRANS*181.44/1000/(YIELD*907.1847);
LIME_CO2_PROD_TRANS = CO2_PROD_TRANS*181.44/1000/(YIELD*907.1847);
LIME_N2O_PROD_TRANS = N2O_PROD_TRANS*181.44/1000/(YIELD*907.1847);
LIME_CH4_PROD_TRANS = CH4_PROD_TRANS*181.44/1000/(YIELD*907.1847);
LIME_GHG_PROD_TRANS =
LIME_CO2_PROD_TRANS+296*LIME_N2O_PROD_TRANS+23*LIME_CH4_PROD_TRANS;

!EMISSIONS DUE TO COMBUSTION;
SW_KWH = 0.015144857/0.016479;
E_COAL=0.016479/0.022305893;
NOX_SW = 0.49*453.6*0.015144857;
SOX_SW = 0.025*453.6*0.015144857;
CO2_SW = 222.0077036*453.6*0.015144857;
N2O_SW = 0.013*453.6*0.015144857;
CH4_SW = 0.021*453.6*0.015144857;
CO_SW = 0.6*453.6*0.015144857;
ASH_SW = (4.61+42.04*(1-0.99)+0.18*64.06/32.06)/100*1000-SOX_SW-
CH4_SW*0.748287-CO_SW*0.428775;
NOX_COAL = 12/2;
NOX_C_ALONE = NOX_COAL/(0.022305893/0.010338);
SOX_COAL = 34.32388/2;
SOX_C_ALONE = SOX_COAL/(0.022305893/0.010338);
CO2_COAL = 44.01/12.01*0.99*57.48532/100*1000;
CO2_C_ALONE = CO2_COAL/(0.022305893/0.010338);
N2O_COAL = 31.252783884275/1000;
N2O_C_ALONE = N2O_COAL/(0.022305893/0.010338);
CH4_COAL = 22.32341706/1000;
CH4_C_ALONE = CH4_COAL/(0.022305893/0.010338);

```

```

CO_COAL = 0.5/2;
CO_C_ALONE = CO_COAL/(0.022305893/0.010338);
ASH_COAL = (8.63612+57.48532*(1-0.99)+0.90326*64.06/32.06)/100*1000-
SOX_COAL-CH4_COAL*0.748287-CO_COAL*0.428775;
ASH_C_ALONE = ASH_COAL/(0.022305893/0.010338);

!EMISSIONS DUE TO COFIRING;
WEIGHT_CO = COFIRE*0.022305893/((1-
COFIRE)*0.015144857+COFIRE*0.022305893);
WT_COAL = 907.1847*(1-WEIGHT_CO); !USING 1TON OF FUEL;
WT_SW = 907.1847*WEIGHT_CO;
TOTAL_WT = WT_COAL+WT_SW;
THERMAL_COAL = WT_COAL*0.022305893;
THERMAL_SW = WT_SW * 0.015144857;
TOTAL_THERMAL = THERMAL_COAL+THERMAL_SW;
ELEC_COAL = THERMAL_COAL/0.010338;
ELEC_SW = THERMAL_SW/0.010986;
TOTAL_ELEC = ELEC_COAL+ELEC_SW;
COAL_FOR_ELEC = WT_COAL/TOTAL_ELEC;
SW_FOR_ELEC = WT_SW/TOTAL_ELEC;
ELEC_FROM_COAL = 1*ELEC_COAL/TOTAL_ELEC;
ELEC_FROM_SW = 1*ELEC_SW/TOTAL_ELEC;
!EMISSIONS FROM COAL IN COFIRING;
NOX_C_COFIRE = COAL_FOR_ELEC*NOX_COAL;
SOX_C_COFIRE = COAL_FOR_ELEC*SOX_COAL;
CO2_C_COFIRE = COAL_FOR_ELEC*CO2_COAL;
N2O_C_COFIRE = COAL_FOR_ELEC*N2O_COAL;
CH4_C_COFIRE = COAL_FOR_ELEC*CH4_COAL;
CO_C_COFIRE = COAL_FOR_ELEC*CO_COAL;
ASH_C_COFIRE = COAL_FOR_ELEC*ASH_COAL;
!EMISSIONS FROM SWITCHGRASS IN COFIRING;
NOX_SW_COFIRE = SW_FOR_ELEC * NOX_SW;
SOX_SW_COFIRE = SW_FOR_ELEC*SOX_SW;
CO2_SW_COFIRE = SW_FOR_ELEC*CO2_SW;
N2O_SW_COFIRE = SW_FOR_ELEC*N2O_SW;
CH4_SW_COFIRE = SW_FOR_ELEC*CH4_SW;
CO_SW_COFIRE = SW_FOR_ELEC*CO_SW;
ASH_SW_COFIRE = SW_FOR_ELEC*ASH_SW;
!TOTAL EMISSIONS BY COFIRING;
NOX_COFIRE = NOX_C_COFIRE+NOX_SW_COFIRE;
SOX_COFIRE = SOX_C_COFIRE+SOX_SW_COFIRE;
CO2_COFIRE = CO2_C_COFIRE+CO2_SW_COFIRE;
N2O_COFIRE = N2O_C_COFIRE+N2O_SW_COFIRE;
CH4_COFIRE= CH4_C_COFIRE+CH4_SW_COFIRE;
CO_COFIRE = CO_C_COFIRE+CO_SW_COFIRE;
ASH_COFIRE = ASH_C_COFIRE+ASH_SW_COFIRE;
GHG_COFIRE = CO2_COFIRE+296*N2O_COFIRE+23*CH4_COFIRE;

!POSTCOMBUSTION THERMAL COFIRING;
SOX_UNCONTROL_C_ALONE = SOX_C_ALONE;
SOX_AFTER_CONTROL = 4.6717;
SOX_CONTROLLED = SOX_UNCONTROL_C_ALONE-SOX_AFTER_CONTROL;
WASTE_TARGET = 21.36328;
BEFORE_CONTROL = SOX_COFIRE;

```

```

REMOVED_SOX = SOX_CONTROLLED;
REDUCTION_SOX = SOX_UNCONTROL_C_ALONE-BEFORE_CONTROL;
CACO3_NEED = REMOVED_SOX*1.656187949;
EMISSION_CO2 = REMOVED_SOX*0.687012176;
CASO4_CACO3_WASTE = 2.12519513*REMOVED_SOX+CACO3_NEED*(1.06-1)/1.06;
WASTE_FROM_COAL = 60.39837536;
WASTE_CHANGE = ASH_C_ALONE-ASH_COFIRE;!THIS IS A NEGATIVE QUANTITY;
TOTAL_WASTE_COFIRE = WASTE_FROM_COAL+WASTE_CHANGE;
WASTE_LAND_FILL = TOTAL_WASTE_COFIRE-WASTE_TARGET;
CO2_TRANSPORT_WASTE =
WASTE_LAND_FILL/10^6*(94234*128500/10^6*0.018665806*10*1);!1 TONNE OF
WASTE TRANSPORTED 5 MILES AWAY;
N2O_TRANSPORT_WASTE =
WASTE_LAND_FILL/10^6*(2.201*128500/10^6*0.018665806*10*1);
CH4_TRANSPORT_WASTE =
WASTE_LAND_FILL/10^6*(108.266*128500/10^6*0.018665806*10*1);
GHG_TRANSPORT_WASTE =
CO2_TRANSPORT_WASTE+296*N2O_TRANSPORT_WASTE+23*CH4_TRANSPORT_WASTE;
CO2_SOX_REACTION = EMISSION_CO2;
N2O_SOX_REACTION = 0;
CH4_SOX_REACTION = 0;
NET_E_N2O_LOST = 0;
CO2_LIMESTONE =
CO2_SOX_REACTION+CACO3_NEED/10^6*(CO2_DE+CO2_RAIL+CO2_TRUCK);
N2O_LIMESTONE =
N2O_SOX_REACTION+CACO3_NEED/10^6*(N2O_DE+N2O_RAIL+N2O_TRUCK);
CH4_LIMESTONE =
CH4_SOX_REACTION+CACO3_NEED/10^6*(CH4_DE+CH4_RAIL+CH4_TRUCK);
GHG_LIMESTONE = CO2_LIMESTONE+296*N2O_LIMESTONE+23*CH4_LIMESTONE;

!FINAL EMISSIONS FROM THE MODEL 223;
!COMBINATION 111;
CO2_111 =
(LIME_CO2_PROD_TRANS+NET_E_CO2_NIT+NET_E_CO2_P+NET_E_CO2_K+NET_E_CO2_A+
TOTAL_CO2_SW-SOIL_E_CO2-
SEQ_CO2+EST1_CO2_FINAL+MAN_CO2_FINAL+HAR1_CO2_FINAL+TRAN1_CO2_FINAL+NET
_E_CO2_LOST)*SW_FOR_ELEC+CO2_COFIRE+CO2_TRANSPORT_WASTE+CO2_LIMESTONE+C
OAL_FOR_ELEC/1000*64245.93942;
N2O_111 =
(LIME_N2O_PROD_TRANS+NET_E_N2O_NIT+NET_E_N2O_P+NET_E_N2O_K+NET_E_N2O_A-
SOIL_E_N2O-
SEQ_N2O+EST1_N2O_FINAL+MAN_N2O_FINAL+HAR1_N2O_FINAL+TRAN1_N2O_FINAL+NET
_E_N2O_LOST)*SW_FOR_ELEC+N2O_COFIRE+N2O_TRANSPORT_WASTE+N2O_LIMESTONE+C
OAL_FOR_ELEC/1000*3.032820475;
CH4_111 =
(LIME_CH4_PROD_TRANS+NET_E_CH4_NIT+NET_E_CH4_P+NET_E_CH4_K+NET_E_CH4_A-
SOIL_E_CH4-
SEQ_CH4+EST1_CH4_FINAL+MAN_CH4_FINAL+HAR1_CH4_FINAL+TRAN1_CH4_FINAL+NET
_E_CH4_LOST)*SW_FOR_ELEC+CH4_COFIRE+CH4_TRANSPORT_WASTE+CH4_LIMESTONE+C
OAL_FOR_ELEC/1000*2602.435886;
GHGCO2EQ_111 = CO2_111+296*N2O_111+23*CH4_111;

!COMBINATION 211;

```

```

CO2_211 =
(LIME_CO2_PROD_TRANS+NET_E_CO2_NIT+NET_E_CO2_P+NET_E_CO2_K+NET_E_CO2_A+
TOTAL_CO2_SW-SOIL_E_CO2-
SEQ_CO2+EST2_CO2_FINAL+MAN_CO2_FINAL+HAR1_CO2_FINAL+TRAN1_CO2_FINAL+NET
_E_CO2_LOST)*SW_FOR_ELEC+CO2_COFIRE+CO2_TRANSPORT_WASTE+CO2_LIMESTONE+C
OAL_FOR_ELEC/1000*64245.93942;
N2O_211 =
(LIME_N2O_PROD_TRANS+NET_E_N2O_NIT+NET_E_N2O_P+NET_E_N2O_K+NET_E_N2O_A-
SOIL_E_N2O-
SEQ_N2O+EST2_N2O_FINAL+MAN_N2O_FINAL+HAR1_N2O_FINAL+TRAN1_N2O_FINAL+NET
_E_N2O_LOST)*SW_FOR_ELEC+N2O_COFIRE+N2O_TRANSPORT_WASTE+N2O_LIMESTONE+C
OAL_FOR_ELEC/1000*3.032820475;
CH4_211 =
(LIME_CH4_PROD_TRANS+NET_E_CH4_NIT+NET_E_CH4_P+NET_E_CH4_K+NET_E_CH4_A-
SOIL_E_CH4-
SEQ_CH4+EST2_CH4_FINAL+MAN_CH4_FINAL+HAR1_CH4_FINAL+TRAN1_CH4_FINAL+NET
_E_CH4_LOST)*SW_FOR_ELEC+CH4_COFIRE+CH4_TRANSPORT_WASTE+CH4_LIMESTONE+C
OAL_FOR_ELEC/1000*2602.435886;
GHGCO2EQ_211 = CO2_211+296*N2O_211+23*CH4_211;

```

!COMBINATION 122;

```

CO2_122 =
(LIME_CO2_PROD_TRANS+NET_E_CO2_NIT+NET_E_CO2_P+NET_E_CO2_K+NET_E_CO2_A+
TOTAL_CO2_SW-SOIL_E_CO2-
SEQ_CO2+EST1_CO2_FINAL+MAN_CO2_FINAL+HAR2_CO2_FINAL+TRAN2_CO2_FINAL+NET
_E_CO2_LOST)*SW_FOR_ELEC+CO2_COFIRE+CO2_TRANSPORT_WASTE+CO2_LIMESTONE+C
OAL_FOR_ELEC/1000*64245.93942;
N2O_122 =
(LIME_N2O_PROD_TRANS+NET_E_N2O_NIT+NET_E_N2O_P+NET_E_N2O_K+NET_E_N2O_A-
SOIL_E_N2O-
SEQ_N2O+EST1_N2O_FINAL+MAN_N2O_FINAL+HAR2_N2O_FINAL+TRAN2_N2O_FINAL+NET
_E_N2O_LOST)*SW_FOR_ELEC+N2O_COFIRE+N2O_TRANSPORT_WASTE+N2O_LIMESTONE+C
OAL_FOR_ELEC/1000*3.032820475;
CH4_122 =
(LIME_CH4_PROD_TRANS+NET_E_CH4_NIT+NET_E_CH4_P+NET_E_CH4_K+NET_E_CH4_A-
SOIL_E_CH4-
SEQ_CH4+EST1_CH4_FINAL+MAN_CH4_FINAL+HAR2_CH4_FINAL+TRAN2_CH4_FINAL+NET
_E_CH4_LOST)*SW_FOR_ELEC+CH4_COFIRE+CH4_TRANSPORT_WASTE+CH4_LIMESTONE+C
OAL_FOR_ELEC/1000*2602.435886;
GHGCO2EQ_122 = CO2_122+296*N2O_122+23*CH4_122;

```

!COMBINATION 123;

```

CO2_123 =
(LIME_CO2_PROD_TRANS+NET_E_CO2_NIT+NET_E_CO2_P+NET_E_CO2_K+NET_E_CO2_A+
TOTAL_CO2_SW-SOIL_E_CO2-
SEQ_CO2+EST1_CO2_FINAL+MAN_CO2_FINAL+HAR2_CO2_FINAL+TRAN3_CO2_FINAL+NET
_E_CO2_LOST)*SW_FOR_ELEC+CO2_COFIRE+CO2_TRANSPORT_WASTE+CO2_LIMESTONE+C
OAL_FOR_ELEC/1000*64245.93942;
N2O_123 =
(LIME_N2O_PROD_TRANS+NET_E_N2O_NIT+NET_E_N2O_P+NET_E_N2O_K+NET_E_N2O_A-
SOIL_E_N2O-
SEQ_N2O+EST1_N2O_FINAL+MAN_N2O_FINAL+HAR2_N2O_FINAL+TRAN3_N2O_FINAL+NET
_E_N2O_LOST)*SW_FOR_ELEC+N2O_COFIRE+N2O_TRANSPORT_WASTE+N2O_LIMESTONE+C
OAL_FOR_ELEC/1000*3.032820475;

```



```

CH4_123 =
(LIME_CH4_PROD_TRANS+NET_E_CH4_NIT+NET_E_CH4_P+NET_E_CH4_K+NET_E_CH4_A-
SOIL_E_CH4-
SEQ_CH4+EST1_CH4_FINAL+MAN_CH4_FINAL+HAR2_CH4_FINAL+TRAN3_CH4_FINAL+NET
_E_CH4_LOST)*SW_FOR_ELEC+CH4_COFIRE+CH4_TRANSPORT_WASTE+CH4_LIMESTONE+C
OAL_FOR_ELEC/1000*2602.435886;
GHGCO2EQ_123 = CO2_123+296*N2O_123+23*CH4_123;

```

!COMBINATION 124;

```

CO2_124 =
(LIME_CO2_PROD_TRANS+NET_E_CO2_NIT+NET_E_CO2_P+NET_E_CO2_K+NET_E_CO2_A+
TOTAL_CO2_SW-SOIL_E_CO2-
SEQ_CO2+EST1_CO2_FINAL+MAN_CO2_FINAL+HAR2_CO2_FINAL+TRAN4_CO2_FINAL+NET
_E_CO2_LOST)*SW_FOR_ELEC+CO2_COFIRE+CO2_TRANSPORT_WASTE+CO2_LIMESTONE+C
OAL_FOR_ELEC/1000*64245.93942;
N2O_124 =
(LIME_N2O_PROD_TRANS+NET_E_N2O_NIT+NET_E_N2O_P+NET_E_N2O_K+NET_E_N2O_A-
SOIL_E_N2O-
SEQ_N2O+EST1_N2O_FINAL+MAN_N2O_FINAL+HAR2_N2O_FINAL+TRAN4_N2O_FINAL+NET
_E_N2O_LOST)*SW_FOR_ELEC+N2O_COFIRE+N2O_TRANSPORT_WASTE+N2O_LIMESTONE+C
OAL_FOR_ELEC/1000*3.032820475;
CH4_124 =
(LIME_CH4_PROD_TRANS+NET_E_CH4_NIT+NET_E_CH4_P+NET_E_CH4_K+NET_E_CH4_A-
SOIL_E_CH4-
SEQ_CH4+EST1_CH4_FINAL+MAN_CH4_FINAL+HAR2_CH4_FINAL+TRAN4_CH4_FINAL+NET
_E_CH4_LOST)*SW_FOR_ELEC+CH4_COFIRE+CH4_TRANSPORT_WASTE+CH4_LIMESTONE+C
OAL_FOR_ELEC/1000*2602.435886;
GHGCO2EQ_124 = CO2_124+296*N2O_124+23*CH4_124;

```

!COMBINATION 222;

```

CO2_222 =
(LIME_CO2_PROD_TRANS+NET_E_CO2_NIT+NET_E_CO2_P+NET_E_CO2_K+NET_E_CO2_A+
TOTAL_CO2_SW-SOIL_E_CO2-
SEQ_CO2+EST2_CO2_FINAL+MAN_CO2_FINAL+HAR2_CO2_FINAL+TRAN2_CO2_FINAL+NET
_E_CO2_LOST)*SW_FOR_ELEC+CO2_COFIRE+CO2_TRANSPORT_WASTE+CO2_LIMESTONE+C
OAL_FOR_ELEC/1000*64245.93942;
N2O_222 =
(LIME_N2O_PROD_TRANS+NET_E_N2O_NIT+NET_E_N2O_P+NET_E_N2O_K+NET_E_N2O_A-
SOIL_E_N2O-
SEQ_N2O+EST2_N2O_FINAL+MAN_N2O_FINAL+HAR2_N2O_FINAL+TRAN2_N2O_FINAL+NET
_E_N2O_LOST)*SW_FOR_ELEC+N2O_COFIRE+N2O_TRANSPORT_WASTE+N2O_LIMESTONE+C
OAL_FOR_ELEC/1000*3.032820475;
CH4_222 =
(LIME_CH4_PROD_TRANS+NET_E_CH4_NIT+NET_E_CH4_P+NET_E_CH4_K+NET_E_CH4_A-
SOIL_E_CH4-
SEQ_CH4+EST2_CH4_FINAL+MAN_CH4_FINAL+HAR2_CH4_FINAL+TRAN2_CH4_FINAL+NET
_E_CH4_LOST)*SW_FOR_ELEC+CH4_COFIRE+CH4_TRANSPORT_WASTE+CH4_LIMESTONE+C
OAL_FOR_ELEC/1000*2602.435886;
GHGCO2EQ_222 = CO2_222+296*N2O_222+23*CH4_222;

```

!COMBINATION 223;

```

CO2_223 =
(LIME_CO2_PROD_TRANS+NET_E_CO2_NIT+NET_E_CO2_P+NET_E_CO2_K+NET_E_CO2_A+
TOTAL_CO2_SW-SOIL_E_CO2-

```

```
SEQ_CO2+EST2_CO2_FINAL+MAN_CO2_FINAL+HAR2_CO2_FINAL+TRAN3_CO2_FINAL+NET
_E_CO2_LOST)*SW_FOR_ELEC+CO2_COFIRE+CO2_TRANSPORT_WASTE+CO2_LIMESTONE+C
OAL_FOR_ELEC/1000*64245.93942;
```

```
N2O_223 =
```

```
(LIME_N2O_PROD_TRANS+NET_E_N2O_NIT+NET_E_N2O_P+NET_E_N2O_K+NET_E_N2O_A-
SOIL_E_N2O-
```

```
SEQ_N2O+EST2_N2O_FINAL+MAN_N2O_FINAL+HAR2_N2O_FINAL+TRAN3_N2O_FINAL+NET
_E_N2O_LOST)*SW_FOR_ELEC+N2O_COFIRE+N2O_TRANSPORT_WASTE+N2O_LIMESTONE+C
OAL_FOR_ELEC/1000*3.032820475;
```

```
CH4_223 =
```

```
(LIME_CH4_PROD_TRANS+NET_E_CH4_NIT+NET_E_CH4_P+NET_E_CH4_K+NET_E_CH4_A-
SOIL_E_CH4-
```

```
SEQ_CH4+EST2_CH4_FINAL+MAN_CH4_FINAL+HAR2_CH4_FINAL+TRAN3_CH4_FINAL+NET
_E_CH4_LOST)*SW_FOR_ELEC+CH4_COFIRE+CH4_TRANSPORT_WASTE+CH4_LIMESTONE+C
OAL_FOR_ELEC/1000*2602.435886;
```

```
GHGCO2EQ_223 = CO2_223+296*N2O_223+23*CH4_223;
```

```
!COMBINATION 224;
```

```
CO2_224 =
```

```
(LIME_CO2_PROD_TRANS+NET_E_CO2_NIT+NET_E_CO2_P+NET_E_CO2_K+NET_E_CO2_A+
TOTAL_CO2_SW-SOIL_E_CO2-
```

```
SEQ_CO2+EST2_CO2_FINAL+MAN_CO2_FINAL+HAR2_CO2_FINAL+TRAN4_CO2_FINAL+NET
_E_CO2_LOST)*SW_FOR_ELEC+CO2_COFIRE+CO2_TRANSPORT_WASTE+CO2_LIMESTONE+C
OAL_FOR_ELEC/1000*64245.93942;
```

```
N2O_224 =
```

```
(LIME_N2O_PROD_TRANS+NET_E_N2O_NIT+NET_E_N2O_P+NET_E_N2O_K+NET_E_N2O_A-
SOIL_E_N2O-
```

```
SEQ_N2O+EST2_N2O_FINAL+MAN_N2O_FINAL+HAR2_N2O_FINAL+TRAN4_N2O_FINAL+NET
_E_N2O_LOST)*SW_FOR_ELEC+N2O_COFIRE+N2O_TRANSPORT_WASTE+N2O_LIMESTONE+C
OAL_FOR_ELEC/1000*3.032820475;
```

```
CH4_224 =
```

```
(LIME_CH4_PROD_TRANS+NET_E_CH4_NIT+NET_E_CH4_P+NET_E_CH4_K+NET_E_CH4_A-
SOIL_E_CH4-
```

```
SEQ_CH4+EST2_CH4_FINAL+MAN_CH4_FINAL+HAR2_CH4_FINAL+TRAN4_CH4_FINAL+NET
_E_CH4_LOST)*SW_FOR_ELEC+CH4_COFIRE+CH4_TRANSPORT_WASTE+CH4_LIMESTONE+C
OAL_FOR_ELEC/1000*2602.435886;
```

```
GHGCO2EQ_224 = CO2_224+296*N2O_224+23*CH4_224;
```

```
!TOTAL PRODUCTION COST EVALUATION;
```

```
COST_PROD_MAN_PASTURE_TRAN1 = MAN_TOTAL_COST_PASTURE + TRAN1_TOTAL_COST
```

```
;! 111, c1;
```

```
COST_PROD_MAN_RECROP_TRAN1 = MAN_TOTAL_COST_RECROP + TRAN1_TOTAL_COST
```

```
;!211, c2;
```

```
COST_PROD_MAN_PASTURE_TRANS2 = MAN_TOTAL_COST_PASTURE +
```

```
TRAN2_TOTAL_COST ;!122, c3;
```

```
COST_PROD_MAN_RECROP_TRAN2 = MAN_TOTAL_COST_RECROP +
```

```
TRAN2_TOTAL_COST;!222, c4;
```

```
COST_PROD_MAN_PASTURE_TRANS3 = MAN_TOTAL_COST_PASTURE +
```

```
TRAN3_TOTAL_COST ;!123, c5;
```

```
COST_PROD_MAN_RECROP_TRAN3 = MAN_TOTAL_COST_RECROP +
```

```
TRAN3_TOTAL_COST;!223, c6;
```

```
COST_PROD_MAN_PASTURE_TRANS4 = MAN_TOTAL_COST_PASTURE +
```

```
TRAN4_TOTAL_COST ;!124, c7;
```

```

COST_PROD_MAN_RECROP_TRAN4          =          MAN_TOTAL_COST_RECROP          +
TRAN4_TOTAL_COST; !224, c8;

```

```

C1 + C2 + C3 + C4 + C5 + C6 + C7 + C8 = 1;

```

```
@BIN(C1);
```

```
@BIN(C2);
```

```
@BIN(C3);
```

```
@BIN(C4);
```

```
@BIN(C5);
```

```
@BIN(C6);
```

```
@BIN(C7);
```

```
@BIN(C8);
```

```

COST_OF_PRODUCTION = ((C1 * COST_PROD_MAN_PASTURE_TRAN1 + C2 *
COST_PROD_MAN_RECROP_TRAN1 + C3 * COST_PROD_MAN_PASTURE_TRANS2 + C4 *
COST_PROD_MAN_RECROP_TRAN2 + C5 * COST_PROD_MAN_PASTURE_TRANS3 + C6 *
COST_PROD_MAN_RECROP_TRAN3 + C7 * COST_PROD_MAN_PASTURE_TRANS4 + C8 *
COST_PROD_MAN_RECROP_TRAN4)/(SIZE_OF_ENTERPRISE * YIELD));

```

```
!CHOOSING OUT THE MIN GHG ALTERNATIVE;
```

```
G1 + G2 + G3 + G4 + G5 + G6 + G7 + G8 = 1;
```

```
@BIN(G1);
```

```
@BIN(G2);
```

```
@BIN(G3);
```

```
@BIN(G4);
```

```
@BIN(G5);
```

```
@BIN(G6);
```

```
@BIN(G7);
```

```
@BIN(G8);
```

```

GHG_ALTERNATIVE = (G1 * GHGCO2EQ_111 + G2 * GHGCO2EQ_211 + G3 *
GHGCO2EQ_122 + G4 * GHGCO2EQ_123 + G5 * GHGCO2EQ_124 + G6 *
GHGCO2EQ_222 + G7 * GHGCO2EQ_223 + G8 * GHGCO2EQ_224);

```

```
G1 = C1; G2 = C2; G3 = C3; G4 = C5; G5 = C7; G6 = C4; G7 = C6; G8 = C8;
```

```
! OFFSET PRICE VARIATION;
```

```
!IF GHG_ALTERNATIVE>984, WE TAKE OFFSET =-1 AND IF
GHG_ALTERNATIVE<=984, WE TAKE OFFSET = 0.5;
```

```
(984-(GHG_ALTERNATIVE))*(2*I-1)>=0;
```

```
@BIN(I);
```

```
OFFSET_COST = (0.5*I -1*(1-I))*GHG_ALTERNATIVE;
```

```
COST_OF_COAL = 28.13099 * 0.9071847;
```

```

COST_DOLLAR_PER_KWH = (((COST_OF_COAL*COAL_FOR_ELEC)/1000 +
(COST_OF_PRODUCTION*SW_FOR_ELEC)/1000)); !-(OFFSET_COST/10^6);

```

```
END
```

## A.2 - Lingo solution for optimum biomass electricity cost without offset (lower biomass cost)

Local optimal solution found at iteration: 113  
 Objective value: 0.1236266E-01

Variable	Value	Reduced Cost
COST_DOLLAR_PER_KWH	0.1236266E-01	0.000000
DIESEL_P	1.450000	0.000000
GAS_P	1.480000	0.000000
ELECT_P	0.7500000E-01	0.000000
LIQ_PET_P	1.050000	0.000000
GENERALOVERHEAD	0.7000000E-01	0.000000
INTEREST	0.7000000E-01	0.000000
TAX	0.000000	0.000000
INSURANCE	0.6000000E-02	0.000000
LABOR_WAGE	7.250000	0.000000
LABOR_TO_MACHINE	1.100000	0.000000
UNALLOCATED_LABOR_TO_MAC	1.250000	0.000000
LUBE_TO_FUEL	0.1500000	0.000000
RENTAL_PASTURE	8.200000	0.000000
RENTAL_RECROP	24.00000	0.000000
YIELD	12.00000	0.000000
RESEED	0.2500000	0.000000
SIZE_OF_ENTERPRISE	1.000000	0.000000
ROUNDBALES	20.00000	0.000000
LOOSECHOP	15.00000	0.000000
MODULES	14.00000	0.000000
PELLETS	30.00000	0.000000
GROUND	15.00000	0.000000
COFIRE	0.1104111	0.000000
DENSITY	0.7000000	0.000000
DAYS_OF_OPERATION	300.0000	0.000000
HRS_OF_OPERATION	24.00000	0.000000
PLANT_EFFICIENCY	0.8000000	0.000000
NPHR_COAL	0.1033800E-01	0.000000
NPHR_SW_COFIRE	0.1098600E-01	0.000000
HHV_COAL	0.2230589E-01	0.000000
HHV_SW	0.1514486E-01	0.000000
PLANT_SIZE_MW	25.00000	0.000000
SW_KG	140.2045	0.000000
COAL_KG	766.9802	0.000000
SW_THERMAL	2.123378	0.000000
COAL_THERMAL	17.10818	0.000000
SW_ELEC	193.2803	0.000000
COAL_ELEC	1654.883	0.000000
TOTAL_ELEC	1848.163	0.000000
SW_REQD	0.7586156E-01	0.000000
COAL_REQD	0.4149959	0.000000
M	0.1092406E+08	0.000000
M_COAL	0.5975942E+08	0.000000
DIST	0.7055117	0.000000

TRUCK_SPEED	45.00000	0.000000
STANDLIFE	15.00000	0.000000
HERBICIDE	2.200000	0.000000
NITROGEN	110.0000	0.000000
P2O5	44.00000	0.000000
K2O	44.00000	0.000000
LIME	2.000000	0.000000
SOIL	0.3000000E-01	0.000000
SEEDS	5.000000	0.000000
TRACTOR	1.000000	0.000000
WIDTH_MI_13	14.00000	0.000000
WIDTH_MI_14	14.00000	0.000000
WIDTH_MI_19	14.00000	0.000000
WIDTH_MI_21	14.00000	0.000000
SPEED_MI_13	4.300000	0.000000
SPEED_MI_14	3.475000	0.000000
SPEED_MI_19	3.475000	0.000000
SPEED_MI_21	3.475000	0.000000
EFFICIENCY_MI_13	0.7700000	0.000000
EFFICIENCY_MI_14	0.4000000	0.000000
EFFICIENCY_MI_19	0.7000000	0.000000
EFFICIENCY_MI_21	0.4000000	0.000000
HRS_PER_AC_M_11	1.200000	0.000000
HRS_PER_AC_M_12	1.900000	0.000000
HRS_PER_AC_M_13	0.1779782	0.000000
HRS_PER_AC_M_14	0.4239466	0.000000
HRS_PER_AC_M_15	1.018814	0.000000
HRS_PER_AC_M_16	4.000000	0.000000
HRS_PER_AC_M_17	1.900000	0.000000
HRS_PER_AC_M_18	1.025085	0.000000
HRS_PER_AC_M_19	0.2422552	0.000000
HRS_PER_AC_M_20	1.900000	0.000000
HRS_PER_AC_M_21	0.4239466	0.000000
HRS_PER_AC_M_22	0.8571429	0.000000
HRS_PER_AC_M_23	1.026877	0.000000
HRS_PER_AC_M_24	4.020000	0.000000
HRS_PER_AC_M_25	1.900000	0.000000
HRS_PER_AC_M_26	1.018814	0.000000
EX_VARIABLE_11	19.16040	0.000000
EX_VARIABLE_12	15.58566	0.000000
EX_VARIABLE_13	1.337210	0.000000
EX_VARIABLE_14	0.4239466	0.000000
EX_VARIABLE_15	37.20300	0.000000
EX_VARIABLE_16	4.020000	0.000000
EX_VARIABLE_17	15.58566	0.000000
EX_VARIABLE_18	40.25098	0.000000
EX_VARIABLE_19	0.3127030	0.000000
EX_VARIABLE_20	15.58566	0.000000
EX_VARIABLE_21	6.689458	0.000000
EX_VARIABLE_22	17.16243	0.000000
EX_VARIABLE_23	18.95162	0.000000
EX_VARIABLE_24	149.5830	0.000000
EX_VARIABLE_25	15.58566	0.000000
EX_VARIABLE_26	40.00474	0.000000

EX_FIXED_11	5.192103	0.000000
EX_FIXED_12	4.475785	0.000000
EX_FIXED_13	2.847213	0.000000
EX_FIXED_14	0.2840442E-02	0.000000
EX_FIXED_15	13.22446	0.000000
EX_FIXED_16	5.188392	0.000000
EX_FIXED_17	4.475785	0.000000
EX_FIXED_18	21.43723	0.000000
EX_FIXED_19	0.5409769	0.000000
EX_FIXED_20	4.475785	0.000000
EX_FIXED_21	2.208791	0.000000
EX_FIXED_22	9.617287	0.000000
EX_FIXED_23	21.47470	0.000000
EX_FIXED_24	21.58125	0.000000
EX_FIXED_25	4.475785	0.000000
EX_FIXED_26	21.30608	0.000000
IN_VARIABLE_1	1.416943	0.000000
IN_VARIABLE_2	2.411506	0.000000
IN_VARIABLE_3	1.536645	0.000000
IN_VARIABLE_4	3.441888	0.000000
IN_VARIABLE_5	1.416943	0.000000
IN_VARIABLE_6	4.941684	0.000000
IN_VARIABLE_7	1.176787	0.000000
IN_VARIABLE_8	3.224300	0.000000
IN_VARIABLE_9	2.811305	0.000000
IN_VARIABLE_10	4.129454	0.000000
IN_VARIABLE_13	2.811305	0.000000
IN_VARIABLE_14	15.87000	0.000000
IN_VARIABLE_16	37.14980	0.000000
IN_VARIABLE_19	2.319169	0.000000
IN_FIXED_1	0.9175799	0.000000
IN_FIXED_2	2.360367	0.000000
IN_FIXED_3	0.7560028	0.000000
IN_FIXED_4	3.150679	0.000000
IN_FIXED_5	0.9175799	0.000000
IN_FIXED_6	5.810623	0.000000
IN_FIXED_7	1.115995	0.000000
IN_FIXED_8	2.351922	0.000000
IN_FIXED_9	3.613818	0.000000
IN_FIXED_10	7.277634	0.000000
IN_FIXED_13	3.613818	0.000000
IN_FIXED_14	15.87000	0.000000
IN_FIXED_16	22.41758	0.000000
IN_FIXED_19	1.584442	0.000000
EST_PASS_M1	2.000000	0.000000
EST_PASS_M2	2.000000	0.000000
EST_PASS_M3	1.000000	0.000000
EST_PASS_M4	1.000000	0.000000
EST1_MAC_HOURS	0.9974996	0.000000
LABOR_1	0.1680556	0.000000
LABOR_2	0.1825038	0.000000
LABOR_3	0.2216117	0.000000
LABOR_4	0.1745192	0.000000
PASS_L1	0.3361111	0.000000

PASS_L2	0.3650075	0.000000
PASS_L3	0.2216117	0.000000
PASS_L4	0.1745192	0.000000
EST1_LAB_HOURS	1.097250	0.000000
EST1_VARIABLE	12.63543	0.000000
EST1_FIXED	10.46258	0.000000
EST1_UNALLOCATED_LAB	1.371562	0.000000
ATRAZINE_EST1	21.31800	0.000000
NITROGEN_EST1	35.20000	0.000000
P2O5_EST1	11.88000	0.000000
K2O_EST1	6.600000	0.000000
LIME_EST1	45.00000	0.000000
SOIL_EST1	0.2100000	0.000000
SEED_EST1	35.00000	0.000000
TRACTOR_EST1	12.63543	0.000000
EST1_TOTAL_VARIABLE	167.8434	0.000000
TRACTOR_EQUIP_EST1	10.46258	0.000000
EST1_GENERALOVERHEAD	11.74904	0.000000
EST1_TOTAL_FIXED	22.21162	0.000000
EST1_TOTAL_LABOR	17.89888	0.000000
EST1_TOTAL_COST	207.9539	0.000000
EST1_AMORITIZED_COST	22.83222	0.000000
EST1_CO2_M1	13203.71	0.000000
EST1_CO2_M2	22942.65	0.000000
EST1_CO2_M3	8705.744	0.000000
EST1_CO2_M4	12877.19	0.000000
EST1_CO2_TOTAL	57729.30	0.000000
EST1_N2O_M1	0.3226294	0.000000
EST1_N2O_M2	0.5343857	0.000000
EST1_N2O_M3	0.2127227	0.000000
EST1_N2O_M4	0.2999385	0.000000
EST1_N2O_TOTAL	1.369676	0.000000
EST1_CH4_M1	20.90191	0.000000
EST1_CH4_M2	26.28614	0.000000
EST1_CH4_M3	13.78148	0.000000
EST1_CH4_M4	14.75381	0.000000
EST1_CH4_TOTAL	75.72334	0.000000
EST1_CO2	5.302971	0.000000
EST1_N2O	0.1258175E-03	0.000000
EST1_CH4	0.6955892E-02	0.000000
EST1_CO2_FINAL	0.4419143	0.000000
EST1_N2O_FINAL	0.1048479E-04	0.000000
EST1_CH4_FINAL	0.5796577E-03	0.000000
EST1_CO2_EQ	0.4583499	0.000000
EST_PASS_M5	2.000000	0.000000
EST_PASS_M6	1.000000	0.000000
EST2_MAC_HOURS	0.4642094	0.000000
LABOR_5	0.1680556	0.000000
LABOR_6	0.1745192	0.000000
PASS_L5	0.3361111	0.000000
PASS_L6	0.1745192	0.000000
EST2_LAB_HOURS	0.5106303	0.000000
EST2_VARIABLE	7.775571	0.000000
EST2_FIXED	7.645783	0.000000

EST2_UNALLOCATED_LAB	0.6382879	0.000000
ATRAZINE_EST2	21.31800	0.000000
NITROGEN_EST2	35.20000	0.000000
P2O5_EST2	11.88000	0.000000
K2O_EST2	6.600000	0.000000
LIME_EST2	45.00000	0.000000
SOIL_EST2	0.2100000	0.000000
SEED_EST2	35.00000	0.000000
TRACTOR_EST2	7.775571	0.000000
EST2_TOTAL_VARIABLE	162.9836	0.000000
TRACTOR_EQUIP_EST2	7.645783	0.000000
EST2_GENERALOVERHEAD	11.40885	0.000000
EST2_TOTAL_FIXED	19.05463	0.000000
EST2_TOTAL_LABOR	8.329657	0.000000
EST2_TOTAL_COST	190.3679	0.000000
EST2_AMORITIZED_COST	20.90137	0.000000
EST2_CO2_M5	13203.71	0.000000
EST2_CO2_M6	12877.19	0.000000
EST2_CO2_TOTAL	26080.90	0.000000
EST2_N2O_M5	0.3226294	0.000000
EST2_N2O_M6	0.2999385	0.000000
EST2_N2O_TOTAL	0.6225679	0.000000
EST2_CH4_M5	20.90191	0.000000
EST2_CH4_M6	14.75381	0.000000
EST2_CH4_TOTAL	35.65572	0.000000
EST2_CO2	2.395773	0.000000
EST2_N2O	0.5718864E-04	0.000000
EST2_CH4	0.3275309E-02	0.000000
EST2_CO2_FINAL	0.1996477	0.000000
EST2_N2O_FINAL	0.4765720E-05	0.000000
EST2_CH4_FINAL	0.2729424E-03	0.000000
EST2_CO2_EQ	0.2073360	0.000000
MAN_PASS_M7	1.000000	0.000000
MAN_PASS_M8	1.000000	0.000000
MAN_MAC_HOURS	0.3863174	0.000000
LABOR_7	0.1354478	0.000000
LABOR_8	0.2895014	0.000000
PASS_L7	0.1354478	0.000000
PASS_L8	0.2895014	0.000000
MAN_LAB_HOURS	0.4249491	0.000000
MAN_VARIABLE	4.401087	0.000000
MAN_FIXED	3.467917	0.000000
MAN_UNALLOCATED_LAB	0.5311864	0.000000
NITROGEN_MAN	35.20000	0.000000
P2O5_MAN	11.88000	0.000000
K2O_MAN	6.600000	0.000000
SOIL_MAN	0.2100000	0.000000
TRACTOR_MAN	4.401087	0.000000
MAN_INTEREST	2.040188	0.000000
MAN_TOTAL_VARIABLE	60.33128	0.000000
TRACTOR_EQUIP_MAN	3.467917	0.000000
MAN_GENERALOVERHEAD	4.223189	0.000000
MAN_EST1	22.83222	0.000000
MAN_EST2	20.90137	0.000000



MAN_TOTAL_FIXED_PASTURE	30.52333	0.000000
MAN_TOTAL_FIXED_RECROP	28.59247	0.000000
MAN_TOTAL_LABOR	6.931983	0.000000
MAN_LAND_PASTURE	8.200000	0.000000
MAN_LAND_RECROP	24.00000	0.000000
MAN_TOTAL_COST_PASTURE	105.9866	0.000000
MAN_TOTAL_COST_RECROP	119.8557	0.000000
MAN_CO2_M7	5320.899	0.000000
MAN_CO2_M8	11867.41	0.000000
MAN_CO2_TOTAL	17188.31	0.000000
MAN_N2O_M7	0.1300148	0.000000
MAN_N2O_M8	0.2764185	0.000000
MAN_N2O_TOTAL	0.4064333	0.000000
MAN_CH4_M7	0.000000	0.000000
EST_PASS_M7	0.000000	0.000000
MAN_CH4_M8	0.000000	0.000000
EST_PASS_M8	0.000000	0.000000
MAN_CH4_TOTAL	0.000000	0.000000
MAN_CO2	1.578905	0.000000
MAN_N2O	0.3733467E-04	0.000000
MAN_CH4	0.000000	0.000000
MAN_CO2_FINAL	1.578905	0.000000
MAN_N2O_FINAL	0.3733467E-04	0.000000
MAN_CH4_FINAL	0.000000	0.000000
MAN_CO2_EQ	1.589957	0.000000
HAR1_PASS_M9	1.000000	0.000000
HAR1_PASS_M10	1.000000	0.000000
HAR1_PASS_M11	1.000000	0.000000
HAR1_PASS_M12	1.000000	0.000000
HAR1_MAC_HOURS	1.931081	0.000000
LABOR_9	0.1957760	0.000000
LABOR_10	0.2784127	0.000000
LABOR_11	1.320000	0.000000
LABOR_12	0.3300000	0.000000
PASS_L9	0.1957760	0.000000
PASS_L10	0.2784127	0.000000
PASS_L11	1.320000	0.000000
PASS_L12	0.3300000	0.000000
HAR1_LAB_HOURS	2.124189	0.000000
HAR1_VARIABLE	34.30414	0.000000
HAR1_FIXED	18.43923	0.000000
HAR1_UNALLOCATED_LAB	2.655236	0.000000
TRACTOR_HAR1	34.30414	0.000000
HAR1_TOTAL_VARIABLE	34.30414	0.000000
TRACTOR_EQUIP_HAR1	18.43923	0.000000
HAR1_GENERALOVERHEAD	2.401290	0.000000
HAR1_TOTAL_FIXED	20.84052	0.000000
HAR1_TOTAL_LABOR	34.65083	0.000000
HAR1_TOTAL_COST	89.79549	0.000000
HAR1_CO2_M9	8025.362	0.000000
HAR1_CO2_M10	14456.28	0.000000
HAR1_CO2_M11	121100.5	0.000000
HAR1_CO2_M12	12963.64	0.000000
HAR1_CO2_TOTAL	156545.7	0.000000

HAR1_N2O_M9	0.1869286	0.000000
HAR1_N2O_M10	0.3367191	0.000000
HAR1_N2O_M11	6.680509	0.000000
HAR1_N2O_M12	0.3167634	0.000000
HAR1_N2O_TOTAL	7.520920	0.000000
HAR1_CH4_M9	9.194918	0.000000
HAR1_CH4_M10	16.56303	0.000000
HAR1_CH4_M11	157.8174	0.000000
HAR1_CH4_M12	20.52187	0.000000
HAR1_CH4_TOTAL	204.0972	0.000000
HAR1_CO2	14.38018	0.000000
HAR1_N2O	0.6908663E-03	0.000000
HAR1_CH4	0.1874822E-01	0.000000
HAR1_CO2_FINAL	14.38018	0.000000
HAR1_N2O_FINAL	0.6908663E-03	0.000000
HAR1_CH4_FINAL	0.1874822E-01	0.000000
HAR1_CO2_EQ	15.01588	0.000000
HAR2_PASS_M13	1.000000	0.000000
HAR2_PASS_M14	1.000000	0.000000
HAR2_MAC_HOURS	0.6019247	0.000000
LABOR_13	0.1957760	0.000000
LABOR_14	0.4663412	0.000000
PASS_L13	0.1957760	0.000000
PASS_L14	0.4663412	0.000000
HAR2_LAB_HOURS	0.6621172	0.000000
HAR2_VARIABLE	18.68130	0.000000
HAR2_FIXED	19.48382	0.000000
HAR2_UNALLOCATED_LAB	0.8276465	0.000000
TRACTOR_HAR2	18.68130	0.000000
HAR2_TOTAL_VARIABLE	18.68130	0.000000
TRACTOR_EQUIP_HAR2	19.48382	0.000000
HAR2_GENERALOVERHEAD	1.307691	0.000000
HAR2_TOTAL_FIXED	20.79151	0.000000
HAR2_TOTAL_LABOR	10.80079	0.000000
HAR2_TOTAL_COST	50.27360	0.000000
HAR2_CO2_M13	8025.362	0.000000
HAR2_CO2_M14	34409.75	0.000000
HAR2_CO2_TOTAL	42435.11	0.000000
HAR2_N2O_M13	0.1869286	0.000000
HAR2_N2O_M14	0.8014801	0.000000
HAR2_N2O_TOTAL	0.9884087	0.000000
HAR2_CH4_M13	9.194918	0.000000
HAR2_CH4_M14	39.42437	0.000000
HAR2_CH4_TOTAL	48.61929	0.000000
HAR2_CO2	3.898059	0.000000
HAR2_N2O	0.9079451E-04	0.000000
HAR2_CH4	0.4466133E-02	0.000000
HAR2_CO2_FINAL	3.898059	0.000000
HAR2_N2O_FINAL	0.9079451E-04	0.000000
HAR2_CH4_FINAL	0.4466133E-02	0.000000
HAR2_CO2_EQ	4.027655	0.000000
TRAN1_PASS_M15	1.000000	0.000000
TRAN1_PASS_M16	1.000000	0.000000
TRAN1_PASS_M17	1.000000	0.000000

TRAN1_MAC_HOURS	6.918814	0.000000
LABOR_15	1.120695	0.000000
LABOR_16	4.400000	0.000000
LABOR_17	2.090000	0.000000
PASS_L15	1.120695	0.000000
PASS_L16	4.400000	0.000000
PASS_L17	2.090000	0.000000
TRAN1_LAB_HOURS	7.610695	0.000000
TRAN1_VARIABLE	89.93846	0.000000
TRAN1_FIXED	40.11783	0.000000
TRAN1_UNALLOCATED_LAB	9.513369	0.000000
TRAN1_HAR1	89.79549	0.000000
TRACTOR_TRAN1	89.93846	0.000000
TRAN1_TOTAL_VARIABLE	179.7339	0.000000
TRACTOR_EQUIP_TRAN1	40.11783	0.000000
TRAN1_GENERALOVERHEAD	12.58138	0.000000
TRAN1_TOTAL_FIXED	52.69921	0.000000
TRAN1_TOTAL_LABOR	124.1495	0.000000
TRAN1_TOTAL_COST	356.5826	0.000000
TRAN1_CO2_M15	244337.5	0.000000
TRAN1_CO2_M16	180367.3	0.000000
TRAN1_CO2_M17	82103.08	0.000000
TRAN1_CO2_TOTAL	506807.9	0.000000
TRAN1_N2O_M15	5.706930	0.000000
TRAN1_N2O_M16	4.201159	0.000000
TRAN1_N2O_M17	2.006168	0.000000
TRAN1_N2O_TOTAL	11.91426	0.000000
TRAN1_CH4_M15	280.7208	0.000000
TRAN1_CH4_M16	206.6527	0.000000
TRAN1_CH4_M17	129.9719	0.000000
TRAN1_CH4_TOTAL	617.3454	0.000000
TRAN1_CO2	46.55501	0.000000
TRAN1_N2O	0.1094435E-02	0.000000
TRAN1_CH4	0.5670891E-01	0.000000
TRAN1_CO2_FINAL	46.55501	0.000000
TRAN1_N2O_FINAL	0.1094435E-02	0.000000
TRAN1_CH4_FINAL	0.5670891E-01	0.000000
TRAN1_CO2_EQ	48.18327	0.000000
TRAN2_PASS_M18	1.000000	0.000000
TRAN2_PASS_M19	1.000000	0.000000
TRAN2_PASS_M20	1.000000	0.000000
TRAN2_MAC_HOURS	3.167340	0.000000
LABOR_18	1.127593	0.000000
LABOR_19	0.2664807	0.000000
LABOR_20	2.090000	0.000000
PASS_L18	1.127593	0.000000
PASS_L19	0.2664807	0.000000
PASS_L20	2.090000	0.000000
TRAN2_LAB_HOURS	3.484074	0.000000
TRAN2_VARIABLE	56.14935	0.000000
TRAN2_FIXED	26.45399	0.000000
TRAN2_UNALLOCATED_LAB	4.355093	0.000000
TRAN2_HAR2	50.27360	0.000000
TRACTOR_TRAN2	56.14935	0.000000

TRAN2_TOTAL_VARIABLE	106.4229	0.000000
TRACTOR_EQUIP_TRAN2	26.45399	0.000000
TRAN2_GENERALOVERHEAD	7.449606	0.000000
TRAN2_TOTAL_FIXED	33.90360	0.000000
TRAN2_TOTAL_LABOR	56.83396	0.000000
TRAN2_TOTAL_COST	197.1605	0.000000
HRS_PER_AC_M_NEW_18	0.8250849	0.000000
TRAN2_CO2_M18	197876.4	0.000000
TRAN2_CO2_M19	10923.73	0.000000
TRAN2_CO2_M20	82103.08	0.000000
TRAN2_CO2_TOTAL	290903.2	0.000000
TRAN2_N2O_M18	4.621750	0.000000
TRAN2_N2O_M19	0.2544381	0.000000
TRAN2_N2O_M20	2.006168	0.000000
TRAN2_N2O_TOTAL	6.882356	0.000000
TRAN2_CH4_M18	227.3414	0.000000
TRAN2_CH4_M19	12.51567	0.000000
TRAN2_CH4_M20	129.9719	0.000000
TRAN2_CH4_TOTAL	369.8289	0.000000
TRAN2_CO2	26.72216	0.000000
TRAN2_N2O	0.6322083E-03	0.000000
TRAN2_CH4	0.3397222E-01	0.000000
TRAN2_CO2_FINAL	26.72216	0.000000
TRAN2_N2O_FINAL	0.6322083E-03	0.000000
TRAN2_CH4_FINAL	0.3397222E-01	0.000000
TRAN2_CO2_EQ	27.69066	0.000000
TRAN3_PASS_M21	1.000000	0.000000
TRAN3_PASS_M22	1.000000	0.000000
TRAN3_PASS_M23	1.000000	0.000000
TRAN3_MAC_HOURS	2.307966	0.000000
LABOR_21	0.4663412	0.000000
LABOR_22	0.9428571	0.000000
LABOR_23	1.129564	0.000000
PASS_L21	0.4663412	0.000000
PASS_L22	0.9428571	0.000000
PASS_L23	1.129564	0.000000
TRAN3_LAB_HOURS	2.538763	0.000000
TRAN3_VARIABLE	42.80352	0.000000
TRAN3_FIXED	33.30078	0.000000
TRAN3_UNALLOCATED_LAB	3.173453	0.000000
TRAN3_HAR2	50.27360	0.000000
TRACTOR_TRAN3	42.80352	0.000000
TRAN3_TOTAL_VARIABLE	93.07712	0.000000
TRACTOR_EQUIP_TRAN3	33.30078	0.000000
TRAN3_GENERALOVERHEAD	6.515398	0.000000
TRAN3_TOTAL_FIXED	39.81618	0.000000
TRAN3_TOTAL_LABOR	41.41357	0.000000
TRAN3_TOTAL_COST	174.3069	0.000000
TRAN3_CO2_M21	44494.77	0.000000
TRAN3_CO2_M22	44980.17	0.000000
TRAN3_CO2_M23	87204.60	0.000000
TRAN3_CO2_TOTAL	176679.5	0.000000
TRAN3_N2O_M21	2.454555	0.000000
TRAN3_N2O_M22	2.481332	0.000000

TRAN3_N2O_M23	5.110649	0.000000
TRAN3_N2O_TOTAL	10.04654	0.000000
TRAN3_CH4_M21	57.98531	0.000000
TRAN3_CH4_M22	58.61788	0.000000
TRAN3_CH4_M23	97.61347	0.000000
TRAN3_CH4_TOTAL	214.2167	0.000000
TRAN3_CO2	16.22966	0.000000
TRAN3_N2O	0.9228675E-03	0.000000
TRAN3_CH4	0.1967779E-01	0.000000
TRAN3_CO2_FINAL	16.22966	0.000000
TRAN3_N2O_FINAL	0.9228675E-03	0.000000
TRAN3_CH4_FINAL	0.1967779E-01	0.000000
TRAN3_CO2_EQ	16.95541	0.000000
TRAN4_PASS_M24	1.000000	0.000000
TRAN4_PASS_M25	1.000000	0.000000
TRAN4_PASS_M26	1.000000	0.000000
TRAN4_MAC_HOURS	6.938814	0.000000
LABOR_24	4.422000	0.000000
LABOR_25	2.090000	0.000000
LABOR_26	1.120695	0.000000
PASS_L24	4.422000	0.000000
PASS_L25	2.090000	0.000000
PASS_L26	1.120695	0.000000
TRAN4_LAB_HOURS	7.632695	0.000000
TRAN4_VARIABLE	205.1734	0.000000
TRAN4_FIXED	47.36311	0.000000
TRAN4_UNALLOCATED_LAB	9.540869	0.000000
TRAN4_HAR2	50.27360	0.000000
TRACTOR_TRAN4	205.1734	0.000000
TRAN4_TOTAL_VARIABLE	255.4470	0.000000
TRACTOR_EQUIP_TRAN4	47.36311	0.000000
TRAN4_GENERALOVERHEAD	17.88129	0.000000
TRAN4_TOTAL_FIXED	65.24440	0.000000
TRAN4_TOTAL_LABOR	124.5083	0.000000
TRAN4_TOTAL_COST	445.1997	0.000000
HRS_PER_AC_M_NEW_26	0.4125424	0.000000
TRAN4_CO2_M24	420998.0	0.000000
TRAN4_CO2_M25	82103.08	0.000000
TRAN4_CO2_M26	98938.21	0.000000
TRAN4_CO2_TOTAL	602039.2	0.000000
TRAN4_N2O_M24	3.085860	0.000000
TRAN4_N2O_M25	2.006168	0.000000
TRAN4_N2O_M26	2.310875	0.000000
TRAN4_N2O_TOTAL	7.402903	0.000000
TRAN4_CH4_M24	605.4699	0.000000
TRAN4_CH4_M25	129.9719	0.000000
TRAN4_CH4_M26	113.6707	0.000000
TRAN4_CH4_TOTAL	849.1124	0.000000
TRAN4_CO2	55.30289	0.000000
TRAN4_N2O	0.6800254E-03	0.000000
TRAN4_CH4	0.7799886E-01	0.000000
TRAN4_CO2_FINAL	55.30289	0.000000
TRAN4_N2O_FINAL	0.6800254E-03	0.000000
TRAN4_CH4_FINAL	0.7799886E-01	0.000000

TRAN4_CO2_EQ	57.29815	0.000000
LOST_TO_YIELD	0.4000000E-01	0.000000
LOST_SW	435.4487	0.000000
EMBED	43.54487	0.000000
CARBON	14.50880	0.000000
CARBON_DEGR	7.254400	0.000000
CARBON_TO_CO2	3.627200	0.000000
E_CO2_LOST	13.29168	0.000000
CARBON_TO_CH4	3.627200	0.000000
E_CH4_LOST	4.847341	0.000000
MULCHED	391.9038	0.000000
CARBON_MULCHED	164.7564	0.000000
MULCHED_CO2	148.2807	0.000000
CO2_FORM_MULCH	543.3667	0.000000
MULCHED_CH4	16.47564	0.000000
CH4_FORM_MULCH	22.01781	0.000000
E_CO2_LOST_ACRE	556.6584	0.000000
E_CH4_LOST_ACRE	26.86515	0.000000
E_GHG_LOST_ACRE	1174.557	0.000000
NET_E_CO2_LOST	51.13424	0.000000
NET_E_CH4_LOST	2.467814	0.000000
NET_E_N2O_LOST	0.000000	0.000000
NET_GHG_LOST	107.8940	0.000000
N_FERT	1.000000	0.000000
N_VOLALIZED	0.1000000	0.000000
N2O_VOLATIZED	0.000000	0.000000
N_VOLATIZED	0.000000	0.000000
N2O_UNVOLATIZED	11.25000	0.000000
RUNOFF_N2O	22.50000	0.000000
TOTAL_N2O	33.75000	0.000000
TOTAL_CO2_SW	0.000000	0.000000
TOTAL_N2O_SW	0.1546901	0.000000
NITROGEN_USE	49.89600	0.000000
TOTAL_CH4_SW	0.000000	0.000000
SOIL_CO2	1631940.	0.000000
SOIL_ENERGY	0.000000	0.000000
SOIL_E_CO2	149.9088	0.000000
SOIL_E_N2O	0.000000	0.000000
SOIL_E_CH4	0.000000	0.000000
SEQ_ENERGY	0.000000	0.000000
SW_KGS	1.000000	0.000000
SEQ_CO2	1540.533	0.000000
SEQ_N2O	0.000000	0.000000
SEQ_CH4	0.000000	0.000000
ENRGY_N	61412.60	0.000000
CO2_N_PROD	3816.050	0.000000
N2O_N_PROD	0.5952300E-01	0.000000
CH4_N_PROD	9.753600	0.000000
N_GHG_PROD	4058.002	0.000000
ENERGY_NIT	3064243.	0.000000
E_CO2_NIT	190405.6	0.000000
E_CH4_NIT	486.6656	0.000000
E_N2O_NIT	2.969960	0.000000
E_GHG_NIT	202478.0	0.000000

ENERGY_NET_N	281.4792	0.000000
NET_E_CO2_NIT	17.49052	0.000000
NET_E_N2O_NIT	0.2728184E-03	0.000000
NET_E_CH4_NIT	0.4470475E-01	0.000000
NET_GHG_NIT	18.59949	0.000000
ENERGY_P	23138.88	0.000000
CO2_P_PROD	1574.910	0.000000
N2O_P_PROD	0.1502300E-01	0.000000
CH4_P_PROD	2.436600	0.000000
P_GHG_PROD	1635.399	0.000000
P_USE	19.95840	0.000000
ENERGY_P2O5	461815.0	0.000000
E_CO2_P	31432.68	0.000000
E_CH4_P	48.63064	0.000000
E_N2O_P	0.2998350	0.000000
E_GHG_P	32639.94	0.000000
ENERGY_NET_P	42.42200	0.000000
NET_E_CO2_P	2.887384	0.000000
NET_E_N2O_P	0.2754263E-04	0.000000
NET_E_CH4_P	0.4467175E-02	0.000000
NET_GHG_P	2.998281	0.000000
ENERGY_K	10409.41	0.000000
CO2_K_PROD	735.1500	0.000000
N2O_K_PROD	0.7423000E-02	0.000000
CH4_K_PROD	1.124600	0.000000
K_GHG_PROD	763.2130	0.000000
K_USE	19.95840	0.000000
ENERGY_K2O	207755.2	0.000000
E_CO2_K	14672.42	0.000000
E_CH4_K	22.44522	0.000000
E_N2O_K	0.1481512	0.000000
E_GHG_K	15232.51	0.000000
ENERGY_NET_K	19.08424	0.000000
NET_E_CO2_K	1.347798	0.000000
NET_E_N2O_K	0.1360906E-04	0.000000
NET_E_CH4_K	0.2061801E-02	0.000000
NET_GHG_K	1.399247	0.000000
ENERGY_A	269077.3	0.000000
CO2_A_PROD	19290.07	0.000000
N2O_A_PROD	0.1736230	0.000000
CH4_A_PROD	28.37560	0.000000
A_GHG_PROD	19994.10	0.000000
A_USE	0.9979200	0.000000
ENERGY_AT	268517.6	0.000000
E_CO2_A	19249.95	0.000000
E_CH4_A	28.31658	0.000000
E_N2O_A	0.1732619	0.000000
E_GHG_A	19952.51	0.000000
ENERGY_NET_A	24.66584	0.000000
NET_E_CO2_A	1.768286	0.000000
NET_E_N2O_A	0.1591571E-04	0.000000
NET_E_CH4_A	0.2601141E-02	0.000000
NET_GHG_A	1.832824	0.000000
DIESEL_INPUT	26454.37	0.000000

ELECT_INPUT	3474.485	0.000000
FUEL_DIESEL	31680.67	0.000000
CO2_EMIT_D	2492.901	0.000000
N2O_EMIT_D	0.5822607E-01	0.000000
CH4_EMIT_D	2.864109	0.000000
ELEC_ENERGY	11333.43	0.000000
CO2_EMIT_E	715.2923	0.000000
N2O_EMIT_E	0.5242998E-02	0.000000
CH4_EMIT_E	1.028708	0.000000
ENERGY_DE	43014.10	0.000000
CO2_DE	3208.193	0.000000
N2O_DE	0.6346907E-01	0.000000
CH4_DE	3.892817	0.000000
GHG_DE	3316.515	0.000000
SOIL_EFFECIENCY	1.000000	0.000000
CO2_EMIT_LIME_APP	439704.3	0.000000
ENERGY_LIME	43014.10	0.000000
CO2_DE_LIME	442912.5	0.000000
N2O_DE_LIME	0.6346907E-01	0.000000
CH4_DE_LIME	3.892817	0.000000
GHG_DE_LIME	443020.8	0.000000
LIME_TONNES	1.000000	0.000000
RAIL	0.6000000	0.000000
DIST_RAIL	795.3601	0.000000
DIESEL_RAIL	0.1038093	0.000000
TRUCK	0.4000000	0.000000
DIST_TRUCK	100.0000	0.000000
DIESEL_TRUCK	0.9594224E-01	0.000000
ENERGY_RAIL	124317.8	0.000000
CO2_RAIL	9756.105	0.000000
N2O_RAIL	0.2284843	0.000000
CH4_RAIL	10.86012	0.000000
ENERGY_TRUCK	114896.5	0.000000
CO2_TRUCK	9041.021	0.000000
N2O_TRUCK	0.2111689	0.000000
CH4_TRUCK	10.38728	0.000000
ENERGY_RT	239214.3	0.000000
CO2_RT	18797.13	0.000000
N2O_RT	0.4396532	0.000000
CH4_RT	21.24740	0.000000
GHG_RT	19415.95	0.000000
FUEL_PROD_TRANS	282228.4	0.000000
CO2_PROD_TRANS	461709.6	0.000000
N2O_PROD_TRANS	0.5031223	0.000000
CH4_PROD_TRANS	25.14022	0.000000
GHG_PROD_TRANS	462436.7	0.000000
LIME_FUEL_ENERGY	4.703886	0.000000
LIME_CO2_PROD_TRANS	7.695290	0.000000
LIME_N2O_PROD_TRANS	0.8385513E-05	0.000000
LIME_CH4_PROD_TRANS	0.4190107E-03	0.000000
LIME_GHG_PROD_TRANS	7.707409	0.000000
SW_KWH	0.9190398	0.000000
E_COAL	0.7387734	0.000000
NOX_SW	3.366156	0.000000



SOX_SW	0.1717427	0.000000
CO2_SW	1525.128	0.000000
N2O_SW	0.8930619E-01	0.000000
CH4_SW	0.1442638	0.000000
CO_SW	4.121824	0.000000
ASH_SW	51.85360	0.000000
NOX_COAL	6.000000	0.000000
NOX_C_ALONE	2.780790	0.000000
SOX_COAL	17.16194	0.000000
SOX_C_ALONE	7.953958	0.000000
CO2_COAL	2085.453	0.000000
CO2_C_ALONE	966.5346	0.000000
N2O_COAL	0.3125278E-01	0.000000
N2O_C_ALONE	0.1448457E-01	0.000000
CH4_COAL	0.2232342E-01	0.000000
CH4_C_ALONE	0.1034612E-01	0.000000
CO_COAL	0.2500000	0.000000
CO_C_ALONE	0.1158662	0.000000
ASH_COAL	92.87219	0.000000
ASH_C_ALONE	43.04301	0.000000
WEIGHT_CO	0.1545490	0.000000
WT_COAL	766.9802	0.000000
WT_SW	140.2045	0.000000
TOTAL_WT	907.1847	0.000000
THERMAL_COAL	17.10818	0.000000
THERMAL_SW	2.123378	0.000000
TOTAL_THERMAL	19.23156	0.000000
ELEC_COAL	1654.883	0.000000
ELEC_SW	193.2803	0.000000
COAL_FOR_ELEC	0.4149959	0.000000
SW_FOR_ELEC	0.7586156E-01	0.000000
ELEC_FROM_COAL	0.8954203	0.000000
ELEC_FROM_SW	0.1045797	0.000000
NOX_C_COFIRE	2.489976	0.000000
SOX_C_COFIRE	7.122136	0.000000
CO2_C_COFIRE	865.4547	0.000000
N2O_C_COFIRE	0.1296978E-01	0.000000
CH4_C_COFIRE	0.9264128E-02	0.000000
CO_C_COFIRE	0.1037490	0.000000
ASH_C_COFIRE	38.54158	0.000000
NOX_SW_COFIRE	0.2553619	0.000000
SOX_SW_COFIRE	0.1302867E-01	0.000000
CO2_SW_COFIRE	115.6986	0.000000
N2O_SW_COFIRE	0.6774907E-02	0.000000
CH4_SW_COFIRE	0.1094408E-01	0.000000
CO_SW_COFIRE	0.3126880	0.000000
ASH_SW_COFIRE	3.933695	0.000000
NOX_COFIRE	2.745338	0.000000
SOX_COFIRE	7.135164	0.000000
CO2_COFIRE	981.1533	0.000000
N2O_COFIRE	0.1974469E-01	0.000000
CH4_COFIRE	0.2020821E-01	0.000000
CO_COFIRE	0.4164370	0.000000
ASH_COFIRE	42.47528	0.000000

GHG_COFIRE	987.4625	0.000000
SOX_UNCONTROL_C_ALONE	7.953958	0.000000
SOX_AFTER_CONTROL	4.671700	0.000000
SOX_CONTROLLED	3.282258	0.000000
WASTE_TARGET	21.36328	0.000000
BEFORE_CONTROL	7.135164	0.000000
REMOVED_SOX	3.282258	0.000000
REDUCTION_SOX	0.8187938	0.000000
CACO3_NEED	5.436036	0.000000
EMISSION_CO2	2.254951	0.000000
CASO4_CACO3_WASTE	7.283139	0.000000
WASTE_FROM_COAL	60.39838	0.000000
WASTE_CHANGE	0.5677291	0.000000
TOTAL_WASTE_COFIRE	60.96610	0.000000
WASTE_LAND_FILL	39.60282	0.000000
CO2_TRANSPORT_WASTE	0.8951249E-01	0.000000
N2O_TRANSPORT_WASTE	0.2090721E-05	0.000000
CH4_TRANSPORT_WASTE	0.1028414E-03	0.000000
GHG_TRANSPORT_WASTE	0.9249670E-01	0.000000
CO2_SOX_REACTION	2.254951	0.000000
N2O_SOX_REACTION	0.000000	0.000000
CH4_SOX_REACTION	0.000000	0.000000
NET_E_N2O_LOST	0.000000	0.000000
CO2_LIMESTONE	2.374573	0.000000
N2O_LIMESTONE	0.2734991E-05	0.000000
CH4_LIMESTONE	0.1366631E-03	0.000000
GHG_LIMESTONE	2.378526	0.000000
CO2_111	893.0608	0.000000
N2O_111	0.2117284E-01	0.000000
CH4_111	1.297544	0.000000
GHGCO2EQ_111	929.1715	0.000000
CO2_211	893.0424	0.000000
N2O_211	0.2117241E-01	0.000000
CH4_211	1.297521	0.000000
GHGCO2EQ_211	929.1524	0.000000
CO2_122	890.7610	0.000000
N2O_122	0.2109226E-01	0.000000
CH4_122	1.294736	0.000000
GHGCO2EQ_122	926.7833	0.000000
CO2_123	889.9651	0.000000
N2O_123	0.2111431E-01	0.000000
CH4_123	1.293652	0.000000
GHGCO2EQ_123	925.9689	0.000000
CO2_124	892.9292	0.000000
N2O_124	0.2109588E-01	0.000000
CH4_124	1.298076	0.000000
GHGCO2EQ_124	929.0293	0.000000
CO2_222	890.7427	0.000000
N2O_222	0.2109182E-01	0.000000
CH4_222	1.294713	0.000000
GHGCO2EQ_222	926.7642	0.000000
CO2_223	889.9467	0.000000
N2O_223	0.2111387E-01	0.000000
CH4_223	1.293628	0.000000

GHGCO2EQ_223	925.9498	0.000000
CO2_224	892.9108	0.000000
N2O_224	0.2109545E-01	0.000000
CH4_224	1.298053	0.000000
GHGCO2EQ_224	929.0103	0.000000
COST_PROD_MAN_PASTURE_TRAN1	462.5692	0.000000
COST_PROD_MAN_RECROP_TRAN1	476.4384	0.000000
COST_PROD_MAN_PASTURE_TRANS2	303.1471	0.000000
COST_PROD_MAN_RECROP_TRAN2	317.0162	0.000000
COST_PROD_MAN_PASTURE_TRANS3	280.2934	0.000000
COST_PROD_MAN_RECROP_TRAN3	294.1626	0.000000
COST_PROD_MAN_PASTURE_TRANS4	551.1863	0.000000
COST_PROD_MAN_RECROP_TRAN4	565.0555	0.000000
C1	0.000000	0.000000
C2	0.000000	0.1152310E-02
C3	0.000000	0.5679818E-04
C4	0.000000	0.1444761E-03
C5	1.000000	-0.8767791E-04
C6	0.000000	0.000000
C7	0.000000	0.1624852E-02
C8	0.000000	0.000000
COST_OF_PRODUCTION	23.35779	0.000000
G1	0.000000	0.1064632E-02
G2	0.000000	0.000000
G3	0.000000	0.000000
G4	1.000000	0.000000
G5	0.000000	0.000000
G6	0.000000	0.000000
G7	0.000000	0.000000
G8	0.000000	0.1712530E-02
GHG_ALTERNATIVE	925.9689	0.000000
I	1.000000	0.000000
OFFSET_COST	462.9844	0.000000
COST_OF_COAL	25.52000	0.000000

### A.3 – Lingo code for allocation strategy with two existing plants and a new plant

```

MIN = COST + GHG + DIST;
COST = COST_A + COST_B + COST_C;
COST_A = ((COST1 + COST11)/2); COST_B = ((COST2+COST22)/2); COST_C =
((COST3+COST33)/2);
GHG = GHG1 + GHG2 + GHG3;
DIST = DIST1 + DIST2 + DIST3;
D_SW1_E1 = 1.414;
D_SW1_E2 = 5.657;
D_SW2_E1 = 7.071;
D_SW2_E2 = 2.828;
D_C1_E1 = 2.828;
D_C1_E2 = 1.414;
D1_SW1_N1 = 1;
D1_SW2_N1 = 7.810249676;
D1_C1_N1 = 3.605551275;
D2_SW1_N1 = 0.707106781;
D2_SW2_N1 = 7.778174593;
D2_C1_N1 = 3.535533906;
D3_SW1_N1 = 7.071067812;
D3_SW2_N1 = 1.414213562;
D3_C1_N1 = 2.828427125;
D4_SW1_N1 = 7.810249676;
D4_SW2_N1 = 1;
D4_C1_N1 = 3.605551275;
D1 + D2 + D3 + D4 = 1;
@BIN(D1);
@BIN(D2);
@BIN(D3);
@BIN(D4);
A1 + A2 + A3 + A4 = 1;
@BIN(A1);
@BIN(A2);
@BIN(A3);
@BIN(A4);
B1 + B2 + B3 + B4 = 1;
@BIN(B1);
@BIN(B2);
@BIN(B3);
@BIN(B4);
A1 = D1; A2 = D2; A3 = D3; A4 = D4; A1 = B1; A2 = B2; A3 = B3; A4 = B4;
D_SW1_N1 = D1_SW1_N1 * D1 + D2_SW1_N1 * D2 + D3_SW1_N1 * D3 + D4_SW1_N1
* D4;
D_SW2_N1 = D1_SW2_N1 * B1 + D2_SW2_N1 * B2 + D3_SW2_N1 * B3 + D4_SW2_N1
* B4;
D_C1_N1 = D1_C1_N1 * A1 + D2_C1_N1 * A2 + D3_C1_N1 * A3 + D4_C1_N1 *
A4;
COFIRE1 >= 0.05;
COFIRE1 <= 0.2;
COFIRE2 >= 0.05;
COFIRE2 <= 0.2;
COFIRE3 >=0.05;

```

```

COFIRE3 <=0.7;
PLANT_SIZE1 >= 25;
PLANT_SIZE1 <=300;
PLANT_SIZE2 >= 25;
PLANT_SIZE2 <=300;
PLANT_SIZE3 >= 100;
PLANT_SIZE3 <= 300;
PLANT_SIZE1 + PLANT_SIZE2 + PLANT_SIZE3= 400;
SW_REQD1 =69.28*COFIRE1 - 0.0511;
SW_REQD2 =69.28*COFIRE2 - 0.0511;
COAL_REQD1 = -44.264 * COFIRE1 + 46.379;
COAL_REQD2 = -44.264 * COFIRE2 + 46.379;
COST11 = 0.0049 * COFIRE1 + 0.0118;
COST22 = 0.0049 * COFIRE2 + 0.0118;
COST33 = 0.0049 * COFIRE3 + 0.0118;
COST1 = -0.015 * EFFICIENCY1 + 0.0203;
COST2 = -0.015 * EFFICIENCY2 + 0.0203;
COST3 = -0.015 * EFFICIENCY3 + 0.0203;
GHG1 = -951.91 * COFIRE1 + 1032.9;
GHG2 = -951.91 * COFIRE2 + 1032.9;
GHG3 = -951.91 * COFIRE3 + 1032.9;
!DEMAND1 = 7* 10^7 * COFIRE1 + 10^8;
!DEMAND2 = 7* 10^7 * COFIRE2 + 10^8;
!DEMAND3 = 7* 10^7 * COFIRE3 + 10^8;
DEMAND1 = 3 * 10^6 * PLANT_SIZE1 + 30;
DEMAND2 = 3 * 10^6 * PLANT_SIZE2 + 30;
DEMAND3 = 3 * 10^6 * PLANT_SIZE3 + 30;
EFFICIENCY1 = 0.03*@LOG(PLANT_SIZE1) + 0.3681;
EFFICIENCY2 = 0.03*@LOG(PLANT_SIZE2) + 0.3681;
EFFICIENCY3 = 0.03*@LOG(PLANT_SIZE3) + 0.3681;
QUANT_SW1_E1 + QUANT_SW1_E2 + QUANT_SW1_N1 <= (SW_REQD1 * 100000000);
QUANT_SW2_E1 + QUANT_SW2_E2 + QUANT_SW2_N1 <= (SW_REQD2 * 100000000);
QUANT_C1_E1 + QUANT_C1_N1 <= (COAL_REQD1 * 100000000);
QUANT_C1_E2 + QUANT_C1_N1 <= (COAL_REQD2 * 100000000);
QUANT_C1_E1 = (1-COFIRE1)*(QUANT_SW1_E1 + QUANT_SW2_E1 + QUANT_C1_E1);
QUANT_C1_E2 = (1-COFIRE2)*(QUANT_SW1_E2 + QUANT_SW2_E2 + QUANT_C1_E2);
QUANT_C1_N1 = (1-COFIRE3)*(QUANT_SW1_N1 + QUANT_SW2_N1 + QUANT_C1_N1);
QUANT_SW1_E1 + QUANT_SW2_E1 + QUANT_C1_E1 >= DEMAND1;
QUANT_SW1_E2 + QUANT_SW2_E2 + QUANT_C1_E2 >= DEMAND2;
QUANT_SW1_N1 + QUANT_SW2_N1 + QUANT_C1_N1 >= DEMAND3;
DIST1 = QUANT_SW1_E1 * D_SW1_E1 + QUANT_SW2_E1 * D_SW2_E1 + QUANT_C1_E1
* D_C1_E1;
DIST2 = QUANT_SW1_E2 * D_SW1_E2 + QUANT_SW2_E2 * D_SW2_E2 + QUANT_C1_E2
* D_C1_E2;
DIST3 = QUANT_SW1_N1 * D_SW1_N1 + QUANT_SW2_N1 * D_SW2_N1 + QUANT_C1_N1
* D_C1_N1;
END

```

#### A.4 – Lingo solution for allocation strategy with two existing plants and a new plant

Local optimal solution found at iteration: 571  
 Objective value: 0.2199562E+10

Variable	Value	Reduced Cost
COST	0.3925967E-01	0.000000
GHG	2153.618	0.000000
DIST	0.2199560E+10	0.000000
COST_A	0.1292503E-01	0.000000
COST_B	0.1261374E-01	0.000000
COST_C	0.1372090E-01	0.000000
COST1	0.1307557E-01	0.000000
COST11	0.1277449E-01	0.000000
COST2	0.1296713E-01	0.000000
COST22	0.1226036E-01	0.000000
COST3	0.1221180E-01	0.000000
COST33	0.1523000E-01	0.000000
GHG1	843.5883	0.000000
GHG2	943.4671	0.000000
GHG3	366.5630	0.000000
DIST1	0.3362121E+09	0.000000
DIST2	0.2598485E+09	0.000000
DIST3	0.1603499E+10	0.000000
D_SW1_E1	1.414000	0.000000
D_SW1_E2	5.657000	0.000000
D_SW2_E1	7.071000	0.000000
D_SW2_E2	2.828000	0.000000
D_C1_E1	2.828000	0.000000
D_C1_E2	1.414000	0.000000
D1_SW1_N1	1.000000	0.000000
D1_SW2_N1	7.810250	0.000000
D1_C1_N1	3.605551	0.000000
D2_SW1_N1	0.7071068	0.000000
D2_SW2_N1	7.778175	0.000000
D2_C1_N1	3.535534	0.000000
D3_SW1_N1	7.071068	0.000000
D3_SW2_N1	1.414214	0.000000
D3_C1_N1	2.828427	0.000000
D4_SW1_N1	7.810250	0.000000
D4_SW2_N1	1.000000	0.000000
D4_C1_N1	3.605551	0.000000
D1	0.000000	0.000000
D2	0.000000	0.000000
D3	0.000000	0.000000
D4	1.000000	0.000000
A1	0.000000	0.4290457E+10
A2	0.000000	0.4251345E+10
A3	0.000000	0.5113103E+08
A4	1.000000	0.000000
B1	0.000000	0.000000

B2	0.000000	0.000000
B3	0.000000	0.000000
B4	1.000000	0.000000
D_SW1_N1	7.810250	0.000000
D_SW2_N1	1.000000	0.000000
D_C1_N1	3.605551	0.000000
COFIRE1	0.1988756	0.000000
COFIRE2	0.9395099E-01	0.000000
COFIRE3	0.7000000	0.000000
PLANT_SIZE1	44.00469	0.000000
PLANT_SIZE2	55.99531	0.000000
PLANT_SIZE3	300.0000	0.000000
SW_REQD1	13.72700	0.000000
SW_REQD2	6.457825	0.000000
COAL_REQD1	37.57597	0.000000
COAL_REQD2	42.22035	0.000000
EFFICIENCY1	0.4816289	0.000000
EFFICIENCY2	0.4888580	0.000000
EFFICIENCY3	0.5392135	0.000000
DEMAND1	0.1320141E+09	0.000000
DEMAND2	0.1679860E+09	0.000000
DEMAND3	0.9000000E+09	0.000000
QUANT_SW1_E1	0.2625438E+08	0.000000
QUANT_SW1_E2	0.000000	2.693960
QUANT_SW1_N1	0.000000	2.248277
QUANT_SW2_E1	0.000000	5.344919
QUANT_SW2_E2	0.1578245E+08	0.000000
QUANT_SW2_N1	0.6300000E+09	0.000000
QUANT_C1_E1	0.1057597E+09	0.000000
QUANT_C1_N1	0.2700000E+09	0.000000
QUANT_C1_E2	0.1522035E+09	0.000000

## VITA

Tanya Mohan, daughter of Dr. Harsh and Dr. Praveen Mohan, was born October 2, 1981, in Rohtak, India. She has one sister, Sugandha Mohan. Tanya graduated from Thapar Institute of Engineering and Technology, Patiala, India with a Bachelor of Engineering degree in Chemical Engineering in May 2003. While attending Thapar Institute of Engineering and Technology, she was awarded Outstanding Student Merit Scholarships in 2000-2003. Her professional experiences include employment as intern in Pfizer Ltd., Chandigarh, India; and Punjab State Council for Science and Technology, Chandigarh, India. She joined the graduate program at Texas A&M University in August 2003. Ms. Mohan completed a Certificate in Business from Mays Business School, Texas A&M University in May 2005. She graduated from Texas A&M University in December 2005 with Masters of Science in Chemical Engineering under the guidance of Dr. Mahmoud M. El-Halwagi. While at Texas A&M University, she was involved in process systems engineering projects with Department of Energy, Department of Agriculture, National Resources Conservation Service and Matrix Process Integration.

Ms. Mohan's address is Department of Chemical Engineering, c/o Dr. Mahmoud M. El-Halwagi, 3122 TAMU, College Station, TX-77843. Her email address is tanyamohan@gmail.com.