

CONTROL OF STAND-ALONE PHOTOVOLTAIC SYSTEM USING FUZZY-LOGIC CONTROLLER

A.MELLIT

M.BENGHANME

A. HADJ ARAB

A.GUESSOUM

UNIVERSITY OF SCIENCES TECHNOLOGY
HOUARI BOUMEDIENE (USTHB), FACULTY OF
ELECTRICAL ENGINEERING, EL-ALIA, P.O.BOX
32. ALGIERS 16111 ALGERIA
PHONE/FAX: (213) 21 21 82 14
mellit_adel2001@yahoo.fr ,
m.benghanem@caramail.com

DEVELOPMENT CENTER
OF RENEWABLE ENERGY
(CDER), P.O.BOX 62,
BOUZARÉAH, ALGIERS
16000, ALGERIA
hadjarab@hotmail.com

MINISTRY FOR THE
HIGHER EDUCATION AND
SCIENTIFIC RESEARCH,
ALGIERS, ALGERIA
guessouma@hotmail.com

ABSTRACT

With industrial development the problem of energy shortage is more and more aggravating. The photovoltaic (PV) systems are rapidly expanding and have increasing in electric power technology and regarded as the green energy of the new century control, sizing and management of stand-alone photovoltaic systems are based on static method and energy estimation allowing the simulation of PV system in average condition. Indeed these approaches provide information about the expected performances and acceptable satisfactions rates they do not perform an optimisation of the PV plant for the local climate conditions. The power supplied by solar arrays depends on the radiation, temperature and array voltage, the operation point of a load connected at the boundaries of a photovoltaic generator always does not coincide with that of the optimal point and it varied according to the weather conditions, in this way it's necessary to track the maximum power of solar arrays. The purpose of this work is to use the fuzzy-logic controller (flc) in order to control of maximum power point tracker (mppt) of PV generator under variable radiation conditions. For this, we used as solution the control of the mppt variation in order to deliver the highest power to the load; also we implemented a controller circuit between PC and the regulator system. The designed system is applicable for remote areas or isolated leads and the sizing of stand-alone PV system. Obtained result indicates that the proposed method can successfully be used for control of mppt for stand-alone PV system.

1. INTRODUCTION

In designing a PV generator, one must, because of economic and sizing reasons, obtain the maximum amount of energy converted to meet the load requirements. A PV-array can operate over a wide range of output voltage and output current. The power supply by solar array on the light illumination intensity temperature and array voltage. It's necessary to track the maximum power of the solar arrays. Some paper proposed the different maximum power point MPPT control methods [1-4]. In this work we present a method based on fuzzy-logic controller as tool, for control by the variation of the cyclic report in order to ensure a good profitability of the system and a good exploitation of solar energy. This work is divided in to four section: In section one we present the

methodology and the principal of fuzzy-logic controller, section two is devoted to present the experimental realization, in section three we present the results and discussions. Finally the sizing application of stand-alone PV system is presented in section four.

2. METHODOLOGY

The principle of this method consists in applying the fuzzy technique to the optimal research of the point of PV generator. To this end, we took for the measurement of the I-V characteristic. Initially we establish an interpolation method then we pass to the interpolation of the fuzzy controller. Several methods can be used for the measurement of the I-V characteristic (Fig.1) of a module according to the method adopted. In our case we use the variable resistive load. The principle is simple, it consists to varying the resistance connected at the boundaries of PV generator and to take tensions V_m and currents I correspondents. Figure 2 shows the P-V characteristic for different radiation values.

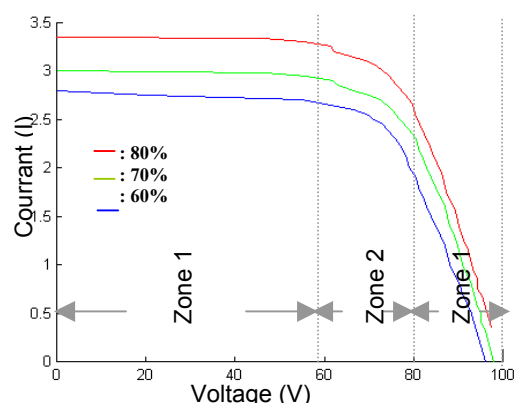

Figure 1. I-V characteristic for different radiation values

In order to determiner the V_{opt} for various radiations it is necessary to establish the I-V characteristic one for different radiation. For that, we use the equations of following translations:

$$I_b = I_a + I_{CC} \left(\frac{E_b}{E_a} - 1 \right) + \Delta t \cdot \alpha \quad (1)$$

$$V_b = V_a + \Delta t \cdot \beta - R_S \cdot \Delta I - K_C I_b \cdot \Delta t \quad (2)$$

Where $\alpha = 1.65 \cdot 10^{-3}$, $\beta = 7.7 \cdot 10^{-3}$ and $K_C = 5.6 \cdot 10^{-3}$

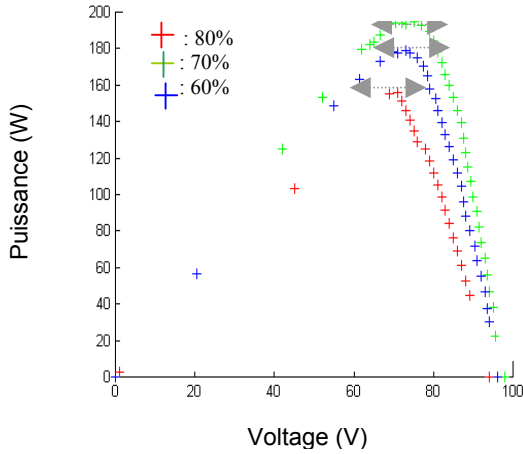

Figure 2. P-V characteristic for different radiation values

The interpolated curve (Fig.3) allows us to determine the variation of V_{opt} and V_{oc} according to the radiation. It is indeed equal to the following approximation:

$$V_{opt} = 0.8 \cdot V_{oc} \quad (3)$$

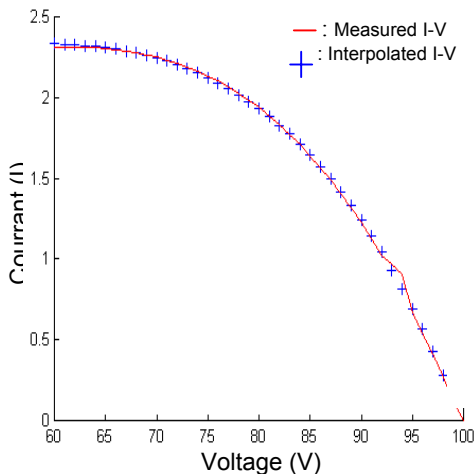

Figure 3. I-V Interpolated characteristic

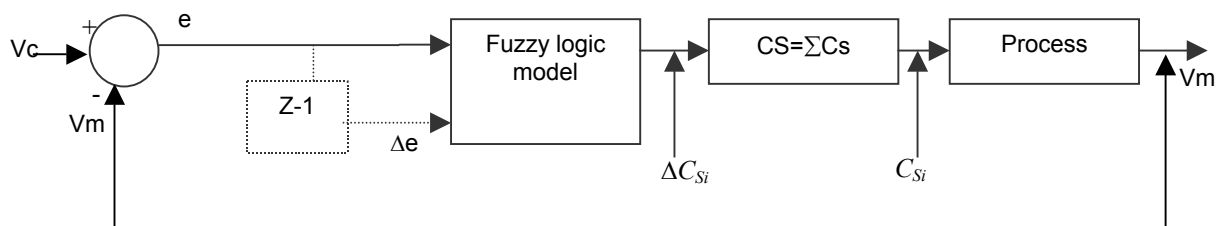

Fig.4 Structure of regulator by Fuzzy-logic

The regulator in what follows have in input the optimal tension describes by the equation (3). Figure 4 shows the structure of fuzzy-logic controller, it consists of the process to be controlled. This last provides the control signal (C_s), it receive at its input the difference between consign (V_c) and the measured parameter (V_m) corresponding also the variation error (Δe).

Where $e = (V_c - V_m)$; $\Delta e = [e(t) - e(t-1)]$, $\Delta e = [V_m(t-1) - V_m(t)]$.

According to the I-V characteristic (Fig.1) we notice that the variation of the tension of a beach to another beach, for that we can divides the characteristic into three zones:

- Zone1 [0 60] : Generating operation of current or the variation of the tension is fast.
- Zone2 [60 80] : Operation of the optimum point or the beach of almost constant variation.
- Zone3: [80 100] : Generating operation of tension or the variation of the tension is slow.

We based on these zones and by taking account of the variation tension according to the cyclic report, the rules of control inspired are gathered in the decision table 1 so above.

In our command, we used the reasoning of the *SEGENO* [5-6] whose rule is form:

if the error is PM And the derive one is NL then the cyclic report is NL .

Where {NL: Negative Large; NM: Negative Means; AZ: About Zero; PM: Positive Means ; PL: Positive Large} is the set of the subsets

Table 1. The fuzzy rules

| e Δe | NL | NM | AZ | PM | PL |
|---------|----|----|----|----|----|
| NL | PL | PP | AZ | NL | NL |
| NM | PL | PP | AZ | NL | NL |
| AZ | PE | PM | AZ | NL | NL |
| PM | PE | PM | PP | NM | NM |
| PL | PE | PM | PP | NM | NM |

3. EXPERIMENTAL REALISATION

In this section we present the experimental realization of the system, designed system is divided in two parts: First part is the data acquisition card, which allows the processing of the input signal collected by PV generator connected to the PC (RS-232 Port). The second part is an interface of power that orders a chopper-reducing transformer it base on the powers transistors. Designed system is described in the figure 5, the measurement of the array voltage of PV generator is taken after a filtering using a capacity which is placed at its end, this capacitor allows to varying the voltage with the turn of the operation point, and this voltage is divider into 1/24, followed by a tracker for the adaptation of impedance. In order to decrease the fluctuations and supply of the average value parameter we use a passes low filter. The signal resulting is injected into A/D converter via the parallel port of the PC this will be to treat later by a program which gives a numerical value which is converted in its turn by a D/A converter. The control signal of the chopper results from a comparator which one of the inputs comes from the PC and the other of generator triangular signal. These impulses command the power transistor connected to the regulator.

4. RESULTS AND DISCUSSIONS

To emphasize the technique of fuzzy-logic controller we carried out tests practice whose results obtained are indicated in figures 6. Figure 6-a shows the variation of the report cyclic C_s , the impulses intended to attack the chopper according to the command coming from the PC. The figures 6.b and 6-c corresponds respectively to the values of the report cyclic $C_s=0.9, 0.6$. It is seen clearly that more the tension increases more the width of impulse increases what corresponds to a closing of the transistor of one more significant duration power. A cyclic report $R=1$ corresponds to a load connected directly with the PV generator, i.e. without regulator and a cyclic report no one corresponds to an open circuit. Figure 6.d illustrates the operation of our regulator. Initially, the assembly is in open circuit what corresponds to a tension V_{oc} of about 98 Volts. The system is on open circuit what corresponds to a tension V_{oc} about 100V. Once the program launched with a cyclic report $C_s=1$, the tension falls at 30V, which corresponds to the point of operation without regulator, then converges towards the optimal tension of surroundings 80V. This result indicates the correct operation of the developed fuzzy-logic controller system.

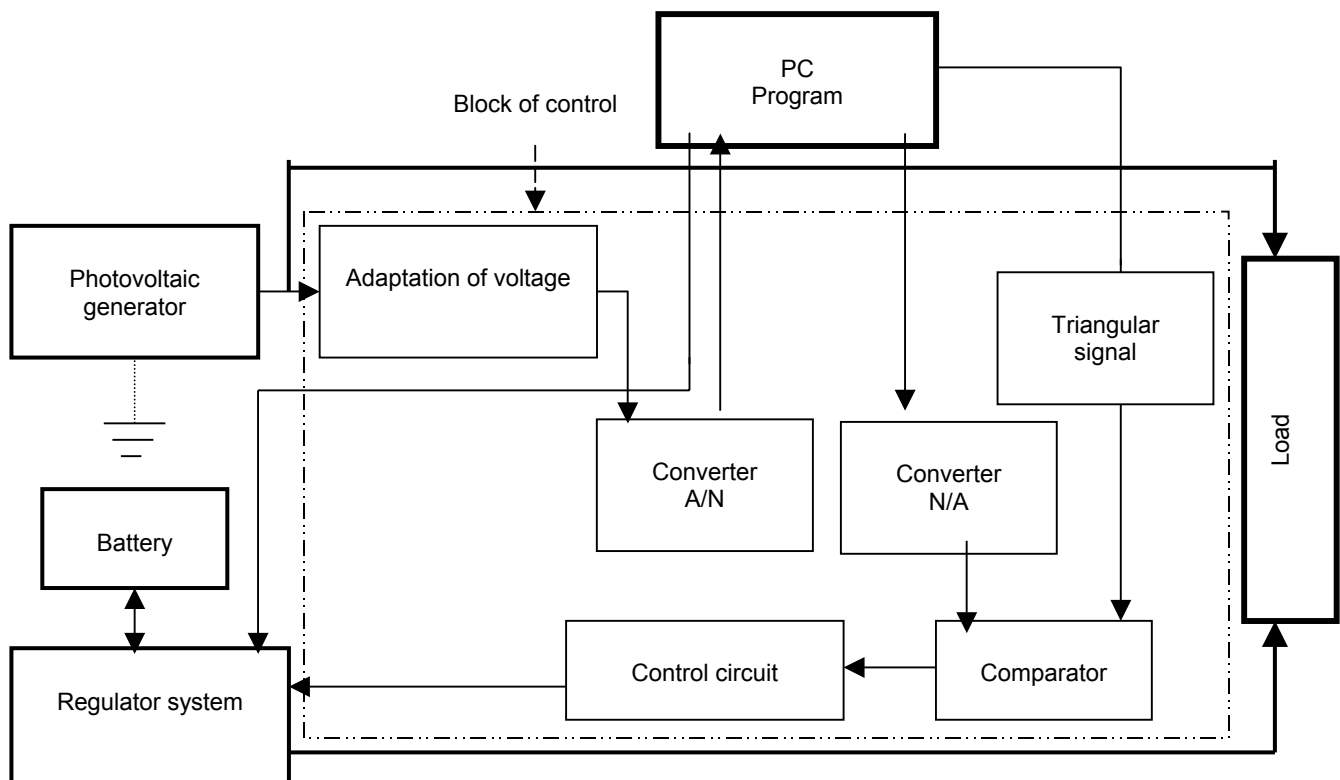

Figure 5. Diagram block of stand-alone PV system controlled by Fuzzy-logic

5. SIZING OF STAND-ALONE PV SYSTEM

In this section we will make a comparison between the results obtained by PV system installed without fuzzy-logic regulator and another experimental system with the fuzzy-logic controller to implement in this work. Firstly we present the elements of the PV system, which we implemented in our laboratory. In continuation we chose a sizing method [7,8] of stand-alone PV systems in order to illustrate the importance of this fuzzy-logic controller.

5.1. DESCRIPTION OF INSTALLED PV SYSTEM

It consists of 4 photovoltaic modules of Sharp type, power Crete 40 W, which had output η_{pv} 10% and of a surface total $A_g = 4 \times 0.3778 \text{ m}^2$, of a system of regulation whose output is $\eta_c = 90\%$ and two lead-acid battery of output $\eta_b = 80\%$. Four PV modules are connected in a configuration parallel-series. PV modules are tilted of a slope equal to the latitude of the site. This experimental PV system is an autonomous system which feeds a load uninterrupted formed of 2 lamps of 40 W of the H4 type, we carried out an electronic device allowing the connection and the automatic disconnection of the load. In our handling we used a constant consumption of 600 Wh/day corresponding to an operation of 7^h30'.

5.2. SIMULATION RESULTS

Figure 7 shows the evolution of the capacity of the PV generator according to storage capacity for Algiers location. According to this figure one note that the capacity of the generator is higher for the system not equipped by the controller on the other hand the system equipped by the regulator with a low capacity. Table 2 shows a comparison between the results obtained by simulation and that obtained in experiments. It is seen well that the system equipped by the controller requires about half of the surface of PV generator compared to other PV system. These results of dimensioning show the importance of this controller for the sizing of stand-alone PV systems.

Table 2. Comparison between experimental and simulated results

| Location | Simulation results | | |
|--|---------------------------|--|---|
| Algiers LLP=1% Load=0.6K Latitude=36°,4 3' | Experimental PV-system | PV system equipped by controller | PV system no equipped by controller |
| PV-array Area (m ²) | 1.51 | 0.9 | 1.65 |

6. CONCLUSION

In this paper we have presented a method for control of the PV system through the MPPT using Fuzzy-logic controller. Designed system has succeeded to reduce the PV-array area and increase their output, obtained result indicates that the proposed method can successfully be used for control of MPPT for stand-alone PV system and give a minimum economic cost, developed controller can be improving by changing the form of the functions of memberships as well as the number of the subsets. Future work will include the investigating the suitability of neuro-fuzzy model for controlling of stand-alone PV systems, and the application of this model for the sizing of photovoltaic systems.

NOMENCLATURE

| | |
|-----------|---|
| I_a | Measured courant of reference |
| I_b | Calculated courant in desired condition |
| V_a | Measured voltage of reference |
| V_b | Calculated voltage in desired condition |
| T_a | Temperature reference |
| T_b | Desired temperature |
| E_a | Radiation reference |
| E_b | Desired radiation |
| V_{opt} | Optimal voltage |
| V_{oc} | Open circuit voltage |
| I_{cc} | Court circuit courant |
| C_s | Cyclic rapport |
| e | Error |
| H | Solar radiation |
| LLP | Loss of Load Pobability |

7. REFERENCES

- [1] Z.Salameh, F.Dagher and W.Alync, "Step down maximum power point tracker for photovoltaic system". *Solar Energy*, 1991, pp. 46-50
- [2] Tetsumi H., Takahiro.T, "A proposal of efficiency improvement with solar power generation system". *IECON01*, 2001,1,
- [3] C.Hua and C Shen, "Study of maximum power techniques and control of DC/DC converters for photovoltaic power system", *29th Annual IEEE PESC, IEEE Computer Soc. Press, New York, USA, 1998*, pp. 86-93,.
- [4] Shengy,L. Maximum power point tracker models, <http://vtengr.se.edu>, January 2001.
- [5] S.SINGER, J.Appelbaum, "Starting characteristics of direct current motors powered by solar cells", *IEEE Transactions on Energy Conversion*, 1993, 8, pp. 47-53.
- [6] J.RTang . "Logique floue". Edition *HERMES*, 1995.
- [7] M.Egido and E. Lorenzo. "The sizing of sand-alone PV systems: A Review and a proposed new method". *Solar Energy Materials and Solar Cells*, 1992, . 26, pp. 51-69
- [8] A.Mellit , M.Benghanem, A.Hadj Arab, and A.Guessoum, "Modelling of sizing the photovoltaic system parameters using artificial neural network". *Proceeding of IEEE, CCA*, 2003, 1, pp.353-357

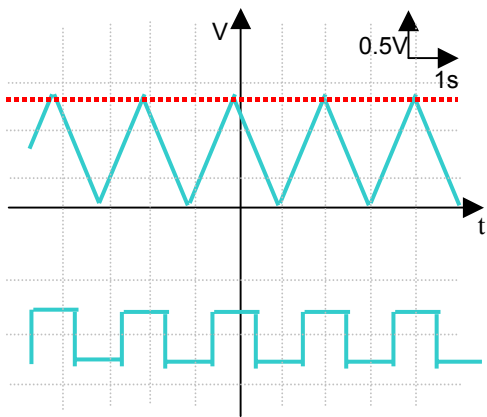

Figure 6-a.

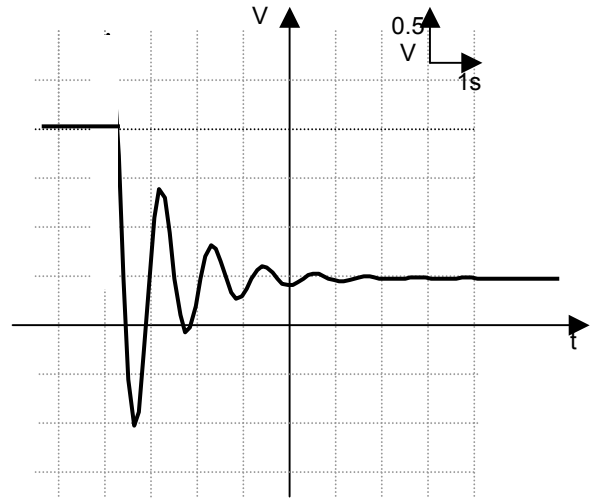

Figure 6.d.

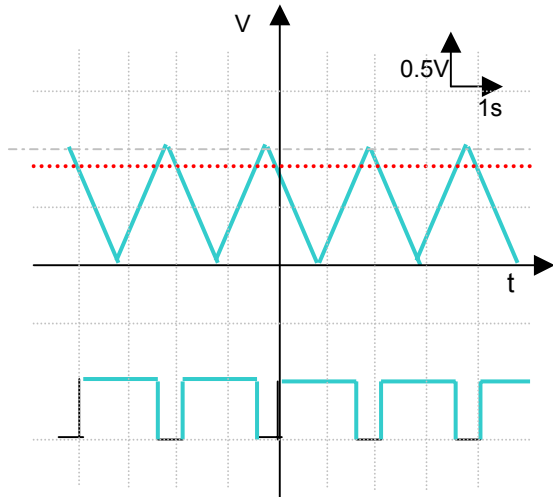

Figure 6-b.

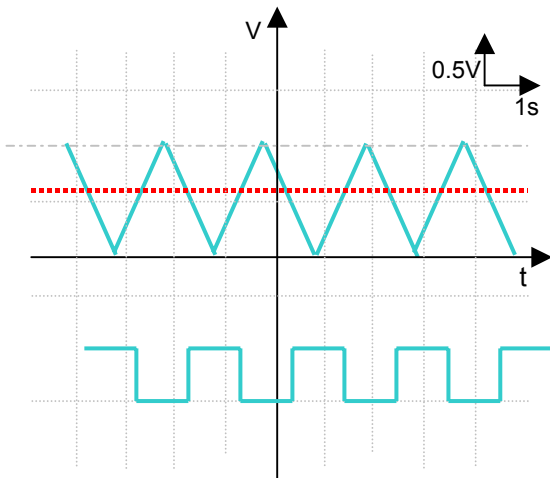

Figure 6-c.

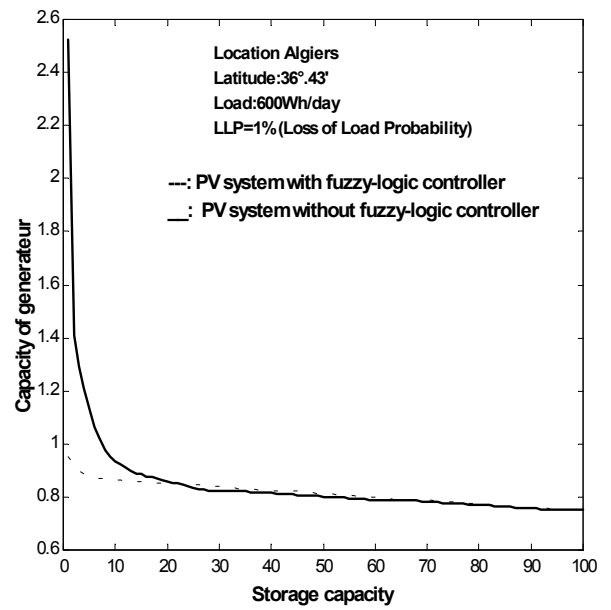

Figure 7. Isoreliability curves