

COMBINED FACTOR ANALYSIS OF THE WISC-III AND CMS:  
DOES THE RESULTING FACTOR STRUCTURE DISCRIMINATE AMONG  
CHILDREN WITH AND WITHOUT CLINICAL DISORDERS?

A Dissertation

by

BECKY MAYES SIEKIERSKI

Submitted to the Office of Graduate Studies of  
Texas A&M University  
in partial fulfillment of the requirements for the degree of  
DOCTOR OF PHILOSOPHY

August 2005

Major Subject: School Psychology

COMBINED FACTOR ANALYSIS OF THE WISC-III AND CMS:  
DOES THE RESULTING FACTOR STRUCTURE DISCRIMINATE AMONG  
CHILDREN WITH AND WITHOUT CLINICAL DISORDERS?

A Dissertation

by

BECKY MAYES SIEKIERSKI

Submitted to the Office of Graduate Studies of  
Texas A&M University  
in partial fulfillment of the requirements for the degree of

DOCTOR OF PHILOSOPHY

Approved by:

Chair of Committee, Cynthia A. Riccio  
Committee Members, William A. Rae  
Michael J. Ash  
Antonio Cepeda-Benito  
Head of Department, Michael R. Benz

August 2005

Major Subject: School Psychology

## ABSTRACT

Combined Factor Analysis of the WISC-III and CMS: Does the Resulting Factor  
Structure Discriminate Among Children With and Without Clinical Disorders?

(August 2005)

Becky Mayes Siekierski, B.S., Texas A&M University;

M.A., University of Houston-Clear Lake

Chair of Advisory Committee: Dr. Cynthia Riccio

The Wechsler Intelligence Scale for Children – Third Edition (WISC-III; Wechsler, 1991) and the Children’s Memory Scale (CMS; Cohen, 1997) are frequently used measures of children’s cognitive ability and memory, respectively. They are often used together to assess a child’s strengths and weaknesses to individualize recommendations for assisting them in the educational setting. However, research suggests that there may be some overlap in the abilities assessed by these instruments, making complete administration of both somewhat redundant. Furthermore, previous studies have been equivocal with regard to the assessment of children with Attention-Deficit/ Hyperactivity Disorder (ADHD) on the WISC-III. Support for the applicability of the four-factor structure of the WISC-III has been questioned, particularly in terms of its utility in the diagnosis of ADHD based on the Freedom from Distractibility Index (FFD). A combined confirmatory factor analysis was conducted on the WISC-III and CMS to determine whether a combination of their subtests could be used in lieu of complete administration of each test.

The combined WISC-III/ CMS standardization sample was obtained from the Psychological Corporation for use in the confirmatory factor analyses. One-, six-, and seven-factor models were initially proposed for the analyses. Results of the combined confirmatory factor analyses indicated that all three models failed to fit the data as well as a new five-factor model that was created during modification of the six-factor model.

Once the five-factor model was specified as the most appropriate model, a clinical sample from a research study was analyzed on the model to find out whether there were age and gender performance differences and also to determine how accurately the new factors differentiated between clinical and nonclinical subsamples. Results indicated that males and females performed significantly differently on the Processing Speed factor but there were no age differences. There were significant differences between the ADHD and no diagnosis groups on three factors: Verbal Comprehension, Working Memory, and Processing Speed; there were no differences on the factors between ADHD subtypes. Together, the five factors were able to correctly classify 66% of children with ADHD. Implications of these results are discussed and suggestions for future research are provided.

## ACKNOWLEDGMENTS

Writing this dissertation was overwhelming at times and could not have been accomplished without the help of numerous individuals. I would like to extend my gratitude to the following people who have contributed their time, assistance, and support over the past several years.

First and foremost, I am especially grateful for the guidance provided by Dr. Cyndi Riccio, my dissertation advisor and mentor who guided my research activities and contributed to my excellent training and continued growth within the field of school psychology. Without her support, I would not have had the experiences that have shaped my graduate training. Thanks also go to Drs. Bill Rae, Michael Ash, and Antonio Cepeda-Benito, my committee members, who have donated their time and contributed valuable suggestions before and during the revision of this dissertation.

To all of the members of the Memory, Attention, and Planning Study (MAPS) team, I owe many thanks for the hours upon hours invested in data collection and preparation of research presentations. This project definitely would not have been as successful without their contributions. Additionally, I am grateful for the financial contributions of the National Academy of Neuropsychology that facilitated the establishment of the MAPS project. I also would like to express my gratitude to The Psychological Corporation for allowing me to use the WISC-III/ CMS standardization data as the basis for my dissertation research.

Special thanks go to the members of my cohort(s) at Texas A&M and also the members of my internship cohort in Oklahoma, whose encouragement has been

valuable. My sincere appreciation is also extended to Roman Garcia de Alba for his friendly support and statistical guidance throughout our graduate program. Furthermore, I would like to express my immense gratitude to Carol Wagner for her dedication to the students in the Department of Educational Psychology. Her selfless devotion to students exceeds expectations and she will always be remembered for her supportive role in my doctoral training.

Last but certainly not least, I am appreciative of my family for believing in me throughout my many years in graduate school. Most importantly, love and gratitude go to my husband, Jim, as he has been unwavering in his love, encouragement, and support of my accomplishments. Words cannot express my appreciation for his selflessness and countless sacrifices in the pursuits of my goals.

## TABLE OF CONTENTS

	Page
ABSTRACT .....	iii
ACKNOWLEDGMENTS.....	v
TABLE OF CONTENTS .....	vii
LIST OF TABLES .....	ix
LIST OF FIGURES.....	x
CHAPTER	
I    INTRODUCTION.....	1
Statement of the Problem .....	1
Combined Factor Analysis .....	2
Use with a Clinical Sample .....	3
Purpose of Study .....	4
Research Questions .....	5
Definitions of Terms .....	5
Implications.....	7
II    LITERATURE REVIEW .....	9
WISC-III Factors.....	9
WISC-III Third Factor .....	15
WISC-III/WAIS-III Similarities .....	21
Children’s Memory Scale.....	22
Combined Factor Analysis .....	26
Use with a Clinical Sample .....	30
III   METHOD .....	32
Participants .....	32
Instruments .....	33
Procedure.....	46
Data Analysis .....	49
IV   RESULTS.....	54

CHAPTER	Page
Confirmatory Factor Analysis .....	54
Model Fit .....	60
Replication with Research Sample .....	61
Research Sample Group Comparisons .....	62
Discriminant Analysis .....	64
V SUMMARY AND CONCLUSIONS.....	71
Summary and Implications.....	71
Limitations and Suggestions for Future Research.....	76
REFERENCES.....	78
VITA .....	91



## LIST OF TABLES

TABLE		Page
1	Subtests comprising the six factors in the Tulskey and Price (2003) model .....	28
2	Demographic data of the WISC-III/CMS standardization sample.....	35
3	Demographic data of research sample from MAPS study .....	36
4	WISC-III index and IQ score composition .....	38
5	CMS domains, indexes, and subtests .....	43
6	Model specification for confirmatory factor analyses.....	50
7	Goodness of fit statistics for confirmatory factor analyses .....	57
8	MAPS sample fit statistics for one- and five-factor models .....	61
9	ANCOVA results for the five factors and their group means .....	63
10	Discriminant analysis classifications of ADHD and No Diagnosis groups using 5-factor model.....	65
11	Discriminant analysis classifications of ADHD and No Diagnosis groups using the FFD .....	66

## LIST OF FIGURES

FIGURE		Page
1	Path specifications for the one-factor model.....	56
2	Path specifications for the five-factor model .....	59
3	ROC curve for Verbal Comprehension.....	68
4	ROC curve for Working Memory .....	68
5	ROC curve for Perceptual Organization .....	69
6	ROC curve for Processing Speed .....	69
7	ROC curve for Auditory Memory .....	70

## CHAPTER I

### INTRODUCTION

The Wechsler Intelligence Scale for Children – Third Edition (WISC-III; Wechsler, 1991) is one of the most widely used measures of intellectual functioning in children. It yields indexes of verbal and performance ability, processing speed, perceptual organization, freedom from distractibility, and verbal comprehension, in addition to an overall estimate of cognitive functioning. The Children’s Memory Scale (CMS; Cohen, 1997) was developed to assess children’s auditory and verbal immediate and delayed memories, working memory, and overall memory ability. Oftentimes, these instruments are used together in a comprehensive evaluation to assess children’s functioning in order to individualize recommendations for enhancing their overall performance.

#### *Statement of the Problem*

It is plausible that some of the underlying constructs of both the WISC-III and CMS may be evident in both tests. The overlap of the two instruments has not been specifically addressed thus far, but a strong relationship between working memory capacity and cognitive ability has been reported (e.g., Süß, Oberauer, Wittmann, Wilhelm, & Schulze, 2002). Comparisons among the CMS and WISC-III in validation studies also revealed a strong correlation between general intelligence and memory functioning (Cohen, 1997). Van den Broek, Sellers, Golden, Burns, and Drabman (2001) compared the WISC-III and Wide Range Assessment of Memory and

---

This dissertation follows the style and format of *Archives of Clinical Neuropsychology*.

Learning (WRAML; Sheslow & Adams, 1990) to investigate whether the combined assessment of intelligence and memory revealed common abilities measured in both. A global factor of memory, attention, and cognition emerged from their analyses, and interestingly, attention appeared to be a common construct across the two instruments in their clinical sample of children. Findings such as these (i.e., Süß et al., 2002; van den Broek et al., 2001) support the assertion that complete administration of both instruments in a comprehensive evaluation may be somewhat redundant. That is, if there are similarities in the WISC-III and CMS, it may be that fewer subtests could be administered without compromising the quality of information obtained. Even if that is not found to be the case, combined results may provide improved reliability and discriminant ability relative to what is currently provided by either measure alone.

#### *Combined Factor Analysis*

Given that both the WISC-III and CMS have been administered to a number of children in the standardization sample, it seems natural that an analysis of the combination of the instruments and constructs across tests should follow. To date, however, there have been no published studies conducted in which the WISC-III and CMS subtests were combined to identify common abilities. If all of the subtests, cognitive and memory, were factor analyzed, one would expect that those purported to measure attention/ concentration/ distractibility (Digit Span, Numbers, Sequencing, Arithmetic) should cluster together to form a more cohesive index score and be more reliable than the current factor. Perhaps the underlying construct being measured in those tasks may become more readily apparent, and accordingly, lend support for or

refute the research (i.e., freedom from distractibility or working memory component). The combined factor structure also would be predicted to yield factors along the current domains of functioning, specifically, verbal comprehension, perceptual organization, processing speed, auditory memory, and visual memory.

Tulsky and Price (2003) have published results of a combined factor analysis of the Wechsler Adult Intelligence Scale – Third Edition (WAIS-III; Wechsler, 1997a) and the Wechsler Memory Scale – Third Edition (WMS-III; Wechsler, 1997b), suggesting a six-factor model of cognitive and memory functioning. They also replicated the new combined model in a clinical sample of adults following the initial analyses. The significance of their research lies in the fact that WAIS-III and WMS-III are the adult counterparts to the WISC-III and CMS, respectively. The six factors that emerged from the combination of the WAIS-III and WMS-III included verbal, perceptual, processing speed, working memory, auditory memory, and visual memory constructs. A combined factor analysis of the WISC-III and CMS would be expected to approximate the model that Tulsky and Price proposed, as the scales and underlying constructs in the tests are regarded as nearly identical. At this point, it is necessary to discern whether or not children's performance on the scales differs from adults', such that a variation of the current adult model is supported.

#### *Use with a Clinical Sample*

The CMS manual (Cohen, 1997) describes results of an analysis of the standardization data suggesting that the Attention/Concentration Index was able to differentiate between two subtypes of ADHD (i.e., Predominantly Inattentive Type and

Combined Type). In addition, Cohen pointed out that the clinical group, as a whole, performed more poorly on the Attention/Concentration Index than matched controls. Replication of these results in the combined WISC-III/ CMS factor structure would have significant implications, providing a solid foundation for the use of the combined index scores for diagnostic decision making with regard to ADHD.

### *Purpose of Study*

The purpose of this study was to perform a combined confirmatory factor analysis on the WISC-III and CMS standardization data to evaluate the resulting factor structure in relation to their individual factor structures. The idea was that ultimately, fewer subtests from the two instruments could be administered without sacrificing any information gained from complete administration of both the WISC-III and CMS in a comprehensive evaluation. Among the benefits hypothesized from this process were shortened administration times and a cross-battery approach to assessment.

Additionally, data from a research sample of children were compared on the WISC-III/ CMS combined factor structure to determine how accurately the new factors differentiated the clinical (ADHD) and nonclinical sub-samples. This was followed by an examination of the factor structure's ability to correctly classify those with and without ADHD. The next goal was to determine whether the ADHD subgroups, Predominantly Inattentive and Combined Type, performed differently on the WISC-III/ CMS combined factor structure. The sensitivity and specificity of the factors relative to ADHD were determined by results of subsequent analyses using the research sample. Children with ADHD were the focus of these analyses due to the continued use of the

third factor of the WISC-III and the Attention/Concentration Index on the CMS by clinicians in diagnostic decision making, despite equivocal research pertaining to their performance.

### *Research Questions*

- 1) Do the data from the CMS and WISC-III combine to yield a different factor structure based on the standardization data?
- 2) For a research sample, if the combined factor structure is different, with what accuracy do these factors differentiate ADHD versus nonclinical subsamples?
- 3) Do group differences emerge between the Predominantly Inattentive and Combined Types of ADHD in a research sample?
- 4) What are the sensitivity and specificity of the factors relative to ADHD?

### *Definitions of Terms*

1. Attention-Deficit/ Hyperactivity Disorder (ADHD) – This disorder is characterized by inattention, hyperactivity, and impulsive behavior. It is pervasive across situations, evident prior to the age of 7, persistent throughout development, and results in clinically significant impairment in functioning. Three diagnostic subtypes delineate the disorder: Predominantly Inattentive (PI), Predominantly Hyperactive- Impulsive, and Combined Type (CT; American Psychiatric Association [APA], 1994, 2000).
2. Cohen's Kappa – The correlation of ratings between two raters (interrater reliability) is calculated using this statistic (Ray, 1997).

3. Confirmatory Factor Analysis – This method of factor analysis allows one to test specific a priori hypotheses about the factor structure for a particular set of variables (Byrne, 2001).
4. Discriminant Analysis – This analysis determines whether groups are different and attempts to identify the combination of variables that can be used as predictors for group membership; the predictors then can be used for classification purposes (Samson, 2000).
5. Factor Analysis – This is a form of data reduction which attempts to identify the latent structure of the relationships between variables (Byrne, 2001).
6. Goodness of Fit Statistics – These are used to establish which predetermined factor structure(s) best fit the data to explain the relationships between the variables (Stapleton, 1997).
7. Multivariate Analysis of Covariance (MANCOVA) – This is an analysis in which one or more variables (covariates) are held constant to isolate and examine the relationships between factors (Garson, n.d.).
8. Receiver Operating Characteristic (ROC) Curve – This statistic measures the ability of a test to correctly classify those with and without a disorder. It specifies the probability of obtaining a true positive versus false positive result based on factor scores (Metz, 1978).
9. Sensitivity – This statistic indicates the proportion of individuals with a disorder who test positive for the disorder (Metz, 1978).



10. Specificity – This is the proportion of individuals without a disorder who test negative for it (Metz, 1978).
11. Working Memory – This is a term used to describe holding information in mind and manipulating that information to formulate a response (Barkley, 1997).

### *Implications*

By combining and factor analyzing the WISC-III and CMS standardization data, constructs can be identified that are measured more reliably when used across the tests. Subtests from the WISC-III may load heavily on factors with subtests on the CMS, providing a greater number of subtests from which to derive meaningful index scores. If it is determined that the WISC-III and CMS successfully combine to form stronger, more reliable index scores, while others fail to contribute a significant amount of additional information, it can be concluded that complete administration of each instrument may be unnecessary. Moreover, significant findings in support of a comprehensive model of children's functioning across cognitive and memory domains would promote the use of a combined approach with the CMS and WISC-III. This, in turn, may lead to the implementation of a cross-battery approach in assessing children's cognitive and memory abilities.

New factor scores may provide better support for conclusions based on those scores, due to the increased number of subtests from which conclusions were drawn. For example, a relative weakness found on an index would likely be based on greater than two subtests, allowing for a larger sample of behavior to contribute to findings. Taken further, it is plausible that the incorporation of subtests across the two instruments may

yield information that affects or changes intervention planning for children.

Administering only those subtests that contribute to the new factor structure would reduce the amount of time invested in assessment and scoring. This would translate into a decreased amount of time committed to testing, thus allowing psychologists to apply greater amounts of time to other forms of service delivery such as consultation, treatment planning, and intervention.

The following chapter explores each of these issues in greater depth and reviews previous research pertaining to use of the WISC-III and the CMS in the assessment of children. Specifically, factor analytic studies on the WISC-III are presented along with the problems inherent in conducting such research. Subsequent chapters delineate the methodology applied in this study, results, and discussion of this research and its implications.

## CHAPTER II

### LITERATURE REVIEW

The previous chapter provided a broad overview of the intent of this research, indicating that a combined confirmatory factor analysis of the Wechsler Intelligence Scale for Children – Third Edition (WISC-III; Wechsler, 1991) and Children’s Memory Scale (CMS; Cohen, 1997) standardization data is central to this study. As previously stated, the resulting combined factor structure was used as a basis for comparisons among a research sample of data from children with and without Attention-Deficit/Hyperactivity Disorder (ADHD). This section incorporates previous research on the WISC-III, CMS, and related subject matter pertaining to the combined factor analysis on which this work is based.

#### *WISC-III Factors*

The WISC-III is generally regarded to be comprised of four factors based on the original factor analysis of the standardization data and replications since that time. The factors have been labeled Verbal Comprehension (VC), Perceptual Organization (PO), Freedom from Distractibility (FFD), and Processing Speed (PS). While it has remained the primary basis for score interpretation, support for the application of a four-factor model as the best fit for the data has varied.

Successful fit of the four factors has been reported in various samples, including a Canadian normative sample (Roid & Worrall, 1997), inpatients of a psychiatric hospital (Tupa, Wright, & Fristad, 1997), children with ADHD (Schwean, Saklofske, Yackulic, & Quinn, 1993), and in children with a range of handicapping conditions

(Konold, Kush, & Canivez, 1997). Roid, Prifitera, and Weiss (1993) collected an independent, nationally stratified sample of data for their WISC-III factor replication studies to examine three-, four-, and five-factor solutions. They found support for continued use and interpretation of the four factor model, including the FFD and PS indexes as the third and fourth factors, respectively. All things considered, the four-factor model for WISC-III interpretation generally has been accepted, with cautious interpretation of the third and fourth factors advised.

*Group performance.* Grice, Krohn, and Logerquist (1999) found support for the four factors in samples of children with learning disabilities, but a three-factor model was equally fitting for that group, suggesting that differentiation among the two models may be difficult. In Hispanic children with learning disabilities, Logerquist-Hansen and Barona (1994) indicated that the three-factor model was most applicable, whereas Kush and Watkins (1994) reported support for the four-factor model in Mexican-American students with learning disabilities, although it was weak. Conclusions from other studies provided strong support for as few as two factors (Allen & Thorndike, 1995b; Sullivan & Montoya, 1997; Watkins, Greenawalt, & Marcell, 2002), and up to five (Burton et al., 2001). Thus, research has demonstrated that interpretation of WISC-III index/ factor scores varies depending on the population considered and does not consistently yield equivalent results.

It should be noted that studies citing factor models other than the standard four-factor model, unless otherwise indicated, consisted of the following: the one-factor model is regarded as essentially the composition of the Full Scale IQ; the two-factor

model is based on the verbal and performance dichotomy; the three-factor model consists of the first three factors of the four-factor model, including verbal comprehension, perceptual organization, and freedom from distractibility. Regarding a five-factor model, Burton et al. (2001) reported the best fit of the standardization data and a clinical sample on the factors verbal comprehension, constructional praxis (Picture Completion, Block Design, and Object Assembly), visual reasoning (Picture Arrangement and Mazes), freedom from distractibility, and processing speed. The main difference evident here is the separation of the traditional perceptual organization factor into two different factors (i.e., constructional praxis and visual reasoning). Although other studies investigated fit of various five-factor models, Burton et al. was the only one to report that it was the best model for the data.

*Examination of the factors in special populations and across ages.* Slate and Jones (1997) compared male and female children with mental retardation on the WISC-III factor structure and found substantial gender differences. The performance of females with mental retardation was consistent with the traditional four-factor WISC-III interpretation; however, the best fit for the males was a three-factor model with an eclectic grouping of subtests comprising them. The first factor included Picture Completion, Picture Arrangement, Block Design, and Object Assembly; the second was comprised of Information, Similarities, Arithmetic, (and Block Design); the third factor included Comprehension, Coding, (and Picture Arrangement). Note that Slate and Jones allowed two subtests to load on two factors while Vocabulary did not contribute enough to warrant interpretation on any factor.

In a longitudinal study by Watkins and Canivez (2001), the WISC-III four-factor solution was supported consistently over time for students with specific learning disabilities, serious emotional disturbances, mental retardation, and other unspecified disabilities. Conversely, when Watkins and Kush (2002) analyzed WISC-III data from students with learning disabilities on twelve models, their results were mixed to the extent that no one model emerged as the best. In fact, they considered the standard four-factor solution “undesirable” (p.15) due to the high number of intercorrelations among factors. In another study, the fit of the four-factor WISC-III model was “marginal” in students with “inappropriate test session behaviors” as well as children with behaviors considered appropriate (Maller, Konold, & Glutting, 1998; p. 468) although no other factor models were examined in the study. Among deaf and hard-of-hearing children, only the first two factors were evident; freedom from distractibility and processing speed both failed to materialize in the study by Sullivan and Montoya (1997); the same was true among gifted children (Watkins et al., 2002).

In their hierarchical factor analysis of the WISC-III standardization data across four age groups, Blaha and Wallbrown (1996) reported that the four factor solution was applicable in all age groups except for the 6-7 year-old group; the FFD factor was not found in this group, although the other factors remained consistent with previous research.

Allen and Thorndike (1995b) conducted a study including both the Wechsler Preschool and Primary Scale of Intelligence – Revised Edition (WPPSI-R; Wechsler, 1989) and the WISC-III in order to determine the stability of the two most agreed upon

factors across the age groups measured by both. The two factors on which they based their analyses were Verbal Comprehension and Perceptual Organization. Allen and Thorndike found that indeed, the two factors were invariant across ages measured by the WPPSI-R and the WISC-III. However, they did qualify their conclusions by adding that there was a tendency for the two-factor model fit to weaken as age progressed. They believed that this was indicative of a developmental shift from a two- to three-factor structure in the WISC-III. In fact, in a subsequent study, Allen and Thorndike (1995a) reported higher levels of fit for a three-factor model across the WISC-III and WAIS-R, supporting their assertion that there was a developmental trend toward a three-factor model as age increased.

Kamphaus, Benson, Hutchinson, and Platt (1994) evaluated the fit of two-, three-, and four-factor models on the WISC-III standardization data. The two-factor model was based on Wechsler's original model, which included all WISC-III subtests but Symbol Search (as it was not developed by Wechsler) to comprise verbal and performance factors. For the three-factor model, they used the same 12 subtests as the two-factor model but this time they were grouped into the verbal, perceptual organization, and freedom from distractibility factors. The four-factor model included all 13 subtests, as intended by Wechsler (1991), grouped into the verbal, perceptual organization, freedom from distractibility, and processing speed factors. The authors reported findings in support of a four-factor model of the WISC-III, as opposed to two- and three-factor models, but the fit for the data was not consistently strong across age groups.

Keith and Witta (1997) examined one-, two-, three-, and four-factor models on the WISC-III standardization data based on previous studies on the WISC-R and WISC-III factor structures. Results indicated that the worst fit to the data was found with the one-factor model and the best fit on the four-factor model as indicated by the WISC-III manual (Wechsler, 1991). Not only did Keith and Witta find support for the four-factor model, but they also determined that it was measured consistently across all 11 age groups in the standardization sample.

In an attempt to replicate Kaufman's (1975) analyses based on the WISC-R, Reynolds and Ford (1994) applied the same analytic procedures to data obtained from children's performance on the WISC-III. They factor analyzed the WISC-III at all 11 age levels within the normative sample using the same subtests that were used by Kaufman in his analyses of the WISC-R. Their goal was to discern whether the same interpretation strategies that were used with the WISC-R could be applied to the WISC-III, as clinicians may be more comfortable using the traditional WISC-R interpretation procedures and may choose not to administer the new, supplemental subtest Symbol Search. Without the inclusion of Symbol Search, Reynolds and Ford speculated, it is possible that interpretation of the fourth factor would be unsupported, and as a result, render the WISC-III four-factor interpretation procedures inappropriate. They found that indeed the WISC-III three-factor structure was stable across all age groups when Symbol Search was removed. In the event that clinicians chose to administer Symbol Search, Reynolds and Ford advised that they consult the WISC-III manual regarding appropriate



interpretation of the four-factor solution, although they cautioned against relying heavily on its interpretation.

A study was performed by Chan (1984) in which he factor analyzed the Hong Kong WISC (HK-WISC), a Cantonese version of the WISC-R, across the 11 age groups within the standardization sample of Chinese children. Two-, three-, and four-factor models were compared and results indicated that the three-factor model was supported across all age levels, consistent with WISC-R standard interpretation procedures. Similarly, Rispens et al. (1997) reported support for the traditional WISC-R three-factor model on the WISC-RN, the Dutch version.

#### *WISC-III Third Factor*

In one of the most historic articles published pertaining to the Wechsler scales, Cohen (1959) strongly encouraged the discontinued use of labels implying an underlying memory component to the third factor, or what he referred to then as Factor C. Instead, he adamantly insisted that it be called Freedom from Distractibility, as its consideration as a memory factor was erroneous. He based his conclusion on the fact that some of the subtests that loaded on the factor (Mazes, Picture Arrangement, and Object Assembly) had no memory requisite and, therefore, must share distractibility as a common feature across them. Incidentally, the other two subtests comprising Cohen's Freedom from Distractibility factor were Arithmetic and Digit Span, the very subtests that continue to contribute to that factor on the WISC-III today.

As the Wechsler scales evolved, the label for the third factor (i.e., Freedom from Distractibility) was retained to maintain historical continuity. It has been criticized for

its misleading name (Lowman, Schwanz, & Kamphaus, 1996), as it has not always been supported as a measure of distractibility. Prifitera, Weiss, and Saklofske (1998) suggested the FFD be renamed Working Memory Index (WMI) in order to be consistent with the label of the third factor on the WAIS-III, while Keith and Witta (1997) suggested renaming the third factor “quantitative reasoning”. Carroll’s (1993) suggested alternative names included “numerical knowledge”, “numerical facility”, and “quantitative reasoning” due to the significant weight of Arithmetic on that index. In the opinion of Watkins and Kush (2002), the FFD factor is “a statistical artifact without substantive meaning” (p.15). Moreover, because of the inability to identify the single underlying construct on the FFD, Ownby and Matthews (1985) advised that it simply be referred to by its number, in other words, the “third factor”.

While the name of the index implies an attention component, alternative explanations for poor performance have been proposed, including academic achievement (Reinecke, Beebe, & Stein, 1999; Siekierski, Jarratt, Rosenthal, & Riccio, 2003), receptive language, verbal working memory, arithmetic skills (Krane & Tannock, 2001), executive and short-term memory processes (Wielkiewicz, 1990), anxiety, number facility, auditory short-term memory (Sattler, 1992), and quantitative reasoning (Keith & Witta, 1997). Results from factor analytic studies by Keith and Witta led them to conclude that the third factor was actually an excellent measure of general intelligence on the WISC-III. Furthermore, Roid et al. (1993) found that the FFD strongly correlated with the Wechsler Individual Achievement Test (WIAT) Mathematics Composite, suggesting a numerical component in addition to working memory.

So, the likelihood that the third factor may reflect a construct different from attention has been explored extensively with many alternative skills proposed. There has been mounting agreement for the idea that faulty working memory skills may be responsible for low scores on the FFD (Barkley, 1997; Krane & Tannock, 2001; Prifitera et al. 1998; Riccio, Cohen, Hall, & Ross, 1997), implying that a child who performs poorly on the FFD has a deficit in the ability to hold information in mind to process it. Further, Krane and Tannock (2001) proposed that the association they found between low FFD scores and a measure of receptive language is more indicative of poor verbal working memory ability.

As previously mentioned, Reynolds and Ford (1994) provided support for and recommended a three-factor solution to the WISC-III in the event that Symbol Search was eliminated from the complete administration of the instrument. Given this situation, they indicated that the third factor should be comprised of Arithmetic, Digit Span, and Coding, reminiscent of the WISC-R third factor composition, as opposed to the WISC-III third factor comprised of only Arithmetic and Digit Span. To continue with interpretation of the third factor in this manner, Reynolds and Ford suggested that the clinician incorporate test observation behaviors, as the third factor can be a sensitive indicator of brain injury and attention deficits. In essence, the authors encouraged continued utilization and interpretation of the freedom from distractibility factor on the WISC-III but specified how to do so most effectively.

Others have refuted the claims made based on the standardization data presented in the WISC-III manual. In a review of the standardization data and analyses, Little

(1992) did not find support for the FFD factor and even suggested that it be ignored in the interpretation of test results. Carroll (1993) pointed out several problems with the reported information and performed analyses on the data using estimated communalities and specific factor loadings, as they were not provided in the manual. This reanalysis of the standardization data also led to a lack of support for the FFD factor. Further, Carroll called attention to the great deal of weight contributed by the Arithmetic subtest on the factor, which significantly affects the interpretation of performance on that scale. In a sample of students with learning disabilities, Kush (1996) found no evidence of the FFD, as Arithmetic loaded on the verbal comprehension factor and Digit Span failed to load on any of the other three.

*Use with ADHD.* Despite the paucity of data supporting its use, and ample research discrediting its foundation, clinicians frequently rely on the FFD as a diagnostic indicator of ADHD. There have been conflicting conclusions in the literature regarding whether or not the FFD should be interpreted, particularly as a measure of sustained attention. Children with ADHD have performed more poorly on the WISC-III FFD than their non-ADHD peers (Golden, 1996), but others investigating their performance on the FFD failed to find a significant relationship (e.g., Anastopoulos, Spisto, & Maher, 1994; Krane & Tannock, 2001; Reinecke et al., 1999; Siekierski et al., 2003).

Further, Anastopoulos et al. (1994) had concluded that 48% to 77% of children with ADHD would remain undiagnosed if the third factor was used as a screening criterion. Wielkiewicz and Palmer (1996) countered Anastopoulos et al.'s conclusions by stating that even if the accuracy of the FFD in diagnosing ADHD was only 23% to

52%, when it is used in conjunction with a thorough evaluation, it can still provide a valuable indicator of the presence or absence of ADHD. Barkley (1996) then challenged Wielkiewicz and Palmer's counterarguments pertaining to Anastopoulos et al.'s study by reaffirming that no assessment scores or battery of scores have been shown to be reliable indicators of ADHD in children. He also reiterated that extreme caution should be used in the interpretation of scores on the third factor. These differing interpretations offered by multiple authors based on the same study pertaining to children's performance on the FFD contribute to continued uncertainty in the clinical use of the FFD for ADHD diagnosis. Consequently, the utility of FFD interpretation as a measure of attention has been challenged repeatedly, with little resolution.

*WISC-R third factor.* The WISC-R third factor, also labeled FFD, is the counterpart of the FFD on the WISC-III and it is also comprised of the scaled scores on Arithmetic and Digit Span. However, on the WISC-R, one additional subtest contributes to its calculation, namely Coding. Studies investigating the FFD on the WISC-R have traditionally reported conflicting findings similar to those on the WISC-III with regard to its validity and use in diagnostic considerations for ADHD.

While Kostura (1993) did not find significant differences between the FFD scores of children with ADHD and academically underachieving students, Lufi and Cohen (1985) and Lufi, Cohen, and Parish-Plass (1990) reported that children with ADHD performed more poorly than their non-ADHD peers. Furthermore, Lufi and Cohen (1985) felt that their results provided support for the utility of the WISC-R in identifying children with ADD.

Stewart and Moely (1983) reported findings of their study of the third factor in which they compared each of the three subtests (Arithmetic, Digit Span, and Coding) to other measures of cognitive and behavioral functioning. They concluded that the freedom from distractibility label was an “oversimplification” of the underlying constructs being measured, as each of the subtests was found to represent a distinct cognitive ability. According to Stewart and Moely, Arithmetic performance seemed to be affected by rehearsal skills, numerical facility, verbal comprehension of the problems, and math skills, while Coding measured use of rehearsal strategies and numerical facility; they found that Digit Span was essentially a memory task. These suggested cognitive constructs oppose the behavioral construct of distractibility that is implied by the index label.

Ownby and Matthews (1985) also reported findings in support of complex underlying executive processes such as visuospatial organization, rapidly shifting mental operations, and sustained attention during cognitive processing. Conversely, Zelman (1982) found that the third factor on the WISC-R corresponded to behavioral types of characteristics, rather than intellectual. Based on his comparisons of the FFD and the Devereaux Child Behavior Scale, he concluded that higher scores on the FFD were indicative of “behavior considered mature, independent, and sociable in a youngster considered coordinated and conscientious about cleanliness” (p. 58), which seems to contrast previous speculations.

Greenblatt, Mattis, and Trad (1991) concluded that 11% of the child psychiatric population in their study had significantly poor performance on the third factor (as

determined by their own criteria). These children also were more likely to demonstrate learning disabilities and a higher VIQ than FSIQ when compared to the remainder of the child psychiatric population. A particularly interesting finding surfaced when Greenblatt, Mattis, and Trad factor analyzed the WISC-R with this population, as Block Design was included on the FFD factor.

#### *WISC-III/ WAIS-III Similarities*

The WISC-III is essentially analogous to the WAIS-III (Wechsler, 1997a), an instrument that is used in an equivalent manner to assess cognitive functioning in adults. Because of their similar construction and sound psychometric properties, comparisons of the WISC-III and WAIS-III are relatively common and can contribute to the collective body of research regarding the measurement of cognitive functioning. Notably, while the WISC-III refers to the third factor as the FFD, the corresponding factor on the WAIS-III is labeled Working Memory (WM). Only one difference in composition exists between the two factors, FFD and WM; the Letter-Number Sequencing subtest is included in calculation of the WM index score, whereas both the FFD and WM share the Arithmetic and Digit Span subtests in common. For that reason, it appears that the inclusion of the Letter-Number Sequencing subtest has altered what researchers believe to be the factor's underlying construct. Nevertheless, studies have continued to cast doubt on the validity of the WM just as has been the case with the FFD (Donders, Tulsky, & Zhu, 2001). In any event, the label assigned to the third factor on the WAIS-III seems more congruent with what research has suggested about the abilities assessed on the FFD.

Given the widespread use of the WISC-III in the assessment of children's sustained attention, definitive support for the continued use of the FFD should be established. It is clear that Arithmetic and Digit Span consistently cluster together, implying that there is a common underlying construct being measured. Unfortunately, it has been difficult to determine the exact nature of that construct, though researchers recognize its link to working memory/ short-term memory abilities. Regardless of the construct it is purported to measure, the use of the FFD is not supported as a reliable index, as it is comprised of only two subtests (Arithmetic and Digit Span) on the WISC-III. That leaves one to question whether the index would more reliably measure a single, identifiable construct if additional, similar subtests were included in its calculation.

#### *Children's Memory Scale*

While the WISC-III is an instrument used to evaluate prior learning and information processing, the Children's Memory Scale (CMS) is considered a measure of new learning and memory that is commonly used in neuropsychological evaluations and educational assessments with children. Reviewers have regarded the CMS as a psychometrically sound and well-developed instrument (Napolitano, 2001; Stein, 2001; Vaupel, 2001) that is a valuable tool for discerning the extent to which a child's memory abilities may contribute to the presenting concerns. Psychologists often include it in a comprehensive evaluation along with the WISC-III due to the ease of score comparisons across instruments as a result of their linking standardization data (Hildebrand & Ledbetter, 2001). The information obtained from the CMS/WISC-III battery can assist in narrowing hypotheses, as well as identifying strengths and weaknesses to be



addressed in a child's individualized education plan. In this way, recommendations and interventions can be tailored specifically to the manner in which a referred child can learn most successfully.

When a factor analysis is performed on the CMS standardization sample, a three-factor model emerges as the best representation of the constructs measured (Cohen, 1997). The three factors supported in the model are auditory/verbal, visual/nonverbal, and attention/concentration. Three subtests on the CMS group together to form the Attention/Concentration Index (Numbers, Sequences, and the optional Picture Locations), although it can be computed based on only the two required subtests (Numbers and Sequences).

The Numbers subtest on the CMS resembles the Digit Span subtest on the WISC-III. Each of them requires that the child repeat numerical sequences at increasing lengths in the same order as presented; subsequently, the child repeats numerical digits again, but this time in reversed order of that presented by the examiner. As stated in the CMS manual (Cohen, 1997), the Attention/Concentration Index is highly correlated with the WISC-III FFD ( $r = .73, p \leq .01$ ). This makes intuitive sense, as each scale shares one subtest in common (i.e., Digit Span/ Numbers). Because the Attention/Concentration Index can be derived from three subtests, as opposed to two, it is assumed to be a more reliable measure of the construct than the FFD.

*Clinical performance.* In a study of the performance of children with specific language impairment (SLI) on the CMS, Cohen, Ledbetter, and Benavides (1999) reported that the children with SLI obtained significantly lower scores on the

Attention/Concentration, Verbal Immediate, and Verbal Delayed indexes while no significant differences were noted in the visual areas. Overall, the children with SLI showed modality-specific weaknesses at all verbal tasks in comparison to visual tasks. The authors concluded that processing and encoding verbal information was poor in children with SLI although their long-term memory of learned material, as measured by the CMS, seemed intact. Cohen et al. added that these results provided support for the clinical utility of the CMS with children with SLI.

Winland (2000) evaluated the ability of the CMS to discriminate among children between the ages of 9 and 16 with and without learning disabilities (LD). She found that four of the indexes on the CMS successfully discriminated the LD and non-LD groups. The order of magnitude of the contribution of the indexes to the significant effects was Delayed Recall, Attention/Concentration, Visual Delayed, and to a lesser extent, the Learning index. The author concluded that indeed, the CMS was clinically useful within a comprehensive neuropsychological battery for detecting significant differences among populations of children with and without learning disabilities.

*Attention/Concentration Index.* The CMS manual (Cohen, 1997) describes results of an analysis of the standardization data suggesting that the Attention/Concentration Index was able to differentiate between two subtypes of ADHD (i.e., Predominantly Inattentive Type and Combined Type). There were 87 children with ADHD who participated in the study and a matched control group was included for comparisons. Within the clinical group, 46 children were diagnosed with Predominantly Inattentive Type and 41 diagnosed with Combined Type; all of the participants with

ADHD were on stimulant medication during the study. In addition to finding that the Attention/Concentration Index successfully discriminated the subtypes, Cohen (1997) reported that the clinical group, as a whole, performed more poorly on the Attention/Concentration Index than matched controls.

In another investigation of the performance of children with ADHD on the Attention/Concentration Index of the CMS, Avis (2000) reported that children with ADHD, regardless of subtype, performed more poorly than controls. However, these children did not significantly differ from each other or differ from controls on any of the other components of the CMS. Further, a linear trend was evident on the Attention/Concentration Index in which the controls performed better than the children with ADHD Inattentive Type, who in turn performed better than the children with ADHD Hyperactive-Impulsive and Combined Types. The author points out that her results were consistent with those reported by Cohen (1997) and indicated that the children with ADHD performed more poorly on the Attention/Concentration Index.

However, Rosenthal, Siekierski, and Riccio's (2003) results of similar analyses contradicted those reported by Cohen (1997) and Avis (2000). In their study, Rosenthal et al. found that the Attention/Concentration Index did not successfully separate the groups of children with ADHD from those with another clinical diagnosis or no diagnosis. Incidentally, the Attention/Concentration Index also did not significantly correlate with scores on continuous performance tasks or parent-report measures of attention. The authors concluded that the Attention/Concentration Index was a poor indicator of attention problems in children.

### *Combined Factor Analysis*

As noted in the previous chapter, the relationship between cognitive ability and memory has been demonstrated a number of times (e.g., Cohen, 1997; Süß et al. 2002; Van den Broek et al. 2001). Although both the WISC-III and CMS were administered to a number of children in the standardization sample, there have yet to be any published results of a combined analysis of the two instruments to further investigate the relationship between the two constructs. However, several studies have reported results from combined factor analyses of the WAIS and WMS. The outcomes of their analyses can provide insight into what can be expected from similar analyses of the WISC-III and CMS.

*WAIS and WMS.* When Bowden, Carstairs, and Shores (1999) performed a combined confirmatory factor analysis of the WAIS-R and WMS-R on a large sample of healthy young adults, they found that a five-factor model provided the best fit for the data. The resulting five factors were named Verbal Comprehension, Perceptual Organization, Attention/Concentration, Verbal Memory, and Visual Memory. Notably, the authors reported that a seven-factor model delineating the three factors contributed by the WAIS-R (i.e., Verbal Comprehension, Perceptual Organization, and Attention/Concentration) in addition to Visual and Verbal Immediate, and Visual and Verbal Delayed Recall factors was also found to be a viable model. However, they concluded that interpretation of the seven-factor model over the five-factor model would not provide incremental validity or a better representation of one's abilities beyond that provided by the verbal and visual memory factors alone. Bowden, Carstairs, and Shores

also pointed out that there was a clear overlap in the attention-concentration/ working memory construct across the instruments

Conversely, a six-factor solution resulted from a combined factor analysis of the WAIS and WMS-R by Nicks, Leonberger, Munz, and Goldfader (1992). The six factors were labeled by the authors as Perceptual Organization, Verbal Comprehension, Attention/Concentration, Complex Verbal Memory, Verbal Paired Associate Memory, and Visual Paired Associate Memory. Preceding the more recent studies, Larrabee, Kane, and Schuck (1983) factor analyzed the original versions of the WAIS and WMS to ascertain the overlap among cognitive and memory constructs measured by the two instruments. Their results essentially supported a five-factor model including Perceptual Organization, Verbal Comprehension, Attention/ Concentration, Verbal Learning and Recall, and Information/Orientation. Although a sixth factor was extracted, it was considered uninterpretable due to the magnitudes of the loadings by the subtests.

*WAIS-III and WMS-III.* More recently, Tulsy and Price (2003) reported the results of a combined factor analysis of the WAIS-III and WMS-III, delineating a six-factor model of cognitive functioning and subsequently replicating the model in a clinical sample of adults. This is important considering, as previously noted, the WAIS-III and WMS-III are the adult counterparts to the WISC-III and CMS. The six factors that emerged from the WAIS-III and WMS-III included verbal comprehension, perceptual organization, processing speed, working memory, auditory memory, and visual memory. Table 1 presents the six factors along with the subtests included in their composition. With regard to rationale for their work, the authors believed that the

constructs measured across the instruments more closely resembled real-world applications, as opposed to separating out cognitive ability and memory. Besides, because the WAIS-III and WMS-III were co-normed, the data were readily available and could easily be examined (Tulsky et al. 2003).

Table 1

Subtests comprising the six factors in the Tulsky and Price (2003) model

Factor	Subtest
Verbal Comprehension	Information
	Vocabulary
	Similarities
Working Memory	Spatial Span
	Letter-Number Sequencing
Perceptual Organization	Block Design
	Picture Completion
	Matrix Reasoning
Processing Speed	Digit Symbol
	Symbol Search
Auditory Memory	Logical Memory I and II
	Verbal Paired Associates I and II
Visual Memory	Family Pictures I and II
	Visual Reproduction I and II

Due to the overlap of subtests and the large total number of subtests, Tulskey and Price (2003) opted to eliminate several of them from their final analyses. Both the WAIS-III and WMS-III contain a working memory index, although their composition differs. Tulskey and Price elected to use the two subtests from the WMS-III (i.e., Spatial Span and Letter-Number Sequencing) in place of the three subtests on the WAIS-III based on efficiency and the balance of verbal and nonverbal response modalities. They believed that there was no reason to question whether the WAIS-III working memory index would be significantly different and, thus, need to be included. Additionally, composite visual and auditory memory factors were used (which were comprised of both the immediate and delayed components of their respective subtests) in place of individual visual and auditory immediate and delayed memory factors. The reason for the composites was that preliminary factor analyses failed to separate the immediate and delayed memory factors. The complexities of choosing which visual memory subtests to retain, coupled with the authors' reluctance to completely eliminate immediate and delayed memory distinctions led to the inclusion of secondary subfactors; these are optional auditory and visual immediate and delayed indexes that can be computed although they are not considered in the 6-factor model.

Based on a 6-factor model of the WAIS-III and WMS-III, Taylor and Heaton (2001) investigated the sensitivity and specificity of the demographically corrected (i.e., age, education, sex, and ethnicity) factor scores. The verbal comprehension factor was found to be the least sensitive to neuropsychiatric disorders in the sample while the processing speed and visual memory factors were more neurodiagnostically sensitive.

Overall, Taylor and Heaton's analyses revealed that a 1 standard deviation cutoff score for each of the factors provided the best balance of sensitivity and specificity, as opposed to the more stringent 1.5 or 2 standard deviation cutoffs for assisting diagnostic decision making. The authors noted that sensitivity and specificity could be affected by varying the size of the test battery selected. That is, a battery may consist of only administering the two most sensitive factors (processing speed and visual memory) as compared to three- and four-factor batteries, in which the factor with the next highest sensitivity was added, and so on. In the total sample, the three-factor (processing speed, visual memory, and auditory memory) and four-factor (processing speed, visual memory, auditory memory, and working memory) batteries provided the highest levels of sensitivity.

#### *Use with a Clinical Sample*

Replication of Cohen's (1997) aforementioned results of performance of children with ADHD on the Attention/ Concentration Index in the combined WISC-III/ CMS factor structure would have significant implications. After all, the children with ADHD would be predicted to perform more poorly than non-ADHD peers on the new factor, perhaps redefined as a measure of working memory rather than freedom from distractibility/ attention/concentration.

Results suggesting children with ADHD performed more poorly on the new working memory factor would be congruent with previous research identifying working memory an area of weakness in those children (e.g., Stevens, Quittner, Zuckerman, & Moore, 2002; West, Houghton, Douglas, & Whiting, 2002), which ultimately may result



in the more appropriate application of combined index scores for diagnostic decision making and generating intervention plans.

This concludes the comprehensive review of the literature pertaining to this study. Within this chapter, previous studies on the WISC-III and CMS were presented along with research in support of and refuting their use. Specifically, the ranges of factors resulting from factor analytic studies with the WISC-III and WISC-R in various ethnic groups, special populations, and across ages were presented in addition to the conflicting study results regarding the use of the third factor in ADHD assessment. Comparisons among the WAIS-III and WMS-III also were provided, as they directly relate to the WISC-III and CMS. Additionally, research investigating the performance of children on the CMS was reviewed. The specific methodology that was selected for this study is discussed in Chapter III, followed by the results and conclusions in Chapters IV and V, respectively.

## CHAPTER III

### METHOD

As discussed in Chapters I and II, the purpose of this study was to investigate the combined factor structure of the Wechsler Intelligence Scale for Children – Third Edition (WISC-III; Wechsler, 1991) and Children’s Memory Scale (CMS; Cohen, 1997) in order to determine the factor model that most closely fits the standardization data. In the second component of the study, data from a research sample of children were applied to the combined factor structure to examine model fit in the clinical population. In this chapter the methodology used to address the research questions is presented. Results and discussion will then be presented in Chapters IV and V, respectively.

#### *Participants*

*Standardization sample.* A sample of 396 children originally acquired for the development of the CMS norms was obtained from The Psychological Corporation. Selected participants were administered the WISC-III and CMS as part of the original normative data collection. Of those children, approximately 50% were female ( $n = 192$ ) and 50% were male ( $n = 204$ ); they ranged in age from 6-16 years. Parent education, race/ethnicity, and geographic region were used as stratification variables. This linking sample closely resembled 1995 Census data pertaining to the population of school-age children in the U.S. However, as the CMS manual reports, the sample was weighted by 3.5% on parent education level and race/ethnicity to more accurately depict the Census data. All subsequent analyses of the standardization data were performed using weighted

means. Demographic information pertaining to the standardization sample is presented in Table 2.

*Research sample.* Data for the comparison clinical/ nonclinical groups were obtained from a research study in which children ages 9-15 years completed a comprehensive neuropsychological evaluation; there were 63 male and 30 female participants. Of those participants, 41 had a diagnosis of ADHD, 26 had a diagnosis other than ADHD, and 26 had no diagnosis. Among the children with ADHD there were 27 with Combined Type and 14 considered Predominantly Inattentive. The children were consecutive referrals to the Memory, Attention, and Planning Study (MAPS), a research project at Texas A&M University. To be included in the study, participants obtained an IQ  $\geq$  80 and had the ability to speak and read English. The sample was comprised primarily of residents of the Bryan/College Station area who learned of the study via school counselors, community postings, and newspaper advertisements. Specific demographic information for this sample is presented in Table 3.

#### *Instruments*

*Wechsler Intelligence Scale for Children – Third Edition (WISC-III).* The WISC-III (Wechsler, 1991) is an individually administered test of cognitive ability for children ages 6-16. Four index scores and an overall estimate of intellectual functioning (Full Scale IQ) are derived from the ten core and three optional subtests: Picture Completion, Information, Coding, Similarities, Picture Arrangement, Arithmetic, Block Design, Vocabulary, Object Assembly, Comprehension, Symbol Search, Digit Span, and Mazes. The four indexes are labeled Verbal Comprehension (VC), Perceptual

Organization (PO), Freedom from Distractibility (FFD), and Processing Speed (PS). In addition to the index and full scale scores, the subtests can be grouped to form verbal and nonverbal ability scores termed the Verbal IQ (VIQ) and Performance IQ (PIQ), respectively. Table 4 illustrates the subtests that comprise the index and IQ scores. Each of the subtests on the WISC-III has a mean of 10 and a standard deviation of 3; the four indexes, VIQ, PIQ, and FSIQ all have a mean of 100 and standard deviation of 15.

*Reliability.* Included in the psychometric properties reported in the WISC-III examiner's manual are reliability and validity estimates, with reliability representing the stability and consistency of scores over time. Measures of consistency provided in the manual include subtest, index, and IQ score reliabilities, as well as interrater and test-retest calculations. Reliability coefficients were calculated for each age subgroup (11 total) and also the average reliability across age groups for each subtest, factor-based index, and IQ scale.

Table 2

Demographic data of WISC-III/ CMS standardization sample

		Sex		
		Males	Females	Total
Ethnicity	Caucasian	149	150	299
	African American	25	19	44
	Hispanic	23	16	39
	Other	7	7	14
	Total	204	192	396
Handedness	Right	186	179	365
	Left	17	13	30
	Ambidextrous	1	0	1
	Total	204	192	396
Parent Education Level	Less than 8 years	17	11	28
	9-11 years	11	16	27
	12 years	67	59	126
	13-15 years	60	56	116
	16+ years	49	50	99
	Total	204	192	396

Table 3

Demographic data of research sample from MAPS Study

		Sex		
		Males	Females	Total
Ethnicity	Caucasian	51	23	74
	African American	6	5	11
	Hispanic	6	1	7
	Other	0	1	1
	Total	63	30	93
Handedness	Right	54	28	82
	Left	9	2	11
	Ambidextrous	0	0	0
	Total	63	30	93
Parent Education Level	Less than 8 years	0	0	0
	9-11 years	1	1	2
	12 years	16	6	22
	13-15 years	10	8	18
	16+ years	35	15	50
	Total	62 <sup>a</sup>	30	92 <sup>a</sup>

<sup>a</sup>Parent education level not reported for one male case.

Internal consistency of each subtest was calculated using a split-half method, with the exception of Symbol Search and Coding. Because these two subtests are speeded and split-half measures of reliability would be inappropriate, stability coefficients were used from a test-retest study instead. For the IQ and index scales, a formula for composite scores was used to compute reliability. Among the reliability coefficients averaged across age groups, subtest reliabilities ranged from .69 to .87, factor-based index scores ranged from .85 to .94, and the three IQ scales ranged from .91 to .96 (Wechsler, 1991). The strength of the reliability coefficients demonstrates that the IQ scales are more consistent than indexes, and much more stable than subtest scores.

Other reliability measures presented in the manual include confidence intervals and standard errors of measurement for all subtests, indexes, and IQ scales. Test-retest stability was computed using a diverse sample of 353 children from six age groups. Results indicated that the WISC-III demonstrates satisfactory stability across time and age groups, with reduced practice effects noted in longer test-retest time intervals. Several subtests on the WISC-III require more judgment in scoring (i.e., Similarities, Vocabulary, and Comprehension), which is likely to introduce more variability in subtest scores. Nevertheless, interscorer reliability coefficients presented in the manual suggest that they can be scored consistently. The reliability coefficients reported were .98 for Similarities, .98 for Vocabulary, .97 for Comprehension, and .92 for Mazes (Wechsler, 1991).

Table 4

WISC-III index and IQ score composition

Full Scale IQ												
IQ	Verbal IQ						Performance IQ					
Index	VCI			FFD			POI			PSI		
Subtests	I	S	V	C	A	D <sup>a</sup>	PC	PA	BD	OA	Cd	SS <sup>a</sup>

*Note.* VCI = Verbal Comprehension Index; FFD = Freedom from Distractibility Index; POI = Perceptual Organization Index; PSI = Processing Speed Index; I = Information; S = Similarities; V = Vocabulary; C = Comprehension; A = Arithmetic; D = Digit Span; PC = Picture Completion; PA = Picture Arrangement; BD = Block Design; OA = Object Assembly; Cd = Coding; SS = Symbol Search. Mazes is not listed as it is an optional subtest that does not contribute to the calculation of IQ or index scores.

<sup>a</sup>Digit Span and Symbol Search are not used in calculation of IQs.

*Validity studies.* With regard to validity, there have been a number of studies on the WISC-III, many of which were presented in the preceding chapter. As previously noted, the factor structure of the WISC-III is often challenged in studies, with particular emphasis on its disparities in special populations, among different ethnic groups, and even in clinical populations. The WISC-III manual presents additional information pertaining to its internal validity, which should contribute support for its structure. In an



analysis of the relationships among the WISC-III subtests and scales, the manual reports that subtests from the Verbal scale correlate more highly with each other than with Performance subtests. Conversely, Performance subtests are more highly correlated with other Performance subtests than with Verbal subtests, demonstrating convergent validity. Likewise, discriminative validity is evident by the low correlations of Verbal subtests with Performance subtests (Wechsler, 1991).

According to the manual, a number of exploratory and confirmatory factor analyses performed on the standardization data found the strongest support for a four-factor solution, after also having examined one-, two-, three-, and five-factor models. Additional confirmatory methods were subsequently used with clinical, high ability, and low ability groups of children. Comprising the clinical group were children with learning disabilities, reading disorders, and attention-deficit disorders. Gifted students were referred to as high ability while children with FSIQs  $\leq 75$  formed the low ability group. In all three groups, the four-factor model consistently provided the best fit.

In order to measure the validity of the WISC-III for use in cognitive assessment, it was compared to the WISC-R, WAIS-R, and the Wechsler Preschool and Primary Scale of Intelligence – Revised (WPPSI-R). High correlations were found across subtests, indexes, and IQ scores in the comparison of the WISC-III and the WISC-R. Slight differences in WAIS-R and WISC-III scores were evident in lower performing 16 year-olds due to the floor effect on the WAIS-R. Thus, in the population of low functioning 16 year-olds, the WISC-III is recommended due to its ability to provide finer discriminations of their abilities and result in more accurate estimates of their skills.

Similarly, due to the overlap in ages assessed on the WISC-III and WPPSI-R, it is preferable to use the WISC-III in evaluations of above-average 6 and 7 year-olds to counter the ceiling effect of the WPPSI-R in these populations.

Additional convergent validity comparisons were made between the WISC-III and the Otis-Lennon School Ability Test – Sixth Edition (OLSAT; Otis & Lennon, 1989) and Differential Ability Scales (DAS; Elliott, 1990). Correlations between OLSAT indexes and WISC-III index and IQ scores ranged from moderately high for the Processing Speed Index (PSI) and OLSAT Total School Ability Index (TSAI;  $r = .48$ ) to very high for the WISC-III FSIQ and OLSAT TSAI ( $r = .73$ ). On the DAS, a very high correlation was found for the WISC-III FSIQ and the DAS General Conceptual Ability (GCA;  $r = .92$ ) with index comparisons also considered very high ( $r = .67$  to  $.87$ ). In a mixed sample of children with ADHD and learning disabilities, the WISC-III FSIQ and DAS GCA continued to correlate highly ( $r = .78$ ), consistently demonstrating that the WISC-III measures cognitive ability in children as well as other instruments considered to measure the same construct.

Children's academic achievement test scores and school grades have been compared to WISC-III scores as well. Overall, as the WISC-III manual reports, very high correlations were found between the WISC-III FSIQ and Total Achievement ( $r = .74$ ) computed across instruments, with notable correlations between the WISC-III VIQ and Reading Achievement scores ( $r = .70$ ); the PIQ was moderately correlated with achievement scores. Moreover, the WISC-III FSIQ moderately correlated with estimated school grade point averages ( $r = .47$ ).

*Children's Memory Scale (CMS)*. The CMS is an instrument designed to assess learning and memory functioning in children ages 5-16. It is comprised of six core subtests (Dot Locations, Stories, Faces, Word Pairs, Numbers, and Sequences) and three optional subtests (Family Pictures, Word Lists, and Picture Locations) which yield seven indexes, three domains, and an overall General Memory score. Of the nine subtests, six have delay components that are administered approximately 30 minutes following the first portion. The three subtests belonging to the Attention/Concentration Index are administered only once, as they do not have delay components.

The three general domains assessed in the CMS are considered Auditory/Verbal learning and memory, Visual/Nonverbal learning and memory, and Attention/Concentration. They are presented along with their associated indexes and subtests in Table 5. Like the WISC-III, the subtests on the CMS have a mean of 10 and a standard deviation of 3, while the indexes and General Memory have a mean of 100 and a standard deviation of 15.

*Reliability*. Individual reliability coefficients were provided in the CMS manual for each of the seven indexes and General Memory. They were as follows: Visual Immediate .76; Visual Delayed .76; Verbal Immediate .86; Verbal Delayed .84; Attention/Concentration .87; Learning .85; Delayed Recognition .80; and General Memory .91. Retest stability was measured in a diverse sample of 125 children, divided into three age groups: 5-8 years, 9-12 years, and 13-16 years old. The children were assessed an average of 60 days following the initial test administration. Results indicated that the indexes demonstrated adequate stability across age and time intervals, with the

exception of the Visual Immediate and Delayed Indexes. There was a practice effect reported on the CMS of up to one standard deviation improvement, likely due to the brief interval between retesting. Regardless, the manual reports that overall, the CMS demonstrates good, consistent scores over time with more reliable index scores than subtest scores. Interrater reliability was measured using intraclass correlation, which calls for two examiners to independently score the same test protocol; results concluded that interrater reliability is very high, ranging from 0.88 to 1.00.

*Validity studies.* As a measure of children's auditory and visual memory abilities and attention/concentration, the CMS should demonstrate relatively strong relationships to other memory measures. In comparisons to instruments that assess other abilities, such as cognitive functioning, achievement, language, and executive function, one would expect that low to moderate relationships (at most) should be evident. The CMS manual reports results of such comparisons to contribute to validation studies.

Table 5

CMS domains, indexes, and subtests

General Memory							
Domain	Visual Memory		Verbal Memory			Attention/Concentration	
Index	Immediate	Delayed	Immediate	Delayed	Delayed Recognition	Attention/Concentration	Learning
Subtests	Dot	Dot			Stories		Dot
	Locations	Locations	Stories	Stories	Delayed	Numbers	Locations
	Total	Long	Immediate	Delayed	Recognition		Learning
	Score	Delay					
	Faces	Faces	Word Pairs	Word Pairs	Word Pairs		Word
	Immediate	Delayed	Pairs	Pairs	Delayed	Sequences	Pairs
			Total	Long	Recognition		Learning
			Score	Delay			

Cohen (1997) reported in the manual that the CMS General Memory scale was highly correlated with the WISC-III Full Scale IQ ( $r = .58; p \leq .01$ ); however, he warned that it cannot be used for predictive purposes, as it has not been supported in that capacity. In addition to the WISC-III, the CMS was compared to other measures of cognitive functioning including the WPPSI-R (Wechsler, 1989), Differential Ability Scales (DAS; Elliot, 1990), and the Otis-Lennon School Ability Test – Sixth Edition (OLSAT; Otis & Lennon, 1989). The CMS consistently demonstrated similar findings across tests, in that the General Memory scale was moderately correlated with indicators of overall cognitive ability on the WPPSI-R, DAS, and OLSAT.

Measures of academic achievement that were used in CMS validity analyses were the Wechsler Individual Achievement Test (WIAT; The Psychological Corporation, 1992b), Stanford Achievement Test – 8<sup>th</sup> Edition (SAT-8; The Psychological Corporation, 1992a), the Metropolitan Achievement Test – 7<sup>th</sup> Edition (MAT-7; Prescott, Balow, Hogan, & Farr, 1992), Iowa Tests of Basic Skills (ITBS; Hieronymus, Hoover, & Linn, 1989), Comprehensive Tests of Basic Skills – 4<sup>th</sup> Edition (CTBS-4; CTB MacMillan/ McGraw-Hill, 1989), and the California Achievement Test – 5<sup>th</sup> Edition (CAT-5; CTB MacMillan/ McGraw-Hill, 1988). Correlations among the tests were discrepant enough to suggest that memory and achievement, as measured by these instruments, are related but not unitary constructs. The strongest relationships were observed between measures of general academic achievement and the Attention/Concentration, General Memory, and auditory/ verbal memory Indexes. These results were consistent with what would be expected.

Three memory scales were compared to the CMS in order to establish convergent validity. In the same way the WISC-III and WAIS-III share similar subtest and factor composition, the CMS and Wechsler Memory Scale – Third Edition (WMS-III; Wechsler, 1997b) are also comparable. In the WMS-III, different labels have been assigned to a few of the subtests, but the majority of them are fundamentally equivalent to those discussed previously in the context of the CMS (e.g. Faces, Logical Memory/Stories, Verbal Paired Associates/ Word Pairs, and so on). When the CMS and WMS-III were compared, corresponding indexes were found to have moderate to strong relationships, suggesting that the two instruments measure the construct of memory consistently throughout the lifespan.

Conversely, correlations among the indexes on the Wide Range Assessment of Memory and Learning (Sheslow & Adams, 1990; WRAML) and CMS were variable, with a range of weak to strong relationships. One particular correlation that stands out is that of the Attention/Concentration Index and the WRAML Verbal Memory Index ( $r = .70, p \leq .001$ ). Overall, the Attention/Concentration Index tended to highly correlate with many WRAML indexes, supporting the notion that an attention component pervades a number of WRAML areas. One final comparison was reported between the CMS and the California Verbal Learning Test – Children’s Version (CVLT-C; Delis, Kramer, Kaplan, & Ober, 1994). Word Lists on the two instruments demonstrated the highest correlations, but other relationships ranged only from low to moderate strength.

Collectively, validity studies of the CMS have indicated that it demonstrates relatively strong relationships to other memory measures. In contrast, the CMS has low

to moderate relationships with measures of cognitive functioning, achievement, language, and executive function.

### *Procedure*

Consent and assent for the standardization data were obtained by The Psychological Corporation. Parental consent and child assent for the research sample were obtained through the MAPS study in accordance with the requirements of the Institutional Review Board. For both samples, the standardization group and the research group, all 12 subtests required for calculation of index scores were administered on the WISC-III; this excluded only the Mazes subtest from complete administration. On the CMS, all six core subtests were administered with their delay components. Standard testing procedures were followed according to instructions specified in both manuals. The order of administration of the WISC-III and CMS was not controlled. Fatigue was not believed to be a factor as testing was conducted over multiple sessions.

For the research sample, cognitive ability, memory, achievement, executive functioning, behavior, and emotional status were among the constructs assessed in the MAPS study. For those children who were being prescribed stimulant medication at the time of participation ( $n = 23$ ), parents were asked to consult their physicians regarding the option of withholding medication during testing; children were tested off stimulant medications whenever possible. Examiners were advanced doctoral students under the supervision of a licensed psychologist or a licensed psychologist herself. All examiners had been trained in standardized administration procedures for the instruments included in the study. Diagnostic considerations were provided by at least two examiners



involved in each evaluation and final diagnostic decisions were agreed upon by the group. Interdiagnostician reliability was determined using Cohen's *Kappa* for assignment to no diagnosis, ADHD, or other clinical groups ( $k = .84$ ), as well as for subtypes for children with ADHD ( $k = .93$ ). Furthermore, the proportion of agreement in the former group was .90 and it was .97 in the latter.

Because the Digit Span subtest on the WISC-III and the Numbers subtest on the CMS are virtually identical, participants in the research study often were administered only one of the two during testing; the non-administered subtest was subsequently assigned the same score. For analytic purposes, only one of the two scores provided for each subject was used. In the event that an individual was administered both subtests, and obtained different scaled scores, the average of the two scores was used in analyses; there were 68 cases that met these criteria. A Pearson correlation was computed to determine the level of agreement between Digit Span (WISC-III) and Numbers (CMS) and was found to be .67 ( $p < .001$ ). To simplify the later procedures, a combined variable was created that was the average of each person's Digit Span and Numbers scores and this new variable was used in place of either subtest score alone.

Of all of the CMS subtests administered, in both the standardization and research samples, none of the delayed recall or recognition scores were used in these analyses. The decision to eliminate them was based on Tulsy and Price's (2003) observation that the immediate and delayed recall components to the subtests on the Wechsler Memory Scale – III were highly correlated and did not support different constructs. Millis, Malina, Bowers, and Ricker (1999) and Price, Tulsy, Millis, and Weiss (2002) had

concluded the same findings in their studies of the Wechsler Memory Scale – III, suggesting that the delay scores would not add enough information to warrant their inclusion in the analyses of the CMS. The exclusion of those scores resulted in five subtest scores contributing to the combined factor analysis from the CMS. They were the Dots Total, Stories Immediate, Faces Immediate, Word Pairs Total, and Sequencing Total subtest standard scores. Recall that the Numbers subtest was combined with the Digit Span subtest from the WISC-III to create a new variable that was used in its place. Combined with the 11 subtests contributed by the WISC-III (i.e., all subtests but Mazes and Digit Span), the total number of subtests used in the combined factor analyses was 17.

As this study was based on the work by Tulskey and Price (2003), it is important to point out the minor differences in methodology here. Noted above, Tulskey and Price included the delay components of the WMS-III memory subtests and five additional subtests were used as well, based on the different makeup of the standard batteries and indexes across the WAIS-III, WMS-III, WISC-III, and CMS. The additional subtests from the WMS-III were Spatial Span, Family Pictures, Visual Reproduction, and Letter-Number Sequencing, whereas Matrix Reasoning was contributed by the WAIS-III. They experienced a similar situation in their study with the Letter-Number Sequencing subtest as it is included in the standard battery on each the WAIS-III and WMS-III, although they chose to administer it only one time per person. Conversely, several subtests from the WISC-III and CMS were used in this combined factor analysis that were not a part of

Tulsky and Price's model. They were Arithmetic (WISC-III), Sequencing and Dots from the CMS, and the combination score of Digit Span and Numbers.

#### *Data Analysis*

*Factor analytic procedures.* Several combined confirmatory factor analyses (CFA) were performed on the CMS and WISC-III standardization data to determine the nature of their combined factor structure. For this portion of the study, the AMOS 4.0 (Arbuckle & Wothke, 1999) computer software program was used. Three comparisons were made based on models for 1) one global factor, 2) Tulsky and Price's (2003) 6-factor model, and 3) a 7-factor model consisting of all of the original WISC-III and CMS factors. The model specifications are outlined in Table 6.

These models were used to run CFAs and compare the performance of many different groups on the factor structures. One group consisted of all of the cases, there were comparisons made between males and females, and finally among two age groups. The two age groupings in the analyses were labeled "younger" (ages 6-11) and "older" (ages 12-16), as determined by each child's test age. Once combined factor analyses were conducted on all of the aforementioned models, the best fitting solution was selected on the basis of fit statistics. The selected factor model was then used with the data from the MAPS research sample of children to address the remaining research questions.

Table 6

## Model specification for confirmatory factor analyses

Model and Factors	Observed Variables
Model 1 (1 global factor)	I, S, A, V, C, DS/N, PC, Cd, PA, BD, OA, SS, Dots, Stories, Faces, WP, Sequences
Model 2 (6 factors)	
Factor 1 (Verbal Comprehension)	I, C, V, S
Factor 2 (Perceptual Organization)	OA, BD, PA, PC
Factor 3 (Auditory Memory)	Stories, WP
Factor 4 (Visual Memory)	Dots, Faces
Factor 5 (Working Memory)	Sequences, DS/N, A
Factor 6 (Processing Speed)	SS, Cd
Model 3 (7 factors)	
Factor 1 (Verbal Comprehension)	I, C, V, S
Factor 2 (Perceptual Organization)	OA, BD, PA, PC
Factor 3 (Freedom From Distractibility)	A, DS
Factor 4 (Processing Speed)	SS, Cd
Factor 5 (Auditory Memory)	Stories, WP
Factor 6 (Visual Memory)	Dots, Faces
Factor 7 (Attention/Concentration)	Sequences, N

*Note.* I = Information; S = Similarities; A = Arithmetic; V = Vocabulary; C = Comprehension; DS/N = Combined Digit Span/Numbers; PC = Picture Completion; Cd = Coding; PA = Picture Arrangement; BD = Block Design; OA = Object Assembly; SS = Symbol Search; WP = Word Pairs; DS = Digit Span; N = Numbers.

*Goodness of fit indexes.* There were a number of goodness of fit indexes computed for the factor models due to the varying methods for determining the fit of the data. Conclusions regarding model fit are generally based on more than one fit index; however, it is unclear what the optimal number of tests should be. Because of conflicting conclusions in previous literature pertaining to the utility of goodness of fit indexes, Marsh, Balla, and McDonald (1988) compared over thirty different indexes used in confirmatory factor analytic studies to investigate the extent to which sample size influences results. They found that although several methods were purported to be independent of sample size, only one commonly used index, the Tucker-Lewis Index (TLI; Tucker & Lewis, 1973), remained relatively unaffected. Based on their conclusions and on the indexes selected by Tulsy and Price (2003) in their WAIS-III/WMS-III combined factor analysis, the goodness of fit indexes calculated here included the TLI, the chi-square index divided by degrees of freedom ( $\chi^2/df$ ), the root mean square error of approximation (RMSEA; Steiger, 1990), normed fit index (NFI; Bentler & Bonett, 1980), and the comparative fit index (CFI; Bentler, 1990).

There are specified guidelines for determining the strength of model fit when using these goodness of fit statistics. Hu and Bentler (1999) suggested cutoff values for fit statistics at levels that would minimize Type II error rates (i.e., the probability of failing to reject the null hypothesis when it is false) while also providing acceptable levels of Type I error rates (i.e., rejecting the null hypothesis when it is true). Their recommendations for the TLI, CFI, and NFI included values close to .95 or higher for good model fit. When using the  $\chi^2/df$  statistic to measure goodness of fit, a value less

than 2.00 is desirable, according to Byrne (1989). Browne and Cudeck (1993) established that RMSEA values less than .05 indicate close fit while values from .05 to .08 suggest reasonable fit; poor fit is indicated when RMSEA values are greater than .10.

For model comparisons, the expected cross-validation index (ECVI; Browne & Cudeck, 1989, 1993) was used, as it is advised for identifying the solution with the greatest generalizability, particularly when the sample size is small. The ECVI measures the difference between the fitted covariance matrix in the analyzed sample and the expected covariance matrix from another sample of the same size. Once the ECVI values have been computed for all models, they are placed in rank order and the model with the lowest ECVI represents the best fit to the data. Because the obtained ECVI values are meaningful only in comparison with one another, there is no specified range of ECVI values that is desirable.

*MANCOVA, ANOVA, and discriminant analysis.* In order to control for potential gender or age differences within the data, multiple analyses of covariance (MANCOVA) were computed with the research sample data. First, the MANCOVA was used to determine whether the clinical (i.e., ADHD diagnosis) and nonclinical (i.e., no diagnosis) groups were found to perform differently on the resulting joint factor structure from the factor analysis. Follow-up ANOVAs were performed to provide more specific information pertaining to the group differences. Discriminant analyses were then performed to determine whether the factors were able to discriminate between the ADHD and no diagnosis groups. A second set of ANOVAs was also conducted to

examine ADHD Predominately Inattentive and Combined Type differences (Question 3).

*Sensitivity and specificity.* To address Question 4, an analysis of the sensitivity and specificity of individual factors was conducted by evaluating the Receiver Operating Characteristic (ROC) curves. The ROC curves were used to determine the probability of obtaining a true positive diagnosis of ADHD and the probability of a false positive determination, based on factor scores. In other words, the accuracy of the score on the factor depended on how well it separated the children being tested into those with and without ADHD, as measured by the area under the ROC curve.

The area under the ROC curve measures discrimination in terms of the ability of the test to correctly classify those with and without the disorder. A magnitude of area under the curve of 1 represents a perfect test, while the breakdown of the levels of accuracy are as follows: 0.90 – 1.0 is excellent, 0.80 – 0.90 is good, 0.70 – 0.80 is fair, 0.60 – 0.70 is poor, and an area under the ROC curve of .50 – .60 fails to separate the groups (Metz, 1978).

The following chapter will present the results of the ROC curves in addition to results from each of the other analyses performed in this study. The final chapter will discuss the overall results of this combined factor analysis in light of previous research on this topic. Implications of the findings of the study and suggestions for future research also will be discussed.

## CHAPTER IV

### RESULTS

In the previous chapters, a basis for this combined confirmatory factor analysis was established by reviewing existing research and identifying areas lacking consistent empirical support. Subsequently, the methodology used in this study was detailed in Chapter III. Results of the statistical analyses performed in this project are presented in this chapter within the context of the initial research questions presented.

The cornerstone of this study was the idea that the information obtained from complete administrations of the Wechsler Intelligence Scale for Children – Third Edition (WISC-III; Wechsler, 1991) and Children’s Memory Scale (CMS; Cohen, 1997) in one comprehensive evaluation may be somewhat redundant in the sense that the instruments seem to provide similar information pertaining to a child’s functioning. It was hypothesized that the subtests from the WISC-III and CMS could be combined to form a more cohesive instrument measuring cognitive and memory functioning in less time than it takes to administer both tests individually. The first research question was intended to begin to address this issue:

Research Question 1: Do the data from the CMS and WISC-III combine to yield a different factor structure based on the standardization data?

#### *Confirmatory Factor Analysis*

A combined confirmatory factor analysis was conducted testing three prespecified models (i.e., one-factor, six-factor, and seven-factor) using various sample groups of the standardization data (i.e., all data, males, females, older, younger). The



WISC-III and CMS subtests comprising each of the models can be found in the previous chapter. For Model 1 (one-factor), each sample group was analyzed individually on the factor structure and modification indices were examined to determine whether estimating additional parameters could improve model fit. During this process, parameter changes were made only when they made theoretical sense. For this model, across sample groups, the following residuals were covaried one-by-one to maximize fit: 1) Block Design and Object Assembly residuals were covaried, 2) Symbol Search and Coding residuals were covaried, and 3) Digit Span/Numbers and Sequences residuals were covaried. These changes consistently yielded improved model fit across groups. The final specification of Model 1 is illustrated in Figure 1 and fit statistics are presented in Table 7.

Models 2 and 3 yielded inadmissible solutions on the first round of analyses with all sample groups, suggesting that the models were misspecified. For Model 2 (six-factor), the reason for this result was that the Visual Memory factor (comprised of Dots and Faces) had a negative variance associated with it. In their work with the WAIS-III and WMS-III, Tulskey and Price (2003) reported that Faces had unacceptably poor loadings on the factor. Using this justification, Faces was eliminated from the current model and the analyses were rerun to determine if a solution could be found; however, simply removing Faces did not suffice. For the next step, Dots was moved to the Perceptual Organization factor and the Visual Memory factor was removed entirely.

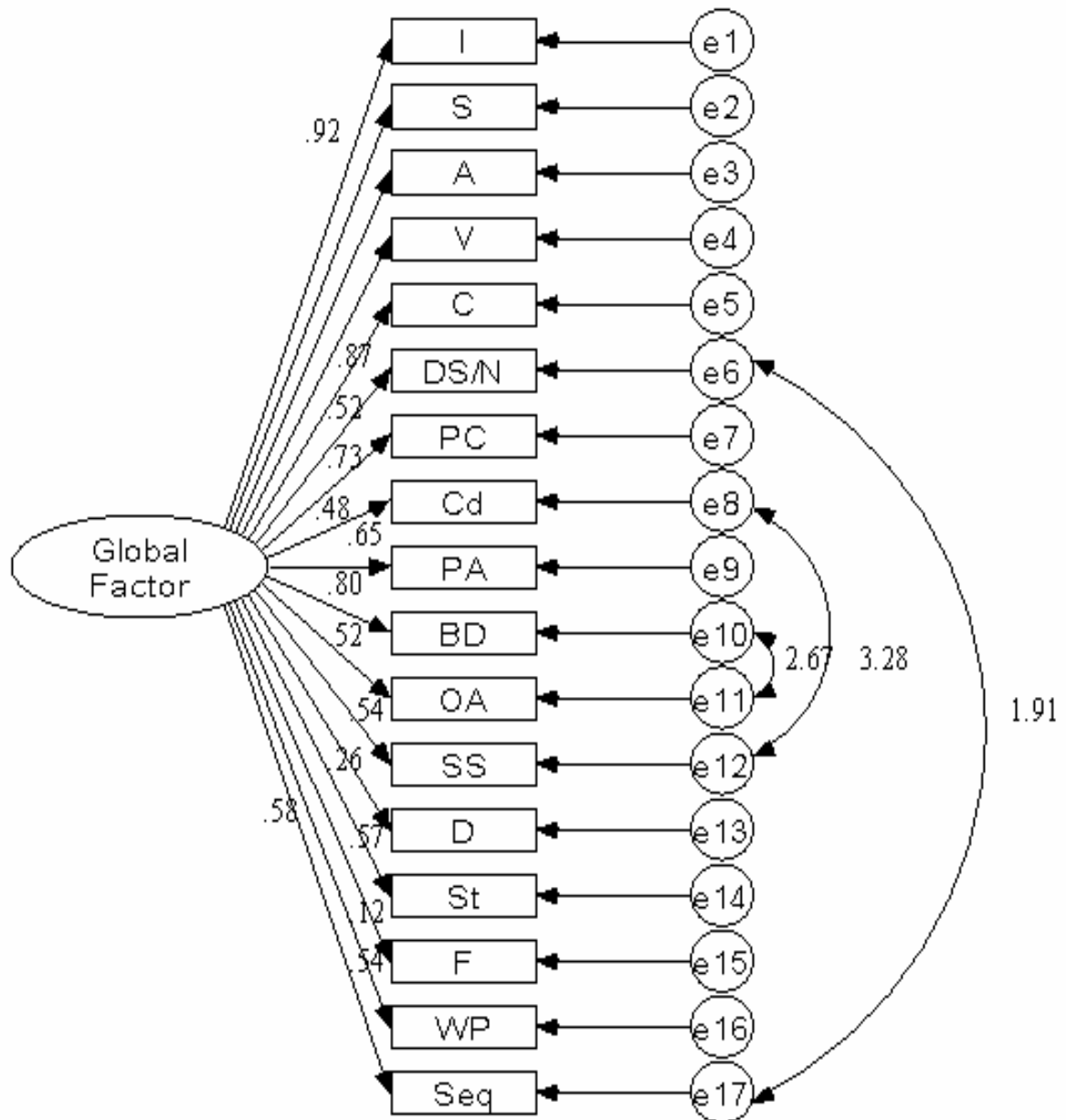

Fig. 1. Path specifications for the one-factor model. I = Information; S = Similarities; A = Arithmetic; V = Vocabulary; C = Comprehension; DS/N = Digit/Span Numbers combined score; PC = Picture Completion; Cd = Coding; PA = Picture Arrangement; BD = Block Design; OA = Object Assembly; SS = Symbol Search; D = Dots; St = Stories; F = Faces; WP = Word Pairs; Seq = Sequences.

Table 7

Goodness of fit statistics for confirmatory factor analyses

Model	$\chi^2/df$	TLI	RMSEA	NFI	CFI	ECVI
1 (1 Factor)						
All data	3.147	.983	.074	.981	.987	1.198
Females	2.127	.982	.077	.974	.986	1.857
Males	2.185	.982	.076	.975	.986	1.780
Younger	2.599	.981	.077	.977	.986	1.522
Older	1.853	.979	.083	.966	.984	2.583
2 (6 Factors)						
Solution not Admissible						
3 (7 Factors)						
Solution not Admissible						
4 (5 Factors)						
All data	2.025	.992	.051	.990	.950	.775
Females	1.636	.990	.058	.983	.993	1.414
Males	1.802	.988	.063	.982	.992	1.407
Younger	1.915	.990	.058	.986	.993	1.101
Older	1.515	.988	.064	.976	.992	2.071

*Note.* TLI = Tucker-Lewis index; RMSEA = root mean squared error of approximation; NFI = normed fit index; CFI = comparative fit index; ECVI = expected cross-validation index.

This resulted in a five-factor model comprised of the remaining subtests of the WISC-III and CMS.

The five-factor model was analyzed successfully and modification indices were inspected to improve model fit. The residuals for Block Design and Object Assembly were covaried followed by the same modification on the residuals for Picture Arrangement and Stories. The same steps were followed for all of the sample groups in the study. The resulting five-factor model is illustrated in Figure 2 and fit statistics are presented in Table 7.

Similar steps were followed in the analysis of Model 3 (seven-factor) as well. Because its original solution was inadmissible, and because the changes made to Model 2 resulted in a successful solution, the same procedures were followed. First, Dots was moved to the Perceptual Organization factor and the Visual Memory factor was removed. This step did not result in an admissible solution so both Dots and Faces were reassigned to the Perceptual Organization factor, Visual Memory was removed, and the model was reanalyzed. Again, these modifications were unsuccessful. Next, Dots, Faces, and the Visual Memory factor were all eliminated from analyses, again resulting in an unsuccessful attempt. After all plausible modifications were made to the seven-factor model, it was concluded that the model did not provide the most appropriate explanation of the abilities measured by a combined approach to the WISC-III and CMS.

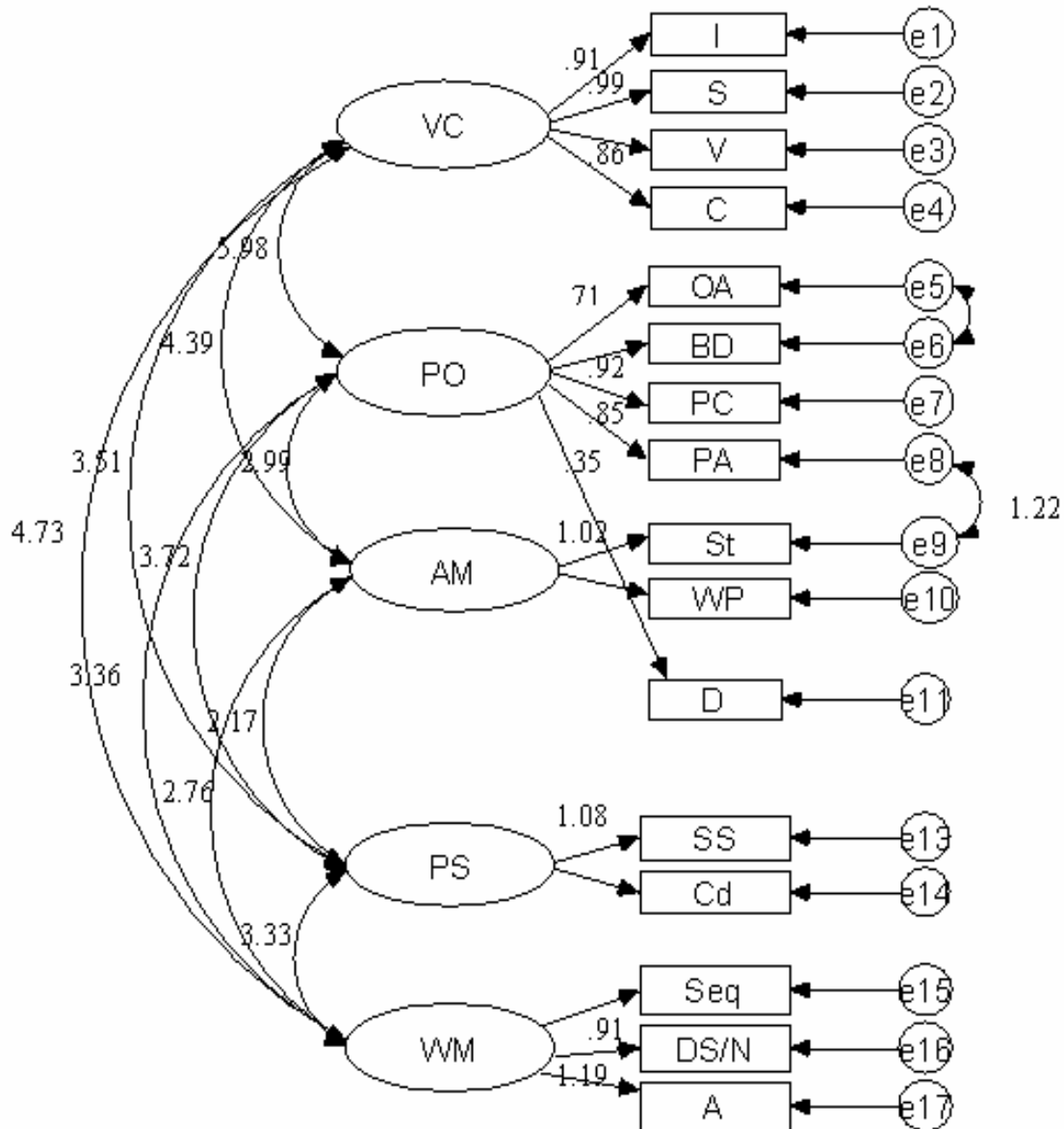

Fig. 2. Path specifications for the five-factor model. VC = Verbal Comprehension; PO = Perceptual Organization; AM = Auditory Memory; PS = Processing Speed; WM = Working Memory; I = Information; S = Similarities; V = Vocabulary; C = Comprehension; OA = Object Assembly; BD = Block Design; PC = Picture Completion; PA = Picture Arrangement; St = Stories; WP = Word Pairs; D = Dots; SS = Symbol Search; Cd = Coding; Seq = Sequences; DS/N = Digit Span/ Numbers combined score; A = Arithmetic.

### *Model Fit*

As previously stated, when comparing goodness of fit statistics across models, the ultimate goal is to find the model with the lowest ECVI value. The TLI, NFI, and CFI values should be closest to 1.0 and RMSEA values of .05 or smaller are best. Additionally, the  $\chi^2/df$  statistic optimally should be less than 2.0 to indicate good model fit. A close examination of the goodness of fit statistics for Model 1 reveals that this model appears to fit the entire data set better than any one of the subgroups alone. Although the  $\chi^2/df$  statistic is higher (i.e., indicating less fit) than the other samples on the model, the remainder of the fit statistics suggest better fit than do the values for the other samples on Model 1. Fit statistics are not provided for Models 2 and 3 due to their resulting inadmissible solutions. Similar to Model 1 fit results, Model 4 explained the full data set better than it explained sample subgroups. This new five-factor model created as a result of the failures of Models 2 and 3 also demonstrated improved fit over Model 1 based on the ECVI statistic. Based on the aforementioned criteria, one can conclude that Model 4 provides a good explanation for the observed data. Consequently, the five-factor model was the basis for the remainder of the analyses conducted in this study.

### *Replication with Research Sample*

Research sample data from all of the participants in the MAPS project were used in replication analyses in order to determine whether the one- and five-factor models demonstrated adequate fit in a smaller group. Initially, the original models were used, removing all previous modifications made for the standardization sample. Subsequently,

both models were modified to match the finalized versions used with the standardization sample, including the added covariances among variables. Results are presented in Table 8. Examination of the fit statistics reveals very minor differences in the performance of the models, indicating that neither one demonstrated clearly superior fit in the research sample data.

Table 8

MAPS sample fit statistics for one- and five-factor models

Model	$\chi^2/df$	TLI	RMSEA	NFI	CFI	ECVI
1 Factor						
No modifications	1.539	.981	.077	.959	.985	3.099
With same modifications as SS	1.398	.986	.066	.964	.989	2.937
5 Factor						
No modifications	1.295	.906	.057	.754	.926	2.237
With same modifications as SS	1.323	.897	.059	.754	.921	2.279

*Note.* SS = standardization sample; TLI = Tucker-Lewis index; RMSEA = root mean square error of approximation; NFI = normed fit index; CFI = comparative fit index; ECVI = expected cross-validation index.

### *Research Sample Group Comparisons*

The data from the MAPS research sample were subjected to multiple analyses of variance (MANOVA) to investigate potential age and gender differences on the factors. Results indicated that while there were no significant age effects among scores on the factors [Wilks'  $\Lambda = .945$ ,  $F(5,86) = .99$ ,  $p = .43$ ], when gender was analyzed, a significant difference was found between males and females [Wilks'  $\Lambda = .877$ ,  $F(5,86) = 2.41$ ,  $p < .05$ ]. Accordingly, subsequent analyses were conducted covarying for gender. Univariate results indicated that there was a significant difference found in performance between males and females on the Processing Speed factor [ $F(1,91) = 9.20$ ,  $p < .01$ ].

Research Question 2: For a research sample, if the combined factor structure is different, with what accuracy do these factors differentiate ADHD versus nonclinical sub-samples?

To address this question, the five-factor model that was created as a result of the combined confirmatory factor analysis of the CMS and WISC-III was used. This set of analyses was conducted to compare how the children with ADHD in the research sample performed on the five factors in comparison to children with no diagnosis. To make this determination, analyses of covariance (ANCOVA) were conducted for each of the factors, covarying for gender. Results indicated that on three of the factors, the ADHD and no diagnosis groups were significantly different. The children with ADHD were significantly different from the children with no diagnosis on the Verbal Comprehension, Working Memory, and Processing Speed factors. For all five factors, the no diagnosis group obtained higher scores than the ADHD group, as evident by



examining the group means for each factor. Complete ANCOVA results and the group means are presented in Table 9 below.

Table 9

ANCOVA results for the five factors and their group means

Factor and Group	<i>M (SD)</i>	<i>F</i>	<i>p</i>	$\eta^2$
Verbal Comprehension		4.06	.048*	.060
ADHD	10.04 (2.08)			
No Diagnosis	11.37 (2.59)			
Perceptual Organization		.836	.364	.013
ADHD	10.56 (1.66)			
No Diagnosis	11.02 (1.76)			
Auditory Memory		2.37	.129	.036
ADHD	10.56 (2.76)			
No Diagnosis	11.63 (2.97)			
Working Memory		7.14	.010*	.100
ADHD	9.28 (2.15)			

Table 9, continued

Factor and Group	<i>M (SD)</i>	<i>F</i>	<i>p</i>	$\eta^2$
No Diagnosis	10.71 (2.56)			
Processing Speed		6.56	.013*	.093
ADHD	9.66 (2.46)			
No Diagnosis	11.88 (2.65)			

\* $p < .05$ .

#### *Discriminant Analysis*

Discriminant function analyses were conducted on the MAPS data next to determine how accurately these five factors were able to classify children into the ADHD and no diagnosis groups based on their subtest performance. One discriminant function was identified and Wilks'  $\Lambda$ , which tests the significance of the discriminant function as a whole, was significant (Wilks'  $\Lambda = .804, p = .02$ ). Using all five factors as predictors, results indicated that 64.2% of the original grouped cases were correctly classified. The discriminant function was only slightly better at correctly classifying children identified as having ADHD (65.9%). The complete classification results are presented in Table 10.

Table 10

Discriminant analysis classifications of ADHD and No Diagnosis groups using 5-factor model

Group	Predicted Group Membership		Total
	No Diagnosis	ADHD	
No Diagnosis	16 (61.5%)	10 (38.5%)	26
ADHD	14 (34.1%)	27 (65.9%)	41
Ungrouped Cases	4 (15.4%)	22 (84.6%)	26

Additional discriminant analyses were performed on the one-factor model and also the Freedom from Distractibility index (FFD) from the WISC-III using the research sample data. Again, the goal of these analyses was to determine how well the one-factor model and the FFD each classified children into ADHD and no diagnosis groups. For the one-factor model, Wilks'  $\lambda$  was significant (Wilks'  $\lambda = .895, p < .01$ ). Classification results indicated that the one-factor model correctly classified 62.7% of the original grouped cases and 63.4% of the children with ADHD. Conversely, for the FFD, Wilks'  $\lambda$  was not significant (Wilks'  $\lambda = .953, p = .08$ ) and only 55.2% of the original cases were correctly classified. Interestingly, 65.9% of the children with ADHD were correctly

classified by the FFD, which is equivalent to the classification results on the five-factor model. Closer examination of the results suggests that the FFD overidentifies ADHD in children without clinical disorders. Table 11 presents the classification results for the FFD.

Table 11

Discriminant analysis classifications of ADHD and No Diagnosis groups using the FFD

Group	Predicted Group Membership		Total
	No Diagnosis	ADHD	
No Diagnosis	10 (38.5%)	16 (61.5%)	26
ADHD	14 (34.1%)	27 (65.9%)	41

Research Question 3: Do group differences emerge in the research sample between the Predominantly Inattentive and Combined Types of ADHD on the combined factor model?

A set of ANOVAs was computed to answer this question for the subtypes of ADHD in the research sample. Results indicated that no significant differences between the groups were evident on the five factors. Thus, the children grouped by ADHD

subtype, Predominantly Inattentive and Combined Type, did not perform significantly different on the factors of the model. For Verbal Comprehension,  $F(1,39) = 0.35$ ,  $p = .56$ ; for Perceptual Organization,  $F(1,39) = 2.67$ ,  $p = .11$ ; for Auditory Memory,  $F(1,39) = 2.64$ ,  $p = .11$ ; for Working Memory,  $F(1,39) = .35$ ,  $p = .56$ ; and for Processing Speed,  $F(1,39) = 1.19$ ,  $p = .28$ .

Research Question 4: What are the sensitivity and specificity of the factors relative to ADHD?

To determine the sensitivity and specificity of the factors with regard to ADHD diagnosis, the area under the ROC curve was measured for each one. The goal of the analyses was to find out how accurately each factor separated the children into those with ADHD and those without it, based on their factor scores; the greater the area under the curve, the better sensitivity and specificity of the factor. Results indicated that all five factors failed to separate the groups, as illustrated in Figures 3-7. Specifically, Verbal Comprehension area = .347, Working Memory area = .341, Perceptual Organization area = .434, Processing Speed area = .279, and Auditory Memory area = .402.

Following analyses of the five factors, two additional ROC curves were computed for the one-factor model and the FFD to learn whether they performed any better than the individual factors in the five-factor model with the diagnosis of ADHD. Consistent with the findings for the five factors, they both failed to adequately separate the groups into those with and without the disorder. The area under the curve for the global factor = .310 and the area under the curve for the FFD = .377.

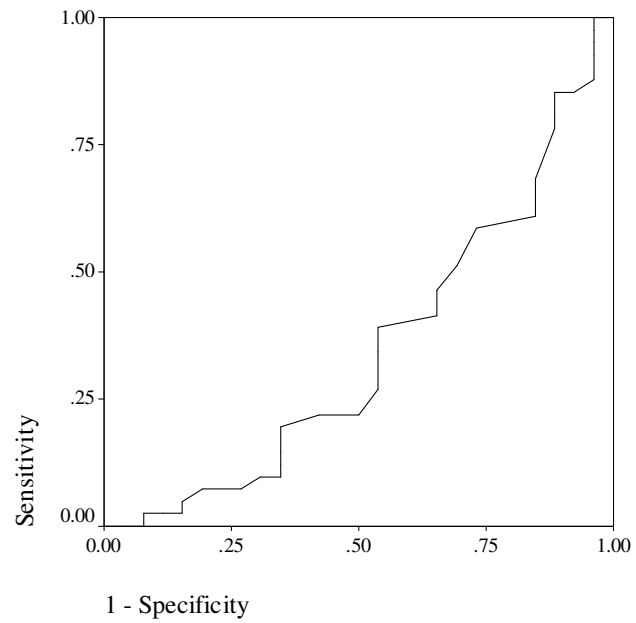

Figure 3. ROC curve for Verbal Comprehension. (Area under the curve = .347).

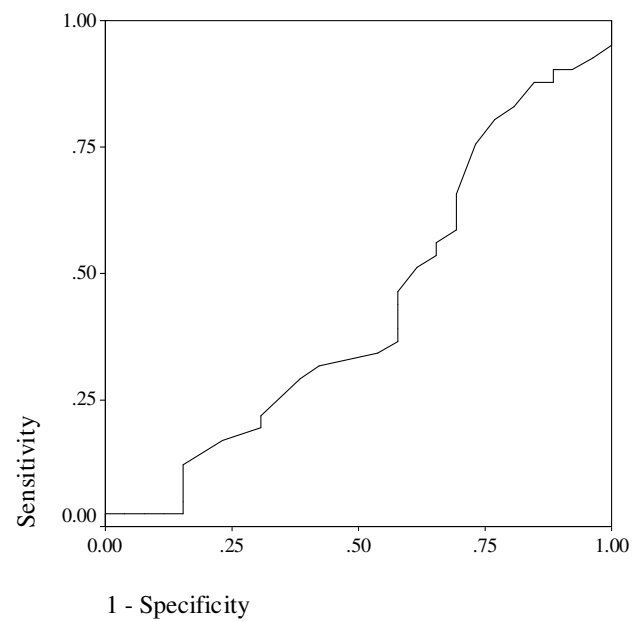

Figure 4. ROC curve for Working Memory. (Area under the curve = .341).

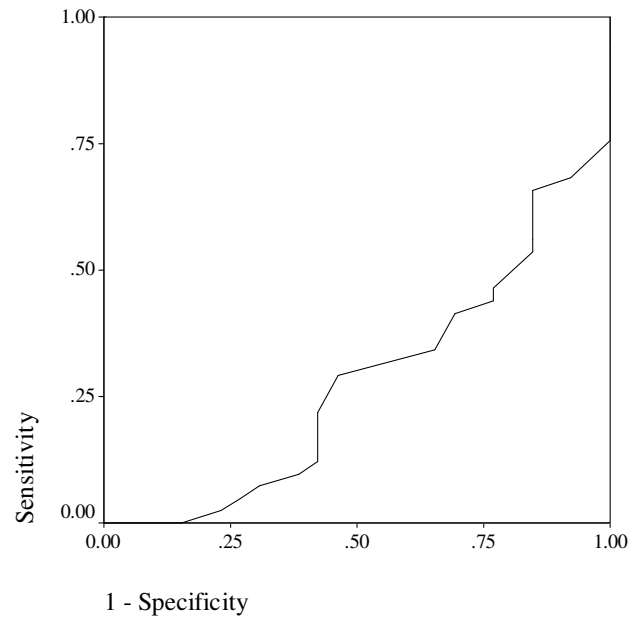

Figure 5. ROC curve for Perceptual Organization. (Area under the curve = .434).

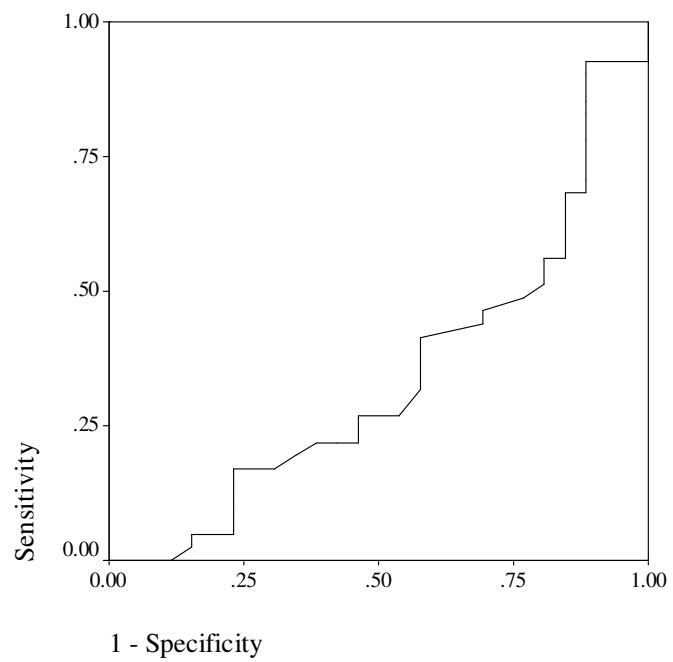

Figure 6. ROC curve for Processing Speed. (Area under the curve = .279).

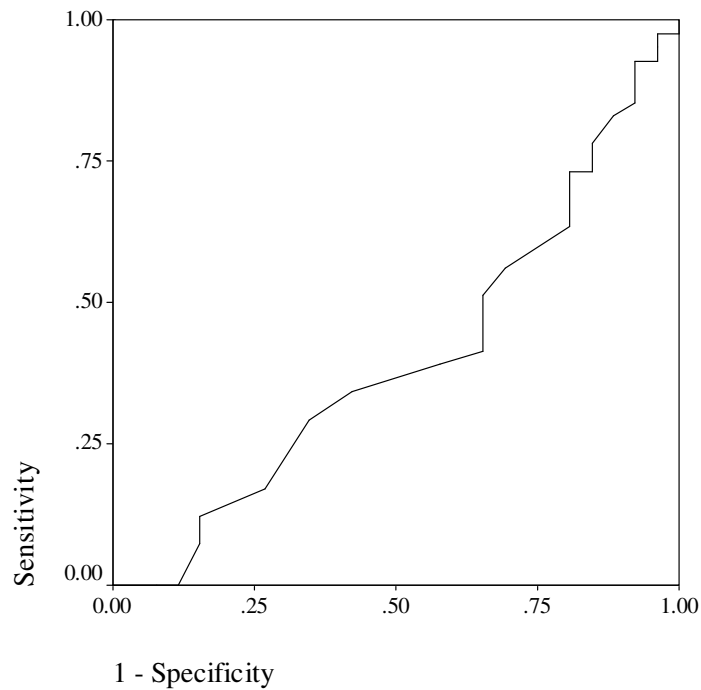

Figure 7. ROC curve for Auditory Memory. (Area under the curve = .402).

This concludes the chapter in which the results of the confirmatory factor analyses were presented along with subsequent computations of research sample performance on the combined factor structure. The implications of the ROC curve findings and those from all other analyses performed will be addressed in the next chapter. Additionally, the limitations of this study and suggestions for future research will be discussed.



## CHAPTER V

### SUMMARY AND CONCLUSIONS

The previous chapters have established the basis for this research study and provided an overview of pertinent research pertaining to the Wechsler Intelligence Scale for Children – Third Edition (WISC-III; Wechsler, 1991), Children’s Memory Scale (CMS; Cohen, 1997), Attention-Deficit/ Hyperactivity Disorder (ADHD), and the use of confirmatory factor analyses in research. The methodology that was employed for collecting data and conducting the statistical analyses were presented in Chapter III with the results of those analyses following in Chapter IV. In this chapter, the implications of this study are discussed, the limitations of the project are identified, and future directions for further research are suggested.

#### *Summary and Implications*

It was the primary intent of this project to identify a combined factor solution for use with the WISC-III and CMS in a cross-battery approach for cognitive and memory assessment in children. Initially, there were three factor models proposed: 1) a one-factor, global construct of cognitive and memory ability, 2) a six-factor solution based on the results of a combined confirmatory factor analysis of the WAIS-III and WMS-III by Tulskey and Price (2003), and 3) a seven-factor model comprised of the four original factors on the WISC-III and the three factors on the CMS. In order to test the competing models, standardization data were obtained from The Psychological Corporation in which participants were administered both the WISC-III and CMS as part of the process of establishing test norms.

Of the three proposed models applied to the standardization data, only the one-factor model resulted in an admissible solution, signifying that the other two models were misspecified and were not acceptable. The goodness of fit statistics for the one-factor model were compared across different subsamples of the data (i.e., males, females, older, younger, all data), with varying degrees of fit noted. Comparisons among the fit statistics indicated that the one-factor model fit the full data set better than it fit any of the smaller subsets of the data.

In the process of respecifying the six-factor model, a five-factor model emerged that successfully fit the data; the factors were considered Verbal Comprehension (VC), Perceptual Organization (PO), Auditory Memory (AM), Working Memory (WM), and Processing Speed (PS). The goodness of fit statistics were compared across subsets of the data, as they were in the one-factor model, with a clear indication that again, the five-factor model fit the full data set better than it fit any of the subgroups within the data. When the one-factor and five-factor models were compared to each other, the five-factor solution demonstrated superior fit over the one-factor model. However, these statistics do not necessarily establish the five-factor model as the correct model, but rather, that it is a plausible solution for the data.

At this point, the primary objective of the study was accomplished. The original inquiry pertained to whether or not a unique factor solution existed for the combination of the WISC-III and CMS; the seven-factor solution, which would have been closer to the originating factors, was inadmissible and the five-factor model provided a good explanation for the data. Accordingly, the remainder of the analyses in the study were

based on this new five-factor model of cognitive and memory functioning from the combination of subtests from the WISC-III and CMS.

As this work was based, in part, on the combined confirmatory factor analysis of the WAIS-III and WMS-III by Tulskey and Price (2003), the differences in the final results of the two studies should be addressed here. To begin with, the six-factor model initially proposed in this study was taken directly from their conclusions that the six-factor model provided the best fit to their adult data on the instruments examined. The fact that the six-factor model was not a feasible solution in this study may be explained by developmental trends in cognitive and memory abilities across the age span. For example, the lack of a consistent visual memory factor in the child data may illustrate memory differences in children and adults. Alternatively, minor variations in factor composition or task demands may be at fault. Regardless of the reason for the different combined factor models in adults and children, it is clear that one cannot make assumptions about similar instruments thought to measure equivalent constructs across the lifespan.

The research sample of data collected as part of the MAPS study was used for all subsequent analyses of group performance. In the research sample, when the performance of males and females on the five factors was examined, significant differences between them were evident on the Processing Speed factor. This result was unexpected and the reason for this difference is unclear. It is possible that the specific demographics of the research sample caused these results although it remains to be seen whether the same differences would appear in alternative samples of children.

Interestingly, age differences were not found in the research sample on the five-factor model, which contrasts with earlier findings with the four-factor model of the WISC-III. For example, Blaha and Wallbrown (1996) reported that the Freedom from Distractibility (FFD) factor was not evident in 6-7 year-olds. One plausible explanation for the difference could be the combined model's inclusion of a third subtest (i.e., Sequences) to what was previously referred to as the FFD, resulting in what is called the Working Memory factor in the five-factor solution. The increase in the number of subtests appears to have created a more reliable factor which, in turn, may be more applicable to the youngest age group than the previous FFD factor.

Another set of analyses conducted in this study revealed that there was a significant difference in the performance of children with ADHD and those with no diagnosis on three of the five factors in the model (i.e., Processing Speed, Verbal Comprehension, and Working Memory). Historically, there has been a great deal of interest in the performance of children with ADHD on tasks of working memory, so that particular finding is not unexpected. On the other hand, the differences in processing speed and verbal comprehension among the two groups are more intriguing. Future research should strive to replicate this work in order to investigate this finding more closely.

This study failed to find significant differences in the performance of children grouped by ADHD subtypes (i.e., Predominantly Inattentive and Combined Type) on the five factors. Instead, it appeared that the children diagnosed with ADHD, regardless of subtype, were more similar than different in their performances. Collectively, the

children classified with different subtypes of ADHD differed more from the children with no diagnosis in the study.

Discriminant function analyses were performed on the five-factor model to explore the predictive abilities of the factor structure in the diagnosis of ADHD in children. Results indicated that the model correctly classified 66% of children with ADHD. Thus, predicting ADHD diagnosis based on these five factors is not considered accurate enough to warrant their use without supplementing the WISC-III and CMS scores with additional diagnostic means. However, when used in conjunction with other measures, the utility of the five-factor model in making a definitive determination about ADHD diagnosis is improved and it can be a valuable contribution to an assessment battery for ADHD. Nonetheless, this should not be interpreted to mean that a particular profile of performance on this five-factor model should result in an ADHD diagnosis. Due to the heterogeneity within the group of children with ADHD, there exists great potential for misinterpretation on the basis of scores from one test administration.

These analyses can assist psychologists in clinical decision making and can provide valuable information pertaining to a child's cognitive and memory strengths and weaknesses. Specific skills and deficits identified by using the combination of the WISC-III and CMS may preclude the use of less empirically supported instruments for deriving recommendations and strategies for assisting children in the academic setting. The applicability of those suggestions also will be far greater than those pieced together from informal observations or evaluation procedures.

One of the original goals of this work was to determine whether a combined approach to assessment using the WISC-III and CMS would result in a more efficient cross-battery evaluation of a child's cognitive and memory functioning. Following a combined confirmatory factor analysis, the five-factor integrated model was identified using subtests from both instruments. In fact, if one were to administer only those subtests from the WISC-III and CMS that are necessary for interpreting the results within the context of the five-factor model, a fewer total number of subtests is required. That is, the Faces subtest and all of the delay components of the CMS could be eliminated. Moreover, rather than administering both Digit Span and Numbers, only one of the two subtests would be required. Until further research investigates the performance of children within other demographic and/or clinical groups on this factor structure, caution should be used when using this model or applying the results, as their generalizability will not have been definitively established.

#### *Limitations and Suggestions for Future Research*

When considering the generalizability of the results of this study to other samples, it is important to note the limitations that may affect how well these data will apply. Several characteristics of the research sample were less than optimal. For one, the overall research sample was relatively small and results pertaining to ADHD diagnosis were based on even smaller numbers; however, this is not uncommon for studies within this area of research. There also was limited ethnic and socioeconomic diversity among research study participants that may impact generalizability of these results. Due to the

number of examiners used in data collection for both the standardization sample and the research sample, likelihood for examiner error also may be a limitation in the study.

In the future, studies should be conducted to ascertain whether the factor structure proposed here is supported in various clinical populations and across demographic groups. Alternative models for the WISC-III and CMS also should be developed and tested to determine whether the five-factor model continues to be the most supported. Variations on the five-factor model could be explored as well, for example, using a different combination of subtests from the WISC-III and CMS or adding those subtests that were eliminated in this study. Another possible direction for research involves reducing even further the list of subtests used in the combined factor analysis, with the goal of fewer subtests administered without losing valuable information about cognitive and memory functioning.

## REFERENCES

- Allen, S.R., & Thorndike, R.M. (1995a). Stability of the WAIS-R and WISC-III factor structure using cross-validation of covariance structures. *Journal of Clinical Psychology, 51*, 650-657.
- Allen, S.R., & Thorndike, R.M. (1995b). Stability of the WPPSI-R and WISC-III factor structure using cross-validation of covariance structure models. *Journal of Psychoeducational Assessment, 13*, 3-20.
- American Psychiatric Association. (1994). *Diagnostic and statistical manual of mental disorders* (4<sup>th</sup> ed.). Washington, DC: American Psychiatric Association.
- American Psychiatric Association. (2000). *Diagnostic and statistical manual of mental disorders* (4<sup>th</sup> ed. Text Revision). Washington, DC: American Psychiatric Association.
- Anastopoulos, A.D., Spisto, M.A., & Maher, M.C. (1994). The WISC-III freedom from distractibility factor: Its utility in identifying children with attention deficit hyperactivity disorder. *Psychological Assessment, 6*(4), 368-371.
- Arbuckle, J.L., & Wothke, W. (1999). *Amos 4.0 user's guide*. Chicago: Smallwaters.
- Avis, K.T. (2000). *ADHD and working memory: An evaluation of children's performance on the Children's Memory Scale*. Unpublished doctoral dissertation, University of Massachusetts, Amherst.
- Barkley, R.A. (1996, June). Clinical use of the third factor – proceed with caution. *The ADHD Report, 4*(3), 6-8.
- Barkley, R.A. (1997). *ADHD and the nature of self-control*. New York: Guilford Press.



- Bentler, P.M. (1990). Comparative fit indexes in structural models. *Psychological Bulletin*, *107*, 238-246.
- Bentler, P.M., & Bonett, D.G. (1980). Significance tests and goodness of fit in the analysis of covariance structures. *Psychological Bulletin*, *88*, 588-606.
- Blaha, J. & Wallbrown, F.H. (1996). Hierarchical factor structure of the Wechsler Intelligence Scale for Children–III. *Psychological Assessment*, *8*, 214-218.
- Bowden, S.C., Carstairs, J.R., & Shores, E.A. (1999). Confirmatory factor analysis of combined Wechsler Adult Intelligence Scale-Revised and Wechsler Memory Scale – Revised scores in a healthy community sample. *Psychological Assessment*, *11*, 339-344.
- Browne, M.W., & Cudeck, R. (1989). Single sample cross-validation indices for covariance structures. *Multivariate Behavioral Research*, *24*, 445-455.
- Browne, M.W., & Cudeck, R. (1993). Alternative ways of assessing model fit. In K.A. Bollen, & J.S. Long (Eds.), *Testing structural equation models* (pp. 136-162). Newbury Park, CA: Sage.
- Burton, D.B., Sepehri, A., Hecht, F., VandenBroek, A., Ryan, J.J., & Drabman, R. (2001). A confirmatory factor analysis of the WISC-III in a clinical sample with cross-validation in the standardization sample. *Child Neuropsychology*, *7*(2), 104-116.
- Byrne, B.M. (1989). *A primer of LISREL: Basic applications and programming for confirmatory factor analytic models*. New York: Springer-Verlag Telos.
- Byrne, B.M. (2001). *Structural equation modeling with AMOS: Basic concepts*,

*applications, and programming*. Mahwah, NJ: Lawrence Erlbaum Associates, Inc.

- Carroll, J.B. (1993). What abilities are measured by the WISC-III? In B.A. Bracken & R.S. McCallum (Eds.), *Journal of Psychoeducational Assessment: Advances in psychoeducational assessment, monograph series* (pp. 134-143). Brandon, VT: Clinical Psychology Publishing Co., Inc.
- Chan, D.W. (1984). Factor analysis of the HK-WISC at 11 age levels between 5 and 15 years. *Journal of Consulting and Clinical Psychology, 52*(3), 482-483.
- Cohen, J. (1959). The factor structure of the WISC at ages 7-6, 10-6, and 13-6. *Journal of Consulting Psychology, 23*, 285-299.
- Cohen, M.J. (1997). *Children's Memory Scale*. San Antonio, TX: The Psychological Corporation.
- Cohen, M.J., Ledbetter, M., & Benavides, D. (1999, November). *Learning and memory performance of children with specific language impairment (SLI) on the Children's Memory Scale*. Paper presented at the 19<sup>th</sup> annual meeting of the National Academy of Neuropsychology, San Antonio, Texas.
- CTB Macmillan/ McGraw-Hill. (1988). *California Achievement Test* (Form E.). Monterey, CA: Author.
- CTB Macmillan/ McGraw-Hill. (1989). *Comprehensive Tests of Basic Skills – Fourth Edition*. Monterey, CA: Author.
- Delis, D., Kramer, J., Kaplan, E., & Ober, B. (1994). *California Verbal Learning Test – Children's Version*. San Antonio, TX: The Psychological Corporation.

- Donders, J., Tulsky, D.S., & Zhu, J. (2001). Criterion validity of new WAIS-III subtest scores after traumatic brain injury. *Journal of the International Neuropsychological Society*, 7, 892-898.
- Elliot, C.D. (1990). *Differential Ability Scales*. San Antonio, TX: The Psychological Corporation.
- Garson, G.D. (n.d.). *GLM: MANOVA and MANCOVA*. Retrieved November 2, 2003, from <http://www2.chass.ncsu.edu/garson/pa765/manova.htm>
- Golden, J. (1996). Are tests of working memory and inattention diagnostically useful in children with ADHD? *ADHD Report*, 4(5), 6-8.
- Greenblatt, E., Mattis, S., & Trad, P.V. (1991). The ACID pattern and the Freedom from Distractibility factor in a child psychiatric population. *Developmental Neuropsychology*, 7, 121-130.
- Grice, J.W., Krohn, E.J., & Logerquist, S. (1999). Cross-validation of the WISC-III factor structure in two samples of children with learning disabilities. *Journal of Psychoeducational Assessment*, 17, 236-248.
- Hieronymus, A.N., Hoover, H.D., & Linquist, E.E. (1989). *Iowa Test of Basic Skills*. Chicago: Riverside.
- Hildebrand, D.K., & Ledbetter, M.F. (2001). Assessing children's intelligence and memory: The Wechsler Intelligence Scale or Children-Third Edition and the Children's Memory Scale. In J.J.W. Andrews, & D.H. Saklofske, (Eds.), *Handbook of psychoeducational assessment: Ability, achievement, and behavior in children* (pp. 13-32). San Diego, CA: Academic Press.

- Hu, L., & Bentler, P.M. (1999). Cutoff criteria for fit indexes in covariance structure analysis: Conventional criteria versus new alternatives. *Structural Equation Modeling, 6*(1), 1-55.
- Kamphaus, R.W., Benson, J., Hutchinson, S., & Platt, L.O. (1994). Identification of factor models for the WISC-III. *Educational and Psychological Measurement, 54*(1), 174-186.
- Kaufman, A. S. (1975). Factor analysis of the WISC-R at eleven age levels between 6 ½ and 16 ½ years. *Journal of Consulting and Clinical Psychology, 43*, 135-147.
- Keith, T.Z., & Witta, E.L. (1997). Hierarchical and cross-age confirmatory factor analysis of the WISC-III: What does it measure? *School Psychology Quarterly, 12*(2), 89-107.
- Konold, T.R., Kush, J.C., & Canivez, G.L. (1997). Factor replication of the WISC-III in three independent samples of children receiving special education. *Journal of Psychoeducational Assessment, 15*, 123-137.
- Kostura, D.D. (1993). Using the WISC-R Freedom from Distractibility factor to identify attention deficit hyperactivity disorder in children referred for psychoeducational assessment. *Canadian Journal of Special Education, 9*, 91-99.
- Krane, E., & Tannock, R. (2001). WISC-III third factor indexes learning problems but not Attention Deficit/ Hyperactivity Disorder. *Journal of Attention Disorders, 5*(2), 69-78.
- Kush, J.C. (1996). Factor structure of the WISC-III for students with learning disabilities. *Journal of Psychoeducational Assessment, 14*, 32-40.

- Kush, J.C., & Watkins, M.W. (1994). *Factor structure of the WISC-III for Mexican-American, learning disabled students* (Report No. TM022083). Pennsylvania: U.S. (ERIC Document Reproduction Service No. ED374154).
- Larrabee, G.J., Kane, R.L., & Schuck, J.R. (1983). Factor analysis of the WAIS and Wechsler Memory Scale: An analysis of the construct validity of the Wechsler Memory Scale. *Journal of Clinical Neuropsychology*, 5(2), 159-168.
- Little, S.G. (1992). The WISC-III: Everything old is new again. *School Psychology Quarterly*, 7, 136-142.
- Logerquist-Hansen, S., & Barona, A. (1994). *Factor structure of the Wechsler Intelligence Scale for Children – III for Hispanic and non-Hispanic White children with learning disabilities*. Paper presented at the annual convention of the American Psychological Association, Los Angeles, CA. (ERIC Document Reproduction Service No. ED379880).
- Lowman, M.G., Schwanz, K.A., & Kamphaus, R.W. (1996). WISC-III third factor: Critical measurement issues. *Canadian Journal of School Psychology*, 12(1), 15-22.
- Lufi, D., & Cohen, A. (1985). Using the WISC-R to identify attentional deficit disorder. *Psychology in the Schools*, 22, 40-42.
- Lufi, D., Cohen, A., & Parish-Plass, J. (1990). Identifying attention deficit hyperactivity disorder with the WISC-R and the Stroop Color and Word Test. *Psychology in the Schools*, 27, 28-33.
- Maller, S.J., Konold, T.R., & Glutting, J.J. (1998). WISC-III factor invariance across

- samples of children exhibiting appropriate and inappropriate test-session behaviors. *Educational and Psychological Measurement*, 58(3), 467-74.
- Marsh, H.W., Balla, J.R., & McDonald, R.P. (1988). Goodness-of-fit indexes in confirmatory factor analysis: The effect of sample size. *Psychological Bulletin*, 103(3), 391-410.
- Metz, C.E. (1978). Basic principles of ROC analysis. *Seminars in Nuclear Medicine*, 8, 283-298.
- Millis, S.R., Malina, A.C., Bowers, D.A., & Ricker, J.H. (1999). Confirmatory factor analysis of the Wechsler Memory Scale-III. *Journal of Clinical and Experimental Neuropsychology*, 21, 87-93.
- Napolitano, S.A. (2001). Review of the Children's Memory Scale. In B.S. Plake, & J.C. Impara (Eds.), *The fourteenth mental measurements yearbook* (pp. 255-257). Lincoln, NE: The University of Nebraska Press.
- Nicks, S.D., Leonberger, F.T., Munz, D.C., & Goldfader, P.R. (1992). Factor analysis of the WMS-R and the WAIS. *Archives of Clinical Neuropsychology*, 7, 387-393.
- Otis, A.S., & Lennon, R.T. (1989). *Otis-Lennon School Ability Test – Sixth Edition*. San Antonio, TX: The Psychological Corporation.
- Ownby, R.L., & Matthews, C.G. (1985). On the meaning of the WISC-R Third Factor: Relations to selected neuropsychological measures. *Journal of Consulting and Clinical Psychology*, 53, 531-534.
- Prescott, G.A., Balow, I.H., Hogan, T.P., & Farr, R.C. (1992). *Metropolitan Achievement Test – Seventh Edition*. San Antonio, TX: The Psychological

Corporation.

Price, L.R., Tulskey, D., Millis, S., & Weiss, L. (2002). Redefining the factor structure of the Wechsler Memory Scale-III: Confirmatory factor analysis with cross-validation. *Journal of Clinical and Experimental Neuropsychology*, 24(5), 574-585.

Prifitera, A., Weiss, L.G., & Saklofske, D.H. (1998). The WISC-III in context. In A.Prifitera, D. Saklofske (Eds.). *WISC-III Clinical use and interpretation*. (pp. 1-38). San Diego: Academic Press.

The Psychological Corporation. (1992a). *Stanford Achievement Test Series – Eighth Edition*. San Antonio, TX: Author.

The Psychological Corporation. (1992b). *Wechsler Individual Achievement Test*. San Antonio, TX: Author.

Ray, W.J. (1997). *Methods toward a science of behavior and experience (5<sup>th</sup> Ed.)*. Pacific Grove, CA: Brooks/Cole Publishing Co.

Reinecke, M.A., Beebe, D.W., & Stein, M.A. (1999). The third factor of the WISC-III: It's probably not freedom from distractibility. *Journal of the American Academy of Child and Adolescent Psychiatry*, 38(3), 322-340.

Reynolds, C.R., & Ford, L.. (1994). Comparative three-factor solutions of the WISC-III and WISC-R at 11 age levels between 6-1/2 and 16-1/2 years. *Archives of Clinical Neuropsychology*, 9(6), 553-570.

Riccio, C.A., Cohen, M.J., Hall, J., & Ross, C.M. (1997). The third and fourth factors of the WISC-III: What they don't measure. *Journal of Psychoeducational*

*Assessment*, 15, 27-39.

Rispens, J., Swaab, H., van den Oord, E.J.C.G., Cohen-Kettenis, P., van England, H., & van Yperen, T. (1997). WISC profiles in child psychiatric diagnosis: Sense or nonsense? *Journal of the American Academy of Child and Adolescent Psychiatry*, 36(11), 1587-1594.

Roid, G.H., Prifitera, A., & Weiss, L.G. (1993). Replication of the WISC-III factor structure in an independent sample [Special issue, Monograph, WISC-III series]. *Journal of Psychoeducational Assessment*, 11, 6-21.

Roid, G.H., & Worrall, W. (1997). Replication of the Wechsler Intelligence Scale for Children-Third Edition four-factor model in the Canadian normative sample. *Psychological Assessment*, 9(4), 512-515.

Rosenthal, E.N., Siekierski, B.M., & Riccio, C.A. (2003, October). *Use of the Attention/ Concentration index of the CMS in the diagnosis of ADHD*. Poster presented at the annual meeting of the National Academy of Neuropsychology, Dallas, TX.

Samson, S.A. (2000). *Exploring options for data analysis: Using multivariate statistics to analyze hyperspectral data*. Retrieved November 11, 2003, from <http://www.geospatial.msstate.edu/publications/multihyperspectral.pdf>

Sattler, J.M. (1992). *Assessment of children*. San Diego, CA: Author.

Schwean, V.L., Saklofske, D.H., Yackulic, R.A., & Quinn, D. (1993). WISC-III performance of ADHD children. *Journal of Psychoeducational Assessment*, 11, 56-70.



- Sheslow, D., & Adams, W. (1990). *Wide Range Assessment of Memory and Learning*.  
Wilmington, DE: Jastak Associates.
- Siekierski, B.M., Jarratt, K.P., Rosenthal, E.N., & Riccio, C.A. (2003, August). *WISC-III Freedom from Distractibility Index and measures of attention in children*. Poster presented at the annual meeting of the American Psychological Association, Toronto, Ontario, Canada.
- Slate, J.R. & Jones, C.H. (1997). Gender differences and factor structure of WISC-III scores for students with mild mental retardation. *Diagnostique, 23*(2), 61-75.
- Stapleton, C.D. (1997, January). *Basic concepts and procedures of confirmatory factor analysis*. Paper presented at the annual meeting of the Southwest Educational Research Association, Austin, TX.
- Steiger, J.H. (1990). Structural model evaluation and modification: An interval estimation approach. *Multivariate Behavioral Research, 25* (2), 173-180.
- Stein, M.B. (2001). Review of the Children's Memory Scale. In B.S. Plake, & J.C. Impara (Eds.), *The fourteenth mental measurements yearbook* (pp. 257-259). Lincoln, NE: The University of Nebraska Press.
- Stevens, J., Quittner, A.L., Zuckerman, J.B., & Moore, S. (2002). Behavioral inhibition, self-regulation of motivation, and working memory in children with attention deficit hyperactivity disorder. *Developmental Neuropsychology, 21*(2), 117-139.
- Stewart, K.J., & Moely, B.E. (1983). The WISC-R third factor: What does it mean? *Journal of Consulting and Clinical Psychology, 51*, 940-941.
- Sullivan, P.M., & Montoya, L.A. (1997). Factor analysis of the WISC-III with deaf and

- hard-of-hearing children. *Psychological Assessment*, 9(3), 317-321.
- Süß, H.M., Oberauer, K., Wittmann, W.W., Wilhelm, O., & Schulze, R. (2002). Working memory capacity explains reasoning ability – and a little bit more. *Intelligence*, 30, 261-288.
- Taylor, M.J., & Heaton, R.K. (2001). Sensitivity and specificity of WAIS-III/WMS-III demographically corrected factor scores in neuropsychological assessment. *Journal of the International Neuropsychological Society*, 7, 867-874.
- Tucker, L.R., & Lewis, C. (1973). A reliability coefficient for maximum likelihood factor analysis. *Psychometrika*, 38(1), 1-10.
- Tulsky, D.S., Ivnik, R.J., Price, L.R., & Wilkins, C. (2003). Assessment of cognitive functioning with the WAIS-III and WMS-III: Development of a 6-factor model. In D.S. Tulsky, D.H. Saklofske, G.J. Chelune, R.K. Heaton, R.J. Ivnik, R. Bornstein, et al. (Eds.), *Clinical interpretation of the WAIS-III and WMS-III* (pp. 147-179). San Diego, CA: Academic Press.
- Tulsky, D.S., & Price, L.R. (2003). The joint WAIS-III and WMS-III factor structure: Development and cross-validation of a six-factor model of cognitive functioning. *Psychological Assessment*, 15(2), 149-162.
- Tupa, D.J., Wright, M.O., & Fristad, M.A. (1997). Confirmatory factor analysis of the WISC-III with child psychiatric inpatients. *Psychological Assessment*, 9(3), 302-306.
- van den Broek, A., Sellers, A., Golden, C.J., Burns, W.J., & Drabman, R. (2001, October). *The multidimensional relationship of the WISC-III and WRAML*. Poster

presented at the annual meeting of the National Academy of Neuropsychology, San Francisco, CA.

- Vaupel, C.A. (2001). Children's Memory Scale. *Journal of Psychoeducational Assessment, 19*(4), 392-400.
- Watkins, M.W. & Canivez, G.L. (2001). Longitudinal factor structure of the WISC-III among students with disabilities. *Psychology in the Schools, 38*(4), 291-298.
- Watkins, M.W., Greenwalt, C.G., & Marcell, C.M. (2002). Factor structure of the Wechsler Intelligence Scale for Children- Third Edition among gifted students. *Educational and Psychological Measurement, 62*(1), 164-172.
- Watkins, M.W., & Kush, J.C. (2002). Confirmatory factor analysis of the WISC-III for students with learning disabilities. *Journal of Psychoeducational Assessment, 20*, 4-19.
- Wechsler, D. (1989). *Wechsler Preschool and Primary Scale of Intelligence – Revised*. San Antonio, TX: The Psychological Corporation.
- Wechsler, D. (1991). *Manual for the Wechsler Intelligence Scale for Children – Third Edition*. San Antonio, TX: The Psychological Corporation.
- Wechsler, D. (1997a). *Wechsler Adult Intelligence Scale – Third Edition*. San Antonio, TX: The Psychological Corporation.
- Wechsler, D. (1997b). *Wechsler Memory Scale – Third Edition*. San Antonio, TX: The Psychological Corporation.
- West, J., Houghton, S., Douglas, G., & Whiting, K. (2002). Response inhibition, memory, and attention in boys with attention-deficit/ hyperactivity disorder.

*Educational Psychology*, 22(5), 533-551.

Wielkiewicz, R.M. (1990). Interpreting low scores on the WISC-R third factor: It's more than distractibility. *Psychological Assessment*, 2(1), 91-97.

Wielkiewicz, R.M., & Palmer, C.M. (1996, June). Can the WISC-R/WISC-III Third Factor help in understanding ADHD? *The ADHD Report*, 4(3), 4-6.

Winland, A. (2000). *Children's Memory Scale discriminate with LD and non-LD children*. Unpublished doctoral dissertation, Marshall University.

Zelman, S.A. (1982). Behavior correlates to the WISC-R distractibility factor. *Dissertation Abstracts International*, 43, 3383A.

## VITA

Becky Mayes Siekierski

16511 Soaring Forest Drive

Clear Lake, TX 77059

## EDUCATION

Doctor of Philosophy – School Psychology

Texas A&M University, August 2005

Master of Arts – School Psychology

University of Houston-Clear Lake, May 2001

Bachelor of Science – Psychology

Texas A&M University, May 1998

## PREDOCTORAL INTERNSHIP

Oklahoma Heath Consortium

Major Rotation: Oklahoma City Public Schools

Minor Rotations: Cleveland County Health Department Child

Guidance Clinics – Moore, OK and Norman, OK

## LICENSURE AND CERTIFICATION

Nationally Certified School Psychologist (NCSP)

Oklahoma Certified School Psychologist

Texas Licensed Specialist in School Psychology (LSSP)