

H.M.S. *PALLAS*: HISTORICAL RECONSTRUCTION OF AN 18<sup>th</sup>-CENTURY  
ROYAL NAVY FRIGATE

A Thesis

by

PETER ERIK FLYNN

Submitted to the Office of Graduate Studies of  
Texas A&M University  
in partial fulfillment of the requirements for the degree of

MASTER OF ARTS

May 2006

Major Subject: Anthropology

H.M.S. *PALLAS*: HISTORICAL RECONSTRUCTION OF AN 18<sup>th</sup>-CENTURY  
ROYAL NAVY FRIGATE

A Thesis

by

PETER ERIK FLYNN

Submitted to the Office of Graduate Studies of  
Texas A&M University  
in partial fulfillment of the requirements for the degree of

MASTER OF ARTS

Approved by:

Chair of Committee,	Kevin J. Crisman
Committee Members,	James C. Bradford Felipe Vieira de Castro
Head of Department,	David L. Carlson

May 2006

Major Subject: Anthropology

## ABSTRACT

HMS *Pallas*: Historical Reconstruction of an 18<sup>th</sup>-Century Royal Navy Frigate.

(May 2006)

Peter Erik Flynn, B.A., University of Manitoba

Chair of Advisory Committee: Dr. Kevin J. Crisman

A 1998 joint survey undertaken by the Institute of Nautical Archaeology and Portuguese authorities located and identified the sunken remains of the Royal Navy frigate HMS *Pallas* (1757-1783) off of the Azorean island of São Jorge. Physical remains are so limited as to suggest that excavation would likely yield little new information. However, much documentary evidence has been preserved in Admiralty archives.

Contemporary treatises about 18th-century British ship construction focus on glossaries of terms, scantling lists and design theory, and include only short sections on frigates insofar as they apply to those topics. They rarely address specific construction aspects. Most current works address individual aspects of ship construction for the period, but provide little significant detail about the frigate as a ship type. All of these works are useful and reliable, however none attempt to combine the ship with the crew, or pursue the complete history of one ship.

As the flagship of a prototypical class, intended to address French superiority in cruiser design, it is reasonable to expect that a history of *Pallas* would exist with some analysis of how successfully these new frigates fulfilled the Royal Navy's perceived need. However, to date there has been no attempt to consolidate the evidence of her 26-year career. This study provides a comprehensive history of a single ship from perceived need and conceived solution through design and construction. The ship's logbooks and additional primary sources made it possible to

accurately document and analyze *Pallas*' activities, maintenance, modifications, and ultimately to draw conclusions about the overall effectiveness of the frigate type.

I began with basic background information to establish the perceived need for a new frigate type, followed by an examination of the conceived design solution. A partial set of admiralty drafts served as a foundation from which to develop a more complete set of construction plans, a spar plan, and rigging plans. Comprehensive research into life aboard Royal Navy warships of the period provided a social context within which to examine the service history of *Pallas*. Finally, a review of the maintenance record and the events leading up to her sinking enabled an informed assessment of how well HMS *Pallas* fulfilled the perceived need for which she was developed.

For Sam

## ACKNOWLEDGEMENTS

I gratefully acknowledge the support of my committee chair, Dr. Kevin J. Crisman for his encouragement and financial assistance, and Drs. James Bradford and Felipe Vieira de Castro for serving on my thesis committee. I would like to express my gratitude for the additional funding provided by the Institute of Nautical Archaeology. I would also like to thank the research staff and librarians of the Public Record Office in London and the librarians at the National Maritime Museum, Greenwich. Finally, I wish to express my thanks and appreciation to the Nautical Archaeology Program faculty and staff.

## TABLE OF CONTENTS

	Page
ABSTRACT .....	iii
DEDICATION .....	v
ACKNOWLEDGEMENTS .....	vi
TABLE OF CONTENTS .....	vii
LIST OF FIGURES .....	x
LIST OF MAPS .....	xiii
LIST OF TABLES .....	xvi
CHAPTER	
I    INTRODUCTION.....	1
II   HISTORICAL OVERVIEW.....	4
Geo-Political Context: Emergence of the Royal Navy in the 17 <sup>th</sup> Century .....	4
The Royal Navy as a Tool of Empire.....	6
III  DEVELOPMENT OF THE 18 <sup>th</sup> -CENTURY FRIGATE FORM .....	10
British Cruiser Development.....	11
The Establishments.....	14
French Influence on Royal Navy Cruiser Development .....	15
Establishment Reforms.....	17
The Slade Era .....	18
The True Frigate Form .....	19
IV  CONSTRUCTION .....	21
Hull Construction .....	24
A. Keel Assembly .....	24
B. Stem Assembly .....	26
C. Sternpost Assembly .....	27
D. Deadwood.....	30
E. Frames .....	31
F. Keelson .....	35
G. Internal Planking .....	36
H. Deck Beams, Knees, Carlings, Ledges and Hooks.....	41

CHAPTER	Page
I. External Planking .....	46
J. Bitts, Partners, Capstans and Mast Steps.....	49
K. Decking .....	53
L. Hatches, Gratings, Ladder Ways and Scuttles.....	56
M. Pillars or Stanchions .....	57
N. Quarter Galleries .....	58
O. Rudder and Tiller Assembly.....	59
P. Head.....	61
Finishing and Fittings.....	63
A. Bulkheads .....	63
B. Magazine .....	65
C. Shot Lockers.....	66
D. Ordnance .....	67
E. Pumps .....	69
F. Ground Tackle.....	71
G. Navigation and Communication.....	71
H. Galley .....	73
I. Other Permanent Fixtures.....	73
J. Ballast.....	74
K. Ships' Boats.....	75
L. Hull Protection .....	77
Spar Plan and Rigging Plan.....	78
A. Masts and Spars.....	79
B. Standing Rigging.....	81
C. Running Rigging .....	83
V    LIFE ABOARD AN 18 <sup>TH</sup> -CENTURY ROYAL NAVY FRIGATE .....	93
Entering the Service .....	93
Shipboard Hierarchy, Duties and Responsibilities .....	94
Pay and Benefits.....	101
Discipline and Punishment.....	102
Accommodations.....	103
Food.....	105
Dress.....	106
Health and Hygiene .....	108
Leisure.....	110
VI    HMS <i>PALLAS</i> : SERVICE HISTORY.....	113
VII   ARCHAEOLOGY OF <i>PALLAS</i> SITE .....	135
VIII  CONCLUSIONS .....	138
REFERENCES .....	141



	Page
APPENDIX A: FIGURES.....	149
APPENDIX B: MAPS .....	185
APPENDIX C: HMS <i>PALLAS</i> HISTORICAL TIMELINE.....	190
VITA.....	215

## LIST OF FIGURES

FIGURE		Page
1	Frigate believed to be <i>Pallas</i> . Painted by Charles Brooking, 1759 .....	149
2	Frigate entering Portsmouth. Painted by Thomas Mitchell, 1780 .....	149
3	Ship's lines for frigate HMS <i>Pallas</i> .....	150
4	Keel and keelson assembly detail .....	151
5	Interior profile for frigate HMS <i>Pallas</i> .....	152
6	Various types of scarfs used in construction of <i>Pallas</i> .....	153
7	Detail of stem assembly .....	154
8	Bow construction detail of frigate <i>Pandora</i> .....	154
9	Stern construction detail of frigate <i>Pandora</i> . .....	155
10	Stem boxing detail .....	155
11	Interior construction detail for frigate HMS <i>Pallas</i> .....	156
12	Frame assembly detail .....	157
13	Hawse pieces detail .....	157
14	Midship section detail frigate HMS <i>Pallas</i> .....	158
15	Spirkettling and quickwork detail .....	159
16	Gun deck construction detail for frigate HMS <i>Pallas</i> .....	160
17	Lower deck construction detail for frigate HMS <i>Pallas</i> .....	161
18	Fore and aft orlop construction detail for frigate HMS <i>Pallas</i> .....	162
19	Quarterdeck and forecastle construction detail for frigate HMS <i>Pallas</i> .....	163
20	Detail of capstan .....	164
21	Wheel and tiller detail .....	165

FIGURE	Page
22	Contemporary engraving of gun founding process ..... 166
23	Gun carriage ..... 167
24	Detail of gun tackle and operation from the late 18 <sup>th</sup> century ..... 167
25	Mid 18 <sup>th</sup> -century chain-pump detail ..... 168
26	Overhead view of chain-pump ..... 168
27	Contemporary engraving of anchor making process..... 169
28	Iron stove from HMS <i>Dorsetshire</i> , ..... 170
29	Copper sheathing on hull of <i>Pandora</i> ..... 171
30	Spar plan for frigate HMS <i>Pallas</i> ..... 172
31	Rigging plan detail for frigate HMS <i>Pallas</i> ..... 173
32	Draft of 1745 Establishment, 44-gun ship showing spar details ..... 174
33	Watercolor of 50-gun ship HMS <i>Lion</i> showing rigging details ..... 174
34	The Isle of Man Action, 1760. Painted by Richard Wright..... 175
35	Two British frigates off the African coast. The one on the left is probably <i>Pallas</i> . Watercolor by Lt. Gabriel Bray..... 175
36	Fishing from the anchor on board <i>Pallas</i> in Senegal Road. Watercolor Lt. Gabriel Bray ..... 176
37	Sail-maker ticketing hammocks on board <i>Pallas</i> . Watercolor by Lt. Gabriel Bray ..... 176
38	Wardroom leisure on board <i>Pallas</i> . Watercolor by Lt. Gabriel Bray..... 176
39	Marines mess on board <i>Pallas</i> . Watercolor by Lt. Gabriel Bray..... 176
40	Lower deck on board <i>Pallas</i> (note pump handle) Watercolor by Lt. Gabriel Bray ..... 176
41	Gun deck onboard <i>Pallas</i> . Watercolor by Lt. Gabriel Bray ..... 177
42	Marine sentinel on board <i>Pallas</i> . Watercolor by Lt. Gabriel Bray..... 177

FIGURE	Page
43	Fishing off a gun onboard <i>Pallas</i> . Watercolor by Lt. Gabriel Bray ..... 177
44	A Homeward-bound West India convoy September 1782 by Robert Dodd, with the merchantman <i>Lady Juliana</i> in the foreground, in the tow of the frigate <i>Pallas</i> . ..... 178
45	Site plan of <i>Pallas</i> Wreck, Calheta harbor, São Jorge, Azores ..... 179
46	One of two concreted 6-pound cannon in situ at the site..... 179
47	Drawings of the 6-pound cannon found at the site ..... 180
48	Concreted cast iron ingots from ballast ..... 180
49	Copper nails and a possible wedge from a forelock bolt found at the site .... 181
50	Copper sheathing found in test trench at the site..... 181
51	Lead sounding weight (CAL/ 00-191) found at the site..... 182
52	Lead sounding weight (CAL/ 00-12) found at the site..... 182
53	Lead musket shot found at the site ..... 183
54	Iron shot found at the site ..... 183
55	Four types of pottery found in test trench at the site ..... 184
56	A variety of copper coins found at the site..... 184

## LIST OF MAPS

MAP		Page
1	The Central Azores and the Island of Sao Jorge in the North Atlantic. ....	185
2	British home waters and western approaches.....	186
3	Theatre of operations: July 1760 – Dec. 1763 and Dec. 1771 – Mar. 1773..	187
4	Theatre of operations: Jan. – Apr. 1775, Dec. 1775 – May 1776 and Mar. – June 1777. ....	188
5	Theatre of operations: May – July 1775, June – Oct. 1776, July – Dec. 1777 and Aug. – Jan. 1783.....	189

## LIST OF TABLES

TABLE		Page
1	Depicting the progression of standardization in Royal Navy Cruisers through the Establishment Period. ....	13
2	Depicting the standard watch schedule aboard Royal Navy Warships. ....	100
3	Showing the list of clothing provided to Royal Navy seaman and boys by the Marine Society.....	107

## CHAPTER I

### INTRODUCTION

On January 26, 1783, a small British convoy of eight military transports sailed out of Halifax harbor bound for England.<sup>1</sup> It was accompanied by the captured French 64-gun man-of-war *Le Caton*, and escorted by the veteran 36-gun frigate HMS *Pallas*.<sup>2</sup> In what had begun nearly eight years earlier as a seemingly minor colonial uprising, Britain found itself isolated and at war, not only with the fledgling United States, but with France, Spain and Holland as well. The war in America was lost but not officially over and privateers continued to prowl the Atlantic with the hope of snatching up one last rich prize.<sup>3</sup> Captain Christopher Parker of *Pallas* had received routine orders to escort the convoy across the North Atlantic to England. First launched in 1757, *Pallas* was long past her prime despite numerous upgrades and refits (Fig. 1 and 2). It is almost certain that this would have been her last voyage had she reached England.<sup>4</sup> *Le Caton* probably sailed with little more than a prize crew—the absolute minimum crewmen required to sail the ship—and would have been little help in defending the convoy. Nevertheless, the profiles of a 64-gun capital ship and a frigate seen from a distance would have been more than enough to deter all but the most daring of privateers.

Numerous leaks appeared in *Pallas*' hull soon after sailing. On January 31<sup>st</sup> a storm scattered the convoy, heavy seas worsened the leaks, and by February 5<sup>th</sup>, despite round the clock pumping by the crew, *Pallas* was shipping six inches (15.2 cm.) of water per hour and eight feet (2.44 m.) of water had accumulated in the hold.<sup>5</sup> Guns, shot and heavy stores were thrown overboard to ease the strain and lighten the ship. On the advice of the carpenter and after consulting his officers, Captain Parker decided to make for the nearest port, the city of Horta on

---

This thesis will conform to the style and format of *The American Neptune*.

the island of Fayal in Portugal's Azores Islands (Map 1). They made landfall off Fayal on February 10<sup>th</sup> but were driven back out to sea by another violent storm before *Pallas* could be brought to anchor. The crew was nearing exhaustion when the storm abated on the following morning. But while the sea conditions had changed they had not improved. *Pallas'* crewmen found themselves becalmed and unable to make any significant headway. The second storm had further stressed the hull, and despite the dead calm, the pumps were no longer able to keep up with the rising water in the hold. Driven eastward beyond Fayal by the storm, Parker decided to seek any port of opportunity. On the morning of February 12<sup>th</sup> luck returned long enough to slip the stricken frigate through a gauntlet of surrounding rocks and run her aground near the town of Calheta on the island of São Jorge. Examination of the hull by the ship's carpenter confirmed that the garboard strake and the rabbet of the keel were so worm eaten as to be almost non-existent.<sup>6</sup> The fortnight from February 12<sup>th</sup> to the 24<sup>th</sup> was spent removing what provisions, stores and fittings could be salvaged and on February 24<sup>th</sup> the hulk of HMS *Pallas* was burnt by her crew.<sup>7</sup>

This study began with an archaeological examination of the scant remains of HMS *Pallas*. The subsequent review of existing primary sources pertaining to her construction and service history—most of which are preserved in the Public Record Office and The National Maritime Museum in London—has contributed significantly to our understanding of the frigate type and its application by the Royal Navy. Furthermore, this study has conclusively established *Pallas'* role as a prototype for all subsequent Royal Navy frigate designs and as a developmental test bed for numerous innovations introduced to Royal Navy warships during the late 18<sup>th</sup> century. Finally, a brief overview of the conditions and organization aboard Royal Navy warships will give substance and personality to a period of the Royal Navy's history which is often neglected in favor of the more glamorous Napoleonic era.



## Notes

<sup>1</sup> The Royal Navy did not officially apply the prefix HMS to its warships until the 1790's however for the purpose of clarity HMS will be applied on the first occasion each Royal Navy warship is named.

<sup>2</sup> The 64-gun *Le Caton* was a prize taken at the Battle of the Saintes the previous April.

<sup>3</sup> Miller, *Sea of Glory*, 520. Britain officially proclaimed an end to hostilities with the United States on February 4, 1783. The 64-gun *Le Caton* was a prize taken at the Battle of the Saintes the previous April.

<sup>4</sup> TNA: PRO ADM 1/5322. The carpenter's testimony at Captain Parker's court martial makes it clear that the *Pallas* was too weak to be 'heaved down' for maintenance while at Halifax.

<sup>5</sup> Ibid., Unfortunately, the ship's logs for the last six months of *Pallas*' career have gone missing. However, the official transcript of Captain Parker's court martial for losing *Pallas* do provide a good description of the final voyage.

<sup>6</sup> Ibid., Again, the carpenter's testimony at Captain Parker's courts martial made it clear that *Pallas* had been found too weak to careen at Halifax prior to her final voyage.

<sup>7</sup> Ibid., Captain Parker's letter to the Admiralty reporting the loss of *Pallas*.

## CHAPTER II

### HISTORICAL OVERVIEW

#### Geo-Political Context: Emergence of the Royal Navy in the 17<sup>th</sup> Century

The role of England in Europe's social, political and economic development can be largely attributed to its geographic location. Traditionally England has relied upon its position—an island nation separated from the European mainland—for a defensive advantage. The English Channel has provided the inhabitants of the British Isles with a natural barrier against all but the most determined invaders. As economic conditions improved throughout western Europe during the 15<sup>th</sup>, 16<sup>th</sup> and 17<sup>th</sup> centuries, English channel ports increasingly exploited their position as natural trade centers and trans-shipping points for goods passing between the Mediterranean, France and the newly developing markets in the Lowlands and the Baltic. Furthermore, England was ideally situated to control the passage of shipping through the narrow Channel and consequently in a position to exert considerable political and economic influence upon continental Europe.<sup>1</sup> It was during this period that England first embraced naval supremacy both for defense and as a tool of foreign policy.

The period from 1650-1815 was one of intense imperial rivalry between the western European powers. Economic and colonial disputes, dynastic conflict, and revolution all contributed to an era of almost continuous tension and conflict which stimulated military and naval development, and led to unprecedented shipbuilding programs.

Although Spain was the dominant power at the beginning of the 17<sup>th</sup> century, the second half of the century witnessed the precipitous decline of Spanish influence; its navy fell into a state of complacent decay, and its ability to project political influence was consequently diminished.<sup>2</sup> As Spanish fortunes waned, those of Holland expanded to fill the growing void.

Dutch commercial and colonial success increasingly attracted the jealous attention of both France and England.<sup>3</sup> Holland's economic strength derived primarily from commercial shipping (by mid-century the majority of European goods were shipped in Dutch bottoms) and from its dominance of far-east trade. However, independence from Spain in 1648 left Holland exposed to predations by both France and England. Crippling trade restrictions and high-handed treatment of Dutch shipping by the English in the North Sea and the Channel (culminating in the Navigation Act of 1651) led to open defiance by the Dutch. The three Anglo-Dutch wars during the third quarter of the 17<sup>th</sup> century (First Anglo-Dutch War, 1652 to 1654; Second Anglo-Dutch War, 1664 to 1667; Third Anglo-Dutch War, 1672 to 1674), although militarily largely inconclusive, essentially broke the Dutch monopolies on commercial shipping and far-eastern trade. With the Dutch colonial empire effectively dismantled, England's only remaining serious rival was France.

The second half of the 17<sup>th</sup> century had also witnessed the emergence of French sea power. However, the continental ambitions of Louis XIV often meant that the needs of the army superceded those of the navy. Consequently the French Navy rarely had the money to maintain more than a portion of its fleet and generally elected to pursue a naval policy of regional superiority and commerce raiding.<sup>4</sup>

The naval battles of the Anglo-Dutch wars were typically fought within sight of land; crews and vessels rarely remained at sea for more than a few days. The Royal Navy's primary function remained the protection of the British Isles against foreign aggression. However England's growing colonial interests compelled the navy to accept much broader responsibilities. It was increasingly called upon to defend overseas colonies, to enforce imperial regulations, and, most importantly, to protect merchant shipping throughout the growing empire from the predation of trading rivals, political enemies and pirates. By the beginning of the 18<sup>th</sup> century the

Royal Navy's influence had expanded into the Mediterranean. England played an active role in the War of Spanish Succession 1702-1713 and it was there that the Royal Navy was first employed as a strategic weapon, raiding shore installations and supporting the army's campaigns on the European mainland. England also gained a permanent strategic position in the Mediterranean by seizing the vital ports of Gibraltar and Port Mahon and in doing so gained control of maritime traffic between the Mediterranean and the Atlantic.<sup>5</sup> The War of Jenkins Ear and the War of Austrian Succession in 1739-1748 required that the Royal Navy operate for extended periods in the Caribbean. The Seven Years' War 1756-1763, which ranged from Canada to India was the world's first truly global conflict and Britain's ultimate victory established Royal Navy supremacy for years to come.<sup>6</sup>

#### The Royal Navy as a Tool of Empire

It was from the Anglo-Dutch wars that the Royal Navy truly emerged as a cohesive, homogenous entity capable of projecting global influence. This period witnessed the development of formalized tactics, standardized ship design, a recognizable strategic doctrine, and the foundations of a permanent naval administration.

Shipbuilding technology had progressed considerably during the previous centuries, but naval tactics had not. Prior to the 16<sup>th</sup> century naval battles were little more than infantry battles at sea with ships being employed to carry infantry into combat. Purpose-built state-owned warships were rare; in time of war, merchant vessels were conscripted or hired by the state and hastily refitted for military service.<sup>7</sup> Fleet formations typically entered battle in line abreast or echelon formations, but once engaged battles degenerated into clusters of individual duels with ships seeking out opponents of comparable size, or several smaller ships engaging a single larger one. Long range weapons such as catapults, and later cannon, were employed only until the

opposing vessel could be grappled and boarded. Early cannon were primarily used to destroy rigging, clear enemy decks of defenders prior to boarding.<sup>8</sup> Ship design of the period reflected this form of warfare. High fore and aft castles were incorporated to gain both a height advantage and provided a secure keep from which to engage enemy boarders.

It was not until the introduction of the smaller, more agile, English race-built galleons of the late 16<sup>th</sup> century that ships began to be viewed as pure gun platforms. The success of these types against the much larger ships of the Spanish Armada in 1588 clearly demonstrated the superiority of heavily armed warships that were capable of battering enemy ships into submission from a distance.<sup>9</sup>

During the 1630's Charles I established England's first permanent navy. By levying 'ship-money,' from the counties he was able to build, and maintain a small purpose-built fleet of warships year round. This also enabled the development of a professional cadre of officers and sailors. Furthermore, this marked the beginning of English naval influence upon the balance of power in Western Europe.<sup>10</sup> England's Parliamentary government of the 1650's expanded upon Charles' naval program, increasing naval spending and initiating substantial new shipbuilding projects. Permanent dockyards and logistical facilities had been established by 1600, but it was the Commonwealth government after 1649 that was largely responsible for establishing the foundations of the navy's permanent professional administrative machinery, command structure, and extensive shore facilities that would eventually support English naval operations on a global scale.<sup>11</sup>

Improvements in guns and gunnery throughout the 17<sup>th</sup> century facilitated a fundamental change in naval doctrine. Tactical requirements shifted from crew capacity and defense to maneuverability and gun-power. The high defensive works were cut down or completely removed, and a large portion of the personnel was re-allocated as gun crews. Predictably during

this period warships grew in size and tonnage as more and larger guns were introduced; the largest carrying up to 100 guns on three gun decks.<sup>12</sup>

Almost exclusively naval conflicts, the Anglo-Dutch wars were the setting for some of the largest fleet engagements in history and resulted in fundamental changes in naval tactics and, consequently, ship design. In 1653, following the first Anglo-Dutch War, English Admiral Robert Blake introduced his *Fighting Instructions* in an attempt to impose order upon the disorganized melees that had, up until then, characterized naval warfare. In this milestone of naval doctrine he outlined the use of a rigid line-of-battle that revolutionized naval tactics and ultimately ship design. He proposed that ships enter battle in line-ahead formation so as to minimize exposure of the vulnerable bow and stern, and to maximize the broadside firepower of all of the ships in the formation. Only as strong as its weakest link, a line-ahead formation increased the interdependency of the ships within the formation, thereby dictating the need for greater homogeneity of construction. Vessels exhibiting similar sailing qualities were better able to maintain station within the formation and thus not compromise the integrity of the unit as a whole.<sup>13</sup>

As a direct result of Blake's innovations, in 1706, the Royal Navy instituted the first Establishment system in an attempt to standardize warship construction. A system of ship ratings was introduced based on tonnage and number of guns carried. For each rating the Establishment defined a list of scantlings or basic dimensions to be observed by shipwrights. The line of battle was made up of first-, second- and third-rate ships of between 70 and 100 guns. Cruisers and small two-decked ships—fourth to sixth-rates—were no longer deemed suitable to stand in the line-of-battle and were assigned duties for which they were better suited.<sup>14</sup>

Finally, this period witnessed the emergence of a recognizable and consistent strategic doctrine. Buttressing its continental allies with subsidies allowed England to sap the military

resources of its enemies. With little need for a land army England was able to consolidate naval superiority. A policy emerged of blockading enemy fleets within their ports, attacking maritime commerce, and seizing undefended colonial possessions abroad.<sup>15</sup>

In little more than 100 years, naval warfare evolved from disorganized regional scuffles fought by part-time navies, to a means of projecting economic and political policy around the globe. This change in the use of naval power demanded a new kind of warship. While the battle fleet remained the core of the Navy, emphasis had shifted. The new requirement was for a cruiser capable of operating independently; capacious, rugged and weatherly enough to remain at sea for long periods; a ship more economical to build and operate than a ship-of-the-line yet powerful enough protect itself and project authority.

### Notes

<sup>1</sup> McKee, "Influence of British Naval Strategy", 226.

<sup>2</sup> Mahan, *Influence of Sea Power*, 94.

<sup>3</sup> *Ibid.*, 97-8.

<sup>4</sup> *Ibid.*, 93-5.

<sup>5</sup> *Ibid.*, 219-20.

<sup>6</sup> Howarth *Sovereign of the Seas*, 208-9.

<sup>7</sup> Notable 16<sup>th</sup> and 17<sup>th</sup>-century exceptions include the ships *Grace Dieu*, *Mary Rose*, *Sovereign of the Seas*, and *Vasa*.

<sup>8</sup> Perrin, *Boeteler's Dialogues*, 296-8

<sup>9</sup> McKee, "Influence of British Naval Strategy", 227-32.

<sup>10</sup> Wheeler, *Making of a World Power*, 35-7.

<sup>11</sup> *ibid.*, 38-46.

<sup>12</sup> Wheeler, *Making of a World Power*, 36, and Lavery, *Ship of the Line* vol. 1, 22-3.

<sup>13</sup> McKee, "Influence of British Naval Strategy", 234, Wheeler, *Making of a World Power*, 48, Tunstall, *Naval Warfare*, 17-21, and Lavery, *Ship of the Line* vol. 1, 22-27.

<sup>14</sup> McKee, "Influence of British Naval Strategy", 234 and Gardiner, *Line of Battle*, 17.

<sup>15</sup> Mahan, *Mahan on Naval Warfare*, 142-43.

### CHAPTER III

#### DEVELOPMENT OF THE 18<sup>TH</sup>-CENTURY FRIGATE FORM

The origin of the 18<sup>th</sup> century frigate is a broad, subjective and, at times, contentious topic. The most common arguments focus on two questions: what constitutes a ‘true frigate,’ and where did the concept originate? Because the primary focus of this study is a particular frigate, HMS *Pallas*, the evolution of the frigate as a ship type will be examined only to the extent necessary to establish a clear historical and developmental lineage.

To most, the word ‘frigate’ conjures images of great battles between massive wooden warships, yardarm to yardarm, blazing away with row upon row of cannon. The term is often given incorrectly to describe any large wooden warship from the period 1650-1850. It is imperative to correct this misnomer. The origins of the word can be found in the Greek *aphraktos* and later in the Latin form *fragata*. The term frigate to identify a type or class of ship has been used by mariners and navies alike for thousands of years. For most of this period the term was used in general way to identify a small vessel, long and slender, propelled by one or more banks of oars.<sup>1</sup> Unlike larger galleys, they were not suited for warfare and served primarily as light, fast dispatch vessels. Not until the 17<sup>th</sup> century is a noticeable change evident in the form and use of the ‘frigate’ type. Early in that century shipwrights at the French port of Dunkirk began to build a small warship that combined the agility of the oared galley with the deep round hull and broadside firepower of the northern European fighting ship.<sup>2</sup>

In his treatise on French frigates, Jean Boudriot has compiled a list of dictionary definitions for the term ‘frigate’ from the period 1643-1847. Although they differ greatly and evolved as time passed, they include these qualities and characteristics in common: a small,



lightly framed warship, ship-rigged, designed to be propelled by either sail or sweeps, built long and low in the water so as to be a fast and agile sailor, and usually armed on a single deck.<sup>3</sup>

For the first century of this period, frigates were not viewed as ‘cruisers.’ They typically worked close to shore performing dispatch or scouting duties. They were maneuverable under sail, and the addition of sweeps enabled them to work against light currents in the mouths of rivers and up estuaries, and the ability to bring broadside guns to bear without the use of a spring.<sup>4</sup> Britain’s acquisition of a global colonial empire imposed greater demands on the Royal Navy, increasing the need for an effective yet economical vessel to help administer and police overseas possessions exert naval influence, act as advanced scout and pass signals for the battle fleet, carry dispatches, gather intelligence, interdict enemy maritime commerce, perform escort duty and suppress piracy and privateers. Such duties called for a swift warship, small yet powerful, capable of operating independently and remaining at sea for long periods.<sup>5</sup>

#### British Cruiser Development

At the beginning of the 18<sup>th</sup> century the Royal Navy employed a vast variety of 5<sup>th</sup> and 6<sup>th</sup>-rate ships differing widely in design, layout and armament. It continued to rely upon small two-deckers, single-deck 6<sup>th</sup>-rates and assorted smaller vessels to protect commerce. Small, one and a half decked 5<sup>th</sup>-rates were not considered to be an acceptable solution and were discontinued following the 1713 Peace of Utrecht. Subsequently no warship types existed between the two-deck, 40-gun ships and single-deck, 20 and 24-gun ships, usually referred to as sloops-of-war, until the Admiralty began experimenting with captured French types in the middle of the century.<sup>6</sup>

The initial Establishment of 1706-1718 attempted to standardize the dimensions of larger warships and establish some degree of uniformity within the Royal Navy’s line of battle

(Table 1). However, Establishments did not dictate design until after 1745. Shipyard surveyors were restricted in dimension and scantling but they were free to alter ships' lines and styling as long as the finished product was within the Establishment parameters. Furthermore, proposed designs of smaller ships were subject to far fewer design constraints than those of their larger counterparts.<sup>7</sup> The smallest ships included in the 1706-1718 Establishment were 40-gun, two-decked, 5<sup>th</sup>-rates. These were to be 118 feet (40 m.) long on the lower deck, 32 feet (9.7 m.) in beam, 531 tons, and crewed by 130 to 190 men.<sup>8</sup> There were to be eighteen 9-pound guns on the gun deck, twenty 6-pound guns on the upper deck and four 4-pound guns on the quarterdeck.<sup>9</sup>

Smaller 32-gun 5<sup>th</sup>-rates were not built to an Establishment of dimensions but were beginning to show some degree of uniformity. Ships of this class, built prior to the 1706 Establishment, were an eclectic mix ranging from 102 to 110 feet (31.1 to 33.5 m.) long on the lower deck, 24 to 30 feet (7.3 to 9.1 m.) in beam, 350 to 390 tons, and were crewed by 100 to 145 men. The guns were arranged with four 9-pound guns on the gun deck, twenty to twenty-two 6-pound guns on the upper deck and four to six 4-pound guns on the quarterdeck. Those built after the 1706 Establishment were 108 to 110 feet (32.9 to 33.5 m.) long, 29 feet (8.8 m.) in beam, 416 to 423 tons, and carried 100 to 145 crewmen. The guns were arranged with either four 9-pound or eight 12-pound guns on the gun deck, twenty-two 6-pound guns on the upper deck and six 4-pound guns on the quarterdeck.<sup>10</sup> Like the smaller 5<sup>th</sup>-rates, the 6<sup>th</sup>-rates of the early Establishment period were not built to an Establishment of dimensions but were also beginning to show a tendency towards uniformity. Ships of this class built prior to the 1706 Establishment ranged from 92 to 98 feet (28 to 29.9 m.) long on the gun deck, 24 to 26 feet (7.3 to 7.9 m.) in beam, 240 to 270 tons, and were crewed by 85 to 115 men. The main battery of twenty 6-pound guns was mounted on the single gun deck with an additional four 4-pound guns mounted on the quarterdeck of the 24-gun ships only.<sup>11</sup> Those built after the 1706 Establishment were 94 to 95

feet (28.6 to 28.9 m.) long, 25 to 26 feet (7.6 to 7.9 m.) in beam, 260 to 280 tons, and carried 85 to 115 crewmen. Gun weight and arrangement did not significantly change during this period.<sup>12</sup>

Table1: Depicting the progression of standardization in Royal Navy Cruisers through the Establishment Period. Compiled from Lyon, *Sailing Navy List*, 36-7, 47-52.

	Length	Beam	Burthen (Tons)	Crew*	Guns LD/GD	Guns UD	QD/F C
1706 Establishment 5 <sup>th</sup> -Rate, 40 guns	118'	32'	531	190	18 x 9	20 x 6	4 x 6
1706 Establishment 5 <sup>th</sup> -Rate 32 guns†‡	108-110'	29' 6" - 29' 8"	416 57/94 – 423 62/94	145	4 x 9‡	20 x 6	6 x 4
1706 Establishment 6 <sup>th</sup> -Rate, 20-24 guns†	90' 3 3/4"-95' 10"	25' 0" - 26' 6 1/2 "	253 55/94 – 282 5/94	115	-	20 x 6	0-4 x 6
1719 Establishment 5 <sup>th</sup> -Rate, 40 guns	124'	33' 2"	594 55/94	250	20 x 12	20 x 6	-
1719 Establishment 6 <sup>th</sup> -Rate 20 guns	106'	28' 4"	374 49/94	140	-	20 x 6	-
1733 Establishment 5 <sup>th</sup> -Rate 40-44 guns	124'	35' 8"	678	250	20 x 12	20 x 9	4 x 6
1733 Establishment 6 <sup>th</sup> -Rate 20-guns	106'	30' 6"	442 4/94	150	-	20 x 9	-
1741 Establishment 5 <sup>th</sup> -Rate 44 guns	126'	36'	706 36/94	250	20 x 18	20 x 9	4 x 6
1741 Establishment 6 <sup>th</sup> -Rate 24 guns	112'	32'	498 34/94	160	2 x 9	20 x 9	2 x 3
Notes:							
*Maximum wartime figures given. Crew and guns were considerably reduced during peacetime. Pure galley's and foreign-built prizes omitted. Only British built cruiser types are included.							
†Not built to an Establishment							
‡ <i>Mermaid</i> and <i>Dolphin</i> were built as 36-gun ships armed GD 8 x 12, UD 22 x 6, QD 6 x 4. After 1716 all were re-armed GD 8 x 9, UD 20 x 6, QD 2 x 4. <sup>13</sup>							

### The Establishments

The Treaty of Utrecht in 1713 concluded almost sixty years of continuous war between the major European powers, at the end of which Britain had become the dominant naval power. Although French and Spanish designs were generally accepted as more advanced, the Royal Navy established superiority in construction, management, logistics, and quality of crew.<sup>14</sup> However, the long peace that followed saw a dramatic decline in spending and stagnation in ship development within the Royal Navy. The 1719 Establishment fixed the dimensions of all rated warships down to 20-gun 6<sup>th</sup>-rates, but little effort was made to improve upon pre-existing cruiser designs. All of the guns were mounted on the weather deck and a complete bank of oar ports remained on the lower deck for rowing.<sup>15</sup> Ships continued to be designed by master shipwrights of individual yards who retained some freedom of design as long as they worked within the parameters fixed by the Establishment.<sup>16</sup>

Myopic conservatism among the Navy Board continued to obstruct innovation in ship design and resisted efforts to address existing design deficiencies.<sup>17</sup> The Navy Board was conscious, perhaps overly so, that even small increases in ship size amounted to substantial increases in construction and maintenance costs. Consequently, the 1733 and 1741 Establishments that followed were little more than conservative revisions of the scantlings and dimensions fixed by the 1719 Establishment. These were primarily increases in size and strength to accommodate increased battery size and to compensate for lost performance resulting from added gun weight.<sup>18</sup> Nevertheless, throughout the Establishment period (1719-1745) the fleet gradually attained a greater degree of standardization as older ships were retired, broken up and replaced or rebuilt.<sup>19</sup>

During the Establishment period, ship design and spending were the prerogative of the Navy Board, a permanent bureaucracy of naval officers, that ran the dockyards and was

responsible for ship design, construction, maintenance, victualling and day-to-day operations of the fleet. The Admiralty, a council of temporary, politically appointed members, petitioned parliament for funding and dictated policy but exerted little influence over how the Navy Board administered the Navy.<sup>20</sup> The conservatism of the Royal Navy during this period was largely due to Sir Jacob Ackworth, surveyor of the Navy since 1715, who harbored a firm belief in the superiority of the ships of the late 17<sup>th</sup> century.<sup>21</sup>

The outbreak of war with Spain again in 1739 (The War of Jenkin's Ear) did little to change existing attitudes. Spain was not in a position to effectively pursue a *guerre de course* (war on trade) and the Royal Navy saw no need to invest money and resources improving cruiser designs. However, French entry into the war in 1740 (The War of Austrian Succession) witnessed a dramatic increase in losses of British merchant shipping. The Royal Navy's 20-gun 6<sup>th</sup>-rates found themselves increasingly outclassed not only by their French counterparts but by French privateers as well.<sup>22</sup> Consequently, the Admiralty began to seriously examine French cruiser design.

#### French Influence on Royal Navy Cruiser Development

Early French cruiser designs were either clumsy two-deckers similar to their British equivalents or under-gunned single-deckers with their battery dangerously close to the waterline. Like the British, French naval shipwrights sought to bring together the best qualities of both designs into a successful new cruiser design. Their solution undertaken in the early 1740's, was to move the lower deck down to, or below, the waterline, reduce the headroom on the lower deck to about four feet (1.2 m.), and place all of the battery on the upper deck. This reduced topside profile while retaining sufficient freeboard to run out the main battery in all weather conditions.<sup>23</sup> Blaise Ollivier, son of a master shipwright, gained considerable prestige as an

innovator in ship design throughout the early part of the 18<sup>th</sup> century. He was made Master Shipwright at Brest in 1736 where he distinguished himself as France's preeminent shipwright until his death ten years later. Ollivier's *Medée*, built in 1741, is widely credited as the first genuine frigate but there remains little real evidence that this was in fact the case. Many French privateers of the day exhibited similar design characteristics.<sup>24</sup> *Medée* featured two decks, the upper strengthened to bear the weight of the main battery of twenty-six 8-pound guns, the lower with reduced headroom and no ports was devoted entirely to berthing and storage. Ollivier's reputation within the French Navy promoted eventual acceptance of the type and it was the first such design widely accepted for service in the French Navy. It was not the first French vessel to incorporate these design features, but it became the prototype for a class that eventually numbered 30 or more vessels. Ironically, *Medée* was also the first such vessel captured by the British but for some reason she was not taken into Royal Navy service. It is unclear why the Royal Navy failed to capitalize or, at the very least, carry out a detailed survey of this prize. *Renommée*, a near-sister of *Medée*, was highly regarded and immediately taken into Royal Navy service after she capture in 1747. During the same period Ollivier's contemporary, Jacques-Luc Coulomb undertook the parallel development of a smaller 20-gun version based upon the same design concepts. His *Panthère*, built in 1744, was also taken into Royal Navy service when captured in 1745.<sup>25</sup> While the Royal Navy greatly admired the design and sailing qualities of these prizes, little effort was devoted to reproducing them. A year later, the French 40-gun *Embuscade*, the largest frigate-built prize of her day, was renamed *Ambuscade* and taken into Royal Navy service. The French 8-pound guns were replaced with British 12-pound guns and the heavier broadside seems to have been the decisive factor in British cruiser development. Until this point, the Royal Navy had been unwilling to commit resources to the development of what was perceived to be an under-gunned warship.<sup>26</sup>

### Establishment Reforms

As previously stated, the Navy Board controlled the budget and, because of costs involved, was disinclined to increase ship size or to impose any radical design changes. In 1744, the Admiralty began to become involved in Navy Board business. Admiral George Anson, a sea admiral with considerable influence, was appointed to the Admiralty. He in turn immediately appointed Sir John Norris to investigate a complete revision of the Establishment system. Dockyards were instructed to watch for ships with good sailing characteristics for evaluation and technical analysis, and all surveys of French prizes were to be forwarded by the Navy Board for Admiralty inspection. Eventually all proposed designs had to be authorized by the Admiralty before being forwarded to the Navy Board for construction. In response to increasing demands by its sea-officers, the Admiralty ordered a new, improved Establishment for 1745. What the Navy Board drew up was once again little more than a conservative increase in dimensions of the larger ships of the line. Upon returning from blockading the French coast during the winter of 1747, Anson complained of a lack of quality cruisers. In fact, the upgraded French prize *Ambuscade* had been his best ship. He required an improved all-weather cruiser to institute his new strategy of blockading of French ports year round. Finally, in April 1747, displeased with Navy Board conservatism, and in an unprecedented break with tradition, the Admiralty ordered a draught of the captured 26-gun French privateer *Tygre*. A St. Malo privateer of French frigate design, *Tygre* was not purchased by the Royal Navy due to poor quality construction, but it had exhibited excellent performance and sailing characteristics. The Admiralty ordered two copies built. *Unicorn* and *Lyme* were to be constructed “to the lines of the *Tygre* French privateer.” It is interesting to note that some comparative experimentation is demonstrated by the fact that *Lyme* was designed with a round bow and *Unicorn* with a beakhead bow; one in the French tradition and one in the English tradition.<sup>27</sup>

A second generation of *Tygre*-based vessels, *Lowestoffe* and *Tartar*, followed in 1755, to be constructed “to the draught of the *Lyme* with such alterations as may tend to the better accommodation of men and carrying of guns.”<sup>28</sup> Comparative experimentation is once again evident in that *Tartar* was designed with a round bow and *Lowestoffe* was designed with a beakhead.

The third generation of four vessels was ordered in 1756-7, to be constructed “by the draught of the *Tartar* with such alterations withinboard as shall be judged necessary.”<sup>29</sup> The success of these vessels is demonstrated by the fact that eighteen third generation *Unicorn*-class frigates were eventually built. All were increased to 28 guns with the addition of four 3-pound guns in September 1756 and were further furnished with twelve ½-pound swivel guns in November of that same year.<sup>30</sup> All of the generations up to this point were in some way based upon French designs and all carried main batteries of 9-pound guns.

### The Slade Era

Sir Thomas Slade was born in 1703 or 1704 into a family with a long tradition of shipbuilding. He worked his way up in the profession gaining prestige first as a timber broker, then as Shipwright’s Assistant at Harwich and Woolwich. His talent and connections led to his appointment as the Master Shipwright at Deptford where he was responsible for the design and construction of five ships between 1749 and 1755.<sup>31</sup> In 1755, he and William Bately, the Deputy Surveyor at Plymouth, were appointed joint Surveyors of the Navy to replace the retired Sir Joseph Allen. Slade retained this title until his retirement in 1770, becoming the preeminent Royal Navy ship designer and builder of his day. His *Southampton*-class frigates introduced in 1756 are generally regarded as the first ‘genuine frigates’ designed and built in England. They were based on the same design principles as their French precursors but were completely original



designs. They were considerably larger than the *Unicorn*-class ships and carried a heavier main battery of twenty-six 12-pound guns on their upper deck. The following year, 1757, Slade introduced the *Pallas* class frigates, which were simply enlarged versions of the *Southampton* design. When launched *Pallas*-class frigates were regarded as the best fighting cruisers fielded by any navy of their day.<sup>32</sup>

### The True Frigate Form

It is clear that the first ‘true frigate’ of the Royal Navy was derived from a French design that was ultimately perfected by the British. Whether French or English, the sailing frigate was hereafter defined as a two-decked, square rigged warship with three masts (the traditional ship rig), having the main battery on the upper deck and the secondary battery divided between the quarterdeck and forecastle. It was self sufficient and capable of staying at sea for long periods while carrying out a variety of duties. It was large enough to warrant a rating but generally not large enough to stand in the line of battle.<sup>33</sup>

### Notes

<sup>1</sup> Boudriot, *French Frigates*, 12.

<sup>2</sup> Anderson, “Ancestry”, 158.

<sup>3</sup> Ollivier, *Remarks*, 13-14.

<sup>4</sup> Gardiner, *Line of Battle*, 30 and Falconer, *Universal Dictionary*, 274. Springs were only employed while at anchor. A cable was passed from capstan or winch, through a stern port and forward to the anchor cable allowing the stern of the ship to be pulled towards the anchor.

<sup>5</sup> Henderson, *Frigates*, 3, Price, *Eyes of the Fleet*, 25 and Mckee, “Influence of British Naval Strategy,” 234. It is interesting to note that this new workman-like attitude was paralleled by the reduction and/or elimination of decorative appointments and scrollwork. Royal Navy warships acquired a more utilitarian, functional appearance.

<sup>6</sup> Lyon, *Sailing Navy List*, 33.

<sup>7</sup> *Ibid.*, 39.

<sup>8</sup> Mckee, “Influence of British Naval Strategy,” 234. All warship tonnages given in burthen tons or rough cargo capacity not displacement tonnage.

<sup>9</sup> Lyon, *Sailing Navy List*, 36. Note that warships frequently carried more guns than their rating during wartime and fewer than their rating in peacetime. After 1716 the configuration was changed to twenty 12-pound guns on the gun deck and twenty 6-pound guns on the upper deck with no guns on the quarter deck.

<sup>10</sup> *ibid.*, 26-7, 36. It is interesting to note here that even though dimensions had not yet been established, the standard crew for each ship rating had. No matter how much ship size varied, all small 5th-rate, 32's carried 100 to 145 men, all 6<sup>th</sup>-rate 24's carried 85 to 115 men, etc.

<sup>11</sup> *Ibid.*, 27-9.

<sup>12</sup> *Ibid.*, 36-7.

<sup>13</sup> *Ibid.*, 36.

<sup>14</sup> McKee, "Influence of British Naval Strategy," 234.

<sup>15</sup> Gardiner, *First Frigates*, 7.

<sup>16</sup> *Ibid.*, 8.

<sup>17</sup> Lyon, *Sailing Navy List*, 36.

<sup>18</sup> *Ibid.*, 39.

<sup>19</sup> Lavery, "Rebuilding of British Warships," 113-27. Provides a complete discussion of Royal Navy policy and practice for rebuilding warships 1690-1740.

<sup>20</sup> Baugh (ed.), *Naval Administration*, 1-8, Rodger, *Admiralty*, 53-67 and Gardiner, *First Frigates*, 9.

<sup>21</sup> Lyon, *Sailing Navy List*, 39.

<sup>22</sup> Gardiner, *First Frigates*, 9.

<sup>23</sup> *Ibid.*, 10.

<sup>24</sup> *Ibid.*, 11-12.

<sup>25</sup> *Ibid.*, 10-12.

<sup>26</sup> Gardiner, *First Frigates*, 11. *Ambuscade* became the forerunner to the British 32 and 36-gun cruisers.

<sup>27</sup> Gardiner, "First English Frigates," 164, Gardiner, "Frigate Designs," 51-2, Gardiner, *Line of Battle*, 37 and Gardiner, *First Frigates*, 9-16.

<sup>28</sup> Gardiner, *First Frigates*, 16.

<sup>29</sup> *Ibid.*, 16.

<sup>30</sup> *Ibid.*, 16.

<sup>31</sup> Jones, "Sir Thomas Slade," 224-5. *Weymouth* 3<sup>rd</sup>-rate, *Speedwell* Brig, *Dorset* Bomb, *Squirrel* 6<sup>th</sup>-rate, and *Medway* 3<sup>rd</sup>-rate.

<sup>32</sup> *Ibid.*, 224-6.

<sup>33</sup> In small squadron engagements, several frigates might form up in a line with a single 3<sup>rd</sup> or 4<sup>th</sup>-rate against a comparable force.

## CHAPTER IV

### CONSTRUCTION

A variety of sources are available pertaining to the hull design and construction of 18<sup>th</sup>-century Royal Navy warships. Admiralty drafts, like most Royal Navy records of the period have been preserved in the National Maritime Museum Archive.<sup>1</sup> Given the Royal Navy's focus on standardization during this period it is possible to make certain assumptions regarding the construction of all British warships based on admiralty plans. Nevertheless, identical designs submitted to different shipyards never resulted in identical ships. However, it was expected that all contracted ships would conform to general admiralty standards. While lacking detail and often containing inconsistencies, these plans do serve as a good starting point for a theoretical reconstruction.

Unfortunately, a complete set of *Pallas*' Admiralty plans has not survived. However, an incomplete set of drafts includes Sir Thomas Slade's individual deck and construction plans, and these can be supplemented with the surviving lines for sister ship, *Brilliant* (Fig. 3).<sup>2</sup> These 1/48-scale drafts define the major scantlings and provide the designer's intent regarding structural features, general layout, and use of space. Many of the key timbers of the keel, stem, sternpost, and mast steps are prominently included in these drafts and should be consistent throughout the class. Also, during the first half of the 18<sup>th</sup> century, the Navy Board produced a series of lists giving basic measurements as construction guidelines for each rate of warship. These Establishment lists provide specific dimensions for most major timbers and some iron hardware.<sup>3</sup> The shipwrights building *Pallas* would have been expected to conform to the 1745 Establishment, which gives dimensions for 44-gun two deck ships and 24-gun single deck ships, but does not yet address the new 32 and 36-gun cruisers. Nevertheless, they do provide absolute

dimension parameters and allow for further refinement of the Admiralty drafts. These important sources provide a strong foundation for a graphic reconstruction.

As much as possible the results of archaeological investigations will be applied. However, little remains of *Pallas* herself therefore the majority of archaeological evidence must be extrapolated from the closest parallels investigated to date—principally the remains of the 44-gun ship HMS *Charon* sunk off Yorktown in 1781 and the 24-gun frigate HMS *Pandora* sunk off the Australian coast in 1791.

To build upon this foundation, further details have been gathered from a variety of reliable contemporary sources. The majority of period shipbuilding treatises focus primarily on the increasingly complex mathematical design theories being applied to the derivation of ships' lines. However, at times they do offer clues to actual shipbuilding practices. Fewer sources provide a clear idea of the engineering method, actual construction processes and carpentry techniques of English shipwrights of the period. Fewer still contain significant useful data. Nevertheless, several indispensable works remain and augment the Admiralty drafts and Establishment lists. One such work is Blaise Ollivier's *Remarks on the Navies of the English & the Dutch* (1737). As mentioned previously Ollivier was Master Shipwright for the French naval shipyard at Brest from 1736 until his death in 1746. His credentials are strengthened by the fact that he has been credited with the invention of the frigate.<sup>4</sup> In 1737, he was sent to spy on English and Dutch naval shipbuilding facilities and report his findings. Ollivier's *Remarks* provide a highly informative narrative of English naval shipbuilding practices throughout the country, including most notably those at Deptford where *Pallas* would be laid down less than 20 years later. Another invaluable primary source is the anonymous work *The Shipbuilder's Repository* (1789). It contains comprehensive scantling lists for every class of Royal Navy warship from the period. Although anonymous, it is both authoritative and accurate, and has

been accepted by shipwrights and historians alike since its publication. However, because warships of all classes continued to grow in dimensions throughout the period, the basic scantlings given (length, beam, and tonnage) for a 32-gun ship from 1789 more closely represent those of 36-gun *Pallas* and will be used for the purpose of this reconstruction. Further useful primary sources include William Sutherland's *The Shipwright's Assistant* (1711), David Steel's *The Shipwright's Vade Mecum* (1805), and Mungo Murray's *A Treatise on ship-building and navigation* (1754). All contain valuable procedural construction details unavailable elsewhere. However, both Sutherland and Steel are too far removed chronologically for their specific timber dimensions to be applicable.

Another useful source is found in contemporary ship models. Along with the Admiralty drafts, 1/48-scale models were commonly submitted to the navy board for approval. Many of these models have survived to the present in both Admiralty and private collections. Examination of these models can often provide a great deal of insight into the rigging, fitting, internal layout and structural engineering of English warships for a given period.

One final primary source found to be particularly useful occurs in contemporary artwork. Small details can often be harvested from prints, paintings, watercolors, lithographs, sketches, or even the simplest caricature.

Secondary sources found to be especially useful include: Peter Goodwin's *The Construction and Fitting of the English Man of War 1650-1850*, Brian Lavery's *Arming and Fitting of English Ships of War 1600-1815*, Robert Gardiner's *The First Frigates*, and the graphic reconstructions proposed in John McKay's *The 24-gun Frigate Pandora* and David White's *The Frigate Diana*. These works are, for the most part, based upon analysis of the previously mentioned treatises, artwork and Admiralty models but also provide detailed drawings and descriptions for specific elements during specific timeframes. While primary

sources will be used wherever possible these works provide substantial information regarding the fittings, accessories and finishing detail not otherwise addressed.

### Hull Construction

Until the advent of modular construction in the 20<sup>th</sup> century, the keel assembly was the backbone and principle source of longitudinal strength in wooden ships.<sup>5</sup> Consequently, the integrity and fairness of the entire construction depended upon the laying of the keel being both sound and true. Before the construction of the ship could begin, the master shipwright selected a suitable slipway upon which a platform was erected to support the hull during the building process. First, large pieces of timber called ground-ways were laid down as a base. On top of this, heavy blocks of hard knotty stuff were placed at regular intervals along the length of the proposed keel and capped with splitting blocks that could be easily cleaved away at a later time.<sup>6</sup>

#### A. Keel Assembly

Construction began with the keel sections being placed end-to-end on top of the splitting blocks and scarfed together (Fig. 4).<sup>7</sup> The Slade drafts provide the approximate length, and molded and sided dimensions of the keel assembly for *Pallas* but unfortunately little else (Fig.3 and 5). Gardiner gives the length of her keel as 106 ft. 2-5/8 in. (32.37 m.) as designed and 106 ft. 4 in. (32.41 m.) as completed.<sup>8</sup> The keel was 14 in. (35.6 cm.) square at midship and the sided dimensions tapered to between 9 and 11 in. (22.9-27.9 cm.) at the sternpost.<sup>9</sup> Ollivier concurs, observing that English keels "...diminish greatly its breadth athwart ships towards the stern, starting one third along its length...."<sup>10</sup> Goodwin states that the keel diminished in width towards bow as well.<sup>11</sup> However, the drafts show no indication of the keel diminishing towards either end.<sup>12</sup>

The main keel was composed of five pieces of elm or oak scarfed together and secured with six to eight 1 in. (2.5 cm.) diameter iron bolts driven through in pairs from opposite sides of the keel and clenched over roves.<sup>13</sup> The exact type of scarfs employed on *Pallas* cannot be conclusively determined but they were 47 to 66 in. (119.4-167.6 cm.) long and almost certainly a type of coked or tabled diagonal scarf set in the vertical plane (Fig. 4 and 6).<sup>14</sup> Ollivier states that unlike the French, English shipwrights arranged their keel scarfs side by side rather than one on top of another.<sup>15</sup> The keel of *Diana*, 50 years later, employs the same method.<sup>16</sup> Goodwin states that the butt and coke method was the most common (Figs. 6). The butt ends were sided 1/3 of the total siding, the cokes were 2/3 the siding in length and half as wide as they were long (but were never more than 1/2 the molded depth of the keel).<sup>17</sup> While the location of each scarf is marked on some Admiralty drafts, they are not marked on the drafts for *Pallas* or her sister ships. Most sources agree that the scarfs were lined with tarred flannel.<sup>18</sup> However, Ollivier observed that "... English shipwrights line their keel scarfs neither with kersey nor any other filling, they are content but to tar them."<sup>19</sup> Presumably, the use of flannel was a practice that emerged over the course of the century. A rabbet was cut several inches below the top of keel on foreign ships but this did not occur on English warships until after Robert Seppings became surveyor of the Navy in 1812-13.<sup>20</sup> Prior to this, Royal Navy practice was to cut the rabbet along the top edge of the keel and then to build up the surface above with a 'hog' or additional deadwood placed on top of the keel.<sup>21</sup> The keel of HMS *Charon* was constructed in exactly this manner.<sup>22</sup>

Once the main element of the keel was completed, the caps on the support blocks were removed and a false keel was fitted to the underside of the keel assembly. The false keel was a sacrificial element that protected the main keel in case of accidental grounding and increased the keel depth, thereby reducing leeway and enhancing handling characteristics. Made of elm or

teak, the false keel was slightly longer than the main keel and projected a short distance beyond the keel's leading edge. Both the keel and false keel were seated into notches cut into the underside of the gripe. The false keel was composed of five pieces, 4½ to 6 in. (11.4-15.2 cm.) thick with the scarfs being given sufficient shift to avoid those of the keel.<sup>23</sup> The false keel's sided dimension was the same as that of the keel, and the depth was about one third of the molded depth of the keel. The false keel on HMS *Charon* was 6 inches (15.2 cm.) thick, and separated from the main keel by approximately ¼ in. (6 mm.) of oakum.<sup>24</sup> False keels may have been assembled with flat scarfs in the horizontal plane, but more likely with flat scarfs in the vertical plane to facilitate frequent repair and replacement. The false keel was not secured to the main keel with iron bolts or nails but with copper staples, fastened into the sides of the false keel and the keel. This allowed for the false keel to be torn away without causing major damage to the main keel.<sup>25</sup>

#### B. Stem Assembly

Once the keel assembly was complete, the stem and sternpost were erected. The stem and apron were raised together; as was the entire sternpost, fashion piece and transom assembly (Figs. 7, 8 and 9). This was more easily accomplished on smaller vessels. The stem and sternpost assemblies were then trued with the keel, ensuring that the transoms were both perpendicular to the keel and level, before being securely shored on timber foundations.<sup>26</sup>

The shape and dimensions of the stem and apron can be accurately determined from Slade's construction drafts.<sup>27</sup> The stem was composed of two pieces scarfed together in a manner similar to that of the keel. It was molded 16 in. (40.6 cm.) for its entire length and sided 17½ in. (44.4cm.) at the head, diminishing to 13 in. (33 cm.) at the lower side of the cheek, and 10¼ in. (26 cm.) at the keel.<sup>28</sup> It had the same siding as the keel at the boxing but increased as it neared



the bowsprit. The rabbet of the stem was cut flush with the inner surface of the stem, leaving no portion of the stem projecting inside of the planking.<sup>29</sup> The scarfs were 40 in (1.02 m.) long and were secured with six 1 in. (2.5 cm.) diameter iron bolts. Two of the scarf bolts went through the false stem as well.

The false stem or 'apron' was composed of two or three pieces molded 9½ in. (24.1 cm.), sided 19½ in. (49.5 cm.), and fastened together with plain flat scarfs 10½ in. (26.7 cm.) long.<sup>30</sup> The portion of the apron that exceeded the athwartship dimensions of the stem was shaped to provide a landing for the wales and planking. Once this structure was completed, the stem and apron assembly was raised into place by means of sheerlegs.<sup>31</sup> It was half lapped to the top of the keel with a complex scarf called the boxing and, like the keel scarfs, the joint was lined with tar and flannel and secured with six or eight iron or copper bolts driven from opposite sides and clenched over roves. Goodwin suggests a variety of potential boxing techniques but states that the slotted (mortised) type was the most commonly used after the first quarter of the 18<sup>th</sup> century (Fig. 10). As previously stated, the fore end of the keel and keelson extended forward of the boxing scarf and butted against the aft edge of the gripe (Figs. 7 and 8).<sup>32</sup>

### C. Sternpost Assembly

The sternpost assembly served to support the aft body of the ship, the stern timbers and the rudder (Fig. 9). The sternpost itself was cut from carefully selected oak and was mortised into the top of the keel. The mortise was cut to 1/3 the molded depth and 1/3 the sided dimensions of the keel. This joint was typically reinforced by bolting copper fishplates across the seams on either side of the keel.<sup>33</sup> The sternpost was 18 in. (45.7 cm.) square at the head; the fore and aft dimension at the heel, including the inner post, was 32 in. (81.3 cm.). The fore and aft dimension of the inner post was 9 in. (22.9 cm.) at the head and 13 in. (33 cm.) at the heel.<sup>34</sup> The sternpost's

athwartship dimension at the heel was the same as that of the aft end of the keel to which it was fastened, or between 9 and 11 in. (22.9-27.9 cm.). The after edges of the sternpost and keel were chamfered about 60 degrees to allow for the pivot of the rudder. The rake of the sternpost can be accurately determined from Slade's drafts as about 5.5 degrees.<sup>35</sup> The inner post served to reinforce the main post and to support the wing transom. Also made of oak, the inner post was mortised onto the top of the keel in the same manner as the main post, and secured to the forward face of the main post with copper clench bolts.<sup>36</sup> The inner post was beveled to provide a landing for the planking, and a rabbet was cut into the fore edge of the main post to receive the hood ends of the planking.

Before the sternpost assembly was raised, the wing transom, lower deck transom, filling transoms, and fashion pieces were fitted. The wing transom was the most important timber in the stern structure, for it provided both lateral support and served as the foundation for the upper works of the stern. It was made of a single piece of oak notched into the forward face of the sternpost and mortised onto the top of the inner post. It was rabbeted on the upper and lower surfaces to receive the planks of the counter and the tuck.<sup>37</sup> The wing transom was sided 13 in. (33 cm.), molded 14 in. (35.6 cm.), and the athwartship arms spanned the breadth of the stern just below the upper deck. The transoms were notched 1½ in. (3.8 cm.) into the sternpost in the same manner as floors were notched into the keel.<sup>38</sup> They possessed a rising curvature towards the middle of the ship, similar to the floors, called the 'flight.' The wing transom was also rounded upward towards the midline of the ship. The deck transoms were similarly rounded upwards to match the curvature of the associated deck beams.<sup>39</sup> Two copper clench bolts secured the wing transom to the sternpost, two more secured it atop the inner post, and two more secured each end to the aft faces of the fashion pieces.<sup>40</sup> The wing transom was secured firmly to the side of the ship with large knees. The wing transom knees were sided 9 in. (22.9 cm.), the fore and aft

arms were 11 ft. 6 in. (3.51 m.) long, and the athwartship arms were 6 ft. 3 in. (1.9 m.) long. Each was bolted to the transom and the ship's sides with ten 1¼ in. (3.2 cm.) diameter iron bolts.<sup>41</sup>

Cut from carefully selected curved timber, fashion pieces were a continuation of the cant frames aft. They terminated the breadth of the framing and formed the shape of the lower stern (Fig. 9).<sup>42</sup> Most ships had two on each side. The forward most on *Pallas* finished about 3 ft. (9.1 cm.) above the upper edge of the wing transom, and the aftermost finished under the gun deck transom. They were scored over the transoms and fixed in place with treenails and copper bolts.<sup>43</sup> The lower deck transom was installed in a similar manner to the wing transom. However, to compensate for the added molded dimension required to support the ends of the deck planking, it was necessary to notch the lower deck transom 1½ in. (3.8 cm.) into the after face of the aftermost fashion pieces as well. Next, two filling transoms were installed between the wing transom and the lower deck transom, and two more below the lower deck transom. They were all sided 10½ in. (26.7 cm.) and each molded to incrementally rise and narrow as they drew closer to the top of the deadwood.<sup>44</sup> Like the stem assembly, the sternpost assembly was raised into place by means of sheerlegs and shored on timber foundations.<sup>45</sup>

Once the sternpost assembly was raised, the counter timbers were attached. Counter timbers were a series of six upright timbers that defined the shape of the upper stern (Fig 9). The two side counter timbers possessed complex curves in all three dimensions, defining the shape of the stern from both the athwartship and sheer perspectives. The remaining counter timbers were placed between the side counter timbers to form the sides of the window openings and stern ports. Because of their complex shape, they were made from two or more scarfed and bolted pieces. On *Pallas* they were sided 8 in. (20.3 cm.); the fore and aft dimensions of the heels were the same as the upper edge of the wing transom and gradually diminished towards the heads

(Figs. 9 and 11). They were firmly fastened to the top of the wing transom with  $\frac{3}{4}$  in. (1.9 cm.) iron bolts.<sup>46</sup>

#### D. Deadwood

The deadwood or rising wood was an assemblage of large pieces of timber laid upon one another, on top of the main keel, to accommodate the rising of the frames towards the bow and stern, and to form a foundation for the frames and the run of the keelson. (Figs. 7 and 9)<sup>47</sup> It was fashioned 2 to 4 in. (5.1-10.2 cm.) wider than the corresponding keel and trimmed to match the angle of the rabbet.<sup>48</sup> The bow deadwood consisted of a single timber cut to fill the space between the apron and keelson forward of the foremost full frame. The stern deadwood configuration is much more difficult to establish. Ollivier observed a variety of stern deadwood configurations employing layered sections of straight timbers butted against the sternpost, both with and without the addition of a deadwood knee. Furthermore, he observed three different methods employed on three different ships at the same shipyard.<sup>49</sup> He reasonably concluded that deadwood configuration was dependent upon the individual shipwright and the materials available. The stern deadwood on HMS *Charon* was composed of as many as four timbers stacked atop the keel. The lowest piece was tenoned into the forward face of the inner post and the whole assembly was bolted through the keel with  $1\frac{1}{4}$  in. (3.2 cm.) iron bolts.<sup>50</sup> Good examples of deadwood on frigates can be seen on the reconstructions of *Diana* and *Pandora*.<sup>51</sup> Another good example can be seen on the construction drafts of a 60-gun ship built to 1745 establishment standards.<sup>52</sup> Despite the disparity in size of these examples, all employ a single deadwood or 'sternson' knee integrated into a varied assemblage of straight timbers, securing them firmly to the inner sternpost. It would be impossible to establish conclusively what *Pallas*' deadwood would have looked like; however, a reasonable facsimile can be extrapolated from the

parallels available. The sternson knee is portrayed on Slade's construction draft extending aft of the keelson up the inner post to the base of the lowest filling transom. It was bolted through the deadwood, keel, and sternpost with 1¼ in. (3.2 cm.) iron bolts spaced about every 22 in. (55 cm.).<sup>53</sup>

#### E. Frames

Once the keel, stem, and sternpost assembly was completed, and trued and shored in position, the frame timbers were installed. There were three general types; full or square frames, cant frames, and filling frames. Full frames were solid units composed of two overlapping courses of timber. They formed the sides of the gun ports and continued uninterrupted from the keel assembly to the upper works. Cant frames were angled frames forward and aft that were bolted to the sides of the deadwood and formed the bow and stern. Filling frames were essentially the separated components of full frames. They extended up to the gun port sills and then were continued above (Fig. 12).

The layout of the frames usually took place in large buildings called mold lofts where full sized patterns were marked out on the floor and each frame component was cut from compass oak to match its individual pattern.<sup>54</sup> Initially every second floor was placed across the keel, beginning with the midship floor and moving forward and aft from there.<sup>55</sup> The top of the keel or hog timber was notched to receive the floors, each of which was correspondingly notched on its underside (Figs. 4 and 12). Careful attention was given to ensuring that the floors were exactly perpendicular to the line of the keel before being bolted through the keel with 1¼ in. (3.2 cm.) diameter bolts.<sup>56</sup> At the bow, and especially at the stern, specially molded rising floors were lofted to accommodate the rising and narrowing of the hull shape as it neared the posts. Because of the acute angle of these frames they were usually assembled or 'made' from

two or three pieces with a variety of complex scarfs.<sup>57</sup> Once this was done, about every third or fourth frame was raised. The frames were assembled on the ground adjacent to the slipways. Each frame timber, or 'futtock,' overlapped by half its length the frame timbers below and above (Fig. 12). The lower half of the second futtock was bolted in the fore and aft direction to the upper half of the first futtock, the heel of the upper futtock butted against the head of the first futtock, and its lower half was bolted in a like manner to the upper half of the second futtock. The top-timbers were not attached until after the frames had been raised. To further reinforce the joints between the frame timbers, seats were cut into the head and heel of each futtock (not at the heads of the top-timbers) to receive cross chocks. The chocks were secured in place with four treenails driven through the frame from the inside.<sup>58</sup>

The completed frame halves were hoisted into position against their assigned floors. The heels of the first futtocks butted against the sides of the keel, and the heels of the second futtocks butted against the heads of the floor. Chocks were then placed across the timber butts and secured with treenails. A larger chock crossed the keel, connecting the heels of the lower futtocks, and was bolted through the keel. Finally, the lower futtocks were bolted through fore and aft to their associated floor.<sup>59</sup> Once this was accomplished the frames were shored in place and ribbands were placed to ensure the fairness of the remaining frames as they were assembled in place. The breadth ribband was placed so that the main wale could be placed before the ribband was removed.<sup>60</sup> All of the remaining floors were then placed. They were not lofted as those before but were 'spiled' or shaped once in place to conform to the ribbands. The remaining deadwood was built up on top of the keel assembly towards the stem and sternpost to accommodate the rising and narrowing of the frames as they neared the posts.<sup>61</sup>

The sided dimensions of all frames and futtock timbers diminished afore and abaft of midship but usually not more than one inch (2.5 cm.) over the entire length of the ship. For

simplicity only midship dimensions are given here. All available sources agree that the midship floors for a 36-gun frigate of the period were molded 18 in. (45.7 cm.) at the keel, 10 to 12 in. (25.4-30.5 cm.) at the rung heads, and were sided 12½ to 14 in. (31.7-35.6 cm.). The first futtocks were molded 10½ in. (26.7 cm.) at the rung heads and sided 12½ in. (31.7 cm.). The second futtocks were molded 10½ in. (26.7 cm.) at the rung heads and sided 11¾ in. (29.8 cm.). The third futtock was molded 9 in. (22.9 cm.) at the gun deck and sided 11 in. (27.9 cm.). The top-timbers were molded 4 to 4½ in. (10.2-11.4 m.) and sided 10½ to 11 in. (26.7-27.9 cm.) at the heads. The lengths of the chock scarfs are not as conclusive; the 1719 Establishment list calls for scarfs 6 ft. 4½ in. (1.94 m.) long. However, these figures represent a period when timber was more abundant and larger pieces were employed. *Diana* and *Pandora*, while considerably later, are much closer in date to *Pallas*. The frame scarfs on *Diana* were about 48 in. (1.22 m.) long and those on *Pandora* were about 28 in. (71 cm.) long.<sup>62</sup> It is therefore reasonable to assume that those on *Pallas* would have been an average between *Diana* and *Pandora*, or about 38 in. (96.5 cm.) long.

Once all of the full frames were erected the gun ports were installed. The upper and lower sills of the ports were notched into the neighboring full frames. The port sills had the same molded dimensions as the frames.<sup>63</sup> Since *Pallas* had only a single gun deck, only one row of ports was needed. Ollivier observed that no space was left between the floors and frames up to the heads of the first futtocks and that the space between was caulked. He surmised that this served both as ballast and prevented water from gathering between the floors.<sup>64</sup> However it is clear that warships of *Pallas*' time had considerable space between the frame timbers. Goodwin states that the room and space (the width of the frame plus the space in between) for one full frame on a 36-gun ship in 1780 was about 30 in. (76.2 cm.).<sup>65</sup> The room and space recorded from the remains of HMS *Charon* was 28 in. (71.1 cm.) and the floors were sided 12 in. (30.5

cm.).<sup>66</sup> Both sources suggest a room and space close to twice the 12½ to 14 in. (31.7-35.6 cm.) sided dimension of the midship frame at the keel. They had enough room in fact that the elements of the filling frames could be separated, leaving ventilation space between them and reducing the amount of timber required to frame the ship. The timbers of the filling frames were cut in exactly the same manner as those for the full frames. However, the two courses that were bolted together on full frames were assembled and raised as independent elements leaving space between the two courses (Fig. 12). On one half, the head of the floor was chocked to the heel of the second futtock, and the head of the second futtock was chocked to the heel of the top-timber, on the other, the head of the first futtock was chocked to the heel of the upper futtock. Oak filling pieces were placed between the two halves of the filling frames and were bolted through fore and aft.<sup>67</sup>

As the frames neared the bow the floors became half floors. They ceased to cross the deadwood and instead component parts were notched into the top and sides of the deadwood. The notches found on the remains of *Charon* were cut 2 to 3 in. (5.1-7.6 cm.) deep into the top of the deadwood and 12 to 13 in. (30.5-33 cm.) long down the sides.<sup>68</sup> Further forward, as the bow continued to rise and narrow, the cant frames were only notched and bolted to the sides of the deadwood.

Cant frames were frames situated at the ends of the ship that gradually transitioned the lines of the sides towards their respective posts (Fig. 8).<sup>69</sup> They were introduced sometime in the eighteenth century. Sutherland's *Shipbuilding Unvail'd* of 1711 makes no mention of cant frames. They start to appear in ship models around 1719, becoming more common until almost universal by 1750.<sup>70</sup> They were to be equally spaced at the breadth ribband, and shaped using the ribbands, to fair with hawse pieces at the bow, and the transoms and fashion pieces at the stern (Figs. 8 and 9). Cant frames never progressed past 45 degrees from the line of the keel.<sup>71</sup>



Hawse pieces filled the remaining space between the cant timbers and the stem assembly. They were broad timbers standing nearly parallel to the keel through which holes were cut to allow the passage of anchor cables. (Fig. 8 and 13)<sup>72</sup> Their heels butted against the forward face of the foremost cant timber and then curved forward and upward forming the cheeks of the bow. The cants were bolted to the stem assembly and to each other abaft the hawse holes. They were fashioned so that the area around the hawse holes stood proud of (and therefore interrupted) the planking and ceiling strakes—thus preventing excessive damage to the butt ends of those strakes.<sup>73</sup> *Pallas* had four hawse pieces, of the same molded dimensions as the forwardmost cant frame timber and sided 14 in. (35.6 cm.).<sup>74</sup> The timbers directly adjacent to the stem were called bollard timbers or knights heads. They extended above the top timbers and provided lateral support to the bowsprit (Fig. 8). The hawse holes were 13 in. (33 cm.) in diameter and 19 in. (48.3 cm.) above the lower deck. They were lined with lead 1 in. (2.5 cm.) thick.<sup>75</sup>

All ships above 6<sup>th</sup>-rate had a manger or partially walled compartment, not more than 3 ft. 6 in. (106.7 cm.) high, inside the hawse holes to collect water entering through them and to prevent it from running into the ship. The manger boards were 8 to 10 in. (20.3-25.4 cm.) wide, 3 in. (7.6 cm.) thick, rabbeted and secured directly to the cant frames, or to stanchions fixed to them, and extending to stanchions 6 to 9 in. (15.2-22.8 cm.) square placed on either side of the bowsprit step. At the after edges of the manger were two 4¾ in. (12.1 cm.) diameter lead scuppers. The manger, as the name suggests, was also typically used for live animal storage.<sup>76</sup>

#### F. Keelson

The keelson was a heavy longitudinal timber fixed directly over the keel, binding the frame timbers in between, and strengthening the lower part of the ship (Fig.4).<sup>77</sup> It also formed a foundation to support the masts, stanchions and other structural elements. The keelson on *Pallas*

was composed of five pieces, 14 in. (35.6 cm.) square, assembled with hook scarfs 4 ft. 10 in. (1.47 m.) long, and fastened with two  $\frac{3}{4}$  in. (1.9 cm.) iron bolts at each scarf (Fig. 6). The keelson scarfs, like those on the false keel were shifted clear of the keel scarfs. The keelson was notched down over the floor timbers  $\frac{3}{4}$  in. (1.9 cm), before being bolted through every other floor to the keel (those floors not already bolted to the keel) with  $1\frac{1}{4}$  in. (3.2 cm.) iron bolts.<sup>78</sup> After 1750 the keelson no longer terminated at the deadwood but instead carried up to or over the transoms (as the 'sternson') and up to the lower deck hook (as the 'stemson').<sup>79</sup> The sternson was simply an extension of the keelson over the deadwood, retaining the dimension of the keelson and ending in a sternson knee against the inner post. The stemson extended from the forward end of the keelson up to the underside of the upper deck breast hook and diminishing to 10 in. (25.4 cm.) square at its peak (Fig. 7).<sup>80</sup>

#### G. Internal Planking

Ships like *Pallas* were planked both inside and out. The first and most important part of the planking to be fitted was the main wale, a belt of heavy strakes placed between the waterline and the gun ports. Its primary function was to add longitudinal strength. The main wales ran parallel to the line of the sheer rather than the decks. The lower edge tapered towards the ends of the ship.<sup>81</sup> Wales were made of the very best quality oak cut 25 ft. (7.62 m.) long and 7 in. (17.8 cm.) thick. The main wales on both *Diana* and *Pandora* were at or near the dead flat of the sides (Fig. 14). All sources agree that the main wales on 36- to 38-gun frigates were composed of four strakes, 38 to 43 in. (96.5-109.2 cm.) wide, and  $5\frac{1}{2}$  to 7 in. thick.<sup>82</sup>

During construction, once the main wale was fitted, all attention shifted to the internal planking. Work began at the bottom and progressed upwards. As the planking reached the height of each deck, the beams and supporting knees for that deck were installed.

The limber strakes, ceiling or footwaling, stringers, deck clamps, waterways, spirketting, and quickwork were all varieties of longitudinal internal planking. They were all fitted over the frames in parallel courses, tapering towards the posts, and butting up against the apron at the bow and the fashion pieces at the stern. The transoms were usually left exposed.<sup>83</sup>

The limber strakes were a double row of strakes placed 9 to 10 in. (22.9-25.4 cm.) from the keelson amidships (Fig. 14). Each strake was constructed of plank sections about 25 ft. (63.5 cm.) long, joined together with flat scarfs, and fixed to the frames with treenails. The first strake, that closest to the keelson, was 12 to 13 in. (30.5-33 cm.) wide and 5 to 5½ in. (12.7-14 cm.) thick. The second strake was 11¼ to 12 in. (28.6-30.5 cm) wide and 4 to 4¼ in. (10.2-10.8 cm.) thick. The strakes tapered towards the ends of the ship to about one-third their width at the midship frame. The outboard edge of the second limber strake was chamfered to meet the neighboring footwaling.

A groove about 2 in. (5 cm.) deep was cut into the inboard edge of the inner limber strake into which the limber boards were seated.<sup>84</sup> Limber boards were short panels left loose between the keelson and the limber strakes that could be removed to allow access to the bilge.<sup>85</sup> The limber boards on *Charon* were found to be 3 inches (7.6 cm.) thick.<sup>86</sup>

Also known as thick stuff, stringers were a series of heavy ceiling strakes laid at the rung heads of the floors to help strengthen the joint (Fig.14). For a 36-gun ship the stringer assembly consisted of five strakes. The one directly over the joint was 15 in. (38.1 cm.) wide and 6 in. (15.2 cm.) thick, the next two above and below were 12 in. (30.5 cm.) wide and 5½ in. (14 cm.) thick, and the outer two were 11 in. (27.9 cm.) wide and 4½ in. (11.4 cm.) thick. The strakes were fastened together with plain flat scarfs (Fig. 6). All were secured to the frames with treenails. As with all planking and ceiling strakes, stringer strakes diminished in width towards the bow and stern to accommodate the rising and narrowing of the hull.<sup>87</sup>

Clamps were thick stakes worked fore and aft inside the ship that supported the ends of the deck beams (Fig 14). They were assembled from oak planks 25 to 30 ft. (7.62-9.14 m.) long scarfed together hook and butt fashion (Fig. 6). The scarfs were 34 to 45 in. (86.4-114.3 cm.) long and were bolted together with two  $\frac{3}{4}$  in. (1.9 cm.) diameter iron bolts through the butt ends of each scarf. The upper edge was beveled to match the slight arc of the deck beams they supported and they were notched about 1 in. (2.5 cm.) to receive the ends of the deck beams. The clamps on 5<sup>th</sup>-rate warships usually consisted of two stakes with the scarfs shifted half their length.<sup>88</sup>

The orlop clamps were composed of two stakes assembled with hook and butt scarfs and secured together with two  $\frac{3}{4}$  in. (1.9 cm.) iron bolts through the lip of the scarf. The upper stakes were  $11\frac{3}{4}$  to 14 in. (29.8-35.6 cm.) wide and 4 to  $4\frac{3}{4}$  in. (10.2-12.1 cm.) thick; the lower clamp stakes were  $9\frac{3}{4}$  to 11 in. (24.8-27.9 cm.) wide and 3 to  $3\frac{3}{4}$  in. (7.6-9.5 cm.) thick.<sup>89</sup>

The lower deck clamps were composed of two stakes assembled with hook and butt scarfs 34 in. (86.4 cm.) long. The upper stakes were 14 to 15 in. (35.6-38.1 cm.) wide and  $5\frac{1}{4}$  to  $5\frac{1}{2}$  in. (13.3-14 cm.) thick, and the lower stakes were 13 in. (33 cm.) wide and 4 to  $4\frac{1}{4}$  in. (10.2-10.8 cm.) thick.<sup>90</sup>

The upper deck clamps were composed of one or two stakes assembled with hook and butt scarfs 45 in. (114.3 cm.) long. For a frigate carrying a main battery of 12-pound guns on the upper deck it is reasonable to assume that two stakes would have been used.<sup>91</sup> Both stakes of the gundeck clamps were  $9\frac{3}{4}$  in. (25.8 cm.) wide and 4 to  $4\frac{3}{4}$  in. (10.2-12.1 cm.) thick, with the lower stakes being chamfered about 1 inch (2.5 cm.) at the bottom edge.<sup>92</sup>

The deck clamps for the quarterdeck and forecastle consisted of only a single stake on frigates, with the planks being scarfed together with two iron bolts driven vertically through a flat scarf. The deck clamps for both the forecastle and the quarterdeck generally filled the entire

space between the tops of the gun port sills on the gun deck, and the beams on the underside of the forecastle and the quarterdeck respectively. For a frigate this was about 11½ in. (29.2 cm.) wide and 3¾ to 4 in. (9.5-10.2 cm.) thick with the lower edge being chamfered about 1 in. (2.5 cm.).<sup>93</sup>

All deck clamps were fastened to the frames with both treenails and iron ‘dumps’ (round tapered spikes) and tapered towards the ends of the ship in a similar fashion to the planking and ceiling. They were usually chamfered about 1 in. (2.5 cm.) on their lower edge to meet the ceiling planking.<sup>94</sup>

As previously stated, the beams and supporting knees for each deck were installed as the planking reached the height of that deck. However, for the sake of continuity discussion of deck beams and associated timbers will follow completion of the internal planking.

The next internal planks installed were the waterways, which were specially shaped ceiling strakes, wider than the rest, placed onto the ends of the deck beams. They were designed to prevent water from passing between the ceiling planking and decking and reaching the beam-ends and frames (Fig 14). During the 18<sup>th</sup> century, waterways on British warships were concave on the exposed surface creating a smooth transition from the horizontal decking to the vertical spirketting.<sup>95</sup> The lower deck waterways were 4 in. (10.2 cm.) thick.<sup>96</sup> The upper deck waterways were 4½ in. (11.4 cm.) thick and had six 2¾ in. diameter scuppers along each side.<sup>97</sup> The waterways for both the quarterdeck and forecastle were 4 in. (10.2 cm.) thick.<sup>98</sup>

Spirketting was a thick band of ceiling strakes that filled the space between the tops of the waterways and the bottoms of the gun ports (Fig. 14 and 15).<sup>99</sup> As with wales and stringers, it served to increase the longitudinal strength of the hull. It was constructed with hook and butt or anchor stock scarfs that were shifted away from the gun ports (Fig. 6). The seam between the lower spirketting strake and the waterway was caulked with oakum and tar. The width of the

individual strakes would have depended entirely upon the space to be filled between the waterway and the gun port sills. The lower deck spirketting was 4 to 4 3/8 in. (10.2-11.1 cm.) thick.<sup>100</sup> The upper deck, spirketting was composed of two strakes, each 4 in. (10.2 cm.) thick.<sup>101</sup> The spirketting for both the quarterdeck and forecastle was 3 to 4 in. (7.6-10.2 cm.) thick.<sup>102</sup>

Foot waling consisted of all of the remaining inboard planking from the keelson to the orlop clamps (Fig. 14).<sup>103</sup> It filled the space between the limber strakes and the stringers over the frame heads, and from the stringers up to the berth deck clamps. Unlike the rest of the ceiling, it was often made from pine instead of oak. Each strake was about 9 in. wide, 3½ to 4 in. (8.9-10.2 cm.) thick, and was fixed to the frames with treenails. Spaces were typically left between strakes to allow for ventilation of the internal structure.<sup>104</sup>

Quickwork was the planking that formed the internal lining of the hull throughout the working decks (gun deck, lower deck, and orlops) (Fig.15). Like the footwaling, the quickwork was usually made from pine. On the orlop deck the planks were 10 to 15 in. (25.4-38.1 cm.) wide and 6 to 8 in. (15.2-20.3 cm.) thick. They were secured to the frames with iron bolts at the ends and treenails in between. Usually 1½-3 in. (3.8-7.6 cm.) spaces were left between the quickwork strakes for ventilation. On the lower deck the quickwork consisted of a single strake 2½-2¾ in. (6.3-7 cm.) thick. The upper deck quickwork consisted of two strakes 1¾-2 in. (4.4-5.1 cm.) thick.<sup>105</sup> The width varied depending on the number of strakes and the space to be filled. The quickwork strakes between the gun ports had openings cut into them (and were therefore known as air strakes) to provide ventilation to the frames (Fig. 15).<sup>106</sup>

Finally the strings of the waist were worked in just below the gunwale, between the forecastle and quarterdeck, to provide longitudinal integrity to the sheer. The strings were composed of one or two strakes 3½ in. (8.9 cm) thick, scarfed hook and butt into the forecastle

and quarterdeck clamps. They were notched over each frame timber for added rigidity and fastened with  $\frac{3}{4}$  in. (1.9 cm.) iron bolts.<sup>107</sup>

#### H. Deck Beams, Knees, Carlings, Ledges and Hooks

Once the clamps were in place at each deck level, the deck beams and supporting knees were installed. The numbers and approximate placement of the deck beams were provided by Slade's construction draft (Fig. 5). However, some adjustments and corrections had to be made to reconcile the various plan views and placement of additional internal fittings.<sup>108</sup>

Beams were assembled or 'made' from multiple pieces of timber, usually oak but sometimes pine, fastened together with an elongated form of hooked or tabled scarf in the vertical plane. The scarfs were one-third the overall length of the beam and were secured with 1 in. (2.5 cm) diameter iron bolts. With the exception of orlop beams, all beams were rounded up or 'cambered' towards the centerline of the ship to ensure that water drained outboard to the scuppers.<sup>109</sup> The beams were seated into 1 in. (2.5 cm.) notches cut into the clamps and, because the exposed beam-ends were prone to rot, these joints were packed with tarred flannel or brown paper. The space between the beam-ends was filled either with a lodging knee or with a specially fitted spacer or 'packing piece.' Beams were spaced so that associated hanging knees did not interfere with gun ports and they were located over one another and supported through pillars directly down to the keelson. Every effort was made to place beams under gun ports to support the weight of the guns. By necessity beams had to be placed clear of masts and hatchways.<sup>110</sup> This was accomplished by using beam arms; specially formed deck beams that curve to meet the fore or aft face of the neighboring beams thereby partially compensating for the loss of an athwartship beam. *Pallas* had a single 'fork beam' or two beam arms curving from each side to meet the fore and aft faces of the same beam (Figs. 5, 16 and 17).<sup>111</sup>

Knees were angled timbers that reinforced the joints between the deck beams and the sides of the ship.<sup>112</sup> They were carved from carefully selected curved oak compass timber possessing a grain following the desired curvature of the knee. The deck structure of 18<sup>th</sup>-century frigates employed several varieties of knees. Hanging knees were oriented in the vertical plain, with the vertical arm reaching down, and supporting the deck structure from the underside. Standing knees or ‘standards’ were also oriented in the vertical plane but had the vertical arm reaching up above the deck supporting it from above. Finally, lodging knees were placed in the horizontal plain between the deck beams and prevented movement fore and aft.

All sources agree that the orlop deck beams were composed of single timbers sided 9 in. (22.9 cm.) and molded 8 to 9 in. (20.3-22.9 cm.).<sup>113</sup> The orlop beams were secured to the side of the ship with standing and lodging knees. The standing knees were sided 6¼ to 6½ in. (15.9-16.5 cm.) and the athwartship arms were 42 to 45 in. (106.7-114.3 cm.) long. The vertical arms reached to the upper edge of the lower deck clamp. The lodging knees were sided 6½ to 6¾ in. (16.5-17.1 cm.), the athwartship arms were 42 in. (106.7 cm.) long, and the fore and aft arms were not less than 38 in. (96.5 cm.) long. All were bolted through with six 1 in. (2.5 cm.) diameter iron bolts (Fig. 18)<sup>114</sup>

The lower deck beams were sided 9 to 10 ½ in. (22.9-26.7 cm.) and molded 8 to 9½ in. (20.3-24.1 cm.).<sup>115</sup> They were composed of two pieces and were cambered 4½ in. (11.4 cm.) at the centerline of the ship.<sup>116</sup> The lower deck beams were secured to the side of the ship with both hanging and lodging knees. The hanging knees were sided 7½ in. (19 cm.), the athwartship arms were 40 to 44 in. (101.6-111.8 cm.) long, and the vertical arms were 54 in. (137.2 cm.) long. The lodging knees were sided 7 to 7½ in. (17.8-19 cm.), and the athwartship arms were 40 to 44 in. (101.6-111.8 cm.) long. The length of the fore and aft arms was dictated by the space between the deck beams. All were bolted through with eight 1 in. (2.5 cm.) diameter iron bolts (Fig 17).<sup>117</sup>



The upper deck beams were sided 11 to 12 in. (27.9 cm.) and molded  $8\frac{1}{2}$  to 11 in. (21.6 cm.).<sup>118</sup> They were composed of two pieces and were cambered 8 in. (20.3 cm.) at the centerline of the ship.<sup>119</sup> The upper deck beams were secured to the side of the ship with both hanging and lodging knees. The hanging knees were sided  $7\frac{1}{2}$  to 8 in. (19-20.3 cm.) and the athwartship arms were 40 in. (101.6 cm.) long. The vertical arm reached down to the spirketting of the lower deck. The lodging knees were sided 7 to  $7\frac{1}{2}$  in. (17.8-19 cm.) and the athwartship arms were 42 in. (106.7 cm.) long. The length of the fore and aft arms was dictated by the space between the deck beams (Fig.16). There were also five pairs of upper deck standing knees or standards. Their exact placement is unknown but they were probably distributed as evenly as possible along the ship's side without interfering with the operation of the guns. They were sided 8 in. (20.3 cm.), the athwartship arms were 36 in. (91.4 cm.) long, and the vertical arm reached to the upper edge of the forecastle and quarterdeck clamps or the string of the waist. All were bolted through with seven 1 in. (2.5 cm.) diameter iron bolts.<sup>120</sup>

The quarterdeck and forecastle beams were sided  $6\frac{1}{2}$  to 8 in (16.5-20.3 cm.) and molded  $5\frac{3}{4}$  to 6 in. (14.6-15.2 cm.).<sup>121</sup> They were composed of two pieces and were cambered 7 in. (17.8 cm.) at the centerline of the ship.<sup>122</sup> The forecastle and quarterdeck beams were secured to the side of the ship with hanging and lodging knees. The hanging knees were sided  $4\frac{3}{4}$  in. (12.1 cm.) and the athwartship arms were 31 to 33 in. (78.7-83.8 cm.) long on the forecastle and 33 in. (83.8 cm.) long on the quarterdeck. The vertical arms reached to the spirketting on the gun deck. All were bolted through with seven  $\frac{3}{4}$  in. (1.9 cm.) diameter iron bolts. The lodging knees were sided  $4\frac{1}{2}$  to  $5\frac{1}{4}$  in. (11.4-13.3 cm.) and the athwartship arms were 31 in. (78.7 cm.) on the forecastle and 35 in. (88.9 cm.) on the quarterdeck. The length of the fore and aft arms was dictated by the space between the deck beams. All were bolted through with five  $\frac{3}{4}$  in. (1.9 cm.) diameter iron bolts (Fig 19).<sup>123</sup>

The catbeam was the foremost beam on the forecastle and the largest beam on the ship. It supported the inboard ends of the catheads and therefore had to be able to support the weight of the anchors. It also supported the upper ends of the vertical stanchions of the beakhead bulkhead (Figs. 5 and 19). It was 18 in. (45.7 cm.) wider and 2 in. (5.1 cm.) deeper than the other forecastle beams. The knees supporting the catbeam were sided about 4½ in. (11.4 cm.) larger than the other forecastle knees.<sup>124</sup>

Once the deck beams and their corresponding knees were installed the carlings and ledges were fitted. Carlings were nearly square pieces of oak or fir fitted fore and aft in tiers between the deck beams. They were scored 1½ in. (3.8 cm.) into the beams down to the same level as the tops of the deck beams. Ledges were scored 1 in. (2.5 cm.) into the carlings athwartship in the same manner that the carlings were notched into the deck beams. Carlings and ledges were considered a means of adequately strengthening the deck structure while saving both timber and weight (Figs. 16 and 17).<sup>125</sup>

The carlings under the orlop deck were 6¼ to 6½ in. (15.9-16.5 cm.) wide and 4¼ to 4¾ in. (10.8-12.1 cm.) deep and the ledges were 3½ to 3¾ in. (8.9-9.5 cm.) wide and 3 in. (7.6 cm.) deep.<sup>126</sup> The carlings under the lower deck were 6¼ to 6½ in. (15.9-16.5 cm.) wide and 5¼ to 5½ in. (13.3-14 cm.) deep and the ledges were 3¾ in. (9.5 cm.) wide and ¾ to 3½ in. (8.2-8.9 cm.) deep (Fig. 17).<sup>127</sup> The carlings under the upper deck were 6¾ to 7 in. (17.1-17.8 cm.) wide and 4¾ to 5 in. (12.1-12.7 cm.) deep and the ledges were 3½ in. (8.9 cm.) wide and 3 in. (7.6 cm.) deep (Fig. 16).<sup>128</sup> All carlings and ledges were secured in place by nails driven from below. The quarterdeck and forecastle did not have carlings and ledges built into them.<sup>129</sup>

As each level of deck beams was installed, the corresponding transoms, breast hooks, and deck hooks were also installed. Breast hooks were large knees made of compass oak fixed transversely to the inner face of the stemson and over the cant frames and internal planking on

either side of the bow. Their function was to tie together the bow assembly and to buttress the bow against the impact of heavy seas.<sup>130</sup> Deck hooks were similar to breast hooks except that they also supported the ends of the lower and gun decks. They rose 3 in. (7.6 cm.) above the deck planking and had a rabbet cut into them to receive the hood ends of the deck planking.<sup>131</sup> There was one breast hook between the upper and lower deck and three below the lower deck. The positioning and approximate dimensions of each breast hook, deck hook, and crutch can be seen on Slade's construction drafts (Fig. 5).<sup>132</sup> The gun deck hook was sided 11 in. (27.9 cm.), molded 30 in. (76.2 cm.), about 16 ft. (4.88 m.) long, and was secured to the stem and frames with eleven 1¼ in. (3.2 cm.) diameter iron bolts.<sup>133</sup> The lower deck hook was sided 11 in. (27.9 cm.), molded 30 in. (76.2 cm.), about 16 ft. (4.88 m.) long, and was secured to the stem and frames with eleven 1¾ in. (4.4 cm.) diameter iron bolts.<sup>134</sup> The three breast hooks below the lower deck were all sided 10½ in. (26.7 cm.); the upper was molded 30 in. (76.2 cm.) and was 14 ft. (4.27 m.) long, the lower was molded 27 in. (68.6 cm.) and was 12 ft. (3.66 m.) long, and the middle one was somewhere in between. They were secured to the stemson and the sides of the ship with ten 1¾ in. (4.4 cm.) diameter iron bolts.<sup>135</sup> No dimensions were found for the between decks breast hook but, given the similarity of all of the other breast and deck hooks, it is reasonable to assume that it was also sided 11 in. (4.88 m.) and about 16 ft. long.

Crutches were similar to the breast hooks except that they were placed on top of the keelson from the mizzen step aft where they provided internal support between the after frames. They were composed of compass oak to accommodate the sharp rise towards the stern. Slade's construction draft shows only one crutch half way between the mizzen step and the sternson knee. It was sided 9½ to 10½ in. (24.1-26.7 cm.), molded about 29 in. (73.7 cm.), and the arm lengths were 5 ft. 6 in. (167.6 cm.) on each side of the ship.<sup>136</sup>

As previously discussed, transoms were beams or timbers extending across the stern providing strength and giving shape to the stern. However, those transoms above the head of the sternpost were notched over the forward face of the counter timbers instead of to the sternpost assembly and fashion pieces. The lowest of these was the helm port transom, which on frigates was simply the upper gun deck transom.<sup>137</sup> It was seated against the inboard faces of the counter timbers at the height where the head of the rudder penetrated the stern.<sup>138</sup> It was 7½ to 12 in. (19-30.5 cm.) deep, 13½ to 18 in. (34.3-45.7 cm.) broad, and its length was equal to the distance between the side counter timbers. The underside of its after edge was bearded to conform to the shape of the counter. It was bolted to the counter timbers with 7/8 in. (2.2 cm.) diameter iron clench bolts.<sup>139</sup> The seat transom was at the height of the lower port sills and was so named because there was usually a bench built under the stern ports and windows. It was 4½ in. (11.4 cm.) thick, about 12 in. (30.5 cm.) broad, and was scored and bolted to the stern timbers. It was secured to the sides by two knees fastened with 7/8 in. (2.2 cm.) diameter iron bolts.<sup>140</sup> The quarterdeck transom was 7 in. (17.8 cm.) deep, and was scored and bolted to the stern timbers and kneed at each end. The fore and aft arms of the knees were long enough to receive iron bolts forward of the gallery doors.<sup>141</sup>

Riders were interior ribs or frames that reached from the keelson to the lower deck beams.<sup>142</sup> However, the *Shipbuilder's Repository* does not give dimensions for floor riders or futtock riders for ships below 64 guns.<sup>143</sup> Furthermore, no riders are represented on the drafts of *Diana* or *Pandora*. Therefore it is reasonable to conclude that *Pallas* did not have riders.<sup>144</sup>

### I. External Planking

The overall integrity of the hull construction was dependent upon the quality of the planking. As with the ceiling, the planking process began at the bottom of the hull and worked

upwards (with the exception of the previously-fitted main wales). For ease of planking the garboard and second strake were usually left out until the end. This also facilitated clearing the hull of construction debris. Planks of uniform length were carefully fashioned to bring as many strakes as possible to the stern; however, the shape of the stern rarely permitted this, requiring some strakes to be 'dropped' or terminated short of the post. Furthermore, the curvature at the bow often required the placement of 'stealers' or short filling planks worked in between the existing strakes.<sup>145</sup> However, neither *Diana* nor *Pandora* is depicted as having drop strakes or stealers.<sup>146</sup> The planking was usually English oak (sometimes elm was used near the garboard) laid in parallel strakes. The strakes were composed of 25 ft. (7.62 m.) long planks with squared butt ends that were butted over frames to facilitate fastening. They maintained the same thickness as the upper edge of the garboard strake all of the way up to the diminishing strake.<sup>147</sup> *Charon* had 3 in. (7.6 cm.) planking near the garboard and both *Diana* and *Pandora* are depicted as having planking about 3 in. (7.6 m.) thick.<sup>148</sup> The strakes were fastened to the hull with iron clench bolts at the butts and 1½ in. (3.8 cm.) diameter treenails through every frame.<sup>149</sup> Ollivier observed that the hull planking was fastened entirely with treenails and that no iron nails or iron bolts were used.<sup>150</sup> It is possible that this was the case in 1737 when Ollivier visited England, but it is more likely that he simply observed a much greater number of treenails being used than were employed in French shipyards and overlooked the relatively few iron clench bolts employed at the butts.

Directly below the main wale were three rows of diminishing strakes that transitioned from the thickness of the wale to the thickness of the planking. They were assembled from parallel strakes 25 ft. (7.62 m.) long and 10 to 12 in. (25.4-30.5 cm.) wide.<sup>151</sup> Directly above the wales was a strake, known as the black strake. Like the diminishing strakes, it transitioned the thickness from that of the wales to that of the planking. It was 11 to 16 in. (27.9-40.6 cm.) wide

and about 1 in. (2.5 cm.) thinner than the wale. It was assembled with butts shifted away from the scarfs of the wale, and from the gun ports.

The strakes between the main wale and the waist rail were about 3 in. (7.6 cm.) thick and cut to fill the distance to the waist rail.<sup>152</sup> The waist rail was about 6 in. (15.2 cm.) wide, was set about 21 in. (53.3 cm.) below the top-timber line, and ran parallel to the sheer. It extended the full length of the side but was interrupted by gun ports except at the very stern.<sup>153</sup> The strakes between the waist rail and the sheer rail were referred to as sheer strakes. Along with the string of the waist, they provided most of the topside longitudinal strength and therefore were thicker than the normal external planking.<sup>154</sup> The sheer strakes on *Pallas* were 4 in. (10.2 cm.) thick.<sup>155</sup> The sheer rail ran the full length of the side along the top-timber line and was approximately the same width as the waist rail. Goodwin states that the channels interrupted the sheer rail. However, the drafts of *Brilliant* show the channels seated into notches cut into the underside of the sheer rail. The drift rails ran parallel to the sheer rail and stood slightly proud of the quarterdeck and forecastle decks respectively. Because the quarterdeck rises away from the sheer line, it was necessary for the aft drift rail to step up about 12 in. (30.5 cm.) a short distance aft from the fore edge of the quarterdeck. The fife rail ran parallel to, and about 9 in. (22.9 cm.) above, the drift rail. It was 2 to 3 in. (5.1-7.6 cm.) thick and had tenons cut to allow the timberheads to pass through.<sup>156</sup> The planking of the stern and counters was 8 in. (26 cm.) wide and 2½ in. (6.3 cm.) thick. It extended across the stern and was only interrupted by the stern ports and the helm port. The beakhead bulkhead was planked in the same fashion.<sup>157</sup>

The garboard strakes were made of English oak cut in 25 ft. (7.62 m.) lengths, 9¼ in. (23.5 cm.) wide, and fastened together in the same fashion as the other external planking. According to Peter Goodwin they were 7 in. (17.8 cm) thick at the lower edge and tapered to 3½ in. (8.9 cm.) thick at the upper edge.<sup>158</sup> They were bearded to fit the rabbet of the keel and the

joint was caulked and payed. The Admiralty drafts of *Brilliant* do not agree with Goodwin's calculations and neither do the drafts of *Diana* and *Pandora*. All three examples suggest a much more uniform garboard, tapering only slightly from lower to upper edge.<sup>159</sup>

#### J. Bitts, Partners, Capstans, and Mast Steps

Before the decks were laid the bitts, capstans and mast steps were installed.<sup>160</sup> The riding bitts were a heavy framework of timber, stoutly fixed to the structure of the ship, used to secure cables and ropes. They straddled the centerline of the ship just aft of the foremast, and were composed of a double set of bitt pins passing down through the lower deck and orlop deck, and were bolted through the deck beams. The bitt pins were further buttressed by standards about two-thirds the width of the pins, bolted through the forward face and down through the lower deck beams. The after faces of the bitt pins were scored 2 ½ in. (6.3 cm.) deep about 18 in. (45.7 cm.) above the gun deck and heavy transverse cross beams were bolted to them.<sup>161</sup> The riding bitts on *Pallas* are prominently portrayed on Slade's construction drawings providing both placement and dimensions (Figs. 5 and 11).<sup>162</sup>

The aft bitt-pins were 13 in. (33 cm.) square from the heads to about 6 in. (15.2 cm.) below the lower deck. From there, they tapered to about 10 in. (25.4 cm.) square where they were stepped into the footwaling. The fore bitts were more lightly constructed, being about 11 in. (27.9 cm.) square and terminating at the orlop deck. They were scored 2 in. (5.1 cm.) into the aft face of the deck beams and secured with two 1 in. (2.5 cm.) iron bolts. The heads of both sets of bitts stood 52 in. (132.1 cm.) above the deck. The distance between the heads of the bitts athwartship was 38 in. (96.5 cm.). The cross beams of the bitts were 14 in. (35.6 cm.) fore and aft and 12 in. (30.5 cm.) deep. The aft face of each cross beam had an additional elm cladding 5 in. (12.7 cm.) thick. The standards of the bitts were sided 10 in. (25.4 cm) and notched into the

decking 1 in. (2.5 cm.). The vertical arms reached the height of the upper edge of the crossbeams. The fore and aft arms of the forward bitt standards reached the beam immediately before the foremast and, with the carlings below, formed the foremast partners. The fore and aft arms of the aft bitt standards butted against the aft face of the forward bitt pins. All of the standards were fastened to the beams and carlings with 1 in. (2.5 cm.) diameter iron bolts.<sup>163</sup>

Topsail and jeer bitts were the primary belaying points for securing running rigging. They typically consisted of heavy bitt pins, although much lighter than the riding bitts, secured to the deck beams, and had cross beams or pin rails for tying off ropes. The main topsail and jeer bitts were mounted on the upper deck fore and aft of the mainmast respectively. The bitt pins passed through the upper deck and were stepped into the lower deck; the pins for the jeer bitts also supported the foremost quarterdeck beam. The bitt pins were 11 in. (27.9 cm.) square. The cross pieces to the bitts were 5½ in. (14 cm.) deep, 7½ in. (19 cm.) wide, and were scored 1½ in. (3.8 cm.) onto the bitt pins. The cross pieces to the gallows were 8 in. (20.3 cm.) wide, 14 in. (35.6 cm.) deep, and 10 ft. (3.05 m.) long. The upper side was 6 ft. 5 in. (1.96 m.) above the deck.<sup>164</sup> The fore topsail and jeer bitts were mounted on the forecastle fore and aft of the foremast respectively. The bitt pins passed through the forecastle deck and were stepped into the upper deck. The bitt pins were 9 in. (22.9 cm.) square. The cross pieces were 5 in. (12.7 cm.) deep, 7 in. (17.8 cm.) wide, and scored 1 in. (2.5 cm.) onto the bitt pins. Their heads were 39 in. (99.1 cm.) above the deck.<sup>165</sup> No information was available regarding the dimensions of the brace bitts. It seems that they could be positioned either forward or aft of the mizzenmast on the quarterdeck and, because they were not tied to the deck beams, usually had standards supporting each bitt pin. The standards were always placed on the side of the bitts away from the mast.<sup>166</sup>

Mast steps were usually cut from a single large piece of oak. They were notched on the underside to sit over the keelson and had a mortise cut in the upper surface to receive the tenon



on the mast's heel. The placement, fore and aft siding, and depth dimensions of the mast steps are represented on Slade's construction drafts (Fig. 5). The main mast step was sided 27 in. (68.6 cm.) and was 24 in. (61 cm.) high.<sup>167</sup> The athwartship dimension is unknown but Goodwin states that it must slide clear of the stanchions of the pump well. The foremast and mizzenmast steps both took the form of additional crutches. The fore mast step was sided 23 in. (58.4 cm.), molded 24 in. (61 cm.) amidships, and was 8 to 10½ ft. (2.44-3.2 m.) long athwartship. The mizzenmast step was sided 15 in. (38.1 cm.), molded 24 in. (61 cm.) amidships, and the athwartship arms were each 5 ft. 6 in. (167.6 cm) long.<sup>168</sup> The step of the bowsprit was composed of two pieces of oak 10 in. (25.4 cm.) thick, rabbetted into each other and bolted through with two 1 in. (2.5 cm.) diameter iron bolts. Exact information could not be found regarding the athwartship breadth of the bowsprit step, but it was probably about 3½ ft. (1.07 m.). The step reached from the lower deck beam directly before the foremast to the upper deck beam above, was notched into both, and secured to the beams with 1 in. (2.5 cm.) diameter iron bolts.<sup>169</sup>

The longitudinal mast partners were essentially oversized carlings on either side of the mast. The foremast partners on the lower deck were 13 in. (33 cm.) wide and 8 in. (20.3 cm.) deep. The standards for the foremost riding bitts composed the upper portion of the partners, and rabbets were cut into the upper surface deep enough to receive cross chocks 5 in. (12.7 cm.) thick. The main mast partners on the lower deck were 14 in. (35.6 cm.) wide and 13 in. (33 cm.) deep. Their upper sides stood 6 in. (15.2 cm.) proud of the deck beams and were bolted through with 1 in. (2.5 cm.) diameter iron bolts. Rabbets were cut into the upper surface deep enough to receive cross chocks 6 in. (15.2 cm.) thick. The mizzen partners on the lower deck were 5 in. (12.7 cm) thick and 38 in. (96.5 cm.) wide.<sup>170</sup> The foremast partners on the upper deck were 12 in (30.5 cm.) wide and 7 in. (17.8 cm.) deep.<sup>171</sup> The mainmast partners on the upper deck were 15 in. (38.1 cm.) wide, 14 in. (35.6 cm.) deep, and their upper sides were 6½ in. (16.5 cm.)

above the deck beams. The mizzen partners on the upper deck were 4½ in. (11.4 cm.) thick and 4 ft. 6 in. (1.37 m.) wide.<sup>172</sup> The partners to the capstans were 5 in. (12.7 cm.) wide and 5¼ in. (13.3 cm.) deep.<sup>173</sup>

The capstans were heavy mechanical winches whose primary function were to haul in or veer out the anchor cables, but they would have also been employed for other heavy lifting such as raising masts and yards, moving heavy loads into the holds, and winding or kedging the ship (Fig. 20). The two double capstans on *Pallas* are prominently portrayed on Slade's original construction plans providing both absolute placement and dimensions (Fig. 5 and 11).<sup>174</sup> Double capstans consisted of two central barrels mounted on a spindle that passed between the upper and lower decks and were firmly secured to the deck beams of both. A 'drumhead' was mortised to the top of the barrel, at about chest height on the upper deck, and a 'trundle head' was fixed to the barrel at the same height on the lower deck. Mortises 3½ to 4½ in. (8.9-11.4 cm.) square were cut into the edges of each, typically twelve in the drumhead and ten in the trundle head, into which capstan bars could be inserted to turn the capstan. Flat timbers called whelps radiated from the barrel (six on the upper and five on the lower) and served to increase the diameter of the barrels and hold cables more securely. They were shaped to prevent the cables riding up too far and interfering with the men pushing the bars. At the base of the capstan there was a simple ratchet device called a 'pawl ring' that prevented the capstan from 'walking back' or loosing ground. The barrels of *Pallas*' capstans were 20 in. (50.8 cm.) in diameter; the heads were 45 in. (114.3 cm.) in diameter and 9 in. (22.9 cm.) thick, and the whelps were 10 in. (25.4 cm.) thick. The capstan bars were made of English ash. They were 11 ft. 11¼ in. (3.65 m.) long, 3½ to 4½ in. (8.9-11.4 cm.) square, and had a slot cut into the outer end, about 1/3 the width of the bar, to receive the 'swifter.' The swifter was a rope rigged around the periphery of the capstan bars that secured all of the bars in place and permitted additional men to work the capstan when needed.

For more specific detail both Lavery and Goodwin offer comprehensive studies of the historical evolution and mechanics of capstans and their related accessories.<sup>175</sup>

*Pallas* carried 10 cables: seven 100 (189.9 m.) fathoms long and 16½ in. (41.9 cm.) in circumference, one 100 fathoms (189.9 m.) long and 9½ in (24.1 cm.) in circumference, one viol 44 fathoms (80.5 m.) long and 10 in. (25.4 cm.) in circumference, and one messenger 44 fathoms (80.5 m.) long and 10 in. (25.4 cm.) in circumference.<sup>176</sup>

#### K. Decking

The decking was typically laid in parallel strakes from the centerline of the ship outwards. The strakes were about 25 ft. (7.62 m.) long and 9 to 12 in. (22.9-30.5 cm.) wide depending on their location and the curvature of the sides. Deck planking was made from oak, elm, or Prussian or ‘Danzig’ deal (high quality Baltic pine). Oak was used near the ship’s sides, and around capstans and hatchways where strength was required, elm or deal was used for the remainder.<sup>177</sup>

The upper deck was the first to be planked so that work could continue uninterrupted by weather. The decking was worked around the various openings, and oak coamings and head ledges were installed around the hatches, gratings, ladder ways, and scuttles to keep water from reaching the decks below. The head ledges were 5 in. (12.7 cm.) wide, the coamings were 6 in. (15.2 cm.) wide, and both were 9 in. (22.9 cm.) high (Fig. 5 and 17). Outboard of the hatch coamings, on either side of the ship, three courses of binding strakes were laid. Unlike the other decking they were notched down over the deck beams binding them together and contributing to the longitudinal strength of the hull. They were probably oak, cut 10 to 14 in. (25.4-35.6 cm.) wide at midship and narrowing towards the bow and stern. They were 4 to 4 ½ (10.2-11.4 cm.) thick and were notched 1 to 1 ½ in. (2.5-3.8 cm.) onto the beams. The next fourteen courses of

planking were fir or deal, cut 3 in. (7.6 cm.) thick and 6¾ to 7 in. (17.1-17.8 cm.) wide at midship, and narrowing towards the bow and stern. The binding strakes were composed of 25 ft. (7.62 m.) long planks joined with butts located over deck beams. They were laid in courses of four strakes in a specific pattern so that each butt was shifted one beam away from the previous butt (Figs. 16, 17 and 19).<sup>178</sup> The outermost plank, parallel to the ship's side and waterways, was called the margin plank. Notched to receive the butt ends of diminishing decking strakes, its purpose was to prevent the need for these strakes to be tapered to a point where they met the side of the ship (Fig. 16). On White's reconstruction of *Diana*, he has combined the margin strakes and waterways into single strakes 15 in. (38.1 cm.) wide. This may not have been the case on *Pallas* but the *Diana* reconstruction was the only reasonable parallel found that provided decking detail.<sup>179</sup> Once the upper deck planking was completed, a large timber called the collar beam was placed on top of the decking athwartship between the two foremost frame timbers. It was probably the same dimensions as the other upper deck beams. The collar beam's primary function was to serve as a footing for the beakhead bulkhead, but it also provided additional support to the underside of the catbeam. It had eight 4½ in. (11.4 cm.) square mortises cut into its upper face to step the stanchions of the beakhead bulkhead.<sup>180</sup>

The decking on the lower deck was carried out in a similar manner. The head ledges were 5 in. (12.7 cm.) wide and the coamings were 7½ in. (19 cm.) wide. Because they were below deck, the head ledges and coamings were only 3 in. (7.6 cm.) high, except for those around the bread room scuttle, which were 7½ in. (19 cm.) high. The three binding strakes were 12 in. (30.5 cm.) wide at midship, 3½ to 4 in. (8.9-10.2 cm.) thick, and were notched down onto the deck beams 1 to 1½ in. (2.5-3.8 cm.). The next eight strakes were 8 to 8½ in. (20.3-21.6 cm.) wide at midship and 2½ in. (6.3 cm.) thick. The outer two courses of planking on the lower deck were composed of double strakes of oak 12 in. (30.5 cm.) wide and assembled top and butt

fashion. Like the upper deck, the margin plank and waterways were combined into a single strake 21 in. (53.3 cm.) wide.<sup>181</sup>

The planking on the forecastle and quarterdeck was much more basic. The head ledges were 4½ in. (11.4cm.) wide and the coamings were 5-6 in. (12.7-15.2 cm.) wide. They were only 3 in. (7.6 cm.), high except for those around the captain's cabin skylight, which were 4½ in. (11.4 cm.) high. The decking was composed of forty uniform strakes about 8 in. (20.3 cm) wide at the midship end and tapering towards the bow and stern. The forecastle strakes were 2½ in. (6.3 cm.) thick and the quarterdeck strakes were 3 in. (7.6 cm.) thick. Like the upper and lower deck, the margin plank and waterways were combined into a single strake 9 in. (22.9 cm.) wide. All deck planks were fastened to the deck beams and carlings with iron spikes, dumps or treenails.<sup>182</sup>

Once the forecastle was decked, the catheads were installed. Catheads were strong timbers projecting out over both sides of the bow from the forecastle, providing clearance for the anchor flukes when raising and lowering the anchor. They had three sets of sheaves at the end of each arm to which the cat block was rigged. The catheads were 14 in. (35.6 cm.) fore and aft and 12 in. (30.5 cm.) deep. The steeve of the catheads can be determined from Slade's drafts. The inner arms of the cathead rested on the forecastle and were bolted to the foremost forecastle deck beam or catbeam. The outer arms were supported from underneath by a hanging knee that transitioned into the rail of the beak head.<sup>183</sup>

The planking on the orlop decks differed from the other decks. Rather than being laid in 25 ft. (9.45 m.) lengths over several deck beams, the orlop planks were cut into short, easily removable planks that filled the spaces between beams. They were seated onto ledges cut into the forward and after edges of the beams, but were not secured into place. This allowed convenient access to stores in the hold beneath. The planks were 9 in. (22.9 cm.) wide and 1 in.

(2.5 cm.) thick, and battened together into pallets that could be easily shifted or removed. Removable gratings were also frequently used in the orlop decking to provide ventilation and light to the hold.<sup>184</sup>

In the open space between the fore and aft orlop decks, there were five additional transverse beams that supported the cable tier where the ship's large cables were stored (Fig. 5). The cable tier was an open platform, centrally located low in the ship, where the cables could drain into the bilges while remaining easily accessible. It extended from the deck beam immediately abaft the pump well to just under the forward capstan. It was decked in a similar fashion to the other orlop platforms. Additional beams 4 to 6 in. (10.2-15.2 cm.) square were placed over the deck to lift the cables and allow for ventilation and drainage. A row of stanchions supporting heavy wooden gratings divided each side of the cable tier to prevent the cables from shifting while still permitting ventilation.<sup>185</sup>

Access to the forecastle and quarterdeck was provided by stairs located on each side of the ship, near the bulwarks. It is unclear whether *Pallas* was ever fitted with gangways connecting the forecastle to the quarterdeck. However, it was common practice at the time to fit narrow gang boards about 18 in. (45.7 cm.) wide, supported by small wooden or iron knees, along the planksheer.<sup>186</sup>

#### L. Hatches, Gratings, Ladder Ways and Scuttles

The placement and dimensions of the various hatches, gratings, ladder ways, and scuttles are prominently portrayed on Slade's various deck plans for *Pallas* (Figs. 16, 17 and 19).<sup>187</sup> Most hatches had gratings that seated onto sills cut into the inner edge of the coamings. Gratings provided footing over the hatchways and allowed air and light to reach the lower decks. In poor weather they could be covered with canvas to keep out water. Some gratings were permanent like

the steam grating over the stove; others like those over the main hatches were only removed during loading or unloading. The gratings for the ladder ways were removed during the day but were usually replaced at night. They consisted of a lattice of ledges crossed by battens. The ledges were usually about 3 in. (7.62 cm.) square and were oriented athwartship. The battens were the same width but only about  $\frac{3}{4}$  in. (19 cm.) deep except for those at the edges that formed the frame of the grating. They were notched into the top of the ledges to their full depth leaving 3 to 4 in. (7.62-10.2 cm.) square holes in the lattice. Like the decks, the gratings were cambered towards the centerline of the ship, as were the head ledges.<sup>188</sup>

#### M. Pillars or Stanchions

Pillars or stanchions were placed under the deck beams to support the decks above. The exact number and placement on each deck is unclear. However, Ollivier states that pillars supported nearly all of the gun deck beams.<sup>189</sup> On the other decks they were probably placed under every second deck beam. They were placed as close as possible to the centerline of the ship to focus the load above the keel and to leave as much room as possible free for the working of the guns, capstans, and messenger cable. They were not permanently fixed in place, but instead were stepped into mortises cut into the decking or the top of the keelson. The tenons were  $1\frac{1}{2}$  in. (3.8 cm.) square and were chamfered at the forward edge to facilitate removal and replacement.<sup>190</sup> The pillars in the hold under the orlop and gun deck beams were  $7\frac{1}{2}$  in. (19 cm.) square at the lower end and  $6\frac{1}{4}$  in. (15.9 cm.) square at the upper end.<sup>191</sup> The pillars on the upper deck were  $6\frac{3}{4}$  in. (17.1 cm.) square at the lower end and  $6\frac{1}{2}$  in. (16.5 cm.) square at the upper end.<sup>192</sup>

#### N. Quarter Galleries

The quarter galleries were mounted on either side of the extreme stern. They provided light to the great cabin, allowed the captain to observe the sails without going on deck, and the portside gallery served as the captain's private head.<sup>193</sup> They were not structurally fixed to the hull, but instead were supported by stout ornately carved oak brackets, called the lower finishings, bolted to the ship's sides. The floor platforms or 'stools' were constructed of 3 to 4 in. (7.6-10.2 cm.) thick planks bolted together and cut to the floor plan of the gallery. The stools continued the camber of the main deck, and the inner edges were chamfered to meet the angle of the ship's sides. The stools were secured to the tops of the lower finishings with iron dumps driven through from above. This formed the foundation for the gallery structure. Next, vertical timbers called quarter posts were erected at the aft outboard corners of the stools and bolted into position. The quarter posts were assembled in the same fashion as the counter timbers. They continued the shape of the counters to the extremities of the galleries and were supported by a series of molded rails worked across the aft faces of the stern counter timbers. The upper stools or 'deck heads' were constructed in the same manner as the lower stools and were bolted to the quarter posts and the sides of the ship. The upper finishings were shaped to conform to the ship's sides and bolted to the stools and the sides. A single quarter rail was installed between the quarter posts and the forward edge of the galleries on each side, about 18 in. (45.7 cm.) above deck level. They were about 12 in. (30.5 cm.) wide and 8 in. (20.3 cm.) deep, and the inboard edges were rabbeted to form the lower windowsills. Another lighter quarter rail was mounted beneath the deck heads on each side and rabbeted to form the upper windowsills. The area between the lower stools and the quarter rails was planked horizontally with planks 4 to 6 in. (10.2-15.2 cm.) wide and 1½ to 2 in. (3.8-5.1 cm.) thick. The windows and mullions between them were installed and fixed in place with iron spikes. Typically only the middle window was



real; the fore and aft ones were false lights painted to look like windows. The same was true of the windows across the stern; the two outer windows and two chase port lids on either side of the center window were false lights.<sup>194</sup>

Once the galleries were finished the taffrail and quarter pieces could be mounted across the stern. These defined the shape of the upper part of the stern and were decorated with intricate molding and carvings. They probably also contributed structurally to the stern and quarter gallery assembly. Two additional quarterdeck chase ports were cut into the taffrail directly above the upper deck chase ports. These are clearly visible on Slade's construction draft of *Brilliant*.<sup>195</sup> Finally, the taffrail fife rail was installed across the peak of the stern.

A single stern lantern was mounted on an angled bracket projecting from the after face of the taffrail amidships. Decorative style may have varied according to the tastes of the builder but lanterns were usually made from iron or brass, gilt or painted, with glass panes. They were hexagonal in shape, tapering slightly towards the base. The lantern typically housed an oil lamp the burned whale oil or colza (rape seed oil). A single lantern of this type can be seen on a model of the 32-gun frigate *Lowestoft*, (1761) and there is no reason to expect *Pallas* to have been very much different.<sup>196</sup>

#### O. Rudder and Tiller Assembly

The overall shape and dimensions for the rudder can be seen on Slade's draft of *Pallas*' sister ship, *Brilliant* (Fig. 3).<sup>197</sup> Specific details for the rudder fittings proved more difficult to locate; however, all of the most reliable sources, extant period models, and period iconography agree that rudders and rudder fittings on British ships of the line changed very little between 1650 and 1800.<sup>198</sup> White's reconstruction was chosen as an acceptable parallel for *Pallas*.<sup>199</sup>

Although *Diana* is considerably later than *Pallas*, her rudder details differ very little from those seen on a 1732 model of the 44-gun *Centurion*.<sup>200</sup>

The rudder on *Pallas* was made from four parts. The 'main piece' was the primary structural element. It was of oak, had the same siding as the sternpost and extended the full length of the rudder. The fore piece or 'bearding' was made of elm and extended from the base to about half the height of the rudder. It was beveled 45 degrees on both its fore edge to allow for the movement of the rudder. The two after pieces were made of fir and gave fore and aft breadth to the foot of the rudder. At the foot and the after face, narrow fir strips were fixed to protect the assembly from damage. The rudder head was square with rounded corners and was bound with four iron straps 3 to 4 in. (7.6-10.2 cm.) wide and  $\frac{1}{2}$  to  $\frac{3}{4}$  in. (1.3-1.9 cm.) thick. The rudder was mounted to the sternpost with six hinges or gudgeons. Notches were cut into the rudder's bearding at the height of each gudgeon and the pintles were set flush with the fore edge. The pintles were  $2\frac{3}{4}$  in. (7 cm.) in diameter and 11 in. (27.9 cm.) long, and the sockets in the gudgeons were the same diameter. The pindle straps were  $3\frac{3}{4}$  in. (9.5 cm.) wide, were only slightly shorter than the full breadth of the rudder assembly at their respective stations, and served to bind the whole structure together. The gudgeons were mounted over the sternpost and stern planking, the arms splayed to conform to the shape of the stern. The gudgeon arms were  $3\frac{3}{4}$  in. (9.5 cm.) wide and the arm length depended on the height at which they were set. The lowest had arms 5 ft. 10 in. (1.78 m.) long; the length diminished towards the rudder head to 3 ft. 8 in. (1.12 m.) long at the second uppermost gudgeon. The head of the 'main piece' had two tiller holes. The tiller was normally mounted in the lower hole and passed through the helm port just below the gun deck transom. The upper tiller hole could be accessed through the rudder head cover in the great cabin if an auxiliary tiller needed to be rigged (Fig. 5).<sup>201</sup>

The tiller was made of oak, ash, or pine; ash was preferred due to its flexibility. It was 19 ft. (5.79 m.) long, 9½ in. (24.1 cm.) square at the widest point, and 7½ in. (19 cm.) square at the foremost end.<sup>202</sup> It swung just below the upper deck beams and was suspended from the quadrant or sweep by a gooseneck bracket at its forward end. The sweep was a curved track or race fixed under the deck beams beneath which the fore end of the tiller traveled. In the forward face of the sweep a groove was cut and set with *lignum vitae* or iron rollers to allow for the travel of the tiller ropes. A shelf was cut along the after face of the sweep along which the gooseneck of the tiller traveled. Two iron bands, with two eyebolts each, were fitted around the forward end of the tiller and two more were fixed to the sides of the tiller about two-thirds the distance to the rudder head.<sup>203</sup> All sources agree that the rigging of the tiller ropes and tensioning tackle on large warships was consistent throughout the 18<sup>th</sup> century.(Fig. 21).<sup>204</sup>

#### P. Head

The knee of the head was a large flat bracket extending forward from the stem of the ship that supported the head and provided a rigid foundation for the bowsprit, gammoning and the bobstays (Fig.6). The shape and sided dimensions of the knee of the head can be clearly seen on Slade's drafts of *Brilliant* (Fig. 3). The molding was 12½ in. (31.7 cm.) at the stem just above the cheek. It was assembled from six pieces of oak coaked or tabled and bolted together: the lacing, the choke piece, the gammon piece, the gammoning knee, the bobstay piece, and the gripe. At the base of the knee of the head, the gripe was notched into the leading edge of the keel and keelson and secured to both the stem and keel with horseshoe plates placed on either side and bolted together through all three.<sup>205</sup>

Next, the cheeks were attached. The cheeks were two large double sets of oak knees that gave lateral support to the knee of the head and formed the foundation of the head. They also

contributed to the ornamentation, forming a graceful transition from the knee of the head to the sides of the ship just below the hawseholes. The area between the cheeks was closed with filling pieces, and timbers called wash cants further contoured the flat faces on the underside of the cheeks. Finally a contoured bolster was placed around each of the hawseholes.

Once the knee of the head and the cheeks were attached, the head was assembled. The head was the open working area forward of the beakhead bulkhead and above the bowsprit and cheeks of the bow. It was composed of a complex assembly of relatively lightweight timbers whose purpose was as much aesthetic as functional. The lower rail and head rail formed a gracefully rising triangular basket, crossed by transverse head timbers, and floored with a mesh of carlings and ledges. The shape and dimensions of the head from the sheer perspective are clearly visible on Slade's draft of *Brilliant* (Fig. 3). A similar example can be seen in White's reconstruction of *Diana*. Within the head on either side of the bow were two circular toilet facilities that projected over the edge of the bow. Further forward, out over the water and on either side of the bowsprit, were two more open-air seats of ease.<sup>206</sup>

Finally, the figurehead was installed. The figurehead was the primary focus of the ship's ornamental motif and was usually symbolic of the ship's name. The name *Pallas* most likely refers to the Greek goddess Athena, but it could also be a reference a mythological titan of the same name. Figureheads were gilded until 1760 after which they were painted with bright colors. Presumably, *Pallas* would have had a gilded figurehead when launched in 1757, however it is possible that it was refinished with paint at a later date.<sup>207</sup> The figurehead was mounted against the fore edge of the main piece, atop the bobstay piece and bolted to both.

As work progressed, caulkers went to work on the areas already completed. All of the ship's external planking and decking was caulked inside and out. This was done by forcing oakum—strands of old rope covered with pitch or resin—into every seam. Once this was done

the ship's bottom was graved with 'black stuff,' 'white stuff,' or 'brown stuff'—various mixtures of tar, pitch and brimstone—and the hull was ready to launch. *Pallas* was launched before the advent of copper sheathing, but was coppered later in her career. The coppering will be discussed below. Finishing work was usually carried out after launch enabling shipyards to free up the slipways for new hulls to be started.

### Finishing and Fittings

#### A. Bulkheads

Bulkheads were the various partitions that separated one part of the ship from another. Slade's construction drafts provide his recommended locations and dimensions for the various bulkheads and compartments on *Pallas*. Furthermore, the functions of the individual compartments are clearly labeled on the deck plans.<sup>208</sup> Above the waterline the bulkheads were little more than lightweight screens made of canvas stretched over batten frames. This facilitated their swift removal and stowage in the hold when clearing for action.<sup>209</sup>

The berthing deck contained the various officers' cabins and the pantry, all placed on either side of the ship in the stern. The four cabins on the starboard side housed the carpenter, 1<sup>st</sup> lieutenant, master, and gunner. The four on the port side housed the boatswain, 2<sup>nd</sup> lieutenant, surgeon, and purser. In the center of the stern, built around the mizzenmast, was the pantry where special food items were kept secure from the crew. There was no enclosed wardroom on *Pallas*, but the space between and aft of the cabins would have served as the officers' mess and social area. In the extreme stern, aft of the pantry, was the scuttle to the bread room (Fig. 17).<sup>210</sup>

On the upper deck the only substantial bulkheads defined the captain's cabins in the stern. These included the captain's coach (administrative office) just aft of the mizzenmast on the port side, his bedroom on the starboard side, and the great cabin extending the breadth of the

ship in the stern. Slade's drafts also show a small partition with double doors just aft of the stove under the forecastle. This was almost certainly a windbreak to shelter the stove, cook, and food from the elements.<sup>211</sup>

The bulkheads below the waterline were permanent and more substantial. The principle compartments in the hold were the magazine, shot locker, fish room, bread room, and spirit room. The aftermost bulkhead was placed at the aftermost beam of the orlop deck creating the bread room in the extreme stern. It was constructed of pine planking 6 in. (15.2 cm.) wide, and 3 in. (7.6 cm.) thick, worked horizontally over a series of pine or oak stanchions, 4 to 6 in. (10.2-15.2 cm.) square and tenoned into the orlop beam above and the ceiling planking below. The planks were rabbetted along their edges and battens were worked over the seams to keep water out. Raised palleting, assembled from ledges and battens in the same fashion as the hatch gratings, was laid on the floor to help keep the bread dry. Access to the bread room was from above through the scuttle in the berthing deck. The remaining bulkheads were constructed in the same manner. The fore bulkhead of the fish room formed the aft bulkhead of the spirit room and the fore bulkhead of the spirit room formed the aft bulkhead of the main hold.<sup>212</sup> The forward part of the hold was devoted to the magazine, which will be addressed in a separate section below.

On the orlop deck were individual storerooms for the various ships' fittings. The bulkheads were built in much the same manner but were of lighter construction than those in the hold. The stanchions were 4 in. (10.2 cm.) square, and were constructed of fir or pine. The planking was 8 in. (29.3 cm.) wide and 1½ in. (3.8 cm.) thick. It was rabbetted like the bulkhead planking in the hold, and was also quite often rabbetted into the outer edges of the stanchions as well. On the starboard side of the fore orlop deck, working forward, were the block room and the carpenter's storeroom. On the port side were the boatswain's storeroom and a sail room.

Between these storerooms and above the magazine was another sail room. An enclosed passageway led around the starboard side of the central sail room to a stairwell that provided access to the magazine below. Another passageway on the port side led beyond the central sail room, past the light room for the magazine, to the gunner's storeroom in the extreme bow. On the starboard side of the after orlop deck were the slop room and, further aft the steward's room. On the port side were the marine's clothing room and the captain's storeroom. Situated in the floor between the aft storerooms were hatchways to the fish room and spirit room.<sup>213</sup>

#### B. Magazine

Magazines were closed storerooms in which the ship's powder was kept. They were strongly secured against both fire and moisture. The bulk of the powder was stored in barrels or casks in the magazine. At the forward end of the magazine, elevated a little above the palleting was the filling room where cartridges were filled and stored. Both rooms were lighted through glass windows or light scuttles from an adjacent and securely isolated light-room. The magazine on *Pallas* was located just aft of the foremast. The exact placement, layout and dimensions of the magazine are clearly depicted in Slade's construction drafts (Figs. 5 and 18).<sup>214</sup>

The floor of the magazine was elevated above the bottom of the hold and supported by a series of transverse beams. Pine planking 12 in. (30.5 cm.) wide and 3 in. (7.6 cm.) thick was laid across the beams and fastened with copper dumps. On top of this the palleting flat was assembled. A lattice of beams and carlings, each 4½ to 4¾ in. (11.4-12.1 cm.) square, were notched together dividing the floor into 3 ft. (91.4 cm.) square compartments or scuttles 4½ to 4¾ in. (11.4-12.1 cm.) deep. A 1 to 1 ½ in. (2.5-3.8 cm.) deep rabbet was cut into the upper edges of each scuttle. Covers were assembled from four 3 ft. (91.4 cm.) long, 9 in. (22.9 cm.) wide and 1 to 1 ½ in. (2.5-3.8 cm.) thick pine planks battened together. The covers were not

fastened down, allowing access for the removal of accumulated loose powder. Goodwin states that the scuttles were left empty to enable airflow to cool the magazine. Lavery states that the scuttles were filled with charcoal to absorb moisture.<sup>215</sup>

The athwartship bulkheads of the magazine were constructed in the same fashion as the other bulkheads in the hold. Rabbetted planks 2 in. (5.1 cm.) thick were laid over stanchions 4¾ in. (12.1 cm.) square, tenoned into the deck beams and ceiling, and the seams were covered with thin battens to keep out moisture. The side bulkheads were constructed differently. Stanchions 12 in. (30.5 cm.) fore and aft and 6 in. (15.2 cm.) wide were placed approximately 27 in. (68.6 cm.) apart. Paneling 3 in. (7.6 cm.) wide was then worked into rabbets cut in the fore and aft faces of each stanchion.<sup>216</sup> The whole structure was plastered and single lined with slit deal on the outside and plastered and double lined with slit deal on the inside. All exposed metal capable of causing a spark was puttied over.<sup>217</sup> Access to the magazine was through a door on the orlop deck leading to a ladder down to the filling room. Just above the door was a small scuttle through the lower deck between the aft most riding bit pins (Figs. 17 and 18).

### C. Shot Lockers

The shot lockers were placed directly before and abaft of the pump well and the main mast. The reason for this was to keep the weight of the shot as low and as close to the midship centerline as possible. The pump well on *Pallas* was 6 ft. 8 in. (2.03 m.) square. The four bulkhead stanchions that formed the corners of the pump well were 6 to 8 in. (15.2-20.3 cm.) square and were tenoned to the ceiling of the hold and the orlop deck beams above. The shot lockers shared the athwartship bulkheads of the pump well, were 22 to 24 in. (55.9-61 cm.) fore and aft, and about 6 ft. (1.83 m.) high. Stanchions 6 to 8 in. (15.2-20.3 cm.) square supported the outer corners but did not reach the deck beams above. Transverse stiffening timbers 3 to 4½ in.



(7.6-10.2 cm.) square were worked across the heads of the corner timbers and across the transverse bulkheads of the well. The well and shot lockers shared common sidewalls, and all three compartments were planked as a single unit. The planking on the well bulkhead and the shot lockers was 9 in. (22.9 cm.) wide and 2½ in. (6.3 cm.) thick. The nails on the outer bulkheads of the shot lockers were canted to prevent the weight of the shot from forcing out the sides of the locker. The area between the top of the pump well and the underside of the lower deck was enclosed on all sides with horizontal louvers. Hinged panels gave access through the top of the lockers, and the planking on the fore and aft bulkheads was probably removable to provide ready access as the level of shot went down during battle. Each locker was divided vertically to store different types of shot.<sup>218</sup> Some round shot was stored in shot garlands placed between the guns; garlands were racks with round holes cut into the top to prevent the shot from rolling in heavy seas.

*Pallas* carried twenty-six hundred 12-pound round shot (1820 in home waters), one hundred and eighty-two 12-pound grape shot, seventy-eight 12-pound double shot, one thousand 6-pound round shot (700 in home waters), seventy 6-pound grape shot, seven hundred and twenty ½-pound round shot, and one hundred and forty-four ½-pound grape shot.<sup>219</sup>

#### D. Ordnance

*Pallas* was originally armed with a main battery of twenty-six 12-pound guns, 8½ ft. (2.59 m.) long, mounted on the gun deck, eight 6-pound guns, 6 ft. (1.83 m.) long, on the quarterdeck, two 7½ ft. (1.9 m.) long 6-pound, bow chase guns on the forecastle, and eight to twelve ½-pound swivel guns mounted along the forecastle and quarterdeck rails (Fig. 22). The 12-pound guns available when *Pallas* was commissioned were intended for the relatively spacious upper decks of much larger warships. They proved to be too long for the close, narrow

decks of the new frigates and within a year the Ordnance Board had introduced a specially designed, 7½ ft. (2.29 m.) version. All frigates were gradually rearmed with the new 12-pound ‘shorts’.<sup>220</sup> Gunlocks were not introduced for general use by Royal Navy warships until the late 1770’s and it is unlikely that *Pallas* was fitted with them given her age and declining condition.<sup>221</sup> Instead, *Pallas*’ gunners likely used the centuries-old linstock and slow-match to manually ignite the guns’ priming. The 12-pound guns was considered a man killer but not a ship killer, whereas the 18-pound guns that followed could inflict severe damage to any vessel. Nevertheless, the 12-pound guns remained a significant threat to small warships, shore installations, and especially merchant shipping and privateers.<sup>222</sup> By the middle of the 18<sup>th</sup> century 6-pound guns were obsolete. They were still mounted on the forecastle and quarterdecks of most warships but lacked the power to inflict significant damage.<sup>223</sup> The ½-pound swivel guns were strictly anti-personnel weapons, intended for use in close combat.

The primary purpose of the gun carriage was to support the gun. The secondary purpose was to facilitate elevation and traversing of the gun. And thirdly they absorbed the recoil and facilitated the loading process. They were constructed of elm and were always painted, usually ochre red.<sup>224</sup> Gun carriages were inefficient by design to retard the recoil as much as possible.<sup>225</sup> The design and the proportions for the carriages of each weight of gun had been firmly defined by 1725 and would remain little changed for the remainder of the century. The best near-contemporary source available to us is John Muller’s *A Treatise of Artillery*, 1780, in which there is an excellent engraved schematic of a generic naval gun carriage and its component parts (Fig. 23).<sup>226</sup> The 6-pound and 12-pound guns were both mounted on this type of carriage, the only difference being in their relative size. The ½-pound swivel guns were mounted on iron crutches inserted into fixed wooden stocks along the rails; two on each side of the forecastle and four on each side of the quarterdeck.<sup>227</sup>

Two eye bolts and two ring bolts were mounted at each gun port for the gun tackle and another single ring bolt was secured through the deck and deck beam near the centerline of the ship, behind each gun, for the train tackle. The bolts on the gun deck were 1 in. (2.5 cm.) in diameter and the rings were 4½ in. (11.4 cm.) inside diameter and those on the quarterdeck and forecastle were ¾ in. (1.9 cm.) diameter and the openings in the rings were 3¼ in. (8.9 cm.).<sup>228</sup>

Like the gun carriages, the function and arrangement of the gun tackle had been formalized early in the century and was consistent throughout all Royal Navy warships of the period. Falconer provides an excellent, nearly contemporary depiction of the guns and gun tackle in their action and storage configurations (Fig. 24).<sup>229</sup> This is supplemented by Adrian Caruana who defines in detail the various elements of the gun tackle and their role in the operation of the guns.<sup>230</sup>

It was difficult to determine the exact details of the gun port lids. However, the most common type for the period was the standard single lid, hinged to open up and out. Two hinges extended the length of the lid and served to reinforce it structurally.<sup>231</sup> Two good period examples of this type of lid can clearly be seen on a 1730s Admiralty model of a 70-gun ship and on the detail model of *Diana*.<sup>232</sup> With the exception of slight artistic differences, both examples are virtually the same in both form and function.

#### E. Pumps

Whether from leaks, rain, water washing over the deck, or simple accumulation of sea spray, all ships continuously took on water. The camber of the upper deck directed most shipped water to scuppers in the ship's sides and back to the sea. Nevertheless, some water always found its way below decks and accumulated in the bilge. Furthermore, heavy seas, or battle damage

could breach the hull below the waterline. Whatever the cause for water accumulation, all ships required an effective means of removing water from within their hulls.

Suction pumps were rarely used on larger warships where chain pumps were more efficient and manpower plentiful. However, due to the complexity of early chain pumps they were more prone to breakdown, were more difficult to repair, only capable of drawing water from the bilges, and were incapable of producing pressure. Suction pumps could be rigged to draw clean water from other sources or directly from the sea. Therefore, suction pumps were retained as auxiliaries and for secondary functions such as washing the decks and firefighting.<sup>233</sup> The pumps and pump wells from HMS *Charon* were both found to be partially intact. The wells for the suction pumps were located on either side of the keelson, just aft of the mainmast. They were constructed from a log bored out to a diameter of 2¾ in. (7 cm.). The outside was octagonal in shape and 7½ to 8 in. (19 cm.) in diameter. Four vertical channels were cut in the base to allow bilge water access to the pump bore.<sup>234</sup> No suction pumps are portrayed on Slade's construction drafts. However, like *Charon*, it is probable that *Pallas* would have had a pair of suction pumps on either side of the mainmast.<sup>235</sup>

The chain pumps are prominently featured on Slade's construction draft just aft of the mainmast (Figs. 5 and 11).<sup>236</sup> *Pallas* would have been launched with the old style chain pump but retrofitted with the improved Cole-Bentinck type introduced in 1768 (Figs. 25 and 26).<sup>237</sup> The Cole-Bentinck chain pump offered greater ease of maintenance and repair, improved reliability, and vastly superior performance. With the old type chain pump, four men could raise 1 ton of water in 81 seconds, with the new type the amount of time required to raise the same amount of water was dramatically reduced to 43½ seconds.<sup>238</sup> This is particularly pertinent given that during her final days the pumps on *Pallas* were in constant use and were largely responsible for the ultimate survival of her crew.

#### F. Ground Tackle

The navy did not manufacture its anchors, but instead purchased them from contractors (Fig. 27). Every ship had three principle anchors; the best bower, second bower, and sheet anchor.<sup>239</sup> These anchors did not vary substantially in weight, the main difference being in location and function. The bower anchors were historically the two largest anchors; the only real difference being that the best bower was on the port and the second bower on the starboard. The sheet anchor was carried for added security should the bowers fail. Very little information was found regarding the size of anchors carried by Royal Navy warships. Lavery suggests a 30 cwt. (1362 kg.) bower for a ship of 625 tons and a 45 cwt. (2043 kg.) bower for a ship of 969 tons.<sup>240</sup> The 513-ton *Pandora* carried bowers weighing 29 cwt. (1317 kg.) and the 1000-ton *Diana* carried bowers weighing 40 cwt. (1816 kg.).<sup>241</sup> Therefore, it is reasonable to assume that the 724-ton *Pallas* carried bowers weighing between 35 and 40 cwt. (1589-1816 kg.). Additional smaller anchors included the stream anchor for short-term use in light weather, and the kedge anchor used to assist in complex maneuvers across or against the prevailing currents.<sup>242</sup>

The anchor lining was a layer of sacrificial planking built up on the ship's sides to protect the hull below the catheads from the anchors. Its placement was determined by the length of the anchor shank and the arc described by the anchor while being catted. The thickness of the lining typically made up the difference between the hull planking and the wales.<sup>243</sup>

#### G. Navigation and Communication

The helm on *Pallas* was located just forward of the mizzenmast on the quarterdeck. It consisted of the wheel and the binnacle. The design, dimensions and placement of the double wheel can be determined from Slade's construction drafts.<sup>244</sup> The wheel assembly consisted of two ten-spoke wheels fixed to each end of a cylindrical wooden barrel mounted longitudinally on

the ship's centerline. An outer wooden rim reinforced each wheel about two-thirds the distance between the barrel and the ends of the spokes. The wheel assembly turned on an iron spindle suspended between two wooden brackets. The rope from the tiller passed through holes cut in the deck below the wheel and wrapped around the barrel five to seven times before returning to the tiller.<sup>245</sup>

The precise location of the binnacle is not known but it would have been midship, just forward of the wheel. The binnacle was a small wooden cabinet divided into three compartments that protected the ship's compasses against the elements. The central compartment contained a lantern and the two outer compartments each contained a compass. Glass partitions between the compartments let light from the lantern reach the compasses. The outer compartments had glass fronts but the lantern compartment did not. This permitted the helmsman to view the compasses without the light from the lantern affecting his night vision. Above the compass compartments was a drawer that contained the log lines, lead lines, and hourglasses.<sup>246</sup>

Almost all activities on an 18<sup>th</sup>-century Royal Navy warship revolved around the ship's bell; consequently it occupied a suitably prominent position on the ship. The belfry on *Pallas* was located amidships at the after end of the forecastle. It consisted of four stanchions covered by a cross-arched roof. The bell swung on an athwartship beam called the headstock that was suspended between two cross pieces fixed fore and aft between the stanchions.<sup>247</sup>

Communication between ships at sea was typically carried out with various combinations of signal flags. This consequently required that ships carried a large number and variety of flags that needed to be stored in an easily accessible location. The flag locker on *Pallas* was probably located just below the taffrail at the extreme after end of the quarterdeck.

#### H. Galley

The galley on smaller warships was usually located under the forecastle. Iron stoves of standardized dimensions were first proposed in 1728, and by 1757 had supplanted the old style brick hearth. A flat-bottomed copper kettle, rectangular in shape and divided into two unequal sections, was mounted above two separate fireplaces. The fireplaces were stoked through doors in the side and the fore fireplace contained a rack for grilling with brackets on which to mount a spit. A small oven was located between the two fireplaces. Each kettle section had a tap fitted near its bottom to drain the water and a removable lid about half the diameter of the overall kettle. The stove from HMS *Dorsetshire*, launched in 1757, conformed to new Admiralty standards issued in May of that year (Fig. 28). The stove on *Pallas* would have been identical and only a little smaller.<sup>248</sup>

#### I. Other Permanent Fixtures

Hammock cranes were U-shaped wrought iron stanchions bolted along the top of the planksheer or the inner face of the bulwarks—usually fitted on the forecastle and quarterdecks of frigates and smaller warships. They were connected together with ropes or rails to form stowage racks for hammocks. The hammock crane and hammock combination acted as a windbreak and afforded some protection to the crew while in action.<sup>249</sup>

Fenders were fixed, typically in pairs, down the outside of the hull. Their primary function was to prevent boats and cargo being hoisted aboard from damaging the wales and various rails on the side of the ship. *Pallas* had one set of double fenders on each side of the ship outboard of the main hatch.<sup>250</sup>

Frigates did not have decorative entry ports like larger warships. Access to the ship was provided by one set of steps on each side of the ship between the fenders and the break of the quarterdeck.<sup>251</sup>

#### J. Ballast

The purpose of ballast is two-fold; its primary function is to lower the center of gravity providing both stability and seaworthiness, and its secondary function is to trim the ship, compensating for the uneven distribution of guns, cargo and provisions. The amount of ballast carried by mid 18<sup>th</sup>-century Royal Navy warships varied considerably based on the ship's design and on the preferences of the captain. However, by the end of the century these amounts had been standardized based on the number of guns carried. Ballast came in two forms, iron ingots and stone shingle. The ingots were placed into 'rooms' formed by the floor riders or simply across the floor of the hold near midship. Ballast did not reach very far fore or aft of midship. Frigates carried their ballast closer to the centerline with little placed aft of the pump well. The amount of shingle carried was usually about four times the iron. The main advantages of shingle ballast were that it was far cheaper and more readily available than iron. It also provided a good stable surface on which to stow casks. Shingle was placed on top of the iron and reached both farther outboard and fore and aft.<sup>252</sup> The iron ingots, also known as 'kentledge', typically took the form of strips or 'pigs' and varied in size between 12 in. (30.5 cm.) long by 4 in. (10.2 cm.) square and 36 in. (91.4 cm.) long by 6 in. (15.2 cm.) square, with diagonal holes through the upper corners to facilitate lifting.<sup>253</sup> The ingots found on *Charon* were 36 in. (91.4 cm.) by 6 in. (15.2 cm.) square conforming perfectly to this standard.<sup>254</sup> These are identical to those observed by Ollivier over 40 years earlier.<sup>255</sup> However, the seven iron ingots found at the *Pallas* site did not conform to this standard for they measured 25½ in. (65 cm.) long, 17¾ in. (45 cm.) wide and



5¾ in. (15 cm.) thick.<sup>256</sup> Why *Pallas* would have been carrying non-standard ballast or where she got it is unclear however it was not unusual for the Royal Navy to recycle iron ballast from captured ships or other sources.<sup>257</sup>

### K. Ships' Boats

Ships' boats designed to fulfill a vast array of functions and a variety of tasks. Men-of-war rarely tied up to a pier or dock; therefore they relied on their smaller boats for communication with land and other ships. Small boats also transported a ship's provisions and stores from shore and from other ships. They carried out military duties such as cutting-out expeditions and landing troops, guns and supplies. They also played an essential role in anchoring, mooring and maneuvering the ship by kedging, warping or towing.<sup>258</sup>

The best available source concerning ships' boats is W. E. May's *The Boats of Men-of-War*. He states that from 1761 onwards 32- and 36-gun frigates carried a 23 ft. (7 m.) longboat, a 30 ft. (9.1 m.) pinnace, and a 24 ft. (7.3 m.) yawl.<sup>259</sup> In July of 1780, yawls were removed and replaced by two 24 ft. (7.3 m.) cutters. In October of 1780, the longboats on all single deck ships were replaced with 23 to 24 ft. (7-7.3 m.) launches. In June 1781, one of the 24 ft. (7.3 m.) cutters was replaced with a four-oared 18 ft. (5.5 m.) cutter.<sup>260</sup>

The longboat was the largest, heaviest, and strongest boat belonging to any ship, and was capable of carrying great weights in all weather.<sup>261</sup> Its primary function was to carry out anchors and carry large numbers of water casks while still being small enough to be hoisted aboard the ship. It had a single mast and bowsprit, was cutter-rigged, and had a davit and winch.

The launch was generally preferred to the longboat and eventually replaced it. It had less sheer and a wider stern than the longboat with a square midship section making it good for carrying large loads. Like the longboat it was cutter-rigged and carried similar fittings.<sup>262</sup>

Frigates did not carry barges. Pinnaces resembled barges but were smaller, never having more than eight oars. May suggests that the terms pinnace and barge were used indiscriminately and that the usage depended upon the size of the parent vessel.<sup>263</sup> The pinnace was narrower than the other boats and had a small transom. Typically used to carry officers, the interior was lined and paneled to afford some level of comfort. It had fittings for two masts and was probably lateen or spritsail rigged.<sup>264</sup>

Yawls were smaller than cutters but had nearly the same form and similar uses. They were originally clinker built, had a narrow transom and a rounded sternpost. They were a good sea boat and were often requested instead of longboats. In 1769, frigates on foreign service had their clinker yawls replaced with carvel-constructed versions, as they were more durable and easier to repair. By the end of the century, all yawls seem to have been carvel built. They were propelled by four, six, or eight oars, had two masts, and were lateen or spritsail rigged.<sup>265</sup>

Cutters were clinker built and similar in shape to yawls. They were broader, deeper, and shorter than barges and pinnaces and were good sailors. They were meant primarily to carry stores, provisions, and passengers to and from the ship. Like yawls, those built for foreign service were of carvel construction. They were rowed by six oars, had two masts, and were spritsail rigged.<sup>266</sup>

Because of the chronic shortage of space on large sailing vessels of all types, boat stowage was always a problem. Davits were not introduced until 1790. Until then boats were hoisted aboard using capstan and tackle and usually stacked in the waist on top of the spare spars or on top of skid beams.<sup>267</sup> Skid beams were removable beams placed across the waist of the ship on which the boats and spare spars were stored. There were usually three or four beams supported by iron crutches set at regular intervals into the planksheer.<sup>268</sup>

#### L. Hull Protection

Throughout maritime history, various coatings and claddings have been applied to the outer hulls of wooden ships to combat marine growth and damaging infestations. During the late 17<sup>th</sup> and early 18<sup>th</sup> centuries the Royal Navy experimented with many methods, including sacrificial wooden sheathing or lead sheathing used in conjunction with a variety of chemical treatments. In 1761, experimentation began with copper sheathing, which was found to inhibit *teredo navalis* or ship worm. It was relatively lightweight and had the added benefit of resisting the buildup of marine growth – thereby increasing performance while reducing hull maintenance. In July 1779, the Admiralty ordered the coppering of all ships of less than 44-guns.<sup>269</sup> The sheathing was composed of uniform copper sheets 48 in. (121.9 cm.) long and 15 in. (38.1 cm.) wide, fastened to the hull with copper tacks 1 in. (2.5 cm.) long and ¼ in. (0.6 cm.) in diameter. The sheets were overlapped 1½ in. (3.8 cm.) along the aft and upper edges to minimize water resistance (Fig. 29). The inside of each sheet was painted with white lead and thick paper and tar was placed between the sheathing and hull.<sup>270</sup> Evidence from the remains of *Charon* suggests that the sheets were up to 60 in. (152.4 cm.) long and 18 in. (45.7 cm.) wide. Curiously, the false keel on *Charon* was not coppered and neither was the underside of the keel.<sup>271</sup>

#### Spar Plan and Rigging Plan

Details regarding the rigging and fitting of warships from this period were far more difficult to obtain than the details of the hull construction. A handful of contemporary treatises, supplemented by period artwork, do provide a great deal of valuable, if general, information but rarely provide information pertaining to the rigging details of a specific vessel. Period paintings and drawings can be quite useful, but without full knowledge of the artist's background and

intent, they should be treated with some suspicion when analyzing them for specific detail.

Admiralty models can also prove very useful in determining navy standards and practices for a given period, but it must be remembered that these models were presented for consideration by the Admiralty board prior to construction; final approvals were almost always accompanied by long lists of changes to be made to the finished vessel. Several scholarly modern works on 18<sup>th</sup>-century rigging also exist. They are, for the most part, based upon analysis of the previously mentioned treatises, artwork and Admiralty models but also provide detailed drawings and descriptions for specific elements during specific timeframes.

The focus of this section is to establish, as accurately as possible, the spar plan and the standing rigging and running rigging arrangement of the frigate *Pallas*. *Pallas*-class frigates were transitional vessels in several ways. According to navy records, they were originally rigged with a lateen mizzen yard but were subsequently refitted with mizzen gaffs; *Venus* was originally constructed with a sprit topsail and a mizzen topgallant mast, and was also given a flying jibboom in 1794.<sup>272</sup> The rigging plan described here is intended to represent *Pallas* as she was first fitted out following her launch at Deptford shipyard in 1757.

#### A. Masts and Spars

The positioning of the masts on *Pallas* was determined from Slade's drafts. The same drafts also roughly show the rake of the masts and steeve of the bowsprit (Fig. 30).<sup>273</sup> The best information available from modern sources for determining the steeve of the masts comes from a set of standardized formulas described in Goodwin. He states that for 24- to 38-gun ships, the incline (in inches) per yard length of mast was 1/16 in. (1.6 mm.) for the foremast, 5/8 in. (1.6 cm.) for the main mast and 1 in. (2.5 cm.) for the mizzenmast.<sup>274</sup> From Slade's drafts of *Pallas* and *Brilliant* it is possible to determine an approximate mainmast rake of about 1½ degrees, a

mizzenmast rake of about  $1\frac{3}{4}$  degrees, and a foremast rake of less the  $\frac{1}{2}$  degree.<sup>275</sup> Goodwin does not provide an exact formula for the steeve of the bowsprit for warships contemporary with *Pallas*. But he does state that the 22-gun *Tartar* of 1734 had a bowsprit rake of 36 degrees and that 100-gun *Victory* had a bowsprit rake of 36 degrees in 1737, subsequently reduced to 30 degrees when it was rebuilt in 1765.<sup>276</sup> From Slade's drafts of *Pallas* and *Brilliant* it is possible to determine an approximate bowsprit steeve of about 30 degrees.<sup>277</sup>

The mast and spar dimensions and proportions, specifically for *Pallas* class frigates, exist to the present.<sup>278</sup> The exact taper of the masts and spars for *Pallas* do not survive. However, by the middle of the 18<sup>th</sup> century, these details were in the process of being standardized throughout the Royal Navy and by the end of the century, a number of mathematical formulas and tables of such information had emerged.<sup>279</sup> One primary source, David Steel's *Elements of Mastmaking, Sailmaking, and Rigging*, provides a series of tables defining the standardized taper of masts and spars for Royal Navy warships.<sup>280</sup> Some information, both modern and contemporary, exists regarding the fittings of the masts, bowsprits and spars of 18<sup>th</sup>-century Royal Navy warships.<sup>281</sup> Steel's treatise provides exact detailed drawings for a late 18<sup>th</sup>-century, 36-gun frigate.<sup>282</sup> It has been applied because it is a nearly contemporary source but it must be remembered that the 36-gun frigate represented in Steel's treatise is considerably larger than *Pallas*. In some cases this study follows Lees or Harland when they offered slightly different examples claiming to be chronologically closer to *Pallas*. All three of the lower masts were made from several pieces coaked together and reinforced with between six and nine rope woodings. They had no front fish and had iron hoops only around the head of the mast. There is some question as to whether *Pallas* had woodings on the mizzenmast. However, Marquardt specifically states that after 1730, frigates with less than 36 guns had no

woodings on their mizzenmast.<sup>283</sup> Since *Pallas* was a 36-gun vessel, it is reasonable to conclude that her mizzen mast did have woodings.

One of the more difficult reconstruction tasks was determining the doubling of the masts and bowsprit. The drafts in Steel's treatise, and analysis of Admiralty models of *Diana*, provided approximations for frigates from the end of the 18<sup>th</sup> century but examples from frigates dating to the middle of the century proved difficult to locate.<sup>284</sup> The most reliable and near-contemporary examples available are a 1745 draft of the 44-gun *Centurion* (1732) (Fig. 32), a 1719 Establishment draft of a 50-gun ship, and a contemporary watercolor of the 60-gun *Lion* built in 1709 and rebuilt in 1738 (Fig. 33). The same sources also proved to be indispensable in determining the exact placement of the spars on the masts.<sup>285</sup> A variety of extant sources describe the mast tops, hounds, bibs, and caps for 18<sup>th</sup>-century warships, and all are, for the most part, in agreement.<sup>286</sup> As with the mast and spar details, Steel's treatise was followed except where Lees or Harland offered different examples claiming to be closer to *Pallas* in date. The footropes or horses on the spars were spliced to the ends of the yardarms and, after 1760, crossed each other at the slings before being seized to the yard. There were usually two or three stirrups supporting the horses on each side depending on the length of the yard.<sup>287</sup> The details of the studdingsail booms and boom irons followed Steel's drawings for a 36-gun frigate, supplemented with information gathered from several modern sources. The dimensions of the booms were derived by comparing the relative dimensions of the booms to corresponding yards in Steel's drafts and then applying those ratios to the known dimensions of *Pallas*' yards. The irons were angled forward at an angle of approximately 45 degrees. Rollers to facilitate moving the studdingsail booms were not introduced in the Royal Navy until after 1773 so it is doubtful whether *Pallas* was ever fitted with them.<sup>288</sup>

*Pallas* was not rigged with a sprit topsail yard (as was her sister ship *Venus*) and predates the introduction of the martingale or dolphin striker.<sup>289</sup> Exact details of the bowsprit layout for *Pallas* were unavailable so it was necessary to extrapolate the arrangement from the 1745 draft of *Centurion*, the 1719 Establishment draft of a 50-gun ship, the watercolor of the 60-gun *Lion*, and the few general examples provided by modern sources.<sup>290</sup> Information for the bowsprit and jibboom horses was found in several sources.<sup>291</sup>

By 1730, lateen yards had become so large that it was no longer feasible to shift around the mast while tacking. Consequently, the yard was permanently fixed on the starboard side of the mast. The portion of the sail forward of the mast was discarded and the new leech edge was laced to the mast.<sup>292</sup> The mizzen parrel was seized to the jeer blocks with a parrel rope running through a long tackle block, down through a small hook block fastened to an eyebolt in the deck, and tied off to a cleat on the mast about four feet above the deck.<sup>293</sup>

#### B. Standing Rigging

A great deal of information is available for determining the standing rigging arrangement of Royal Navy frigates from the middle of the 18<sup>th</sup> century. The location and arrangement of the chain plates and channels was included in Slade's original drafts of *Pallas* and *Brilliant*.<sup>294</sup>

For details of the arrangement of the shrouds and futtock shrouds at the tops there are numerous sources, both modern and contemporary, and all are in general agreement (Fig. 31).<sup>295</sup> The ratlines were typically spaced 13 to 15 in. (33-38.1 cm.) apart and on the fore and mainmast shrouds ran from the foremost shroud to the second shroud from aft. About every sixth ratline extended to the aft shroud. All of the ratlines on the mizzen extend across all of the shrouds. Topgallant shrouds did not carry ratlines after about 1745.<sup>296</sup>

For the stays, there are several good sources. Here the detail drawings in the modern sources are indispensable for exact location and method of fixing the various stays. While secondary sources, they are based for the most part on studies of admiralty models and should be reliable.<sup>297</sup> Slade's drafts lack a location for securing the backstays of the mizzenmast. The best sources for determining where to secure the mizzen backstays are the 1761 Admiralty model of the 32-gun *Lowestoffe*, the watercolor of *Lion*, and the 1719 Establishment draft of a 50-gun warship where the backstays all appear to be fastened to eye bolts located somewhere between the bulwarks and the channels. The model of *Lowestoffe* also proved extremely useful.<sup>298</sup> In the absence of exact information, two eyebolts were added to the after end of the mizzen channel in a manner similar to those seen on White's rigging reconstruction of *Diana*.<sup>299</sup>

Exact information for the standing rigging of the bowsprit proved difficult to come by. For the most part, it was necessary to rely on White's reconstruction of the rigging for *Diana* and detail drawings from Lees. It is reasonable to conclude that there are only two sets of bobstays and only one set of bowsprit shrouds. They were seized to two collars, the forward collar securing the outer bobstays and the fore preventer stay and the after collar securing the inner bobstays, the bowsprit shrouds and the fore stay.<sup>300</sup>

### C. Running Rigging

Several good contemporary and detailed modern sources exist for the running rigging of the bowsprit and sprit topsail yard.<sup>301</sup> However it was difficult to find information for the arrangement of sprit topsail yard lifts. The only detailed example found was a modern schematic drawing of an English vessel from about 1800.<sup>302</sup>

The lower yards were suspended from the tops by jeers. The double upper jeer blocks were hung from separate strops wrapped around the head of the mast and fed through the lubber



holes on each side. The lower jeer blocks were single and were seized to the slings of the yard. The halliards were seized to the yard near the lower jeer blocks, rove through the upper and lower blocks on each side and down to bits on the deck.<sup>303</sup> An excellent example of a similar, though not identical, arrangement can be seen on the Admiralty model of *Medway*, 1742.<sup>304</sup> Slings were not introduced in the Royal Navy until after 1770.<sup>305</sup> The topsail yards were suspended by their tyes. Each tye ran up from its halliard, rove through a block stropped to the head of the mast, down through a tye block stropped to the yard, passed back up through the top block on the other side of the mast and down to the other halliard. The tye was usually fixed to the backstay by means of a traveler.<sup>306</sup> The topgallant yards simply hung from their tyes. The tye was seized to the yard and ran up through a sheave in the hounds and down to the halliard, which was fixed to the lower mast tops. White's detail of *Diana* shows the halliard continuing down to the deck.<sup>307</sup> Details of the lifts and lift blocks were derived mainly from Lees and from White's reconstruction of the rigging for *Diana*.<sup>308</sup> For the braces there was considerably more information available albeit confusing and not necessarily in agreement. The best near-contemporary portrayal of braces on a Royal Navy warship was a plate from Sutherland's 1711 treatise *The Ship Builder's Assistant*.<sup>309</sup> While this work is a little early, when combined with the several modern examples found, I am confident that a reasonably accurate portrayal of the brace arrangement for *Pallas* has been achieved.<sup>310</sup>

The details of running rigging for the lateen yard are fairly straightforward. The peak halliard was seized to the peak of the yard, rove through a block at the mast cap, back through a sister block supporting a span on the upper portion of the yard, back through another block lower on the mast head and down to the deck. The bowlines were seized to the aftermost main shroud, rove through a pair of blocks that were stropped to an eyebolt at lower end of the yard, rove back through another block seized to the aftermost main shroud and were tied off to the rail. The vang

pendants are typical of nearly all large ships of the period. The middle of a single piece of rope was clove-hitched to the peak of the yard, rove through a long tackle vang purchase hooked to an eyebolt on each side of the deck and tied off to a cleat in the side.<sup>311</sup>

As previously described a substantial portion of the running rigging lines in *Pallas*' rig extended down to specific belaying points on the forecastle, quarterdeck and the upper deck in the waist, but the exact location of the various belaying points on *Pallas* is unknown, however, they were generally divided into pairs of pin-rails fixed to the inner bulwarks on either side of each mast and an assortment of kevels, kevel blocks and cleats placed around the forecastle, quarterdeck and open area of the waist. White's reconstruction of *Diana* is the closest parallel both chronologically and in ship size and type. It provides the location and function of each individual belaying point. Another relatively close parallel found useful was Lees' schematic of a frigate from 1810. Timberheads were also used as non-specific belaying points. They were shaped with an inverted taper bearded back at the lower end. The crown was also bearded. The shape and placement of the timberheads can be seen on Slade's drafts of *Brilliant*.<sup>312</sup>

### Notes

<sup>1</sup> Admiralty drafts are a standardized set of 1/48-scale drawings approved by the Navy Board and the Admiralty Board for each proposed Royal Navy warship. Copies were submitted to the shipwrights to serve as working parameters during construction. Engineering was left almost entirely to the individual shipwrights and varied considerably from yard to yard throughout the empire.

<sup>2</sup> NMM ADM 2042, ADM 2194, ADM 2196, ADM 2198, ADM 2199, and ADM 2200. Admiralty drafts for construction of HMS *Pallas* and HMS *Brilliant*.

<sup>3</sup> NMM ADM 170/429 and NMM: ADM 170/430 also reproduced in Goodwin, *Construction and Fitting*, 242-265.

<sup>4</sup> Gardiner, *Line of Battle*, 36 and Gardiner, *First Frigates*, 10-12.

<sup>5</sup> Murray, *Treatise on Ship-Building*, 208 For the purposes of this work, the procurement, transport, processing and seasoning of timber and other materials used in the construction of *Pallas* in compliance with Admiralty specifications, will be assumed. Discussion of this process would in itself comprise a lengthy thesis topic.

<sup>6</sup> Sutherland, *Ship-Builder's Assistant*, 78 and Steel, *Shipwright's Vade Mecum*, 232-33.

<sup>7</sup> Goodwin, *Construction and Fitting*, 5, Ollivier, *Remarks*, 46 and Sutherland, *Ship-Builder's Assistant*, 78. The method used to secure the keel assembly atop the blocks is unclear. Sutherland proposes notches

in the tops of the splitting blocks and Ollivier states that they used wooden nogs driven down vertically into the keel block. This may be a case of differing shipyard practices.

<sup>8</sup> Gardiner, *First Frigates*, 28.

<sup>9</sup> Anonymous, *Shipbuilder's Repository*, 256-57, and Murray, *Treatise on Ship-Building*, 204.

<sup>10</sup> Ollivier, *Remarks*, 63.

<sup>11</sup> Goodwin, *Construction and Fitting*, 6.

<sup>12</sup> It is evident that Admiralty drafts were viewed more as working guidelines and not precise engineering plans. The contracted shipwrights were left to address the various structural details with considerable autonomy.

<sup>13</sup> Anonymous, *Shipbuilder's Repository*, 256-57, Goodwin, *Construction and Fitting*, 5-7 and Stevens, *Construction and Embellishment*, 12. Elm was preferred for the keel due to its durability when immersed in salt water for long periods. The use of copper bolts below the waterline was not generally practiced until after 1783. However, Goodwin suggests the possibility that limited application may have occurred much earlier.

<sup>14</sup> Anonymous, *Shipbuilder's Repository*, 256-7, Goodwin, *Construction and Fitting*, 6-7, Steel, *Shipwright's Vade Mecum*, 233 and Murray, *Treatise on Ship-Building*, 204.

<sup>15</sup> Ollivier, *Remarks*, 45-6.

<sup>16</sup> White, *Frigate Diana*, 3.

<sup>17</sup> Goodwin, *Construction and Fitting*, 7.

<sup>18</sup> Steel, *Shipwright's Vade Mecum*, 233 and Goodwin, *Construction and Fitting*, 7.

<sup>19</sup> Ollivier, *Remarks*, 46.

<sup>20</sup> Stevens, *Construction and Embellishment*, 12.

<sup>21</sup> Goodwin, *Construction and Fitting*, 7.

<sup>22</sup> Steffy, "The Charon Report," 226.

<sup>23</sup> Goodwin, *Construction and Fitting*, 8 and Anonymous, *Shipbuilder's Repository*, 256-57.

<sup>24</sup> Steffy, *Wooden Shipbuilding*, 177, Steffy, "The Charon Report," 226.

<sup>25</sup> Goodwin, *Construction and Fitting*, 7-8.

<sup>26</sup> Sutherland, *Ship-Builder's Assistant*, 78-9.

<sup>27</sup> NMM: ADM 2196.

<sup>28</sup> Anonymous, *Shipbuilder's Repository*, 254-55 and Steel, *Shipwright's Vade Mecum*, 234.

<sup>29</sup> Ollivier, *Remarks*, 46.

<sup>30</sup> Anonymous, *Shipbuilder's Repository*, 256-57 and Ollivier, *Remarks*, 47.

<sup>31</sup> Dodds and Moore, *Building the Wooden Fighting Ship*, 62-5. This source provides excellent visual depictions of the process of raising large timber assemblies into place.

<sup>32</sup> Ollivier, *Remarks*, 46 and Goodwin, *Construction and Fitting*, 9-10.

<sup>33</sup> Goodwin, *Construction and Fitting*, 8 and Steel, *Shipwright's Vade Mecum*, 234-35.

<sup>34</sup> Anonymous, *Shipbuilder's Repository*, 246-49.

<sup>35</sup> NMM: ADM 2196.

<sup>36</sup> Goodwin, *Construction and Fitting*, 9.

<sup>37</sup> Stevens, *Construction and Embellishment*, 22.

<sup>38</sup> Anonymous, *Shipbuilder's Repository*, 248-49.

<sup>39</sup> Sutherland, *Ship-Builder's Assistant*, 81.

<sup>40</sup> Goodwin, *Construction and Fitting*, 26. The dimensions of the bolts is unknown but they were probably 1-1¼ in. (2.2-3.8 cm.) diameter.

<sup>41</sup> Anonymous, *Shipbuilder's Repository*, 310-11.

<sup>42</sup> Falconer, *Universal Dictionary*, 123 and Steel, *Shipwright's Vade Mecum*, 103.

<sup>43</sup> Goodwin, *Construction and Fitting*, 24.

<sup>44</sup> Anonymous, *Shipbuilder's Repository*, 248-49, Goodwin, *Construction and Fitting*, 26 and Ollivier, *Remarks*, 47.

<sup>45</sup> Dodds and Moore, *Building the Wooden Fitting Ship*, 62-5. This source provides excellent visual depictions of the process of raising large timber assemblies into place.

- <sup>46</sup> Anonymous, *Shipbuilder's Repository*, 332-33, Goodwin, *Construction and Fitting*, 31 and NMM: ADM 2196.
- <sup>47</sup> Murray, *Treatise on Ship-Building*, 207.
- <sup>48</sup> Goodwin, *Construction and Fitting*, 12-13.
- <sup>49</sup> Ollivier, *Remarks*, 47.
- <sup>50</sup> Steffy, "The Charon Report," 132.
- <sup>51</sup> McKay and Coleman, *Frigate Pandora*, 26-8 and White, *Frigate Diana*, 30-1.
- <sup>52</sup> Lavery, *Ship of the Line* Vol. 2, 43.
- <sup>53</sup> NMM: ADM 2196 and NMM: ADM 170/429.
- <sup>54</sup> Several early *Unicorn* class frigates were built entirely of fir.
- <sup>55</sup> Sutherland, *Ship-Builder's Assistant*, 79.
- <sup>56</sup> Anonymous, *Shipbuilder's Repository*, 262-63 and NMM: ADM 170/429.
- <sup>57</sup> Steel, *Shipwright's Vade Mecum*, 237.
- <sup>58</sup> Ollivier, *Remarks*, 65-6, Dodds and Moore, *Building the Wooden Fighting Ship*, 72-3 and Steel, *Shipwright's Vade Mecum*, 238-39. Ollivier claimed that the doubled frames were fastened together with treenails rather than iron bolts.
- <sup>59</sup> Dodds and Moore, *Building the Wooden Fighting Ship*, 72-3 and Steel, *Shipwright's Vade Mecum*, 238-39. Steel gives an excellent description of raising the frames into place.
- <sup>60</sup> Sutherland, *Ship-Builder's Assistant*, 79.
- <sup>61</sup> Steel, *Shipwright's Vade Mecum*, 237, Dodds and Moore, *Building the Wooden Fighting Ship*, 68 and Sutherland, *Ship-Builder's Assistant*, 79.
- <sup>62</sup> ADM 2196, Anonymous, *Shipbuilder's Repository*, 262-69, NMM: ADM 170/430, Steffy, *Wooden Shipbuilding*, 177, McKay and Coleman, *Frigate Pandora*, 64, White, *Frigate Diana*, 61.
- <sup>63</sup> Ollivier, *Remarks*, 52.
- <sup>64</sup> Ollivier, *Remarks*, 48.
- <sup>65</sup> Goodwin, *Construction and Fitting*, 13.
- <sup>66</sup> Steffy, *Wooden Shipbuilding*, 177.
- <sup>67</sup> Goodwin, *Construction and Fitting*, 17.
- <sup>68</sup> Steffy, "The Charon Report," 130 and Stevens, *Construction and Embellishment*, 13-14.
- <sup>69</sup> Falconer, *Universal Dictionary*, 74.
- <sup>70</sup> Stevens, *Construction and Embellishment*, 15-17.
- <sup>71</sup> Sutherland, *Ship-Builder's Assistant*, 80 and Goodwin, *Construction and Fitting*, 23.
- <sup>72</sup> Murray, *Treatise on Ship-Building*, 207, Steel, *Shipwright's Vade Mecum*, 109.
- <sup>73</sup> Ollivier, *Remarks*, 50.
- <sup>74</sup> Anonymous, *Shipbuilder's Repository*, 254-55.
- <sup>75</sup> Anonymous, *Shipbuilder's Repository*, 254-55.
- <sup>76</sup> Anonymous, *Shipbuilder's Repository*, 308-9, Goodwin, *Construction and Fitting*, 178, Sutherland, *Ship-Builder's Assistant*, 83 and Steel, *Shipwright's Vade Mecum*, 116-17.
- <sup>77</sup> Steel, *Shipwright's Vade Mecum*, 112.
- <sup>78</sup> Anonymous, *Shipbuilder's Repository*, 258-59, Murray, *Treatise on Ship-Building*, 204 and Sutherland, *Ship-Builder's Assistant*, 79.
- <sup>79</sup> Stevens, *Construction and Embellishment*, 19, White, *Frigate Diana*, 30-1.
- <sup>80</sup> Anonymous, *Shipbuilder's Repository*, 258-59.
- <sup>81</sup> Falconer, *Universal Dictionary*, 331, Fincham, *Outline of Ship Building*, 29, Goodwin, *Construction and Fitting*, 53, Steel, *Shipwright's Vade Mecum*, 140-141 and Murray, *Treatise on Ship-Building*, 209.
- <sup>82</sup> Anonymous, *Shipbuilder's Repository*, 268-69, Murray, *Treatise on Ship-Building*, 205, Goodwin, *Construction and Fitting*, 53, McKay and Coleman, *Frigate Pandora*, 69 and White, *Frigate Diana*, 61.
- <sup>83</sup> Steffy, *Wooden Shipbuilding*, 271. States clearly that some eighteenth century English documents called all of the ceiling, footwaling in which case the thick strakes near the turn of the bilge were known as thick stuff. Falconer, *Universal Dictionary*, 79 and 132, Falconer makes no differentiation between ceiling and footwaling. Stevens, *Construction and Embellishment*, 20.
- <sup>84</sup> Anonymous, *Shipbuilder's Repository*, 278-79 and Goodwin, *Construction and Fitting*, 39-40.

- <sup>85</sup> Murray, *Treatise on Ship-Building*, 208.
- <sup>86</sup> Steffy, *Wooden Shipbuilding*, 177.
- <sup>87</sup> Goodwin, *Construction and Fitting*, 40-1.
- <sup>88</sup> Anonymous, *Shipbuilder's Repository*, 296-97, 320-21, Blanckley, *Naval Expositor*, 35, Murray, *Treatise on Ship-Building*, 207, Goodwin, *Construction and Fitting*, 41-2 and Falconer, *Universal Dictionary*, 81.
- <sup>89</sup> Anonymous, *Shipbuilder's Repository*, 280-81, 320-2, Goodwin, *Construction and Fitting*, 41-2 and Ollivier, *Remarks*, 50. Ollivier states that no orlop deck clamps were used. The orlop beams were butted against the frames, notched into the ceiling strakes and secured at both ends with hanging knees.
- <sup>90</sup> Anonymous, *Shipbuilder's Repository*, 296-97, 320-21 and Goodwin, *Construction and Fitting*, 41-2.
- <sup>91</sup> McKay and Coleman, *Frigate Pandora*, 69 and White, *Frigate Diana*, 61. The section plan for *Pandora* shows a large single-strake clamp. However, *Pandora* carried only 9-pound guns and therefore did not require a heavily reinforced gun deck. The section plan for *Diana*, armed with much heavier 18-pound guns, shows a two-strake clamp supporting the gun deck.
- <sup>92</sup> Anonymous, *Shipbuilder's Repository*, 320-21 and Goodwin, *Construction and Fitting*, 42.
- <sup>93</sup> Anonymous, *Shipbuilder's Repository*, 326-29 and Goodwin, *Construction and Fitting*, 42.
- <sup>94</sup> Goodwin, *Construction and Fitting*, 42.
- <sup>95</sup> Goodwin, *Construction and Fitting*, 43-4.
- <sup>96</sup> Anonymous, *Shipbuilder's Repository*, 304-5.
- <sup>97</sup> Anonymous, *Shipbuilder's Repository*, 322-5.
- <sup>98</sup> Anonymous, *Shipbuilder's Repository*, 328-29.
- <sup>99</sup> Blanckley, *Naval Expositor*, 156 and Steel, *Shipwright's Vade Mecum*, 133.
- <sup>100</sup> Anonymous, *Shipbuilder's Repository*, 308-9 and Goodwin, *Construction and Fitting*, 44.
- <sup>101</sup> Anonymous, *Shipbuilder's Repository*, 324-25 and Goodwin, *Construction and Fitting*, 44.
- <sup>102</sup> Anonymous, *Shipbuilder's Repository*, 328-31 and Goodwin, *Construction and Fitting*, 44.
- <sup>103</sup> Blanckley, *Naval Expositor*, 57, Steffy, *Wooden Shipbuilding*, 271. Steffy states clearly that some eighteenth century English documents called all of the ceiling, footwaling in which case the thick strakes near the turn of the bilge were known as thick stuff. Falconer, *Universal Dictionary*, 79 and 132. Falconer makes no differentiation between ceiling and footwaling.
- <sup>104</sup> Anonymous, *Shipbuilder's Repository*, 280-1 and Goodwin, *Construction and Fitting*, 46.
- <sup>105</sup> Anonymous, *Shipbuilder's Repository*, 324-25, White, *Frigate Diana*, 61 and Goodwin, *Construction and Fitting*, 46. Goodwin suggests 4 or 5 strakes of quickwork but there is only room between the spiketting and deck clamps for a single strake on the lower deck and two strakes on the gundeck as can be seen on White's reconstruction of *Diana*.
- <sup>106</sup> Ollivier, *Remarks*, 50.
- <sup>107</sup> Anonymous, *Shipbuilder's Repository*, 326-27, Steel, *Shipwright's Vade Mecum*, 136.
- <sup>108</sup> NMM: ADM 2194, NMM: ADM 2196, NMM: ADM 2198, ADM 2199, and ADM 2200, Admiralty drafts for construction of HMS *Pallas* and HMS *Brilliant*.
- <sup>109</sup> Anonymous, *Shipbuilder's Repository*, 298-99, Ollivier, *Remarks*, 51 and Goodwin, *Construction and Fitting*, 65-6.
- <sup>110</sup> Sutherland, *Ship-Builders Assistant*, 84-5.
- <sup>111</sup> NMM: ADM 2196, NMM: ADM 2198 and NMM: ADM 2199. Admiralty drafts for construction of HMS *Pallas* and HMS *Brilliant*.
- <sup>112</sup> Steel, *Shipwright's Vade Mecum*, 112-13 and Falconer, *Universal Dictionary*, 166.
- <sup>113</sup> NMM: ADM 2196, Anonymous, *Shipbuilder's Repository*, 282-83 and Goodwin, *Construction and Fitting*, 69-70.
- <sup>114</sup> Anonymous, *Shipbuilder's Repository*, 282-3, NMM: ADM 170/429 and Goodwin, *Construction and Fitting*, 78.
- <sup>115</sup> Anonymous, *Shipbuilder's Repository*, 298-99, NMM: ADM 2196 and Goodwin, *Construction and Fitting*, 66.
- <sup>116</sup> Goodwin, *Construction and Fitting*, 65-6.
- <sup>117</sup> Anonymous, *Shipbuilder's Repository*, 298-301 and Goodwin, *Construction and Fitting*, 76-7, 88.

- <sup>118</sup> Anonymous, *Shipbuilder's Repository*, 320-21, NMM: ADM 2196, Murray, *Treatise on Ship-Building*, 204 and Goodwin, *Construction and Fitting*, 67-8.
- <sup>119</sup> Goodwin, *Construction and Fitting*, 65-6.
- <sup>120</sup> Anonymous, *Shipbuilder's Repository*, 320-25 and Goodwin, *Construction and Fitting*, 77, 88.
- <sup>121</sup> Anonymous, *Shipbuilder's Repository*, 326-31, NMM: ADM 2196, Murray, *Treatise on Ship-Building*, 204 and Goodwin, *Construction and Fitting*, 68-9.
- <sup>122</sup> Goodwin, *Construction and Fitting*, 65-6.
- <sup>123</sup> Anonymous, *Shipbuilder's Repository*, 326-31.
- <sup>124</sup> Goodwin, *Construction and Fitting*, 72.
- <sup>125</sup> Anonymous, *Shipbuilder's Repository*, 300-1, Blanckley, *Naval Expositor*, 29, Steel, *Shipwright's Vade Mecum*, 92, 114, Sutherland, *Ship-Builder's Assistant*, 85 and Murray, *Treatise on Ship-Building*, 206.
- <sup>126</sup> Anonymous, *Shipbuilder's Repository*, 284-85 and Goodwin, *Construction and Fitting*, 74-5.
- <sup>127</sup> Anonymous, *Shipbuilder's Repository*, 300-01 and Goodwin, *Construction and Fitting*, 74-5.
- <sup>128</sup> Anonymous, *Shipbuilder's Repository*, 322-23 and Goodwin, *Construction and Fitting*, 74-5.
- <sup>129</sup> Anonymous, *Shipbuilder's Repository*, 300-01 and Goodwin, *Construction and Fitting*, 74-5.
- <sup>130</sup> Blanckley, *Naval Expositor*, 22, Goodwin, *Construction and Fitting*, 91, Murray, *Treatise on Ship-Building*, 206 and Steel, *Shipwright's Vade Mecum*, 89.
- <sup>131</sup> Ollivier, *Remarks*, 52.
- <sup>132</sup> NMM: ADM, 2196.
- <sup>133</sup> Anonymous, *Shipbuilder's Repository*, 320-23.
- <sup>134</sup> Anonymous, *Shipbuilder's Repository*, 296-99.
- <sup>135</sup> Anonymous, *Shipbuilder's Repository*, 290-91 and NMM: ADM 2196.
- <sup>136</sup> Anonymous, *Shipbuilder's Repository*, 288-89, Goodwin, *Construction and Fitting*, 105-6 and NMM: ADM 2196.
- <sup>137</sup> White, *Frigate Diana*, 36 and McKay and Coleman, *Frigate Pandora*, 42-3.
- <sup>138</sup> Steel, *Shipwright's Vade Mecum*, 109 and Goodwin, *Construction and Fitting*, 33.
- <sup>139</sup> Anonymous, *Shipbuilder's Repository*, 320-21 and Goodwin, *Construction and Fitting*, 33.
- <sup>140</sup> Anonymous, *Shipbuilder's Repository*, 324-25, McKay and Coleman, *Frigate Pandora*, 42 and White, *Frigate Diana*, 36.
- <sup>141</sup> Anonymous, *Shipbuilder's Repository*, 328-29, McKay and Coleman, *Frigate Pandora*, 42 and White, *Frigate Diana*, 36.
- <sup>142</sup> Falconer, *Universal Dictionary*, 243.
- <sup>143</sup> Anonymous, *Shipbuilder's Repository*, 286-87.
- <sup>144</sup> Anonymous, *Shipbuilder's Repository*, 286-87, McKay and Coleman, *Frigate Pandora*, 69 and White, *Frigate Diana*, 61.
- <sup>145</sup> Sutherland, *Ship-Builder's Assistant*, 87-8 and Goodwin, *Construction and Fitting*, 50.
- <sup>146</sup> McKay and Coleman, *Frigate Pandora*, 40 and White, *Frigate Diana*, 67.
- <sup>147</sup> Goodwin, *Construction and Fitting*, 50.
- <sup>148</sup> Steffy, "The Charon Report," 130, McKay and Coleman, *Frigate Pandora*, 69 and White, *Frigate Diana*, 61.
- <sup>149</sup> Goodwin, *Construction and Fitting*, 50 and Steffy, "The Charon Report," 130.
- <sup>150</sup> Ollivier, *Remarks*, 52.
- <sup>151</sup> Goodwin, *Construction and Fitting*, 51.
- <sup>152</sup> Goodwin, *Construction and Fitting*, 54.
- <sup>153</sup> NMM: ADM 2042 and Goodwin, *Construction and Fitting*, 57-8.
- <sup>154</sup> Steel, *Shipwright's Vade Mecum*, 130 and White, *Frigate Diana*, 61, 67.
- <sup>155</sup> Anonymous, *Shipbuilder's Repository*, 270-71.
- <sup>156</sup> NMM: ADM 2042 and Goodwin, *Construction and Fitting*, 57-8.
- <sup>157</sup> Anonymous, *Shipbuilder's Repository*, 246-47 and Goodwin, *Construction and Fitting*, 54.
- <sup>158</sup> Goodwin, *Construction and Fitting*, 50.
- <sup>159</sup> ADM 2042, White, *Frigate Diana*, 61 and McKay and Coleman, *Frigate Pandora*, 64.

- <sup>160</sup> Dodds and Moore, *Building the Wooden Fighting Ship*, 93.
- <sup>161</sup> Anonymous, *Shipbuilder's Repository*, 302-3, Blanckley, *Naval Expositor*, 10, Falconer, *Universal Dictionary*, 36, Goodwin, *Construction and Fitting*, 175.
- <sup>162</sup> NMM: ADM 2196.
- <sup>163</sup> NMM: ADM 2196 and Anonymous, *Shipbuilder's Repository*, 302-04.
- <sup>164</sup> Anonymous, *Shipbuilder's Repository*, 326-27.
- <sup>165</sup> NMM: ADM, 2196 and Anonymous, *Shipbuilder's Repository*, 333-34.
- <sup>166</sup> Goodwin, *Construction and Fitting*, 220.
- <sup>167</sup> NMM: ADM 2196.
- <sup>168</sup> Anonymous, *Shipbuilder's Repository*, 288-89, Goodwin, *Construction and Fitting*, 172 and NMM: ADM 2196.
- <sup>169</sup> Anonymous, *Shipbuilder's Repository*, 306-7 and NMM: ADM 2196. The breadth of the bowsprit step is based on the thickness to breadth ratio given for larger ships in *The Shipbuilder's Repository*.
- <sup>170</sup> Anonymous, *Shipbuilder's Repository*, 304-7.
- <sup>171</sup> Anonymous, *Shipbuilder's Repository*, 322-23.
- <sup>172</sup> Steel, *Shipwright's Vade Mecum*, 303. *The Shipbuilder's Repository* does not provide these dimensions
- <sup>173</sup> Anonymous, *Shipbuilder's Repository*, 306-7.
- <sup>174</sup> NMM: ADM 2196.
- <sup>175</sup> Goodwin, *Construction and Fitting*, 145-50, Steel, *Shipwright's Vade Mecum*, 92, 102 and Lavery, *Construction and Fitting*, 36-49.
- <sup>176</sup> Gardiner, *First Frigates*, 67.
- <sup>177</sup> Goodwin, *Construction and Fitting*, 58-9 and Dodds and Moore, *Building the Wooden Fighting Ship*, 96.
- <sup>178</sup> Anonymous, *Shipbuilder's Repository*, 240-41, Goodwin, *Construction and Fitting*, 59-60 and White, *Frigate Diana*, 48-9.
- <sup>179</sup> Goodwin, *Construction and Fitting*, 59-60 and White, *Frigate Diana*, 48-9.
- <sup>180</sup> NMM: ADM 2200 and Goodwin, *Construction and Fitting*, 72.
- <sup>181</sup> Anonymous, *Shipbuilder's Repository*, 238-39 and White, *Frigate Diana*, 52-3.
- <sup>182</sup> Anonymous, *Shipbuilder's Repository*, 242-43, Goodwin, *Construction and Fitting*, 58-60 and White, *Frigate Diana*, 46-7.
- <sup>183</sup> Blanckley, *Naval Expositor*, 30, Falconer, *Universal Dictionary*, 79, Anonymous, *Shipbuilder's Repository*, 252-53, Murray, *Treatise on Ship-Building*, 206 and Lavery, *Construction and Fitting*, 51.
- <sup>184</sup> Goodwin, *Construction and Fitting*, 58-9 and Anonymous, *Shipbuilder's Repository*, 238-39.
- <sup>185</sup> Lavery, *Construction and Fitting*, 45-6 and Goodwin, *Construction and Fitting*, 115.
- <sup>186</sup> Goodwin, *Construction and Fitting*, 193 and Lavery, *Construction and Fitting*, 249.
- <sup>187</sup> NMM: ADM 2198, NMM: ADM 2199, NMM: ADM 2200.
- <sup>188</sup> Blanckley, *Naval Expositor*, 66 and Lavery, *Construction and Fitting*, 239-40.
- <sup>189</sup> Ollivier, *Remarks*, 50.
- <sup>190</sup> Steffy, "The Charon Report," 128.
- <sup>191</sup> Anonymous, *Shipbuilder's Repository*, 290-91.
- <sup>192</sup> Anonymous, *Shipbuilder's Repository*, 310-11.
- <sup>193</sup> Lavery, *Construction and Fitting*, 202-3.
- <sup>194</sup> Goodwin, *Construction and Fitting*, 199-201 and White, *Frigate Diana*, 34-5. Up until the early 18<sup>th</sup> century glazing was made from ground mica commonly known as Muscovy glass.
- <sup>195</sup> Steel, *Shipwright's Vade Mecum*, 137, Gardiner, *First Frigates*, 30 and White, *Frigate Diana*, 34.
- <sup>196</sup> Lavery, *Construction and Fitting*, 255, Gardiner, *First Frigates*, 84 and Goodwin, *Construction and Fitting*, 206. Up until the early 18<sup>th</sup> century glazing was made from ground mica commonly known as Muscovy glass.
- <sup>197</sup> NMM: ADM 2042.
- <sup>198</sup> Harland, *Seamanship in the Age of Sail*, 71, and Lavery *Construction and Fitting*, 10-12.
- <sup>199</sup> White *Frigate Diana*, Plate 6, 19, 115.
- <sup>200</sup> Lees *Masting and Rigging*, Plate 58, 155.

- <sup>201</sup> Lavery, *Construction and Fitting*, 11, Goodwin, *Construction and Fitting*, 129-131 and White, *Frigate Diana*, 114-15.
- <sup>202</sup> Anonymous, *Shipbuilder's Repository*, 312-13.
- <sup>203</sup> Steel, *Shipwright's Vade Mecum*, 137, Goodwin, *Construction and Fitting*, 131-36, Lavery, *Construction and Fitting*, 17-21 and White, *Frigate Diana*, 112-14.
- <sup>204</sup> Lavery, *Construction and Fitting*, 20-1 and White, *Frigate Diana*, 112-14.
- <sup>205</sup> Steel, *Shipwright's Vade Mecum*, 113, NMM: ADM 2042, Anonymous, *Shipbuilder's Repository*, 334-5 and Goodwin, *Construction and Fitting*, 36-7.
- <sup>206</sup> NMM: ADM 2042 and White, *Frigate Diana*, 70-1.
- <sup>207</sup> Goodwin, *Construction and Fitting*, 205.
- <sup>208</sup> NMM: ADM 2194, NMM: ADM 2196, NMM: ADM 2198, NMM: ADM 2199 and NMM: ADM 2200. These could be subject to modification by the builder and/or Captain.
- <sup>209</sup> Goodwin, *Construction and Fitting*, 111.
- <sup>210</sup> NMM: ADM 2196, NMM: ADM 2198 and Blomfield, "Internal Economy," 161-4.
- <sup>211</sup> NMM: ADM 2196 and NMM: ADM 2199.
- <sup>212</sup> Steel, *Shipwright's Vade Mecum*, 90, Goodwin, *Construction and Fitting*, 111-2, White, *Frigate Diana*, 55, Lavery, *Construction and Fitting*, 146 and Dodds and Moore, *Building the Wooden Fighting Ship*, 99.
- <sup>213</sup> NMM: ADM 2194 and NMM: ADM 2196.
- <sup>214</sup> Falconer, *Universal Dictionary*, 186, NMM: ADM 2194 and NMM: ADM 2196.
- <sup>215</sup> Goodwin, *Construction and Fitting*, 121 and Lavery, *Construction and Fitting*, 144-46, 150.
- <sup>216</sup> Goodwin, *Construction and Fitting*, 121-22 and Anonymous, *Shipbuilder's Repository*, 292-93.
- <sup>217</sup> Lavery, *Construction and Fitting*, 150.
- <sup>218</sup> Anonymous, *Shipbuilder's Repository*, 290-93, Goodwin, *Construction and Fitting*, 126-27, Lavery, *Construction and Fitting*, 150 and Steffy, "The Charon Report," 139-40.
- <sup>219</sup> TNA: PRO ADM 95/66 and Gardiner, *First Frigates*, 80.
- <sup>220</sup> Caruana, *History of English Sea Ordnance* Vol. 2, 152, Gardiner, *First Frigates*, 81, and Lavery, *Construction and Fitting*, 101.
- <sup>221</sup> Caruana, *History of English Sea Ordnance* Vol. 2, 391-2 and Lavery, *Construction and Fitting*, 143.
- <sup>222</sup> Caruana, *History of English Sea Ordnance* Vol. 2, 242.
- <sup>223</sup> Lavery, *Construction and Fitting*, 102.
- <sup>224</sup> Caruana, *History of English Sea Ordnance* Vol. 2, 358.
- <sup>225</sup> Caruana, *History of English Sea Ordnance* Vol. 1, 229.
- <sup>226</sup> Muller, *Treatise of Artillery*, 149, also published in Dodds and Moore, *Building the Wooden Fighting Ship*, 123.
- <sup>227</sup> Gardiner, *First Frigates*, 81.
- <sup>228</sup> Anonymous, *Shipbuilder's Repository*, 324-5, 328-29 and Goodwin, *Construction and Fitting*, 77, 88.
- <sup>229</sup> Falconer, *Universal Dictionary*, 203.
- <sup>230</sup> Caruana, *History of English Sea Ordnance* Vol. 2, 381-88.
- <sup>231</sup> Goodwin, *Construction and Fitting*, 188.
- <sup>232</sup> White, *Frigate Diana*, 19 and Lavery, *Construction and Fitting*, 55.
- <sup>233</sup> Falconer, *Universal Dictionary*, 221-23 and Oertling, *Ships' Bilge Pumps*, 53.
- <sup>234</sup> Steffy, "The Charon Report," 134 and Steffy, *Wooden Shipbuilding*, 174.
- <sup>235</sup> NMM: ADM 2196.
- <sup>236</sup> *Ibid.*
- <sup>237</sup> Lavery, *Construction and Fitting*, 72, Oertling, *Ships' Bilge Pumps*, 59-61 and Steffy, "The Charon Report," 134-5. The Admiralty did not order its use on all Royal Navy warships until 1774.
- <sup>238</sup> Falconer, *Universal Dictionary*, 221-23.
- <sup>239</sup> Falconer, *Universal Dictionary*, 9.
- <sup>240</sup> Lavery, *Construction and Fitting*, 33.
- <sup>241</sup> McKay and Coleman, *Frigate Pandora*, 76 and White, *Frigate Diana*, 76.
- <sup>242</sup> Lavery, *Construction and Fitting*, 35.
- <sup>243</sup> Goodwin, *Construction and Fitting*, 183-84.



- <sup>244</sup> NMM: ADM 219.
- <sup>245</sup> Lavery, *Construction and Fitting*, 22-3.
- <sup>246</sup> Falconer, *Universal Dictionary*, 35-6 and Lavery, *Construction and Fitting*, 26.
- <sup>247</sup> Goodwin, *Construction and Fitting*, 206-7.
- <sup>248</sup> Lavery, *Construction and Fitting*, 197 and NMM: ADM 2196. In fact the stove depicted on Slade's construction draft of *Pallas* appears to be nearly identical to the one on *Dorsetshire*.
- <sup>249</sup> Goodwin, *Construction and Fitting*, 211.
- <sup>250</sup> NMM: ADM 2042 and Goodwin, *Construction and Fitting*, 184.
- <sup>251</sup> NMM: ADM 2042.
- <sup>252</sup> Lavery, *Construction and Fitting*, 186-7.
- <sup>253</sup> Lavery, *Construction and Fitting*, 186.
- <sup>254</sup> Steffy, "The *Charon* Report," 118.
- <sup>255</sup> Ollivier, *Remarks*, 55.
- <sup>256</sup> Garcia and Monteiro, *Intervenção Arquelógica Subaquática*, 20.
- <sup>257</sup> King, "Iron Ballast for the Georgian Navy," 15-16.
- <sup>258</sup> Lavery, *Construction and Fitting*, 207-12.
- <sup>259</sup> May, *Boats of Men-of-War*, 36.
- <sup>260</sup> Gardiner, *First Frigates*, 67.
- <sup>261</sup> Falconer, *Universal Dictionary*, 39.
- <sup>262</sup> Lavery, *Construction and Fitting*, 218-19.
- <sup>263</sup> Falconer, *Universal Dictionary*, 39, May, 1999. 25-6.
- <sup>264</sup> Lavery, *Construction and Fitting*, 219-20.
- <sup>265</sup> Falconer, *Universal Dictionary*, 39, Lavery, *Construction and Fitting* 222.
- <sup>266</sup> Falconer, *Universal Dictionary*, 39 and Lavery, *Construction and Fitting*, 222-3.
- <sup>267</sup> May, *Boats of Men-of-War*, 47-9.
- <sup>268</sup> Goodwin, *Construction and Fitting*, 210 and Lavery, *Construction and Fitting*, 235.
- <sup>269</sup> Knight, *Copper Sheathing*, 299-301, Steffy, "The *Charon* Report," 131, and Lavery, *Construction and Fitting*, 62-3. Analysis of the logbooks for *Pallas* (specifically time spent in home ports) suggests that she was coppered as early as January 1778. (see service history chapter and Appendix C)
- <sup>270</sup> Knight, *Copper Sheathing*, 301-2, Goodwin, *Construction and Fitting*, 225-27 and Lavery, *Construction and Fitting*, 6.
- <sup>271</sup> Steffy, "The *Charon* Report", 131.
- <sup>272</sup> Gardiner, *First Frigates*, 88.
- <sup>273</sup> NMM: ADM 2196 and NMM: ADM 2042.
- <sup>274</sup> Goodwin, *Construction and Fitting*, 166-9.
- <sup>275</sup> NMM: ADM 2196 and NMM: ADM 2042.
- <sup>276</sup> Goodwin, *Construction and Fitting*, 169
- <sup>277</sup> NMM: ADM 2196 and NMM: ADM 2042.
- <sup>278</sup> Gardiner, *First Frigates*, 88.
- <sup>279</sup> Marquardt, *Eighteenth-century Rigs and Rigging*, 17, Lees, *Masting and Rigging*, 2 and Goodwin, *Construction and Fitting*, 170.
- <sup>280</sup> Steel, *Elements of Mastmaking*, 50-1.
- <sup>281</sup> Lees, *Masting and Rigging*, 3-15, Marquardt *Eighteenth-century Rigs and Rigging*, 14, 22-33 and Harland, *Seamanship in the Age of Sail*, 19-21,34.
- <sup>282</sup> Steel, *Elements of Mastmaking*, Plate IV and V.
- <sup>283</sup> Marquardt, *Eighteenth-century Rigs and Rigging*, 14-16.
- <sup>284</sup> Steel, *Elements of Mastmaking*, Plate V and White *Frigate Diana*, 78.
- <sup>285</sup> Lees, *Masting and Rigging*, Plate 21-Admiralty Draft (#6039) *Centurion* and Ollivier, *Remarks*, 44, 166—an anonymous watercolor of *Lion*, and a draft of a 1719 Establishment 50-gun ship.
- <sup>286</sup> Steel, *Elements of Mastmaking*, Plate IV, Lees, *Masting and Rigging*, 3, 23-31 and Harland, *Seamanship in the Age of Sail*, 19-20.
- <sup>287</sup> Lees, *Masting and Rigging*, 69 and Marquardt, *Eighteenth-century Rigs and Rigging*, 72-3.

- <sup>288</sup> Steel, *Elements of Mastmaking*, Plate IV, Lees, *Masting and Rigging*, 14-16, Marquardt, *Eighteenth-century Rigs and Rigging*, 104 and Harland, *Seamanship in the Age of Sail*, 21.
- <sup>289</sup> Gardiner, *First Frigates*, 88, Marquardt, *Eighteenth-century Rigs and Rigging*, 29, and Harland, *Seamanship in the Age of Sail*, 20-1.
- <sup>290</sup> Marquardt, *Eighteenth-century Rigs and Rigging*, 29, and Harland, *Seamanship in the Age of Sail*, 20, Lees, *Masting and Rigging*, 11, Plate 21-Admiralty Draft (#6039) *Centurion*, Ollivier, *Remarks*, 44, 166 An anonymous watercolor of *Lion*, and a draft of a 1719 Establishment 50-gun ship.
- <sup>291</sup> Lees, *Masting and Rigging*, 51, Harland, *Seamanship in the Age of Sail*, 24 and Marquardt, *Eighteenth-century Rigs and Rigging*, 52.
- <sup>292</sup> Harland, *Seamanship in the Age of Sail*, 75.
- <sup>293</sup> Lees, *Masting and Rigging*, 105.
- <sup>294</sup> NMM: ADM 2196 and NMM: ADM 2042.
- <sup>295</sup> Gardiner, *First Frigates*, 84-Admiralty model of *Lowestoffe*, Harland, *Seamanship in the Age of Sail*, 22-3, Lees, *Masting and Rigging*, 54.
- <sup>296</sup> Marquardt, *Eighteenth-century Rigs and Rigging*, 63 and Lees, *Masting and Rigging*, 44, 61.
- <sup>297</sup> Lees, *Masting and Rigging*, 48, 50, 56-7, Biddlecombe, *Art of Rigging*, Plate IX, 62-3, Harland, *Seamanship in the Age of Sail*, 22.
- <sup>298</sup> Gardiner, *First Frigates*, 84-Admiralty model of *Lowestoffe*, and Ollivier, *Remarks*, 44, 166 – An anonymous watercolor of *Lion*, and a draft of a 1719 Establishment 50-gun ship.
- <sup>299</sup> White *Frigate Diana*, 84.
- <sup>300</sup> White *Frigate Diana*, 84-6 and Lees, *Masting and Rigging*, 50.
- <sup>301</sup> Lees, *Masting and Rigging*, 100-1.
- <sup>302</sup> Marquardt, *Eighteenth-century Rigs and Rigging*, 57.
- <sup>303</sup> Lees, *Masting and Rigging*, 64-5.
- <sup>304</sup> Lees, *Masting and Rigging*, Plate 3.
- <sup>305</sup> Marquardt, *Eighteenth-century Rigs and Rigging*, 77.
- <sup>306</sup> Marquardt, *Eighteenth-century Rigs and Rigging*, 89, 92, White *Frigate Diana*, 93 and Lees, *Masting and Rigging*, 83.
- <sup>307</sup> Harland, *Seamanship in the Age of Sail*, 26 and White, *Frigate Diana*, 93.
- <sup>308</sup> Lees, *Masting and Rigging*, 68-9, 85, and White *Frigate Diana*, 95.
- <sup>309</sup> Sutherland *Ship-Builder's Assistant*, 114.
- <sup>310</sup> Marquardt, *Eighteenth-century Rigs and Rigging*, 101, White *Frigate Diana*, 94 and Biddlecombe, *Art of Rigging*, Plate X, 64-5.
- <sup>311</sup> Harland, *Seamanship in the Age of Sail*, 75-6 and Lees, *Masting and Rigging*, 106-8.
- <sup>312</sup> NMM: ADM 2042.

## CHAPTER V

### LIFE ABOARD AN 18<sup>TH</sup>-CENTURY ROYAL NAVY FRIGATE

The field of nautical archaeology has focused, for the most part, on the ships themselves and to a lesser degree on recovered artifacts. Consideration has been given primarily to the methods and circumstances of construction, to aspects of the political, environmental and economic conditions that may have influenced design, and to the circumstances surrounding their ultimate demise. Very little emphasis has been placed on the study of physical, environmental, and social conditions of the men that lived, sailed and, in many cases, died on these ships. There has been a collective tendency to sterilize, when what is needed is a move to humanize a ship and its collection of artifacts. Nautical archaeologists are, after all, cultural anthropologists whose ultimate goal should be the study of mankind based upon analysis of material culture. Historians, on the other hand, perhaps because many view themselves more as humanists than scientists, have devoted more consideration to shipboard life. What follows is an examination of the living conditions common throughout the British fleet during the 18<sup>th</sup> century focusing specifically on HMS *Pallas* wherever possible. Topics addressed include shipboard hierarchy, duties and discipline, pay and benefits, accommodations, food, clothing, health and hygiene, and leisure activities

#### Entering the Service

There were three ways for the common seaman to enter the service of the Royal Navy. He could enter as a young apprentice bound to an officer patron, volunteer of his own free will or, during wartime, be pressed onto service.

Contrary to popular perceptions, 18<sup>th</sup>-century press gangs did not wander the streets clubbing able-bodied men over the head and depriving them of their liberty. In practice, press gangs were generally very selective and took only seafaring men or those possessing experience in maritime related industries.<sup>1</sup> Men illegally impressed had legal recourse to regain their freedom. However there were many cases in which such individuals, upon receiving their legal release, chose instead to remain and serve.<sup>2</sup>

There is a great deal of information regarding the methods employed by the navy to address the manpower shortfall during this period. However, navy records of recruitment activities make it impossible to establish any meaningful numbers or ratios for each type of recruitment. This is primarily because these records speak simply of ‘recruits’ (defined as volunteers and pressed men) and ‘losses’ (defined as discharges, desertions and deaths). A number of record-keeping errors resulted from this. Men who deserted from one vessel quite often found themselves pressed into the service of another by the end of the same week. Ships returning home often had large portions of their crews pressed onto other outbound ships before they reached port, as pressing at sea was a common practice; it is clear that the navy’s records included only those men recruited on land.<sup>3</sup>

The navy reckoned that a year at sea made an ‘ordinary’ seaman and two years made an ‘able’ seaman.<sup>4</sup> Captains typically considered a crew composition of one-third able seamen, one-third ordinary, and one-third landsmen as the absolute minimum acceptable ratio required to safely operate a ship.<sup>5</sup>

#### Shipboard Hierarchy, Duties and Responsibilities

Every man that joined a ship’s company was assigned a rating by the captain or first lieutenant. The rating was recorded in the muster book and determined pay scale and duties.

Boys and new volunteers were usually the lowest rates followed by landsmen, ordinary seamen and able seamen, petty officers, warrant officers, and commissioned officers.<sup>6</sup>

The ideal compliment for a 36-gun 5<sup>th</sup>-rate warship of the 1750's consisted of 240 men: four commissioned officers, 14 warrant officers, 36 petty officers, six idlers, 104-132 seamen and 45 marines with the remainder being servants and widow's men. Widow's men, fictitious seamen whose wages were contributed to the pension fund, were borne on the ship's books at a rate of two for every hundred crew.<sup>7</sup>

The *Pallas*' commissioned officers consisted of a captain and three lieutenants. The captain was in overall command of his vessel and its crew and was responsible for its sailing, manning, and upkeep. Before sailing, he was expected to oversee the assignment of ratings to the members of the crew and to draw up and post 'watch,' 'division,' 'station,' and 'quarter' lists. He was expected to obtain from the Clerk of the Survey a book listing the inventory of stores allotted to the boatswain, carpenter, gunner and purser of his ship and to confirm that it was in agreement with the individual inventories of those men. He was not permitted to make alterations to the spars, sails, or hull of his ship. Finally, he was expected to keep a complete journal recording the activities of the ship and its crew and to sign and submit a copy to the Admiralty and Navy Office after each voyage.<sup>8</sup>

Each lieutenant was expected to keep a list of the men in his watch and to frequently muster them, reporting any deficiencies to the captain. He was expected to visit below decks at night to see that there was no disorder, to ensure against unauthorized fire, candles or smoking, and to report any infractions to the captain. He was not permitted to change the course of the ship without orders except to avoid immediate danger. No boats were permitted to arrive or depart without the permission of the lieutenant on duty. In action, he was expected to ensure that the men were at their proper action stations performing their duties. The senior lieutenant

assumed command of the ship in the event of the captain's absence, illness or death. Lieutenants were required to supply themselves with the necessary instruments, maps, and books of navigation and, like the Captain, to keep a journal to be turned over to the Admiralty at the end of each voyage.<sup>9</sup>

The function of the master was to assist the captain in overseeing the fitting out of the ship. He was expected to oversee the loading of all stores, and to report any damaged goods to the captain. He was in charge of the receiving, loading, and distribution of ballast; he supervised the loading of the hold, and continually oversaw the redistribution of stores over the course of the voyage to ensure the ship's trim. He was charged with ensuring that compasses, glasses, log, and lead lines were kept in good order, and was responsible for navigating the ship in accordance with the orders of his captain or other superiors. He was further charged with observing all coasts and waterways and recording any new navigational details observed. When at anchor, he was responsible for keeping the hawse clear of fouls and obstructions. Finally, the master was expected to monitor and sign the accounts and logs of those below him and to ensure that he was thoroughly acquainted with their contents. Like the other officers, the master was required to supply himself with the necessary maps, instruments, and books of navigation and to keep a journal to be turned over to the Admiralty at the end of each voyage.<sup>10</sup>

The boatswain was in overall charge of the rigging, cable, anchors, cordage, and canvas—stores that he was expected to jealously guard against excessive waste. He was to inspect the rigging every morning and report his findings to the captain, to assist in changing the watches, and to ensure that the men carried out their duties. He was responsible for his own accounts, which had to be audited and vouched for by both the captain and master before being turned over to the Surveyor of the Navy.<sup>11</sup>

The sailmaker was required to inspect all of the sails taken onboard ship and to attend all surveys and conversions of the sails and rigging. He was expected to keep all of the sails in good repair and fit for service and was responsible for the drying and storage of all sails not in use. He was also expected to assist with hammocks and was instructed by the boatswain to cut up useless scraps of canvas to patch hammocks.<sup>12</sup> Gabriel Bray's sketch "The sailmaker ticketing hammocks on board the *Pallas*, November 1774" (Fig. 37) suggests that the sailmaker may also have been, in part, responsible for overseeing the stowage of hammocks.<sup>13</sup>

The gunner was in charge of the guns, gunnery tools, and stores of powder, ammunition and small arms. He was expected to oversee the maintenance and securing of the guns and their mountings. Before every voyage, he was required to apply to the storekeeper of His Majesty's ordnance for the ship's allotment of gunnery stores. He was expected to notify the captain when powder was brought aboard and to ensure the security and safety of the powder rooms.<sup>14</sup>

The carpenter oversaw the upkeep of the ship and ensured that the hull was sound and free of leaks. He was responsible for the maintenance of masts, yards, bulkheads, and cabins and for ensuring that the pumps were in good working order. He was to examine the masts several times a day and to report his findings to the officer of the watch. He was to keep a sufficient quantity of shot plugs made at all times, and during engagements, he and his crew were expected to continually inspect the hold for leaks. Upon reaching port, the carpenter was required to draw up a report of the condition of the ship's hull, masts and yards, and any repairs that were required.<sup>15</sup>

The surgeon took charge of the sick and injured. He was responsible for the sick berth, for organizing additional space when necessary, and was able to draw on the crew for additional help. The surgeon was required to pay particular attention to the cleanliness of the sick berth and to the overall cleanliness of the ship. He was to visit between decks every morning and make a

report to the captain. In foreign ports, the surgeon was expected to visit the local hospital and sick houses every second day (Tuesday and Thursday mornings in English ports) and submit a written report to the captain. Finally, the surgeon was expected to be present when punishments were administered.<sup>16</sup>

The purser had the key to the steward's store and was responsible for the inspection, maintenance, and distribution of its contents. It was his responsibility to procure funds from the navy and deliver them to the victualler, to ensure the honesty of the cook with regard to purchasing and dressing victuals, and to ensure the cleanliness of the steward's room. Like most jobs, responsibilities varied depending upon the captain; according to one captain, the purser was responsible for the candles in the lanterns taken on deck at night. The purser kept the ship's crew lists and the pay books, and was expected to provide the captain with a weekly report on the expenditure and inventory of all types of goods.<sup>17</sup>

The cook was responsible for the steep tub and answerable for the meat put therein. He soaked the meat to remove the salt and then boiled it. He oversaw the preparation, division, and distribution of the ship's food, and was expected to cut the meat ration fairly with regard to both quantity and quality. He ensured fair distribution of all foodstuff, being always on the lookout for messes trying to sneak a double ration—a not infrequent occurrence.<sup>18</sup>

Few frigates had a chaplain, if one was present, he served much the same purpose as his shore bound counterparts and in many cases also served as the shipboard schoolmaster. The schoolmaster was certified by the navy and was expected to instruct volunteers in writing, mathematics, and the theory and practice of navigation. He was expected to oversee the education of the boys according to a curriculum set out by his captain and to be diligent in his duty. He did not receive his pay without confirmation from his captain.<sup>19</sup>



The armorer and gunsmith assisted the gunner in the survey and receipt of small arms. They were expected to be conscientious in cleaning and maintaining the small arms and to undertake their repairs when possible.<sup>20</sup>

The master at arms drilled the petty officers and ship's company daily in the use of small arms. He placed and relieved the sentinels and inspected their weapons to ensure their cleanliness and maintenance. He attended the arrival and departure of all boats to prevent seamen from leaving the ship without permission, and he was expected to work with the officer of the watch to maintain order aboard ship.<sup>21</sup>

The thirty-six petty officers were composed of: two master's mates, six midshipmen, a captain's clerk, three quartermasters and three quartermaster's mates, a boatswain's mate, two yeoman of the sheets, a coxswain, a sailmaker's mate, a gunner's mate, a yeoman of the powder room, nine quarter gunners, a carpenter's mate, a steward, two corporals, and a trumpeter. The idlers were composed of sailmaker's crew and carpenter's crew.<sup>22</sup>

The ship's company was divided into each of several groupings with each man assigned to specific stations and duties within each grouping. At sea, all men-of-war maintained at least two watches. The body of the crew up to the rank of petty officer was divided into starboard and larboard watches with one watch being on deck at all times. Only the non-seaman officers (the purser, carpenter, surgeon and chaplain), were exempt from standing watch and not expected to answer 'all hands.' Each watch was four hours long except for the two two-hour dogwatches between four and eight in the evening (Table 2). A petty officer kept a half-hour sandglass and rang the ship's bell every time he turned the glass. No one on a watch got more than four hours of sleep at a time and often had to wake and turn out for 'all hands'; this happened more frequently on smaller vessels like frigates and sloops. The master and the lieutenants took turns as watch officer.<sup>23</sup> *Pallas* had four watch officers so each had 12 hours between watches.

The typical day at sea began when the navigation sightings were taken at noon. During the afternoon watch, the main meal of the day was eaten, the crew drilled and carried out routine maintenance, and the first grog ration of the day was issued. Supper was eaten during the dogwatches. During the first and middle watches the order was “hammocks down.” The morning began with the order ‘hammocks up’ at 4 a.m. The men arose, bundled their hammocks and stowed them in their assigned location in the hammock cranes along the rail. The ship was thoroughly cleaned and breakfast was eaten. The forenoon watch consisted mainly of drilling and maintenance.

Table 2: Depicting the standard watch schedule aboard Royal Navy Warships.

1 <sup>st</sup> watch	8 p.m. – midnight
Middle watch	Midnight – 4 a.m.
Morning watch	4 a.m. – 8 a.m.
Forenoon watch	8 a.m. – noon
Afternoon watch	Noon – 4 p.m.
1 <sup>st</sup> dog watch	4 p.m. – 6 p.m.
2 <sup>nd</sup> dog watch	6 p.m. – 8 p.m.

The crew was further divided into a number of divisions equal to the number of lieutenants with each lieutenant being responsible for the health and welfare of the sailors in his division. Each sailor had a particular ‘station’ for each of the ship’s specific maneuvers. He was required to know where to be and what his job was for each maneuver. Each sailor was ‘quartered’ to a specific part of the ship while in action; most were quartered as gun crew but some were quartered as top men, magazine help, or powder monkeys. Some were quartered to

assist the carpenter with damage control and others to the cockpit to assist the surgeon with casualties. Most men also had secondary duties while in action including trimming sails, fire fighting, working the pumps, repelling boarders, or serving in boarding parties. Finally the crew was divided into messes—usually about eight to twelve men who received and ate their food together.<sup>24</sup>

### Pay and Benefits

It has been proposed that the low rate of pay was one of the main reasons the Royal Navy had difficulty manning the fleet. An able seaman in the navy received twenty-four shillings, an ordinary seaman nineteen shillings, and a landsman eighteen shillings per month. From this was deducted sixpence a month for the Greenwich Hospital and one shilling to be divided between the surgeon, the chaplain, and the Chatham Chest—a pension established for wounded sailors and the widows of those killed in action. It was true that sailors could potentially earn much more serving aboard merchant ships or privateers, but like most government jobs, the lower pay scale came with certain benefits. A sailor in the navy was guaranteed his pay. A merchant sailor could spend months at sea and if the voyage was unprofitable he was liable to receive little or no pay; privateers received no pay, only a share in prizes taken at sea. Navy sailors could also expect to receive a share, albeit usually smaller, of prizes taken by their ship. Furthermore, the navy sailor had all of his overhead expenses taken care of; the navy provided food, a generous ration of alcohol and a place to sleep. Volunteers usually received an award or ‘bounty’ upon enlistment but the bulk of his pay was withheld until the end of his ship’s commission. Sailors discharged before then received a ticket redeemable on the date that that ship was paid off. When a navy sailor got paid, usually just before sailing on the next commission, he had few, if any, financial obligations. A navy sailor injured in the line

of duty would be provided for by the Greenwich Hospital. If permanently disabled he could expect to receive a modest pension from the Chatham Chest for the remainder of his life.<sup>25</sup>

### Discipline and Punishment

Discipline in the modern sense of the word—as a code of behavior imposed by the naval authority—did not exist *per se* in the 18<sup>th</sup>-century Royal Navy. Instead, what existed, amounted to a collective agreement amongst the seamen and officers to undertake the necessary steps to ensure the safety of the ship and the survival of its crew. The modern perception of perpetual animosity between the officers and crew has been greatly exaggerated. Seamen understood and respected the need for a structured chain of command and likewise most officers understood that extreme or unnecessary punishments only served to alienate the crew and adversely effected the smooth operation of the ship.<sup>26</sup> According to the *Royal Navy's Articles of War-1757*, officers aboard His Majesty's ships of war had the right to maintain a solemn, orderly and reverent atmosphere free from profanity and drunkenness. The use of personal violence by officers and mates to encourage performance of duty, was accepted by the crew as a necessary means of maintaining discipline. However, even in this there was established structure and set boundaries to be observed. Officers and petty officers could reasonably coax a malingering sailor with a well-placed blow of a knotted rope or rattan stave (referred to as 'starting') but beating a man was not permitted. Striking a man's face was considered unacceptable.<sup>27</sup>

Punishment for crimes committed aboard 18<sup>th</sup>-century Royal Navy warships is difficult to quantify. The most common punishment was flogging and the most common offence was, by far, drunkenness. For misdemeanors, suspension of grog ration or menial labor was a typical punishment. Various punishments were designed both to confine and to humiliate the offender; a man could be seized into the rigging for a period of time or placed in leg irons on the deck—

usually in a location where the entire ship's company could see him. A man who had committed a crime against the ship's crew, such as theft, could be sentenced to running the gauntlet—a punishment whereby all of the crew was given the opportunity to flog the offender as he passed among the assembled ship's company. Officers and petty officers could be disgraced but there was virtually nowhere to disgrace an ordinary or able seaman.

According to the Admiralty's *Regulations and Instructions Relating to His Majesty's Service at Sea*, no captain had the authority to administer more than twelve lashes. However, twelve lashes generally were seen by captains as the minimum punishment that justified assembling the ship's company. Any crime deemed worthy of a more severe punishment had to be tried by court martial, but a court martial typically returned sentences too severe to suit intermediate crimes. Furthermore, the squadron or port second-in-command and a panel of at least five officers had to preside over a court martial. A ship at sea could go months without assembling a quorum and, in practice, captains carried out the punishments themselves, administering more than twelve lashes or other punishments based on the severity of the crime.<sup>28</sup>

For more serious crimes a man could be keel hauled, or if in port, whipped through the fleet—taken from ship to ship and flogged in front of the assembled company of each. The only crimes dire enough to warrant capital punishment were espionage, cowardice or desertion in the face of the enemy, murder, and sodomy. Seamen were hung; officers were shot.<sup>29</sup>

### Accommodations

Hammocks first began to appear on Royal Navy warships in the early 17<sup>th</sup> century but it was not until the 18<sup>th</sup> century that they were officially adopted. In 1746, the Navy Board ordered that all ships be fitted with hammock cranes—a framework of U-shaped, wrought iron brackets mounted along the top of the rail. Hammocks were slung parallel to the keel of the ship on the

gun deck so that all swung in unison as the ship rolled. On larger warships men were allotted as little as 18 inches in which to hang their hammock, but on frigates the ratio of crew to space available was greater leaving considerably more space to spread out. When hammocks were not in use, they were stowed in the hammock cranes and covered with canvas to form a sort of parapet. This served several purposes; it provided organized storage away from the gun deck, it acted as a windbreak and, in combat, it provided some protection from musket fire and flying splinters. Frigates and sloops, having proportionately smaller crews and consequently fewer hammocks, usually arranged those that they did have on the quarterdeck and forecastle rails.<sup>30</sup> There were typically two hammocks issued per man but the boatswain ensured that the spares were conserved and protected against unnecessary or unauthorized use.<sup>31</sup>

The sailors' possessions were kept in large wooden sea chests that served both for storage and often as seating during mealtime and leisure. Like hammocks, each man's sea chest was assigned a specific storage location.

The officers and some of the warrant officers had the comfort of semi-private quarters. A frigate captain had the entire after section of the main deck, below the quarterdeck, as his personal cabin. He did not have the day cabin or dining room that captains of larger ships enjoyed but they were still relatively spacious and private quarters. The lieutenants, master, gunner, and marine officer each had a small berth in the aft area of the lower deck around the pantry area—frigates did not have a wardroom *per se*. The boatswain and the carpenter each had small berths on either side of the main mast on the lower deck, and the purser, surgeon, and steward all had small berths in the aft section of the orlop deck.<sup>32</sup>

## Food

The Navy Victualling Board issued each man standard weekly rations as follows: Sunday one pound of biscuit, one gallon of beer, one pound of pork, and a half pint of peas; Monday one pound of biscuit, one gallon of beer, one pint of oatmeal, two ounces of butter, and four ounces of cheese; Tuesday one pound of biscuit, one gallon of beer and two pounds of beef; Wednesday one pound of biscuit, one gallon of beer, a half pint of peas, one pint of oatmeal, two ounces of butter and four ounces of cheese. Thursdays were the same as Sundays, Fridays the same as Wednesdays and Saturdays the same as Tuesdays. On foreign voyages, the following authorized substitutions could be made. A half pint of brandy, rum or arrack could take the place of a gallon of beer. Four pounds of flour or three pounds of flour, a pound of raisins, a half-pound of currents and a half-pound of beef suet equaled four pounds of beef or a two pound piece of pork with pease. A half-pound of rice was equal to a pint of oatmeal, and a pint of olive oil was equal to a pound of butter or two pounds of Suffolk cheese or a pound and a third of Cheshire cheese.<sup>33</sup>

Messes on Royal Navy warships were typically composed of eight to twelve men. On frigates like *Pallas* this number was probably considerably lower. One source suggests that on a 38-gun frigate of the *Diana* class, if six feet (1.83 m.) (the length of a hammock) were allowed for each mess table, there would be room for twelve tiers of tables. With an inner and outer tier on each side, for a crew of 240 men including officers, each mess would seat four to five men. Even if only outer tiers were used, each mess would average about nine men.<sup>34</sup> The mess captain collected the allotment for his entire mess in a wooden tub. Each man had his own spoon and cup and all messmates ate out of the same tub. Bray's watercolor of a marine mess on board the *Pallas* shows that mealtime was rather informal and suggests that neither mess tables nor sea chests were necessarily used during mealtimes (Fig. 39).<sup>35</sup>

All provisions were packed in casks and the beef and pork were salted and pickled in casks. While in port, the biscuit was replaced by bread, and fresh meat was to be provided twice a week when it was possible and convenient. Victualling vessels with a cargo consigned to one ship could not be waylaid by another captain and the provisions were to be turned over to their intended ship without charge to the purser. If the contents of a cask appeared spoiled when it was opened, a survey was carried out by a panel of officers and if the contents were found unfit for consumption, the purser was credited with its value.<sup>36</sup>

Analysis of Royal Navy records shows that for the period 1750-57 the total proportion of condemned foodstuffs issued by the victualling board amounted to less than one percent of that issued. This was accomplished by the scrupulous use of only the best ingredients and continual experiment and development. Great care was taken to ensure that stock was turned over and two years was considered to be the maximum time that beef or pork should be stored in a cask even at the end of long supply lines. The diet was plain and repetitive but provided more than sufficient calories for the hard physical work of a seaman. When compared with the diet of the population ashore, that of the seaman was quite extravagant, providing a daily hot meal, a beer ration every day, and meat four times weekly.<sup>37</sup> This serves as yet another example of why, despite the rigors and hardships, many men chose a life aboard a Royal Navy warship.

### Dress

The common seaman in the 18<sup>th</sup> century was not required to wear a prescribed uniform. His choice of clothing was instead dictated by the working conditions aboard ship. That they dressed differently from landmen, and in a distinctive fashion, is certain. Seamen were immediately identifiable on land and were equally able to identify landmen. Newly inducted landmen were the object of considerable derision and mistrust until they got their seaman's



clothes. The Marine Society was founded in 1756 in part to ensure that seamen and boys went to sea properly attired. A 1757 list of the clothing supplied by the Society to men and boys included:<sup>38</sup>

Table 3: Showing the list of clothing provided to Royal Navy seaman and boys by the Marine Society. After Robinson, "British Seaman's Dress," 325-7.

1 leather cap	2 pair shoes
2 worsted caps	2 pair pett-duck trousers
3 hand kerchiefs	2 Hessen frocks
3 7/8ths check shirts	1 ticken mattress
1 striped flannel waistcoat	1 pillow
1 pair half-thick browns drawers	1 blanket
1 settee-waistcoat, blue duffil lined lapelled	1 coverlet
1 pair Russia-drab breeches	1 pair buckles
2 pair check drawers	1 pair buttons
2 pair yarn hose	1 sewing kit
2 pair worsted hose	1 knife

Clothing was often available for sale aboard ship from the ship's 'slops,' a small store of items maintained by the purser. Most sailors were acquainted with the rudiments of sewing, and often sewed strips of canvas over the seams of their clothing to extend wear. Shoes were typically avoided unless the weather was unusually cold. Waistcoats or vests were worn in cold weather and all seamen had an oilskin or some other form of water-resistant clothing.<sup>39</sup>

The Royal Navy first introduced a specified uniform for officers and midshipmen in 1748. Until that time, it was the only maritime power not to have a distinctive uniform for its officers. The new uniforms varied by rank but generally were similar except for decorative detail.

The coat was blue with white trim, the waistcoat was white kersymere trimmed with lace. The cloth was Prussian blue and very thick. The sleeves were cut short to allow the lace of the waistcoat to show. Breeches were either white or blue kersymere and the three cornered hat was blue with lace trim.<sup>40</sup> Officers had dress uniforms for formal occasions and undress uniforms for day-to-day wear at sea—the latter often made them indistinguishable from the common seamen. Officers were required to pay for their uniforms.

### Health and Hygiene

In the Royal Navy during the 18<sup>th</sup> century, far more sailors died as a result of sickness than died in battle. Malnutrition, communicable disease, and insect-borne fevers were the most common ailments encountered by ship surgeons. In addition, a high occurrence of food poisonings and dysenteries were common ailments capable of decimating whole crews. Scurvy, typhus, and pulmonary tuberculosis were the most common culprits in tropical latitudes. Fevers such as malaria, yellow fever, and undulant fever were a chronic problem. Whole ship's crews and even whole squadrons could be wiped out by fever in a relatively short period of time. In one famous incident, a Caribbean squadron under the command of Admiral Hosier lost 4000 to 5000 men to tropical fever (probably yellow fever) during the years 1726-27.<sup>41</sup>

By the early 17<sup>th</sup> century the deficiency of fresh fruits and vegetables was recognized as the cause of scurvy. However, it was not until navy surgeon James Lind submitted his comprehensive document, *A Treatise of the Scurvey*, (1753), that the Royal Navy instituted permanent preventative measures to counter its occurrence—including citrus fruit or juice as a part of the regular victuals.<sup>42</sup>

During the 18<sup>th</sup> century, the cause of typhus was thought, as with many diseases, to be impure air, bad smells and confined spaces. It was not until 1909 that it was understood to be

transmitted by lice. Having made the association between lack of cleanliness and typhus, great effort was made to maintain a clean environment aboard Royal Navy warships. One disease that actually was the result of impure air and poor ventilation was tuberculosis.

The majority of the collectively-termed tropical fevers that plagued sailors during this period were poorly understood and believed to be contagious. Although associations were made between swampy environments and tropical fever, it wasn't until 1847 that the direct connection between fevers and biting insects was made.

Every effort was made to improve hygiene aboard Royal Navy warships throughout the 18<sup>th</sup> century and cleaning became a regular part of day-to-day activity. Conditions were further improved during the 1740s and 1750s when Admirals Boscawen and Hawke campaigned for the installation of below-decks ventilators.

An additional factor to be considered was the physical environment. Ships, especially sailing ships, were dangerous places and the risk of physical injury from falls, falling objects, over straining, and other mishaps was much higher than on land. Finally, moisture and cold would have then, as it still does today, contributed to a much higher incidence of arthritis amongst sailors.<sup>43</sup>

One of the more interesting topics relating to shipboard health and hygiene was the sanitary arrangements aboard ship. Privacy was of little consequence and there were a number of ways a seaman could answer the call of nature. The easiest and most time-honored methods were to go to the channels on the lee side of the ship and urinate off the side or, grabbing hold of the shrouds, to hang out over the water and defecate. The wind and heel of the ship would ensure that the waste was carried well clear of the sides. By the middle of the 17<sup>th</sup> century, round enclosures were added to the channels of larger ships. By the 1620s, the beakhead also became universally accepted as a place for men to relieve themselves and by the 1680s purpose-built

'seats of easement' began to appear on ships. These were simple boxes with a round or key-shaped hole in the top and a conduit to direct the waste clear of the ship. By the late 18<sup>th</sup> century, three rows of multiple seats became common on larger ships; however there was usually less than one seat for every one hundred crewmen on board. Another sanitary arrangement that began to appear in the late 17<sup>th</sup> century was the piss-dale—a urinal-like fixture mounted on the bulwarks near the waist of the ship with the waste being carried out in a manner similar to scuppers. By the middle of the 17<sup>th</sup> century, officers were usually afforded the privilege of enclosed private heads located in the quarter galleries.<sup>44</sup>

### Leisure

The 18<sup>th</sup> century Royal Navy seaman relished his infrequent leisure time aboard ship and put it to good use. Typically, simple pleasures such as fishing, sleeping, reading, writing, drinking, and smoking were the most common. Games such as draughts (checkers), cards, and dice were common among the crew with chess being the preferred game of officers (Figs. 36, 38 and 43). Yarning (storytelling) was a highly developed and appreciated talent amongst sailors of the day. Arts and crafts such as rope work, macramé, embroidery, carving, model-making, painting, and sketching were also popular leisure pastimes and have provided the world with some great surviving maritime artifacts from which a great deal of anthropological data can be drawn.

There is little doubt that common 18<sup>th</sup>-century Royal Navy seamen lived a rugged, dangerous, and physically demanding existence. They lived, worked, and slept together in the absolute minimum of space and could expect to go years without seeing their families and loved ones. They risked a high mortality rate and received relatively little pay. However, it is equally true that they enjoyed numerous benefits unavailable to the common landmen. They were part of

a proud, close-knit, supportive, and deeply loyal community. They generally ate better than their land-bound counterparts (if somewhat more monotonously) and had access to top-notch (for the day) medical attention. They also had access to basic education, and there is considerable evidence that a great many learned to read and write while serving aboard Royal Navy warships. They were able to travel and visit exotic ports of call. Finally, if they survived to retirement or were crippled in the line of duty, they could expect to receive a modest pension from His Majesty's government.

### Notes

<sup>1</sup> Rodger, *Wooden World*, 150.

<sup>2</sup> *Ibid.*, 177

<sup>3</sup> *Ibid.*, 145-52.

<sup>4</sup> *Ibid.*, 26.

<sup>5</sup> *Ibid.*, 26-7.

<sup>6</sup> Blake and Lawrence, *Nelson's Navy*, 66.

<sup>7</sup> Rodger, *Wooden World*, 348-51.

<sup>8</sup> Lavery (ed.), *Shipboard Life and Organization*, 9-14.

<sup>9</sup> *Ibid.*, 23-5.

<sup>10</sup> *Ibid.*, 25-7.

<sup>11</sup> Anonymous, *Observations and Instructions*, "Orders to the Boatswain", Lavery (ed.), *Shipboard Life and Organization*, 27-8, and Mountaine, *Seaman's Vade Mecum*, 53-4.

<sup>12</sup> Anonymous, *Observations and Instructions*, "Orders to the Boatswain", and Mountaine, *Seaman's Vade Mecum*, 53-4.

<sup>13</sup> Spavens, *Memoirs of a Seafaring Life*, 123 and Quarm, "An Album of Drawings by Gabriel Bray," 39.

<sup>14</sup> Lavery (ed.), *Shipboard Life and Organization*, 29-36.

<sup>15</sup> Anonymous, *Observations and Instructions*, "Orders to the Carpenter" and Lavery (ed.), 1998, 38.

<sup>16</sup> Anonymous, *Observations and Instructions*, "Orders to the Surgeon".

<sup>17</sup> Anonymous, *Observations and Instructions*, "Orders to the Purser" and J.L., *Sea-Man's Vade Mecum*, 142.

<sup>18</sup> Perrin, *Boeteler's Dialogues*, 14-15, Lavery (ed.), *Shipboard Life and Organization*, 44, and Montaine, *Seaman's Vade Mecum*, 68.

<sup>19</sup> Lavery (ed.), *Shipboard Life and Organization*, 43 and Rodger *Wooden World*, 23-4.

<sup>20</sup> Lavery (ed.), *Shipboard Life and Organization*, 36-7.

<sup>21</sup> Lavery (ed.), *Shipboard Life and Organization*, 41-2.

<sup>22</sup> Rodger, *Wooden World*, 348-51.

<sup>23</sup> Rodger, *Wooden World*, 39-40.

<sup>24</sup> Lavery (ed.), *Shipboard Life and Organization*, 242-55.

<sup>25</sup> Rodger, *Wooden World*, 124-29.

<sup>26</sup> Rodger, *Wooden World*, 205-11.

<sup>27</sup> Rodger, *Wooden World*, 211-17.

<sup>28</sup> Rodger, *Wooden World*, 218-22.

<sup>29</sup> *Royal Navy Articles of War 1757, Articles 1-35.*

- <sup>30</sup> Goodwin, *Construction and Fitting*, 210-11.
- <sup>31</sup> Anonymous, *Observations and Instructions*, Orders to the Boatswain, Blomfield, "Hammocks and Their Accessories," 146-7 and Mountaine *Seaman's Vade Mecum*, 53-4.
- <sup>32</sup> Lavery *Construction and Fitting*, 165.
- <sup>33</sup> Mountaine, *Seaman's Vade Mecum*, 72.
- <sup>34</sup> Lavery (ed.), *Shipboard Life and Organization*, 244-5.
- <sup>35</sup> Spavens, *Memoirs of a Seafaring Life*, 107, and Quarm, "An Album of Drawings by Gabriel Bray," 39.
- <sup>36</sup> Montaine, *Seaman's Vade Mecum*, 71-4, and Rodger, *Wooden World*, 82-7.
- <sup>37</sup> Rodger, *Wooden World*, 84-5.
- <sup>38</sup> Robinson, "British Seaman's Dress," 325-7.
- <sup>39</sup> Rodger, *Wooden World*, 94-95.
- <sup>40</sup> Manwaring, *A Bibliography of British Naval History*, 105-13.
- <sup>41</sup> Marcus, *Heart of Oak*, 128.
- <sup>42</sup> This is where the practice of referring to the British as 'limeys' originated.
- <sup>43</sup> BR2193- *Handbook for Royal Navy Medical Officers*, Articles 0101-0107, Lind, *Treatise of the Scurvy*, "Of the Prevention of the Scurvy," and Marcus, *Heart of Oak*, 128-42.
- <sup>44</sup> Lavery *Construction and Fitting*, 201-3.

## CHAPTER VI

HMS *PALLAS*: SERVICE HISTORY

An examination of the service history of the frigate *Pallas* will demonstrate the role frigates played in British strategic policy, the kinds of duties and responsibilities typically assigned to them and will clearly illustrate the demanding maintenance requirements of all active Royal Navy warships of the era.

At the outbreak of war with France in April 1756 the Royal Navy was acutely aware of the inadequacy of its cruiser fleet. In order to protect British maritime trade and military convoys from French predations and to carry the *guerre de course* to the French, more and better cruisers were desperately needed. In response the Admiralty ordered nine new 32 and 36-gun frigates. It was believed that these new designs could compete with and hopefully surpass their French counterparts.

On August 31, 1757, the 128-foot hull of the Royal Navy's newest warship class slid down the slipway of the Wells shipbuilding firm at Deptford and into the Thames River.<sup>1</sup> The ship, commissioned HMS *Pallas*, was one of the Royal Navy's new classes of 36-gun, 12-pound frigates.<sup>2</sup> These frigates, the 32-gun *Richmond* class designed by William Bately<sup>3</sup>, and the 32-gun *Southampton* class,<sup>4</sup> and the 36-gun *Pallas* class<sup>5</sup> designed by the recently appointed Surveyor of the Navy, Thomas Slade, were developed in the early 1750's, in response to a perceived French superiority both in the sailing qualities and gun power of their cruisers.<sup>6</sup> The designs for all three classes placed all of the guns on the main deck, quarterdeck and forecastle, leaving the lower deck free for living space and the extra stores that would allow them to cruise for months without putting in for provisions. The new frigates possessed the speed and sailing qualities needed to elude larger warships and the strength to overpower any pirate, smuggler or

privateer encountered. The completed hull of *Pallas*, on the day she was launched, lacked any major fittings other than lower masts and bowsprit. She carried no ballast, raising considerable concern regarding her stability until she could be floated into position and lashed alongside HMS *Gibraltar* (24), for fitting out.

On September 3<sup>rd</sup>, Captain Archibald Cleveland arrived at Deptford and took possession of *Pallas*. For the next month he supervised the final fitting out, crewing and provisioning prior to her shakedown cruise to Long Reach, Gravesend and The Nore.<sup>7</sup> The remarkably hasty fitting-out period for *Pallas* is testimony to the urgency of the navy to supplement its cruiser fleet.

On the morning of October 29, 1757 *Pallas* sailed with HMS *Shannon* (36), on her first operational cruise with orders to support Admiral Edward Hawke's squadron blockading the French fleet at Brest (Map 2). On the following day, having lost sight of *Shannon* and sailing alone, *Pallas* brought to several Dutch vessels.

Over the next month, *Pallas* patrolled with the squadron blockading the French fleet in Brest. During this period she was variously in company with *Shannon*, HMS *Medway* (60), HMS *Dolphin* (20), HMS *Unicorn* (28), HMS *Ramillies* (90), HMS *Royal George* (100), and HMS *Southampton* (36), occasionally breaking away to pursue unidentified sails. On November 3<sup>rd</sup>, after a long chase, *Pallas* captured her first prize, a French privateer. Other than generally poor weather, no other notable events were reported during this period. The deteriorating weather began to take its toll on the fleet; damaged ships and support vessels began returning to Spithead and on December 15<sup>th</sup> *Pallas* received word that the remainder of the fleet should begin working to Spithead to ride out the weather.

The weather had obviously taken its toll on *Pallas*. On December 21, 1757 a pilot came aboard to bring her into Portsmouth harbor for repairs. Over the following ten days, the guns and



powder were removed, the main and mizzen shrouds were replaced, the blocks and rigging were overhauled, new gammoning was installed on the bowsprit, iron ballast was removed to adjust the trim and the hull was re-caulked. By the end of December, re-provisioning and re-rigging were completed and the masts had been scraped and payed with pine varnish. On January 12, 1758 she was moved from Portsmouth harbor to Bembridge Point and on the 15<sup>th</sup> she sailed to join HMS *Eagle* (60) and HMS *Torbay* (74) patrolling the Biscay coast about 200 miles (325 km.) southwest of Brest. Over the next two months she patrolled west and southwest of Brest enforcing the blockade of French commerce (Map 2).

On February 14<sup>th</sup> *Pallas* returned to Plymouth Sound for general maintenance. On February 20<sup>th</sup> it was discovered that the foremast was sprung under the upper wedges. The foremast was removed the following day and on February 23<sup>rd</sup> *Pallas* was hauled into dry dock where caulkers were employed in breaming the ship's bottom. February 25<sup>th</sup> and 26<sup>th</sup> were spent installing and rigging the new foremast.

By March 1<sup>st</sup>, *Pallas* had been re-provisioned and moved out into Plymouth Sound. On March 3<sup>rd</sup> she sailed with HMS *America* (60) to patrol southwest of Plymouth. On the second day her foremast stay parted. It is interesting to note that she did not immediately return to Plymouth, but continued to patrol for two weeks encountering mostly British convoys bound for the Americas. On March 17<sup>th</sup> *Pallas* re-entered Plymouth Sound. March 18<sup>th</sup> was spent fixing the lower rigging, un-reaving the bad running rigging, and reaving new running rigging. On March 20<sup>th</sup>, the crew un-rigged the fore and main topmasts and re-rigged them the following day. On March 22<sup>nd</sup>, *Pallas* once again made sail and returned to her patrol.

Between March 23<sup>rd</sup> and April 28, 1758 while patrolling off the southwest coast of England, there were two notable encounters. At Land's End on the 31<sup>st</sup>, *Pallas* sighted and pursued a French frigate—her first encounter with an enemy warship. There was little or no wind

and the Frenchman used sweeps to evade capture. On April 17<sup>th</sup>, just to the north of Le Havre, *Pallas* liberated a British merchant ship taken by a French privateer (Map 2).<sup>8</sup> During this period it appears that there was considerable concern on the part of the Admiralty regarding fever aboard English warships and orders were issued that all ships should be washed with vinegar.<sup>9</sup>

On April 18, 1758 *Pallas* dropped anchor at Spithead, and on April 24<sup>th</sup> was taken into Portsmouth (Fig. 2) for general maintenance where the main and mizzen masts were found, like the foremast before them, to be sprung. Either the ship was being driven hard or the quality of the mast timber was poor. Since *Pallas* had been built during the first months of the war and priority was given to the construction of frigates it is reasonable to assume that stockpiled seasoned timber was employed in the hull construction—the longevity of *Pallas* hull supports this view. However, by the time *Pallas* was launched, stockpiles of seasoned masts and spars would have been used up servicing active ships and in fitting-out ships brought out of ordinary. Therefore *Pallas* probably received sub-standard masts and spars. The new main and mizzen masts were stepped and re-rigged by May 10<sup>th</sup>. Having been re-provisioned *Pallas* made ready to sail, but on the following day, the foremast was found to be sprung beneath the woodings. *Pallas* remained in Spithead until June 1<sup>st</sup> replacing the foremast and carrying out general maintenance.<sup>10</sup>

There is a gap in the logbooks from June to October of 1758. However, it is known that on June 6<sup>th</sup> *Pallas* took part in the destruction of shipping and storehouses at St. Malo and that from August 6<sup>th</sup> to the 17<sup>th</sup>, *Pallas* participated in Admiral Richard Howe's raids on Cherbourg. On August 7<sup>th</sup> Howe temporarily transferred his flag to *Pallas* so that he could stand in closer to shore during the operation.<sup>11</sup> By October 6<sup>th</sup>, *Pallas* was back at Portsmouth undergoing a major overhaul. The lower masts were replaced and re-rigged, a new best bower cable was taken aboard, and she was hauled into dry dock for breaming, caulking, and blacking. Once again this

illustrates the hard service that frigates were subjected to and the shortage of quality timber available to the Royal Navy as the war progressed. On November 1<sup>st</sup>, the ship's company received its first distribution of prize money.<sup>12</sup> Provisioning was completed by November 6<sup>th</sup> and *Pallas* was moved to Spithead where she remained at anchor until November 11, 1758.

The following day, *Pallas* set sail from Spithead with orders to escort HMS *Saltash* (14), which was carrying silver to pay the garrison at Senegal, and to then join up with Admiral Augustus Keppel's fleet off West Africa.<sup>13</sup> On November 17<sup>th</sup> the fleet was sighted and they joined company with *Torbay* and 16 merchant ships (referred to in *Pallas*' logbooks as 16 sail). *Pallas* parted company with the fleet on November 20<sup>th</sup>, just off Lisbon, dispatched back to England.<sup>14</sup> For the remainder of 1758 *Pallas* patrolled the Bay of Biscay as far north as Le Havre, at various times in company with HMS *Actæon* (28), *Deptford* (50), *Essex* (64), *Windsor* (60), and the *Rochester* privateer (Map 2).

On January 1, 1759, *Pallas* returned to Portsmouth for general maintenance. On January 30<sup>th</sup> after maintenance and provisioning she joined a large fleet anchored at Spithead under the command of Admiral Charles Holmes. On February 14<sup>th</sup>, *Pallas* set sail in company with HMS *Chatham* (50), HMS *Falkland* (50), HMS *Chichester* (70), and HMS *Boreas* (28), escorting an outbound East India convoy. Together they patrolled the southern approaches until February 24<sup>th</sup> when *Chichester* and *Chatham* parted company leaving *Falkland* in command of the convoy. On March 12<sup>th</sup>, the four ships met up with again. On the same day the main mast of *Pallas* was found to be sprung. The following day, the carpenter from *Boreas* came aboard to assist in woolding the mast. *Pallas* parted company with *Boreas* on March 14<sup>th</sup>, came safely to anchor at Spithead two days later, and the following day was moved into Portsmouth Harbor. Over the next ten days, the main mast was replaced and general maintenance and provisioning were carried out.

On April 4, 1759, *Pallas* set sail in company with *Essex*, and the *Jamaica* sloop and anchored at Needle Point. They were joined by *Chatham* on the following day and commenced their patrol of the French coast. For the next three weeks, the four ships patrolled off Brest enforcing the commercial blockade, bringing-to numerous vessels, and liberating a Jamaican prize taken by the French (Map 2). On April 26<sup>th</sup>, *Essex* (64), and *Chatham*, returned to Plymouth with the prize and *Pallas* made for Portsmouth. From April 29<sup>th</sup> to May 21<sup>st</sup>, *Pallas* rode at anchor at Spithead and carried out general maintenance in Portsmouth harbor. There she joined an assembled fleet that included HMS *Nottingham* (60), HMS *Hercules* (74), HMS *Venus* (36), and HMS *Minerva* (32), as well as *Chatham* and *Essex*.

At some point during the beginning of June Captain Archibald Cleveland departed and Captain Michael Clements took command of *Pallas*.<sup>15</sup> Clements would remain captain until *Pallas* was paid off in January 1764.<sup>16</sup> On June 18, 1759 *Pallas* sailed from Spithead in the company of HMS *Rochester* (50) and a cutter with orders to patrol the Channel coast and the Bay of Biscay near Brest. On July 5<sup>th</sup>, *Pallas* stood into Brest harbor firing on French ships there and at the shore batteries at St. Matthew's Convent. From July 6<sup>th</sup> to 16<sup>th</sup>, *Pallas* continuously harried the French at St. Matthew's Convent and in Brest harbor (Map 2). On the following day she turned for home and on July 18<sup>th</sup> entered Plymouth Sound. Over the course of the next week she was heeled and her bottom cleaned and the crew carried out general maintenance and loaded provisions aboard.

On July 28<sup>th</sup>, *Pallas* sailed from Plymouth in company with HMS *Hero* (74), HMS *Sapphire* (32), *Southampton*, and *Venus* to relieve Admiral Hawke's force blockading the French ports of Brest and Le Havre. *Pallas* remained with Hawke's fleet through the summer without notable encounter and returned to Plymouth Sound on October 3<sup>rd</sup>.<sup>17</sup> She spent the next two

weeks having a sprung bowsprit replaced, carrying out general maintenance and loading provisions for three months at sea.

On October 19, 1759 *Pallas* set sail from Plymouth Sound with orders to patrol the French coast of the Bay of Biscay around Quiberon Bay, Belle Isle, and the Isle of Groa (Ile de Groix) (Map 2). Between October 29<sup>th</sup> and November 14<sup>th</sup> she was variously in company with HMS *Vengeance* (28), HMS *Firm* (50), HMS *Maidstone* (28), *Chatham*, *Venus*, *Sapphire*, *Southampton*, and the *Swallow* sloop. There is a gap in the logbooks in the crucial period from November 15<sup>th</sup> until January 5, 1760, but it is known that *Pallas* joined Hawke's fleet on the 15<sup>th</sup> and that on the same day the sloop of war *Fortune* arrived with news that the French Grand Fleet was making for Quiberon Bay.<sup>18</sup> *Firm* and *Southampton* were dispatched to carry the news to Hawke's fleet and *Pallas* was dispatched to carry the news to the commanders of *Fame* and *Windsor*, cruising off of Finisterre, with a request to bring out the remainder of their squadron.<sup>19</sup> On November 19<sup>th</sup>, Hawke's combined fleet crippled the French fleet at the Battle of Quiberon Bay, essentially ending any threat of a French cross-channel invasion of England.

*Pallas* returned to Plymouth on January 5, 1760 where she remained until January 29<sup>th</sup> carrying out general maintenance and provisioning. The following day she sailed with her sister ship HMS *Brilliant* (36) with orders to patrol St. George's Channel between Ireland and Wales (Map 2). For more than two weeks they patrolled south and southwest of Ireland and on February 18<sup>th</sup> came to anchor at Kinsale Harbor in southern Ireland. General maintenance was carried out until February 25 when *Pallas* and *Brilliant*, accompanied by HMS *Æolus* (32), resumed their patrol. On February 28<sup>th</sup>, *Pallas*, *Brilliant*, and *Æolus* encountered three strange ships and gave chase. They proved to be the French frigates *Marechal de Belle Isle* (44), *La Blond* (36) and *Terpsichore* (24).<sup>20</sup>

The French frigates had been dispatched from Dunkirk in October with a small detachment of troops under the command of the renowned privateer Captain François Thurot with orders to sail north and land a diversionary force in Ireland in preparation for the cross-channel invasion. Thurot's passage around northern Scotland had been plagued by bad weather delaying his arrival off the Irish coast for several months. Unaware that the invasion had been thwarted by Hawke at Quiberon Bay the previous fall, Thurot carried out his assignment temporarily landing a small force near town of Carrickfergus.<sup>21</sup>

The two squadrons engaged off the Isle of Man and after a short, hour and-a-half long battle, all three French ships were taken (Fig. 34). *Pallas* suffered sail and rigging damage, a shot through the mainmast and had her best bower was shot away. The three French prizes were taken to Ramsey Bay where the prisoners were put ashore and temporary repairs were made. On March 6<sup>th</sup>, *Pallas*, *Brilliant*, *Æolus*, *Weasel* sloop and the three prizes sailed for Plymouth, stopping at Kinsale Harbor on the way, and arriving at Plymouth Sound on March 26<sup>th</sup>.<sup>22</sup> For the next two weeks *Pallas* underwent repairs.

On April 9<sup>th</sup> *Pallas* returned to patrolling the French channel coast near St. Matthew's Convent and Brest (Map 2). On April 16<sup>th</sup>, lookouts sighted a sail and *Pallas* gave chase. The ship proved to be French and the two ships exchanged fire. During the engagement the French ship was ran aground so violently that her masts fell. *Pallas* wore and raked her to finish the job.<sup>23</sup> On April 17<sup>th</sup> *Pallas* joined company with HMS *Shrewsbury* (74) and they remained in contact until *Pallas* returned to Plymouth sound on May 24<sup>th</sup>. She remained in Plymouth between May 25<sup>th</sup> and June 16, 1760 undergoing a major overhaul, and departed on June 17<sup>th</sup> bound for service in the Mediterranean.<sup>24</sup>

On June 23<sup>rd</sup>, about 100 miles (160 km.) southwest of Brest, *Pallas* again sprung her foremast. She continued south for two weeks, sighting the rock of Lisbon on July 3<sup>rd</sup>, passing off

Cadiz on July 4<sup>th</sup>, and arriving at Gibraltar on the following day. *Pallas* spent a week in Gibraltar having her foremast repaired and taking on provisions. She sailed on July 12<sup>th</sup> and patrolled off Europa Point and Gibraltar for the next week. On July 24<sup>th</sup>, she began to work eastwards and, on July 29<sup>th</sup>, came to anchor at Majorca. On August 7<sup>th</sup>, she departed Majorca bound for Malta, arriving there four days later (Map 3).

There is a gap in the *Pallas*' logbooks from August 11, 1760 until the beginning of October. However, it is known that *Pallas* joined up with Admiral Charles Saunders' fleet blockading the French Fleet at Toulon. At some point after July 12<sup>th</sup> *Pallas*, *Shrewsbury*, and HMS *Argo* (28), engaged in a running battle with the French 74-gun *Diadème* escorting a convoy to Martinique. *Shrewsbury* was a poor sailor and it was left to the frigates to harass and slow *Diadème* until *Shrewsbury* could catch up. Unfortunately, *Pallas* exposed herself to a broadside from *Diadème*, suffered significant damage, and was forced to break off the pursuit. *Diadème* later took part in both the Battle of the Capes (that forced the surrender of the British Army at Yorktown), in October, 1781 and Battle of the Saints, April, 1782.<sup>25</sup> It is probable that most of the remaining period missing from the logbook was spent at Gibraltar making repairs to the damage inflicted by *Diadème*.

In early October, 1760 *Pallas* returned to patrolling in the western Mediterranean around Malta and Cape Angelo with HMS *Somerset* (64), HMS *Dunkirk* (60), HMS *Shannon* (36), and *Shrewsbury*.<sup>26</sup> For the next five months in late 1760 and early 1761, *Pallas* patrolled the western Mediterranean calling variously at Messina in Sicily, Malta, Tunis, Leghorn (Livorno, Italy), and Cagliari Bay for maintenance and provisions. The only incident of note was the capture of a French prize off Cape Negro, Morocco (Map 3).<sup>27</sup>

There is month-long gap in the logbooks from April 30<sup>th</sup> to June 5, 1761. From June 6<sup>th</sup> to 19<sup>th</sup>, *Pallas* was once again moored in Malta where she took on provisions, had her rigging

overhauled and carried out general maintenance. Another month-long gap occurs from June 19<sup>th</sup> to July 23<sup>rd</sup>. From July 24<sup>th</sup> to September 1<sup>st</sup>, *Pallas* was moored in Leghorn. There she underwent a complete refit: careening, caulking, and breeming. The decks, masts and sides were scraped and payed. New masts were stepped and new rigging was installed, and the whole ship and the gun carriages were painted. *Pallas* sailed from Leghorn Road in early September 1761 on a five-month patrol of the western Mediterranean, the eastern approaches to Malta and the ‘Strait of Sicily’ (presumably the Straits of Messina), periodically calling at Messina, Tunis and Malta before returning to Gibraltar on March 16, 1762 (Map 3). While there she was overhauled and the crew was employed in picking oakum before sheathing the hull.<sup>28</sup>

Departing Gibraltar on May 1, 1762 *Pallas* sailed out to patrol up the east coast of Spain to Villefranche Bay east of Nice, arriving on May 11<sup>th</sup>. *Pallas* remained at Villefranche for several weeks taking on provisions and carrying out general maintenance before returning to Gibraltar in late May.<sup>29</sup> For the next eight months she patrolled off Cadiz, Cape Trafalgar, the Atlantic approaches to Gibraltar, and the Atlantic coast of Morocco, returning periodically to Gibraltar or Lagos Bay for provisions and general maintenance. The only incident of note took place on July 23<sup>rd</sup> in Cadiz harbor when *Pallas* was attacked by two xebecs—low fast coastal vessels—which were driven off after suffering heavy casualties.<sup>30</sup>

On February 10, 1763 the war with France came to an end with the signing of the Treaty of Paris. News of the peace had probably not yet reached Gibraltar when, on February 17 1763, *Pallas* sailed with *Dunkirk*, *Chichester*, and a convoy of merchant vessels bound for England. On February 26<sup>th</sup>, *Pallas* parted company with the convoy and entered Lisbon Harbor where she remained moored until March 14<sup>th</sup> when she returned to Gibraltar. *Pallas* remained moored in Gibraltar or Cadiz from March 18 until the end of April, sailing in early May to patrol the south coast of France and western Italy, calling at Cagliari, Genoa, and Leghorn (Map 3). By the first



week of July she had returned to Gibraltar for provisions and general maintenance. From July until late November 1763 she was moored intermittently between Gibraltar and Cadiz. On November 22<sup>nd</sup> she sailed for Lisbon en route to Spithead, arriving on December 21<sup>st</sup>. A pilot came aboard the following day to bring her into Portsmouth harbor and between December 22<sup>nd</sup> and January 13<sup>th</sup>, *Pallas* was stripped of her spars and fittings and placed in ordinary. On January 14, 1764, the crew was paid off.<sup>31</sup> This completed a period of over six years of active service in home waters and in the Mediterranean. The logbooks clearly show that *Pallas* was worked hard throughout this period displaying both her utility and durability.

The stripped hulk of *Pallas* languished in the ordinary yard at Portsmouth for nearly seven years before she was once again commissioned in early October 1770 and a new commander, Captain John Laforey, took possession.<sup>32</sup> During the period of her working up, from October until March of 1771, she was either in Portsmouth harbor or at Spithead. A letter exists from Captain Laforey to the Admiralty requesting authority to crew her, and several letters from Laforey to the Admiralty during that period describe both chronic illness and personal problems. In one letter he simply asked to be replaced, in his next letter he claimed to be so ill that he could not travel without endangering his health and in his final letter he requested leave citing the poor order of his family affairs.<sup>33</sup> The tone of the correspondence suggests that Laforey did not want command of *Pallas*. At some point at the beginning of 1771 Captain Laforey was relieved and Captain C. Watson took command of *Pallas*.<sup>34</sup>

*Pallas* remained at anchor at Spithead until May 5<sup>th</sup> when she received orders to sail for the Mediterranean. On May 13, 1771 *Pallas* joined company with frigates HMS *Pearl* (40) and *Minerva* off Porto, Portugal, and together they made for Gibraltar (Map 2). On May 28<sup>th</sup>, *Pallas* sailed into the Mediterranean with *Minerva*. Captain Watson was made commodore of the fleet charged with protecting English trade interests in the Levant and evacuating English subjects

should it become necessary.<sup>35</sup> They arrived in the Gulf of Smyrna on July 7<sup>th</sup>, and remained moored there until the end of November, carrying out general maintenance and showing the British flag. A letter from Captain Watson to the Admiralty dated July 6<sup>th</sup> reports their arrival on station and advises that a plague was at the time ravaging Smyrna.<sup>36</sup> On November 30<sup>th</sup> *Pallas* sailed from Smyrna and returned to the western Mediterranean, patrolling the north coast of Africa and the south coast of Spain, arriving off Europa Point, Spain on February 8, 1772. On February 9<sup>th</sup> she anchored in a squall and was obliged to cut away her bower before entering Gibraltar harbor on the following day.<sup>37</sup>

*Pallas* remained moored in Gibraltar harbor before sailing on April 5<sup>th</sup>. The following day a shock ran through the ship and it was feared that she had hit an uncharted rock but no damage was found. It was later determined to have been an earthquake. On April 12<sup>th</sup> *Pallas* arrived at Lisbon where she remained moored in the Tagus River for several weeks before returning to Gibraltar on May 1<sup>st</sup>. A week later she sailed for the eastern coast of Spain where she patrolled for the next four months, calling periodically at Port Mahon for maintenance and provisions before returning to Gibraltar on September 17<sup>th</sup>. There is a gap in the record of *Pallas* for the period September 18<sup>th</sup> until December 8<sup>th</sup>. From December 9<sup>th</sup> until March 25, 1773, she remained at Gibraltar.<sup>38</sup> On March 26<sup>th</sup>, she sailed with orders to patrol the Atlantic approaches to Gibraltar and then to make her way back to England.

At some time during the following month, it was decided to again place *Pallas* in ordinary. Captain Clements was re-assigned and Captain James Alms took command for the duration of her decommissioning.<sup>39</sup> The crew was paid off and *Pallas* was placed in ordinary in June 1773.

It was only slightly more than a year before the need to protect England's commercial interests abroad compelled *Pallas*' return to service. The frigate was re-commissioned on

October 5<sup>th</sup> 1774 and spent the next five weeks moored in Portsmouth harbor working up, where a new captain, William Cornwallis, took command.<sup>40</sup> It is also worth noting that Gabriel Bray, the new senior Lieutenant, joined *Pallas*' crew at this time. Over the course of the next several voyages, Bray would create a series of amazing and useful watercolors of life aboard *Pallas* (Figs. 35 to 43)

On December 12, 1774 she sailed in company with *Weasel* sloop with orders to patrol down the Atlantic coast of West Africa. Presumably, the British government intended to prevent American colonial smugglers from doing business with, and acquiring arms from, sympathetic European nations through West African trading posts. *Pallas* worked down the coasts of Portugal and Morocco, passing the island of Palma in the Canaries on New Year's Day 1775, and arriving at Santa Cruz Bay in the Canaries on January 6<sup>th</sup> (Map 4). On January 18<sup>th</sup> *Pallas* and *Weasel* sailed south from Tenerife, running down the Senegal Bar. On January 28<sup>th</sup> the two vessels anchored off the Senegal fort and *Pallas* sent 25 half barrels of powder ashore to the fort at the request of the Governor there. (Figs. 35 and 36). The following day *Pallas* and *Weasel* continued south, taking two French prizes before coming to anchor on February 4<sup>th</sup> in the Gambia River off James Island where they delivered 15 half barrels of powder to Fort James. On February 10<sup>th</sup> they ran down the Gambia River and continued south down the West African coast. On February 17<sup>th</sup> they moored in Frenchman's Bay on the Sierra Leone River and on March 2<sup>nd</sup> continued south arriving at the English fort at Whydah on April 3<sup>rd</sup>. There they found numerous ships of all nationalities (map 4).

On April 5, 1775, *Pallas* parted company with *Weasel* and began her first trans-Atlantic crossing and on April 18<sup>th</sup> she passed south of the equator for the first time in her career. She remained in the southern hemisphere for the next two weeks as she sailed west but at no point did she venture more than two degrees south. On May 31<sup>st</sup>, 55 days after sailing from Whydah,

*Pallas* arrived at Barbados and dropped anchor in Carlisle Bay the following day. There are few comments in the logbooks regarding this passage other than the decks were washed regularly with vinegar and the guns were exercised more frequently than usual.<sup>41</sup> However, it is known that the crew was suffering from scurvy upon *Pallas*' arrival in the Caribbean.<sup>42</sup> On June 1, 1775 *Pallas* sailed from Barbados for Port Royal, Jamaica (Map 5). She spent several weeks at Port Royal taking on provisions and undergoing a general overhaul. It was probably there that the crew of *Pallas* learned that war had broken out with the American colonies. On July 13<sup>th</sup> she sailed from Port Royal, patrolled around Jamaica and the Caribbean and then returned to England arriving at Spithead on August 28<sup>th</sup>.

During the next two months, *Pallas* took on provisions, had her rigging overhauled, received a new bowsprit, new gammoning, and new shrouds and spent two and a half weeks in dry dock.<sup>43</sup> On November 16, 1775, she sailed with orders to once again patrol down the Atlantic coast of Africa supporting England's commercial interests and suppressing smuggling and gun-running ventures by the American rebels.<sup>44</sup> *Pallas* called at Madeira and Santa Cruz Bay in the Canary Islands before arriving at Goree on January 8, 1776 (Map 4). The following day she continued south past the mouth of the Gambia River and down the African coast, arriving at Whydah on March 31<sup>st</sup>.

Between January 22<sup>nd</sup> and 30<sup>th</sup>, *Pallas* was in Frenchman's Bay at the mouth of the Sierra Leone River investigating rumors of an American ships hiding up the river. Unable to take *Pallas* into the shallow river, Captain Cornwallis exceeded his authority by acquiring the *St. John* sloop from the local proprietors of the Bence Island plantation. The *St. John* was fitted out and armed with eight guns and small contingent of officers and men were transferred from *Pallas* under the overall command of Lieutenant Alexander Agnew. Cornwallis ordered Agnew to patrol around Cape Coast interdicting American ships attempting to buy arms and

ammunition. Agnew was immediately successful, taking a schooner belonging to South Carolina. Also during this period *Weasel* sloop captured an American brig with the assistance of First Lieutenant Gabriel Bray of *Pallas* who had taken command of a prize ship, presumably the schooner captured by *St. John*. Bray was then ordered to sail the prize to Antigua in the Caribbean.<sup>45</sup>

On May 3, 1776 *Pallas* began her second transatlantic crossing, arriving at Port Royal, Jamaica on June 21<sup>st</sup> without notable incident. She remained moored in Port Royal harbor until July 6<sup>th</sup> when she sailed with the frigate *Maidstone*, and 22 sail of merchant vessels bound north up the American coast but the convoy was forced to return to Port Royal. By July 10<sup>th</sup>, the fleet had grown to include *Pallas*, *Maidstone*, the *West Florida* packet, and 105 merchant vessels. Further delayed by a shortage of water, the convoy did not sail until late September.<sup>46</sup> On October 1<sup>st</sup> *Pallas* liberated the *Anne*, an English vessel bound from Dominica to London that had been taken by an American privateer. On October 3<sup>rd</sup> *Pallas* and *Maidstone* chased off what appeared to be an American privateer and on October 12<sup>th</sup> the convoy entered St. Lawrence harbor, Newfoundland, and came to anchor. On October 29<sup>th</sup> they sailed with a convoy bound for England arriving at Spithead on November 17<sup>th</sup> without any notable incidents being recorded in the logbooks. However, other documents make it clear that the crossing was anything but uneventful. They were plagued by poor weather, hounded by American privateers and Captain Cornwallis complained bitterly of the poor discipline of the convoy. Only 44 of the merchantmen arrived in England in convoy with *Pallas*.<sup>47</sup>

There is a gap in the logbooks from November 17<sup>th</sup> until December 28, 1776 but it is reasonable to assume that *Pallas* remained moored at Spithead for that period. On December 28<sup>th</sup>, *Pallas* was moved into Portsmouth harbor where she remained for a month receiving a refit, general maintenance, and provisioning.<sup>48</sup> At some point during this layover, Captain Cornwallis

was reassigned and Captain Rowland Cotton took command of *Pallas*.<sup>49</sup> On January 24, 1777, *Pallas* was moved back to Spithead where she remained moored through the following month.<sup>50</sup>

March 1<sup>st</sup> *Pallas* sailed with orders to escort a convoy to Tenerife and Grand Canary (Map 4). They arrived at Tenerife on March 20<sup>th</sup> and patrolled the African coast until June 2<sup>nd</sup> when she again headed across the Atlantic arriving at Carlisle Bay, Barbados, without incident on July 26<sup>th</sup>. On November 10<sup>th</sup> *Pallas*, the hired armed ship *Bute* (10), and *Nancy* sloop, with a convoy of 17 merchant vessels, sailed north up the American coast.<sup>51</sup> The following week *Pallas* and *Bute* liberated an unidentified schooner that had been taken by an American privateer.<sup>52</sup> On November 29<sup>th</sup>, *Bute* started taking on water and a carpenter from *Pallas* was sent aboard to assist. By December 3<sup>rd</sup> *Bute* was determined to be beyond saving and was scuttled by her captain. There is no record of the Atlantic crossing but *Pallas* came to anchor at Spithead on January 14, 1778 without apparent incident.<sup>53</sup>

The already overextended resources of the Royal Navy were stretched further when France's signed an alliance with the United States on February 6, 1778. The need to protect England's commercial fleet overseas and now increasingly closer to home placed a much greater burden on the Navy and the frigates in particular.

At some point in early 1778, Captain Rowland Cotton was reassigned and Captain Richard King took command of *Pallas*.<sup>54</sup> From January 17<sup>th</sup> to 29<sup>th</sup> *Pallas* sat in Portsmouth harbor waiting to enter the dry dock; she was moved there on January 30<sup>th</sup> and remained until April 24<sup>th</sup>.<sup>55</sup> Almost three months in dock suggests a major overhaul or refit, but the only notes regarding the work being done simply state that the iron ballast was removed, the holds were cleared and rummaged, and that there was fitting and rigging done. It is almost certain that *Pallas* was coppered during this period in dry dock. *Pallas* left dry dock on April 25<sup>th</sup> but remained in Portsmouth harbor until May 18<sup>th</sup> presumably taking on stores, provisions, guns and

powder. On May 19<sup>th</sup> she was moved to Spithead where she remained at anchor until the 27<sup>th</sup> when she sailed to Torbay. From May 28<sup>th</sup> to June 12<sup>th</sup> *Pallas* rode at the fleet anchorage at Torbay.

At this point there is another gap in the logbook account. There is no suggestion in the logbooks that *Pallas* took part in the Battle of Ushant off the French coast on July 27, 1778. The next place that *Pallas* can be firmly located is arriving at the mouth of St. Lawrence River on August 24, 1778. It is doubtful that *Pallas* again undertook her annual patrol down the Atlantic coast of Africa as these patrols typically took eight months to a year. It is more likely that the frigate was employed escorting troop and supply convoys needed to combat the rebelling colonies in North America. During September and October *Pallas* engaged in several short cruises around Cape Race, Cape Chapeau Rouge, and Newfoundland (Map. 5). At some point in October of 1778, Captain King was reassigned and Captain Thomas Spry took command of *Pallas*.<sup>56</sup> On November 1<sup>st</sup>, *Pallas* sailed from St. John's, Newfoundland, in company with HMS *Invincible* (74) escorting 40 merchant sail to Gibraltar, arriving there on November 29<sup>th</sup> with no notable incident. On December 30<sup>th</sup>, after taking on provisions at Cadiz, she sailed for Spithead arriving on January 25, 1779, where she remained undergoing a refit.<sup>57</sup>

The Royal Navy now faced war on its doorstep and wasted no time responding to the new threat. On May 3<sup>rd</sup> *Pallas* sailed from Spithead to patrol the French coast and the English Channel, in and around 'Gernsey', Gravedela Bay, Concale Bay, and Cawsand Bay. There is some indication that she engaged in some sort of action at Concale Bay but no specific details were found.<sup>58</sup> *Pallas* returned to Spithead on May 22<sup>nd</sup> and remained at anchor there until June 16<sup>th</sup>.

On June 17, 1779, *Pallas* departed Spithead in company with *Cameleon* sloop escorting a convoy of 28 sail bound for Jamaica. They sailed south through the Bay of Biscay and along

the Portuguese coast calling at the island of Madeira on July 3<sup>rd</sup> and continuing on to Port Royal arriving on August 25<sup>th</sup>, arriving too late to participate in the Battle of Grenada on July 6<sup>th</sup>. For the next twenty-one months *Pallas* patrolled the Caribbean around Port Royal interdicting American and French ships in the region (Map 5). During this period, either alone or in company with other Royal Navy warships, *Pallas* was involved in the taking of at least eight prizes, including an American ship.<sup>59</sup> There is no suggestion in the logbooks that *Pallas* participated in the Battle of Martinique on April 17, 1780. It was probably during this extended period in warmer waters that the teredo infestation established itself in *Pallas* hull.

On August 21, 1781 *Pallas* sailed with a fleet including HMS *Ramillies* (90). *Pallas* was apparently detached from the fleet and joined company with HMS *Diamond* (32) on September 15<sup>th</sup>. The two frigates circled south past Puerto Rico and Bonaire before arriving back at Port Royal Jamaica on November 6, 1781. At some point late in 1782 Captain Spry was replaced by Captain John Thomas. It is unclear where and when this occurred, only that it was before the end of 1781.<sup>60</sup> However, orders sent to the captain of *Pallas* by Admiral George Rodney, then in command of the fleet at Port Royal, between March 6<sup>th</sup> and July 8<sup>th</sup> were addressed to Captain John Thomas.

From December 12<sup>th</sup> 1781 to February 28, 1782, *Pallas* patrolled around the Turks and Isabella Point with HMS *Resource* (24) returning to Kingston on March 1<sup>st</sup> and Port Royal on March 6<sup>th</sup>. There is no suggestion in the logbooks that *Pallas* participated in the Battle of St. Kitts on January 25-26, 1782. *Pallas* remained at Port Royal until May 21<sup>st</sup> replacing the main mast and therefore also missed taking part in the Battle of the Saints on April 12, 1782. While in Port Royal Admiral Rodney ordered *Pallas*' boatswain to participate in a survey of the boatswain's stores of HMS *Royal Oak* (74), her gunner to participate in a survey of the powder and gunner's stores of HMS *Fame* (74), and her master to participate in an overall survey of



HMS *Ajax* (74). *Pallas* herself had her fore topsail surveyed. There is also a curious order by Rodney to supplement *Pallas* with a further compliment of surgeons.<sup>61</sup>

From May 22<sup>nd</sup> *Pallas* carried out a short patrol returning Port Royal on June 27<sup>th</sup> where she remained until July 11<sup>th</sup>. While there Captain Thomas received orders from Rodney for *Pallas*' gunner to provide one twelve-pound gun to the gunner of HMS *Barfleur* (98)<sup>62</sup> He was also ordered to discharge 50 able seamen to help man the prizes taken at the Battle of the Saints and to take on board 50 French prisoners-of-war. On July 8<sup>th</sup> or 9<sup>th</sup>, with no reason given, Thomas was replaced as captain of *Pallas* by Captain Christopher Parker. The logbooks make no note of this but on July 8 Rodney's orders to *Pallas*' captain were addressed to Captain Thomas of His Majesty's Ship *Pallas*, on July 9 his orders were addressed to Captain Parker of His Majesty's Ship *Pallas*.<sup>63</sup>

On July 25, 1782 *Pallas* sailed with Admiral Samuel Graves and a large fleet including HMS *Ramillies* (90), HMS *Canada* (74), HMS *Centaur* (74), the French prizes *Ville de Paris* (104), *Le Glorieux* (74), *L'Ardent* (64), *Le Jason* (64), *Le Caton* (64), and a large convoy of merchant vessels bound for England. The French ships had been taken on April 12<sup>th</sup> at the Battle of the Saints off Dominica where Admirals Rodney and Samuel Hood decisively defeated French Admiral De Grasse. En route to England, the convoy encountered severe weather off the American coast (Map 5). On September 8<sup>th</sup>, *Le Caton* developed a serious leak and was ordered to Halifax, Nova Scotia, accompanied by *Pallas*. Ultimately, *Ramillies* and *Centaur* would be lost and several of the French prizes were damaged beyond salvage.<sup>64</sup>

There is a gap in the logbooks from September 1782 to January 1783. However, it is known that once *Pallas* had delivered *Le Caton* safely to Halifax, she immediately returned to sea to round-up and lend assistance to what remained of the scattered convoy. In late September 1782, *Pallas* arrived in England towing the damaged merchantman *Lady Juliana* (Fig. 44).<sup>65</sup>

From October 1782 until January 1783, the whereabouts of *Pallas* are unknown. There is not enough time for her have to once again patrolled down the African coast before crossing the Atlantic. It is more likely that *Pallas* returned directly to North America, perhaps still searching for remnants of the scattered convoy. Whatever the case, *Pallas* ended up in Halifax sometime in January of 1783.<sup>66</sup>

In late January, *Pallas* sailed from Halifax escorting a convoy bound for England. Several leaks became apparent soon after sailing and, to compound the difficulties, *Pallas* became separated from her charges in a storm. By the 5<sup>th</sup> of February, despite non-stop pumping, there was eight feet (2.44 m.) of water in the hold. The guns and most of the stores were thrown overboard and *Pallas* made a desperate run for the Azores (Map 1). On February 10th *Pallas* arrived off the island of Fayal but stormy weather prevented her from anchoring. On February 12th the exhausted officers and crew managed to bring *Pallas* into Calheta harbor on the south shore of the island of São Jorge. Upon examination of the hull it was found that the keel and garboards were so riddled with teredo worm that they were nearly non-existent. The crew unloaded the remaining stores, salvaged what they could and set *Pallas* on fire.<sup>67</sup>

## Notes

<sup>1</sup> Gardiner, *First Frigates*, 22-28.

<sup>2</sup> This was the first HMS *Pallas* commissioned in Royal Navy history.

<sup>3</sup> *Richmond* and *Juno*. *Thames*, *Boston*, *Lark* and *Jason* would follow between 1758 and 1763.

<sup>4</sup> *Southampton*, *Vestal*, *Minerva*, and *Diana*.

<sup>5</sup> *Pallas*, *Venus*, and *Brilliant*.

<sup>6</sup> Gardiner, *First Frigates*, 22-28. Existing British 24-gun –36-gun, 9-pound vessels possessed similar sailing qualities but carried considerably less broadside weight than the new French 36-gun, 12-pound frigates. British 44-gun two-deck heavy cruisers possessed superior firepower to the French design but they were inferior sailors. Also, the low freeboard of the lower deck gunports on the 44-gun heavy cruisers often meant that they could not be opened in heavy seas thereby limiting them to the same broadside as a 20-gun, 9-pound sloop.

<sup>7</sup> For daily activities as recorded in the ship's logbooks, see Appendix C.

<sup>8</sup> TNA: PRO ADM 51/666, Lieutenant's Logbooks from HMS *Pallas*. Unless otherwise noted, following information is extracted from TNA: PRO ADM 51/666 Lieutenant's Logbooks from HMS *Pallas*.

<sup>9</sup> TNA: PRO ADM 1/1606, Admiralty Correspondence.

- <sup>10</sup> TNA: PRO ADM 51/666, Lieutenant's Logbooks from HMS *Pallas*.
- <sup>11</sup> Beatson, *Naval and Military Memoirs*, Vol 2, 263-4, Sainsbury, *Royal Navy Day by Day*, 164, 229, and Clowes, *Royal Navy*, Vol. 3, 193-194. For a detailed description of this action and *Pallas*' role based on Admiral Howe's correspondence with the fleet, see N.A.M. Rodger, *Naval Miscellany*, Vol. 5, 213-43.
- <sup>12</sup> TNA: PRO ADM 51/666, Lieutenant's Logbooks from HMS *Pallas*. The logbook is not specific about what prizes were being paid for.
- <sup>13</sup> Marsh, "Taking of Goree," 121.
- <sup>14</sup> TNA: PRO ADM 51/666, Lieutenant's Logbooks from HMS *Pallas*. Note the longitudes given 39° lat. 6° long. on Nov. 20 and 40° lat. x6° long. on Nov 22 are incorrect coordinates that would place *Pallas* high and dry in Western Spain.
- <sup>15</sup> TNA: PRO ADM 51/666, Lieutenant's Logbooks from HMS *Pallas*. There is no indication regarding the circumstances of this change of command.
- <sup>16</sup> NMM: PJ/JC Vol. 1, National Maritime Museum Warship History Continuation Sheet microfilm.
- <sup>17</sup> TNA: PRO ADM 51/666, Lieutenant's Logbooks from HMS *Pallas*. It is unclear why there is this gap in the activity of *Pallas*.
- <sup>18</sup> Beatson, *Naval and Military Memoirs*, Vol.2, 416.
- <sup>19</sup> Spavens, *Seaman's Narrative*, 48-50.
- <sup>20</sup> TNA: PRO ADM 51/666, Lieutenant's Logbooks from HMS *Pallas*. Beatson, *Naval and Military Memoirs*, Vol 3, 53-5.
- <sup>21</sup> Jenkins, *History of the French Navy*, 129-136
- <sup>22</sup> TNA: PRO ADM 51/666, Lieutenant's Logbooks from HMS *Pallas*.
- <sup>23</sup> TNA: PRO ADM 51/666, Lieutenant's Logbooks from HMS *Pallas* No information is given regarding the ship type but there is little chance that it was a warship but more likely a French privateer or smuggler.
- <sup>24</sup> TNA: PRO ADM 51/666, Lieutenant's Logbooks from HMS *Pallas*.
- <sup>25</sup> Beatson, *Naval and Military Memoirs*, Vol 3, 48,57. Clowes, *Royal Navy*, Vol. 3, 303.
- <sup>26</sup> TNA: PRO ADM 51/666, Lieutenant's Logbooks from HMS *Pallas*.
- <sup>27</sup> TNA: PRO ADM 51/666, Lieutenant's Logbooks from HMS *Pallas*.
- <sup>28</sup> TNA: PRO ADM 51/666, Lieutenant's Logbooks from HMS *Pallas*. This is a clear reference to hull sheathing. However, NMM: PJ/JC Vol.1 National Maritime Museum Warship History Continuation Sheet microfilm, records that *Pallas* was coppered between October 1778 and May 1779.
- <sup>29</sup> Clowes, *Royal Navy*, Vol. 3, 253. At this time the area around Villefranche was independent and not a part of France.
- <sup>30</sup> Beatson, *Naval and Military Memoirs*, Vol 3, 217.
- <sup>31</sup> TNA: PRO ADM 51/666, Lieutenant's Logbooks from HMS *Pallas*. This is the end of the logbooks designated NMM: ADM 51/666.
- <sup>32</sup> TNA: PRO ADM 51/667, Lieutenant's Logbooks from HMS *Pallas*. Unless otherwise noted following information is extracted from TNA: PRO ADM 51/667 Lieutenant's Logbooks from HMS *Pallas*.
- <sup>33</sup> TNA: PRO ADM 1/2053.
- <sup>34</sup> NMM: PJ/JC Vol. 1, National Maritime Museum Warship History Continuation Sheet microfilm.
- <sup>35</sup> TNA: PRO SP 97/58, Admiralty Correspondence.
- <sup>36</sup> TNA: PRO SP 97/58, Admiralty Correspondence.
- <sup>37</sup> TNA: PRO ADM 51/667 Lieutenant's Logbooks from HMS *Pallas* . There is a gap in TNA: PRO ADM 51/667, Lieutenant's Logbooks from HMS *Pallas*, from April 1<sup>st</sup> until December 9<sup>th</sup> that is partially covered in TNA: PRO ADM 51/4283, Lieutenant's Logbooks from HMS *Pallas*.
- <sup>38</sup> TNA: PRO ADM 51/667, Lieutenant's Logbooks from HMS *Pallas*. The record recommences after gap filled by TNA: PRO ADM 51/4283, Lieutenant's Logbooks from HMS *Pallas*.
- <sup>39</sup> NMM: PJ/JC Vol. 1, National Maritime Museum Warship History Continuation Sheet microfilm.
- <sup>40</sup> NMM: PJ/JC Vol. 1, National Maritime Museum Warship History Continuation Sheet microfilm.
- <sup>41</sup> TNA: PRO ADM 51/667, Lieutenant's Logbooks from HMS *Pallas*.
- <sup>42</sup> Clark (ed.), *Naval Documents*, Vol. 3, 906.
- <sup>43</sup> TNA: PRO ADM 51/667, Lieutenant's Logbooks from HMS *Pallas*. No specifics are given regarding the nature of the repair undertaken while in dry dock.

- <sup>44</sup> Clark (ed.), *Naval Documents*, Vol. 3, 363-6.
- <sup>45</sup> Clark (ed.), *Naval Documents*, Vol. 3, 540, 544, Vol. 6, 76, Vol. 8, 598 and TNA: PRO ADM 1/1611, Admiralty Correspondence.
- <sup>46</sup> Clark (ed.), *Naval Documents*, Vol. 6, 867.
- <sup>47</sup> Clark (ed.), *Naval Documents*, Vol. 7, 734, 736, 750-1, 756, 761.
- <sup>48</sup> TNA: PRO ADM 51/667, Lieutenant's Logbooks from HMS *Pallas*.
- <sup>49</sup> PJ/JC Vol. 1, NMM Warship History Continuation Sheet microfilm.
- <sup>50</sup> TNA: PRO ADM 51/667, Lieutenant's Logbooks from HMS *Pallas*.
- <sup>51</sup> TNA: PRO ADM 51/667, Lieutenant's Logbooks from HMS *Pallas*.
- <sup>52</sup> Clark (ed.), *Naval Documents*, Vol. 10, 535.
- <sup>53</sup> TNA: PRO ADM 51/667, Lieutenant's Logbooks from HMS *Pallas*. This is where the logbook TNA: PRO ADM 51/667 ends.
- <sup>54</sup> NMM: PJ/JC Vol. 1, National Maritime Museum Warship History Continuation Sheet microfilm.
- <sup>55</sup> NMM: PJ/JC Vol. 1, National Maritime Museum Warship History Continuation Sheet microfilm. *Pallas* was coppered between October 1778 and May 1779. However January to April 1778 is the only period noted in the logbooks that she was brought into dry dock. TNA: PRO ADM 51/668, Lieutenant's Logbooks from HMS *Pallas*. It is reasonable to assume that the new logbook coincides with the change of command. Captain King does not offer much in the way of useful remarks to the lieutenant's logbook. Unless otherwise noted following information is extracted from TNA: PRO ADM 51/668 Lieutenant's Logbooks from HMS *Pallas*.
- <sup>56</sup> NMM: PJ/JC Vol. 1, National Maritime Museum Warship History Continuation Sheet microfilm.
- <sup>57</sup> TNA: PRO ADM 51/668, Lieutenant's Logbooks from HMS *Pallas*. NMM: PJ/JC Vol. 1, National Maritime Museum Warship History Continuation Sheet microfilm. It is possible that *Pallas* was coppered during this overhaul but there is no suggestion that she was brought into dry dock.
- <sup>58</sup> NMM: PJ/JC Vol. 1, National Maritime Museum Warship History Continuation Sheet microfilm. I have found references to an action at Concale around this date but so far this is the only reference that I have found suggesting *Pallas*' involvement.
- <sup>59</sup> TNA: PRO ADM 51/668, Lieutenant's Logbooks from HMS *Pallas*. It is reasonable to assume that the word ship here refers to the rig type, i.e. a full-rigged, three mast ship No name is given.
- <sup>60</sup> NMM: PJ/JC Vol. 1, National Maritime Museum Warship History Continuation Sheet microfilm. Neither the logbooks nor the National Maritime Museum Warship Continuation Sheet for *Pallas* make any note of a new captain being assigned during this period. However The Continuation sheet does show Captain Spry leaving *Pallas* before the end of 1781.
- <sup>61</sup> Rodney, *Letter-Books and Order-Book*, 683, 692, 695, 711, 745.
- <sup>62</sup> *Ibid.*, 811.
- <sup>63</sup> *Ibid.*, 816-17, 25.
- <sup>64</sup> Breen, "Foundering of the HMS *Ramilles*," 190 and Rodney, *Letter-Books and Order-Book*, 834, 840.
- <sup>65</sup> Rodger, *Command of the Ocean*, 510 Plate 22b.
- <sup>66</sup> TNA: PRO ADM 51/668, Lieutenant's Logbooks from HMS *Pallas*.
- <sup>67</sup> TNA: PRO ADM 1/5322, Capt Parker's report to the Admiralty informing of the loss of *Pallas*.

CHAPTER VII  
ARCHAEOLOGY OF *PALLAS* SITE

The remains of *Pallas* lay in three meters of water within Calheta harbor, forgotten but not officially lost. The site, south and west of the existing harbor, is little affected by modern commercial boat traffic and has, for the most part, been sheltered from the worst of Atlantic storms. Because Royal Navy records confirmed that the crew made an effort to remove what remained of the valuable fixtures before destroying her, no subsequent effort was made to salvage the remains of *Pallas*.<sup>1</sup> There is little evidence of previous disturbance or removal of material culture, but a certain amount of salvage by local residents probably took place after 1783, and scuba divers may have collected souvenirs in recent decades.

The first officially-sanctioned investigation of the site took place in the summer of 1998 as part of a general shipwreck survey of the Azores sponsored by the Institute of Nautical Archaeology (INA), the Azorean Government's Direcção Regional da Cultura (DRC) and the Centro Nacional de Arqueologia Náutica e Subaquática (CNANS) in Lisbon. The Azorean government was planning improvements of Calheta harbor and had contracted for a formal archaeological survey of the harbor to be carried out by the DRC and INA.

The primary investigators, Catarina Garcia, Paulo Monteiro and Kevin Crisman carried out a cursory survey, photographing the site, drawing and mapping visible debris (Fig. 44), and collecting samples. Visible remains at the site include two iron cannon (Figs. 44, 45 and 46), one row of rectangular iron ingots, and a single massive concretion of iron ballast and shot protruding above the sand and cobble bottom (Figs. 44 and 45).

A subsequent more thorough investigation carried out by Garcia and Monteiro involved digging several test trenches that exposed a variety of copper nails, tacks, and possible wedge

from a forelock bolt (Fig. 48), fragments of copper sheathing (Fig. 49), lead sounding weights (Figs. 50 and 51), an assortment of lead and iron shot (Fig. 52 and 53), four types of pottery fragments (Fig. 54), and a variety of copper coins (Fig. 55).<sup>2</sup>

*Pallas*' logbooks for her last few months of service have unfortunately gone missing. However, Royal Navy records provide a clear account of the final voyage of *Pallas* including her destruction in Calheta harbor.<sup>3</sup> This is further corroborated by the Navy records progress sheets. Furthermore, Azorean historical accounts record that the local populace objected to having *Pallas* burn in close proximity to their town.<sup>4</sup>

There is little doubt that the 6-pound guns found at the site are from *Pallas*. They have the unmistakable appearance of British-manufactured guns from the mid-18<sup>th</sup> century and are in fact examples of the 6-pound 'shorts,' designed specifically for Royal Navy frigates, and introduced in August 1757.<sup>5</sup> The copper sheathing and iron ballast ingots can also be considered diagnostic and strongly suggest the remains of an 18<sup>th</sup>-century Royal Navy warship. The iron shot are also convincing evidence of the presence of a warship.<sup>6</sup> Measuring about 4 cm. in diameter, they could be grape shot but are more likely shot for the ½-pound swivel guns mounted along the rails of 18<sup>th</sup>-century English frigates. Unfortunately copper nails, spikes, and drift pins were common throughout most 18<sup>th</sup>-century shipbuilding traditions and therefore these finds cannot be considered diagnostic artifacts on their own. Nevertheless, it is possible that future comparative analysis may establish some or all as the unique product of the 18<sup>th</sup>-century Royal Navy. It is equally likely that analysis of the pottery fragments and coins will confirm a date consistent with the destruction of *Pallas*. However, they do not, by themselves, provide any conclusive data and could easily be coincidental intrusions. The same is true for the lead musket balls. Standing alone they cannot be considered diagnostic. Almost all maritime vessels carried (and still carry) some small arms. However, taken in context with the other artifacts found at the

site, they do reinforce the identification of the wreck. Given this collective body of evidence, both archaeological and historical, there is little doubt that the site has been properly identified as that of the frigate HMS *Pallas* of 1757 -1783.

It is possible that more remains to be discovered. However, given the hard, compacted nature of the bottom it is unlikely. As already stated, the two guns were probably the only two remaining aboard *Pallas* upon her arrival at São Jorge. A cursory investigation of the site yielded sufficient data to conclusively identify the site and yielded both quantity and variety of artifacts scattered around the site but failed to locate any structural remains of *Pallas*' hull. While it is possible that the large concretion of iron ballast and shot may conceal some surviving portions of the wooden hull, the archaeological significance of any concealed remains is questionable. While the *Pallas* site is worthy of further investigation, it does not represent a period or shipbuilding tradition previously unrecorded. The knowledge gained could be considerable but costly, and would more likely serve to fill in small details currently missing from the historical record. The expense and feasibility of lifting, dismantling, or otherwise circumventing the large concretion weigh heavily against the potentially meager returns of future excavation. However, further thorough and systematic survey of the site may prove otherwise.

### Notes

<sup>1</sup> TNA: PRO ADM 1/5322, Courts Martial account accounts and Captain Parker's letter to the Admiralty reporting the lost of *Pallas*.

<sup>2</sup> Garcia and Monteiro, *Intervenção Arquelógica Subaquática*, 14-22.

<sup>3</sup> NMM: PJ/JC Vol. 1, Warship History Continuation Sheet microfilm, TNA: PRO ADM 1/5322, Courts Martial account accounts and Captain Parker's letter to the Admiralty reporting the lost of *Pallas*, and TNA: PRO ADM 2/1116, Orders from the Admiralty to Captain Jonathan Faulknor HMS *Princess Royal*, to convene Captain Parker's courts martial.

<sup>4</sup> Crisman, "Looking for Ships," 7.

<sup>5</sup> Caruana, *History of British Sea Ordnance*, Vol. 2, 152, Gardiner, *First Frigates*, 81, and Lavery, *Construction and Fitting*, 101.

<sup>6</sup> Knight, "Copper Sheathing," 299-309, Steffy, 1981, 131, and Lavery, *Construction and Fitting*, 62-3.

## CHAPTER VIII

## CONCLUSIONS

A carefully researched graphic reconstruction of the hull and fittings of HMS *Pallas* has been produced using the surviving Admiralty drafts for *Pallas* as a starting point and refining them with the 1745 Establishment lists, extant contemporary literary sources, period models and artwork, and, where required, modern literary sources. The most significant deficiency would be the absence of exact information regarding the size and types of fasteners used. Nevertheless, data regarding most of the large, and most important, fastenings were established or can be reasonably deduced. Unfortunately, yard records were not readily accessible during this study. It is highly probable that records from Deptford, or even other yards, would contribute significantly to the reconstruction.

While it was possible to recreate a reasonably accurate representation of the spar plan and rigging plan for *Pallas*, a considerable amount of detail is still lacking. Some of this deficiency may be addressed by further examination of contemporary representations. However, an exact reproduction of the rigging of a specific vessel is a virtual impossibility. Captains frequently altered the rigs of their ships, sometimes on a daily basis, to suit their individual preference and sailing styles. They were often unable to exactly reproduce lost or damaged rigging elements due to shortages of materials, and were compelled to resort to altering their ship's rig to make do with what they had. The most that can be hoped for is to recreate, as accurately as possible, the vessel's ideal rigging plan based on Royal Navy standards and accepted practices of the period.

Examination of life aboard a Royal Navy warship gives personality to the ship and, taken in the intimate context of a specific ship, confers a more dynamic feel for the day-to-day



existence of the 18<sup>th</sup>-century Royal Navy sailor. While the service history provided by the logbooks is often sterile and repetitive, it does offer occasional glimpses of historical events from a unique perspective, and further contributes to the personality of the ship. Finally, Gabriel Bray's watercolors provide a powerful visual catalyst, transporting the viewer directly to the decks of *Pallas*.

Most Royal Navy historians consider the *Pallas* class a failure.<sup>1</sup> This is not based on any deficiency in capability or performance; rather it is an issue of economy and Navy Board conservatism of the time. The *Pallas* class frigates successfully fulfilled the requirements set out for their development. They were fast, seaworthy and maneuverable. They were able to remain at sea and operate independently for long periods, and their durability was especially apparent in their longevity.<sup>2</sup> They were capable of projecting strategic influence on a global scale, policing Britain's widespread colonial possessions and suppressing piracy. At war they proved highly successful as commerce raiders and equally successful at protecting British maritime commerce from enemy commerce raiders and privateers. They proved effective at blockading smaller enemy ports to stop important war material from reaching Britain's enemies. They efficiently gathered valuable intelligence often enabling timely deployment of the battle fleet or other resources.

Along with the contemporary 32's, they served as the prototype for all subsequent Royal Navy frigates. Furthermore, there is credible evidence that early frigates of the Continental Navy were influenced by the *Pallas* design.<sup>3</sup> They served as platforms on which numerous improvements were tested and eventually accepted for general use within the Royal Navy. During the course of her career, *Pallas* was retrofitted with copper sheathing, a mizzen driver boom, and additional ventilation scuttles.<sup>4</sup>

In some ways, the 36's were unnecessarily overbuilt. They possessed no significant advantage over the 32-gun *Southampton*-class, *Richmond*-class and *Niger*-class frigates—the four additional 6-pound guns carried by the 36's made no significant contribution to broadside firepower and served only to make the ship unnecessarily larger and increase topside weight. The *Southamptons*, *Richmonds* and *Nigers* were only marginally smaller but were significantly lighter (670 rather than 720 tons), required less wood to construct and were, at least theoretically, better sailors. Royal Navy performance evaluations state that the *Pallas* class frigates were faster than their 32-gun counterparts, otherwise they were comparable to the *Southamptons*, not outstandingly weatherly, but very maneuverable.<sup>5</sup> The logbooks of eleven different captains, over the course of *Pallas*' 25-year history, record no negative comment regarding her sailing quality, performance, or capacity.

Ultimately the conservative minded and cost-conscious Navy Board found its 32-gun frigates to be a more cost effective solution. They served the same purpose as the 36's and were cheaper to produce and maintain. It was not until the introduction of the carronade to the Royal Navy's arsenal towards the end of the century that 36-gun frigates were reintroduced.

### Notes

<sup>1</sup> Gardiner, "First English Frigates," 168.

<sup>2</sup> Gardiner, *First Frigates*, 28 *Brilliant* was sold in 1776 after 19 years of service, *Pallas* was beached as unseviceable in 1783 after 25 years of service and *Venus* was sold in 1828 after an incredible 72 years of service.

<sup>3</sup> Clark (ed.), *Naval Documents*, Vol. 3, 1115, Vol. 4, 12 and Fowler, *Rebels Under Sail*, 220-1, 231. The correspondence between Josiah Bartlett of The Marine Committee and shipbuilder John Langdon (February 3<sup>rd</sup> and 19<sup>th</sup>, 1776) strongly suggest that the 32-gun *Raleigh* was at the very least loosely based on the drafts of *Pallas*.

<sup>4</sup> TNA: PRO ADM 51/666, Gardiner, *First Frigates*, 77 and NMM: PJ/JC Vol. 1, National Maritime Museum Warship History Continuation Sheet microfilm.

<sup>5</sup> Gardiner, *First Frigates*, 98.

## REFERENCES

Primary Sources

Anonymous. *The Shipbuilder's Repository* (1788; reprint, Rotherfield: Jean Boudriot, 1992).

Anonymous. *Observations and Instructions for the use of the commissioned, the junior and other officers of the Royal Navy.... With an Appendix; being a complete set of forms for watch, station and quarter bills for ships of war. By a Captain of the Royal Navy* (London: P. Steele, 1804).

Beatson, Robert. *Naval and Military Memoirs of Great Britain from the Year 1727, to the Present Time* (London: printed for J. Strachan and P. Hill, Edinburgh, 1790).

Blanckley, Thomas Riley. *A Naval Expositor: shewing and explaining the words and terms of art belonging to the parts, qualities and proportions of building, rigging, furnishing, & fitting a ship for sea:...* (London: printed by E. Owen in Warwick Lane, and engraved by Paul Fourdrinier at Charing Cross, 1750).

Burney, William. *A New Universal Dictionary of the Marine* (London: T. Cadell & W. Davies, 1815).

Clark, William B. (ed.). *Naval Documents of the American Revolution* (Washington: Naval Historical Center, Department of the Navy, 1964).

Diderot, Denis, 1713-1784. *Diderot Encyclopedia: The Complete Illustrations* (New York: Abrams, 1978).

Falconer, William, *Universal Dictionary of the Marine* (London: printed for T. Cadell, 1771).

Fincham, John. *An Outline of Ship Building* (London: Whittaker, 1852).

Hutchinson, William. *A Treatise on Naval Architecture* (1794; reprint, Greenwich, U.K.: Conway Maritime Press, 1970).

“J.L.” *The Sea-Man's Vade Mecum: Containing the most Necessary Things for qualifying Seamen of all Ranks, viz* (London: printed and sold by James Woodward, 1707).

Lever, Darcy. *The Young Sea Officer's Sheet Anchor: A Key to Leading, Rigging and Practical Seamanship*. (1808; reprint, Ottawa: Algrove Publishing Limited, Classic Reprint Series, 3rd ed., 2000).

Lind, James. *A Treatise of the Scurvy in Three Parts. Containing an inquiry into the Nature, Causes and Cure of that Disease...* (London: A. Millar, 1753).

Montaine, William. *The Seaman's Vade-Mecum and Defensive War by Sea* (London: W. and J. Mount & T. and T. Page, 1761).

- Muller, John. *A Treatise of Artillery* (London: printed for John Millan, 1780).
- Murray, Mungo. *A Treatise on ship-building and navigation*. (London: printed by D. Henry and R. Cave. for the author, 1754).
- National Maritime Museum [hereafter NMM]: PJ/JC Vol.1, Warship History Continuation Sheet microfilm, National Maritime Museum Library, Greenwich.
- NMM: ADM 170/429, Royal Navy 1719 Establishment Lists.
- NMM: ADM 170/430, Royal Navy 1719 Establishment Lists.
- NMM: ADM 2042, Admiralty drafts of lines for HMS *Brilliant*, Thomas Slade, 1757.
- NMM: ADM 2194, ADM 2196, ADM 2198, ADM 2199, and ADM 2200, Admiralty drafts for construction of HMS *Pallas*, Thomas Slade, 1757.
- Ollivier, Blaise. *18th Century Shipbuilding: Remarks on the Navies of the English & the Dutch from Observations made at their Dockyards in 1737*. (Translated and edited by David H. Roberts), (1737; reprint, Rotherfield, East Sussex, U.K.: Jean Boudriot Publications, 1992).
- Perrin, W. G. (ed.), *Boeteler's Dialogues* (1685; reprinted as Naval Records Society Vol. LXV, 1929).
- Quarm, R. "An Album of Drawings by Gabriel Bray RN, HMS *Pallas*, 1774–75," *The Mariner's Mirror*, 81:1 (1995): 32-44.
- Rodney, George Brydges, *Letter-Books and Order-Book of George, Lord Rodney, Admiral of the White Squadron, 1780-1782...* (New York: printed for the Naval Records Society by the New York Historical Society, 1932).
- Royal Navy. *The Royal Navy Articles of War–1757* [www.hmsrichmond.org/rnarticles.htm](http://www.hmsrichmond.org/rnarticles.htm)
- Spavens, W. *Memoirs of a Seafaring Life: The Narrative of William Spavens*. ed. N.A.M. Rodger, (1796, reprinted, London: The Bath Press for the Folio Society, 2000).
- Steel, David. *Steel's Elements of Mastmaking, Sailmaking and Rigging*. (1794; reprint. New York: E.W. Sweetman, 1982).
- Steel, David Sr. and/or Jr. *The Shipwright's Vade-Mecum: A Clear and Familiar Introduction to the Principles and Practice of Ship-Building...* (1805; reprint, London: J.W. Norie and Company, 1822).
- Sutherland, W. *The Ship-Builders Assistant* (1711; reprint, Rotherfield, U.K.: Jean Boudriot Publications, 1989).

The National Archive: Public Record Office [hereafter TNA: PRO] ADM 1/1606, Admiralty Correspondence.

TNA: PRO ADM 1/1611, Admiralty Correspondence.

TNA: PRO ADM 1/2053, Admiralty Correspondence.

TNA: PRO ADM 1/5322, Court's Martial of Captain Christopher Parker.

TNA: PRO ADM 2/1116, Orders from the Admiralty to Capt. Jonathan Faulknor HMS *Princess Royal*, to convene Capt. Parker's courts martial.

TNA: PRO ADM 51/666, Lieutenant's logbooks from HMS *Pallas*. (Jan. 1758 – Jan. 1764).

TNA: PRO ADM 51/667, Lieutenant's logbooks from HMS *Pallas*. (Oct. 1770 – Jan. 1778).

TNA: PRO ADM 51/668, Lieutenant's logbooks from HMS *Pallas*. (Feb. 1778 – July 1782).

TNA: PRO ADM 51/4283, Lieutenant's logbooks from HMS *Pallas*. (Apr. 1772 – Dec. 1772 and Nov. – Dec. 1776)

TNA: PRO SP 97/58, Admiralty Correspondence.

### Secondary Sources

Albions, R.G. *The Timber Problems of the Royal Navy: 1652-1862* (Cambridge, MA: Harvard University Press, 1926).

Anderson, Fred. *Crucible of War: The Seven Years' War and the Fate of Empire in British North America, 1754-1766* (New York: Vintage Books Division of Random House, Inc., 2001).

Anderson, R. C. "The Ancestry of the Eighteenth-Century Frigate," *The Mariner's Mirror* 27:2 (1941): 158.

Barker, D. "The Naval Uniform Dress of 1748," *The Mariner's Mirror* 65:3 (1979): 243-53.

Baugh, D.A. (ed.). *Naval Administration 1715-1750* (Printed for the Navy Records Society. London: Spottiswoode Ballantyne Press, 1977).

Biddlecomb, George. *The Art of Rigging: Containing an Explanation of Terms and Phrases.... Mineola* (New York: Dover Publications, Inc., 1990).

Blake, N. and R. Lawrence. *The Illustrated Companion to Nelson's Navy* (London: Chatham Books, 2000).

- Blomfield, Sir R. Massie. "Hammocks and Their Accessories," *The Mariner's Mirror* 1:5 (1911): 144-47.
- . "The Internal Economy of Men-of-War: Gun-room, Ward-room, Bread-room, and Galley," *The Mariner's Mirror* 1:6 (1911): 161-64.
- Boudriot, Jean. *The History of the French Frigate 1650–1850* (Rotherfield, East Sussex: 1993).
- Breen, K. "The Foundering of the HMS *Ramillies*," *The Mariner's Mirror* 56:2 (1970): 187-97.
- Brooking, Charles. *Charles Brooking, 1723-1759 and the 18<sup>th</sup>-Century British Marine Painters*. (Wappinger's Falls, NY: Antigue Collector's Club, 2000).
- Caruana, Adrian. *The History of English Sea Ordnance, 1523-1875*, (2 Volumes) (Rotherfield, England: Jean Boudriot, 1994).
- Clowes, W.L. *The Royal Navy: A History from the Earliest Times to 1900*, Volume 3, (London: Chatham Publishing, 1996).
- Crisman, K. "Looking for Ships: The 1998 Central Azores Shipwreck Survey," *INA Quarterly*, 26:1 (1999): 3-9.
- Dodds, James and James Moore. *Building the Wooden Fighting Ship* (London: Chatham Publishing, 1984).
- Fordyce, Alexander D. *Outline of Naval Routine* (London: Smith, Elder & Co., 1937).
- Fowler, William M., Jr. *Rebels Under Sail: The American Navy during the Revolution* (New York: Charles Scribner's Sons, 1976).
- Garcia, C. and P. Monteiro. *Intervenção Arquelógica Subaquática: HMS Pallas* (Unpublished survey report to various Portuguese government agencies on file at the Centro Nacional de Arquelógica Náutica e Subaquática (CNANS) Lisbon: 2000).
- Gardiner, Robert. (ed.). *Navies and the American Revolution 1775–1783* (Annapolis, MD: Naval Institute Press, 1996).
- . *The Line of Battle: The Sailing Warship 1650–1840* (London: Conway Maritime Press, 1992).
- Gardiner, Robert. *The First Frigates: Nine-Pounder and Twelve-Pounder Frigates, 1748–1815* (London: Conway Maritime Press, 1992).
- . "The Frigate Designs of 1755-57," *The Mariner's Mirror*, 63:1 (1977): 51-70.
- . "The First English Frigates," *The Mariner's Mirror*, 61:2 (1975): 163-172.

- Goodwin, Peter. *The Construction and Fitting of the English Man of War 1650–1850* (Annapolis: Naval Institute Press, 1987).
- Harland, John. *Seamanship in the Age of Sail* (Annapolis: Naval Institute Press, 1984).
- Henderson, James. *The Frigates: An Account of the Lesser Warships of the Wars from 1793-1815* (New York: Dodd, Mead, 1971).
- Hertzog, Keith P. “Naval Operations in West Africa and the Disruption of the Slave Trade during the American Revolution,” *The American Neptune*, 55:1 (1995): 42-48.
- Howard, F. *Sailing Ships of War, 1400-1860* (New York: Mayflower Books, 1979).
- Howarth, D. *Sovereign of the Seas: The Story of British Sea Power* (London: Quartet Books, 1974).
- Ireland, B. *Naval Warfare in the Age of Sail: War at Sea 1756-1815* (New York: W.W. Norton & Company, 2000).
- Jenkins, E.H. *A History of the French Navy, from its Beginnings to the Present Day* (London: MacDonald and Jane’s, 1973).
- Jones A. G. E. “Sir Thomas Slade, 1703/4 - 1771,” *The Mariner’s Mirror*, 63:3 (1977): 224-226.
- King, P. “Iron Ballast for the Georgian Navy and its Producers,” *The Mariner’s Mirror*, 81:1 (1995): 15-20.
- Knight, R. “The Introduction of Copper Sheathing into the Royal Navy, 1779-1786,” *The Mariner’s Mirror*, 59.3 (1973): 299-309.
- Lavery, Brian. *The Arming and Fitting of English Ships of War 1600–1815* (London: Conway Maritime Press of Chrysalis Books Ltd., 1987).
- . *The Ship of the Line Volume II: Design, construction and fittings* (London: Conway Maritime Press, 1984).
- . *The Ship of the Line Volume I: The development of the battlefleet 1650–1850* (London: Conway Maritime Press, 1983).
- . “The Rebuilding of British Warships, 1690-1740,” *The Mariner’s Mirror*, 66:1 (1980): 113-27.
- Lavery, Brian, (ed.). *Shipboard Life and Organization, 1731-1815* (London: Ashgate, 1998).
- Lees, James. *The Mastng and Rigging of English Ships of War 1625–1860* (Annapolis: Naval Institute Press, 1979).
- Low, Charles Rathbone. *Famous Frigate Actions* (London: Conway Maritime Press, 1970).

- Lyon, David. *The Sailing Navy List: All the Ships of the Royal Navy—Built, Purchased and Captured 1688–1860* (London: Conway Maritime Press, 1993).
- Mahan, Alfred Thayer. *Mahan on Naval Warfare*. Selections from the Writings of Rear Admiral Alfred T. Mahan, ed. Allan Westcott (1941; reprint, Don Mills, Canada: General Publishing Company, Ltd., 1999).
- . *The Influence of Sea Power Upon History 1660–1783* (New York: Dover Publications, Inc., 1987).
- Manwaring, G. E. *A Bibliography of British Naval History* (London: Conway Maritime Press, 1970).
- . “The First Naval Uniform for Officers: The Story of the Blue and White Costume of 1748,” *The Mariner’s Mirror*, 51:3 (1965): 105-14.
- Marcus, G.J. *Heart of Oak: A Survey of British Sea Power in the Georgian era* (London: Oxford University Press, 1975).
- . *Quiberon Bay: The Campaign in Home Waters, 1759* (London: Hollis & Carter, 1960).
- Marquardt, Karl Heinz. *Eighteenth-century Rigs & Rigging* (London: Conway Maritime Press of Chrysalis Books Ltd., 1986).
- Marsh, A.F. “The Taking of Goree,” *The Mariner’s Mirror*, 51:2 (1965): 117-130.
- Marston, Daniel. *The Seven Years’ War* (Oxford: Osprey Publishing, 2001).
- Masefield, J. *Sea Life in Nelson’s Time* (1905; reprint, London: Conway Maritime Press, 1971).
- May, W.E. *The Boats of Men-of-War* (Annapolis: Naval Institute Press, 1999).
- . “The *Minerva* in the Mediterranean,” *The Mariner’s Mirror*, 52:2 (1966): 181-91.
- Mckay, J. and Ron Coleman. *The 24-gun Frigate Pandora, 1779* (London: Conway Maritime Press, 1992).
- Mckee, A. “The Influence of British Naval Strategy on Ship Design: 400–1850,” in *A History of Seafaring, based on Underwater Archaeology*. George Bass (ed.) (London: Thames and Hudson, 1972).
- Miller, Nathan. *Sea of Glory: A Naval History of the American Revolution* (Charleston, SC: The Nautical & Aviation Publishing Company of America, 1974).
- Morris, R. *The Royal Dockyards During the Revolutionary and Napoleonic Wars* (Leicester, U.K.: Leicester University Press, 1983).



- Oertling, T. *Ships' Bilge Pumps: A History of Their Development, 1500-1900* (College Station: Texas A&M University Press, 1996).
- . "The Chain Pump: an 18<sup>th</sup> Century Example," *International Journal of Nautical Archaeology*, 2:2 (1982): 113-124.
- Price, Anthony. *The Eyes of the Fleet: A Popular History of Frigates and Frigate Captains,...* (New York: W. W. Norton, 1996).
- Robinson, C.N. "British Seamen's Dress," *The Mariner's Mirror*, 2:11 (1912) 325-27.
- Rodger, N.A.M. *The Command of the Ocean: A Naval History of Britain, 1649-1815* (New York: W.W. Norton & Company, 2005).
- . *The Wooden World: An Anatomy of the Georgian Navy* (New York: W.W. Norton & Company, Inc., 1996).
- . *The Admiralty* (Lavenham, U.K.: Lavenham Press Limited, 1979).
- Rodger, N.A.M. (ed.). *Memoirs of a Seafaring Life. The Narrative of William Spavens Pensioner on the Naval Chest at Chatham* (1796; reprint, London: The Bath Press, 2000).
- . *Naval Miscellany*. Volume 5, (London: printed for the Navy Records Society, 1984).
- Royal Navy. BR 2193 (extract from). "The Development of Preventative Medicine in the Royal Navy," *Handbook for Royal Navy Medical Officers*. Articles 0101-0107,
- Sainsbury, Captain A.B. *The Royal Navy Day by Day* (Shepperton, Surrey, U.K.: Ian Allen Publishing. 1992).
- Scammell, G.V. "The Sinews of War: Manning and Provisioning English Fighting Ships c.1550-1650," *The Mariner's Mirror* 73:4 (1987) 351-67.
- Simmons, J.J. *Those Vulgar Tubes: External Sanitary Accommodations Aboard European Ships of the Fifteenth Through Seventeenth Centuries* (College Station: Texas A&M University Press, 1991).
- Steffy, J. Richard, *Wooden Shipbuilding and the Interpretation of Shipwrecks* (College Station: Texas A&M University Press, 1994).
- Steffy, J. Richard, Richard W. Swete, Samuel Margolin, Christopher F. Amer, Michela M. Perreault, Dana M. Lange, Denise Lakey, James A. Duff, Gianmarco Brenni, Thomas J. Oertling & William L. Huber. "The Charon Report." In *Underwater Archaeology: The Challenge before Us*, edited by Gordon P. Watts, Jr. San Marino, CA: Fathom Eight Publications, (1981).

- Stevens, J. R. *An Account of the Construction and Embellishment of Old Time Ships* (Toronto: unpublished, printed for the author, 1949).
- Syrett, David. *The Royal Navy in European Waters during the American Revolutionary War* (Columbia: University of South Carolina Press, 1998).
- . *The Royal Navy in American Waters 1775–1783* (Aldershot: Scholar Press, 1989).
- Syrett, David and R. L. DiNardo (eds.). *The Commissioned Sea Officers of the Royal Navy, 1660-1815* (Aldershot: Scholar Press for the Naval Records Society, 1994).
- Tunstall, Brian. *Naval Warfare in the Age of Sail: The Evolution of Fighting Tactics, 1650-1815* (Edison, NJ: Wellfleet Press, 1990).
- Warner, O. *Fighting Sail: Three Hundred Years of Warfare at Sea* (Bungay, Suffolk, U.K.: The Chaucer Press, 1979).
- Wheeler, James s. *The Making of a World Power: War and the Military Revolution in Seventeenth-Century England* (Stroud, U.K.: Sutton Publishing, 1999).
- White, David. *The Frigate Diana* (Annapolis, MD: Naval Institute Press, 1987).

## APPENDIX A

## FIGURES



Fig. 1. Frigate believed to be *Pallas*. Painted by Charles Brooking, 1759. From Brooking, 8



Fig. 2. Frigate entering Portsmouth. Painted by Thomas Mitchell, 1780. From Brooking, 100

36-Gun Royal Navy Frigate  
HMS PALLAS  
1757

Ship Lines

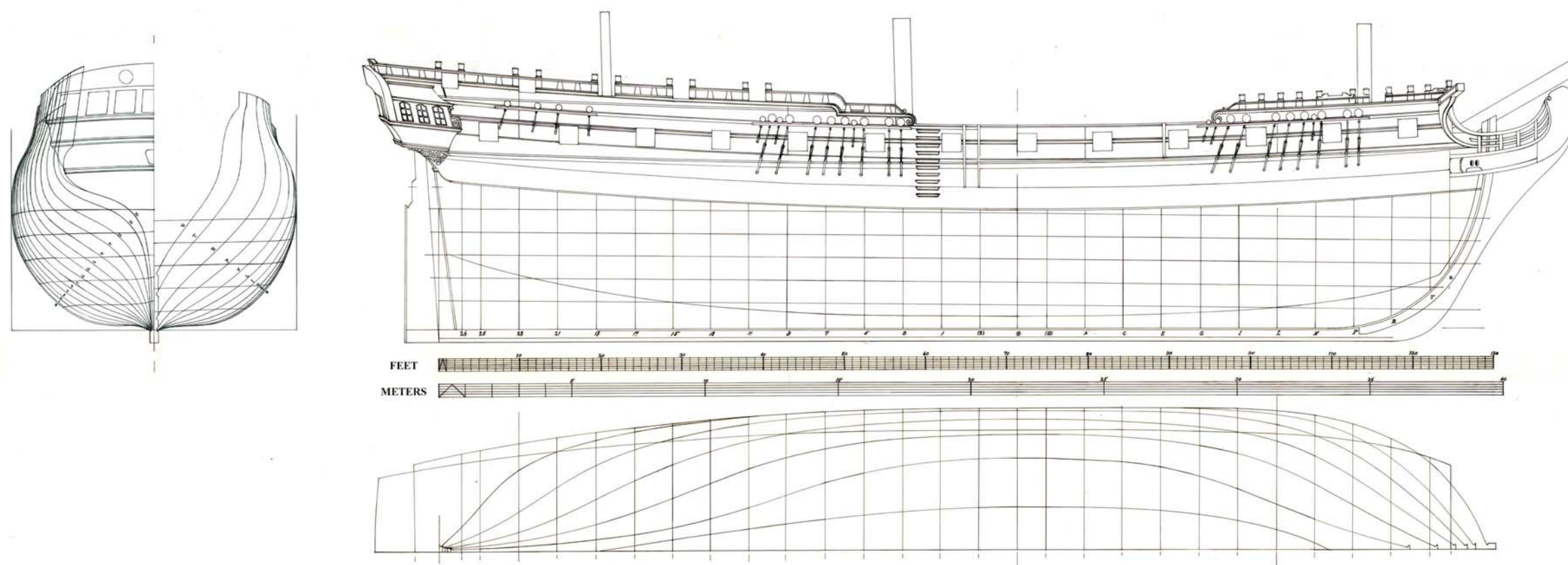

Fig. 3. Ship's lines for frigate HMS *Pallas*. Based on NMM: ADM 2042 - Admiralty drawings for *Pallas*' sister ship HMS *Brilliant*

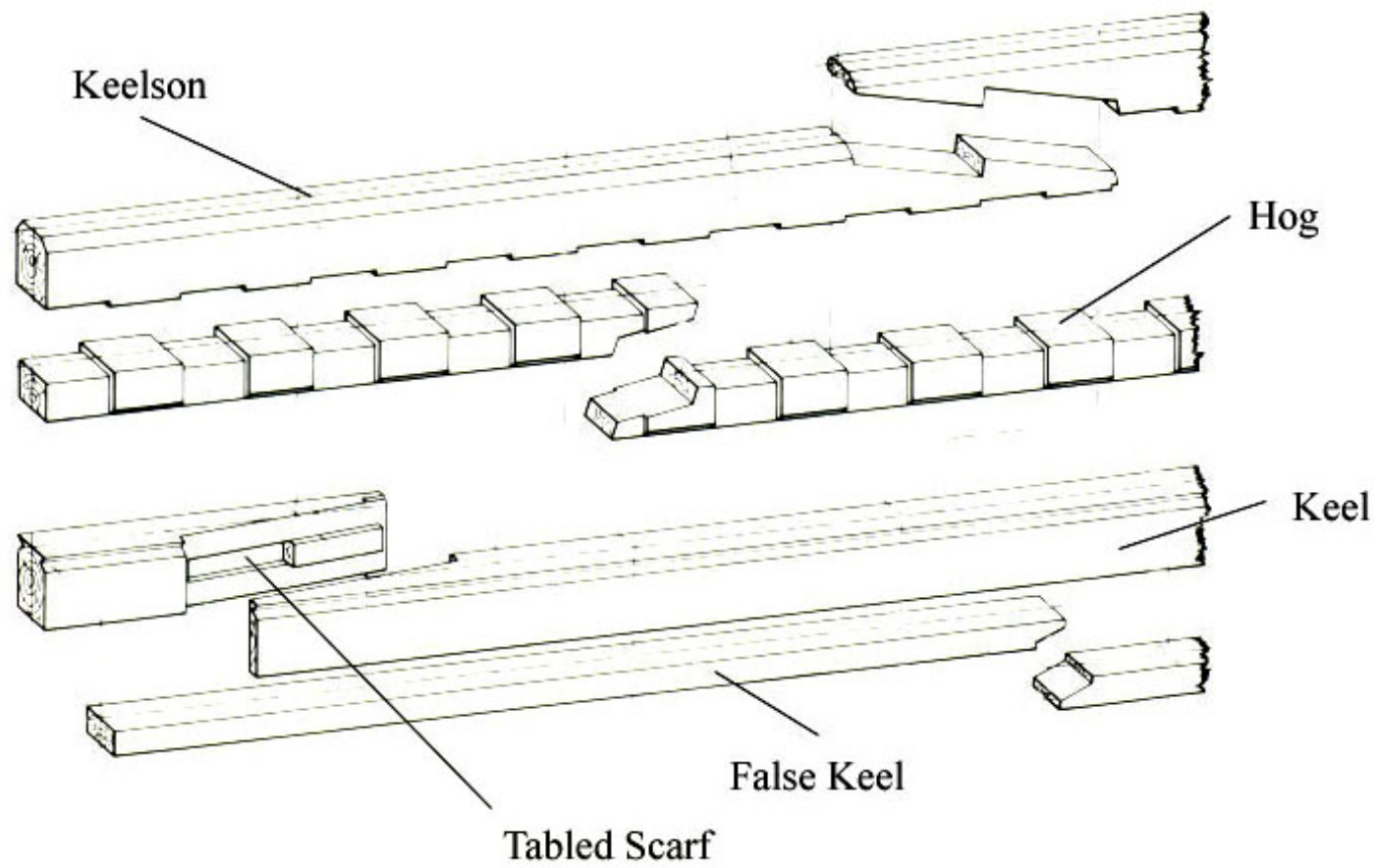

Fig. 4. Keel and keelson assembly detail. From White, 31

36-Gun Royal Navy Frigate  
HMS PALLAS  
1757  
Interior Profile

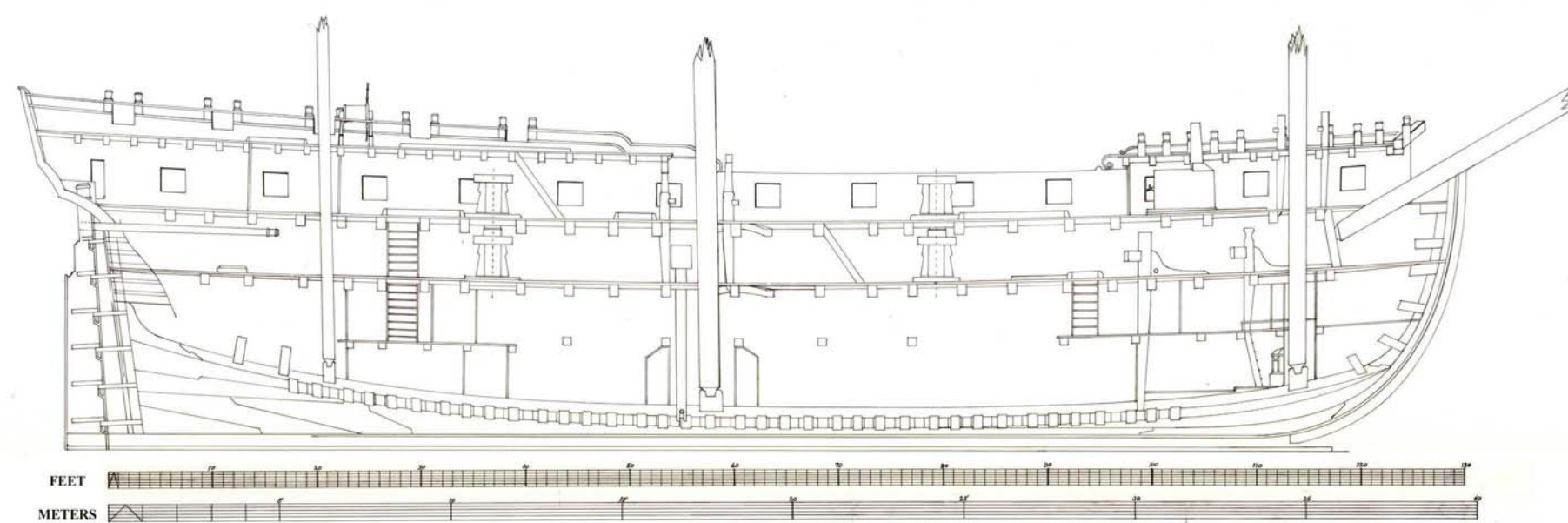

Fig. 5. Interior profile plan for frigate HMS *Pallas*. Based on NMM: ADM 2196 Admiralty drawings HMS *Pallas*

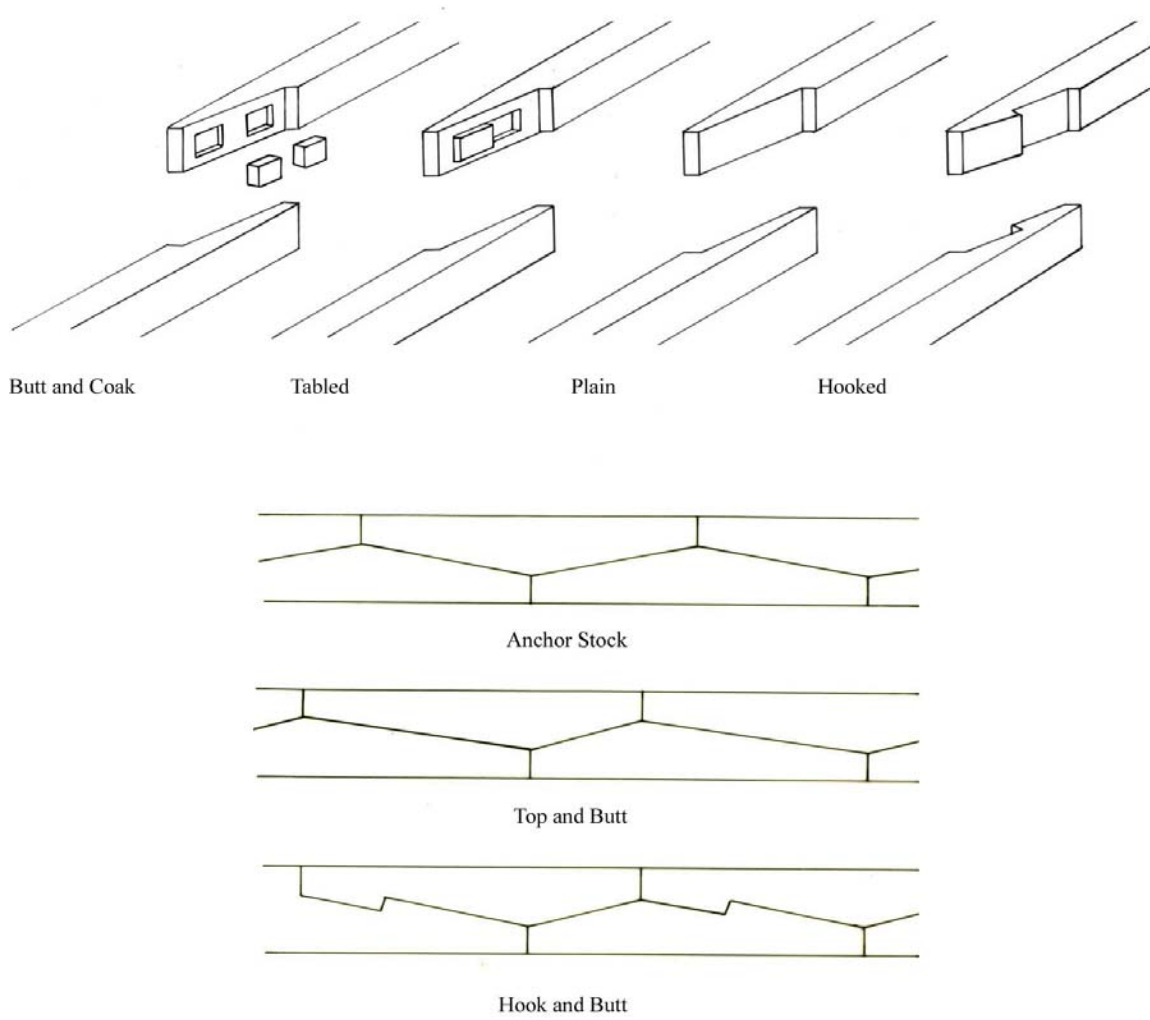

Fig. 6. Various types of scarfs used in construction of *Pallas*.

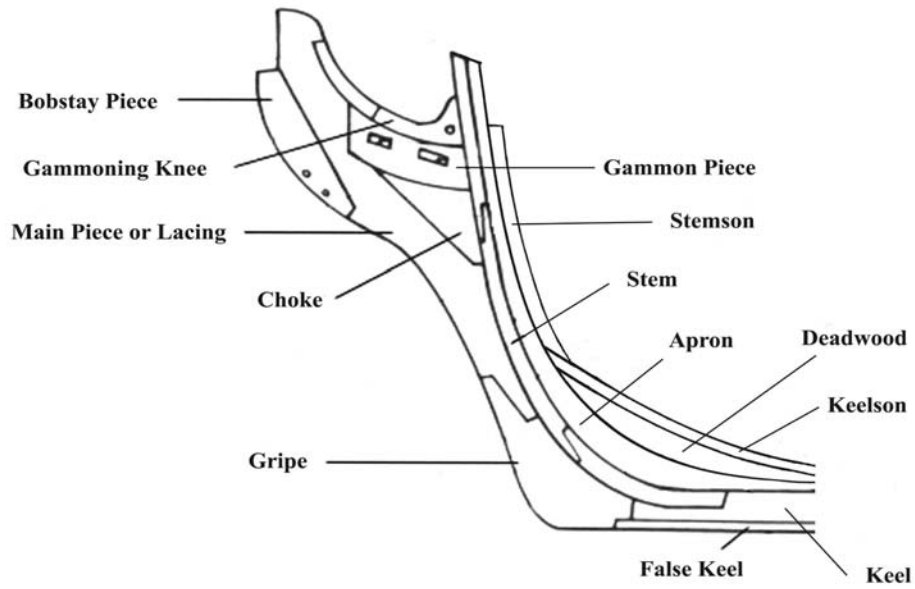

Fig. 7. Stem assembly detail. After Goodwin, 37

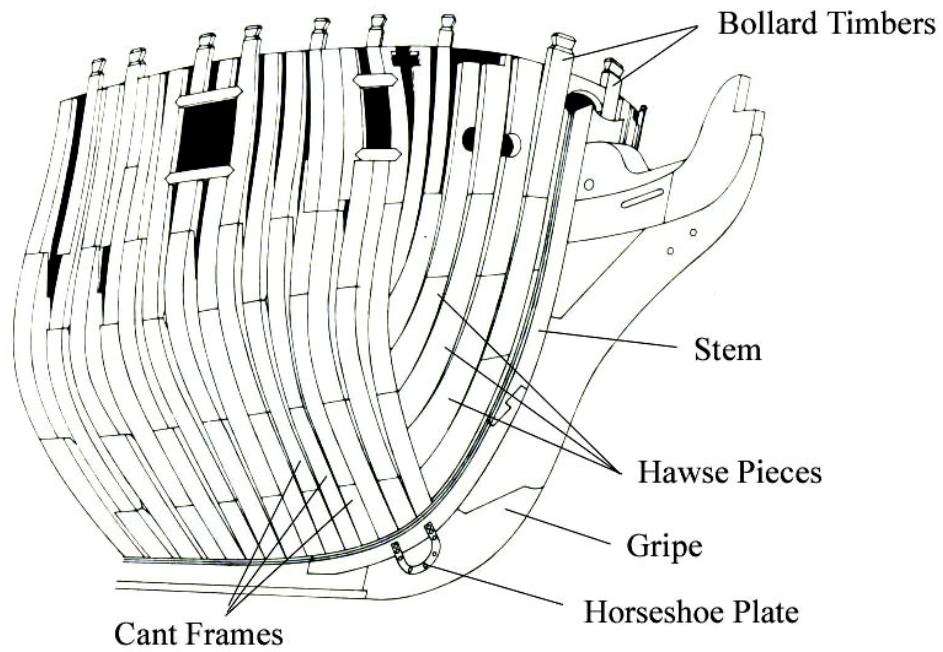

Fig. 8. Bow construction detail of frigate *Pandora*. From McKay and Coleman, 30



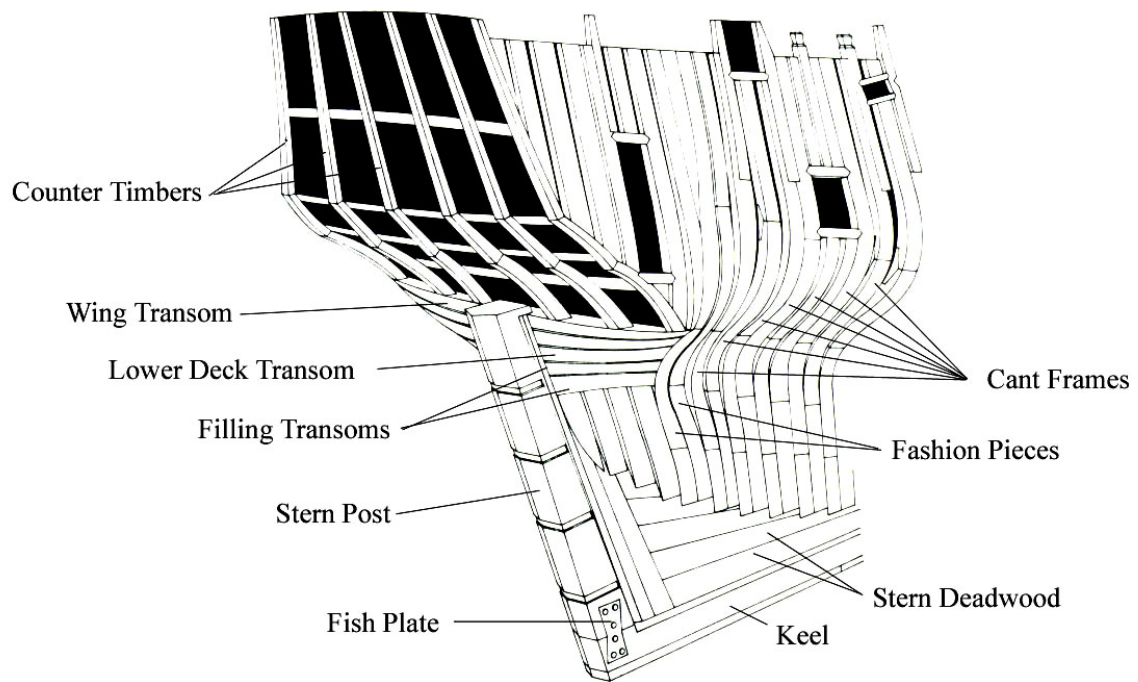

Fig. 9. Stern construction detail of frigate *Pandora*. From McKay and Coleman, 31

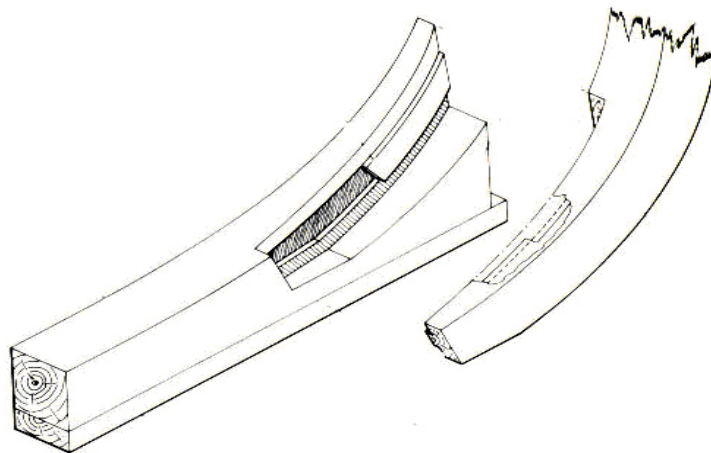

Fig.10. Stem boxing detail. From White, 31

36-Gun Royal Navy Frigate  
HMS PALLAS  
1757

Interior  
Construction Detail

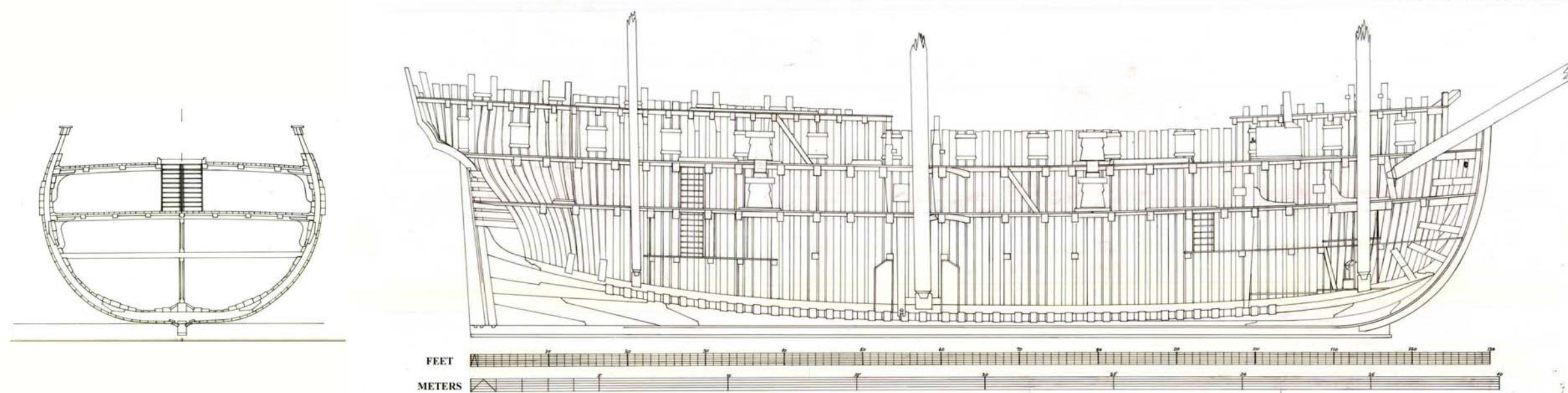

Fig. 11. Interior construction detail for frigate HMS *Pallas*.

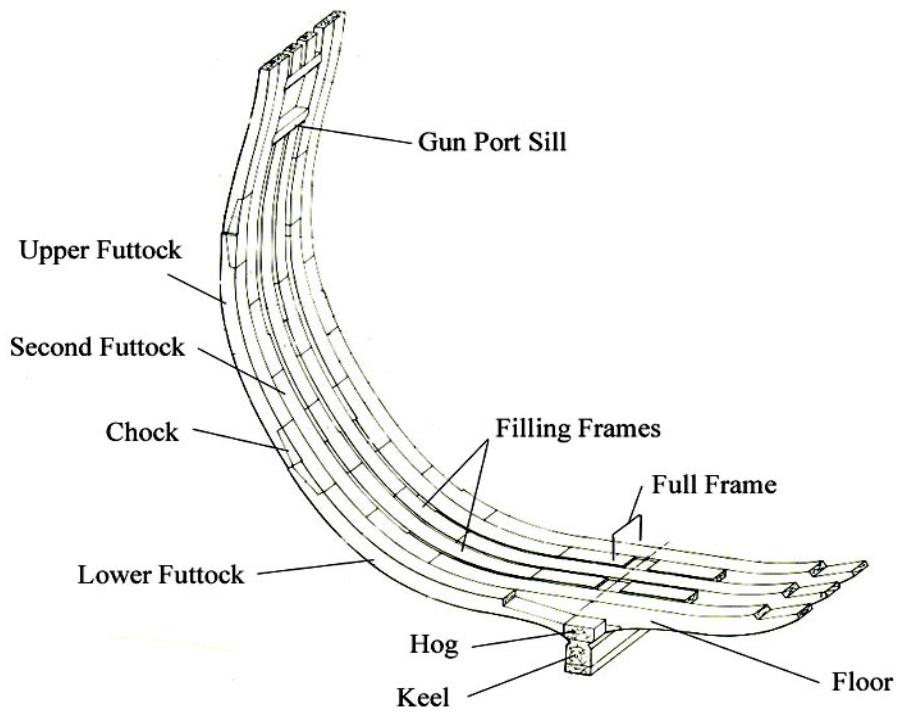

Fig. 12. Frame assembly detail. From White, 39

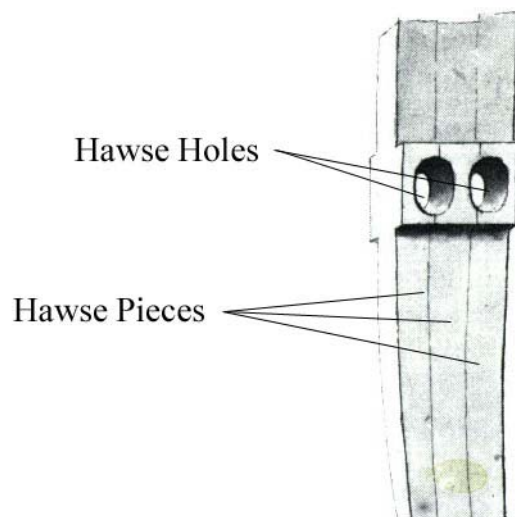

Fig. 13. Hawse pieces detail. From Ollivier, 57

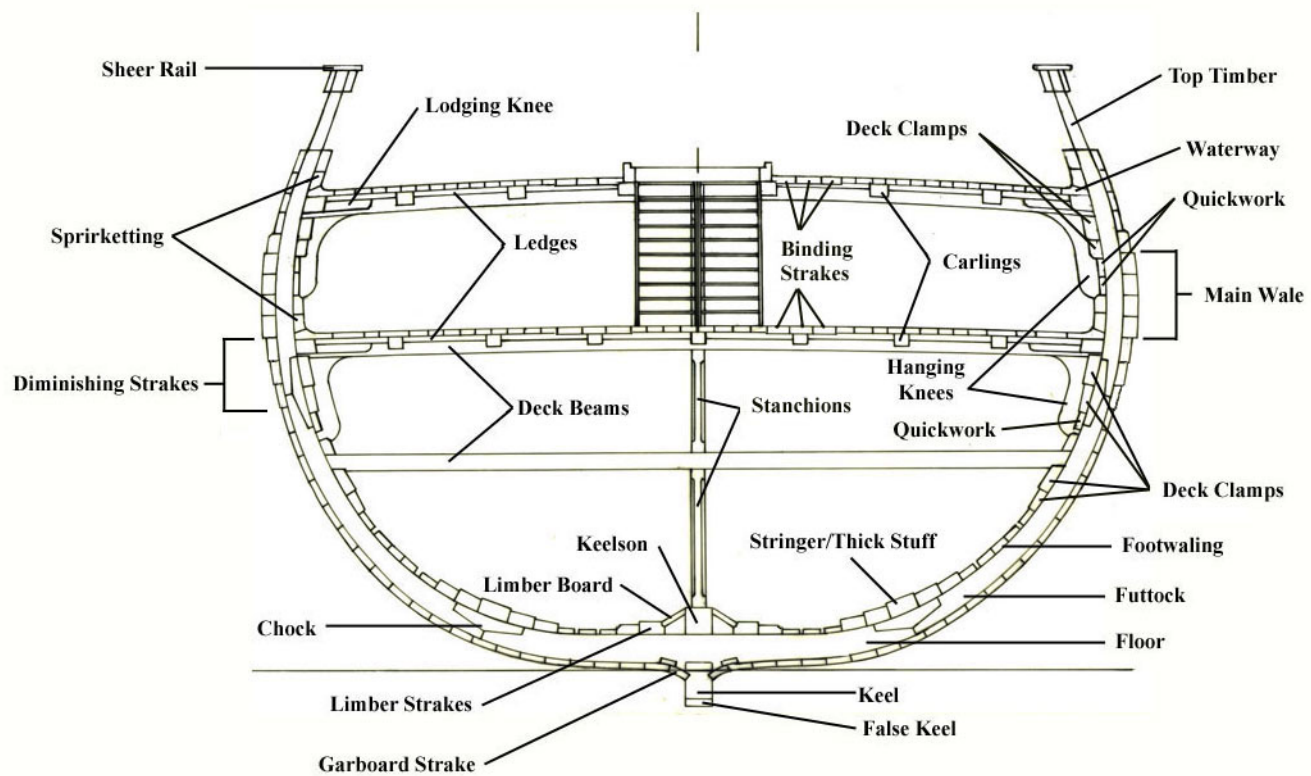

Fig. 14. Midship section detail frigate HMS *Pallas*.

© 2005 by P. Erik Flynn. All Rights Reserved

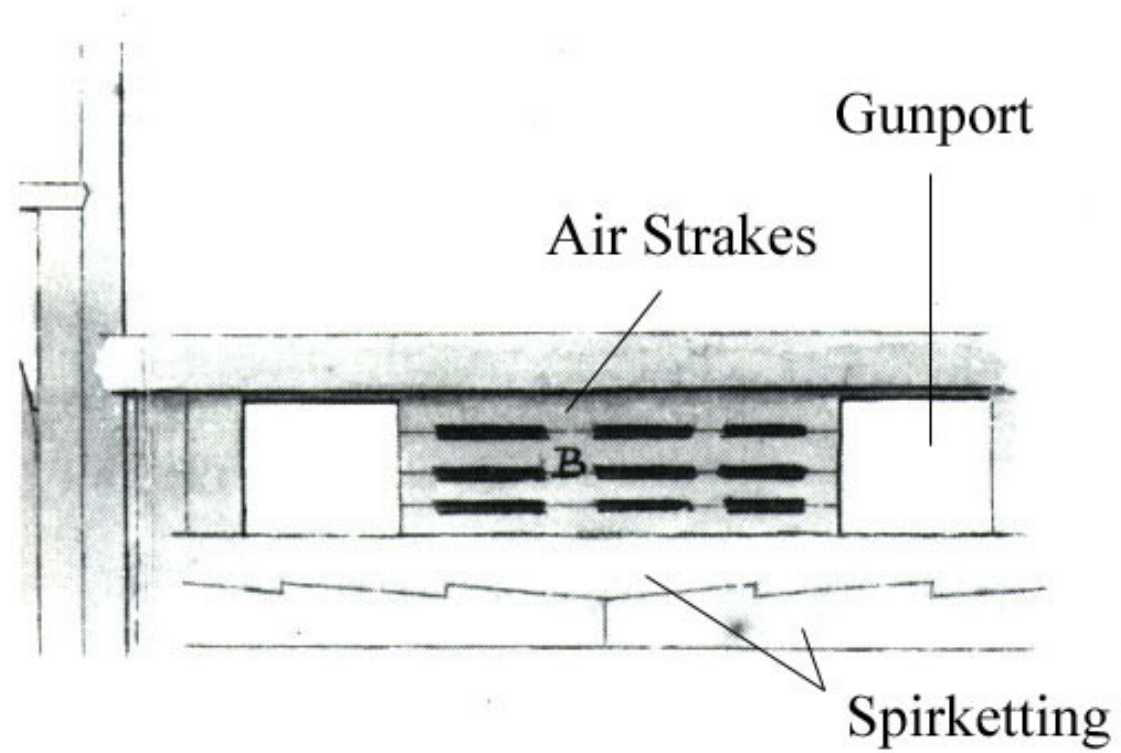

Fig. 15. Spirketting and quickwork detail. From Ollivier, 57

36-Gun Royal Navy Frigate  
HMS PALLAS  
1757  
Gun Deck Plan

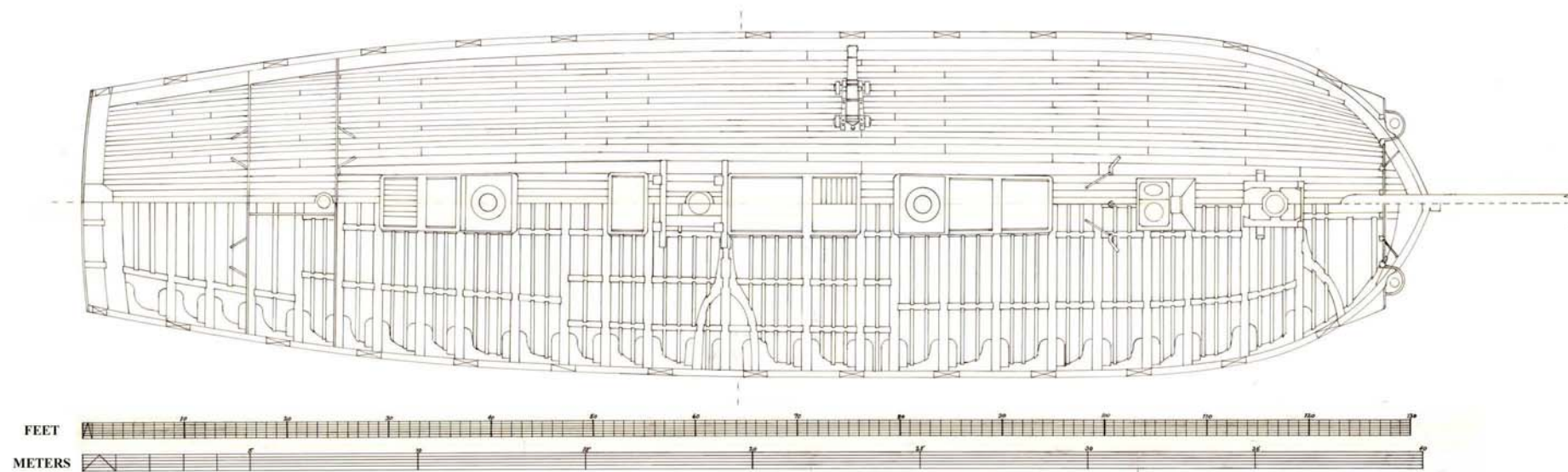

Fig. 16. Gun deck construction detail for frigate HMS *Pallas*.

36-Gun Royal Navy Frigate  
HMS PALLAS  
1757

Lower Deck Plan

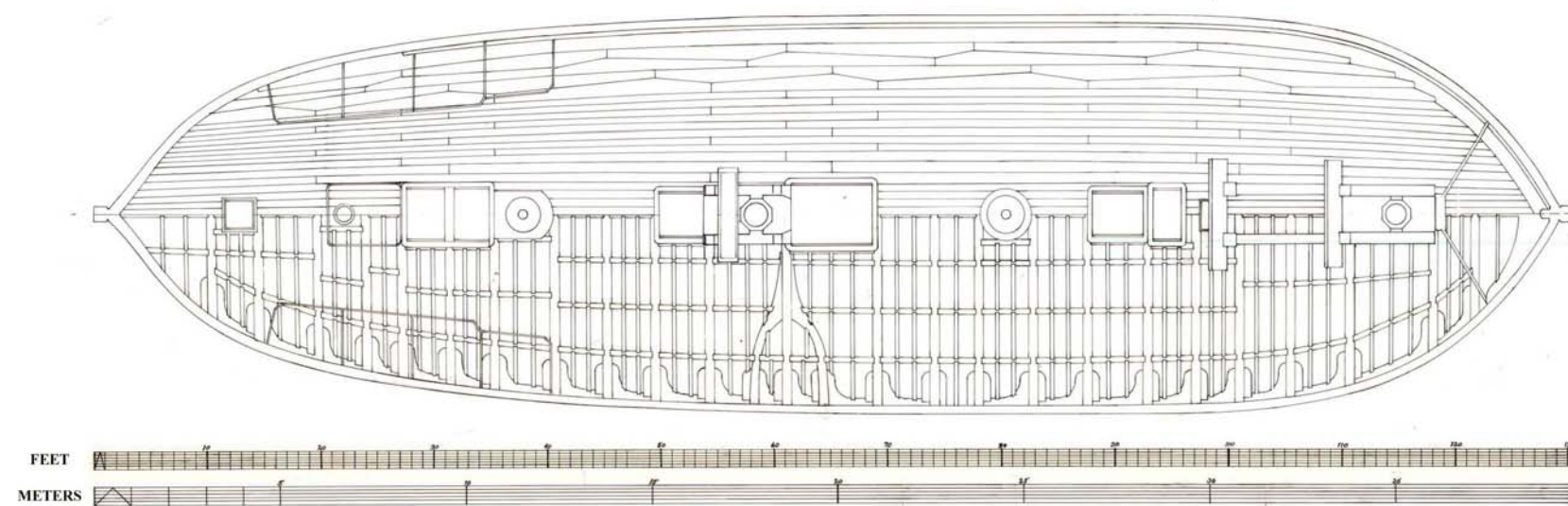

Fig. 17. Lower deck construction detail for frigate HMS *Pallas*.

36-Gun Royal Navy Frigate  
HMS PALLAS  
1757

Orlop Platforms

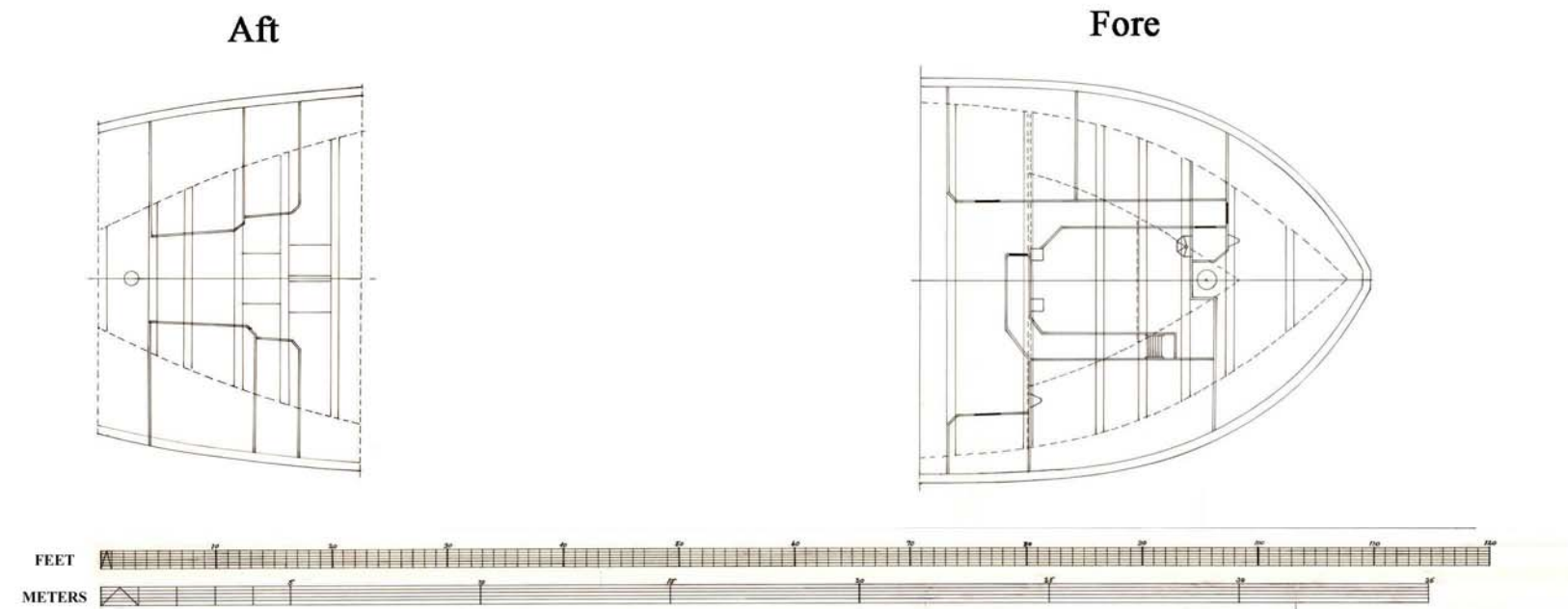

Fig. 18. Fore and aft orlop construction detail for frigate HMS *Pallas*.



36-Gun Royal Navy Frigate  
HMS PALLAS  
1757  
Deck Plans

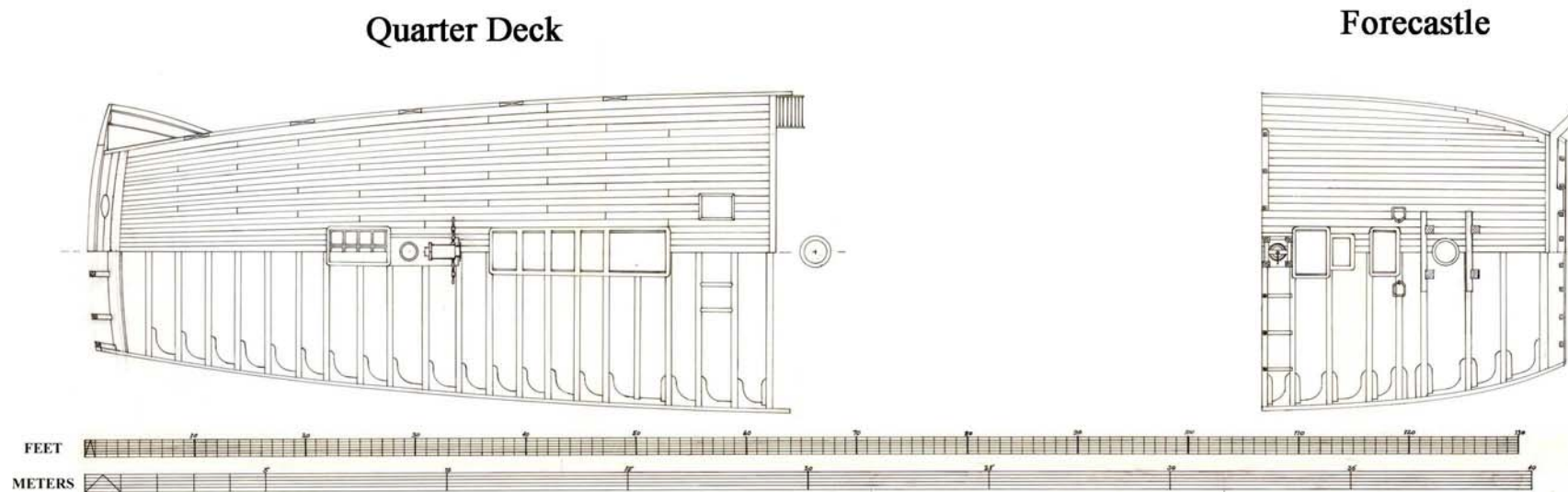

Fig. 19. Quarterdeck and forecastle construction detail for frigate HMS *Pallas*.

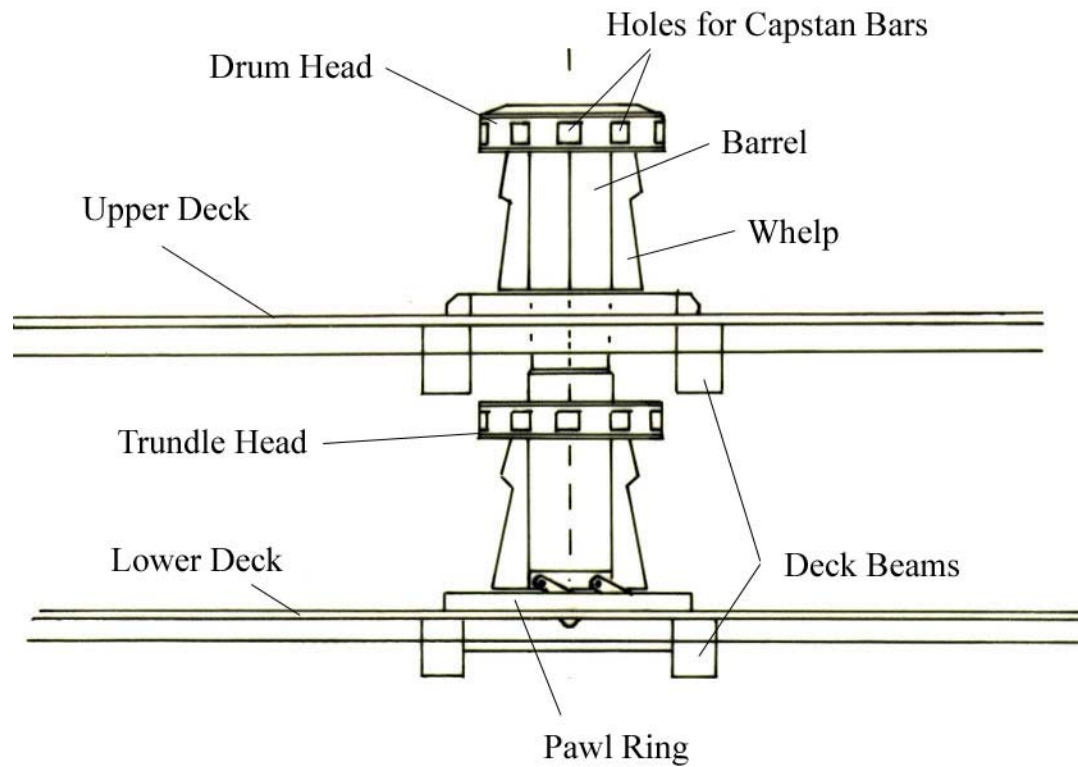

Fig. 20. Detail of capstan. Based on ADM 2196 Admiralty drawings HMS *Pallas*

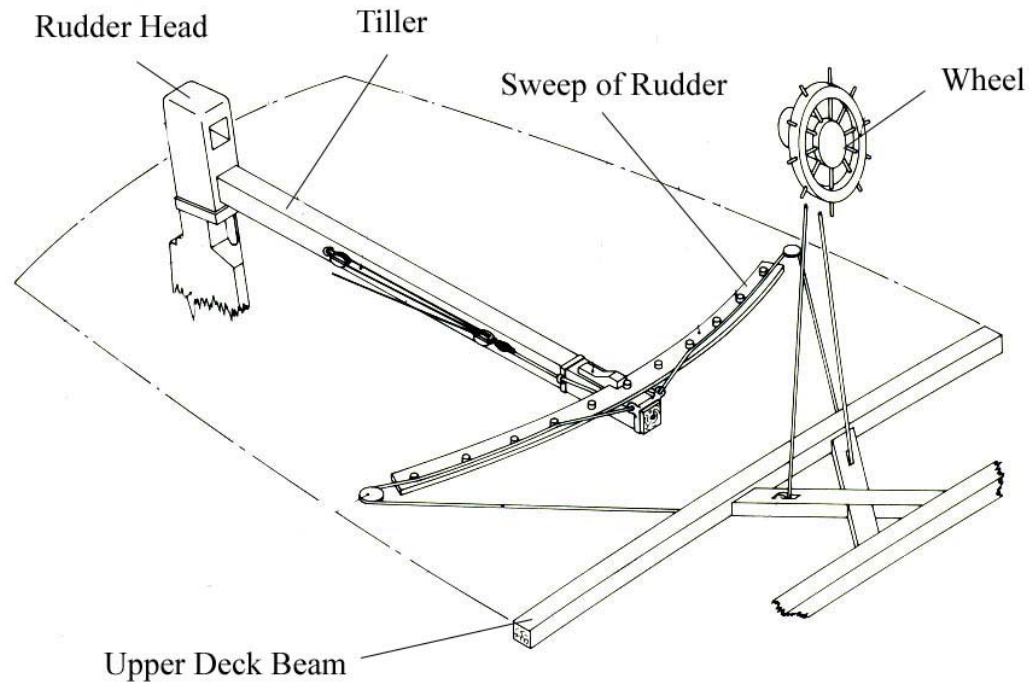

Fig. 21. Wheel and tiller detail. From White, 112

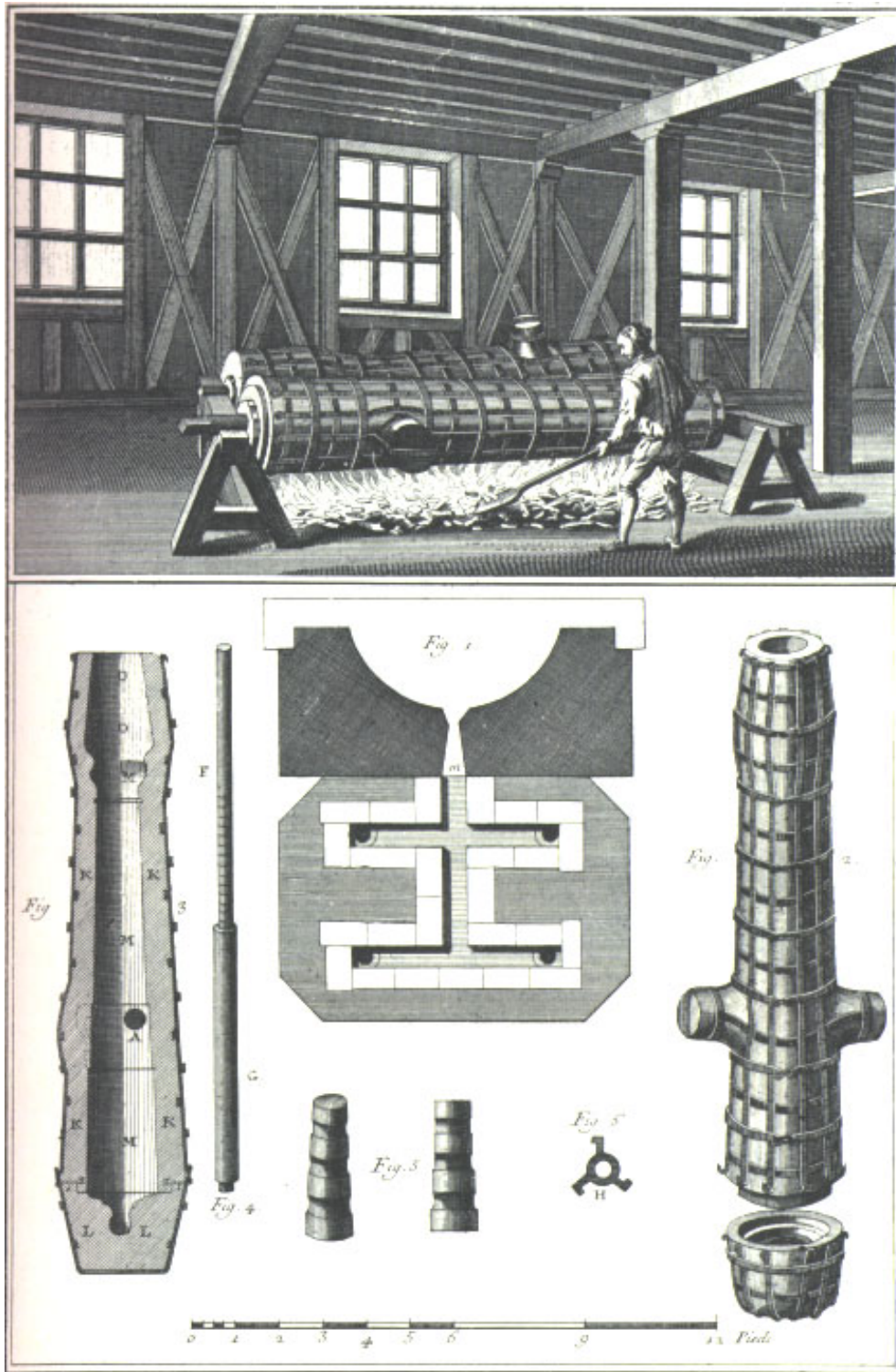

Fig. 22. Contemporary engraving of gun founding process. From Diderot, 1123

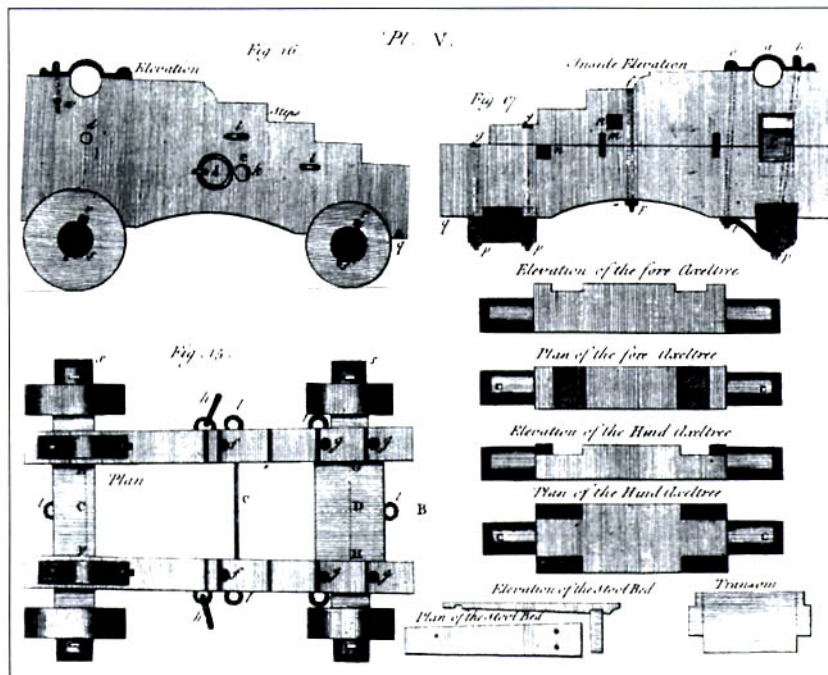

Fig. 23. Gun carriage. From Millan, Plate V.

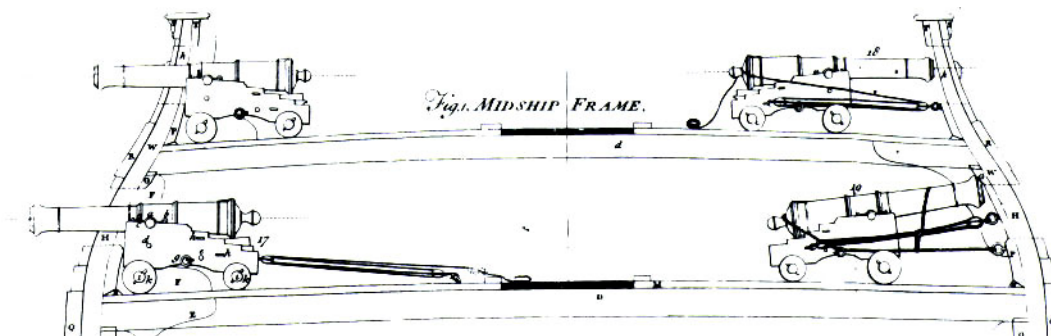

Fig. 24. Detail of gun tackle and operation from the late 18<sup>th</sup> century. From Falconer, 203, Plate VII

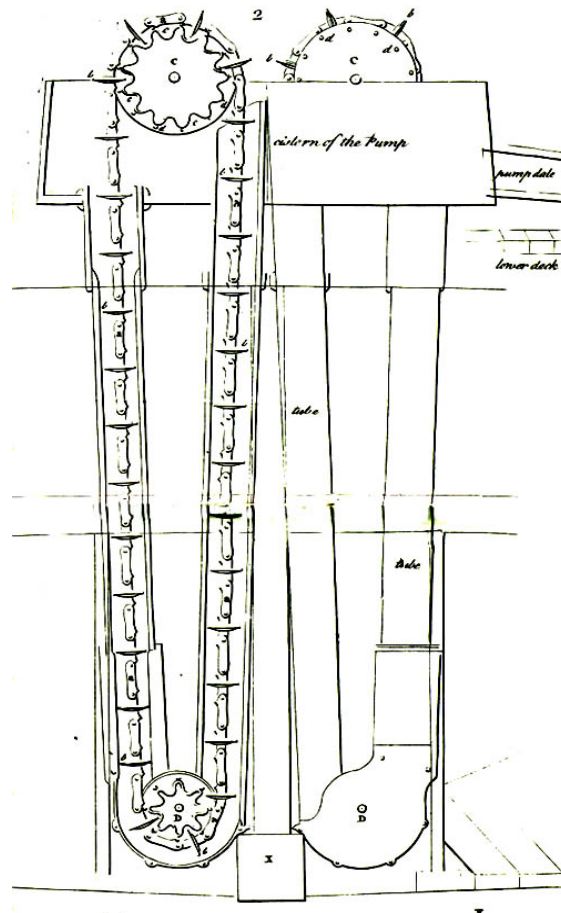

Fig. 25. Mid 18<sup>th</sup>-century chain-pump detail. From Falconer, 217, Plate VI

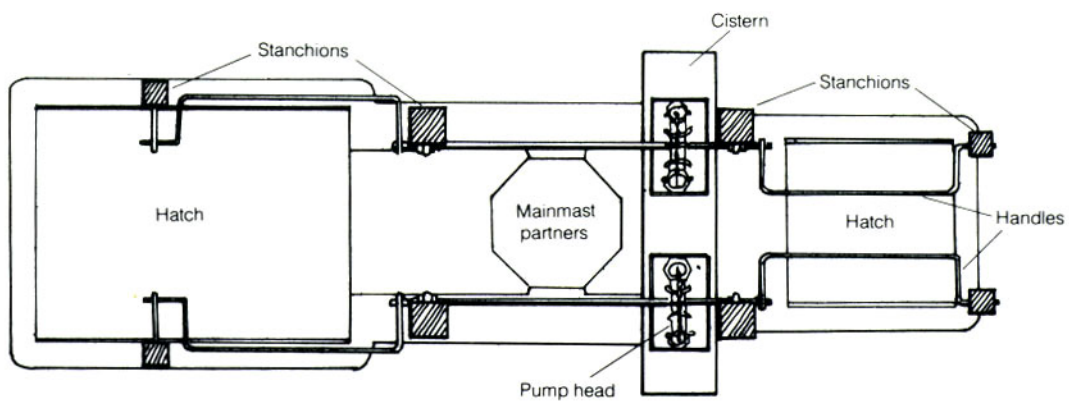

Fig. 26. Overhead view of chain-pump, Lavery, 1987, 71

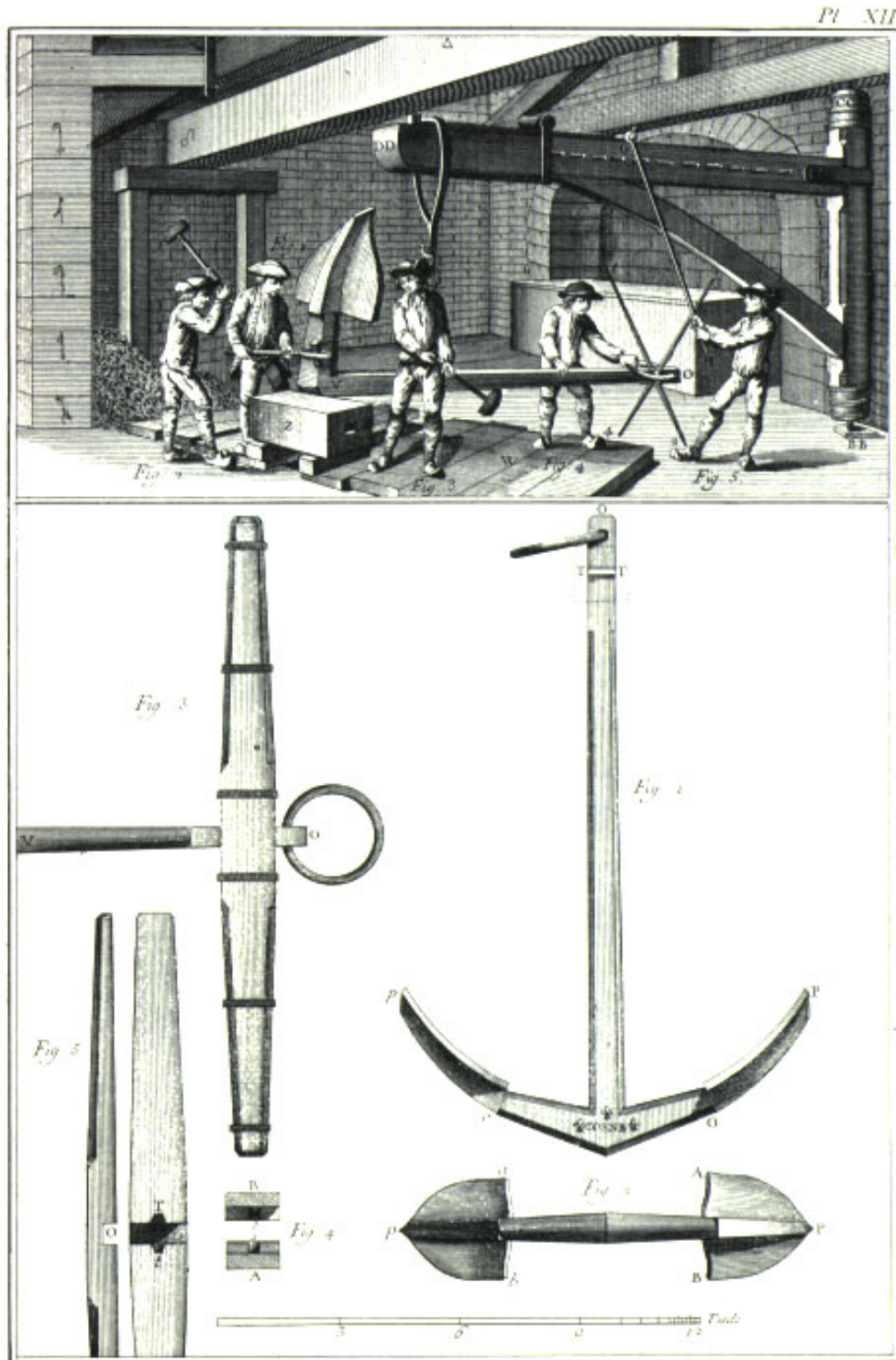

Fig. 27. Contemporary engraving of anchor making process. From Diderot, 1683

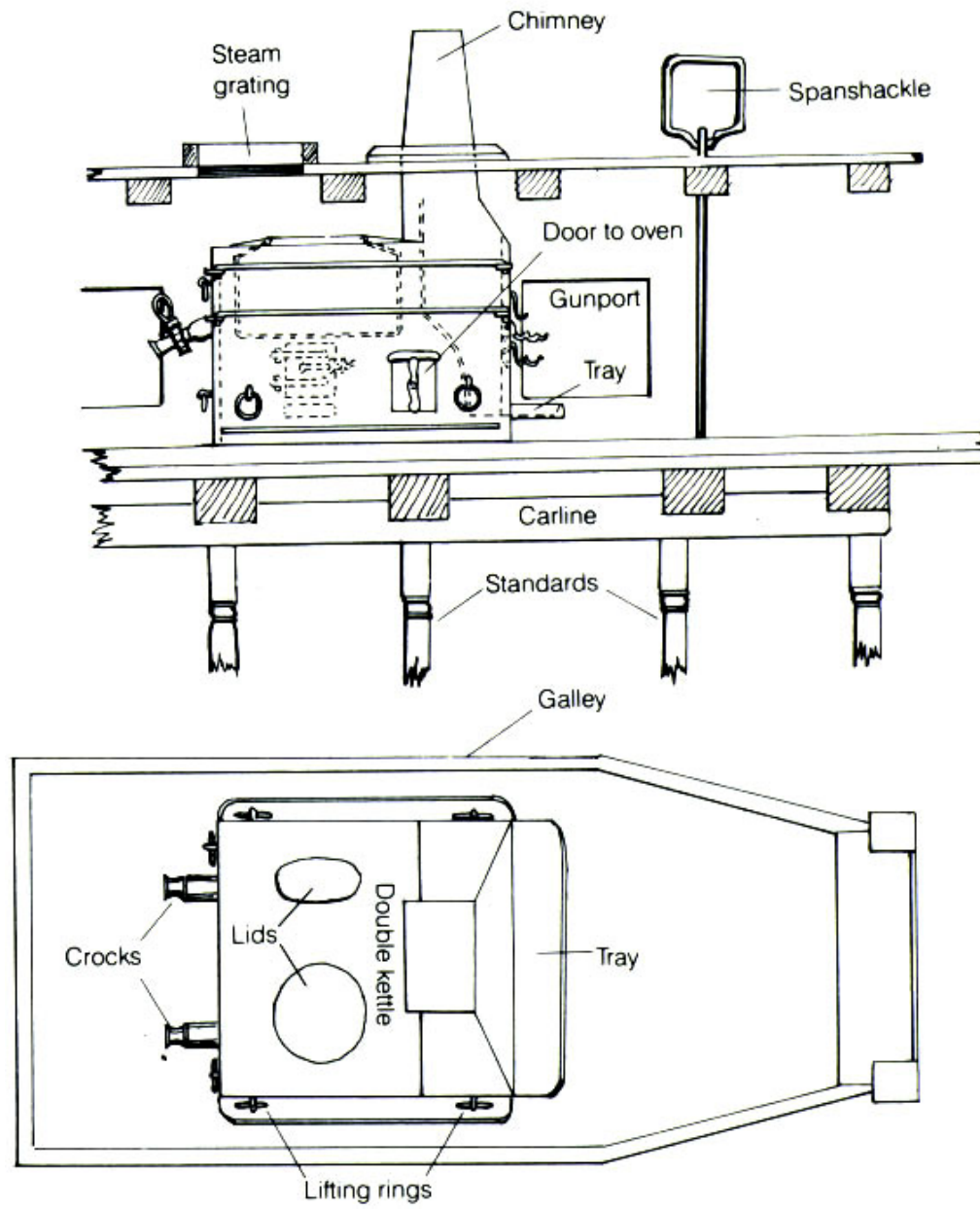

Fig. 28. Iron stove from HMS *Dorsetshire*, 1757. From Lavery, 1987, 197



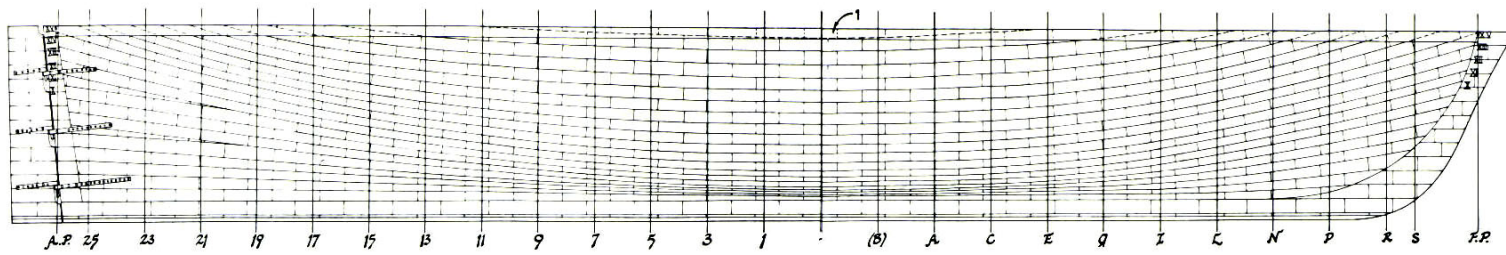

Fig. 29. Copper sheathing on hull of *Pandora*. From McKay and Coleman, 26-7

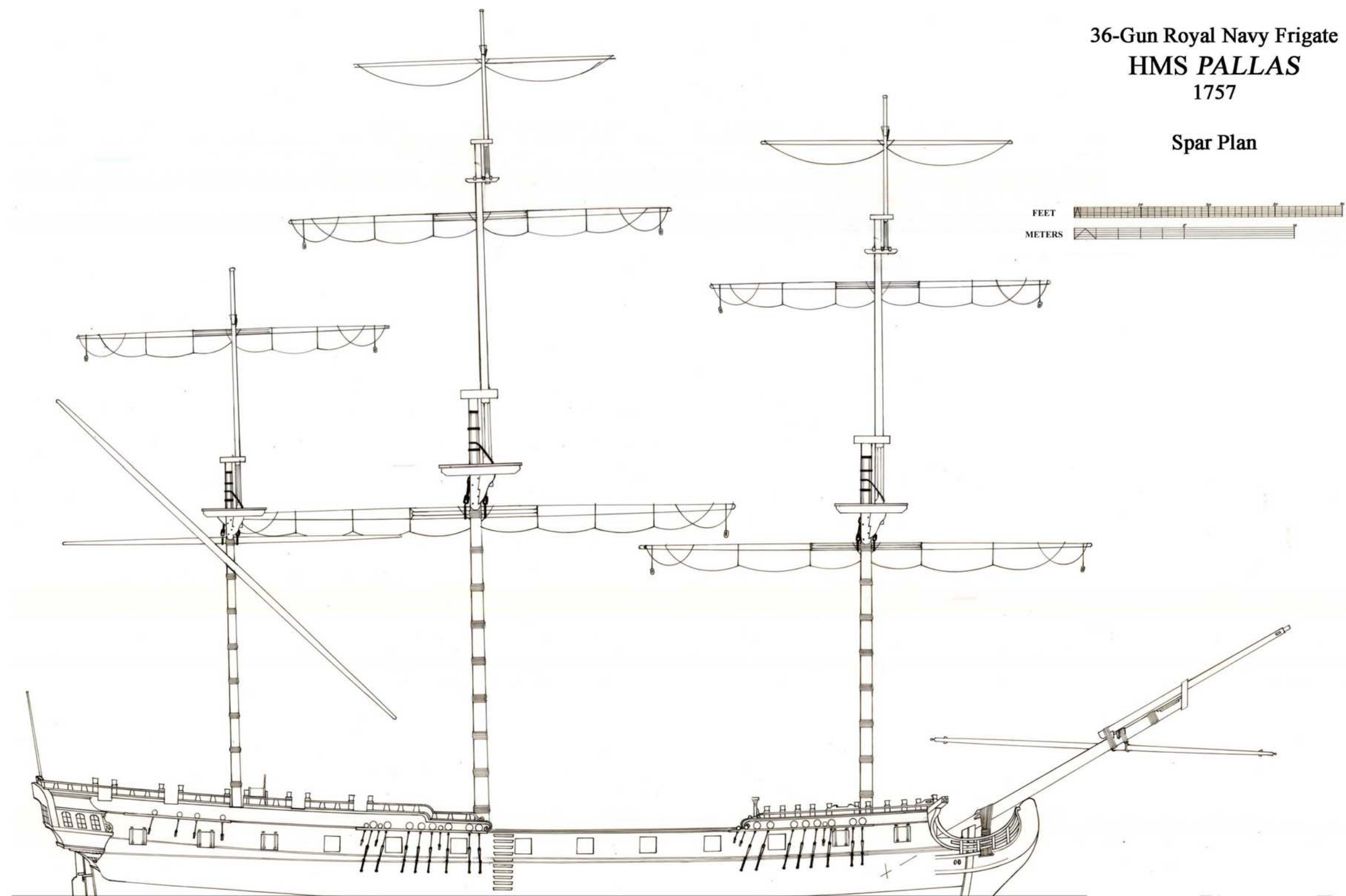

Fig. 30. Spar plan for frigate HMS *Pallas*.

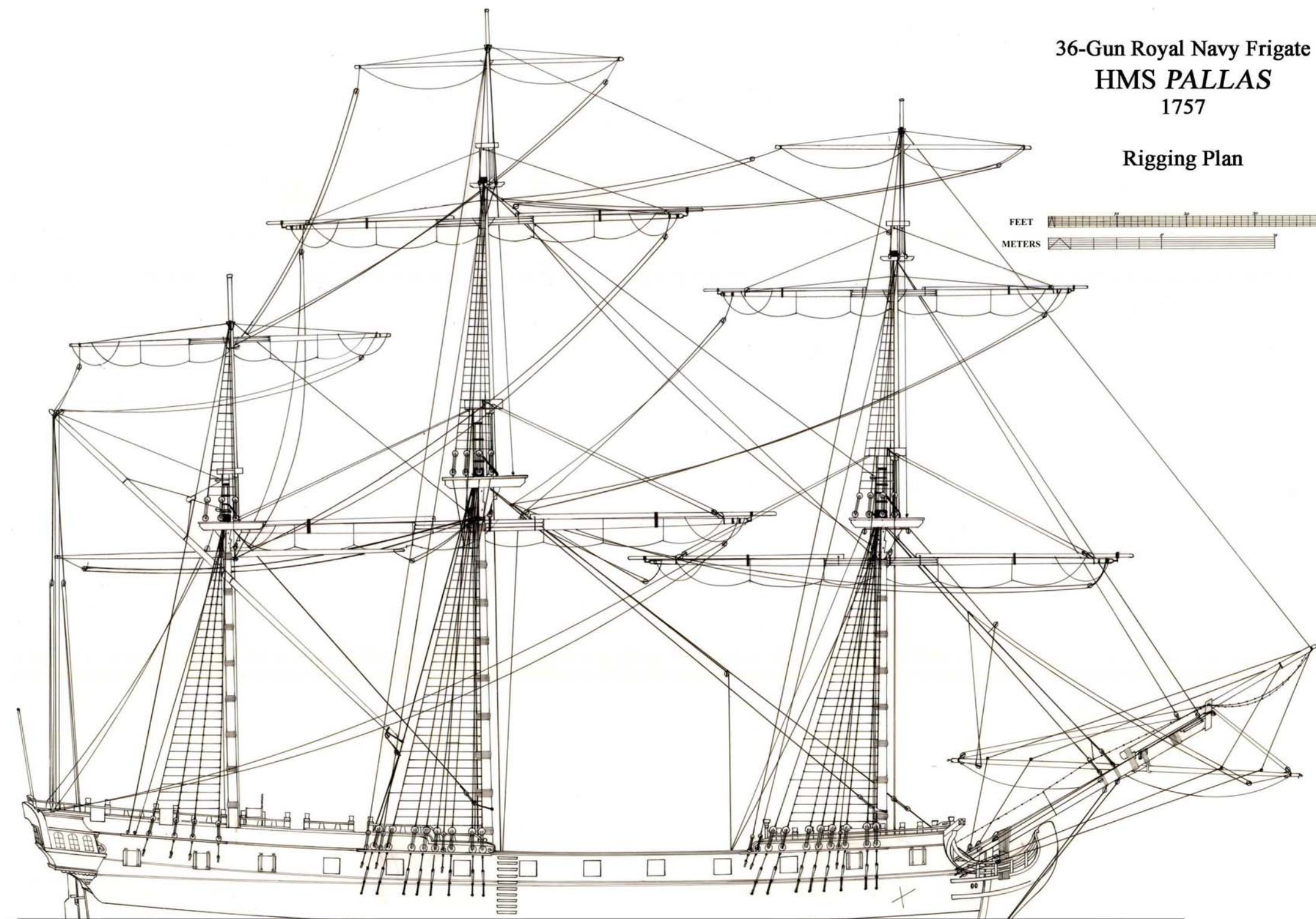

Fig. 31. Rigging plan detail for frigate HMS Pallas.

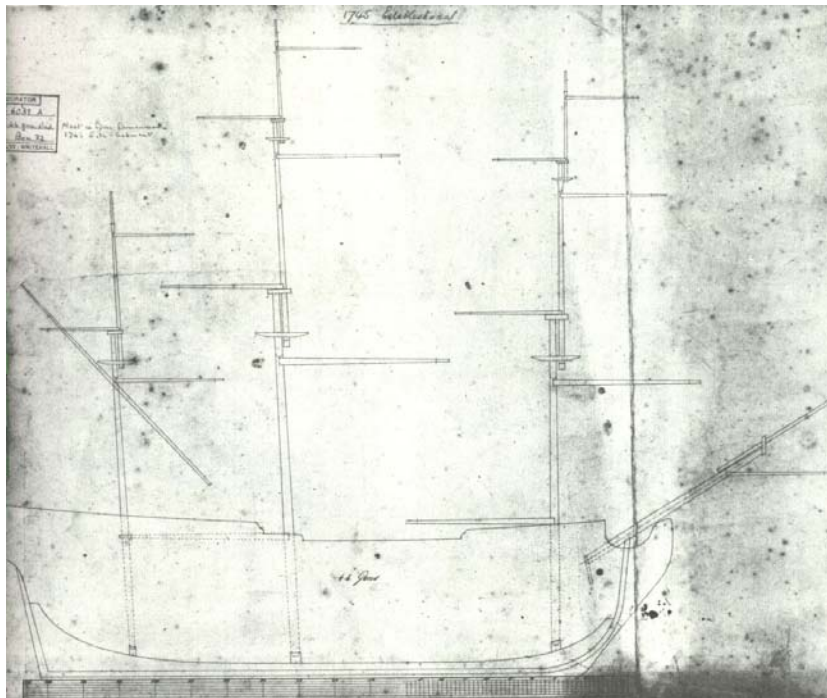

Fig. 32. Draft of 1745 Establishment, 44-gun ship showing spar details. From Lees, 37, Plate 21

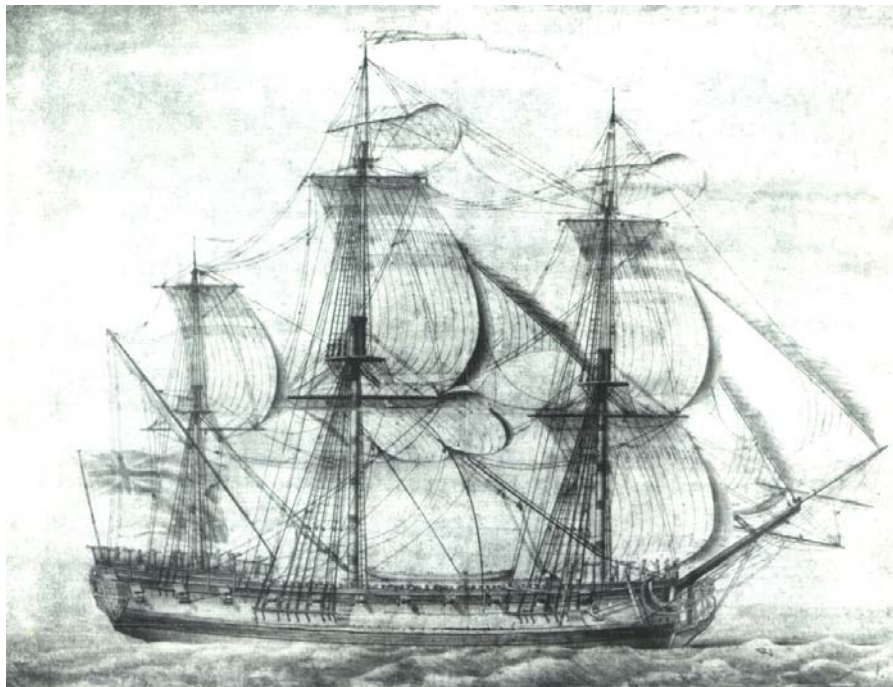

Fig. 33. Watercolor of 50-gun ship HMS *Lion* showing rigging details. From Ollivier, 44

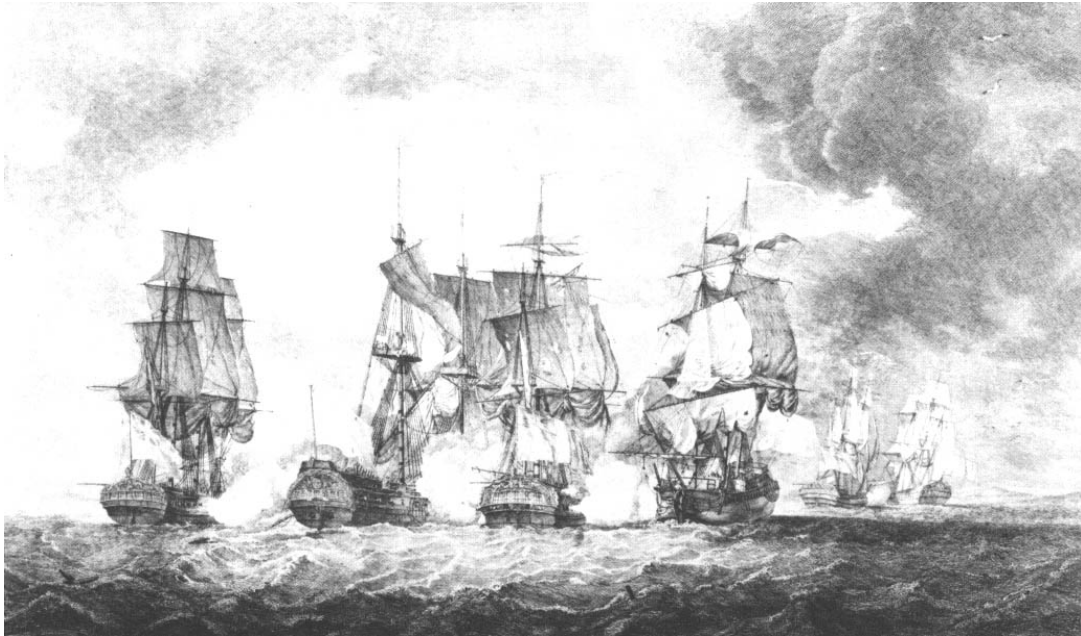

Fig. 34 The Isle of Man Action, 1760. Painted by Richard Wright. From Warner, 90



Fig.35. Two British frigates off the African coast. The one on the left is probably *Pallas*. Watercolor by Lt. Gabriel Bray, From Spavens, 91



Fig. 36. Fishing from the anchor on board *Pallas* in Senegal Road. Watercolor by Lt. Gabriel Bray, From Spavens, 74



Fig. 37. Sail-maker ticketing hammocks on board *Pallas*. Watercolor by Lt. Gabriel Bray, From Spavens, 123



Fig. 38. Wardroom leisure on board *Pallas*. Watercolor by Lt. Gabriel Bray, From Spavens, 74



Fig.39. Marines mess on board *Pallas*. Watercolor by Lt. Gabriel Bray, From Spavens, 107

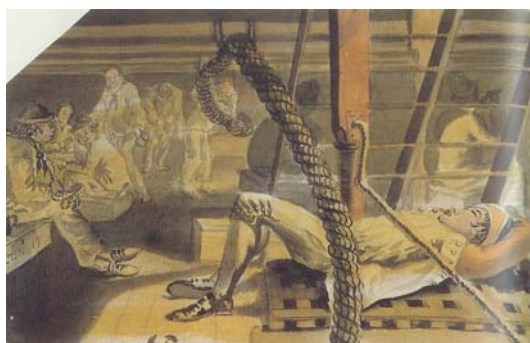

Fig 40. Lower deck on board *Pallas* (note pump crank handle) Watercolor by Lt. Gabriel Bray, From Spavens, 123

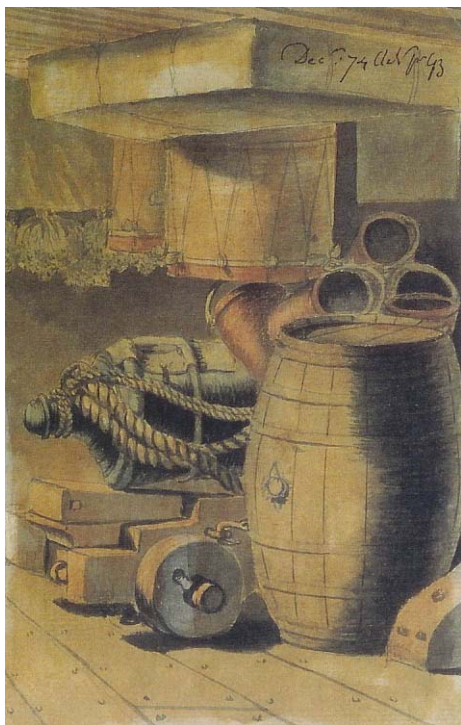

Fig. 41. Gun deck onboard *Pallas*. Watercolor by Lt. Gabriel Bray, From Spavens, 91

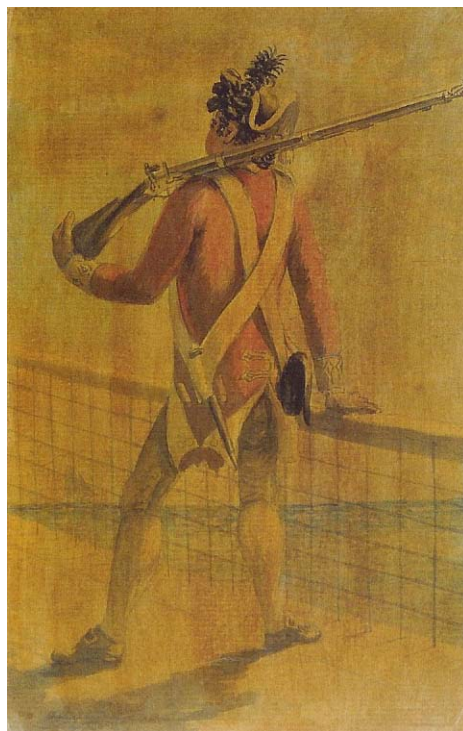

Fig. 42. Marine sentinel on board *Pallas*. Watercolor by Lt. Gabriel Bray, From Spavens, 75



Fig. 43. Fishing off a gun onboard *Pallas*. Watercolor by Lt. Gabriel Bray, From W. Spavens, 90



Fig. 44. A Homeward-bound West India convoy September 1782 By Robert Dodd, with the merchantman *Lady Juliana* in the foreground, in the tow of the frigate *Pallas*. From Rodger, *Command of the Ocean*, 510 Plate 22b.



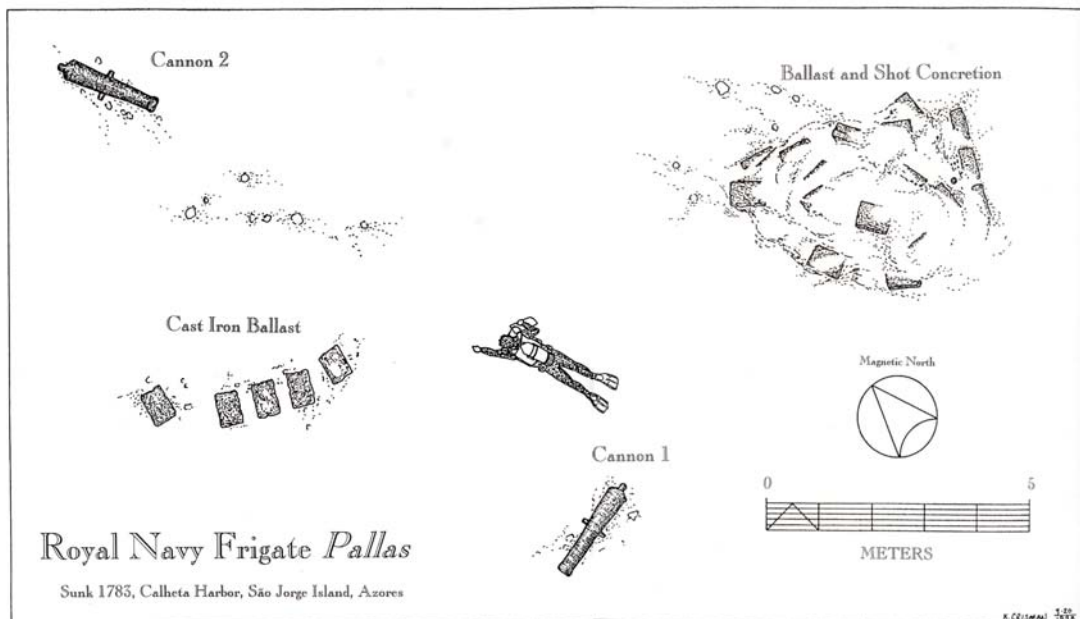

Fig. 45. Site plan of *Pallas* Wreck, Calheta harbor, São Jorge, Azores.  
Courtesy of Kevin Crisman

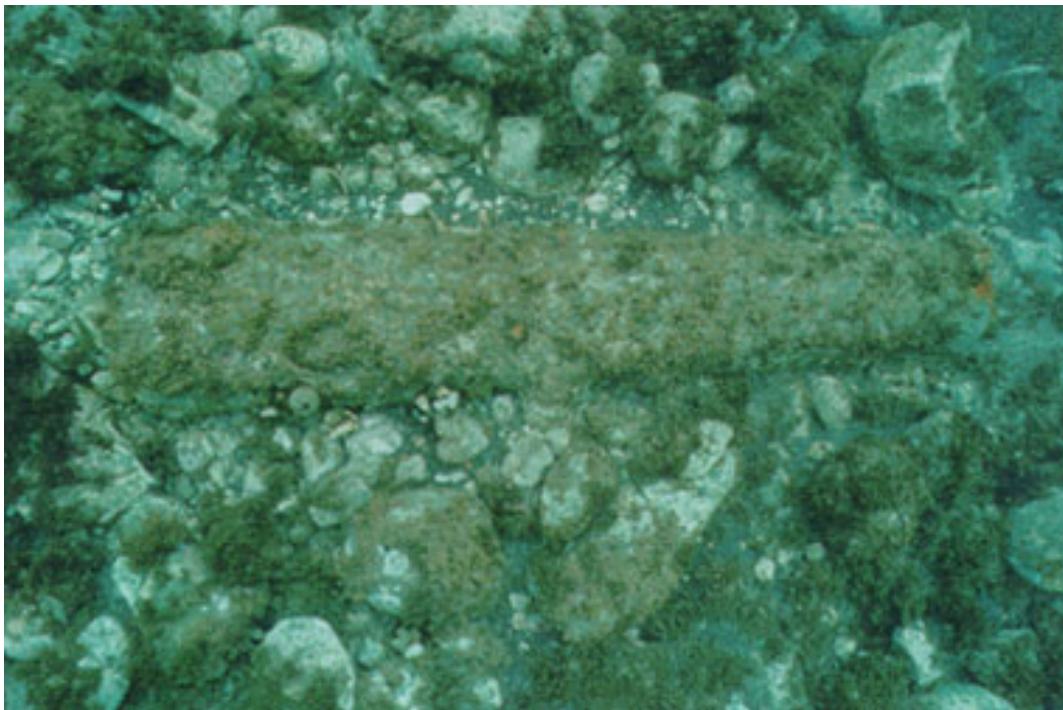

Fig. 46. One of two concreted 6-pound cannon in situ at the site. Garcia and Monteiro p. XVIII

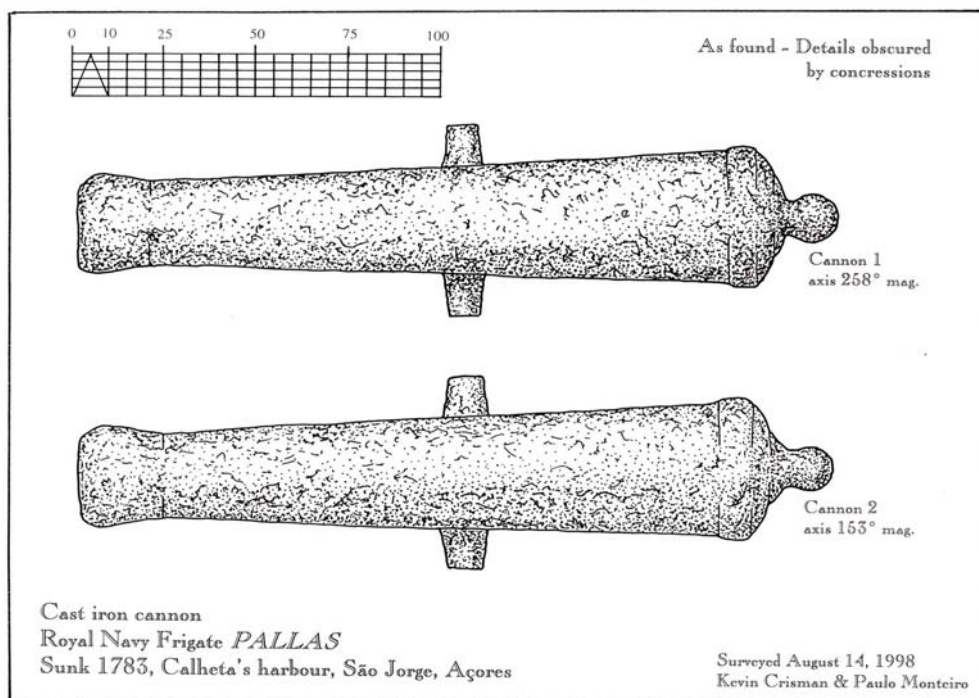

Fig. 47. Drawings of the 6-pound cannon found at the site. Courtesy of Kevin Crisman

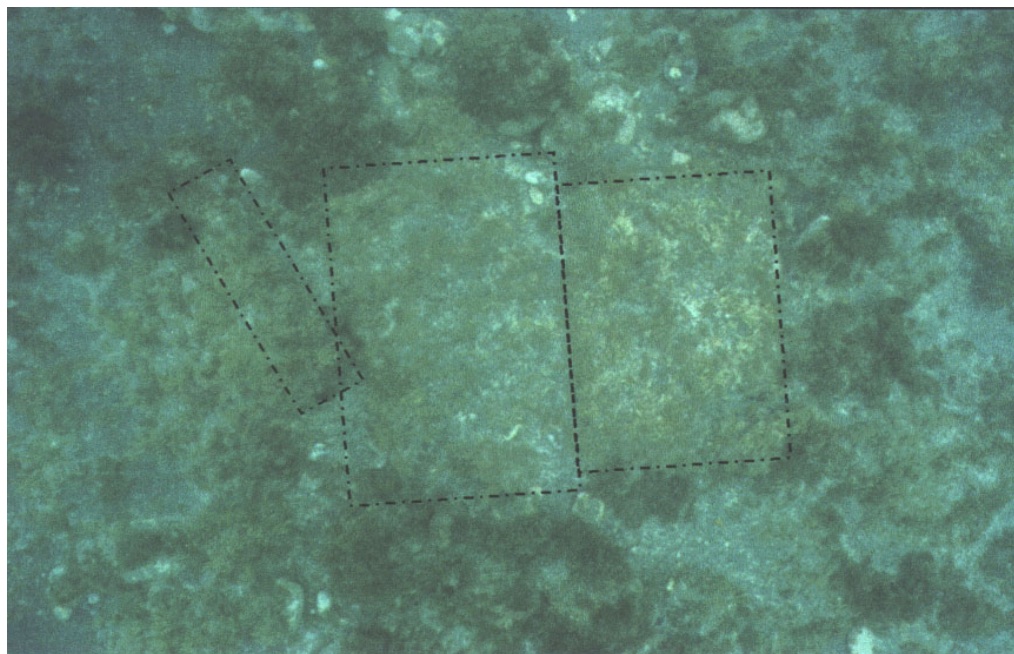

Fig. 48. Concreted cast iron ingots from ballast. Garcia and Monteiro p. XIX



Fig. 49 Copper nails and a possible wedge from a forelock bolt found at the site. Garcia and Monteiro p. XIII



Fig. 50 Copper sheathing found in test trench at the site. Garcia and Monteiro p. XIV



Fig. 51. Lead sounding weight (CAL/ 00-191) found at the site. Garcia and Monteiro p. XII



Fig. 52. Lead sounding weight (CAL/ 00-12) found at the site. Garcia and Monteiro p. XII



Fig. 53. Lead musket shot found at the site. Garcia and Monteiro p. XVI



Fig. 54. Iron shot found at the site. Garcia and Monteiro p. XVI



Fig. 55. Four types of pottery found in test trench at the site. Garcia and Monteiro p. X



Fig. 56. A variety of copper coins found at the site. Garcia and Monteiro p. XV

## APPENDIX B

## MAPS

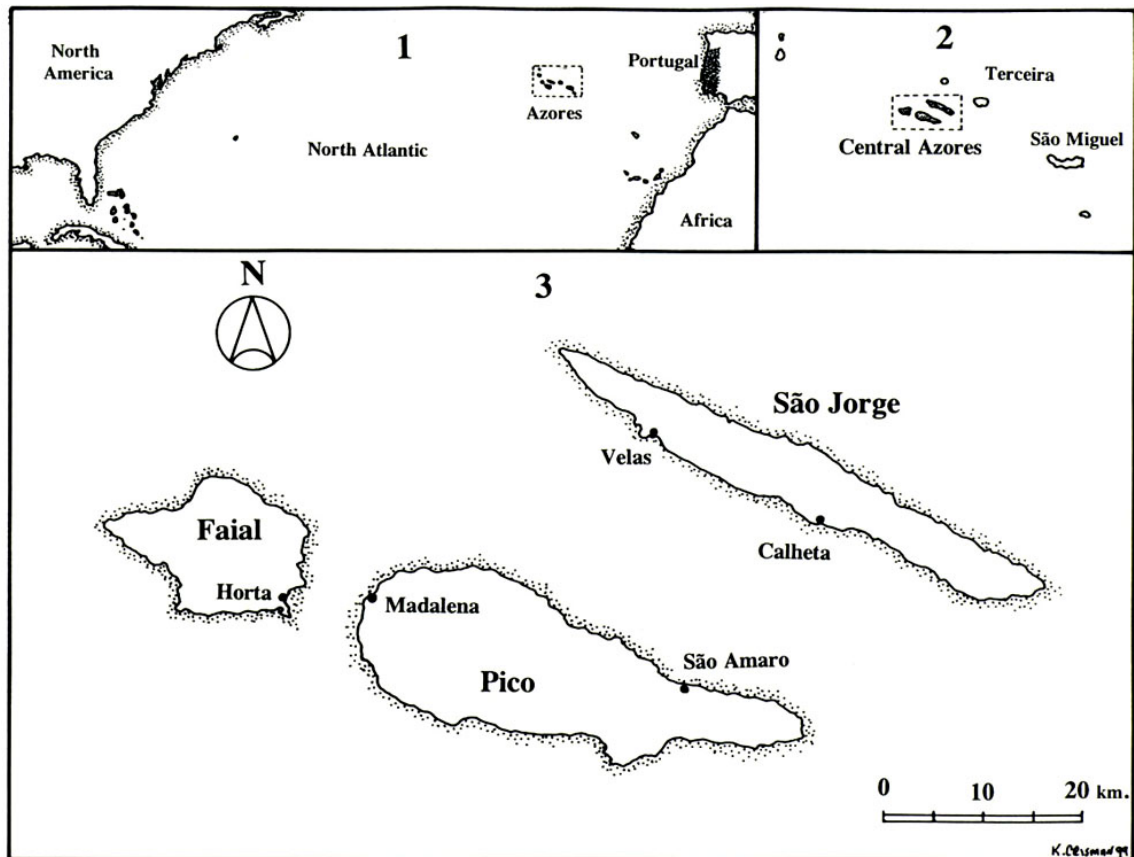

Map 1. The Central Azores and the Island of Sao Jorge in the North Atlantic.  
Courtesy of Dr. Kevin Crisman.

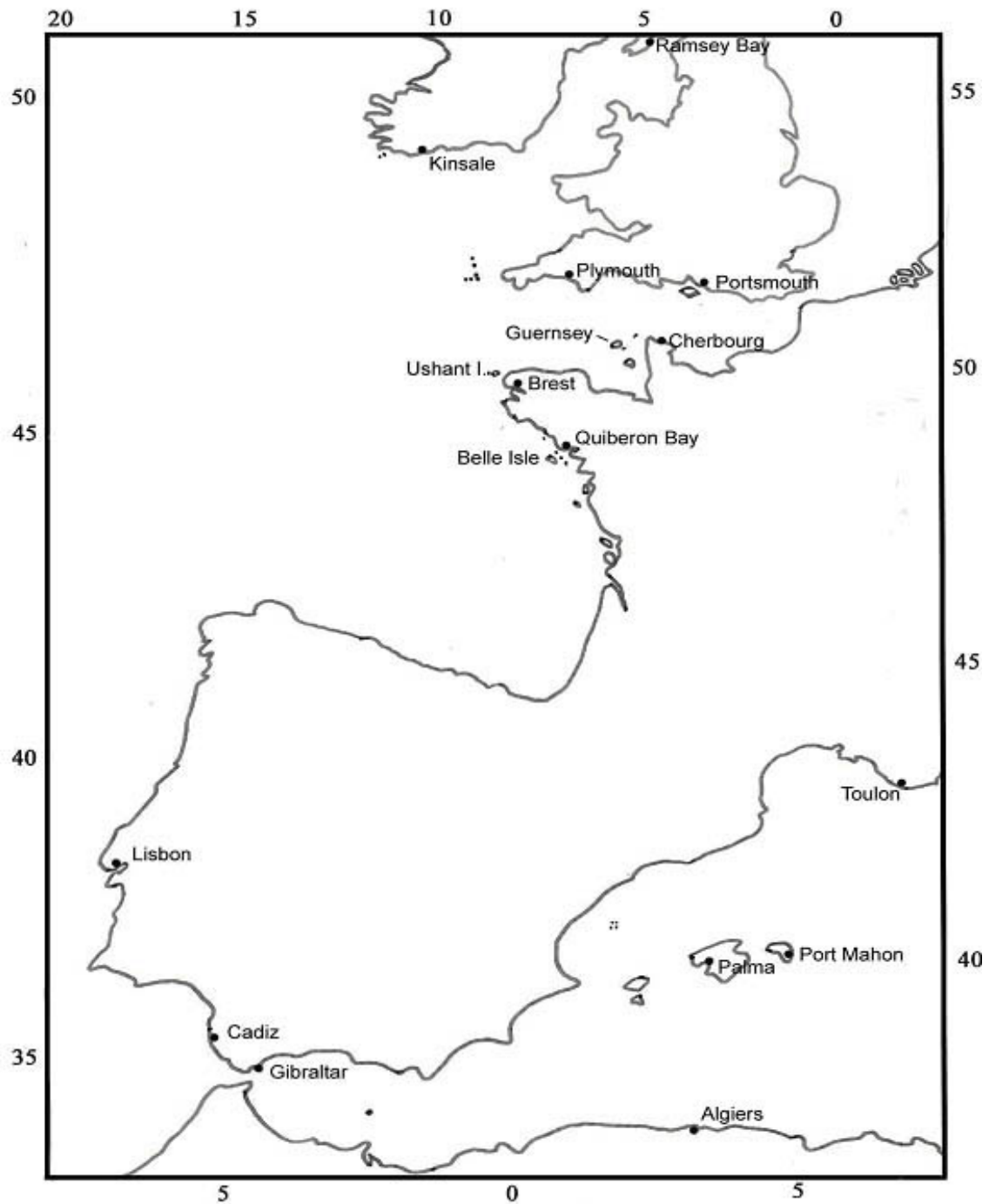

Map 2. British home waters and western approaches. (after National Geographic Atlas of the world, p.53)



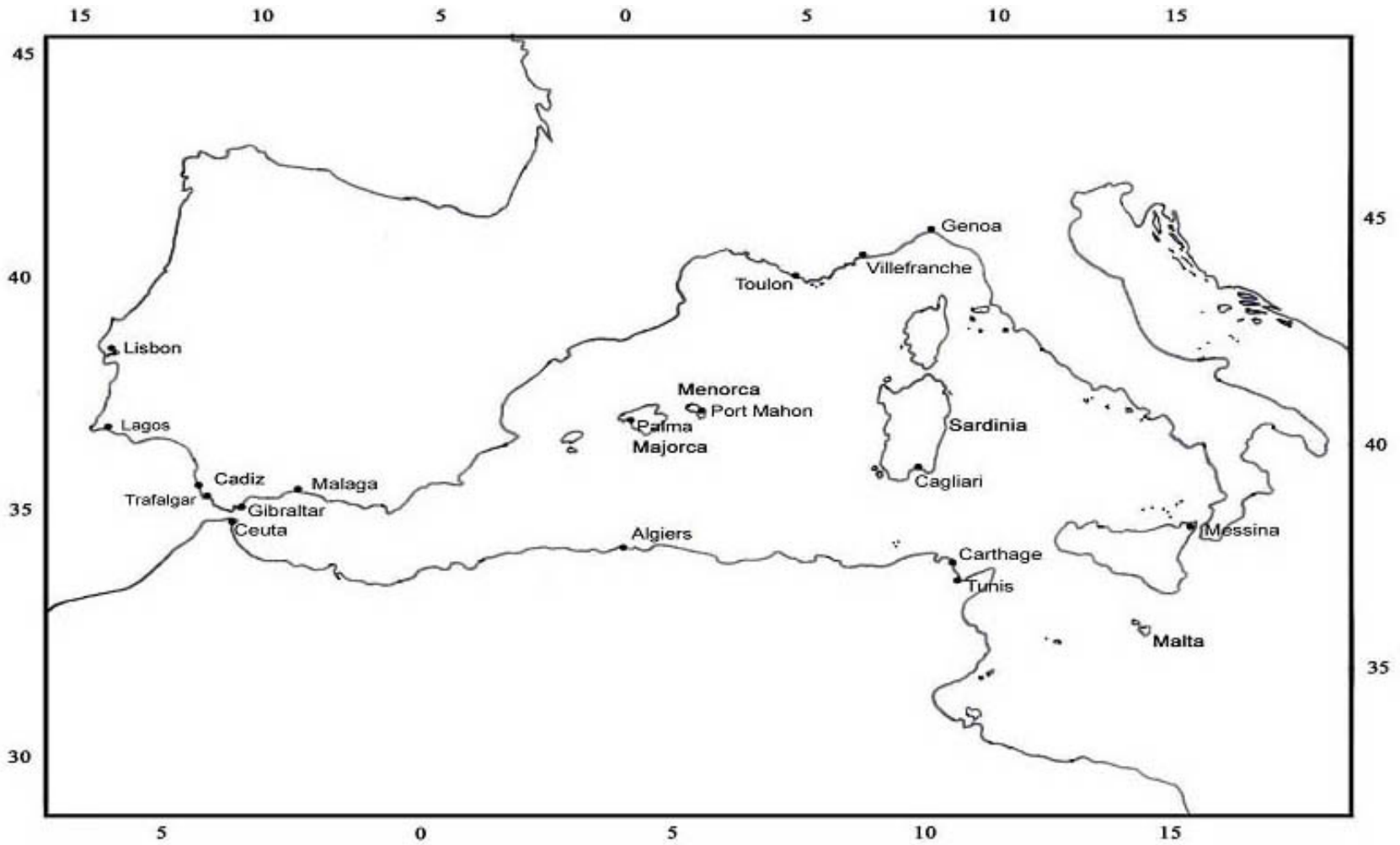

Map 3. Theatre of operations: July 1760 – Dec. 1763 and Dec. 1771 – Mar. 1773. (after National Geographic Atlas of the World, p.53)

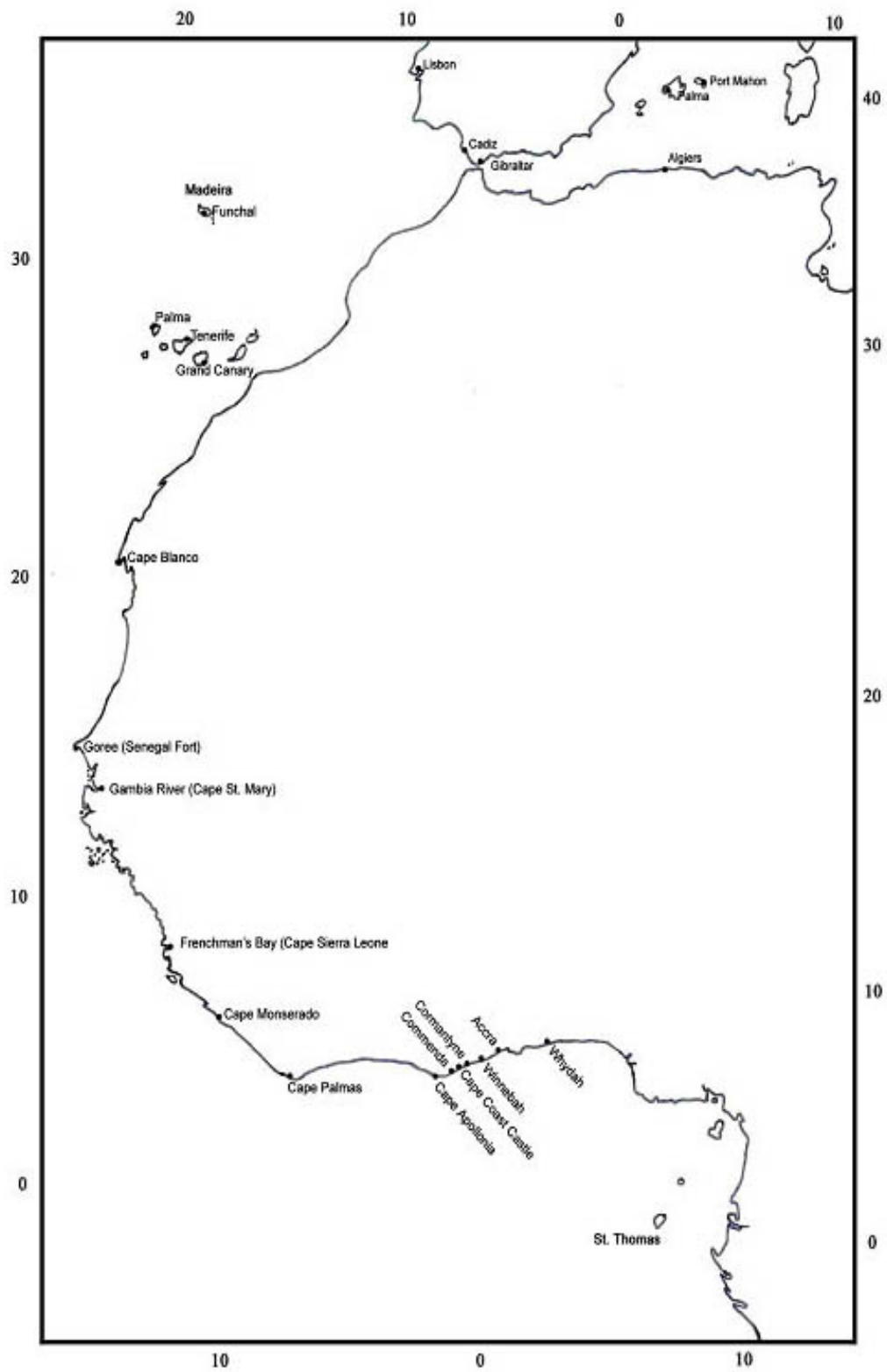

Map 4. Theatre of operations: Jan. – Apr. 1775, Dec. 1775 – May 1776 and Mar. – June 1777.  
(after National Geographic Atlas of the World, p.91)

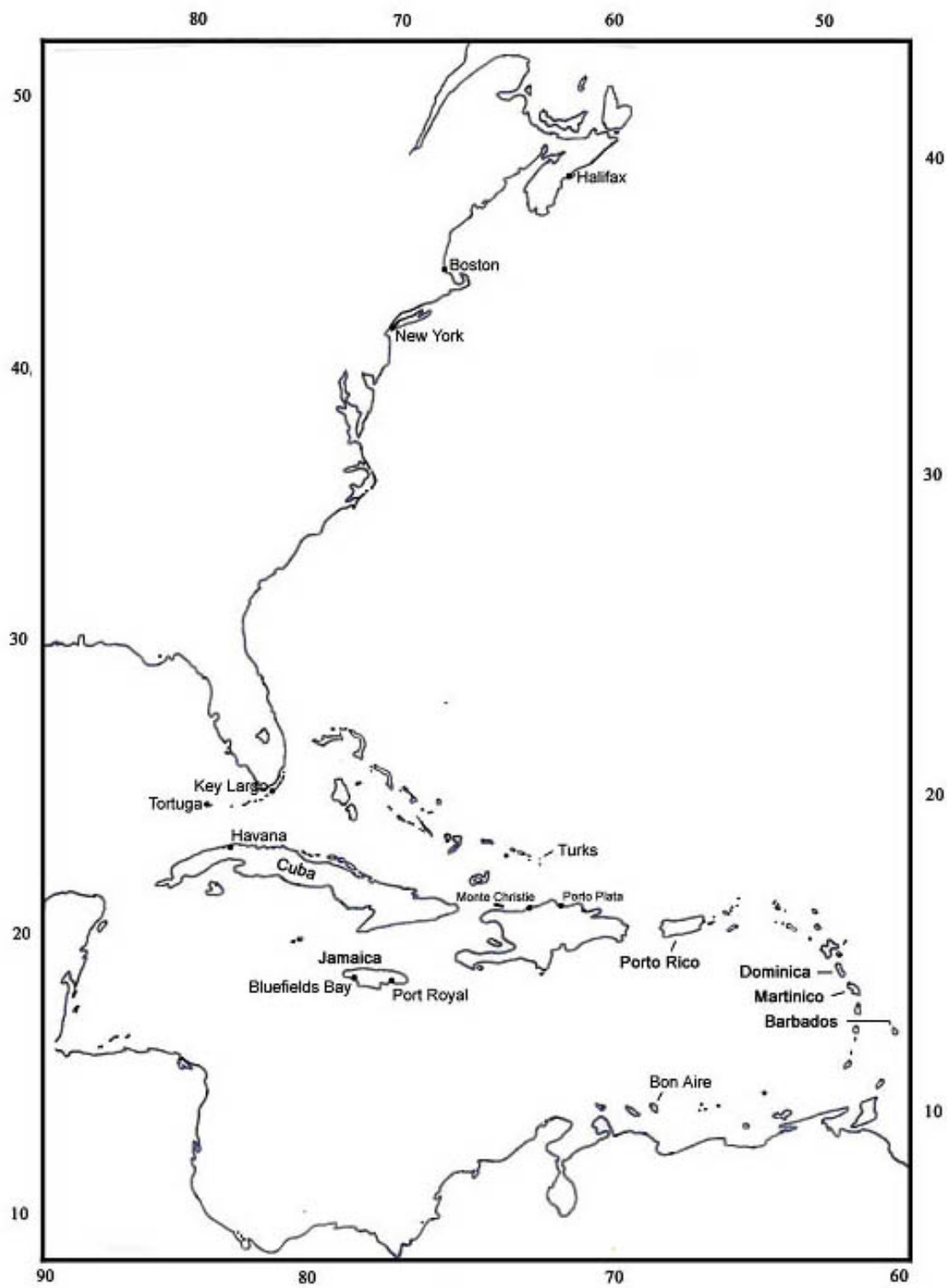

Map 5. Theatre of operations: May – July 1775, June – Oct. 1776, July – Dec. 1777 and Aug. – Jan. 1783. (after National Geographic Atlas of the World, p.17)

## APPENDIX C

HMS *PALLAS* TIMELINE

Year	Month & Day	Coordinates	Activity
<b>1757</b>	08/31		moved hull of HMS <i>Pallas</i> from Wells shipbuilding firm at Deptford into Thames River <sup>1,2</sup>
	09/03		lashed alongside HMS <i>Gibraltar</i> @ Deptford; Captain Archibald Cleveland took possession at Deptford
	09/05		took on 35 tons of iron ballast and 35 tons of shingle ballast; trimmed
	09/06		began rigging ship and clearing holds
	09/07		another 24 tons of shingle ballast
	09/08		took on water, officers' stores
	09/09-10		loaded provisions of all species including fresh beef
	09/11-17		continued running rigging, provisioning
	09/18		received 47 pressed men; read Articles of War to ship's company
	09/19-10/07		rigging and final fitting out <sup>3</sup>
	10/08		sailed with HMS <i>Shannon</i> to Long Reaches
	10/09-11		took on guns, gunner's stores
	10/12		took on powder
	10/13		sailed with <i>Shannon</i> to Gravesend; sealed the guns
	10/14		sailed to Nore; saluted Commodore Grey with 13 guns
	10/15		men paid; new men received bounties and advances
	10/17		exercised great guns and small arms
	10/19		read Articles of War
	10/22		fired 17-gun salute for King's coronation
	10/29		sailed with <i>Shannon</i> and HMS <i>Hussar</i>
	10/30		lost sight of <i>Shannon</i> ; brought to several Dutch vessels
	10/31		rejoined <i>Shannon</i>
	11/02		with <i>Shannon</i> joined company with HMS <i>Medway</i> , HMS <i>Dolphin</i> , and HMS <i>Unicorn</i>
	11/03		spotted sail near Le Havre; <i>Pallas</i> gave chase through the night
	11/04	49°28 x 00°08	proved to be a French privateer; put a prize crew aboard to bring her in; lost sight of the fleet
	11/08	46°38 x 4°44	rejoined <i>Medway</i> , <i>Unicorn</i> and <i>Dolphin</i>
	11/10	46°38 x 5°12	joined Edward Hawke in HMS <i>Ramillies</i> , and Vice Admiral Boscawen on HMS <i>Royal George</i> with 18 sail under their command
	11/11-28	47°04 x 3°58 48°36 x 3°20 46°50 x 4°30 48°57 x 5°58	patrolled with fleet  generally poor weather; no notable encounters
	11/29		joined by HMS <i>Southampton</i>

Year	Month & Day	Coordinates	Activity
1757 continued	12/08	48°12 x 5°05	<i>Medway</i> and <i>Southampton</i> part company taking nine of the sail with them
	12/11		read Articles of War to ship's company
	12/14	49°45 x 1°38	fired on an unknown vessel believed to be French; proved to be an English privateer
	12/15		remainder of fleet begin working into Spithead to ride out weather
	12/16		anchored at Spithead
	12/21		pilot came aboard to bring her into Portsmouth
	12/22-27		overhauling blocks and rigging, replaced main and mizzen shrouds, installed new bowsprit gammoning; removed iron ballast to adjust trim, and re-caulked hull
	12/28-30		reloaded ballast and loaded provisions
	12/31		re-provisioning completed
<b>1758</b>	01/01		completed rigging; masts scraped and payed with varnish of pine
	01/02		guns on board
	01/03		gunner's stores and powder
	01/05		quartering the ship's company
	01/10		exercised great guns and small arms; fresh beef
	01/12		pilot aboard to move <i>Pallas</i> out of harbor; Bembridge Point sailed
	01/15		sailed
	01/17	49°26 x 1°17w	joined company with HMS <i>Eagle</i> .
	01/21	46°23 x 11°40	joined company with HMS <i>Torbay</i>
	01/22	45°53 x 12°13	chased and brought to Danish ship bound from Cadiz to Copenhagen and an English ship bound from Newcastle to New York
	01/24-25	44°35 x 10°59	chased and fired on ship which hoisted English colors; snow bound from Falmouth to New York with mail
	01/26	44°11 x 9°07	four more sail sighted; proved to be English
	01/29	45°32 x 8°58	chased sail; proved to be the British <i>Willshire</i> privateer out of Bristol
	01/30	45°58 x 8°43	gave chase; proved to be a Portuguese brig from Lisbon; read Articles of War to ship's company
	01/31	47°05 x 7°43	gave chase; Spanish snow from Seville bound for Dublin
	02/01	47°29 x 7°48	pursued by three sail—fired at foremost; proved to be privateer <i>Willshire</i> , HMS <i>Achilles</i> and the third <i>Veteran</i> privateer of London
	02/02		exercised great guns and small arms
	02/03	47°11 x 8°07	<i>Veteran</i> privateer in sight
	02/04	47°37 x 7°44	<i>Veteran</i> privateer in sight
	02/05	47°25 x 6°23	<i>Veteran</i> privateer in sight
	02/06	47°22 x 5°50	saw two sails; one proved be <i>Veteran</i> privateer, the other a Dutch bound from Lisbon to Rotterdam
	02/07	48°45 x 4°42	rejoined <i>Eagle</i>
	02/10	49°16 x 2°10	saw two sail – gave chase; HMS <i>Lizard</i> and <i>Speedwell</i> sloop
	02/11	49°30 x 1°42	saw sail, gave chase
	02/12	49°42 x 1°21	turned out to be <i>Eagle</i> .

Year	Month & Day	Coordinates	Activity
1758 continued	02/14		anchored Plymouth Sound
	02/15-19		general maintenance, tarring shrouds, scraping and paying lower masts
	02/20		removed guns and powder; found foremast sprung under the upper wedges and employed unrigging the foremast
	02/21		removed foremast
	02/22		officers' stores brought onboard
	02/23		hauled into dock; caulkers employed in breaming ship's bottom; stores brought onboard
	02/24		26 tons of shingle ballast brought on board
	02/25		water brought on board
	02/25-26		foremast re-installed and rigged
	02/26		read Articles of War and punished several crew members (crimes unknown)
	02/27-28		guns, powder and gunners stores loaded; payed ship sides
	03/01		sealed guns; read Articles of War
	03/02		moved out of harbor and anchored with several other of HM ships
	03/03		came to sail in company with the HMS <i>America</i> ; John Head fell from mizzen yard and died of injuries
	03/04	49°52 x 2°23	
	03/05	49°03 x 3°04	fore topmast stay broke
	03/09	50°30 x 4°56	chased Portuguese brig and snow; saw 8 sail; proved to be the <i>York</i> with a convoy bound for America
	03/11	49°59 x 5°45	encountered HMS <i>Antelope</i> with a convoy for the West Indies
	03/17		re-entered Plymouth sound
	03/18		employed in fixing the lower rigging, unreaving the bad running rigging, and reaving new
	03/20		unrigged the fore and main topmasts
	03/21		employed re-rigging fore and main topmasts
	03/22		made sail
	03/23		brought to and spoke with several Dutch vessels; saw 13 sail to southwest and gave chase; turned out to be HMS <i>Greyhound</i> with convoy from Lisbon
	03/27		got on board a new driver boom
	03/31	49°36 x 6°21	Land's End; saw and chased French frigate in little or no wind; Frenchman used oars to evade
	04/01	49°16 x 2°31	chased ship—turned out to be <i>Southampton</i>
	04/09	48-50° x 2-6°	patrolled
	04/15	49°17 x 3°46	brought to a Portuguese ship bound for Lisbon from England
	04/16	49°14 x 1°50	spoke with <i>Defiance</i> privateer of Bristol
	04/17	49°41 x 0°10	liberated a British ship taken by a French privateer
	04/18		returned to anchor at Portsmouth
	04/24		taken by pilot into harbor; yards and topmasts were struck
	04/25		unrigging and overhauling blocks
	04/26		main and mizzen mast found to be sprung

Year	Month & Day	Coordinates	Activity
1758 continued	04/27		transported alongside the sheer hulk and masts were removed
	05/03		officers' stores aboard
	05/04		provisions aboard
	05/08		new main and mizzen installed at sheer hulk
	05/10		rigging and provisioning
	05/11		guns and powder
	05/12		ready for sailing—found foremast sprung under woolding
	05/13		scraped and payed sides with varnish
	05/14-06/01		Spithead general maintenance
	June to October gap: Cherbourg raid September 1758 <sup>4</sup>		
	10/06		guns out
	10/07		clearing and washing hold; major overhaul and replacement of rigging?
	10/16		carpenters and caulkers hard at work; 30 tons of shingle ballast
	10/17-18		sheer hulk for painters, removal of lower masts, a new best bower cable
	10/19-21		new lower mast and rigging
	10/22		yards installed
	10/23		painters, caulkers, and rigging
	10/24		topmasts and top gallants
	10/25		hauled into dock for blacking; stores on board
	10/26		caulking and breaming
	10/27		out of dock
	10/28		topsail yards, beer and water
	10/29-30		guns and gunners' stores
	10/30		boatswain's and carpenter's stores
	10/31		powder
	11/01		ship's company received prize money
	11/06		pilot came aboard to convey the ship out of Portsmouth harbor
	11/07-11		at anchor in Spithead
	11/12		set sail in company with HMS <i>Saltash</i>
	11/15	47°00 x 5°40	saw two sail and gave chase; found to be Dutch bound from Lisbon to Holland
	11/17	45°07 x 6°21	saw fleet; joined <i>Torbay</i> with 16 sails
	11/20	39°17 x 6°21	parted company <sup>5</sup>
	11/22	40°30 x 5°53	saw sail – gave chase – lost contact [incorrect longitude]
	11/23		read Articles of War to company
	11/25	45°00 x 4°12	spoke with Dane bound from Lisbon to Hamburg
	11/28	47°10 x 1°25	brought to several Dutch ships—
	12/01-05	47°18 x 0°13-1°55	came into company with HMS <i>Actæon</i> , HMS <i>Deptford</i> and one other (HMS <i>Rocheater</i> ?)
	12/05	47°18 x 1°55	<i>Actæon</i> parted company
	12/16	47°48 x 2°50	saw sail – gave chase; turned out to be English <i>Bristol</i> privateer

Year	Month & Day	Coordinates	Activity
1758 continued	12/17	47°51 x 1°57	saw sail – gave chase; turned out to be Danish dogger from Petersburg for Lisbon
	12/19	48°40 x 4°30	lost contact with <i>Deptford</i> and <i>Rochester</i> ; carpenters employed repairing bumpkin
	12/20	48°31 x 4°45	saw sails – gave chase; turned out to be <i>Rochester</i> and unknown privateer
	12/21	48°08 x 4°59	spoke with HMS <i>Essex</i> and HMS <i>Windsor</i>
	12/22	47°37 x 5°38	remained in company with <i>Essex</i> , <i>Windsor</i> and <i>Rochester</i>
	12/23	46°40 x 5°56	chased sail; Dane from Norway for Lisbon
	12/24-25	45°48 x 6°42 to 44°52 x 6°56	chased and brought to a Dutch East Indiaman
	12/28	45°00 x 6°06	chased and brought to ship; turned out to be British privateer; lost contact with <i>Essex</i> , <i>Windsor</i> and <i>Rochester</i>
	12/30-31	45°20 x 2°28 to 45°30 x 3°41	chased and brought to Danish ketch
<b>1759</b>	01/01-09		in Spithead; general maintenance
	01/10		fresh beef taken aboard
	01/10-16		continue general maintenance
	01/17		pilot moved <i>Pallas</i> into Portsmouth harbor
	01/18-19		cleared holds – guns removed
	01/20		blacking the yards
	01/22-23		caulking and paying masts
	01/24		carpenter's and boatswain's stores taken aboard
	01/25-27		rigging, maintenance, and fitting for sea
	01/28		guns loaded
	01/29		scraped and payed lower masts; finished provisioning for 3 months
	01/30		powder loaded
	02/01		exit harbor anchor at Spithead; joined with large fleet there under Admiral Holmes; mostly transports and Indiamen
	02/02		scraping and paying sides
	02/03-05		general maintenance
	02/08		exercised great guns
	02/09		took on beer
	02/10		read Articles of War and punished sailor for neglect of duty
	02/11-13		general maintenance
	02/14		set sail in company with HMS <i>Chichester</i> , HMS <i>Chatham</i> , HMS <i>Faulkland</i> , and HMS <i>Boreas</i> with East India convoy
	02/16		<i>Chatham</i> and <i>Boreas</i> chased Spaniard Bilboa for Amsterdam and spoke with same
	02/18	49°30 x 00°20	saw sail, <i>Boreas</i> chased; turned out to be <i>Lizard</i> in company of 21 sail convoy
	02/20	46°36 x 06°10	chased and brought to <i>Hassa</i> privateer of London
	02/21	45°40 x 7°35	parted company with ship bound for Guinea
	02/22	45°11 x 9°17	<i>Pallas</i> and <i>Chatham</i> chased and brought to a Spaniard from 'Carachis' to St. Sebastian's
	02/24	45°18 x 11°53	<i>Faulkland</i> took command of convoy and parted company; <i>Chichester</i> and <i>Chatham</i>



Year	Month & Day	Coordinates	Activity
1759 continued	02/27	47°09 x 09°44	spoke with two vessels that had been attacked by French privateers at 49°20 and proceeded there with <i>Boreas</i>
	03/01-04	49°31 x 09°09	Patrolled; no finds chased sail turned out to be Dane from St. Cruz bound for Copenhagen
	03/12		met up with <i>Chichester</i> and <i>Chatham</i> ; main mast found to be sprung
	03/13		carpenter from <i>Boreas</i> came aboard to assist woolding the mast
	03/14		parted company with <i>Boreas</i>
	03/16		reached Spithead and anchored
	03/17		taken into Portsmouth harbor by pilot
	03/18		unrigging ship
	03/19-20		removed guns and powder, clearing hold, water casks put ashore; carpenters and caulkers aboard
	03/21-25		new mainmast installed; overhauled rigging
	03/26		officers' stores aboard
	03/27-30		provisioning
	03/31		guns aboard
	04/01		powder aboard; moved to anchor at Spithead
	04/03		fresh beef <sup>6</sup>
	04/04		set sail with <i>Essex</i> , <i>Jamaica</i> sloop; anchored at Needle Point
	04/05		joined by <i>Chatham</i>
	04/07	47°49 x 1°03	saw sail – gave chase – fired guns
	04/08	47°02 x 0°48	proved to be HMS <i>Juno</i>
	04/09	45°46 x 1°34	chased sail – Dutch dogger from Calais for Rochfort
	04/10		sighted 20 sail – Dutch convoy
	04/13	46°10 x 1°34	chased sail – Spaniard from Bristol for Bordeaux
	04/15	45°33 x 0°22	chased sail; turned out to be Jamaican ship taken by French; liberated; prize
	04/17	45°34 x 5°24	parted company with <i>Jamaica</i> sloop
	04/22	45°54 x 7°14	chased sail – packet from Falmouth
	04/26		<i>Essex</i> and <i>Chatham</i> bore aft to Plymouth with prize; <i>Pallas</i> made for Portsmouth
	04/29 to 05/21		Spithead and Portsmouth general maintenance; assembled fleet including HMS <i>Nottingham</i> , HMS <i>Hercules</i> , <i>Chatham</i> , HMS <i>Venus</i> , <i>Essex</i> and HMS <i>Minerva</i>
	In early June of 1759, Captain Archibald Cleveland departed and Captain Michael Clements took command of HMS <i>Pallas</i> . <sup>7</sup> Clements would remain captain until <i>Pallas</i> was paid off in January 1764. <sup>8</sup>		
	06/18		sailed from Spithead
	06/23 to 07/04		patrolled channel coast of France near Brest in company of <i>Rochester</i> and a cutter
	07/05		fired on French ships in Brest harbor and shore batteries at St. Matthews Convent
	07/06-16		harried French at St. Matthews and in Brest harbor
	07/18		Plymouth Sound; heeled and scrubbed
	07/19-21		provisioned
	07/22-27		general maintenance

Year	Month & Day	Coordinates	Activity
1759 continued	07/28		sailed in company with HMS <i>Hero</i> , <i>Southampton</i> , <i>Venus</i> , <i>HMS Sapphire</i> ; blockaded French ports of Brest and Le Havre
	Logbook gap from July 28 to October 3, 1759		
	10/03		Plymouth Sound
	10/04		provisioning
	10/05		moved to sheer hulk to remove sprung bowsprit; caulkers came aboard to caulk ship
	10/06		clearing hold; overhauling rigging
	10/07		new bowsprit installed; new gammoning; provisioning for 3 months
	10/08-11		ballast, water and beer
	10/13		company received 6 months pay
	10/14		moved out into Plymouth sound
	10/15-18		scraping, paying and general maintenance
	10/19		set sail
	10/20	47°16 x 00°38	saw two Dutch vessels; spoke with one
	10/21-28		patrol French channel coast; Quiberon Bay, Belle Isle, Isle of Groa; 27 <sup>th</sup> came to sail with <i>Chatham</i>
	10/29		met with <i>Sapphire</i> and HMS <i>Vengeance</i> and parted company
	10/30		continued patrol; met <i>Venus</i> , <i>Swallow</i> sloop and a convoy of victuallers
	10/31		joined HMS <i>Firm</i>
	11/02		joined company with HMS <i>Maidstone</i>
	11/03		joined <i>Chatham</i> and <i>Vengeance</i> ; parted company with all
	11/04-13		Quiberon Bay—came to anchor; found here squadron and several victuallers; gun maintenance
	11/14		sailed in company with <i>Firm</i> , <i>Southampton</i> and <i>Vengeance</i>
	Logbook gap 11/15 to end of 1759		
<b>1760</b>	01/05		returned to Plymouth Sound
	01/07		pilot came to bring <i>Pallas</i> into harbor
	01/08		replaced sprung main [top]mast; unloaded powder
	01/09		unloaded and overhauled rigging
	01/10-19		provisioning
	01/20		took on guns
	01/21		took on powder
	01/22		scraped sides and lower masts and payed; tallowed topmasts
	01/23		pilot aboard to take <i>Pallas</i> back into sound
	01/24-29		general maintenance
	01/30		sailed with HMS <i>Brilliant</i>
	02/01	49°16 x 7°15	with <i>Brilliant</i>
	02/07	47°51 x 15°26	with <i>Brilliant</i>
	02/14	50°48 x 16°59	with <i>Brilliant</i>
	02/16	50°55 x 15°6	with <i>Brilliant</i>
	02/18		Kinsale Harbor
	02/19-24		general maintenance
	02/25		sailed with <i>Brilliant</i> and HMS <i>Æolus</i>

Year	Month & Day	Coordinates	Activity
1760 continued	02/28		encountered 3 strange ships and gave chase; proved to be French frigates <i>Marshal Bell Isle</i> 44, <i>Lablond</i> 36 and <i>Terpsichor</i> 24 <sup>9</sup> <i>Pallas</i> —sails and rigging damaged, shot through mainmast, best bower shot away
	02/29		three ships were taken to Ramsay Bay
	03/1-5		prisoners were put ashore and temporary repairs were made
	03/6-25		<i>Pallas</i> , <i>Brilliant</i> , <i>Æolus</i> , <i>Weasel</i> sloop and the three prizes sailed for Plymouth, stopping at Kinsale Harbor on the way
	03/27		<i>Pallas</i> brought into Plymouth Harbor
	03/28		guns and powder off loaded
	03/30		bower cables replaced; rigging overhauled
	04/06		mainmast replaced and re-rigged
	04/08		company paid 6 months wages
	04/09		returned to patrolling the French channel coast near St. Matthews Convent, Brest
	04/16		saw ship and gave chase; turned out to be French; exchanged fire; French ship ran aground so violently that her masts fell; <i>Pallas</i> wore and raked her to finish the job
	04/17 to 05/23		in company of HMS <i>Shrewsbury</i>
	05/24		returned to Plymouth Sound
	05/25		clearing hold
	05/28 to 06/17		major overhaul; new masts and bowsprit, re-rigged, scraping and paying decks and sides and lower masts; provisioning
	06/18		depart Plymouth
	06/21	47°20 x 6°04	
	06/22	45°49 x 6°56	
	06/23	45°49 x 7°25	foremast sprung
	06/24	45°44 x 6°53	
	06/25	44°16 x 8°11	
	06/26	44°30 x 7°58	
	06/27	45°08 x 8°42	
	06/28	44°06 x 8°47	
	06/29	44°40 x 9°41	
	06/30	44°30 x 10°21	
	07/01	42°47 x 10°6	
	07/03	37°59 x 9°59	rock of Lisbon
	07/04	36°24 x 8°27	Cadiz
	07/06		Gibraltar
	07/07-11		repaired foremast and took on provisions
	07/12-17		Europa Point patrol
	07/19-20		near Gibraltar
	0724	37°26 x 00°14	
	07/25	37°35 x 00°14	
	07/29		Majorca
	08/07	38°50 x 10°15e	
	08/10	36°50 x 13°45e	
	08/11		Malta
	Logbook gap August to October <sup>10</sup>		

Year	Month & Day	Coordinates	Activity
1760 continued	October		patrolled western Mediterranean around Malta and Cape Angelo with <i>Dunkirk</i> , <i>Shannon</i> , <i>Shrewsbury</i> , and HMS <i>Somerset</i>
	10/19-23		Messina Road; provisioning and general maintenance
	10/29	36°22 x 15°23	
	11/07		Malta
	11/12	36°43 x 13°27	
	11/16-17		Cape Carthage
	12/02	38°59 x 7°50	
	12/03-09		patrolled between Sardinia and Majorca
	12/13		at anchor in Tunis; provisions and general maintenance
	12/18		exchanged broadsides with three French vessels
	12/20-23		patrolled off Tunis
	12/28		took a French prize off Cape Negro
<b>1761</b>	01/02	35°36 x 11°08	
	01/04		moored in Malta; provisions and general maintenance
	01/24	37°58 x 10°25	
	01/28	42°03 x 6°32	
	01/29	42°23 x 5°37	
	01/30	41°42 x 5°00	
	01/31	41°59 x 4°58	
	02/04		moored in Leghorn [Legorno] Road
	02/11-13		anchored in Tunis; provisions and general maintenance
	02/19-22		anchored in Leghorn Road; provisions and out general maintenance
	03/20		anchor in Cagliari Bay; overhauling rigging and scrubbing bottom
	04/5-16		patrolled southeast approaches to Malta
	04/22-29		moored in Milo Harbor; provisions and general maintenance
	Logbook gap April 30 to June 6, 1761		
	06/06-19		moored in Malta; provisions, overhauling rigging; general maintenance
	Logbook gap June 19 to July 24, 1761		
	07/24 to 09/01		moored in Leghorn; complete refit, caulking, careening and breeming; new masts; painting, painting gun carriages, new rigging; scraping and paying decks, masts and sides; provisioning
	09 - 11/04		patrolled between Sardinia and Majorca
	11/04-17		moored in Messina; rigging adjustments; provisions and general maintenance
	12/30 to 01/04		moored in Tunis Bay; provisions and general maintenance
<b>1762</b>	01/10-12		moored in Malta; provisions and general maintenance
	01/19-26		Patrol
	02/09-15		at anchor in Cagliari Bay; provisions and general maintenance
	03/16-04/30		in Gibraltar; overhaul; picking oakum before sheathing

Year	Month & Day	Coordinates	Activity
1762 continued	05/08	41°44 x 5°50e	
	05/11		moored in Villefranche Bay; provisions and general maintenance <sup>11</sup>
	06/06-15		mainly at anchor in Gibraltar
	06/15-08/12		patrol between Cadiz and Trafalgar
	08/13-22		moored in Gibraltar harbor; provisioning, rigging and general maintenance
	08/23	35°39 x 1°49w 33°31 x 2°09 36°12 x 6°00 36°33 x 7°27	patrol
	09/23	38°33 x 7°07	
	10/05	42°24 x 8°55	
	09/24-10/04	39°40 x 6°00 40°35 x 7°05	
	10/16-11/20		moored in Gibraltar Bay
	11/22-12/14	34-36° x 0-3°	On patrol
	12/16-21		at anchor in Lagos Bay; provisions and general maintenance
	12/22-01/05	mostly 36°x 0-1°	patrol
<b>1763</b>	01/06-02/16		moored in Gibraltar
	02/17		sailed from Gibraltar with HMS <i>Dunkirk</i> , <i>Chichester</i> and some merchant vessels bound for England
	02/26-03/14		moored in Lisbon Harbor
	03/14-17		returned to Gibraltar
	03/18-04/08		moored in Gibraltar
	04/09-28		moored in Cadiz
	04/29-05/01		moored in Gibraltar
	05/02-06		short cruise to Cagliari
	05/07-09		Cagliari Bay
	05/10-13		Cagliari to Genoa
	05/14-22		moored in Genoa
	05/23-25		Genoa to Leghorn Road
	05/26-06/11		moored at Leghorn Road
	07/01-05		patrolled around Gibraltar
	07/06		moored at Gibraltar; carried out general maintenance
	08/10		sailed from Gibraltar to Cadiz
	08/11-28		moored in Cadiz harbor
	08/29-30		sailed from Cadiz to Gibraltar
	09/01-11/02		moored in Gibraltar; provisions and general maintenance
	11/03-05		moved to Cadiz
	11/06-21		moored in Cadiz
	11/22-12/02		Moved to Lisbon
	12/03-08		Moored in Lisbon; general maintenance
	12/09		sailed from Lisbon

Year	Month & Day	Coordinates	Activity
1763 continued	12/21		moored at Spithead
	12/22-01/13		ship stripped
<b>1764</b>	01/14		crew paid off <sup>12</sup>
<b>1770</b>	10/26-11/11		alongside Jetty Head working up for sea, taking on a new crew, provisions, ballast, rigging; new Captain named LaForey <sup>13</sup>
	11/12-26		moored in Portsmouth harbor; tops, yards and shrouds; cleaning and trimming; blacking yards; carpenter, boatswain and gunner stores; ballast and trim
	11/26-12/19		read Articles of War to the ship's company; ballast; heavy cables and anchors; Clerk of the Cheque came aboard to muster crew; provisions
<b>1771</b>	12/20-03/27		moored at Spithead
	03/28-04/11		final working up, guns brought aboard <sup>14</sup>
	04/12-05/02		anchored at Spithead, Captain Watson assumes command <sup>15</sup>
	05/05		sailed for the Mediterranean
	05/08	48°38 x 1°25w	
	05/09	48°22 x 2°13w	
	05/10	45°42 x 4°21w	
	05/11	43°47 x 5°14w	
	05/12	42°10 x 0°43w	[incorrect coordinates] <sup>16</sup>
	05/13	40°58 x 0°55w	<i>Minerva</i> and HMS <i>Pearl</i> in company
	05/14	41°19 x 2°12w	
	05/15	40°55 x 2°19	
	05/16	40°39 x 0°12	
	05/17	40°20 x 0°20	
	05/18	37°54	
	05/19	36°33 x 1°41	
	05/20-27		Gibraltar at anchor
	05/28		sailed on patrol with <i>Minerva</i>
	05/29	36°40 x 0°51e	
	05/30	37°8 x 0°44e	
	05/31	36°50 x 2°22e	
	06/01	37°08 x 0°34	
	06/02	38°24 x 0°34	
	06/04	39°10	
	06/05	39°47 x 00°51	
	06/10		sailed still in company with <i>Minerva</i>
	06/13	38°30 x 0°57e	
	06/14	39°09 x 2°17	
	06/15	38°23 x 2°37	
	06/18-22		moored in Malta harbor
	06/23	36°9 x 2°39	sailed with <i>Minerva</i>
	06/24	36°28 x 5°59	
	06/26-07/01		moored in Milo harbor

Year	Month & Day	Coordinates	Activity
1771 continued	07/07-11/29		moored in Smyrna harbor; general maintenance
	11/30		sailed
	12/02	36°20	Moses Ward, sailmaker, runs gauntlet for sin of attempted sodomy
	12/03	35°43	
	12/04	35°15 x 0°55w[?]	
	12/05	36°0	
	12/06	36°24 x 2°22w[?]	
	12/07	36°16 x 5°42w[?]	
	12/08	36°28 x 6°45w[?]	
	12/09-18		moored in Malta harbor
	12/19	36°39 x 0°38e	
	12/20	36°36 x 1°17e	
	12/21	36°27 x 0°27e	
	12/22	36°46	
	12/23	36°44	
	12/24	36°35	
	12/25	36°53	
	12/26	37°23	
	12/27	38°28 x 0°45w[?]	
	12/28	37°49 x 2°21w[?]	
	12/29	37°53 x 3°22w[?]	
	12/30	37°30	
	12/31	37°01	
<b>1772</b>	01/01-08		moored in Bona Bay
	01/09	37°07	sailed
	01/10	37°42	
	01/13	39°53	
	01/14-15		at anchor off Cape Mola
	01/16	39°18 x 0°30e	
	01/17	39°21 x 0°48e	
	01/18	39°18	
	01/19	39°21	
	01/20-28		moored in Mahon harbor overhauling rigging
	01/29	38°48 x 0°37e	
	01/30	38°43 x 2°29e	
	01/31	38°24 x 0°30e	
	02/01	38°14 x 0°23e	
	02/02	37°51 x 0°04e	
	02/04	36°57	
	02/05	36°54	
	02/06	37°06	
	02/07	36°26	
	02/08		Europa Point
	02/09		anchored in squall; obliged to cut away small bower
	02/10-04/04		moored in Gibraltar harbor; general maintenance; scraping, paying, painting, etc. <sup>17</sup>

Year	Month & Day	Coordinates	Activity
1772 continued	04/06		shock thought to be rock turned out to be an earthquake
	04/07	37°07 x 6°14w	
	04/12-29		moored in Tagus River (Lisbon)
	04/30-31		Gibraltar
	05/01-06		moored in Gibraltar
	05/08	36°47 x 00°55e	
	05/25-06/24		moored in Mahon Harbor
	06/25-07/01	37°06-37°10 x 1°58-0°45e	short patrol
	07/02-07/21		Mahon Harbor
	07/22-28		short patrol
	07/29-09/03		Mahon Harbor
	09/04-16		patrol around Cape Mola, cape Paul, Cape Palus, Malaga, Gibraltar, Ceuta Point
	09/17		moored in Gibraltar
Logbook gap September 18, 1772 through December 8, 1772			
<b>1773</b>	12/09/1772 to 03/16/1773		alongside the wharf at Gibraltar <sup>18</sup>
	03/16-25		moved into Gibraltar Bay
	03/26	36°26 x 2°54w	sailed from Gibraltar on patrol
	03/27	36°26 x 3°30w	
	03/28	36°26 x 4°29w	
	03/29	36°51 x 5°44	
	03/30	36°49 x 5°46w	
	03/31	38°52 x 6°01w	
	04/01-11	39°57 x 7°02w 39°57 x 7°02w 40°43 x 7°1 41°30 x 5°45w 43°49 x 4°46w 45°31 x 3°01w 47°12 x 1°23 49°24 x 0°14e 49°39 x 1°14 50°29	return trip to England; recorded following daily coordinates
<b>1774</b>	04/12-23		moored in Spithead
	10/05-11/12		moored in Portsmouth harbor working up; new captain, Honorable William Cornwallis took command effective September 1774 <sup>19</sup>
	11/13- 12/11		anchored at Spithead
	12/12		sailed in company with <i>Weasel</i> sloop
	12/20	48°42 x 2°53w	
	12/21	46°10 x 4°52w	



Year	Month & Day	Coordinates	Activity
1774 continued	12/22	43°11 x 7°06w	
	12/23	40°57 x 8°36w	
	12/24	39°14 x 9°36w	
	12/25	37°40 x 10°45w	
	12/26	35°16 x 11°15w	
	12/27	33°11 x 11°43w	
	12/28	32°35	
	12/29	30°55 x 00°24e	
	12/30	29°54 x 00°16w	
	12/31	29°16 x 00°49w	
<b>1775</b>	01/01		island of Palma
	01/02	28°57 x 0°27w	
	01/03	28°38	
	01/04	29°19	
	01/05	28°53	
	01/06-17		in Santa Cruz Bay, Tenerife; provisions and general maintenance
	01/18	28°06	sailed in company with <i>Weasel</i> sloop
	01/19	27°07	
	01/20	25°56 x 0°18e	
	01/21	24°18 x 0°01e	
	01/22	21°38 x 0°41w	
	01/23	18°49 x 0°27w	
	01/24	16°47	
	01/25	15°58	running down Senegal Bar; spoke to sloop from Dominica
	01/26		anchored off Senegal Bar
	01/27	16°00	in company with <i>Weasel</i> sloop
	01/28-29		anchored off Senegal Fort
	01/30		anchored off Senegal Bar
	01/31	15°29	sent 25 half barrels of powder ashore for use by [Senegal] fort at the request of the governor
	02/01	13°39n	
	02/02	13°29n	anchored in Gambia River; fired on and brought to French sloop
	02/03		fired on and brought to French sloop and cutter
	02/04-09		in Gambia River off James Island; delivered 15 half barrels of powder to Fort James
	02/10		ran down river
	02/11	12°17 x 0°55w	
	02/12	10°12 x 0°52w	
	02/13	9°3 x 0°27e	
	02/14	8°47 x 1°25e	
	02/15	8°44 x 2°10e	
	02/16	8°31	

Year	Month & Day	Coordinates	Activity
1775 continued	02/17-03/01		moored in Frenchman's Bay, Sierra Leone River; found several French ships and small vessels in Frenchman's Bay and an English ship and several small vessels in Whiteman's Bay; at anchor, general maintenance
	03/02		sailed
	03/03	8°32 x 0°42w	
	03/04	7°52 x 0°45w	
	03/05	7°16 x 0°18	
	03/06	6°57 x 0°11e	
	03/07	6°22	Cape Monserado
	03/08	5°41n	
	03/09	5°20n	
	03/10	5°12	
	03/11	4°53	
	03/12	4°25	
	03/13	4°34	
	03/15	5°05	mouth of 'Cochroe' River; spoke to two Dutch vessels
	03/16	5°09	
	03/17	4°57	Cape Apollonia; spoke with English sloop
	03/18		anchored off Dick's Cove
	03/19	4°59n	Commenda Fort; spoke to French sloop
	03/20-26		off Cape Coast Castle (Dutch fort)
	03/27		anchored off Annamaboe (Dutch fort)
	03/28	5°09n	
	03/29	5°18n	Winnebah Fort (Dutch); Dutch ship at anchor
	03/30	5°32n	English Fort at Accra (English, Danish and Dutch forts all in proximity)
	03/31	5°43n	
	04/01	6°13n	
	04/02	6°12	
	04/03		anchored off Whydah; English, French and Portuguese forts; numerous ships of all nationalities
	04/04		visited English fort
	04/05		sailed
	04/06	5°28 x 1°49w	
	04/07	5°12 x 0°37w	
	04/08	4°52 x 0°6w	
	04/09	4°27 x 0°6e	
	04/10	3°22 x 0°40e	
	04/11	2°41 x 0°56e	
	04/12	1°56 x 1°13e	
	04/13	1°01 x 0°27e	
	04/14	0°52 x 0°46w	
	04/15	0°46 x 1°58w	
	04/16	0°46 x 2°31w	
	04/17	0°23 x 2°30w	

Year	Month & Day	Coordinates	Activity
1775 continued	04/18	0°10s x 2°10w	
	04/19	0°47s x 1°26w	
	04/20	1°03s x 1°42w	
	04/21	1°11s x 2°22w	
	04/22	1°20s x 3°22w	
	04/23	1°28s x 4°43w	washed decks regularly with vinegar; exercised guns more often
	04/24	1°40s x 7°02	
	04/25	1°27s x 9°55	
	04/26	1°33s x 11°32w	
	04/27	1°30s x 13°12w	
	04/28	1°25 x 15°34	
	04/29	1°21 x 18°02	
	04/30	1°16 x 20°22	
	05/01	0°47s x 22°28	
	05/02	0°9s x 24°43	
	05/03	0°29n x 26°34	
	05/04	1°5n x 27°10	
	05/05	1°42n x 27°32	
	05/06	2°42n x 28°7	
	05/07	3°26n x 28°35w	
	05/08	4°6n x 28°45w	
	05/09	4°57n x 28°57w	
	05/10	5°26n x 28°52w	
	05/11	5°49n x 29°15w	
	05/12	6°07n x 29°47w	
	05/13	6°22 x 30°48w	
	05/14	6°33 x 31°19w	
	05/15	6°42 x 32°26w	
	05/16	7°04 x 33°40w	
	05/17	8°03 x 35°22w	
	05/18	9°11 x 37°27w	
	05/19	10°22 x 40°13w	
	05/20	11°34 x 43°15w	
	05/21	12°23 x 46°13w	
	05/22	12°46n x 49°4w	
	05/23	12°55 x 57°57w	
	05/24	13°04 x 54°45w	
	05/25	13°14 x 57°34w	
	05/26	13°09 x 60°03w	
	05/27	12°58 x 62°40w	
	05/28	13°23n x 64°20w	
	05/29	13°17 x 66°04	
	05/30	13°10n	Barbados

Year	Month & Day	Coordinates	Activity
1775 continued	05/31		anchored in Carlisle Bay, Barbados
	06/01	13°25	west end of Barbados
	06/02	13°47	
	06/03	14°57	
	06/09-07/12		moored in Port Royal, Jamaica; general overhaul and provisioning
	07/13		sailed; patrolled around Jamaica and Caribbean and returned to England
	08/28		arrived Spithead
	08/28-09/05		Spithead
	09/06-22		refit, rigging
	09/23-10/10		in dock <sup>20</sup>
	10/11-11/03		in Portsmouth harbor; new bowsprit, new gammoning, new rigging, shrouds, provisions
	11/04-16		moored in Spithead
	11/16		sailed; cruising
	11/23	49°10 x 1°47w	
	11/24	48°20 x 2°36w	
	11/25	46°40 x 3°36w	
	11/26	46°05 x 5°31w	
	11/27	44°30 x 5°08w	
	11/29	44°04 x 00°04w	
	11/30	44°41 x 1°01w	
	12/01	45°00 x 1°17w	
	12/02	44°58 x 1°22w	
	12/03	44°14 x 1°41w	
	12/04	43°15 x 2°03w	
	12/05	42°39 x 2°19w	
	12/06	40°49 x 3°00w	
	12/07	38°47 x 3°47w	
	12/08	37°12 x 4°24w	
	12/09	34°45 x 5°20w	
	12/10	32°40	
	12/11		Madeira
	12/12		Madeira
	12/13	31°59	
	12/14	32°43 x 1°15e	
	12/15	32°06 x 2°53e	
	12/16	31°38 x 3°35e	
	12/17	30°40 x 3°27e	
	12/18	29°25	
	12/19	29°10	
	12/20	28°53	
	12/21-29		in Santa Cruz Bay, Tenerife
	12/30	26°43	Grand Canary
	12/31	23°46 x 0°43w	

Year	Month & Day	Coordinates	Activity
<b>1776</b>	01/01	21°29n	running along Barbary coast
	01/02		anchored off Cape Blanco
	01/03	20°32 x 0°12w	
	01/04	18°29 x 0°40e	
	01/05	17°34	
	01/06	16°06	Senegal Fort
	01/07	14°55	
	01/08	14°19 x 0°20e	Goree; fired at and brought to French brig forcing it to show colors
	01/09	13°34	mouth of Gambia river
	01/10	13°35	anchored at mouth of Gambia river
	01/11-13	13°10 x 00°36w	Anchored at Cape St. Mary
	01/13	13°10 x 00°36w	Cape St. Mary
	01/14	11°40 x 00°47w	Cape St. Mary
	01/15	9°57 x 00°16w	Cape St. Mary
	01/16	9°8 x 1°22e	Cape St. Mary
	01/17	8°44 x 2°36e	Cape St. Mary
	01/18		Cape Sierra Leone
	01/19-02/04		anchored in Frenchman's Bay
	02/05-06		Cape Sierra Leone
	02/07-08		off Banana Islands
	02/09-13		anchored off Banana Islands
	02/14-16	7°59n	around Banana Islands
	02/17	8°08 x 00°34w	Cape Sierra Leone
	02/18	7°11 x 00°22w	Cape Sierra Leone
	02/19	7°09 x 00°31e	Cape Sierra Leone
	02/20	7°04 x 1°11e	Cape Sierra Leone
	02/21	6°58n	
	02/22	6°42n	Cape Marte
	02/23	6°23n	
	02/24	6°09n	
	02/25	5°54n	
	02/26	5°38n	
	02/27	5°18	
	02/28	4°43	
	02/29	4°18	Cape Palmas
	03/01	4°32n	
	03/02	5°03	
	03/03	5°08	
	03/04		
	03/05	4°57	Cape Apollonia
	03/06	4°47	Dick's Cove Castle
	03/07	4°58	English fort at Commenda
	03/08-17		anchored off Cape Coast Castle
	03/18-22	5°10	anchored off Cormantyne Fort (Dutch) <sup>21</sup>
	03/23		anchored off Assam (Alsam?)

Year	Month & Day	Coordinates	Activity
1776 continued	03/24	5°20	Winnebah
	03/25-27		anchored off Accra (English fort); Dutch, Danish forts also
	03/28	5°43	
	03/29	5°44	
	03/30	6°13	
	03/31-04/01		anchored at Whydah (English fort)
	04/02-20	6°07 to 0°23n x 0°42 to 5°3e	off the coast of Whydah
	04/21	00°16n	north end of the island of St. Thomas
	04/22-05/02		in Annadechoros Bay, St. Thomas island
	05/06	00°45s x 0°52w	
	05/07	00°56s x 1°42w	
	05/08	1°05s x 2°51w	
	05/09	1°07s x 3°48w	
	05/10	1°48s x 5°15w	
	05/11	2°17s x 7°20w	
	05/12	2°04s x 9°14w	
	05/14	1°55s x 12°31w	
	05/15	2°26s x 13°54	
	05/16	2°31s x 15°18	
	05/17	2°11s x 16°41	
	05/19	2°07s x 19°29	
	05/20	2°19s x 21°08	
	05/21	2°41s x 23°06	
	05/22	2°57s x 25°29	
	05/23	3°21s x 27°10	
	05/24	3°34s x 28°37	
	05/25	3°06s x 30°32	
	05/26	2°19s x 32°29	
	05/27	0°59s x 34°09	
	05/28	0°33n x 35°42	
	05/29	2°06n x 36°47	
	05/31	4°22n x 37°57	
	06/01	3°17 x 38°50	
	06/02	5°52 x 39°19	
	06/03	6°56 x 40°19	
	06/04	8°28 x 41°55	
	06/05	9°44 x 44°18	
	06/06	10°58 x 46°48	
	06/07	12°00 x 49°10	
	06/08	12°23 x 51°14	
	06/09	12°37 x 53°14	
	06/10	13°22 x 55°23	
	06/11		south end of Barbados
	06/12		Carlisle Bay, Barbados

Year	Month & Day	Coordinates	Activity	
1776 continued	06/13-18		Cape Solomon to Martinico	
	06/22-07/05		moored in Port Royal harbor	
	07/06		sailed with 22 vessels and <i>Maidstone</i> ; bound up North American coast	
	07/10		company added <i>West Florida</i> pacquet ( <i>sic</i> ) and now number 105 merchant	
	10/01		liberated the <i>Anne</i> from Dominica bound for London and taken by an American privateer	
	10/03		chased off what appeared to be an American privateer	
	10/12		entered St. Lawrence harbor	
	10/13-28		St. Lawrence harbor	
	10/29-11/16		Atlantic crossing <sup>23</sup>	
	11/01	44°47 x 08°10		
	11/02	45°14 x 11°10		
	11/03	45°30 x 14°56		
	11/04	45°34 x 16°12		
	11/05	44°43 x 18°08		
	11/06	44°24 x 22°36		
	11/07	44°37 x 25°20		
	11/08	45°08 x 27°46		
	11/10	47°59 x 35°40		
	11/13	49°24 x 45°40 <sup>22</sup>		
	11/17			arrived at Spithead
	11/18-20			anchored at Spithead
	11/23-12/05			in Portsmouth Harbor
	12/06		aside sheer hulk replacing mainmast	
	12/07-14		in Portsmouth Harbor	
<b>1777</b>	12/15-26		in dock; no reason given	
	12/28-01/23		Portsmouth harbor; refit, maintenance, provisioning <sup>24</sup>	
	01/24-02/28		at Spithead	
	03/01-20		sailed as escort to convoy to Tenerife, Grand Canary	
	03/21-04/02		in and around Tenerife and Grand Canary	
	04/05		anchored at Senegal Fort	
	04/06		anchored at Senegal Bar	
	04/08-15		mouth of Gambia River	
	04/16-25		worked from Cape St. Mary to Cape Sierra Leone	
	04/26-05/10		in Frenchman's Bay, Sierra Leone	
	05/11-22		Cape Sierra Leone to Cape Palmas	
	05/23-06/01		Cape Palmas to Cape Apollonia	
	06/01-04		to Commenda Castle	
	06/05-09		Cape Coast Castle	
	06/10	4°44n x 0°49e	Annamaboe	
	06/10-22	4°44n x 00°49e to 8°28s x 6°13w	worked down African coast from Annamaboe	
	06/23-07/25		Atlantic crossing	

Year	Month & Day	Coordinates	Activity
1777 continued	07/26		arrived Carlisle Bay, Barbados
	07/27-08/07		patrol around Dominica with HMS <i>Jenny</i>
	08/07		arrived Port Royal
	08/07-10/26		Port Royal; overhaul blocks and rigging, new gammoning and bobstays, blacking yards and rigging, reeving the running rigging, working up junk <sup>25</sup> , scraped and payed deck, lower masts, and sides
	10/27		departed Port Royal with HMS <i>Bute</i> and six merchantmen
	11/07		arrived Bluefields Bay, Jamaica
	11/08-09		in Bluefields Bay
	11/10		departed Bluefields Bay with <i>Bute</i> , <i>Nancy</i> sloop and 17 sail
	11/15		<i>Nancy</i> sloop parted company and made for Pensacola
	11/18		liberated schooner taken by American privateer
	11/29		<i>Bute</i> started taking on water and <i>Pallas'</i> carpenter sent to assist
	12/03		<i>Bute</i> scuttled by her captain
<b>1778</b>	01/14-16		anchored at Spithead <sup>26</sup>
	01/17-29		in Portsmouth Harbor <sup>27</sup>
	01/30-04/24		in dock; iron ballast out; cleaned and rummaged; boatswain and carpenter stores returned; fitting the rigging <sup>28</sup>
	04/25-05/18		in Portsmouth
	05/19-24		at Spithead
	05/25-27		sailed for Torbay
	05/28-06/12		at Torbay
	08/24		arrived at St. Lawrence
	09/05-11		St. John's, Newfoundland
	09/11-16		local patrol; Cape Race; Cape Chapeau Rouge
	09/17-10/08		moored at St. Peter's Road, Newfoundland
	10/09-12		local patrol
	10/13-31		St. John's harbor <sup>29</sup>
	11/01-29		escorted convoy to Gibraltar with <i>Invincible</i> and 40 plus sail
	11/29-12/09		in Gibraltar Bay
	12/10-11		in Cadiz Bay
	12/12-26		patrol St. Mary and St. Sebastian
	12/27-29		in Cadiz Bay
<b>1779</b>	12/30-01/25		Cadiz to Spithead
	01/26-02/25		Mitler [?] Banks and Spithead
	03/05-05/02		in Hamoze near Spithead; refit, reeving running rigging, provisioning, replaced canvas, masts and bowsprit, painted lower masts, re-rigged
	05/03-22		around Guernsey, Grovedela Bay, Cancale Bay, Cawsand Bay <sup>30</sup>
	05/23-06/16		moored at Spithead
	06/17		depart with convoy, 28 sail and HMS <i>Cameleon</i>



Year	Month & Day	Coordinates	Activity
1779 continued	06/21	49°25 x 1°36w	
	06/22	49°16 x 3°01w	
	06/23	48°53 x 5°25	
	06/24	47°03 x 7°33	
	06/25	xxxx x 8°13	
	06/26	44°39 x 8°27	
	06/27	43°21 x 8°39	
	06/29	38°54 x 8°52	
	07/01	34°55 x 8°26	
	07/03	32°49 x 10°30	
	07/04-11		moored at Funchal Bay
	07/13		west end of Madeira
	07/15	30°54 x 00°47w	
	07/19	26°55 x 6°13	
	07/21	24°24 x 9°19	
	07/25	19°52 x 15°16	
	07/30	15°22 x 23°37	
	08/02	13°05 x 29°05w	
	08/08		off Carlisle Bay, Barbados
	08/14		moored at English Harbor
	08/25-09/11		moored at Port Royal
	09/12-10/21		patrol around Cuba, Jamaica, Tortuga, Cape Nichola, Monte Christie, Porto Plata, and Isabella Point
	10/22-11/05		Port Royal Harbor
<b>1780</b>	11/06-01/01		patrol around Caribbean
	01/02-23		moored at Port Royal
	01/24		depart as part of large fleet of men of war and merchantmen
	02/08	28°49n x 79°32w	
	02/12	32°23 x 86°28	
	02/16	29°49 x 83°33	
	02/20	29°45 x 69°40	
	02/23	28°59 x 66°57	
	02/28	29°00 x 65°37	
	03/01	28°34 x 65°10	
	03/04	26°15 x 65°44	
	03/07	19°58 x 65°06	
	03/11	17°15 x 70°20	
	03/13	17°19 x 73°52	
	03/21	17°18 x 75°02	
	04/08		joined with HMS <i>Phoenix</i>
	04/10	12°33 x 75°18	<i>Phoenix</i> in company
	04/25	13°54 x 71°25	
	05/01-06/10		Port Royal

Year	Month & Day	Coordinates	Activity
1780 continued	06/11-21		short patrol with HMS <i>Ulysses</i> ; Cape Tiberon and Isle of Ash
	06/22-07/11		Port Royal
	07/16-22		Bluefields Bay
	07/27		joined with HMS <i>Lowestoffe</i>
	07/30	19°50 x 80°51	
	08/01	21°26 x 83°40	
	08/09	23°19 x 85°44	
	08/12	24°11 x 85°49	
	09/06		took Spanish prize <sup>31</sup>
	09/13		in and around Tortuga Bank
	09/15		Key Largo
	09/19	31°50 x 78°07	
	09/22	29°54 x 74°47	
	09/27	28°54 x 70°31	
	10/01	23°35 x 69°06	
	10/05	21°53 x 71°00	
	01/06-18		worked back to Jamaica
	01/19-23		Port Royal
	10/24-31		short local patrol
	11/01-15		short local patrol; took Spanish packet [ <i>sic</i> ] prize on the 10 <sup>th</sup>
	11/16-12/03		Port Royal
	12/04		sailed with HMS <i>Diamond</i> and HMS <i>Pomona</i> in company; patrol
<b>1781</b>	01/09	19°27 x 65°30	took prize snow <sup>32</sup>
	01/17	20°05 x 63°59	took prize brig
	02/03		return to Port Royal
	02/03-10		in Port Royal
	02/11		patrol with <i>Diamond</i> , <i>Pomona</i> , HMS <i>Pelican</i> , and <i>Guay Trouin (Frouin?)</i>
	02/24	16°17 x 71°13	
	02/26	14°15 x 68°56	
	03/03	12°35 x 69°25	
	03/07	15°08 x 70°05	
	03/13	12°23 x 65°47	
	03/18		took two Spanish brigs and a 40-gun letter of marque
	03/20		took American brig from Philadelphia
	03/21		parted company with all but <i>Pomona</i> at Bon Aire [ <i>sic</i> ]
	03/22-04/10		work back to Jamaica
	04/11-05/14		Port Royal
	05/15		sail in company with <i>Diamond</i> and <i>Ulysses</i> and eight sail merchants
	06/17		joined 'active' privateer from Jamaica
	06/21		took American prize ship
	07/21-08/20		Port Royal
	08/21		sailed with fleet including <i>Ramillies</i>

Year	Month & Day	Coordinates	Activity
1781 continued	09/13		<i>Diamond</i> joined
	10/24		Porto [ <i>sic</i> ] Rico
	10/31		Bon Aire
	11/06		return to Port Royal
	11/07-12/17		Port Royal, Kingston and Fairway
<b>1782</b>	12/17-02/28		patrol Turks, Isabella Point; HMS <i>Resource</i> in company
	03/01-05		Kingston harbor
	03/06		Port Royal
	03/28-04/25		Kingston
	04/26-05/21		Port Royal; sheer hulk, replacing main mast
	05/22-06/27		Patrol
	06/28-07/24		Port Royal
	07/25		Departed Port Royal with Admiral Graves' fleet prize fleet from the Battle of the Saints, bound for England. <sup>33</sup>
From Late September, 1782 until January 1783, the whereabouts of <i>Pallas</i> are unknown.			
<b>1783</b>	January 1783		Halifax. <sup>34</sup> Late January sailed from Halifax escorting a convoy bound for England.
	02/12		Calheta Harbor, São Jorge, Azores; <i>Pallas</i> set on fire <sup>35</sup>

<sup>1</sup> Until or unless otherwise noted, the following information comes from TNA: PRO ADM 51/666. Lieutenant's logbooks from HMS *Pallas*.

<sup>2</sup> Gardiner, *First Frigates*, p. 22-28.

<sup>3</sup> TNA: PRO ADM 51/666. Lieutenant's logbooks from HMS *Pallas*. Both the quantity of information and the degree of detail available about *Pallas*' career varies considerably in the logs of her numerous Captains; variance which is inevitably reflected in this table.

<sup>4</sup> Clowes, *Royal Navy*, Vol. 3, p. 193-94. Although there is a gap in the *Pallas* logbooks for this period, Clowes states that from August 6-17, *Pallas* participated in Admiral Howe's raids on Cherbourg and that Howe transferred his flag to *Pallas* in order to be able to stand in closer to shore during the operation.

<sup>5</sup> TNA: PRO ADM 51/666. Lieutenant's Logbooks from HMS *Pallas*. The longitudes given in the log book for November 20 and 22 are incorrect coordinates that would place *Pallas* in Western Spain

<sup>6</sup> TNA: PRO ADM 51/666. Lieutenant's logbooks from HMS *Pallas*.

<sup>7</sup> TNA: PRO ADM 51/666. Lieutenant's logbooks from HMS *Pallas*. No explanation is given for this change of command.

<sup>8</sup> NMM: PJ/JC Vol. 1, National Maritime Museum Warship History Continuation Sheet microfilm.

<sup>9</sup> Jenkins, *History of the French Navy*, 129-36. These were the French frigates *Marshal Bell Isle* (44), *Lablond* (36) and *Terpsichor* (24). The two squadrons engaged and after a short, hour and a half long battle all three French ships were taken. *Pallas* suffered sail and rigging damage, a shot through the mainmast, and her best bower was shot away. The French frigates had been dispatched from Dunkirk in October with a small detachment of troops under the command of the renowned privateer Captain Thurot with orders to sail north and land a diversionary force in Ireland in preparation for the cross-channel invasion.

<sup>10</sup> Clowes, *Royal Navy*, Vol. 3, 303. At some point in the late summer of 1760, *Pallas*, *Shrewsbury* and *Argo* engaged in a running battle with the French 74 *Diadème* escorting a convoy to Martinique. *Shrewsbury* was a poor sailor and it was left to the frigates to harass and slow *Diadème* until *Shrewsbury*

could catch up. Unfortunately, *Pallas* exposed herself to a broadside from *Diadème* and was forced to break off the pursuit.

<sup>11</sup> Clowes, *Royal Navy*, Vol. 3, 253. This is interesting. *Pallas* was in a French port five months before peace was suggested by the French.

<sup>12</sup> All of the above information comes from TNA: PRO ADM 51/666 unless otherwise noted.

<sup>13</sup> Unless otherwise noted the following information comes from TNA: PRO ADM 51/667 Lieutenant's Logbooks from HMS *Pallas*.

<sup>14</sup> NMM: PJ/JC Vol. 1. National Maritime Museum Warship History Continuation Sheet microfilm. At some point between January and May of 1771 Captain Laforey was relieved, because on May 7, 1771 when *Pallas* sets sail for the Mediterranean, Captain C. Watson was in command.

<sup>15</sup> NMM: PJ/JC Vol. 1. National Maritime Museum Warship History Continuation Sheet microfilm.

<sup>16</sup> Coordinates for May 12 through May 17, 1771 cannot be correct as they reference points on the Iberian peninsula. Either little care was taken in the readings or the coordinates were transcribed incorrectly.

<sup>17</sup> A gap in TNA: PRO ADM 51/667 Lieutenant's Logbooks from HMS *Pallas*, for the period April 1 to December 9, is partially covered in TNA: PRO ADM 51/4283.

<sup>18</sup> TNA: PRO ADM 51/667. Lieutenant's Logbooks from HMS *Pallas*. Record recommences after gap filled by TNA: PRO ADM 51/4283. Lieutenant's Logbooks from HMS *Pallas*.

<sup>19</sup> Ibid.

<sup>20</sup> TNA: PRO ADM 51/667. Lieutenant's Logbooks from HMS *Pallas*. No specifics are given regarding the repair undertaken while in dry dock.

<sup>21</sup> TNA: PRO ADM 1/1611. Admiralty Correspondence. During this period, Captain Cornwallis received news that an American brig in the Gabon River had arms and ammunition aboard. The brig was captured with the assistance of *Weasel* sloop and 1<sup>st</sup> Lieutenant Bray of the *Pallas* was ordered to sail the prize to Antigua.

<sup>22</sup> Note that coordinates progress backwards from east to west. Presumably they were entered into the logbook at a later date.

<sup>23</sup> Information for November through December 1776 extracted from TNA: PRO ADM 51/4283.

<sup>24</sup> NMM: PJ/JC Vol. 1. National Maritime Museum Warship History Continuation Sheet microfilm. During this layover, Captain Cornwallis was reassigned and Captain Rowland Cotton took command.

<sup>25</sup> Blanckley, *Naval Expositor*, 83. Junk was old rope cut into short lengths for use as swabs, nippers and to be picked in oakum.

<sup>26</sup> NMM: PJ/JC Vol. 1. National Maritime Museum Warship History Continuation Sheet microfilm. In early 1778. Captain Rowland Cotton was reassigned and Captain Richard King took command.

<sup>27</sup> TNA: PRO ADM 51/668. Lieutenant's Logbooks from HMS *Pallas*. Unless otherwise noted the following information comes from TNA: PRO ADM 51/668. Lieutenant's Logbooks from HMS *Pallas*. It is probable that the new logbook coincides with the change of command; Captain King records little in the way of useful remarks during his tenure.

<sup>28</sup> NMM: PJ/JC Vol. 1. National Maritime Museum Warship History Continuation Sheet microfilm. It is almost certain that *Pallas* was coppered during this period in dry dock.

<sup>29</sup> NMM: PJ/JC Vol. 1. National Maritime Museum Warship History Continuation Sheet microfilm. During October 1778, Captain King was reassigned and Captain T. Spry took command.

<sup>30</sup> NMM: PJ/JC Vol. 1. National Maritime Museum Warship History Continuation Sheet microfilm. I have found references to an action at Concale around this date suggesting that *Pallas* was involved.

<sup>31</sup> TNA: PRO ADM 51/668. Lieutenant's Logbooks from HMS *Pallas*. The logbook contains no details as to the ship type.

<sup>32</sup> *ibid.*, The nationality of the snow taken on January 9<sup>th</sup> and the brig taken on January 17<sup>th</sup> is not given.

<sup>33</sup> Breen, "Foundering of the HMS *Ramillies*," 190. HMS *Ramillies* and several of the French prizes in the convoy were lost in severe weather.

<sup>34</sup> TNA: PRO ADM 51/668. Lieutenant's Logbooks from HMS *Pallas*.

<sup>35</sup> Crisman, "Looking for Ships," 7-8.

## VITA

Peter Erik Flynn  
 P.O. Box 1343  
 Helena MT 59624  
 eflynn13@yahoo.com

Education: M.A., Nautical Archaeology, Texas A&M University, 2006  
 B.A., Classics and History, University of Manitoba, 1998

Honors/Awards:

Phi Kappa Phi Honor Society, 2001- Present  
 Graduate Assistantship, J. Richard Steffy Ship Reconstruction Laboratory, 2001-2002  
 Travel Research Grant, Public Record Office and National Maritime Museum, London, England; Summer 2002  
 Graduate Assistantship, J. Richard Steffy Ship Reconstruction Laboratory, 2002-2003

Publications:

Maintained and contributed to Texas A&M Nautical Archaeology Program Ship Reconstruction Laboratory website  
 Contributed to "From Ships to Shore", catalog for the Carrington Weems Antique Map and Ship Model Exhibition at the J. Wayne Stark Galleries, Texas A&M University

Professional Experience:

Underwater Archaeological Excavation, Portimao harbor , Portugal, Summer 2002. F. Castro  
 Archaeological Recording, Cais do Sodré project, Lisbon, Portugal, Summer 2002, C. Rodriguez and F. Castro  
 Underwater Archaeological Excavation, Angra D expedition, Summer 2001. K. Crisman  
 Archaeological Recording, Cais do Sodré project, Summer 2001, C. Rodriguez and F. Castro  
 Underwater Archaeological Excavation, Combined Caesarea Expedition, Summers 2000 and 1999; Directors K. Holum and Professor Avner Raban  
 Archaeological Excavation/Asst. Supervisor/Acting Area Supervisor, Ein Gedi, Israel Winter 1999; Y. Hirschfeld, Director; A.de Vincenz, Supervisor  
 Contract Archaeology / Cultural Resource Management, Environment and Archaeology, LLC Florence, Kentucky, Fall 1999,;Summer-Fall 1998; V. Whitlatch, Supervisor  
 Archaeological Excavation / Artifact Restoration and Archiving, Ein Gedi, Israel, Winter 1998; Director, Y. Hirschfeld  
 Archaeological Excavation / Artifact Conservation and Archiving, Dnieprovskaya project, Summer 1997; Professor D. Howorth, University of Manitoba and V.V. Bylkova, Kherson Institute, Southern Ukraine  
 Archaeological Excavation, Summer 1997; Hermitage Museum, St. Petersburg Russia excavation at Nymphaion, southern Ukraine; Expedition Leader, O. Sokolova  
 Archaeological Excavation / Geophysical Survey, Olbia project, southern Ukraine, Summer 1996; D. Howorth, University of Manitoba, Director  
 Archaeological Survey, Oropos project, (Euboa, Greece) Summer 1995; Director, M. Cosmopoulos