

# UNIQUE FAN VIBRATION PROBLEMS: THEIR CAUSES AND SOLUTIONS

by

**Donald R. Smith**

Senior Research Scientist

and

**Harold R. Simmons**

Senior Research Engineer

Applied Physics Division

Southwest Research Institute

San Antonio, Texas

---

*Donald R. Smith received a B.S. degree in Physics from Trinity University in 1969 and is currently a senior research scientist in the Applied Physics Division at Southwest Research Institute. Since joining SwRI in 1967, he has been actively involved in the solution of vibration and pulsation problems in rotating and reciprocating equipment. His specialty in recent years has been the solution of excessive vibration and failure problems in large fan systems and structures. He has been instrumental in the development of computer programs and solution techniques for analyzing lateral and torsional critical speeds, foundation resonances, and field balancing techniques which minimize balancing time.*

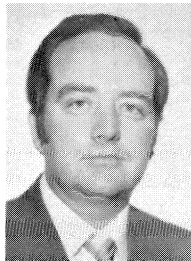

---

*Harold R. Simmons graduated from the University of Florida with a B.S. degree in Mechanical Engineering in 1963 and is presently a senior research engineer in the Applied Physics Division at Southwest Research Institute.*

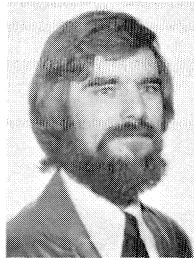

*Mr. Simmons began his career in turbomachinery as a mechanical design engineer at Pratt & Whitney Aircraft where he participated in the design of high Mach number jet engines. He subsequently transferred to the Structures Analysis Group where he contributed to engine design through rotor dynamic analysis and by research on balancing, dampers, and optimization of rotor designs.*

*Mr. Simmons joined Southwest Research Institute in 1974 where he has been involved as project manager in solving many rotating equipment problems by the use of analytical and experimental techniques. Recent contributions are a hand calculator program for two plane balancing by least squares technique and an ASME paper entitled "Vibration Energy: A Quick Approach to Rotor Dynamic Optimization". He is a member of ASME and is a registered professional engineer (States of Texas and Florida).*

---

## ABSTRACT

Operating requirements for new fans demand that greater attention be given to the design of the total installation

including everything from the foundation to the ducts. Rotor dynamic analysis without adequate consideration of the structural and foundation dynamics and of the fluid dynamics and acoustics of the entire system is often not sufficient to deal with fan vibration problems.

This paper discusses a multi-disciplinary approach to evaluate existing fan system designs for root causes of overall vibration problems and the development of methods to solve them. Actual case histories are presented which cover the latest field instrumentation and evaluation techniques in the analysis of fan vibration problems.

## INTRODUCTION

Fan vibration problems have been a serious cause of operational problems, shutdowns, and curtailed operations at a wide variety of industrial plants: Vibration problems often result from mechanical defects such as unbalance and misalignment, which can be routinely solved by the plant personnel. However, other more complex vibration problems also occur which generally require more sophisticated or specialized analytical and field analyses of the entire fan-duct-foundation system.

The duct systems in today's coal fired power plants are complex and often include elaborate pollution control systems which require several fans (Figure 1). Vibrations in such

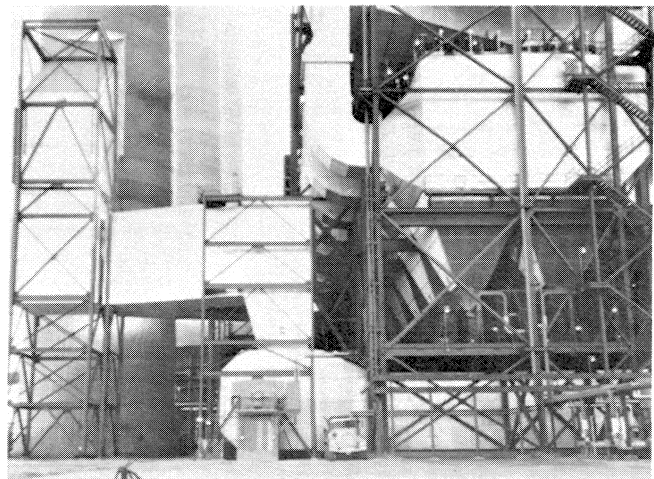

Figure 1. Typical Exhaust Duct System at a Coal Fired Power Plant.

systems are complicated by dynamic interaction of acoustical and structural systems and other fans. When fans are installed inside of buildings, structure-borne vibrations can cause the entire building to shake. On highly resonant systems, attempts to define fan vibration trends are complicated by the almost countless number of coupled variables which make up the system. Seemingly unrelated variables such as time of day, sunshine, rainfall, or load changes on other units often appear to contribute.

In recognition of these system interactions and the multiplicity of excitation sources, it is essential to have an extensive array of different transducers and analysis equipment for a field study (Figure 2). In addition to the usual accelerometers and proximity probes for vibration measurement, pressure transducers, shaft telemetry, strain gages, torsional transducers, and shakers are often necessary. Likewise, spectral analysis equipment is augmented with a spectral time history (raster plot) generator for event correlation and two-channel spectral analyzer for transmission path and source identification.

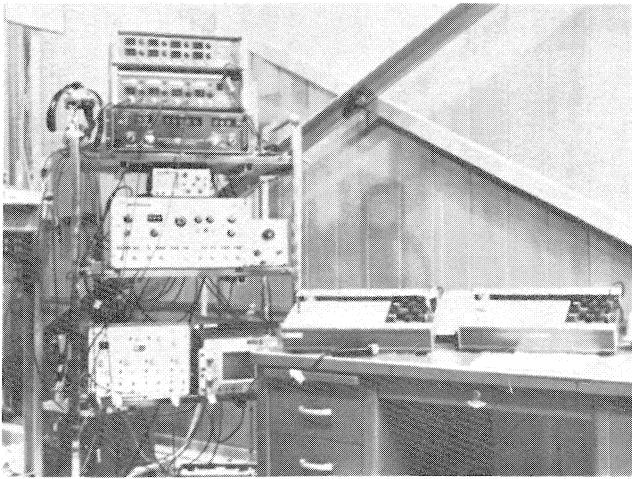

Figure 2. Analysis Equipment Used in Field Vibration Testing.

The objective of this paper is to present the causes and solutions of four unique vibration problems that have been identified in our investigations of many different fan systems.

The first case discusses one of the more unique problems encountered on centrifugal fans which is labeled a disc-wobble resonance. This resonance involves flexing of the impeller support disc and the pitching inertia of the impeller wheel. Severe lateral and axial vibrations can occur when this resonance is near shaft running speed.

The second case deals with fan foundation resonance as a cause of increased system sensitivity to low level excitation. Fans with resonant foundations have been found to vibrate above specified limits even when shut down due to the groundborne excitation from adjacent fans.

The third case illustrates that building, support, and duct structural resonances cause high vibrations on fans. In one study, the excessive vibration caused fatigue failure of axial fan blades and bearings.

In the fourth case several acoustic and flow effects are identified as contributors to fan and duct failures. One of the most significant flow excitation sources is rotating stall, but other sources such as turbulence and vortex shedding also exist, especially when amplified by acoustic resonances.

## DISC WOBBLE RESONANCE

Disc wobble resonance is defined as a pitching mode of the impeller wheel where the flexible element is the center disc. Several cases of disc wobble resonance have been found on centrifugal fans ranging from small single inlet chemical process fans to large double inlet power plant induced draft (ID) fans. Whenever excessive vibrations occur, the fan impeller should be checked for disc wobble resonance by impact or shaker testing. For those fans with this problem, the disc wobble margin was usually only 5 to 40 rpm from the running speed. For those fans with no apparent disc wobble problem, the resonant frequency was at least 20% above the running speed.

One severe case of disc resonance occurred at a plant where four ID fans were installed to convert two units from pressure fired boilers to balanced draft systems. When the units were run at high loads, fan and motor bearing vibration increased to unacceptable levels and bearing failures were reported. Each unit could be run no higher than half load since interaction between fans and fan resonances allowed only one ID fan to operate at a time. Balancing at maximum draft temperature and full load (hot balancing) was not effective in reducing the vibrations.

With one ID fan per unit running, bearing housing vibrations at shaft frequency started at 2 to 3 mils. After a few days, the vibration began to shift in phase and increase in amplitude. Then within a few hours, the amplitude had exceeded the 5 mil alarm point and the phase had shifted over 180 degrees. At this point, the fan was shut down and the other fan on the unit started up.

An investigation was undertaken considering all apparent sources of vibration excitation, including pressure pulsations and coupling of torsional natural frequencies. In addition, a variable speed shaker was used to identify possible fan resonance or critical speeds.

Bearing and shaft vibration amplitudes and phase angles were plotted during several startups and shutdowns (Figure 3) to determine if the fan was operating near a critical speed. Vibration due to unbalance alone (discounting resonances) will increase as a function of the speed squared. It can be seen in Figure 3 that the vibration at 900 rpm was significantly greater than the level due to a pure unbalance. This indicates that the fan was operating near a resonance. The fact that there was no dramatic 180 degree phase shift of the bearing housing

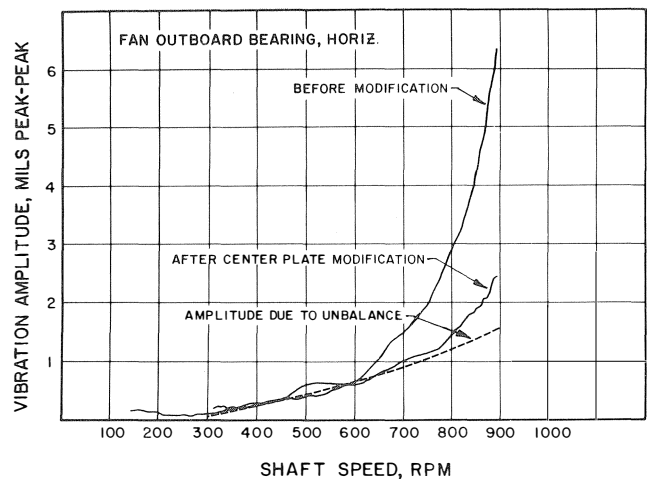

Figure 3. Bearing Housing Vibration Response During Startup.

vibrations indicated that this resonance was probably not a critical speed. The measured shaft torsional oscillations were low and not consistent with running speed; therefore, the torsional resonant coupling effects were negligible.

Signal analysis indicated that the pulsations were synchronous and phase related to shaft speed. Pulsation amplitude in the duct was approximately 0.1 psi and produced a force equivalent to a 10 oz. unbalance at the outside radius of the fan. This pulsation at running speed was postulated to be caused by airfoil spacing and alignment errors.

To identify the resonant frequency, a large variable speed shaker was bolted to the concrete foundation with the force applied in the horizontal direction and run over a frequency range from well below fan speed to 50% above. Vibration data from bearing housings, shaft, and foundation were used to identify the resonances just above the running speed.

The shaft lateral critical speed was found to be 1200 rpm, or 33% above running speed (900 rpm). Calculations indicated that including bearing flexibility would lower the shaft critical to 1080 rpm which was still adequately above the running speed.

The foundation response was found to be highly damped and offered no significant amplification of the vibration at the running speed. The major effect of the foundation was as a vibration transmission path between adjacent fans.

The disc resonance was identified by measurements from inside the impeller wheel during a shaker test. When the shaker speed reached 930 rpm, the whole wheel vibrated at 20 mils or more, but the shaft remained relatively calm. Measurement of the vibration at selected locations around the wheel with accelerometers revealed the disc wobble mode shape (Figure 4).

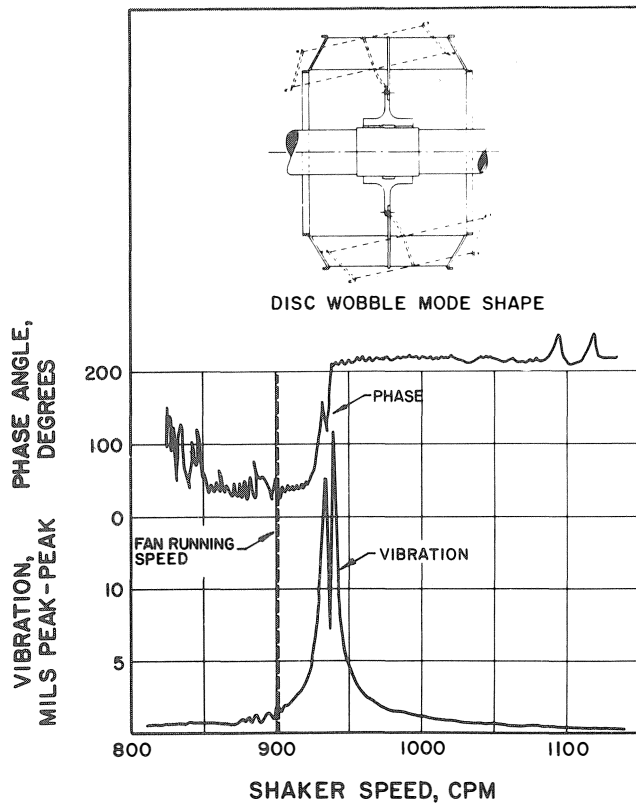

Figure 4. Disc-Wobble Mode Vibration Response to Shaker Excitation.

In this mode the wheel and disc act much like a single degree-of-freedom spring-mass system with the impeller wheel remaining rigid and pitching about the hub. The resonant frequency may be calculated by:

$$f = \frac{1}{2\pi} \sqrt{\frac{K_T}{I_D}} \tag{1}$$

where:  $I_D$  = pitching inertia of the wheel about a diameter  
 $K_T$  = trunion bending stiffness of the support disc.

Gyroscopic effects will tend to raise the disc wobble resonant frequency above that calculated by equation (1). The degree of gyroscopic stiffening depends on the polar to diametrical inertia ratio ( $I_p/I_D$ ) and bearing stiffness symmetry. Although these gyroscopic effects can be simulated it is usually conservative to ignore them.

The disc stiffness can be approximated by:

$$K_T = \alpha Et^3 \tag{2}$$

where: E = Young's Modulus  
 t = plate thickness  
 $\alpha$  = bending coefficient

which is based on Roark, Case 10 [1]. The major limitation of equation (2) is that the assumption of fixed edges does not hold at the disc-to-hub connection and the outer diameter is difficult to define at the airfoil-to-disc connection.

Wedges were driven between the fan impeller and the inlet cone to restrain the wheel and determine the effect of stiffening the center plate. When the shaker test was repeated, wheel and horizontal bearing vibrations were eliminated at 930 cpm. This verified that stiffening the fan center plate would increase the wheel natural frequency and reduce the vibrations on the fan bearings.

An evaluation was made of a plate stiffener that could be fabricated and bolted to the center disc in the field to increase the disc resonant mode. An estimated 50% stiffness improvement was found to be required based on equation (1). The proposed added plate stiffness improvement was checked with a scaled model which was constructed to give qualitative comparisons.

The stiffener plate was installed in one fan and another shaker test was performed to determine the increase in natural frequency. The wheel rocking mode resonant frequency increased by 25%, which agreed with the predicted values.

When the fan was restarted, the bearing housing vibration levels were significantly reduced (Figure 3). These modified fans have since been in operation for several years and no longer have high vibrations even at full load.

### Balancing

In another case, fans with a similar disc wobble resonance did not require modifications to the center plate but vibrations were reduced by field balancing. These fans were in ventilation service and had no large thermal excursions such as ID fans experience. Even when the disc wobble resonance was within 1% of the fan speed, the fans could be successfully balanced for both horizontal and axial bearing housing vibrations using a controlled balancing procedure.

To balance fans near resonances requires accurate amplitude and phase data and the effects of extraneous excitations such as shaft misalignment and fan interaction must be minimized. It was found that the shaft alignment was initially very poor. The initial balancing with the poor alignment was less than satisfactory, as the running speed vibration was very

erratic. After coupling alignment, the large fluctuations of first order vibration data were significantly reduced.

To eliminate other extraneous influence (vibration transmitted between fans), vibration amplitude and phase were plotted versus time (Figure 5). These figures illustrate that the slightly different speeds of the induction motors produce a beating effect on the vibration. The vibration of each fan caused by its own unbalance is the average data between maximum and minimum.

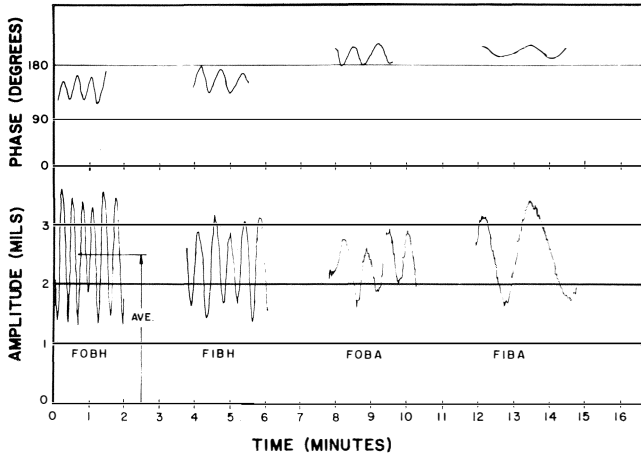

Figure 5. Horizontal and Axial Vibrations of Both Fan Bearings Showing Beating Effect of Adjacent Fan.

Using this data the fans were balanced using a two-plane least squares balancing technique programmed on a Hewlett-Packard HP 65 calculator. Two balance planes were required because the disc wobble resonance and shaft bending mode each required independent balance. The least squares technique [2] was necessary to minimize both horizontal and axial vibrations at both bearings (four points) while only using two balance planes of correction.

### FOUNDATION NATURAL FREQUENCY

During the initial startup of four centrifugal ID fans at a large power plant, the bearing housing vibrations exceeded the 2 mils at 900 rpm specified in the contract. It was reported that the fans could not be balanced satisfactorily; when the vibrations were reduced on the fan bearings, the vibrations would increase on the motor bearing.

Detailed investigations revealed the following problems which made balancing difficult:

1. Foundation resonance.
2. Fan shaft critical speed.
3. Interaction of adjacent fans.
4. Thermal distortion of fan impellers.

#### Foundation Resonance

Vibrations measured on the fan bearings during startup and coastdowns of the fans (Figure 6) revealed what appeared to be a foundation natural frequency near the running speed. These fans were designed to have their lowest foundation natural frequencies at least 70% above running speed, which should have been adequate. Further conservatism was included in the design calculations by using a lower limit value of Young's Modulus (E) of 500,000 psi for the sandstone formation

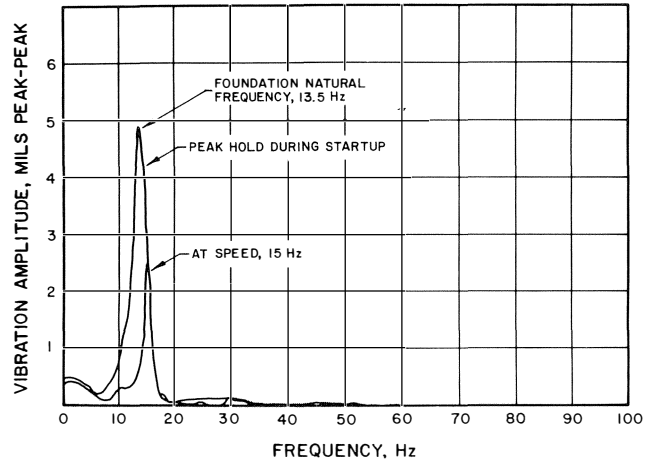

Figure 6. Spectral Analysis of Bearing Housing Vibrations During Startup.

beneath the foundation. On three of the fans, the natural frequency was just below the running speed, but on the fourth fan the resonance was slightly above the running speed. To verify that these were foundation resonances, a variable speed mechanical shaker was attached to the foundation and run through a speed range of zero to 30 Hz. The shaker vibration response agreed with the coastdown data and verified that the first foundation natural frequency ranged from 12 to 16 Hz for these "identical" four fans.

To evaluate the discrepancy between measured and calculated foundation resonances, the foundation-soil dynamic system was modeled with a computer program developed by Southwest Research Institute (SwRI). Foundation natural frequencies were calculated for a range of soil moduli and compared with shaker data. As shown in Figure 7, the effective soil modulus must be from 80,000 to 120,000 psi to match the measured foundation natural frequencies. The lower than expected soil stiffness beneath the foundations was probably due to blasting, over-excavation, and backfill during construction.

A shaker test was conducted on the partially completed foundation block of an adjacent unit (Figure 8) to determine natural frequencies and vibration mode shapes. These tests showed that the effective soil modulus was similar to that obtained for Unit 1, which indicated that the Unit 2 ID fans would also have foundation natural frequencies near the running speed. Foundation modifications to reduce the vibration amplitudes were analyzed using the computer program. However, it was determined that most modifications investigated were impractical based on cost or space limitations and other methods were investigated to reduce the vibrations.

Shaker tests on one foundation revealed that the vibrations were increased by a factor of six when dirt was removed from the side of the foundation. Based upon this test, sand bags were temporarily placed against the side of the foundation to increase damping and lateral restraint on the foundation. The vibrations were reduced by a factor of approximately two to one.

#### Fan Shaft Lateral Critical Speed

In the fan industry has been some confusion as to the exact definitions of critical speed and resonant speed; therefore, to clarify the problem, the Air Movement and Control Association (AMCA) [3] has adopted the following definitions:

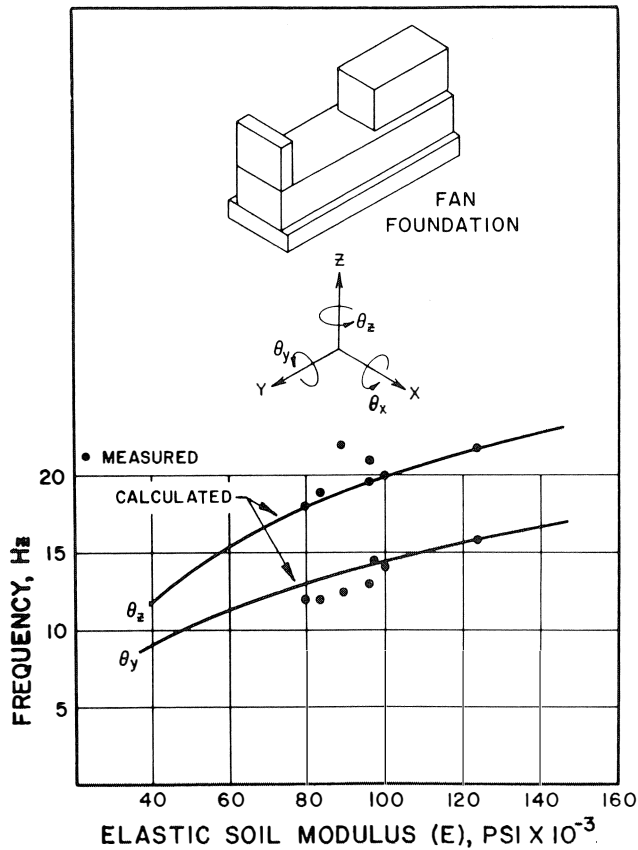

Figure 7. Comparison of Measured and Calculated Foundation Natural Frequencies.

**Critical Speed:** A critical speed is that speed which corresponds to the natural frequency of the rotating element (impeller and shaft assembly) when mounted on rigid supports. (Note: This is generally referred to as the rigid-bearing critical speed.)

**Design Resonant Speed:** Design resonant speed is that speed which corresponds to the natural frequency of the combined spring-mass system of the rotating element, oil film, bearing housing, and bearing supports but excluding the foundation (foundation stiffness is considered as infinite).

**Installed Resonant Speed:** Installed resonant speed is that speed which corresponds to the natural frequency of the combined spring-mass system of the rotating element, oil film, bearing housing, bearing supports, and includes the effect of foundation stiffness.

These ID fans mounted on the resonant foundations also had increased vibration amplitudes due to critical speed effects. The rigid-bearing critical speed and installed resonant speed were calculated to be 1180 rpm and 960 rpm, respectively. The lateral critical speed should be at least 20% from the running speed to prevent excessive vibration amplification. In this case, the calculated installed resonant speed was only 7% above the running speed; therefore, amplification could be expected. It is important that fan users be aware of the critical speed definitions used in the fan industry and refer to the installed resonant speed when writing design specifications.

Major modifications such as shortening the bearing span would be required to increase the shaft critical speed to 20%

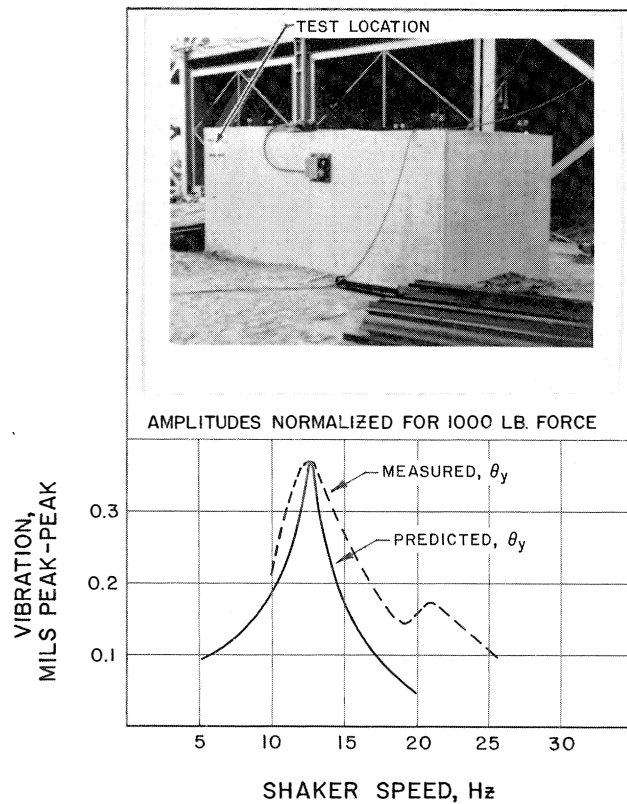

Figure 8. Comparison of Measured and Calculated Foundation Vibration Response.

above the running speed. These modifications were not possible and it was decided to reduce the shaft vibrations by improving the fan balance.

**System Balance**

In the process of developing the best system balance, it is desirable to solo the motor to determine if it is balanced properly. For this system the motor solo tests indicated that the motors were well balanced. However, when the fan was coupled to the motor, high vibrations were measured on both the fan and motor bearings. It was therefore necessary to consider the vibrations of both the fan and motor bearings when calculating balance weights for the fan.

Since the vibration amplitudes and phase angles changed with time, it was decided to plot these variables (Figure 9) to determine if they were repeatable. As shown, the amplitude and phase angle for each bearing traced out elliptical patterns as a function of time. These elliptical patterns were caused by interaction from adjacent fans. The best balance requiring the minimum number of balance trials was obtained by reading the vibration amplitude and phase angle at the center of each elliptical pattern. On one fan, a particularly strong interaction from an adjacent fan developed and a stable vibration phase angle could not be obtained. Fan vibrations immediately stabilized at all four bearing positions (Figure 10) when the adjacent fan was tripped.

Even with the interaction between fans and the foundation and critical speed resonances, two-plane balancing was sufficient to reduce the vibrations to acceptable limits. This

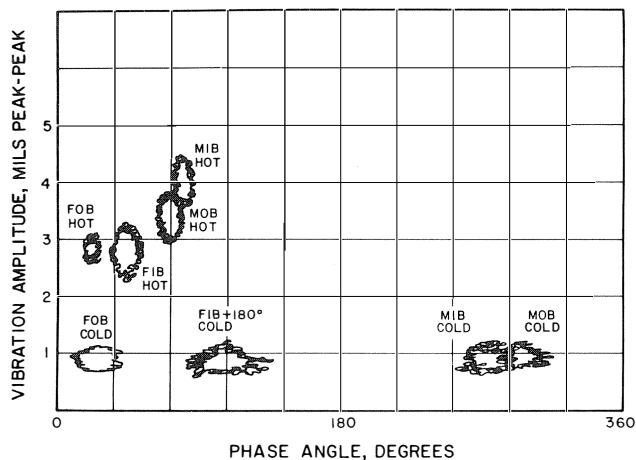

Figure 9. Variation of Motor and Fan Bearing Vibration During Hot and Cold Conditions.

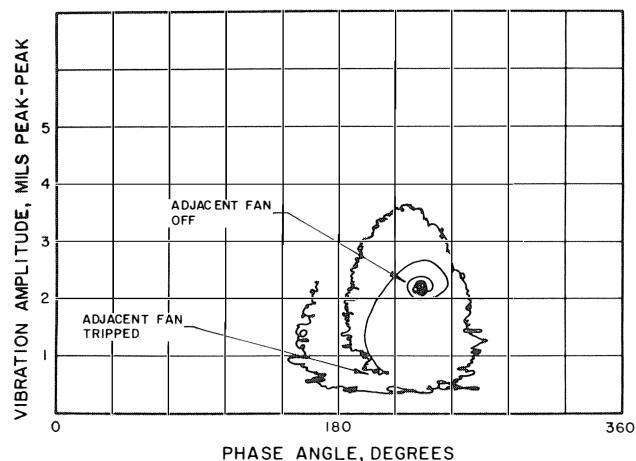

Figure 10. Fan Vibration Interaction with Adjacent Fan.

was accomplished by utilizing a least squares balancing technique. Using this procedure, it was possible to reduce vibration at all four bearing locations even though only two balance planes were used.

All fans of the unit were balanced cold to within the 2 mil limit. When the boiler was fired and the flue gas temperatures increased to approximately 250° F, the vibrations on the bearing housings immediately began to increase and change phase angles (Figure 9). It is not unusual for the balance of a large ID fan to change due to thermal distortion; however, if the fan critical speed and foundation natural frequency are near the running speed, the small changes in unbalance may result in excessive vibration.

Plant management requested that the system be "hot balanced" to counteract unbalance caused by thermal distortion. Hot balancing fans with the plant at full load is a difficult, time consuming process. Experience obtained in hot balancing these ID fans revealed that it took approximately 10 to 12 hours of running time after the installation of a balance weight before fan vibrations stabilized. Data taken before this time could result in ineffective corrections.

Although the fan vibrations were reduced by hot balancing, the units remained very sensitive to small changes. It was

determined that the residual unbalances in the fans were now much less than the allowable and additional balancing would not be effective.

It was determined that although the bearing housing vibrations increased above the specified level of 2 mils, there was no bearing damage because the foundation moved with the shaft. By using proximity probes in addition to accelerometers, it was found that the vibration levels could be increased to 5 mils without causing excessive shaft-to-housing vibrations. The plant has operated for several years with higher vibration levels without bearing damage.

## CASE RESONANCE

Case resonances on fans can amplify shaft vibrations which can lead to blade and bearing fatigue failures. One such case was encountered on two axial forced draft (FD) fans (Figure 11) installed inside a power plant building. Excessive vibration levels were experienced on the fans, motors, and particularly on the floor between the fans. The fans were overly sensitive to changes in blade pitch and unbalance.

When these fans were first installed, they operated in continuous service for approximately one year with no vibration problems. On the initial field balance, the balance sensitivity was considered normal for fans of this type. When the fans were restarted after disassembly for maintenance, vibration levels suddenly increased. Balancing could not bring vibration levels to the required level. Fatigue failures of the fan blades and bearings began to appear after a short time. The bearing housing is part of the case and vibration is easily transmitted throughout the fan housing and into the floor.

In the course of investigation, tests made during fan operation and with a mechanical shaker indicated that severe resonances occurred near the fan running speed (1200 rpm) which amplified the vibration levels on the fans, motors, and the floor. These resonances were identified as:

1. Motor-foundation natural frequency.
2. Shaft critical speed.
3. Natural frequency of the inlet box and attached acoustic insulation.
4. Floor resonance.

To solve the vibration problem it was necessary to systematically identify each of the resonant mode shapes and attempt to detune each separately, and then to determine the effect on the entire system.

First, the motor-foundation natural frequency was identified at 1180 and 1220 cpm as shown in Figure 12. The experimentally measured mode shape indicated that the motor was rocking on top of the foundation and that the motor-to-foundation attachment appeared flexible. Additional tie-down bolts were added and the motor vibrations reduced by a factor of three.

Inadequate motor tie-downs have been observed in many jobs. The attachment may be satisfactory for static loads but does not have sufficient stiffness to control dynamic loads. It is important that the connection between the machine and the foundation be rigid to prevent amplification of the vibration excitations from the motor rotor to the foundation.

Using impact and shaker tests, the shaft first lateral critical speed was measured to be 900 rpm at rest (Figure 13). The first critical speed increased to 1095 rpm with the fan running at 1200 rpm. The increase in critical speed was due to the gyroscopic effects of the large overhung wheels. The first lateral critical speed was less than 10% from the running speed which also increased the vibration sensitivity of the fans.

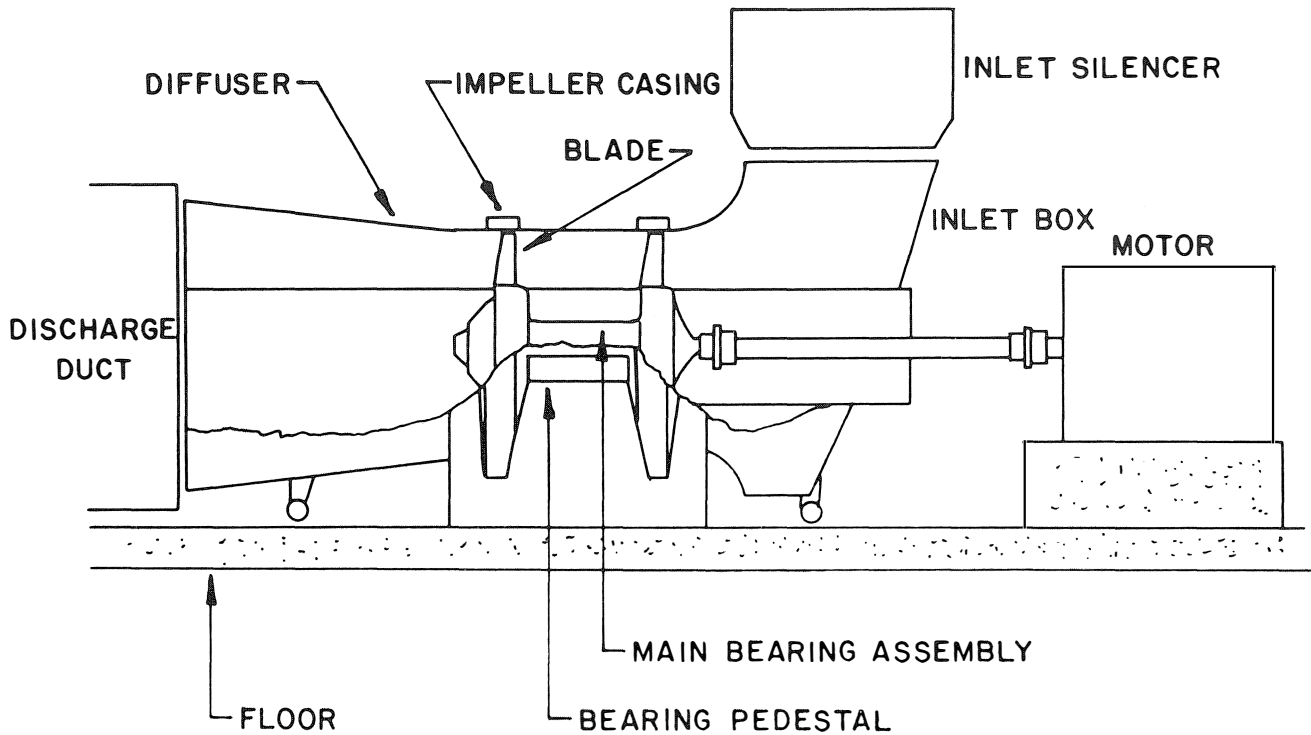

Figure 11. Cutaway View of Two-Stage Axial Fan.

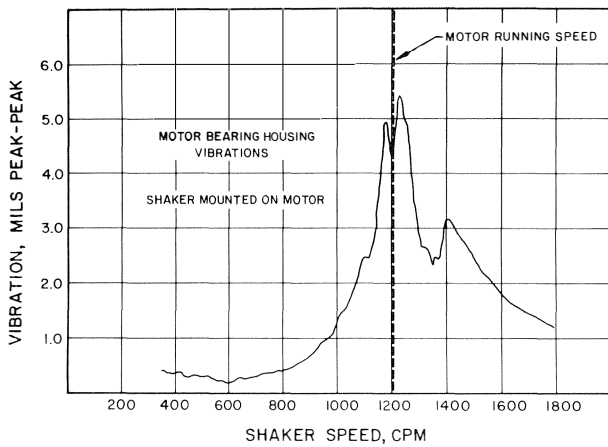

Figure 12. Motor Bearing Vibration Response to Shaker Excitation.

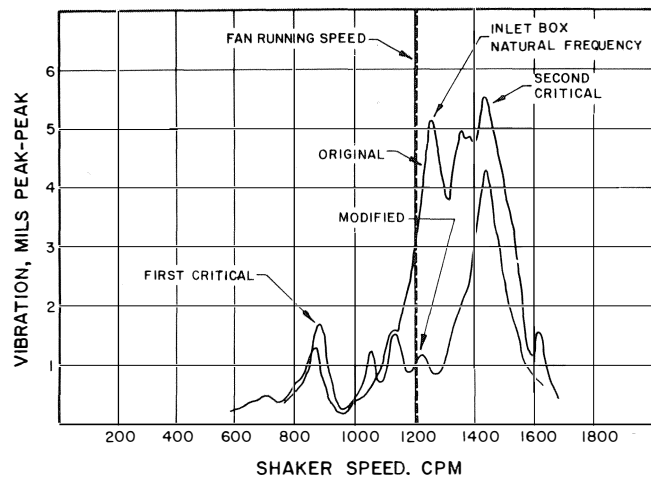

Figure 13. Fan Shaft Vibration Improvement Due to Bracing the Inlet Box.

Initial shaker tests of the inlet box and diffuser indicated a strong response at 1240 cpm (Figure 13). To determine which part of the fan housing was resonant at 1240 cpm, the fan was systematically disassembled and shaker data was taken after each part was removed. The shaker tests were repeated with the inlet box totally isolated from the fan and the floor and the response at 1240 cpm was completely eliminated.

When the inlet box was rolled back and bolted to the fan housing, it was noticed that a piece of metal at the upper edge was bent and had rigidly wedged against the silencer. The inlet box and the silencer were not supposed to be structurally connected. A shaker test was run with this wedge in place and all the vibrations were significantly reduced. When this piece

of metal was cut, the vibrations on the fan and the floor increased to their previous levels. This indicated that partially restraining the inlet box at the silencer was beneficial and added structural damping to the system as the vibration amplitude reduced while frequencies remained the same. The wedged piece of metal would press against the silencer differently each time the inlet box was removed and reinstalled, and the vibration characteristics would be different. This test indicated that the inlet box resonance was primarily responsible for the extreme vibration sensitivity of the fan.

The vibration levels on the fans, motors, and floor were significantly reduced after the inlet box was attached to the

silencer with braces and additional anchor bolts were added between the motor and the foundation. After these modifications, the fans were no longer sensitive to load change and had normal balance sensitivity.

## ACOUSTIC AND FLOW EFFECTS

A number of acoustic and flow-related effects have been identified which contribute to fan vibration problems. For example, a once-per-revolution pulsation was measured during the disc-wobble resonance and was phase related to the shaft. A resonant acoustic path through the inlet duct from one side of the impeller to the other was identified. In this case, however, the problem was solved by mechanically stiffening the disc and no acoustic modifications were required.

Another well documented acoustic excitation in fans is rotating stall [4]. This is caused by the air impinging on the fan blade at an improper angle resulting in flow separation and stall. Under some marginal flow or improper preswirl conditions, this stall affects only a few blades in a localized portion of the fan, forming what is called a stall cell. Multiple stall cells can be formed equally spaced around the impeller. As the impeller blades form a cascade whereby the pressure field of one blade affects that of its neighbor, the stall cells tend to precess around the impeller. It has been the authors' experience that the precession of stall cells is commonly at one-third shaft speed. A spectrum plot (Figure 14) of a fan inlet pulsation signal shows strong frequency components at exact multiples of one-third shaft speed. These multiples occur because of multiple stalls cells and pressure signal distortion creating higher harmonics.

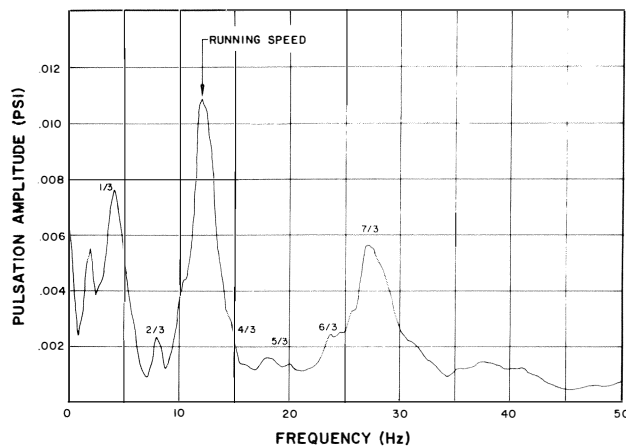

Figure 14. Spectral Analysis of Fan Inlet Pulsation Showing One-Third Multiples of Shaft Speed.

Rotating stall has been found on many fans, but it seems to be most prevalent on systems with overdesigned fans that are highly throttled at the inlet. Variable inlet vanes tend to improve the air-to-blade incident angle at highly throttled conditions, but may not be the complete solution.

### Inlet Vortex

In one experience during the initial startup of a power plant, high vibration levels were observed on the inlet boxes of two ID fans which resulted in extensive structural damage. On one of the fans that had been in operation for only eleven days,

one of the inlet cones had broken away and several of the internal pipe braces had failed. The second fan ran for only four days and it too suffered extensive fatigue damage similar to the first.

Accelerometers, strain gages, and pressure transducers were installed at several critical locations on the fan housing to identify the source of excitation. It was found that the pulsation, vibration, and strain levels increased as a function of the damper position and the levels were excessive at a damper position of approximately 70% open. The predominant pulsation frequencies were 20, 40, and 60 Hz which coincides with 4, 8, and 12 times the rotating stall frequency (Figure 15). The inlet cone mechanical natural frequency was also found to occur very near 40 Hz and was excited by the pulsations at 40 Hz.

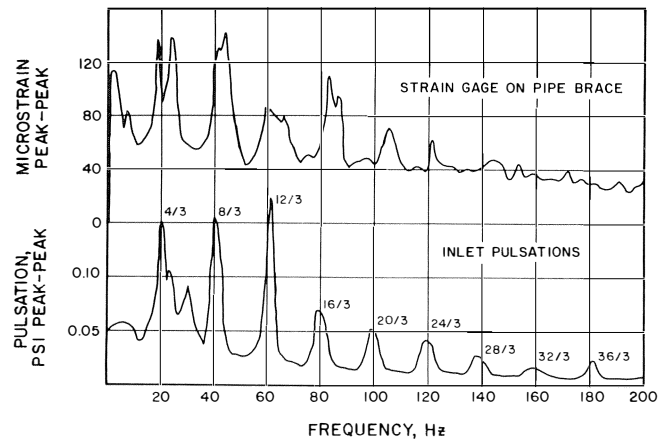

Figure 15. Inlet Pulsation and Strain Spectra Showing Multiples of Rotating Stall Frequencies.

Several modifications were made to the ducts and turning vanes upstream of the fan to reduce the pulsations, but no reduction of pulsation or vibration occurred. Testing was then conducted to determine the effect of discharge throttle control. Flow through most fans is controlled on the inlet side and outlet dampers are used only for fan isolation. For this test, the outlet dampers were temporarily set up for manual control. The inlet dampers were opened to 45% which resulted in high pulsations and vibrations. The inlet dampers were left on automatic control and the outlet dampers were partially closed, keeping the flow rate constant. When the outlet dampers closed to 55%, the inlet opened to 51% and the vibrations and pulsations immediately reduced. This test suggested that a fixed orifice in the discharge duct could reduce the pulsations and vibrations, but its effects at full load were not known. A properly designed damper to control discharge flow was impossible to obtain and install in a reasonable time period; therefore, testing was continued to obtain another solution.

The discharge damper test suggested that an inlet box vortex could be created by the inlet dampers. The vortex velocity would increase as it passed through the impeller eye and could cause an incident angle mismatch at the blades and result in a rotating stall condition. In order to destroy any vortex forming tendencies, splitter plates were installed in each inlet box (Figure 16) directly opposite the inlet dampers. A significant improvement resulted. The vibrations, pulsations, strain, and noise levels were greatly reduced. In addition, the air flow at comparable vane settings was increased by a factor of 1.7 with a similar increase in motor



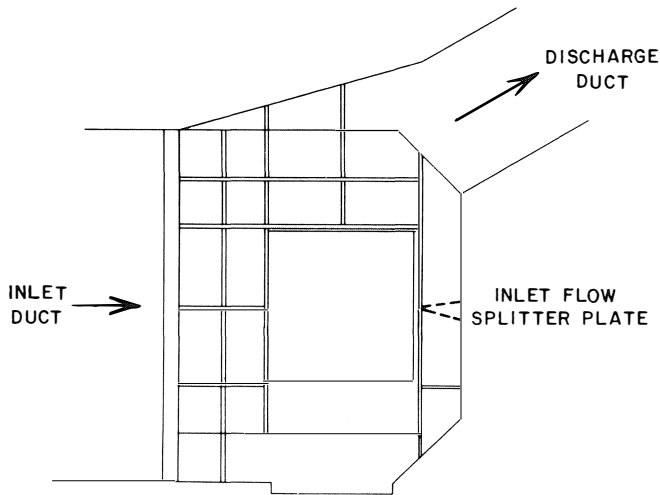

Figure 16. Inlet Flow Splitter Used to Reduce Inlet Vortex.

current. The vibration characteristics were significantly improved and the predominant pulsations components were virtually eliminated.

**Duct Vibrations**

Vibrations of large ducts are generally due to pulsations produced by vortex shedding, flow turbulence, or rotating stall

which excite mechanical natural frequencies of the duct walls or individual panels. The pulsation amplitudes are usually low level (less than 0.01 psi); however, these pulsations can result in shaking forces of several hundred pounds due to large surface areas.

When analyzing duct vibrations, it is necessary to determine if the pulsation amplitudes are excessive, or if the ducts are mechanically resonant or too flexible. If the pulsation amplitudes are low, the vibrations can usually be satisfactorily reduced by stiffening the ducts. However, if the pulsation amplitudes are large, it is usually necessary to reduce the pulsation. Acoustical resonances which form standing waves in the duct can cause high level pulsations. The solution in this case is generally to break up the standing wave by acoustical modifications.

Acoustical resonances have been identified as a contributing factor of exhaust duct structural failures. The usual problems are fatigue damage on internal liners, lagging, braces, and flow dividers.

In the startup of one new installation, failures of the exhaust duct internal liner had occurred at the transition from rectangular to circular section (Figure 17) during cold flow conditions. The cracked liner was attached to a large unstiffened plate that had resonant vibrations of 90 mils at 5.76 Hz. As the pulsation levels were low (0.0015 psi), it was recommended that stiffening ribs be added to the plate. Since these modifications could not be installed for some time, an acoustical solution was also sought for cold flow operation.

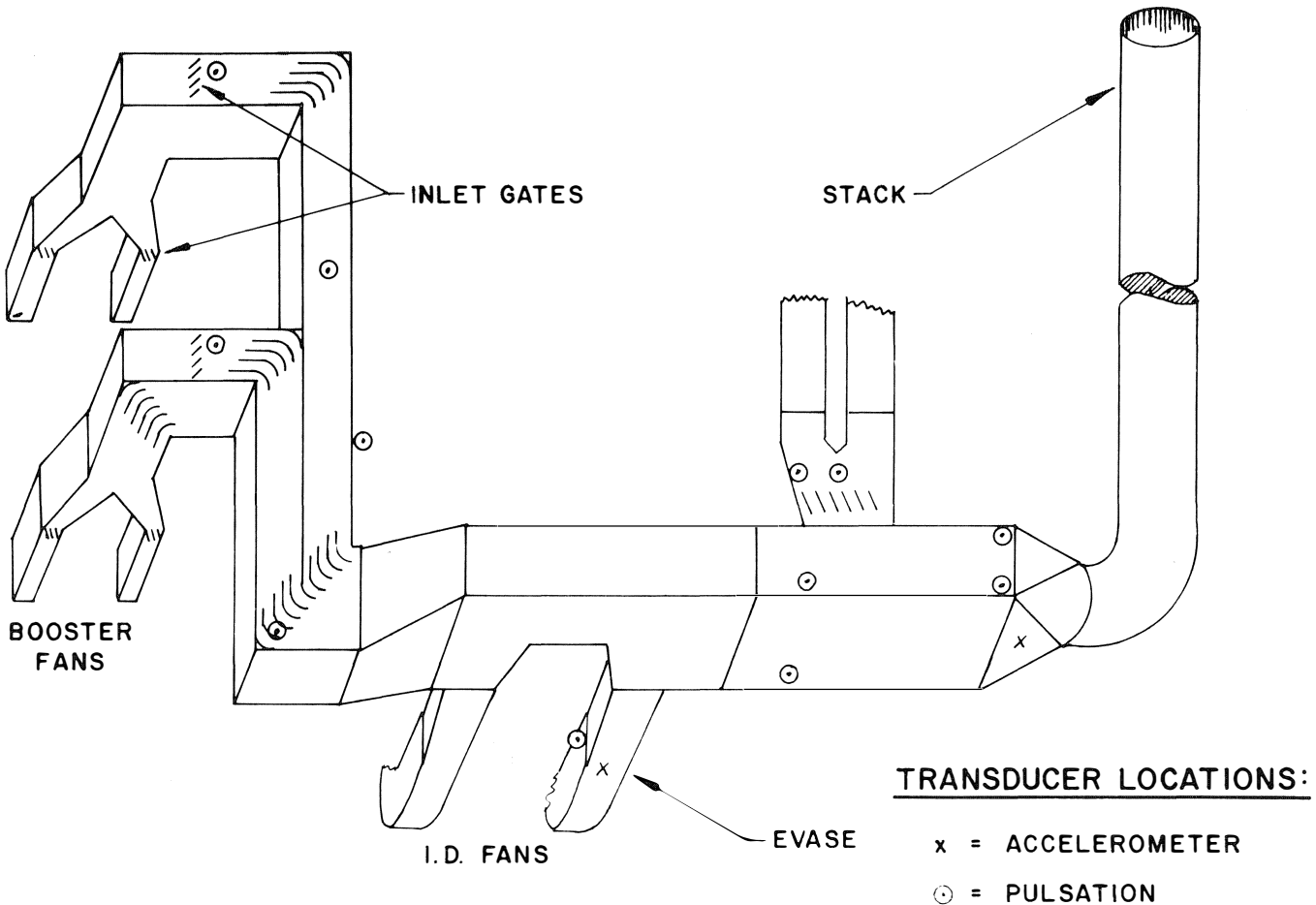

Figure 17. Exhaust Duct Schematic.

A two-channel spectrum analyzer was used to trace the vibration and pulsation transmission path throughout the exhaust duct system. The two-channel analyzer is well suited for this type of study as it can determine the causal relationship (coherence) between two signals. Using this technique, it was determined that the 5.76 Hz vibration was excited by acoustic pulsation and was related to many of the pulsation measurement points throughout the duct (Figure 17). The plates on opposite sides of the transition duct were also found to inflate and deflate together. This relationship suggested that an overall acoustic mode existed in the exhaust duct. The 5.76 Hz pulsation frequency was found to be the 17th harmonic of an exhaust duct fundamental frequency as the total duct length (Figure 18) corresponds exactly with 4.25 wave lengths. Acoustically modifying the system by selectively opening scrubber gates varied transition duct vibration amplitude by as much as  $\pm 40\%$ .

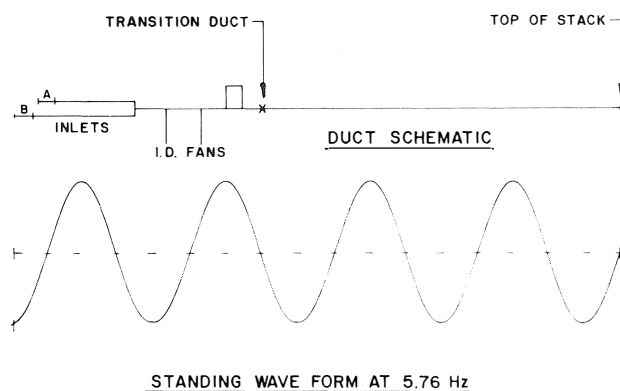

Figure 18. Seventeenth Harmonic Pulsation Mode Shape.

Excessive vibrations also occurred in the evase (fan diffuser). The maximum evase vibration was 23 mils at 4 Hz and was highly coherent with the ID fan exhaust pulsations. Unfortunately, scrubber gate positions that improved transition duct vibration increased evase vibration and vice versa. A compromise condition was established whereby the gates of one scrubber inlet could be opened to cause that inlet leg to act as an acoustic absorber for cold flow purge conditions. These duct vibration problems occurred during the cold flow conditions and they probably would not be a problem during hot, full load operation because the acoustical resonances and flow excitation frequencies would be quite different.

It is very difficult to calculate by hand all the acoustical modes that might exist in a complex exhaust duct system. Often the analysis is limited to calculation of the fundamental longitudinal and transverse (cross wall) frequencies. The fundamental frequencies are usually very low and should have no strong discrete source of excitation. However, as shown in the previous example, harmonics or multiples of these frequencies also exist. This situation is similar to that of a bugle, an instrument with a fixed air column and no keys. Several notes can be played on the bugle by selectively exciting the various harmonics of the fixed air column. With a fundamental frequency of less than 1 Hz, many harmonics will exist and the problem becomes that of matching potential source locations with points that have high coupling potential for a given acoustic mode.

Duct systems can be acoustically modeled with an electronic analog (Figure 19) which has been used in designing

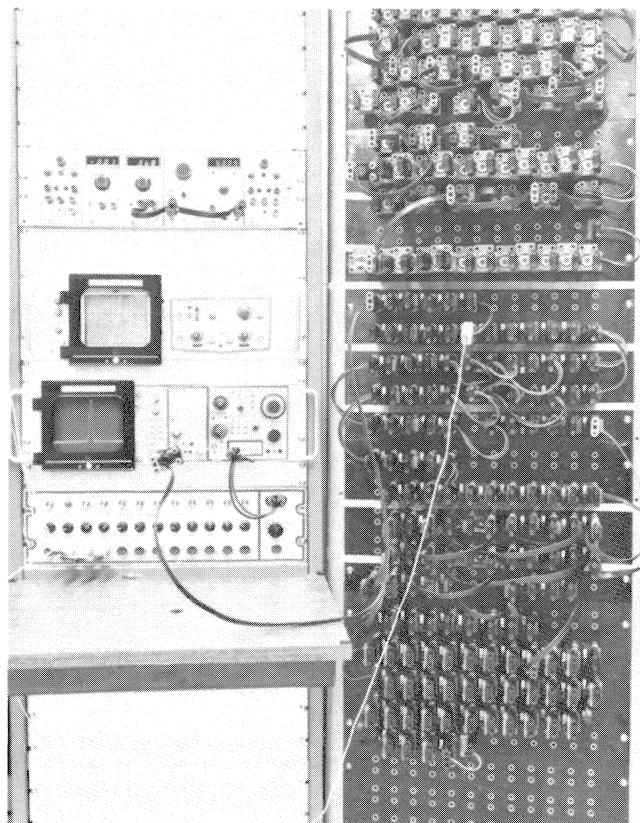

Figure 19. Electro-acoustic Analog of Duct System (Courtesy of Southern Gas Association Pipeline and Compressor Research Council.)

compressor and pump piping for over 25 years. One limiting factor in the simulation of large duct systems is the assumption of a one-dimensional model. This assumption requires that the acoustic wave lengths be long relative to duct widths. Therefore, a limit is established on the highest frequency mode that can be reliably simulated. Since many duct vibration problems occur at low frequencies, effective solutions can be developed using this technology.

Research has shown that another factor which must be considered in correlating the electronic analog model to actual field measurements is the effect of duct wall flexibility on the reduction of acoustic wave propagation velocities. For the rigid duct wall assumption, the propagation velocity is identical to the free field sonic velocity. The sonic velocity for air is approximately

$$c = 49.02 \sqrt{T} \text{ ft/sec} \quad (3)$$

where: T = temperature, °R.

It is well known in the pulsation analyses of liquid system that pipe wall expansion flexibility can cause a reduction of the velocity of propagation by reducing the effective bulk modulus of the fluid in the pipe. A similar evaluation conducted on the effects of typical duct expansion due to wall flexure showed considerable reduction in propagation velocity depending upon both duct wall flexibility and resonances. Assuming air at standard pressure and first mode expansion of the duct wall, an equation was derived for modifying the velocity of propagation as follows:

$$a = 49.02 \sqrt{T} \left[ 1 + \frac{1.143 \times 10^{-8} \left( \frac{w^5 \kappa_w}{I_w} + \frac{h^5 \kappa_h}{I_h} \right) \right]^{-1/2} \text{ ft/sec (4)}$$

where: h = duct height (inches)  
 w = duct width (inches)  
 $I_w$  = wall section moment of inertia/unit duct length (inches<sup>3</sup>)  
 $\kappa_w$  = wall magnification factor dependent on resonant frequency to excitation frequency ratio.

At various sections in one duct system evaluated, propagation velocities were reduced by 3% to 25% without including the effects of wall resonances. A large reduction in acoustic velocity due to duct wall flexibility and resonances may be an indication that stiffer walls should be used. In some cases, modeling of the entire duct system including duct wall flexibilities and resonances prior to construction could be useful in identification of potential duct acoustical problems.

## CONCLUSIONS

The four cases discussed in this paper identify problem areas, interactions in fan systems, and techniques required for their identification and solution. This information provides practical guidelines for analysis and solution which is summarized below.

1. Vibration problems are sometimes due to a complex interaction between various parts of the fan-duct-foundation system.
2. Natural frequencies near the running speed can cause severe amplification of the forces in the system and result in excessive vibrations and sensitivity to small changes. A combined analytical investigation and field study utilizing specialized equipment is often required to analyze interaction problems that involve the entire system.
3. Disc wobble resonance is a vibration problem that is unique to centrifugal fans as it is caused by excessive flexibility of the support disc. Fan manufacturers usually provide sufficient disc thickness to avoid this resonance, but it is a potential problem area for fans with uprated speed or flow. All centrifugal fans should be checked during manufacture for disc wobble resonance. A stiffening plate may be required to provide a reliable long-term fix for fans with these problems.
4. Blasting and excavation during construction may reduce soil stiffness properties such that foundation resonances occur too near running speed. Actual "as installed" soil stiffnesses can be defined by conducting shaker tests and fitting the results to a parametric variation of a computer model.
5. Fan shaft "installed resonant frequency" as defined by the AMCA should be used in the design or specification of fan systems as this is the most meaningful for

vibration sensitivity. Installed resonant frequency should have a 20% margin from running speed. Care should be used in the application of gyroscopic effects in the calculation of critical speed margins.

6. Least squares optimum balancing in one or two planes has definite advantages for minimizing vibrations for fans with critical speed, foundation resonance, and disc wobble resonance problems. The least squares technique allows minimization of vibration at many points rather than at just one or two points.
7. When balancing, all extraneous influences need to be eliminated. For sensitive systems, alignment specifications should be tightened and interaction from adjacent units should be averaged out by plotting phase and amplitude through several interaction periods. Balancing to reduce thermal distortion requires waiting for the rotor to thermally stabilize which may take 12 or more hours. Balancing with data taken before thermal stabilization or without minimizing extraneous influences may result in ineffective correction.
8. Rotating stall can be caused by an inlet air incident angle mismatch at the blades (often the result of improper pre-swirl). Pulsation frequencies generated by rotating stall generally occur at multiples of one-third shaft speed. A vortex throughout the inlet box has been identified as the cause of improper pre-swirl and rotating stall in one case. A splitter plate installed in the inlet destroyed the vortex and eliminated the vibration failure problem.
9. The mode shapes of troublesome acoustic resonances can be traced out with a two-channel FFT analyzer. These mode shapes are helpful in identifying the problem and in locating acoustic absorbers or other pulsation attenuation devices.
10. The use of the analog simulator permits determination of acoustical responses of the fan-duct system and development of effective means for control of undesirable acoustic resonances.

## REFERENCES

1. Roark, R. J., *Formulas for Stress and Strain*, 2nd ed, (New York: McGraw Hill, 1943), p. 191.
2. Goodman, Thomas P., "A Least-Square Method for Computing Balance Corrections," *Journal of Engineering for Industry*, Trans. ASME, Series B, Vol. 86, No. 3, Aug. 1964, pp. 273-279.
3. "Power Plant Fans Specification Guidelines," Air Movement and Control Association, Publication 801, 1977.
4. Gilkey, C. H., et al, "Centrifugal Fan/Duct Systems Vibrations," ASME Paper 74-WA/DE-30.

