

ARC: 301.54
G655

TA/OST 75-26

FEASIBILITY TEST OF AN APPROACH AND PROTOTYPE FOR ULTRA LOW COST HOUSING

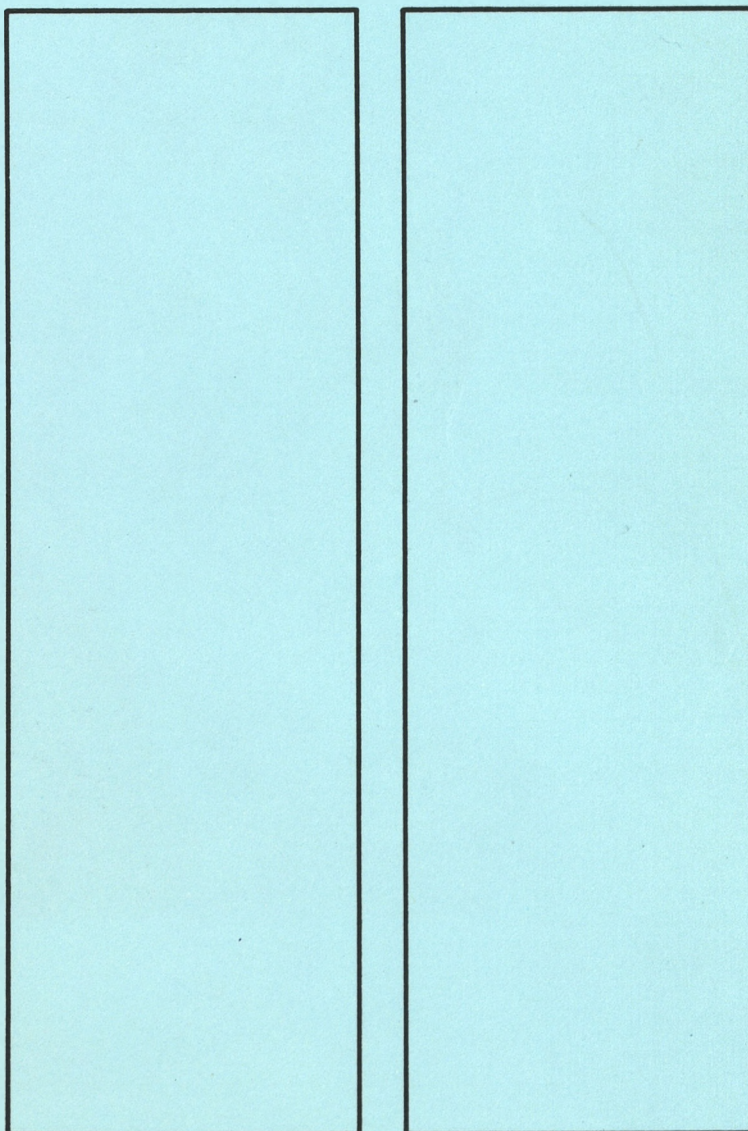

Office of Science and Technology
Technical Assistance Bureau
Agency for International Development
Washington, D.C. 20523

NOVEMBER 1975



FEASIBILITY TEST OF AN APPROACH AND
PROTOTYPE FOR ULTRA LOW COST HOUSING

FINAL REPORT

submitted by

Interdisciplinary Working Party
Carnegie Mellon University
Pittsburgh, Pennsylvania 15213

to the

Office of Science and Technology
Technical Assistance Bureau
Agency for International Development
Department of State
Washington, D.C. 20523

CMU Co-Principal Investigators

Charles H. Goodspeed, Ph.D.
Asst. Professor, Department of
Civil Engineering, CMU

Volker H. Hartkopf
Director, Advanced
Building Studies, CMU

Consultants

Frederick C. Cuny
Partner-In-Charge
INTERTECT
Dallas, Texas

Vijai P. Singh, Ph.D.
Assoc. Professor of Sociology
University of Pittsburgh
Pittsburgh, Pennsylvania

Carnegie Mellon University Proposal No. 08078
AID contract No. AID/ta-C-1174, dated Feb. 24, 1975
AID Project Manager, William H. Littlewood, TA/OST

November, 1975

TABLE OF CONTENTS

Part I	The Structure Report	
A.	<u>Introduction</u>	
I.	Background	1
II.	Approach	2
III.	Design Constraints	3
B.	<u>Technical Data</u>	
I.	Description of the Structure	6
II.	Technical Data	7
III.	Computer Verification of Design Feasibility ...	9
IV.	Selection of Materials.....	11
V.	Material Tests	12
VI.	Instructional Material.....	12
C.	<u>Field Tests</u>	
I.	Site Tests	13
II.	Component Construction Tests.....	20
III.	Construction Procedure Evaluations	23
IV.	Problems.....	24
V.	Cultural Acceptability.....	25
VI.	Voluntary Agency Evaluations.....	27
D.	<u>OTHER HOUSING ACTIVITIES IN BANGLADESH</u>	
I.	Replacement Housing	
A.	Care CINVA-Ram Houses	29
B.	Care Jute-Polyester Resin Structures	31
C.	CDF Housing Project.....	32
D.	Australian Baptist Housing Project.....	33
E.	MAP Housing Project.....	34
II.	Refugee Camp Housing	
A.	World Vision Housing Program.....	36
B.	Presbyterian Mission Housing Project.....	36

List of Figures

<u>Figure</u>	<u>Description</u>	<u>Page</u>
1	Carnegie Mellon University Model	6
2	A-Frame	7
3	A-Frame Elevations	8
4	A-Frame Cross Section	9
5	A-Frame Cross Section	9
6	Stress Input	10
7	Bandar Project	14
8	Pabna Project	15
9	Mirpur Housing Project	17
10	Bustee Camp (Demra)	19
11	Bustee Camp (Tongi)	19
12	Kunda	20
13	Diagonal Bracing	21
14	Roofing Tests	22
15	CARE Jute-polyester Resin Structures	31
16	CDF Housing Project	32
17	Australian Baptist Housing Project	33
18	MAP Housing Project	34
19	Bahari Bustee Camps	35
20	World Vision Housing Program	36
21	Presbyterian Mission Housing Project	36
22	Layout of Mirpur Project	75

Part I

INTRODUCTION

This report outlines the activities of the Carnegie-Mellon University/INTERTECT Refugee Housing Team under a grant funded by the Office of Science and Technology (TA/OST) entitled "Feasibility Test of an Approach and Prototype for Ultra Low-Cost Shelters." The report covers the period December 1974-August 1975 and specifically describes the work completed pursuant to that contract.

I. Background

Over the past two years, an interdisciplinary team of architects, engineers, planners and sociologists have developed a prototype ultra low-cost housing unit for use in a variety of relief and rural development situations, especially in disaster-prone areas of the developing countries. The structure is an "A" frame modular housing system which can use a wide variety of local indigenous materials in a structure which is extremely cheap, labor intensive, easily erected and which is wind and flood resistant.

Under a research contract, A.I.D. has provided funds to continue research of the structure and to test the unit in actual field conditions. Specifically, the grant provides funds to:

- Test the feasibility of the approach and a modified prototype ("II") for ultra low-cost shelter.
- Construct and evaluate Prototype II in a different relief situation, specifically, Bangladesh.
- Incorporate the test results in improved prototype designs and construction procedures. Include uneducated self-help, local materials, high wind, sun, rain and flood resistance, rapid construction, acceptability, and ease of upgrading or reduction back to the basic materials.
- Develop appropriate management procedures for large volume construction.

- Establish channels of communication and cooperation for the further development of prototypes, dissemination of the project's results, and promotion of utilization through mass construction projects.
- Maintain collaboration with major relief organizations such as A.I.D., CORR, OXFAM and CARE, and maintain the interdisciplinary approach.
- Maintain flexibility of approach, since differing needs, cultural patterns, availabilities of materials, geographic and climatic characteristics, changing nature of catastrophies, etc., all mitigate against a single, universally acceptable shelter prototype.

II. Approach

Due to regional variations in climate, topography and culture, no universally acceptable housing prototype is possible. Thus, the Working Party decided to concentrate its initial efforts in three areas: first, the development of a building process and methodology which can be applied to a wide variety of situations; second, the development of a prototype housing unit which could be built throughout large areas of the world with whatever materials were on hand locally; third, the introduction of technological processes to improve indigenous building techniques and construction practices. All were incorporated into a design program to produce an evolutionary shelter, a unit which provides immediate shelter for refugees and, with modifications, can be turned into a long-term house. By concentrating efforts on developing housing for refugees, who are traditionally the people on the lowest rung of the housing ladder, the resulting technologies could be applied to the problem of providing housing for the ultra low income urban and rural populations in the third world.

The team decided to concentrate its initial efforts on developing a prototype for tropical environments. Tropical housing was selected for several reasons:

- The majority of high density refugee situations occur in the tropical regions.
- Housing in tropical areas worldwide tends to utilize similar shapes, thus providing a strong cultural base from which to begin.
- Tropical areas have the greatest variety of materials with which to work.
- There were currently a number of active refugee operations on-going in tropical areas (Bangladesh, Indo-China, Philippines).

III. Design Constraints

A. Cost: An estimated cost of \$10 of shelter space per family* was derived by utilizing criteria obtained from the U. S. Agency for International Development (AID) and from costs typically allocated by relief organizations in recent operations. For the design to be acceptable, it had to contain the total cost of materials and labor within this limit. Similarly, the unit cost basis of other items such as sanitary facilities, stabilized soil, drainage ditches and water supply facilities, must be viewed as separate costs.

B. Use of Local Materials: The materials indigenous to tropical areas were the only structural materials considered in building the system. The structural flooring and roofing systems were designed so that modification required by material constraints in one system will not affect the details in the other systems. The framing system design for the structural member and the connecting materials had to be adaptable to the various structural strengths and sizes possessed by the materials. The flooring system had to accommodate similar variations in material properties by modification of design detail and not the entire floor framing system. An entire roof system consisting of framing and covering had to be devised for the various materials used due to the extreme difference in the material properties. It was the intent of the program to investigate many of the materials available for construction and document the necessary modifications as dictated by the material constraints. To ensure connection durability, it was necessary to transfer loads through contact of the members and not by the connecting material.

C. Environmental Problems: Many environmental conditions impose the controlling constraints in the design of refugee shelters. Flooding, wind and heat of the tropical zone induce extensive loading and design problems. Many areas of the tropics are at an elevation of only a few feet above sea level with a ground water table 9 to 18 inches below the ground surface. During tropical rains, extensive flooding occurs which must be considered in the shelter system design. The high temperature and humidity of the tropical zones necessitate the need for adequate ventilation. The building design must also consider methods for preventing the building material from rotting under the prevalent conditions of heat, water and moisture.

*This cost was later changed to \$10 per person to allow for inflation in Bangladesh. This allowance is comparable to monies currently allocated for housing per capita by VOLAGS in Bangladesh. The per family figure is, however, still applicable in many other tropical areas.

D. Ease of Administration: With the vast numbers of people in refugee camps, it is imperative that administrative personnel be able to make frequent checks for illness and death throughout all structures. This requires that each living space be adequately lighted and easily accessible. Shelters must also be built to facilitate feeding and medical care for the occupants. The layout of the refugee camp as well as the shelter configuration must not only be acceptable to the administrative personnel but to the social and cultural patterns of the people.

E. Ease of Construction: For a shelter system design to be feasible, a specified number of units must be capable of being produced on a daily basis. Thus, the structural system must utilize a repetitive pattern in the framing. It is desirable to require various repetitive operations so that organized teams with only limited skills can mass produce the components of the building. By using repetitive operations, administrative personnel can set up rigs or patterns in which uniform components can be produced. The erection process must also facilitate the scheduling of continuous work for each team.

F. Behavioral Constraints: While the emotional and physical status of refugees varies greatly according to the nature of the disaster and the time the people have been refugees, certain generalizations may be made concerning their behavioral aspects. In his study, Refugee Camps & Camp Planning,* Frederick Cuny identifies the phases of personal adjustment that refugees undergo in refugee camps. The general improvement of emotional and behavioral aspects is seen to be a function of stability, organization, involvement and improvement of the physical environment. The Working Party addressed these functions in the design program for the prototype. First, the various behavioral aspects of refugees were outlined as design constraints. The constraints were then grouped under the functions outlined above. The results were as follows:

1. Stability: In order to encourage stability, the structure must be of a design similar to existing housing types or familiar to the region. Thus, the constraints identified which would promote stability were familiarity and similarity.

*Refugee Camps and Camp Planning, Frederick C. Cuny & Associates - INTERTECT, Dallas, Texas, 1971.

2. Organization: In order to be successful as relief housing, the structure must facilitate refugee organization. This requirement had to be met two ways. First, the unit had to lend itself to encouraging administration by design. In other words, the structure had to be designed from the viewpoint of a refugee camp administrator. Second, the structure itself had to be designed to be part of an organizational effort, i.e., it had to lend itself to mass production by the refugees themselves. To meet this requirement, the prototype had to be easy to understand, simple to build, and able to utilize pre-fabrication techniques.

3. Involvement: To be able to involve the refugees, the prime constraint was to design a structure that could be built with those tools, materials and building techniques with which rural people in the developing countries would be familiar. If the refugees couldn't use their own limited tools, in all likelihood the structure wouldn't be built.

4. Environmental Improvement: This was the most difficult aspect. Not only would the structure have to be able to reasonably withstand a hostile natural environment, it would also have to withstand a high density refugee camp environment with poor sanitation, inadequate health care and other accompanying detrimental factors. Within the camp environment, the structure had to provide a safe sanctuary for families, broken families and individuals alike. Furthermore, the unit had to be flexible enough to allow individual modifications or improvements by the occupants without substantially affecting the strength of the unit or altering any of the other functions of the structure.

These constraints were incorporated into the design program and each was met.

The ultimate size depends on the number of people who are to occupy the structure; the more people, the larger the structure. The normal living unit in the structure illustrated in this manual is the area, on both floors, between two full-sized A-frames.

Figure 2

A-Frame



It is recommended, however, that the structure not exceed seven normal units in length.

This structure is not unlike many structures currently used by people in the developing countries; in fact, it utilizes all those skills normally found in tropical areas as well as incorporating local building techniques. However, this unit maximizes the use of each type of material and reduces the overall costs by reducing the amount of material required. Thus, the unit is one which improves on local designs and streamlines construction.

II. Technical Data:

The shelter consists of three independent components: the main framing; the flooring; the roof framing and covering systems.

The main framing consists of the A-frames, diagonal bracings, a ridge pole and associated connections. The A-frame itself consists of two large wooden members notched and bound at the top to form a durable joint. The height and spacing of the frames can be modified when required by the structural strength of the members. The diagonal bracing between the A-frames is assembled separate from the roofing system. The connection details for the diagonal bracing resist either compressive or tensile forces depending on the properties of the diagonal members.

The flooring system consists of the floor and supporting beams and columns. The flooring configuration remains fixed with the construction details varying slightly depending on the material properties.

The beam-column connections for the flooring do not change but the spacing for the beams and columns vary with material properties. The column height and anchoring system is dependent on the expected local flooding conditions.

The roof framing and cover is totally dependent on the properties and utilization of the covering material, thus requiring distinct designs for the various covering materials. A means of venting was devised for the vertex of thatched roofs.

It is felt that the total system is flexible and can be modified to accommodate the various material, environmental, administrative, cultural and technical constraints. It incorporates building features which are common to both wood and bamboo structures. The design is simple enough to be built with no more than a machete.

It can be built entirely on site, or major components may be prefabricated by refugee work teams and hundreds of units can be built in a day. The structure incorporates features that provide privacy for the occupants but allow administrators to easily check for disease or malnutrition. Finally, the structure is designed to withstand the most severe tropical environment by incorporating such features as an optional second floor to provide temporary escape from flooding while serving a human function such as providing segregated space within the living unit for members of a single family.

The A-frame was selected as the optimum structural system offering the most versatility with respect to the constraints. The primary reason for selecting the A-frame is that it is the best shape for resisting wind loads. The A-frame was incorporated in both the length and width of the structure.

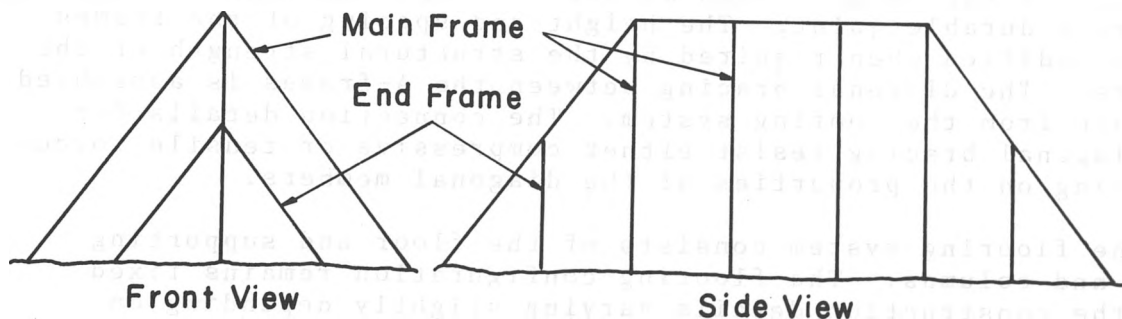
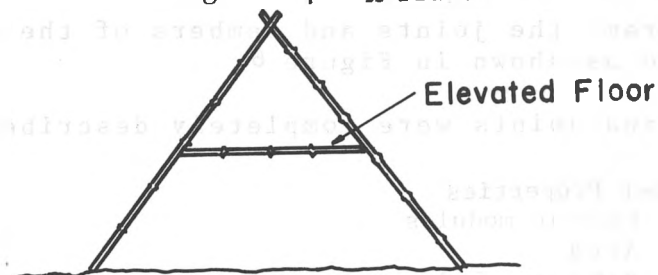

Figure 3 A-Frame Elevation

The structure was designed with two occupiable levels. The reasoning was twofold: (1) living space would be increased; (2) when flooding conditions exist, the elevated floor would provide an escape area.

Figure 4 A-Frame Cross Section



Columns were added to support the floor.

Figure 5 A-Frame Cross Section

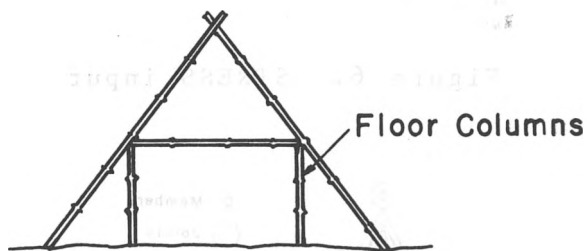

Materials are used to their greatest advantage in this design. Large components are kept to a minimum and rely on smaller pieces for supplementary strength. The flooring, stringers, cross-bracing and trusses are only one and one-half inches in diameter. Only the A-frames and columns are large members. The floor beam is an intermediate size.

III. Computer Verification of Design Feasibility

A. Stress Program: The analysis of framed structures deals with forces and displacements, given the makeup and orientation of all the members. The term "framed" structure is used to denote structures composed of slender elements, that is, members that can be represented by their centroidal axis and analyzed as line elements. The structure may extend in two or three dimensions, and at any joint the members may be pinned or rigidly connected.

In order to expedite the analysis phase of this project, a computer programming system known as STRESS (which is an abbreviation for Structural Engineering Systems Solver) was used. In STRESS, a problem is described by writing a number of statements specifying the nature and size of the

structure, the loads, a solution procedure and the results desired.*

In 1973-74 a STRESS problem was conducted on the initial design which used bamboo trusses for additional strength for the frame.** Bamboo in Bangladesh, however, was of sufficient size to warrant tests to determine if the trusses could be eliminated.

For the program, the joints and members of the structure were numbered as shown in Figure 6:

The members and joints were completely described by listing:

1. Member Properties
 - a. Elastic modulus
 - b. Area
 - c. Moment of inertia
2. Joint coordinates
3. Member incidences

Figure 6. STRESS input

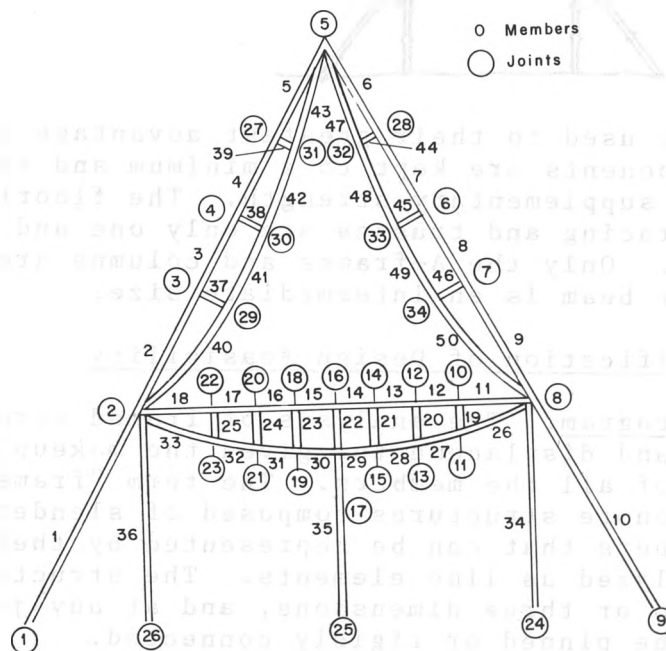

*STRESS Reference Manual, S. J. Fenves, R. D. Logcher, S. P. Mauch, the M.I.T. Press, Cambridge, Mass., June 1964.

**Report: "A Prototype Refugee Shelter," Carnegie-Mellon University, Interdisciplinary Working Party, 1974.

It was assumed from previous tests* that the minimum crushing strength of the bamboo to be used was 7,800 psi, the bending strength 7,800 psi, and the modulus of elasticity was 1,500,000 psi. The results are listed below:

Sample #1

<u>Top</u>	<u>Bottom</u>
O.D. = 1.09 in.	O.D. = 1.03 in.
I.D. = .69 in.	I.D. = .69 in.
Wall Thickness = .20 in.	Wall Thickness = .17 in.
Area = $\pi(r_1^2 - r_2^2) = .57 \text{ in.}^2$	Area = $.47 \text{ in.}^2$
$I = \frac{1}{4}\pi(r_1^4 - r_2^4) = .060 \text{ in.}^4$	$I = .046 \text{ in.}^4$
Length = 4.00 in.	

Sample #2

<u>Top</u>	<u>Bottom</u>
O.D. = 1.06 in.	O.D. = 1.06 in.
I.D. = .70 in.	I.D. = .73 in.
Wall Thickness = .18 in.	Wall Thickness = .165 in.
Area = $.50 \text{ in.}^2$	Area = $.453 \text{ in.}^2$
$I = .050 \text{ in.}^4$	$I = .047 \text{ in.}^4$
Length = 5.94 in.	

Sample #3

<u>Top</u>	<u>Bottom</u>
O.D. = .81 in.	O.D. = .84 in.
I.D. = .62 in.	I.D. = .65 in.
Wall Thickness = .095 in.	Wall Thickness = .095 in.
Area = $.22 \text{ in.}^2$	Area = $.21 \text{ in.}^2$
$I = .014 \text{ in.}^4$	$I = .019 \text{ in.}^4$
Length = 6.06 in.	

IV. Selection of Materials

It was decided at the beginning of the design phase that all components of the structure were to use only indigenous materials, materials which could be produced easily in the immediate region with unsophisticated techniques, or materials common to local use. In 1973-74 the team conducted a series of lab tests on bamboo and stabilized earth and a field test of the structure's adaptability to construction with wood and palm thatch. The results of those tests are reported in "A Prototype Refugee Shelter."**The field test in Bangladesh tested techniques and procedures for the use of:

- A. Frame - bamboo, jute ropes
- B. Roof - straw, bamboo and grass thatch
- C. Floor - split bamboo poles
- D. Binding - jute rope, coconut rope, bamboo withes, galvanized wire.

*Report: "A Prototype Refugee Shelter," Carnegie-Mellon University, Interdisciplinary Working Party, 1974.

**Ibid

In addition, roofing consisting of sandwich panels made of bamboo mats with inner layers of plastic (polyethylene) sheeting were also built and are being tested.

V. Material Tests

A. Bamboo: During the period of this contract, no new laboratory tests were conducted on bamboo. In the field tests of the structures, the bamboo used were modified to determine longevity. There are three major classes of bamboo in Bangladesh which are determined by the thickness of the wall of the culm. A first class bamboo is approximately 30-40' long, has a diameter of 6-8" and a wall thickness of up to 3 1/2". While this bamboo has extraordinary strength, it is difficult to bend and all joints must be cut or abutted. Thus, no tests were made on new bamboo joints.

B. Stabilized Earth Progress: During the period of this contract, new laboratory testing programs have been initiated on the stabilized soil. Work is in progress to determine the optimum percent of stabilizing chemical required for soils varying in percent composition of silt, clay and sand. Permeability tests have been run on stabilized soils. The results are disappointing in that the stabilized soils break down in time. Work has been initiated to develop a new cross-linking agent to retard this effect.

VI. Instructional Material: In preparing for the field work, the team completed work on an interim construction manual, alternate site plans for a community unit of a refugee camp using the structure, and a packet of supportive materials for use in the field.

FIELD TESTS

I. Site Tests

A. Prototypes -- Dr. Goodspeed and Mr. Mia erected two shelters with various modifications dictated by materials available at the sites. The first structure was built in Bandar for housing two families. The basic A-frame design was used. As the maximum flood protection required at the site was 3 feet, the elevation of the floor was constructed at 3 feet 6 inches, thus requiring a side entrance to the shelter. The roofing consisted of mats tied to the frame covered with thatch made of sungrass. Sufficient materials for the structure were available in the local markets.

The structure was erected by unskilled labor in a little over two days, including the time spent explaining the concept and various components comprising the shelter to local observers. Many of their building techniques were discussed and some implemented in the construction. A new thatching technique using a type of straw and bamboo did evolve from the work which may prove to be easier for mass production in large-scale operations. The technique consists of producing thatch shingles by binding the thatch between parallel strips of bamboo running perpendicular to the thatch.

Patterns made of jute rope were used both to construct the A-frames and to lay out the holes in which the frames were placed. This assured some degree of quality control in fabricating the A-frames as well as alignment during erection of the frames. The patterns or nets appear to be a necessity as none of the local laborers were able to lay out a right angle with any degree of accuracy.

The diagonal bracing and thatching members were attached without modification from previous plans. The roof covering consisted of construction mats on which the thatch shingles were tied. The shingles were made at random lengths; as they were tied on, excess lengths were trimmed off and used to start the next row.

Two families moved into the structure shortly after completion. They were generally pleased with the unit and to date have made no modifications to the shelter. In talking with local people, it is apparent that our shelter, on a \$/sq.ft. basis, is cheaper than similar housing construction. The cost of materials for the first prototype is as follows:

1 - 1 1/2"	Dry thin-walled bamboo	1.¢/ft.
1 - 1 1/2"	Green thick-walled bamboo	1.¢/ft.
A-frame	Members thick-walled 1"+	3.¢/ft.
thatch	2 1/2" - 3" diameter bundle	6.5¢/bundle
jute	multistrain rope,	
	approx. 40 lbs. total	32¢/lb.
wire	1/32" diameter total	approx. 1.¢/ft.
mat	8 x 8 finish mat	\$1.50/mat

Figure 7. Bandar Project



Figure 8. Pabna Project



All prices have increased approximately 500% in the past 2 years. The total cost for this two-family unit was approximately \$200.00. Modifications of the initial design were thus developed to reduce this cost as follows:

1. Jute ropes will be used in place of bamboo for the diagonal bracing; also, jute ropes can be used as horizontal stringers between A-frame for attaching the thatch (1" - 1 1/2" bamboo was used before);
2. Roofing will be constructed using only thatch, thus eliminating the high cost of mats;
3. Overall height of the structure will be reduced consistent with sizes of typical single-family structures in Bangladesh.

The second shelter was built in Pabna, approximately 150 miles north of Dacca. This shelter was for 1 1/2 families and incorporated some of the above modifications. The construction site was on high ground above flood stage; therefore, the floor was omitted.

The total cost of this shelter was approximately \$70. Modification (1) was only partially implemented, thus the total possible cost savings was not appreciated. The common

practice of people living on a built-up plinth allows the elimination of the high cost of bamboo flooring. A model illustrating all the modifications was constructed in Bangladesh for use as a training aid and for demonstration purposes. In addition, revisions to the construction manual were made which incorporated the modifications gleaned from the prototype tests.

B. Field Tests in Actual Relief Situations -- A number of structures were built in actual relief or refugee situations following the prototype construction program. After careful selection, sites were chosen in each of the major relief camps in the Dacca area and structures were erected under the supervision of one of the team members. A brief description of each project follows:

1. Mirpur Bahari Camp CMU (N.Dacca)--- In a project funded by OXFAM, the CMU - INTERTECT team initiated a construction program which involves the provision of up to 80 family units in 23 structures as part of a joint OXFAM-Mennonite Central Committee- UNICEF- CMU program to rehabilitate a 100-yard square section of the Bihari Camp. The team developed a basic site plan for the development of the area, supervised the site preparation, trained a team of Bihari residents to build the structures, and supervised the construction of the first unit. Remaining units will be built by the Biharis under the supervision of the Mennonite Central Committee field representative and a local Bengali architect who was trained to take over the project. The structures will be a variety of sizes from small, two-family units to one large seven-family unit. Some will have two floors, but most will have only a mud plinth. All are constructed with bamboo frames, bamboo mats and jute rope cross-braces. (A complete description of the project is contained in Appendix I excerpts from "Request for a Capital Grant from OXFAM.")

These structures are designed to be long-term replacement housing in a refugee camp environment.

2. Demra Bustee Camp (10 miles south of Dacca) -- The Bangladesh Red Cross funded the construction of one two-family unit at the Demra Camp. The object of this test was to test the costs (Tk 500 per family) and the stability of the unit under high wind conditions and in a refugee camp environment. The structure is made of bamboo frames with a sungrass covering. The staff sited the structure, trained a team to construct it and provided occasional supervision to the construction team. This project was also supported by the League of Red Cross Societies.

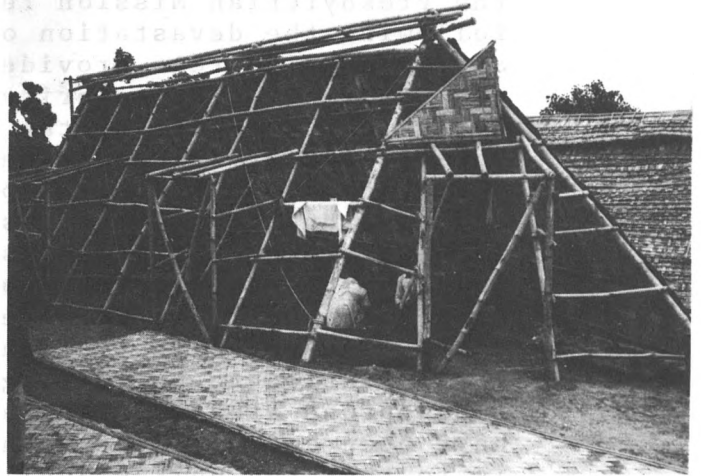
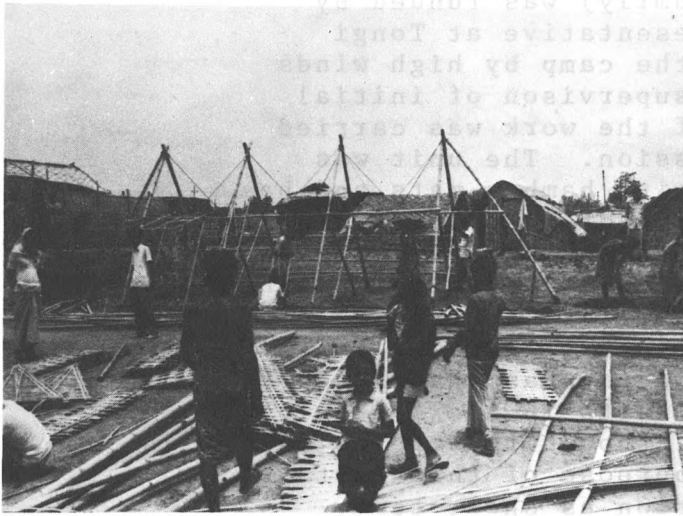

3. Tongi Bustee Camp (20 miles north of Dacca) -- One demonstration unit (two-family) was funded by the Presbyterian Mission representative at Tongi following the devastation of the camp by high winds and rain. The team provided supervision of initial construction. The majority of the work was carried out by a contractor of the Mission. The unit was constructed of bamboo frames with bamboo mats and has a 3-foot bamboo floor. Support for the project and continuing interest has been provided by HEED and the Bangladesh Red Cross as well as the camp's engineer. Originally designed for two families, four now occupy the unit due to severe lack of housing in the camp. The government of Bangladesh has announced its intention to build larger units in the low-lying, flood-prone areas of the camp, though to date no funds have been appropriated. The purpose of this test is to test the unit's application as short-term, interim housing in a flood-prone refugee camp environment.

C. Village or Rural Housing -- Two units were constructed in a project funded by the Community Development Foundation/ Save the Children Federation at the village of Kunda in the Comilla District. The sites were selected by the CDF local representatives as were the families who were to receive the structures. The purpose of the project was to test the structure as a long-term replacement unit for structures destroyed in natural disasters in rural areas and to test acceptability by local residents. The site selected is one which is repeatedly struck by floods and cyclones, thus the environmental suitability is also observable.

The staff provided a trained Bengali team and also trained several local people in the construction procedure. One team member supervised the construction of the frames but left the finishing to the local people. The units were built of bamboo frames and sungrass thatching. The CDF will monitor the structures over the next two years and will provide the CMU team with their appraisal of the unit in this role.

In addition to these units, UNICEF contacted the team about constructing several large-size structures in the Mymensingh area for use as schools and auxiliary buildings. The Bengali architect trained by the staff will undertake this construction in the near future.

Figure 10. Bustee Camp (Demra)

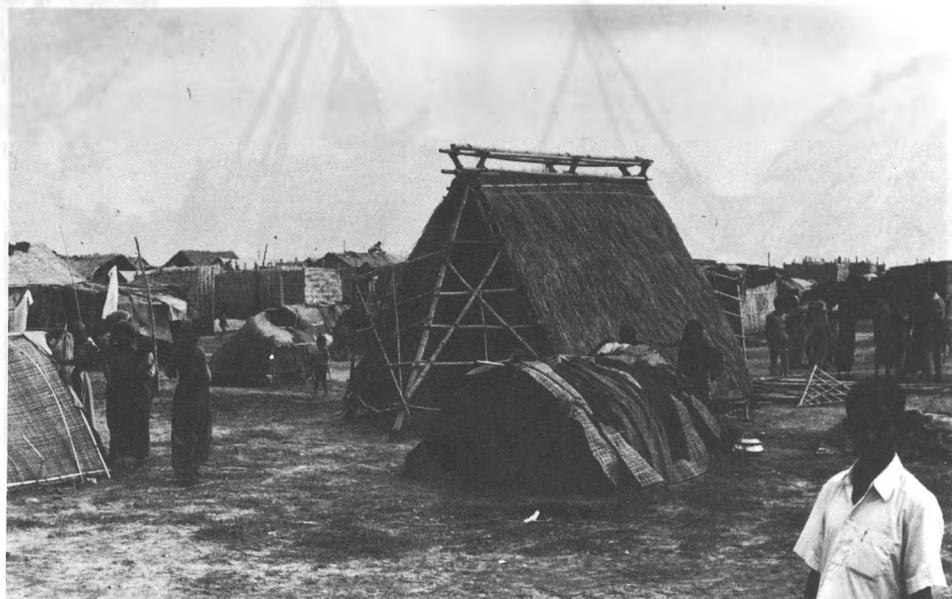

Figure 11. Bustee Camp (Tongi)



Figure 12. Kunda



II. Component Construction and Tests

A. Frame -- The A-frames of each structure were built with bamboo poles varying in diameter from 5-8" and cut to the appropriate lengths required by the individual structure. (As pointed out earlier, structures varied in size depending on the purpose of the test). All construction of the main frames followed the procedures established in the construction manual and no changes were necessary.

In the cross-bracing of the frames, several techniques were tested. First, braces were made from small, full culm pieces which were lashed to the main frames. In these tests, pieces of the long bamboo poles used for the frame which remained after cutting the frames to size were used. This was possible only on the shorter structures and made good use of the left-over material.

In the larger structures, two techniques were used, both of which were designed to reduce costs. The first method involved splitting the bamboo lengthwise. This required the acquisition of long pieces with thinner walls than those used for the A-frames. In an attempt to reduce this cost, a number of units (at Pabna and Mirpur) were constructed using "1/2" jute ropes for the cross braces. The costs, however, turned out to be the same and reports of excessive sagging stopped further construction with this method.

Figure 13. Diagonal Bracing

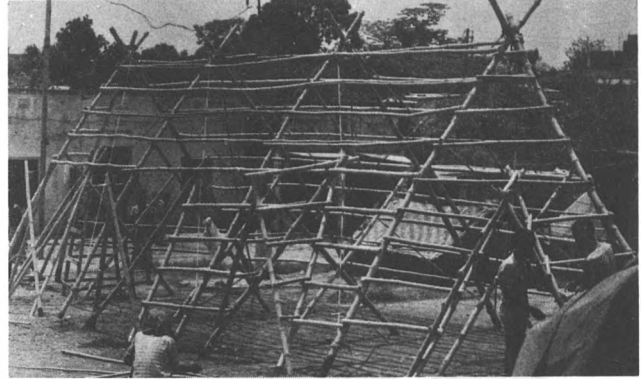
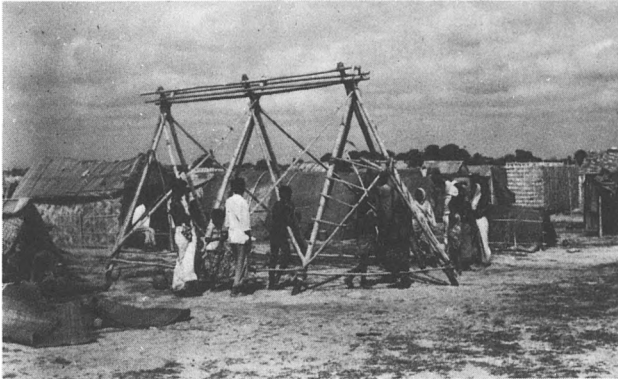

B. Roof

A variety of roofing techniques were tested, most using strictly indigenous materials but several using a combination of indigenous and synthetic.

Grass over bamboo mats: The prototype built at Pabna had a roof made of sungrass over woven bamboo mats. One half of the roof was thatched in a conventional manner, i.e., weaving and tying the grass directly to the mats. On the other side were shingles made of grass secured to bamboo frames which were attached to frame by pushing thatching wire through the bamboo mats (See Figure 14). The latter method proved to be the strongest but the most expensive. Grass shingles were also used on the structure at Demra and the units at Kunda though no other mats were used.

Sungrass Thatch: This unit was constructed using the traditional Bengali rural thatching procedures. Only grass, tied directly to the frame, was used. This procedure reduced the overall costs approximately 30% but it is felt that strength and durability have been sacrificed.

Bamboo Shingles: At the Tongi Bustee Camp, and in the first block of structures at the Mirpur Non-local Camp, bamboo shingles made of split, thin culm bamboos were used. These were tied directly to the frame. This proved to be the most expensive method using strictly local materials but offers the most strength. At Mirpur there were complaints that the roofs leaked during the first rains but once the bamboo had swelled the leaks stopped.

Bamboo/Plastic Sandwich Panels: At Mirpur a number of structures were covered with large panels made of reinforced polyethylene sheets sandwiched between two bamboo mats. This method proved to be the favorite with the occupants (ICRC had built a number of structures earlier using this technique for roofs and it was very popular).

ROOFING TESTS

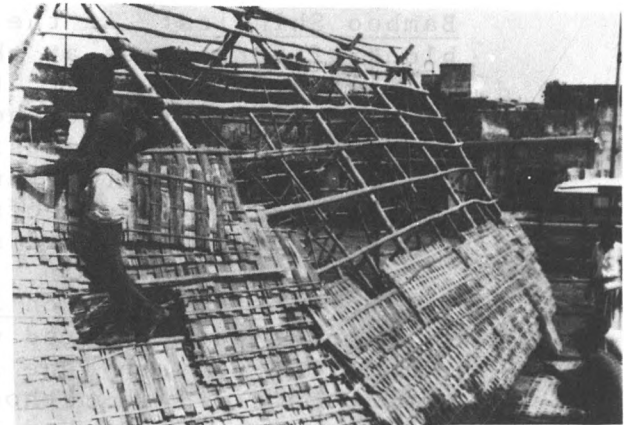
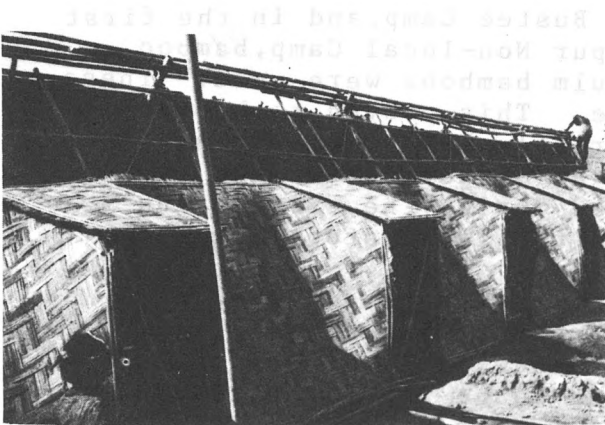
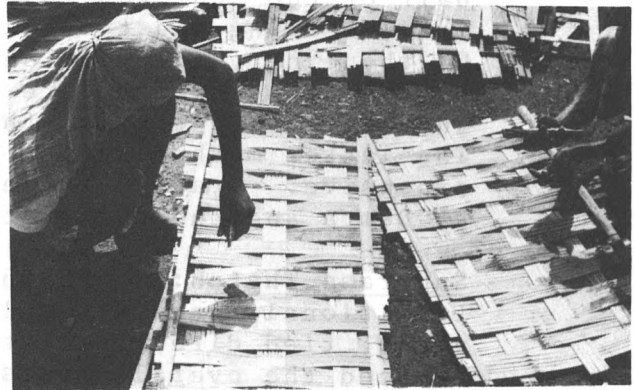
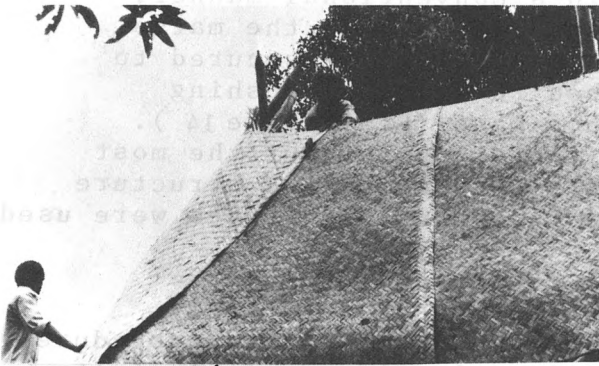
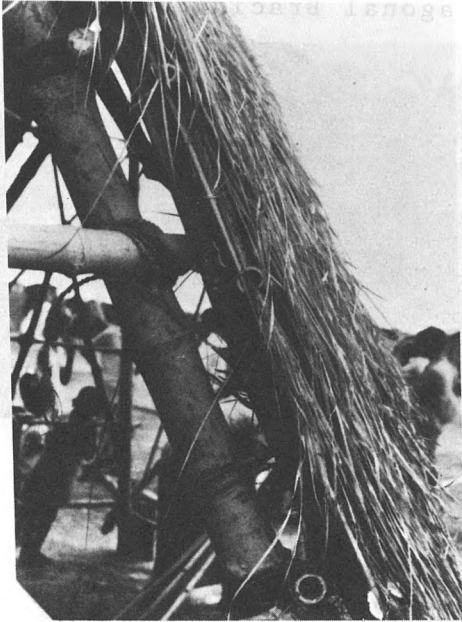

C. Floors -- Floors were installed according to the flood level. In most cases the normal method of building a mud plinth was used as it is the most common and acceptable method to the Bengalis. In the structure at Bandar and the unit at Tongi as well as two units at Mirpur, the floor was installed 6-12" above the known flood level. The floor was constructed of split bamboos placed on bamboo supports.

In four structures at Mirpur a second floor was added to increase the floor/storage area of the structures. This practice was discontinued in later units as there was no danger of flooding and residents complained that it made the rooms too small.

It was found that elimination of bamboo floors decreased costs by 10-15% and decreased construction time.

D. Binding -- Three types of binding were used in the field tests. For the main frames and cross bracing jute ropes, coconut ropes, bamboo withes, and wire were all tried, with the last two proving the best. For attaching the roof frame, jute fibres, coconut rope, sisal twine, and wire were used, the two latter being the most durable and easiest to work with. All shingles were made with wire bindings and were in turn secured with wire. There was no significant difference in the cost of wire and the other materials.

E. Bamboo Treatments -- All bamboo purchased for the tests were untreated except by soakage (most bamboo in Bangladesh is floated in large rafts to the distribution point. In areas where the water is brackish this serves to give it some material protection, but in other areas the bamboo is prone to various fungi and rot).

In the Bandar, Pabna and Mirpur structures all pieces touching the ground were treated with coal tar, a solution used locally to protect bamboo.

III. Construction Procedure Evaluations

During all construction, the construction manuals were used. After trying a variety of formats, including drawings and photographs, a take-apart model was built to help explain the concept. While the basic procedures and construction sequence proved adequate, the manual was less than a success with the Bengalis. Biharis, on the other hand, had no problems with it.

*See The Use of Bamboo and Reeds in Building Construction, U. N. Publication #ST/50A/113.

The nets which were designed to facilitate and speed up the layout of the unit were not adequately tested as they were never tried in a mass production scheme. As the size of structures varied considerably from site to site, the nets which were prepared saw little use. The general construction procedure, however, proved to be easily understood by the workers and there were no major problems in construction after the initial unit on each site was erected.

IV. Problems

During the course of the field tests, few problems were encountered. The ones which did arise can be generally classified as structural problems and cultural problems.

Structural Problems: Surprisingly, few major problems occurred concerning the unit itself. The few structural problems were easily overcome by on-site modifications. However, three distinct problems did arise.

The first is that of cost. As already mentioned, prices of materials have increased up to 500% in four years and as much as 150% since last fall. Thus, bamboo, while readily available, was much more expensive than our original estimates. The team was able to reduce costs in the frame by using jute and hemp ropes, but it is not certain how long these will last. As for the roofing material, where grass thatch was available, it was well within the cost limitations; but as the grass only has a lifespan of one year, it was only used for short-term or interim structures or in areas where people could afford to recover their structure. In the more permanent structures, such as the ones in Mirpur Bihari Camp, a bamboo mat was constructed. Having to rely on bamboo for the entire unit made the large structures extremely expensive (\$60-\$70) per family unit. However, by scaling down the structures which did not require a second floor, we were able to put the costs of two-family units back down to the \$40 per family category. Any future efforts will include attempting to reduce costs further.

The other major problem faced regarding the structure was how best to convey the concept of the structure to those working on it. The manuals proved to be too cumbersome to use in training the work teams, and even literate team leaders ignored them, preferring to explain each step as they went along. To overcome this problem, the staff contacted several persons who prepare training aids for the Integrated Rural Development Program (IRDP) health and agricultural projects. They suggested that the best low-cost media they

had found were flip charts. Based on their recommendations, the team proposes to drop production of the basic construction handbook (not the instructor's handbook) and develop instead a mock-up of a flip-chart package which could be produced for field use.

Another problem concerned leakage in the structures following the first rains. In most cases this problem can be solved by lowering the edges of the air vent. In the other cases, it is felt that after several rains the thatch material will "cure" and leakages will stop. The staff at Mirpur reports that the occupants of units built with the bamboo shingles have made some small adjustments to the roof and virtually all leakage has ended. In the case of the structures at Pabna and Demra, however, the thatch is too thin and no underlying mats were used. It is felt that if mats are installed, the leakage will cease.

In most construction, the staff built, or directed construction of, only the superstructure of the unit, i.e., frame, roof, raised bamboo floor. It was expected that the occupants themselves would build raised mud floors and drainage in areas where this was the custom. Only in a few instances has this been done despite complaints that water enters from the bottom. In future tests the team will insure that these are installed in the course of construction.

V. Cultural Acceptability

In June of 1975 Dr. Vijai Singh, a sociologist from the University of Pittsburgh, visited a number of the test sites to evaluate the cultural acceptability of the units in their various roles and to report on their status several months after occupancy. The main focus of the cultural evaluation involved:

- Cultural Acceptability
- Modifications to the structure made or requested by the occupants/agencies
- The ability of the occupants to repair and maintain the structures
- Exploring attitudes of occupants to determine methods of facilitating self-help.

A. Acceptability -- The architectural acceptability of the structure and space utilization constitute two important cultural components. As far as the architectural aspect, both Bengalis as well as Biharis expressed their general disapproval because these types of structures

were not found in this area* and they were too tall.** Residents commented that the small thatch that covers the vent and the continuous contraction of space from the ground to the roof are rare in the traditional Bengali architecture. The popular rural housing structures involve four walls on the ground even though there is some variation in roofing patterns. For instance, most of the brick houses have flat roofs and others are elevated in the middle.

It is felt that the overall acceptability of the CMU structures can be improved by lowering their heights and changing them in appearance to conform to the traditional structures.

They all complained about inadequate space inside the structures and charged that they were built without any consideration of the needs of the families living in them. Most complaints centered on lack of storage and kitchen space. The problems will be worked out for single family units in the coming year but will remain problems for the multi-family units in the camps. One approach for the camp environments has been to build common cooking areas within blocks of the structures (see Mirpur site plan, Appendix I, Figure 22). The same can be done for bathing areas when they cannot be placed inside the structure.

B. Modifications -- Few modifications were made by the occupants from the time of construction to Dr. Singh's visit; however, some comments were made as to possible changes.

Residents felt that the windows were a little too high in Mirpur, Pabna and Demra. They should be lowered so that there is some air flow at the floor level. At present, it is difficult to sleep inside in hot and humid weather. Split or thin bamboo can be used as a protection to prevent small dogs and cats from coming in through the windows.

Despite a number of different door styles that were tried, none proved popular and all residents suggested a bigger entrance and a door that can be shut and locked.

*Some residents commented that they looked like "Christian churches," though these feelings might have been influenced by their understanding that these projects are financed by the Westerners and they also provide technical assistance.

**Residents of units with elevated second floors had no complaints.

C. Maintenance -- The technology used is consistent with the local technology and most people can repair their structures without too much difficulty.

One fear expressed is that, when split bamboo breaks or one of them moves from its original position, it is difficult to repair or replace them. The steel wires are costly to replace. Therefore, split bamboo and steel wires should be used as little as possible.

D. Self-help -- Despite some of the problems they were facing, Dr. Singh reports a lack of enthusiasm to do something about them on their own. For instance, they could elevate the floor of the structures and build drainage around them to alleviate the problem of seepage around the bottom, but they wanted relief organizations or other concerned individuals to come and help them. Some steps should be taken to promote a sense of "self-help" in them which is so desperately needed.

For instance, residents complained about the lack of contacts and communication between them and the construction team from Pittsburgh. They said that they did not have any opportunity to express their ideas and preferences about the structures. They resented the fact that some "local elites" acted as contact men who had little familiarity with the problems facing refugees. They also felt that the "middle men" were charging high prices for building materials, thereby reducing flexibility in design. All these factors could have been explored and dealt with had an occupants' committee or some other participating mechanism been set up.

VI. VOLAG Evaluations/Comments

The agencies which sponsored each of the units were asked to provide a continuous evaluation of the unit(s) erected under their auspices. Immediately after construction and then at six-month intervals for a period of two years, each VOLAG sends a Housing Evaluation Form on which problems concerning, or modifications to, the unit are reported. The evaluations received to date are outlined in Appendix II. In addition, the Mennonite Central Committee has been reporting monthly on the large Mirpur project. These reports are also included.

OTHER HOUSING ACTIVITIES IN BANGLADESH

In order to provide a basis of comparison of costs, techniques, and cultural acceptability, a number of housing projects conducted by the voluntary agencies in Bangladesh were visited and analyzed. It should be noted that the purpose was not to critique these activities; the visits were only for comparative data. They are classified according to their role as refugee camp housing or replacement housing. It should also be noted that all costs are based on costs at the time of each project. Material costs have inflated at approximately 100% per year since independence. No costs mentioned reflect the 1975 devaluation.

I. Replacement Housing -- CARE, CINVA-Ram Housing Project*

In March 1973, a 62-Village Model Housing Project undertaken by CARE in conjunction with the Ministry of Relief & Rehabilitation was completed. A total of 8600 houses were constructed in 62 villages, one in each sub-division of Bangladesh, between March 1, 1972 and March 22, 1973.

Villages were selected in each sub-division by the District Commissioner on the basis of the destruction caused by the 1971 cyclone or during the War of Liberation, and though the target was 125 houses in each village, in some as many as 200 were constructed due to excessive damage to original housing. Participants were selected by local and government officials in conjunction with CARE on the basis of greatest need.

The main objectives of the project were to provide immediate and permanent storm and flood resistant housing and to demonstrate the effectiveness of CINVA-Ram construction.

Originally it was intended that CARE would provide all bricks, cement and C.G.I. sheets. The participant would provide the labor required for making the blocks, 150 cft. of soil, 100 cft. of sand and 12 cft. of timber for the roof, windows and door frames. It was found, however, that participants could not provide timber and so, except for doors and windows, this was supplied by CARE.

One of the major problems during the project was supply and logistics. Cement was purchased from Japan and India, often on erratic delivery schedules. OXFAM provided Indian C.G.I. sheets and ridging was locally produced from imported plain sheets. Delivery to units was done mainly by rail to the nearest distribution point and from there either by CARE Bedford truck of which they purchased fifteen, locally assembled, or by U.N. trucks borrowed from the local DC or the United Nations. Some shipping to the delta areas was done by coaster, however, ultimately country boats were found to be more reliable. Many of the North Bengal villages could only be reached by broad-gauge railway which meant shipping supplies from Chittagong to Khulna by boat, then to North Bengal by train.

As much as possible, local contractors were used for the supply of bricks, timber, masons and carpenters, though often timber had to be brought from other parts of the country due to shortages.

*Data obtained from a CARE report by R. I. Smillie, May 1973

Storage space and accommodation for CARE staff was usually provided by the village under construction and Unit headquarters space was provided by the D.C. - staff such as storekeepers, messengers, chowkidars and drivers were hired locally both at Unit offices and at the village level, not to mention labor engaged at railway stations, river ports and construction sites.

Materials

	<u>Per House</u>	<u>Total</u>
Cement (producing 10 million CINVA-Ram blocks)	20 bags	8600 tons
C.G.I. Sheets	18 pieces	1300 tons
Ridging	24 running ft.	40 tons
Timber	22 cft	190000 cft
Bricks	1000	8600000
Steel Rod	52 rft.	86 tons

In addition, several tons of nails, screws and washers were used. Five hundred CINVA-Ram block making machines, some produced in Dacca and Comilla, as well as several hundred soil screens were used. There was a fleet of over 50 vehicles, some owned by CARE, some loaned by the Government, by OXFAM and by UNROD.

Many hidden costs connected with the 62-Village Project were covered by the participants - much of the labor, movement of supplies, assistance to mason and bricklayers, provision of sand, soil and wood for doors and windows. The village usually provided accommodation and office space. The Government of Bangladesh provided logistical support, free rail movement of many hundred tons of supplies, exemption from many charges and taxes and was able to second many staff from the Low Cost Housing Department to provide the necessary skills and experience required in such a project.

The total expenditure on the 62-Village Project was roughly Tk.18.7 million or \$2.5 million, at a cost of approximately Tk.2180 per house. Of the amounts, roughly Tk.525 (\$70) was spent on imported goods. The balance was devoted to local purchases and costs.

CARE Jute-polyester Resin Structures - Bill Woudenberg of CARE is currently experimenting with a process for developing prefabricated structures which utilize the material most found in abundance in Bangladesh; jute. The process is similar to working with fiberglass. First, a wooden mold is made for producing the prefabricated panels. Jute cloth is layed on the mold, saturated with polyester resin by means of a spray gun and then the process repeated. After the desired thickness is achieved, a final pigment coat is added to give color; the panel is cured, then taken off the mold and is ready for use.

There is no uniform design for the panels--any form may be used and a number of designs have been tested. Each panel has a flange so it can be bolted to the next; thus virtually any size structures can be built. Woudenberg estimates that the lifespan of the structure is easily 30 years without maintenance. It is estimated that the unit can withstand winds of 160 mph.

The biggest drawback is cost; thus the structures are not used as housing, rather as public buildings such as schools, clinics, godowns (warehouses), etc. The estimated cost is \$4 per square foot. Recent schools built with this process, 20' x 77', cost approximately \$4,600.

Figure 15

CARE Jute-polyester Resin Structures

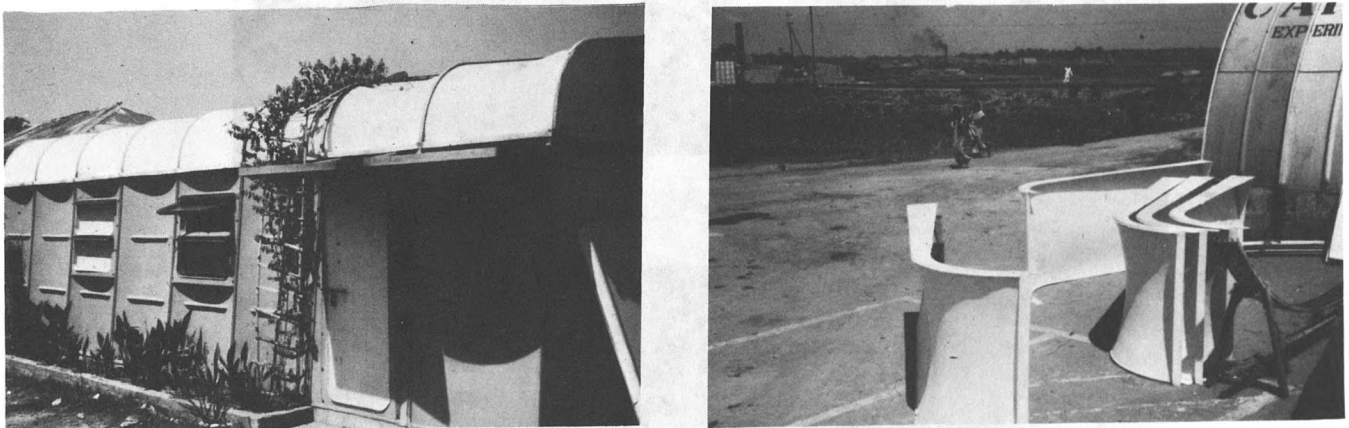

Figure 15
CARE Housing Project

Community Development Foundation Housing Project - The CDF housing project, which lasted from 1972 until mid-1973, rehoused approximately 3,000 families in units made entirely of local materials.

Funding for the project was provided by USAID. The money was channeled by CDF through the Thana Central Co-operative Association (TCCA). The local Thana officials selected the families who were generally those affected by the war who did not have a house. After review of the family situation, a process handled by TCCA, CDF, and AID, grants were provided to TCCA to purchase materials in bulk. (This was designed to stimulate participation with the Thana). These were then distributed to the individual families to build their own structures. Sites were chosen by the recipients themselves; in fact it was stipulated that they must own the land before they received the materials.

All units were constructed in two Thanas, Rangunia and Mesarai, both in Chittagong District. All recipients were responsible for building their structures and, as no technical or design assistance was provided, units varied in size and design. A typical structure would be a bamboo frame built on a raised plateau of earth stabilized with cow dung. The roof was made of thatched sungrass, the walls of woven bamboo mats. Erection time averaged three days per unit. Total cost of each unit was approximately \$70.



Figure 16
CDF Housing Project

Australian Baptist Housing Project - In August of 1974, the Australian Baptists, with the assistance of H.E.E.D., began construction of 300 single-family units of replacement housing for flood affected widows in the Mymensingh District. Recipients were selected by the union council of the Thana who owned sites where a previous structure had been.

The units, which are 20' x 10', are bamboo framed with bamboo mat walls. Roofs are made of 18 C.G.I. sheets. Total cost is approximately \$150 placed on a 3-4' mud plinth.

All structures are built by two teams of eight workers each; one team prepares the materials and site, the other erects the structure. Construction time is approximately 1-2 days. The teams were originally paid with food for work, but now each is paid approximately \$2 per day.

One interesting feature of the program is the practice of giving each widow a cow as well as the house. While this has served the purpose of providing an income (from sale of the milk), it has also made them more attractive as wives and a number now have remarried.

Figure 17

Australian Baptist Housing Project

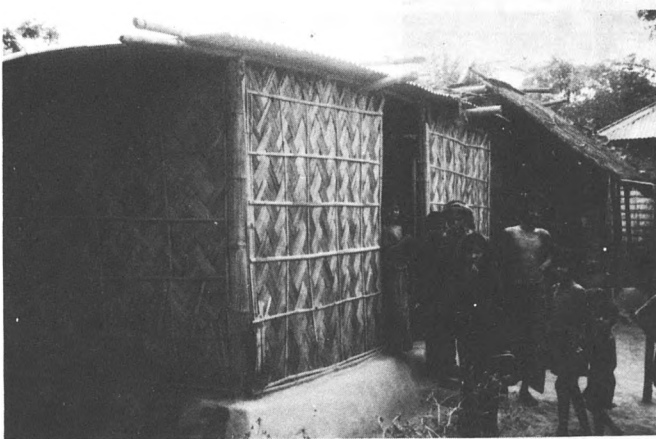

MAP Housing Project - The Medical Assistance Programs (MAP) Wheaton, Illinois, received a grant of \$900,000 from the U. S. Agency for International Development, Obligation #6226317, early in 1972. During April and May, 1972, twenty-four MAP team members carried out a variety of relief and rehabilitation projects in Bangladesh, including a housing project. The group improvised the construction of thousands of bamboo and thatch houses. AID provided \$522,025 for this part of the project. The type of house selected was the standard village home. Work concentrated in the high risk Chittagong District; over 4,000 homes were built.

The approach did not attempt to improve or strengthen existing housing designs, thus the same type of housing was constructed which failed before in the high exposure environment. It should be pointed out that the project was concluded well in advance of the Carnegie Mellon University team arrival. Therefore, a detailed evaluation of the performance of these houses was not possible, since they are not distinguishable from indigenous housing.

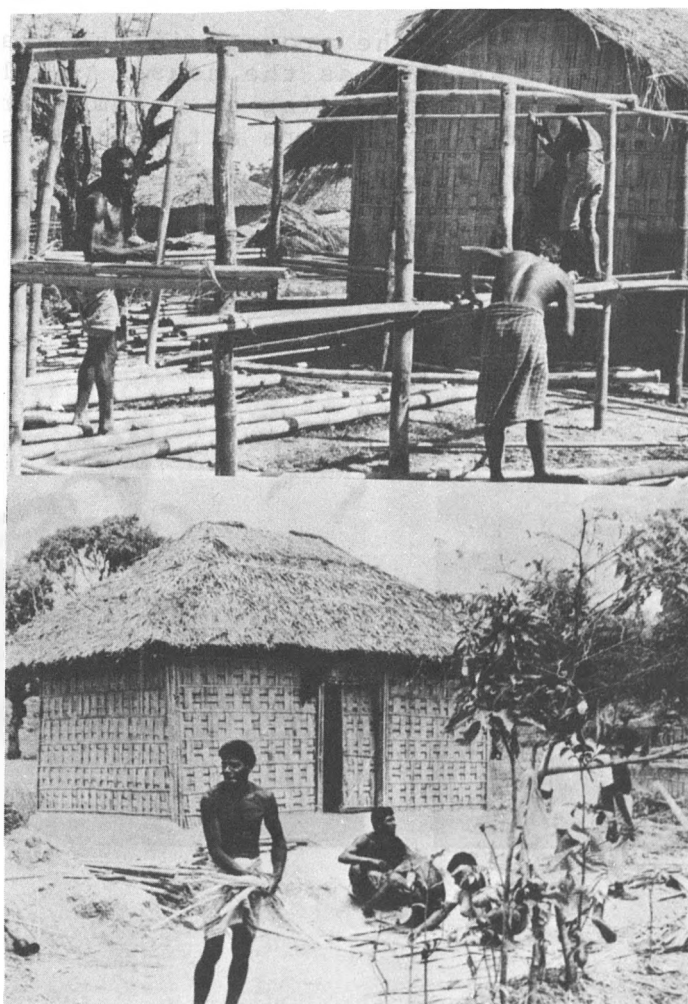

(Photos courtesy of MAP)

Figure 18
MAP Housing Project

II. Refugee Camp Housing

A number of structures have been built in the Bahari Bustee Camps by the VOLAGS in Bangladesh, but the vast majority have been built by the refugees themselves with materials provided them with little or no technical assistance. Two programs are worth mentioning here as they are representative of the programs on-going during the field test.

Figure 19 - Bahai Bustee Camps



World Vision Housing Program - In the Bustee Camp at Demra, World Vision distributed one bamboo pole approximately 30' long and one sheet of 10' x 20' bamboo mat (Class II). Distribution was generally for those relocated to the site who had no housing or whose housing was obviously so substandard as to be worthless in the coming monsoon. No technical assistance on methods of erecting or strengthening the units was provided; consequently, most of the units built were of two designs, illustrated below. It should be pointed out that few of these have survived the high winds and that, with only minor assistance such as explaining advantages of proper wind orientation, bracing, etc., many of these units might have lasted longer.



Figure 20
World Vision Housing Program

Presbyterian Mission Housing Project - At Tongi Bustee Camp, the representatives of the Presbyterian Mission arranged with a contractor to build 30-40 units of single family housing as replacement units for some destroyed during the first Spring windstorm that struck the camp in mid-April. The units, depicted below, were made of bamboo frames covered with bamboo mat siding and bamboo mat-plastic sheet sandwich panel roofing. The structures, which cost approximately \$100 each, were extremely vulnerable to winds. All labor was provided by the contractor who hired men in the camp to build the units.

Figure 21
Presbyterian Mission
Housing Project

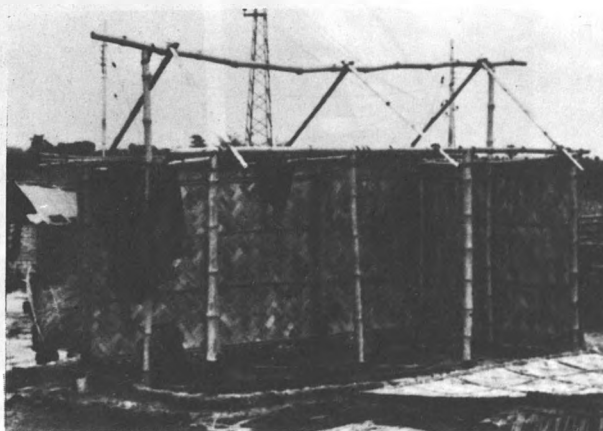

Part II

INSTRUCTOR'S MANUAL FOR CONSTRUCTION OF THE
CARNEGIE-MELLON UNIVERSITY REFUGEE HOUSING SHELTER

Purpose:

This manual provides a relief staff with:

1. The procedures for construction of the shelter;
2. Recommended organization for mass production of the shelter;
3. Information on alternative roofing materials;
4. Technical data concerning the strength and durability of the shelter.

Organization of Manual:

This manual is organized into three parts:

- Part I - Construction
- Part II - Mass Production of Structure
- Part III - Appendices

Description of Structure:

The Carnegie-Mellon University Refugee Shelter is designed for use in any tropical climate and can be built entirely of local materials. Any variety of materials can be utilized with only minor modifications necessary due to different types of materials.

The Carnegie-Mellon University Shelter consists of three groups of components: the frame, the floor, and the roof.

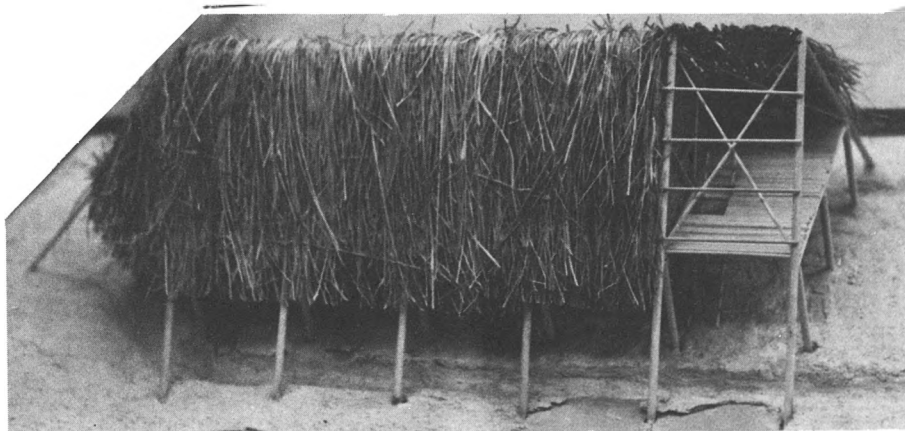

Each of these groups has been designed so it is structurally independent of the others. For example, the frame does not depend on the floor for strength; the floor can be built by itself either before or after construction of the frame; and the roofing material can be any one or combination of materials -- either natural, such as thatch, or synthetic, such as corrugated tin or zinc. This enables the structure to be built either one at a time or en masse. The frame and the flooring systems can be pre-fabricated at one place and delivered to the construction site, or all the

materials can be delivered to the site for assembly and construction there. The structure is designed so that if initially a short-life material is used for any part of the structure, it can be replaced without having to replace the entire structure.

The shelter can be built to any size the builder desires, either vertically or longitudinally. The unique feature of this structure is that the second floor is conceived as having a variety of purposes, but most importantly it is designed to be a refuge from flooding. Thus in an area where flooding is not a hazard, the second floor may be reduced in size (by elevating it higher in the structure) and used only for storage or eliminated altogether.

The ultimate size depends on the number of people who are to occupy the structure; the more people, the larger the structure. The normal living unit in the structure illustrated in this manual is the area, on both floors, between two full-sized A-frames.

It is recommended, however, that the structure not exceed seven normal units in length.

This structure is not unlike many structures currently used by people in the developing countries; in fact it utilizes all those skills normally found in tropical areas as well as incorporating local building techniques. However, this unit maximizes the use of each type of material and reduces the overall costs by reducing the amount of material required. Thus, the unit is one which improves on local designs and streamlines construction.

Part I Construction

This Construction Manual outlines the procedures for building a typical shelter using bamboo for the structural members and a thatching of bamboo or mat for the roof covering. The structure depicted contains 3 living units without a floor.

ଦାଣ୍ଡି ତୈଳିର ନିର୍ମାଣାଦମ୍ବି

ଏହି ଯେତେବେଳେ ଶାନ୍ତର ଶୁଣି-ତ୍ର ଯତ୍ନେ ଧାନ୍ୟ ନିଧି ତୈଳି ନିର୍ମାଣ
 ଲିଭାଦ୍ୟାନ ଆଶ୍ରୟ ତୈଳିର ନିର୍ମାଣାଦମ୍ବି ଯେଉଁ ଅନ୍ୟ ଉଲ୍ଲେଖିତ
 ନିୟମାଧୀନ ଲାଗି ଶୁଣି ଯାହାର ରାଧୁନୀ ଯାହାରେ।

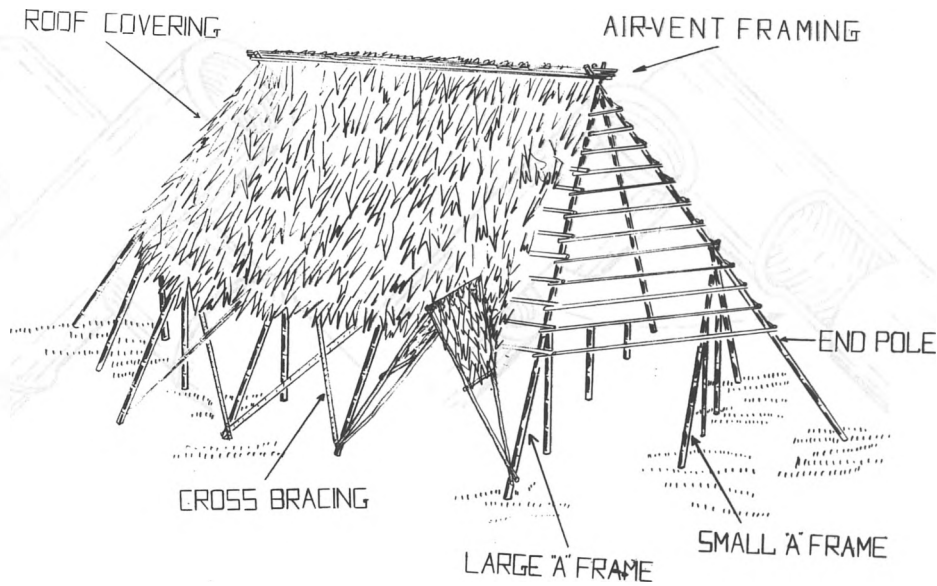

Step 2 - Layout structure by driving stakes into ground at points where holes for the A-frames are to be dug. Then dig holes for structure members. (See Pg 57 for dimensions)

ଦ୍ୱିତୀୟ ପାଦ
 ଯଦିଓ ଉପରୋକ୍ତ ଶୀର୍ଷ ପଥରେ ୨୦୦ ଫୁଟରେ
 ଚିହ୍ନ ଦିଆଯାଇ ୨୦୦, ୧୦୦ ଫୁଟରେ ପଥରେ ୨୦୦ ଫୁଟ
 ଧୂଳି / ଧୂଳି କାଢ଼ି ୨୦୦

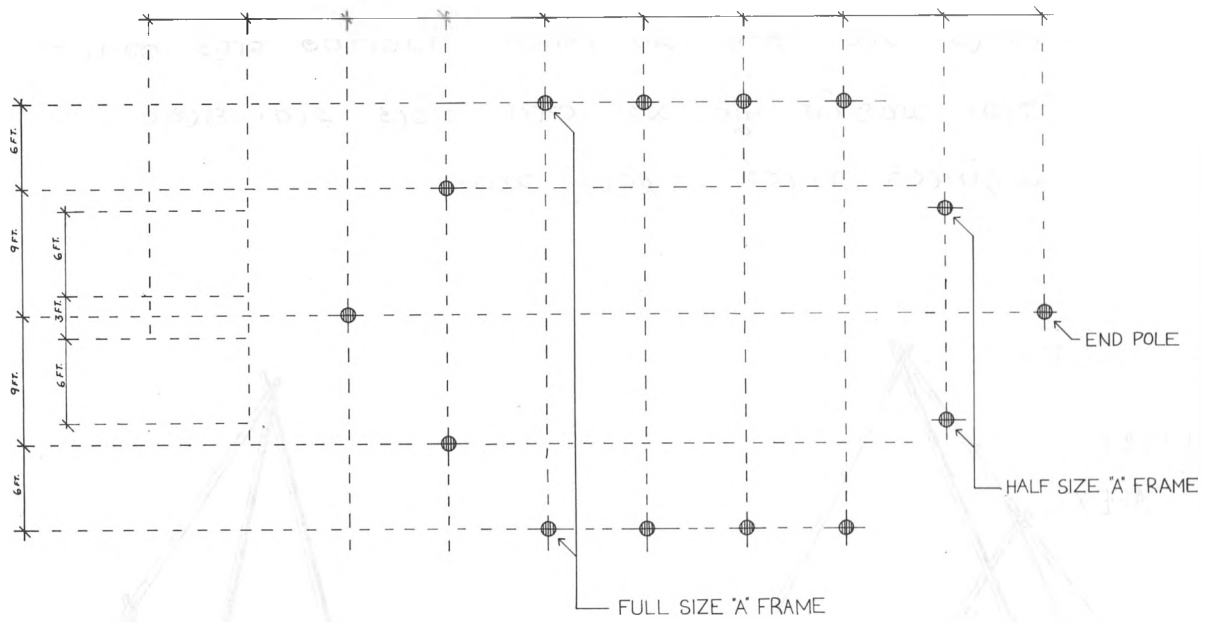

Step 3 - Tie the A-frame members together at the notch connection.

Construct the end assembly by placing one large and one half size A-frame in the proper holes as shown. Lay one end pole over the apex of both and place its base in the proper hole. Tie components together and back fill the holes. Repeat at opposite end of shelter.

ପାଦମ ପର୍ବ ଏକଜ୍ଞା ଅନୁସାଧୀ ଶରଣୀ ଚଡ଼ ୩ ନକ୍ଷା ଛୋଟ ଫ୍ରେମ ନିର୍ଦ୍ଧାରିତ
ନର୍ତ୍ତ ଚାରିପେ ଚାରିପ ଏବଂ ଡେଇଁ ଚାରିପେ ଥରେ ୧.୩ ନିର୍ଦ୍ଧାରିତ
ଶରଣୀ ଫୁଟି ପୁରୁଣୀ ଫୁଟି ଫୁଟି ଡେଇଁ ଡେଇଁ ଡେଇଁ ଡେଇଁ ଡେଇଁ
ଠାରେ ଥରେ ଥରେ ଥରେ ଥରେ ଥରେ ଥରେ ଥରେ ଥରେ ଥରେ
ଥରେ ଥରେ ଥରେ ଥରେ ଥରେ ଥରେ ଥରେ ଥରେ ଥରେ
ଅନୁନିର୍ଦ୍ଧାରିତ ନିର୍ଦ୍ଧାରିତ ଚାରିପେ ଥରେ ଥରେ

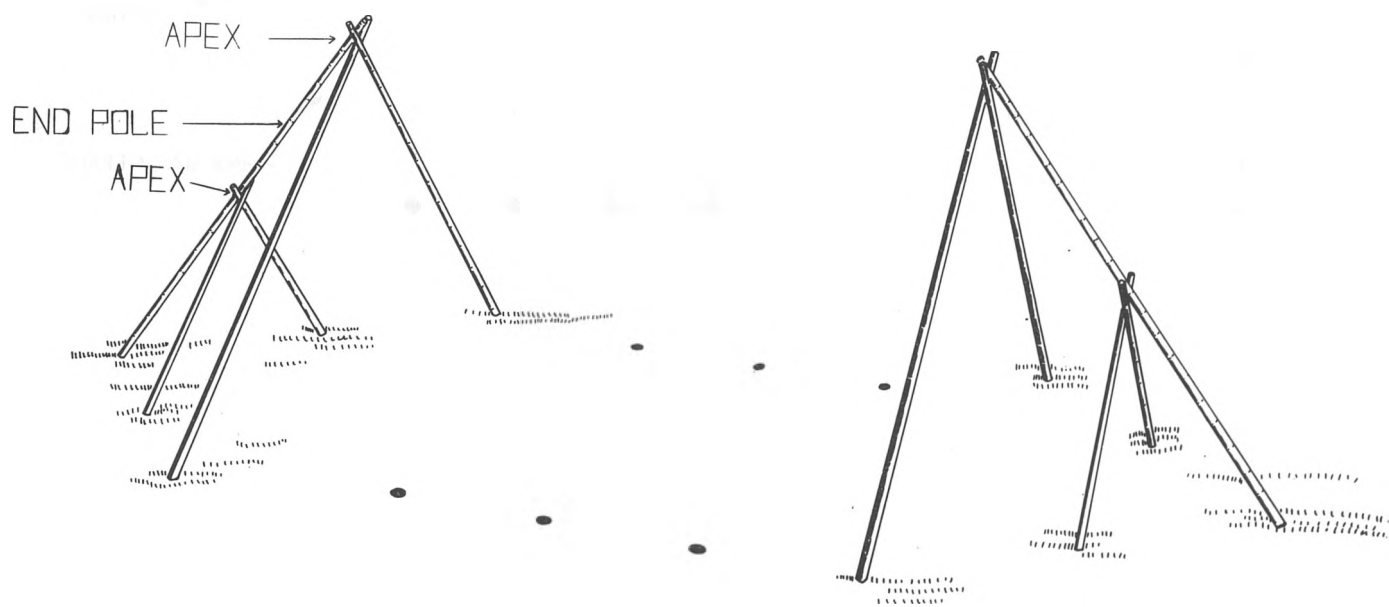

Step 4 - Erect the remainder of the large A-frames in proper holes, align the A-frames and tie the ridge pole in place. Then place the frame bracing as shown.

ସରଳ ଚାର ଗାଢ଼ି ଚଢ଼ ଫ୍ରେମ୍‌ଫ୍ରେମ୍‌ସି ଶିଖିଟିତ ଯାତେ ଫ୍ରେମ୍‌ଫ୍ରେମ୍‌ସି ଚଢ଼େ ।

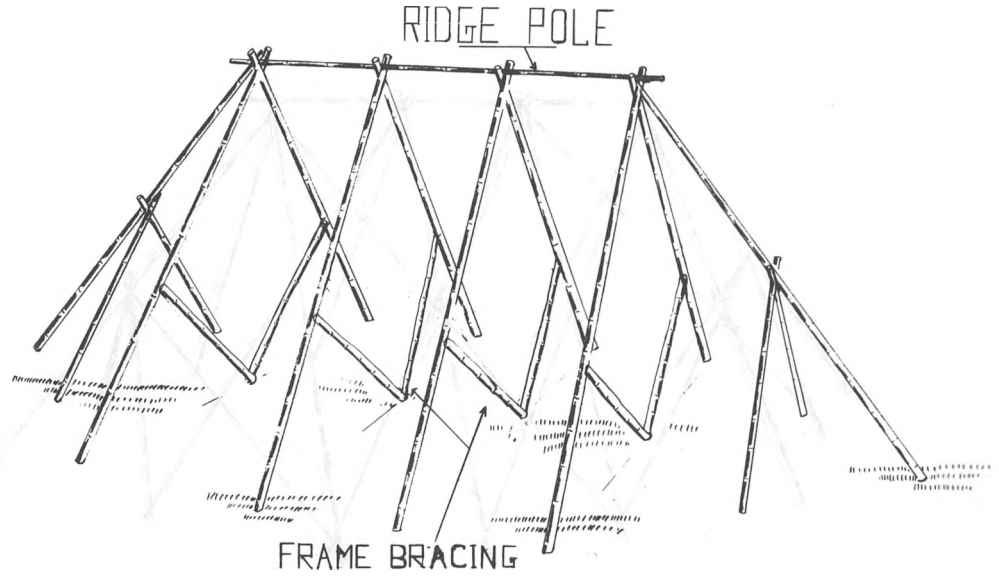

Step 5 - Tie the cross-bracing between the frames.

ଉତ୍ପାଦନ କାର୍ଯ୍ୟ ପାଇଁ ଉପଯୋଗୀ ଚାକରାଣୀ ସମ୍ପର୍କିତ ସୁବିଧା ମିଳିତ ହୁଏ କ୍ଷେତ୍ର ସ୍ୱତନ୍ତ୍ରତା
 ଉପସ୍ଥାପନା କାର୍ଯ୍ୟକାରୀ ମାତ୍ରାରେ ହେବ। ମତେ ପାଖିତ କନ୍ୟ ଉପକ୍ରମ
 ଆମତେ ହେବ।

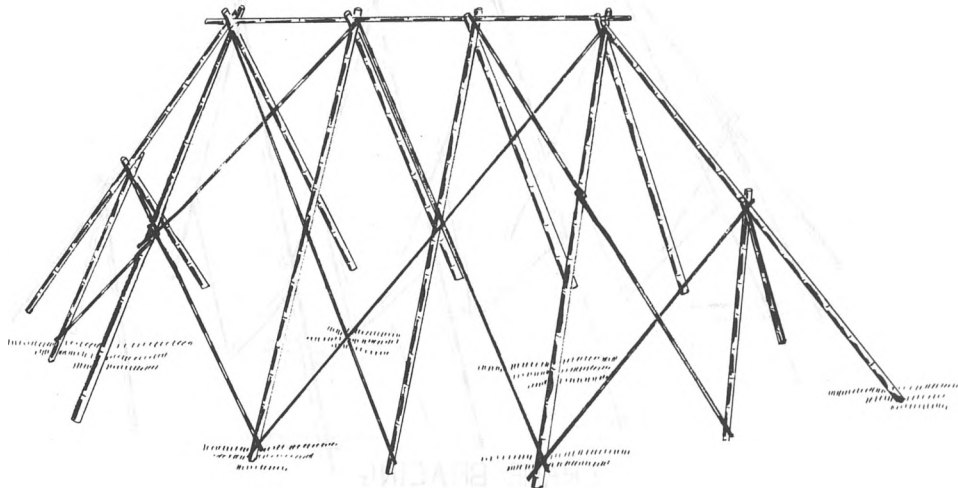

CROSS BRACING
 BETWEEN FRAMES 90°
 INTERSECTIONS

Step 6 - Install the roof covering using the selected material and the corresponding technique.

ନିମ୍ନ ଉପର ଲକ୍ଷ୍ୟାବଳୀରୁ ଚିତ୍ର ଦା ଖୁଣ୍ଟି ଆଗିପେ ଧାରା କାଟାଯୋ ଡେରୀ କଠଡେ ହେବ।
 ବଢେ ଉପର ଦା ଧଡ ଆଗିପେ ଧାରା ଉଠୁଆଁ କଠଡେ ହେବ।

(See page 22)

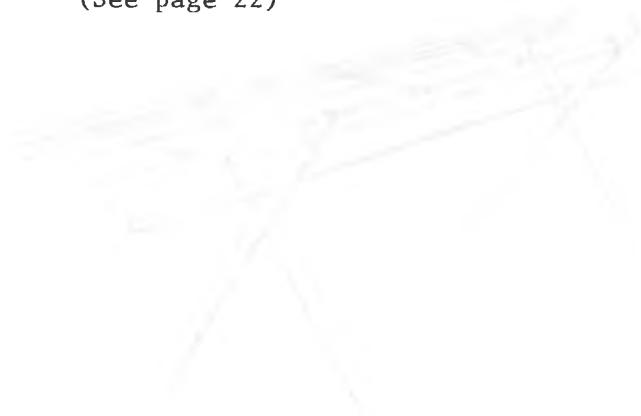

Step 7 - At the top of the shelter, longitudinal poles should be attached as shown.

ଅବଶ୍ୟକ ସମୟରେ ଉପରୋକ୍ତ ପଦକ୍ଷେପ ଅନୁସାରେ ଉପରୋକ୍ତ ଚିତ୍ର ଅନୁସାରେ କରାଯାଏ ।

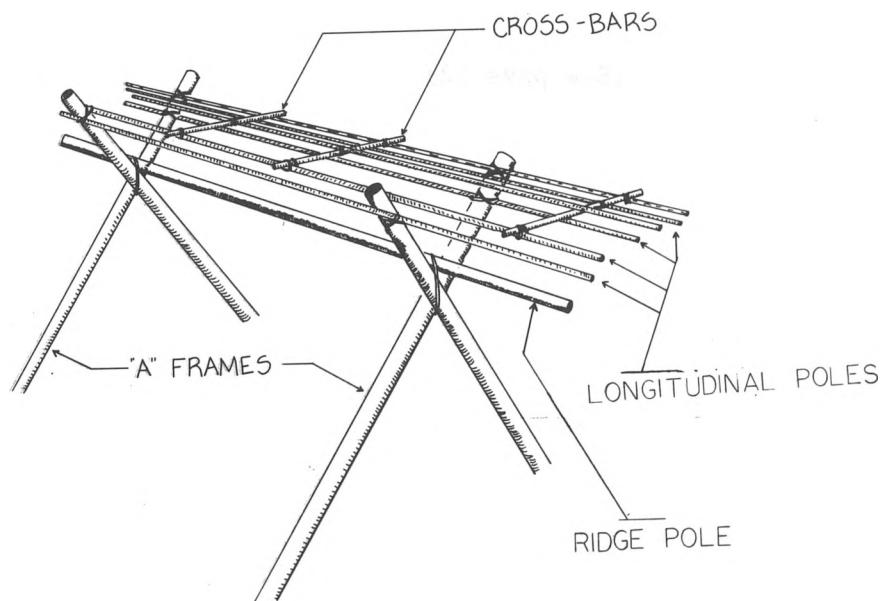

Step 8 - Attach the roofing material to permit air flow while shading water as shown.

ଏକମାତ୍ର ଅଧିକାରୀ ମାଡ଼େର 3 ଅବସ୍ଥାରେ ଯୁକ୍ତ କରାଯାଏ
 ଏହା 2ଟି ମାଡ଼େର ମାଡ଼େର 1ମ ଅବସ୍ଥାରେ ଏବଂ ମାଡ଼େର
 2ଟି ମାଡ଼େର କୋଣ କରାଯାଏ।

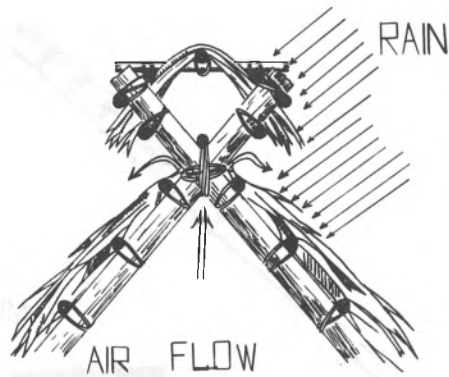

Step 9 - Dig drainage ditches around perimeter of shelter. Dirt taken from the ditch should be used to raise the level of the floor inside.

ଆହୁରି (କିମ୍ବା) ସାଧାରଣ ଚାଉଳାଞ୍ଜ (DRAIN) (ସ୍ଥଳ) ଧିକ୍
 ଗର୍ଭ ଧରଣ ଦୂରତେ ୨୦୦ ଗର୍ଭ ଧୈରୀୟା ସାମାନ୍ତର ଦୂରତେ
 ଚିତ୍ତ ଦୂରତେ ୨୫ ଚୂର୍ଣ୍ଣାତ ଦୂରତେ ୨୦୦

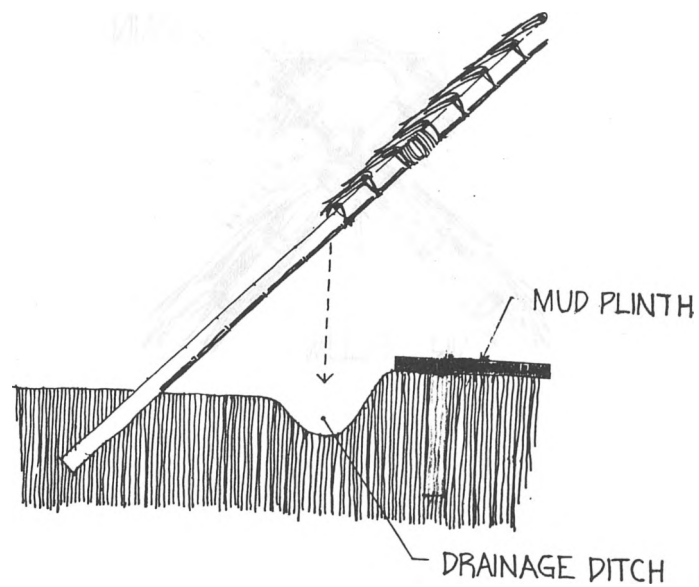

Step 10 - Install windows where desired. Diagram also shows how thatch functions to equalize pressure between interior and exterior.

ଚାନ୍ଦିନୀ ଉପରାଧୀ ଗାମାମା ଡିଗି କଠାଏ ୧୦୦।

ଓଡ଼ିଆ ଓ ଗାଁରେ ଡାକ ଗାମା ଡିଗି କଠାଏ ୧୦୦।

ଓଡ଼ିଆ ଓ ଗାଁରେ ଡାକ ଗାମା ଡିଗି କଠାଏ ୧୦୦।

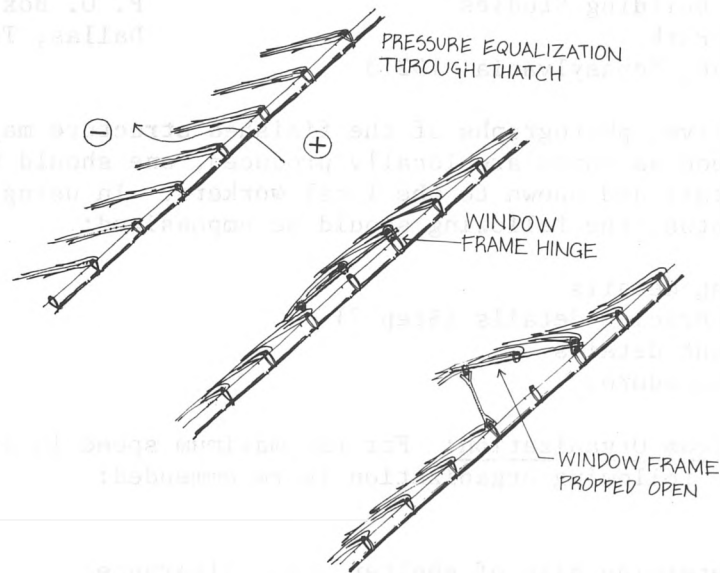

PART II

MASS PRODUCTION OF SHELTER

The Carnegie-Mellon University Refugee Housing Structure has been designed to enable numerous structures to be built simultaneously. The following procedures are recommended.

- A. Explaining the Concept: It is often difficult to explain the concept of any structure to those unfamiliar with it. To make it easier for unskilled laborers to understanding the CMU structure, it is recommended that a model be utilized. This may be constructed locally or one may be obtained from:

Carnegie-Mellon University
Advanced Building Studies
Schenley Park
Pittsburgh, Pennsylvania 15213

INTERTECT
P. O. Box 10502
Dallas, Texas 72507

As an alternative, photographs of the finished structure may be obtained. However, as soon as units are locally produced, one should be photographed in detail and shown to the local workers. In using either a model or photos, the following should be emphasized:

1. The joining details
 2. The cross-bracing details (Step 7)
 3. The air vent details
 4. Roofing procedures
- B. Construction Team Organization: For the maximum speed in erecting the structure, the following organization is recommended:

Team 1

Duties: Determine size of shelter, site clearance;
transport, receive and organize materials
Number: 10 men

Team 2

Duties: Stake out the shelter (construct net), dig holes
for frames and columns
Number: 6 men

Team 3

Duties: Pre-fabrication of components
Number: As required

Team 4

Duties: Erecting frames, tying cross-bracing (exterior only).
Number: 6 men

Team 5

Duties: Tie frame bracing, install floor
Number: 10 men

Team 6

Duties: Install roofing, install air vent, install windows
Number: 5 - 10 men

Team 7

Duties: Dig drainage ditch

Number: 4 men

- C. Anchorage: When utilizing cement or stabilized earth as a means of anchoring the structure, it is recommended that a separate team be formed to perform the task. This is necessary due to the precise measuring of the chemicals/mixture and in some cases the materials may be dangerous.

CONSTRUCTION MANUAL

This section outlines the procedures for building a typical shelter using bamboo for the structural members and a thatching for the roof. The structure depicted contains five living units with a floor.

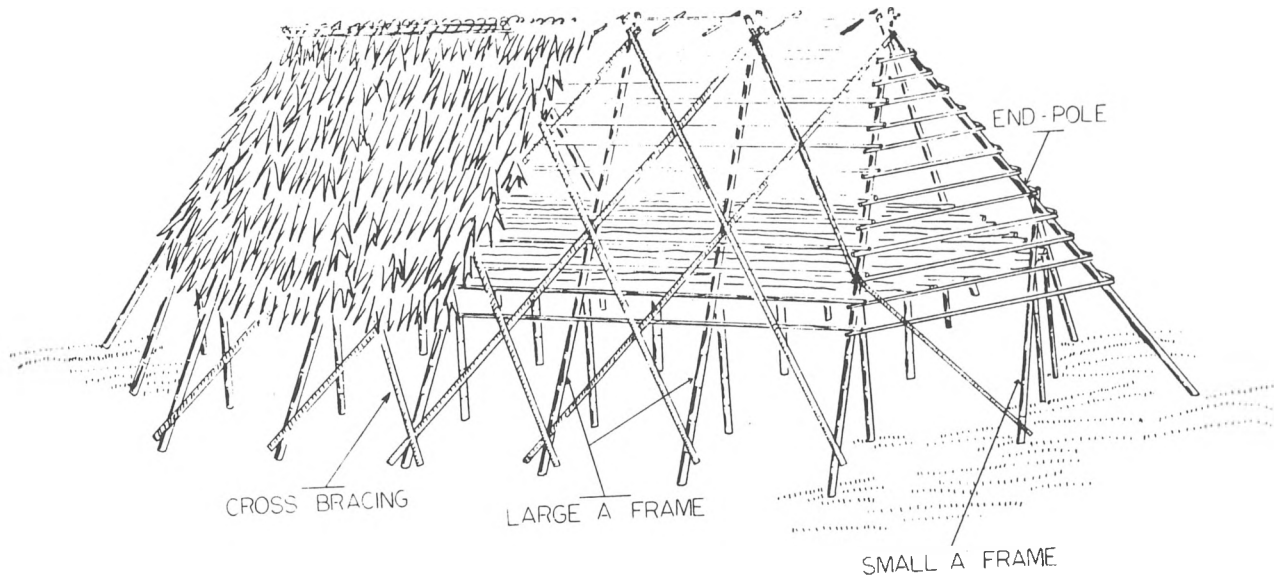

STEP 1 - Select the slope of wall desired from the two options given. Select the respective size of shelter desired, (make the selection by height desired or by width of ground space desired). Use the corresponding dimensions for the selected shelter size to construct the shelter.

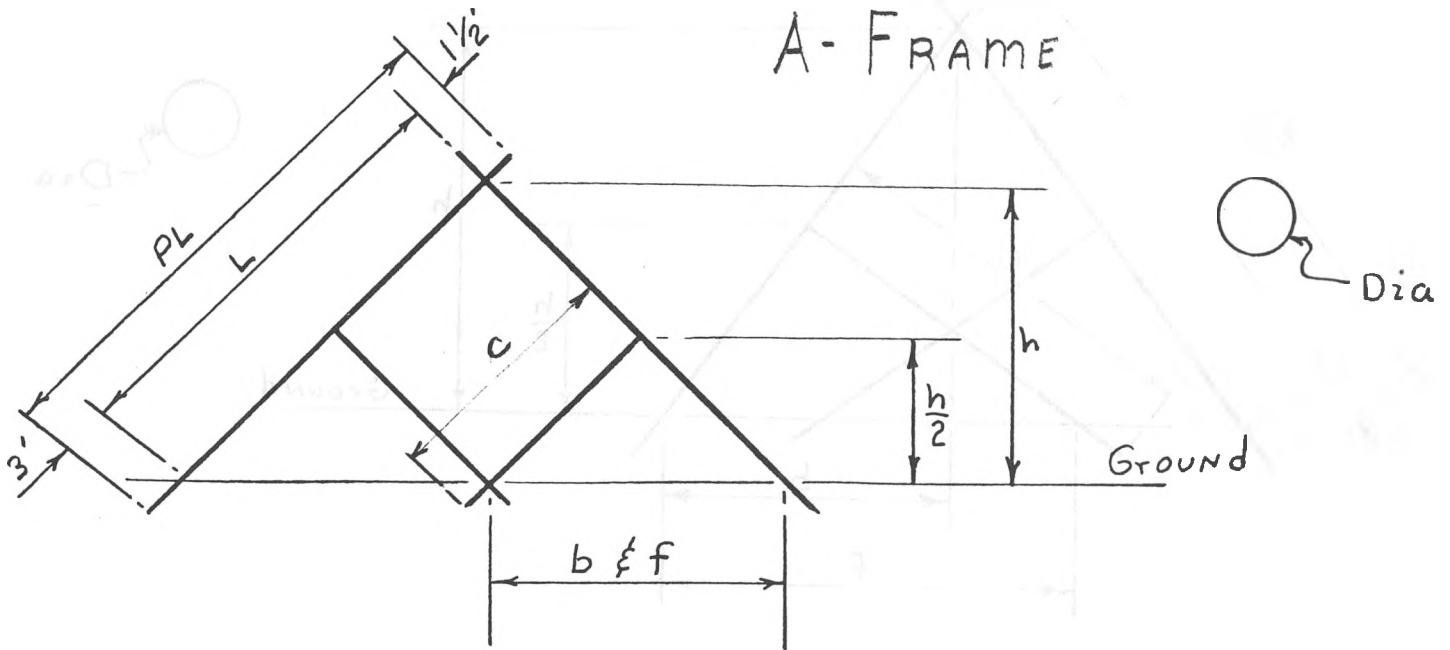

45° SLOPE A-FRAME

Dimensions for Step 1							Step 3	
L	PL	h	Dia	b	f	c	a	d
5'7"	10'	4'	3"	4'	4'	5'6"	0	43'9"
8'5"	13'	6'	3"	6'	6'	7'	0	48'5"
11'4"	16'	8'	4"	8'	8'	8'6"	4	53'5"
14'2"	18'6"	10'	4"	10'	10'	10'	5	58'6"
16'11"	21'6"	12'	5"	12'	12'	11'6"	6	63'8"
19'10"	24'6"	14'	5"	14'	14'	13'	7	68'
22'7"	27'	16'	6"	16'	16'	14'6"	7	74'4"
25'4"	30'	18'	6"	18'	18'	16'	8	79'7"

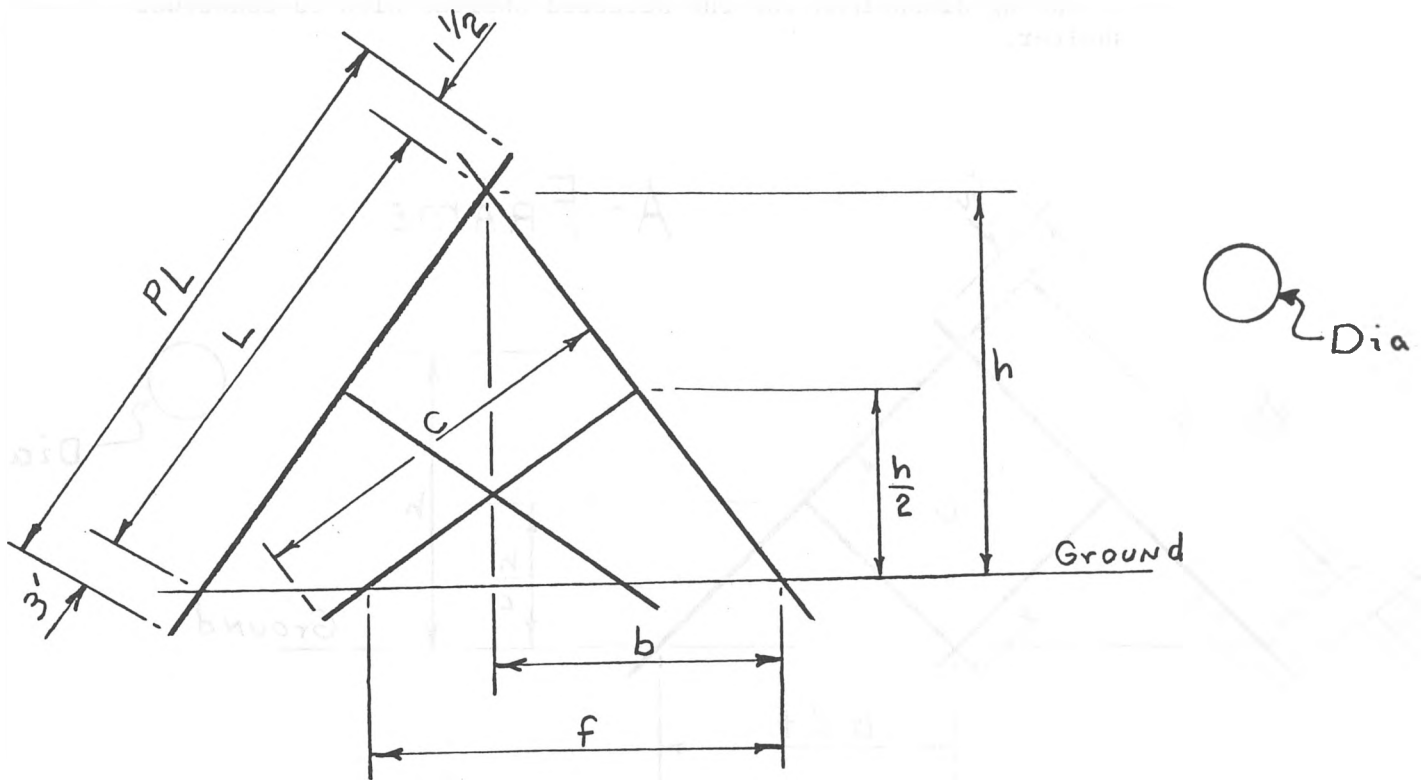

A-FRAME

DIMENSIONS			STEP 1				STEP 3	
L	PL	h	Dia	b	f	c	a	d
7'6"	12'	6'	3"	4'6"	6'6"	8'	0	44'10"
10'	14'6"	8"	3"	6'	8'6"	9'6"	0	48'6"
12'6"	17'	10'	4"	7'6"	10'6"	11'	0	52'4"
15'	19'6"	12'	4"	9'	12'6"	12'6"	4'6"	56'10"
17'6"	22'	14'	5"	10'6"	14'6"	14'	5'3"	59'8"
20'	24'6"	16'	5"	12'	16'6"	15'6"	6'	63'8"
22'6"	27'	18'	6"	13'6"	18'6"	17'	6'9"	67'7"
25'	29'6"	20'	6"	15'	20'6"	18'6"	7'6"	71'-6"

STEP 2 - Receive, organize and check material according to the "material" list.

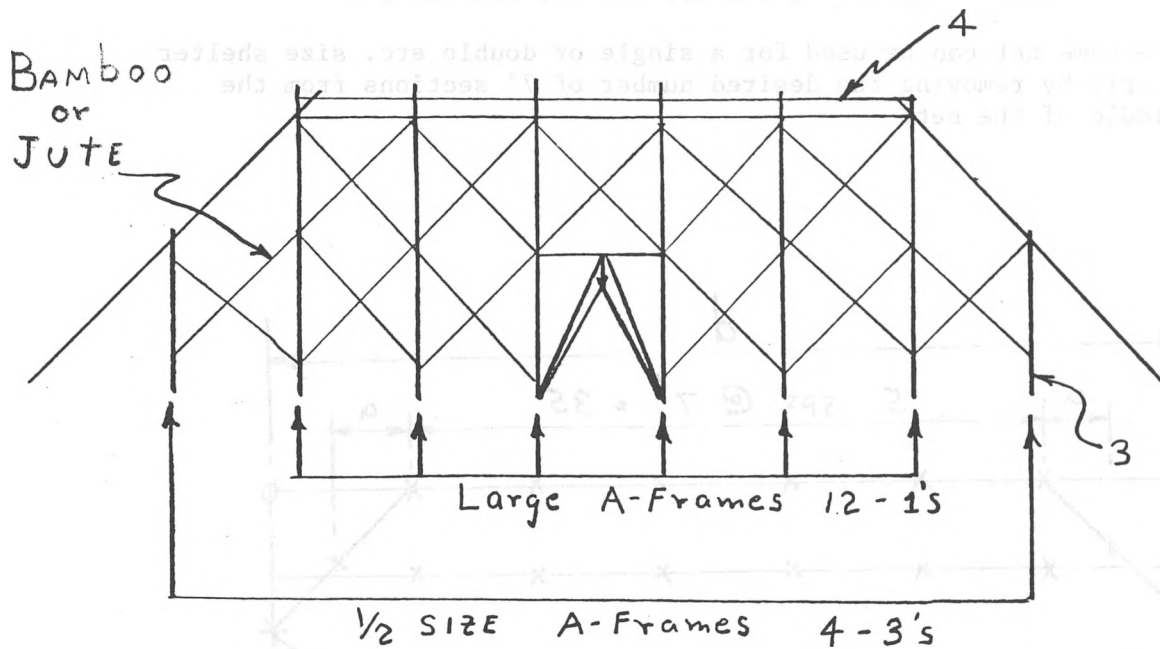

No	Description	Length	Quantity
1	Large A-frame members	PL	14
2	A-frame bracing	C	12
3	Small A-frame members	1/2 PL	4
4	Vent	36'	5
5	Jute		1600 ft
6	Door	≈10'	6
7	Roof (thatching or Mat)		

STEP 3 - Construct the net as shown, tie knots at each X. Situate the net on the ground where a structure is to be built and put stakes at each knot, then remove the net and dig the holes.

NOTE: The same net can be used for a single or double etc. size shelter simply by removing the desired number of 7' sections from the middle of the net.

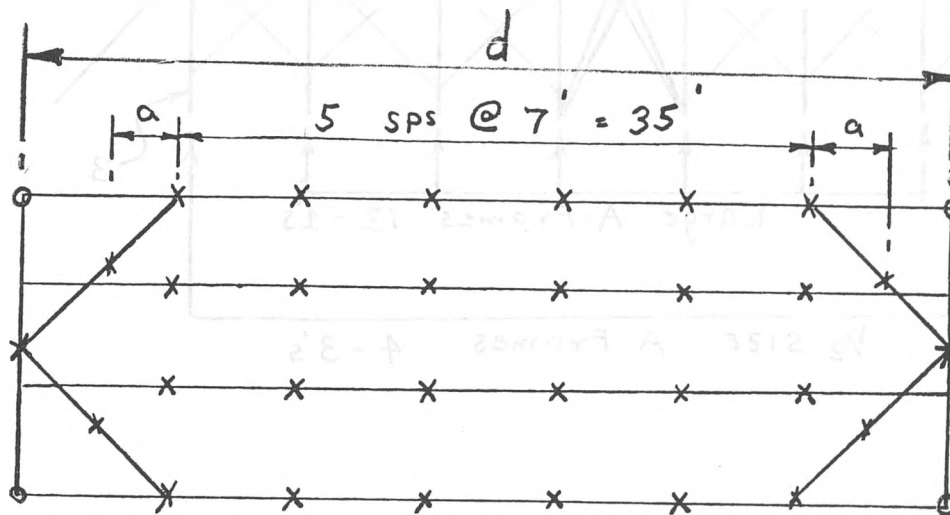

Item	Quantity	Description	Notes
1	1	Net	
2	1	Stakes	
3	1	...	
4	1	...	
5	1	...	
6	1	...	
7	1	...	

STEP 4 - Pre-fabrication of Components: The recommended procedure for pre-construction to ensure uniform sizing is to stake out the pattern for each component on the ground. The following pattern can be used for cutting the A-frames (see Step 1 for dimensions).

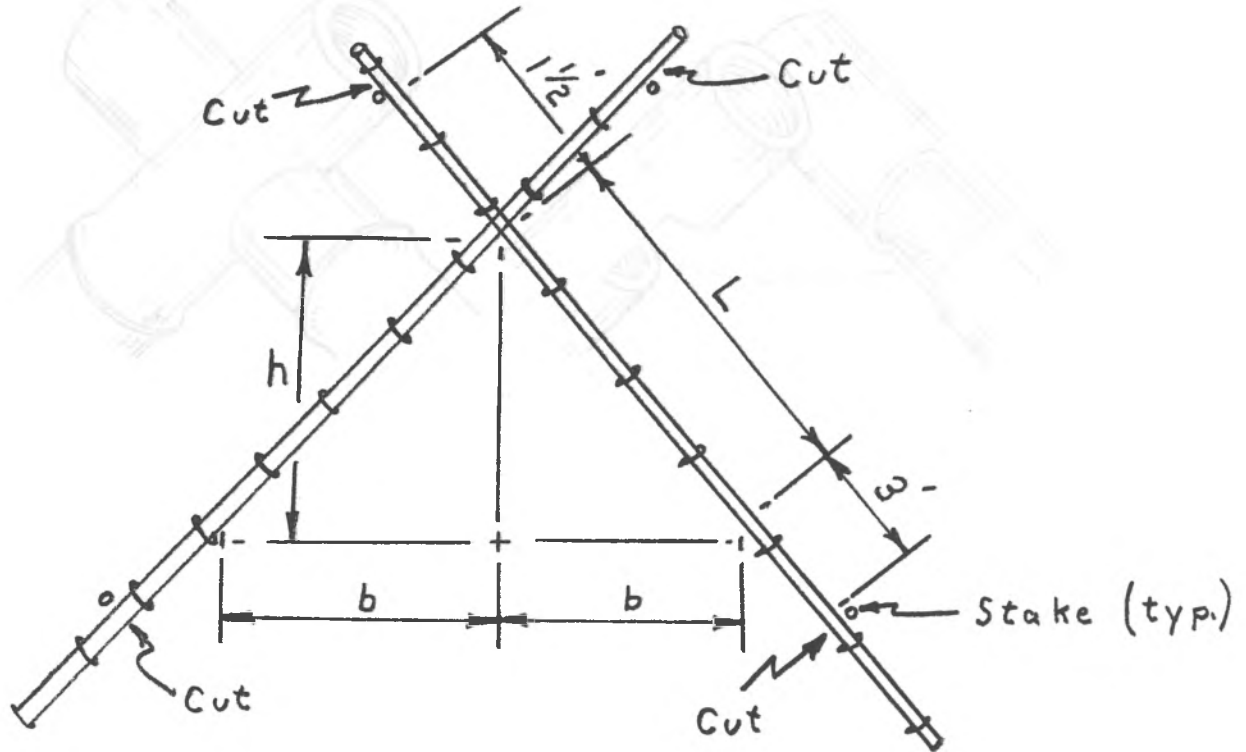

STEP 5 - Take two poles cut to length for A-frames. At 1 ft. from the end of each, cut a notch as illustrated. Repeat this procedure until the desired number of frames are cut. Repeat the above procedure using smaller poles to make the half size A-frames.

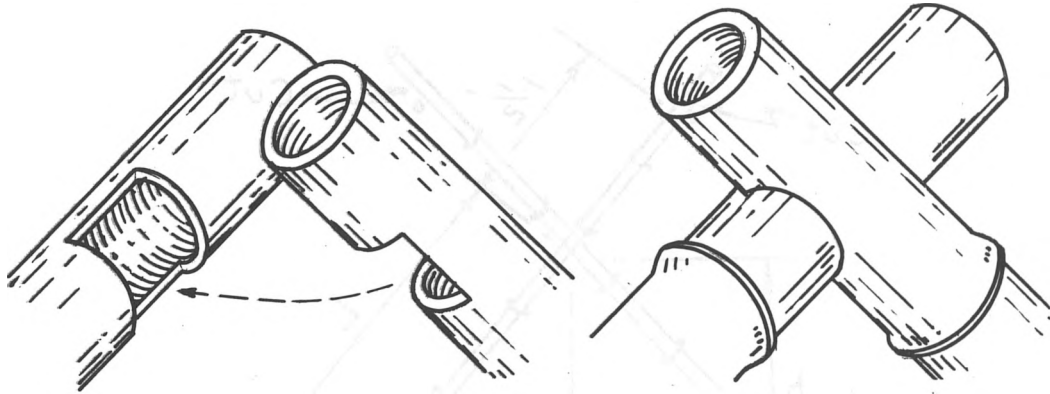

STEP 6 - Tie the A-frame members together at the notch connection. Construct the end assembly by placing one large and one half size A-frame in the proper holes as shown. Lay one end pole over the apex of both and place its base in the proper hole. Tie components together and back fill the holes. Repeat at opposite end of shelter.

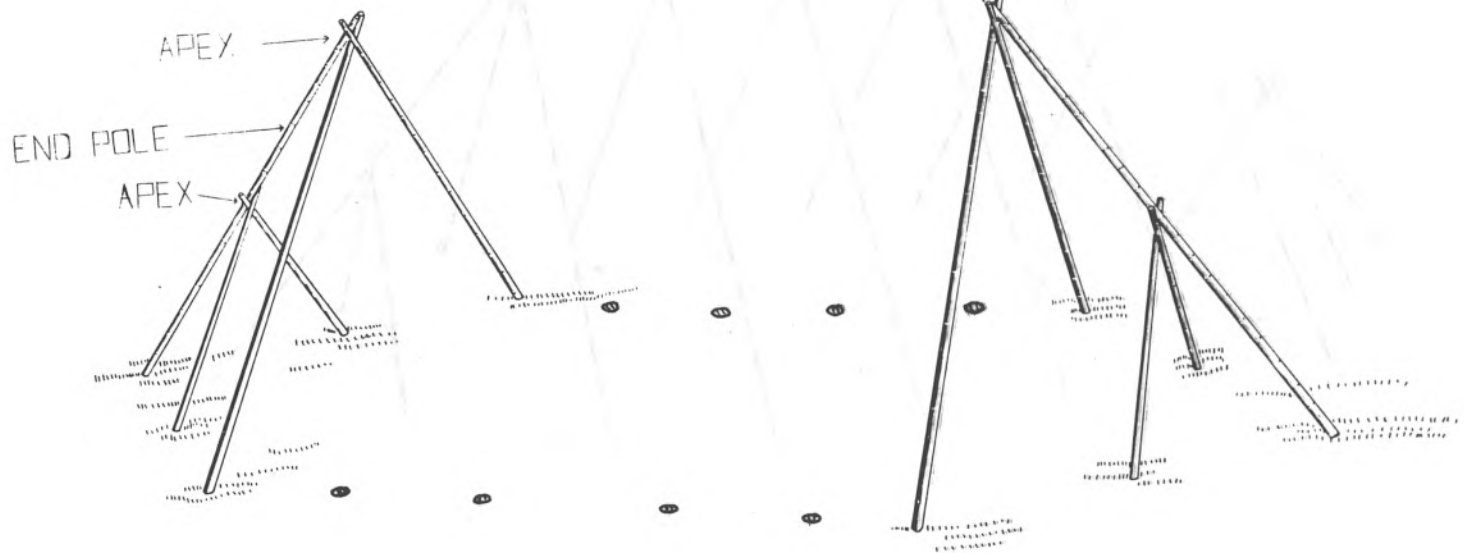

STEP 7 - Erect the remainder of the large frames in proper holes,

Construct the remainder of the large frames in the proper holes as shown. Use one end pole over the apex of each and place the base in the proper hole. The components together and back fill the holes. Repeat as appropriate end of shelter.

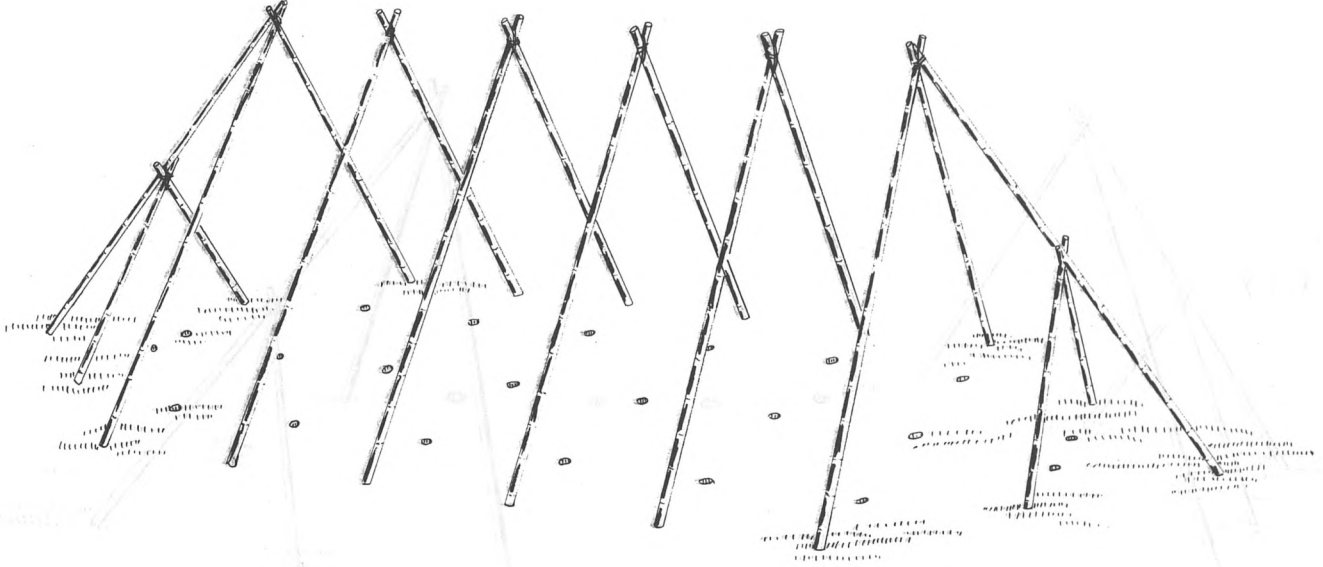

STEP 8 - Attach the cross-bracing between the frames.

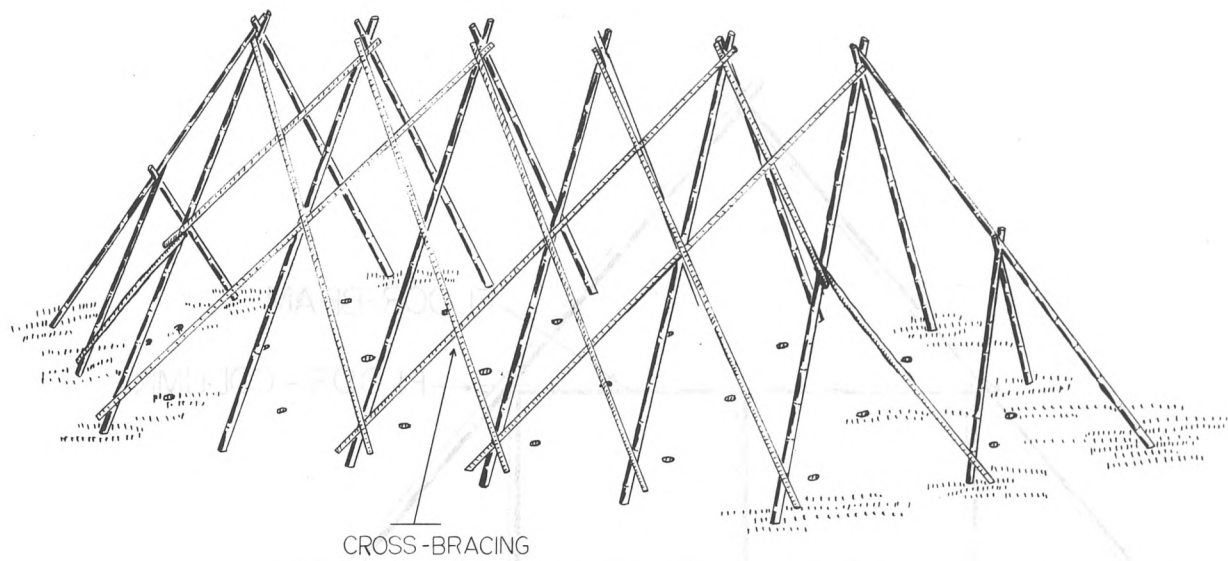

STEP 9 - Place floor columns in proper holes and attach floor beam to columns and frame.

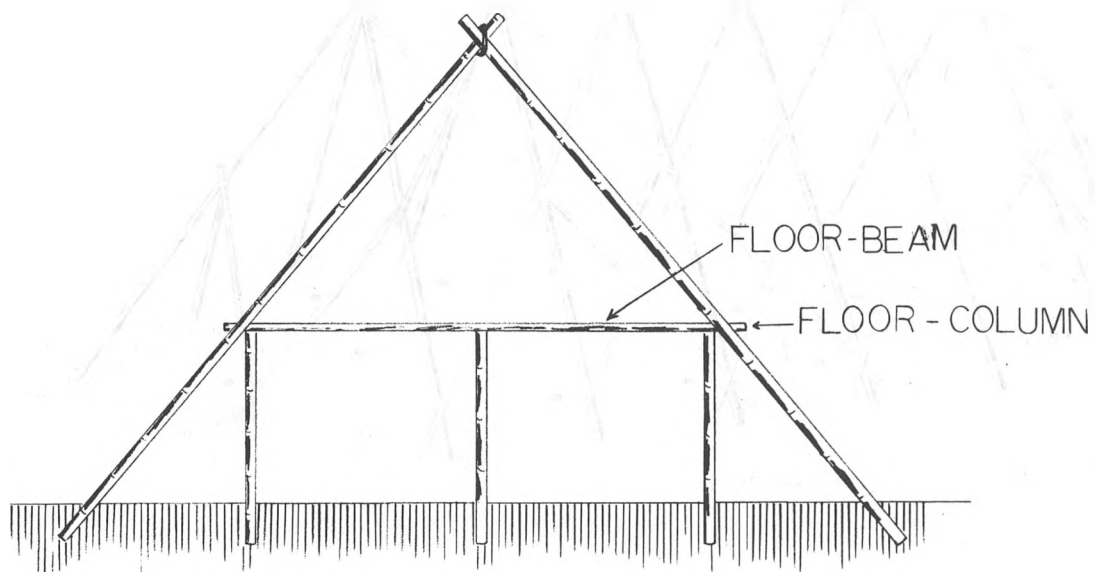

STEP 10 - Install flooring members as shown. For added strength attach small poles in the transverse direction beneath the floor.
Install the roof by attaching poles horizontally across the length of the structure. The thatch is then hung from these poles,

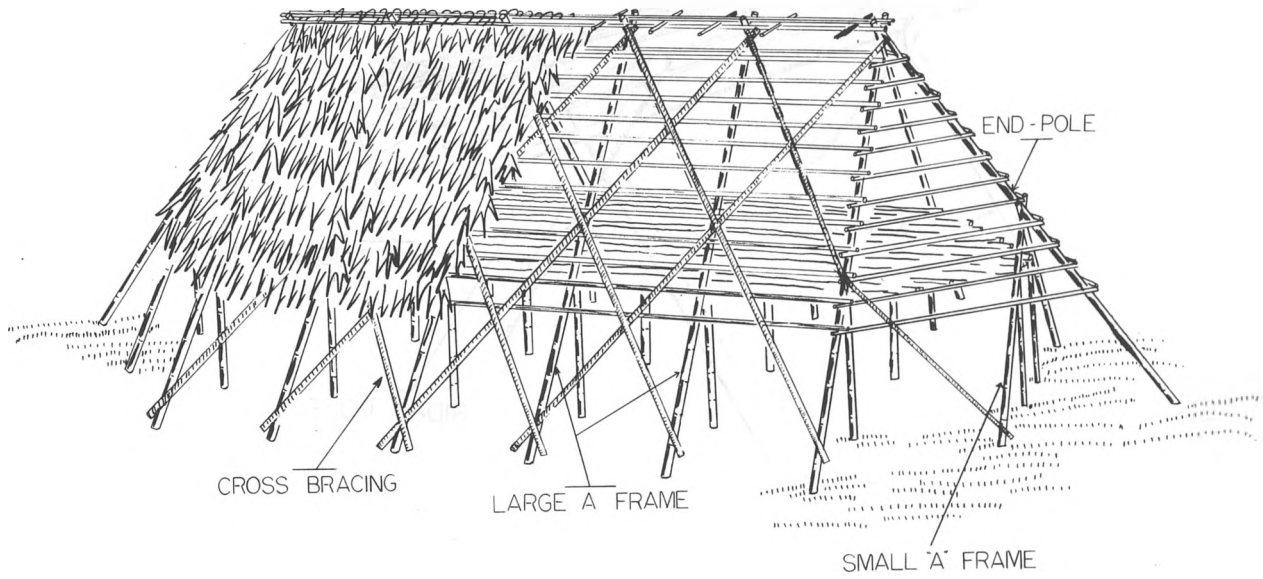

STEP 11 - At the top of the shelter, longitudinal poles should be attached as shown.

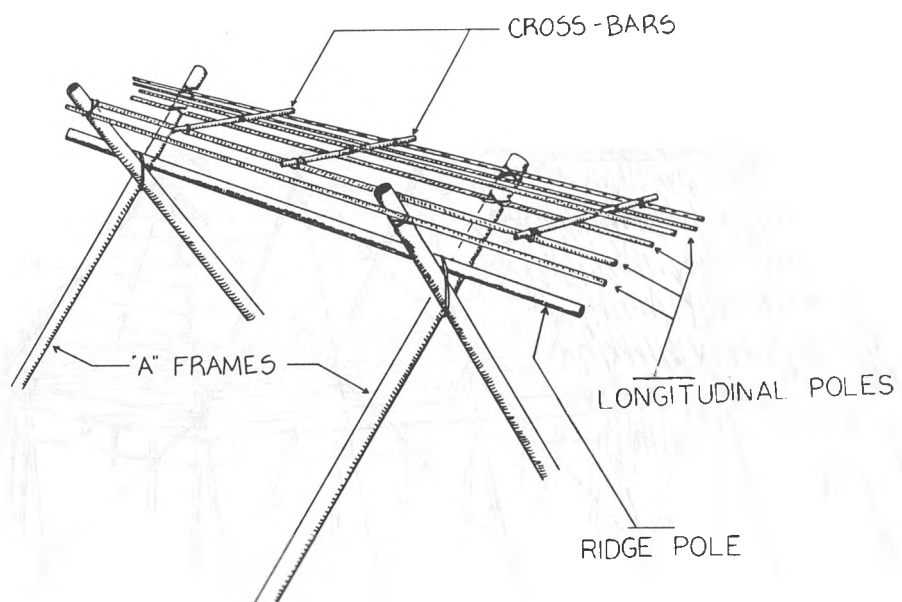

STEP 12 - Attach short transverse poles, and then another longitudinal pole on top. With the addition of thatch, this creates a covering for the air vent.

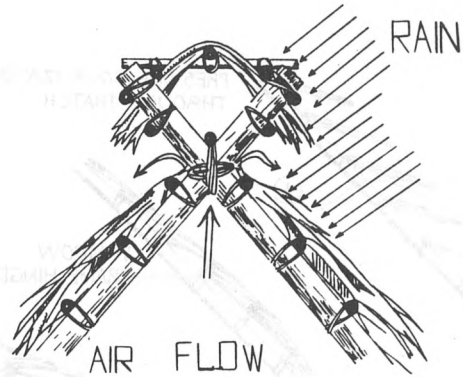

STEP 13 - Install windows where desired. Diagram also shows how thatch functions to equalize pressure between interior and exterior.

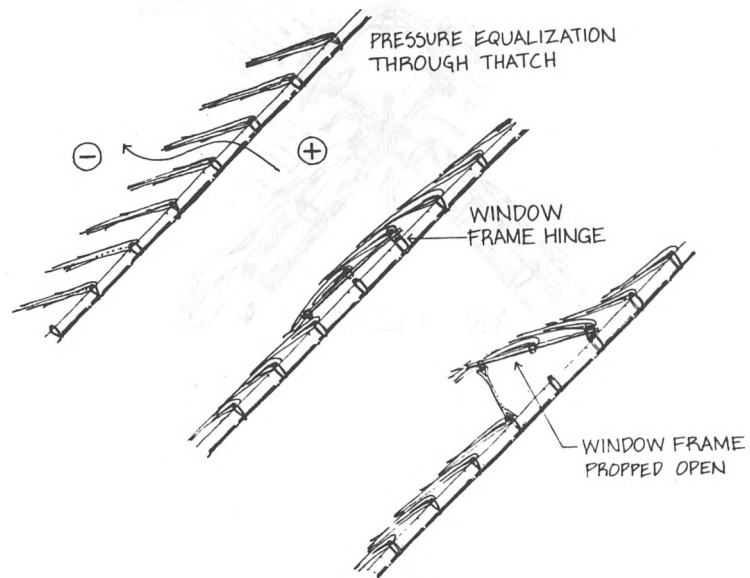

STEP 14 - Dig drainage ditches around perimeter of shelter. Dirt taken from the ditch should be used to raise the level of the floor inside.

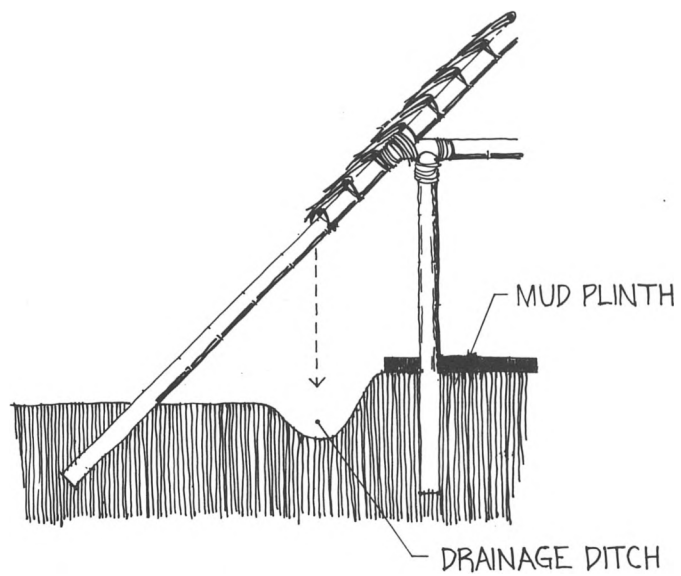

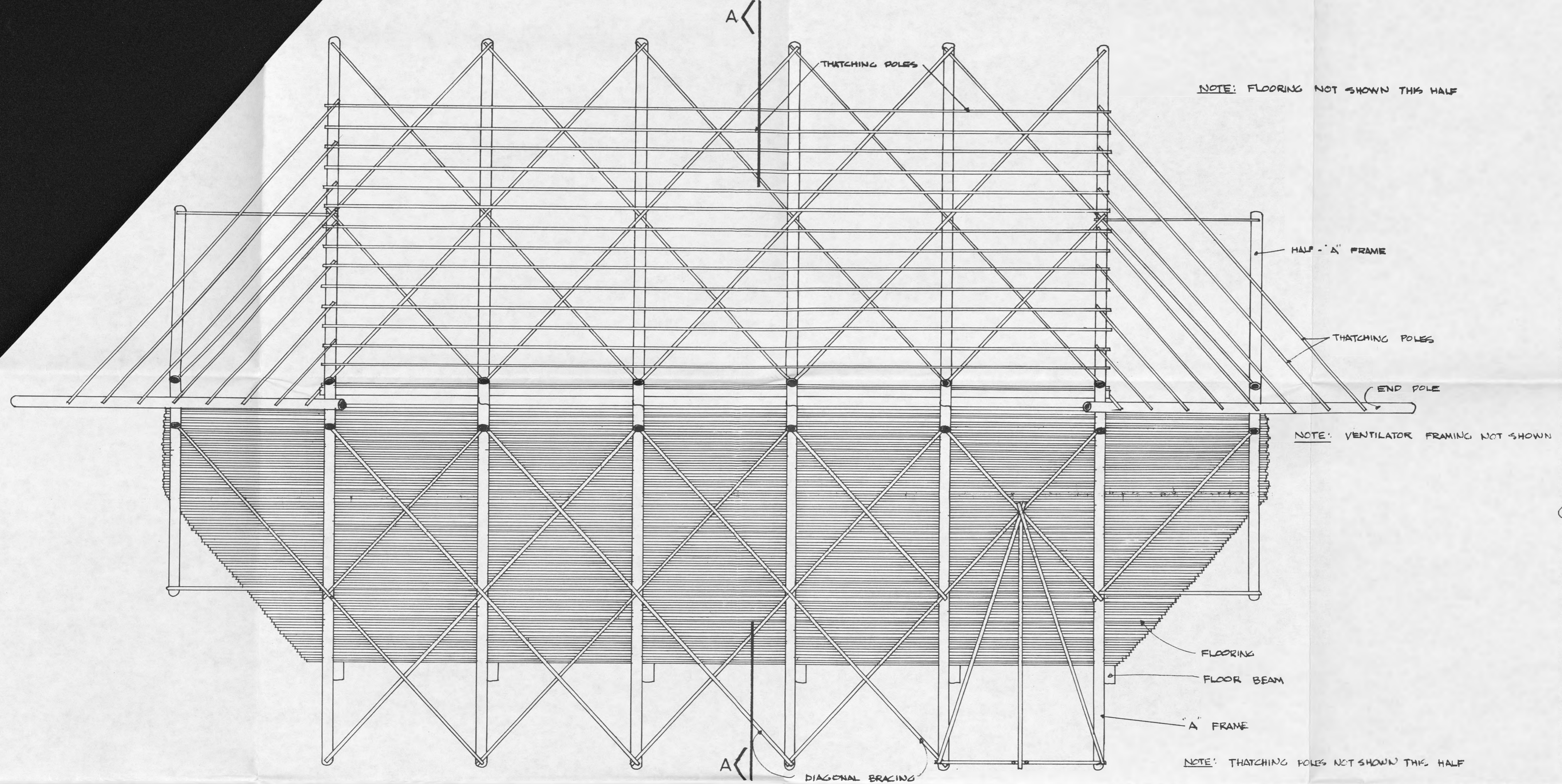

STRUCTURAL PLAN

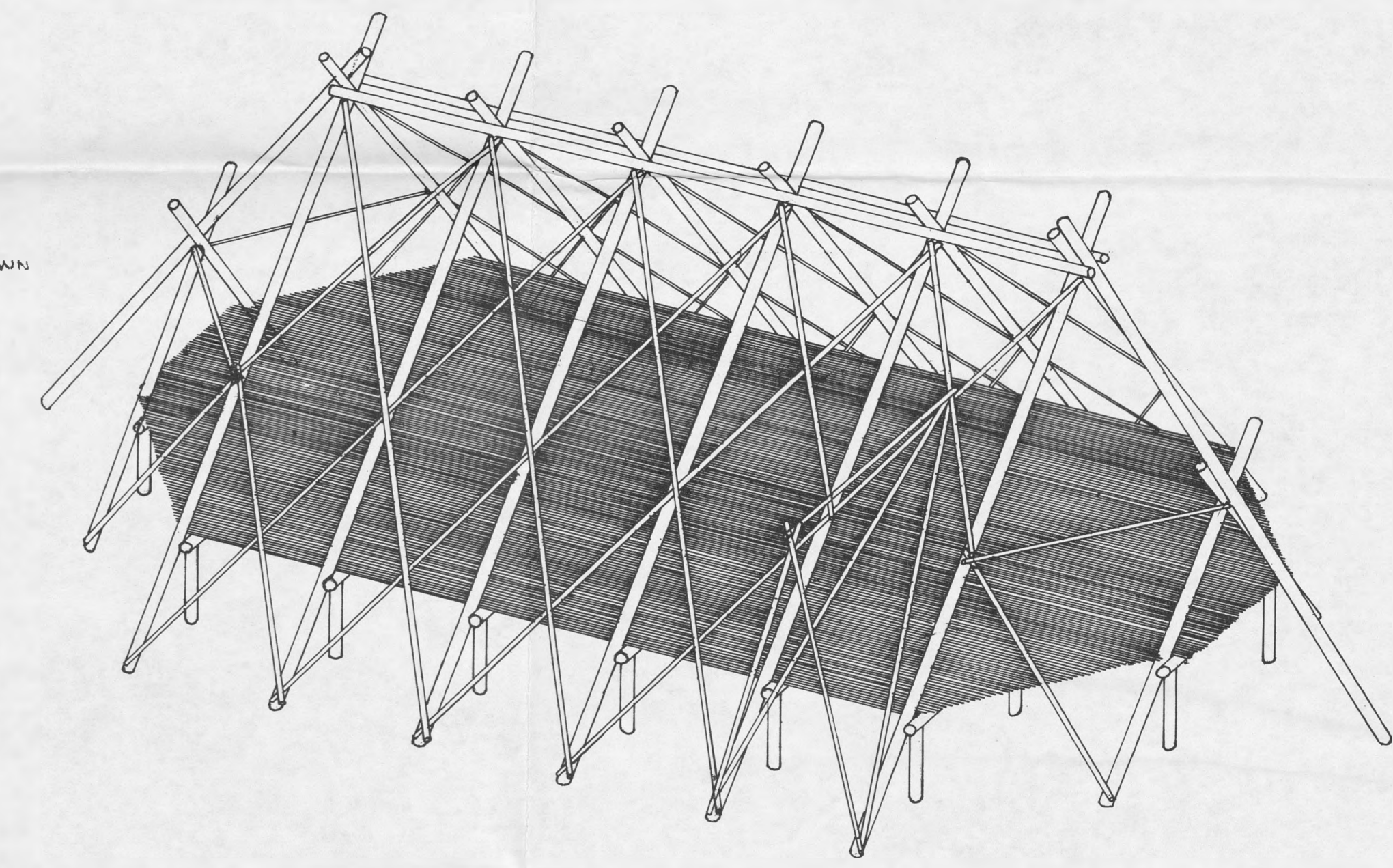

ISOMETRIC

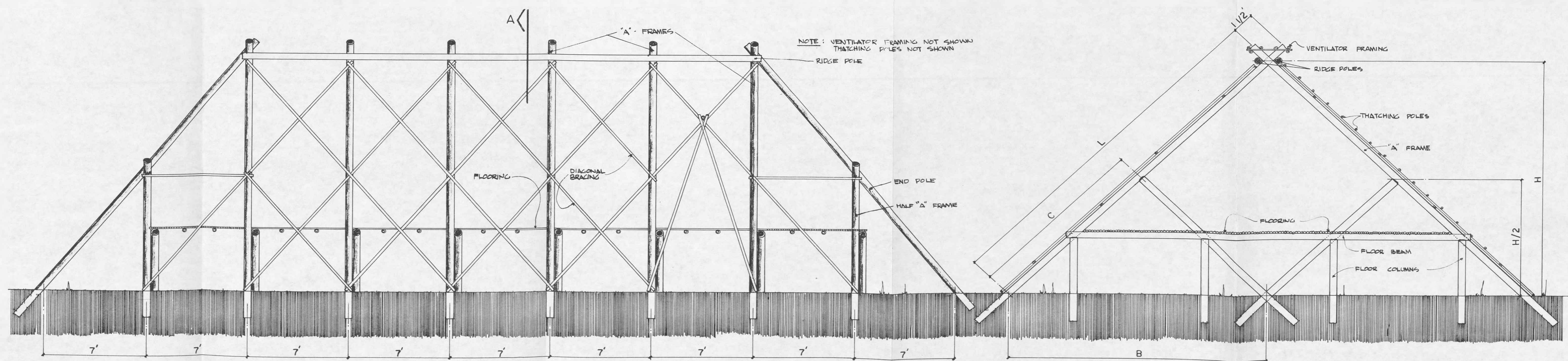

STRUCTURAL ELEVATION

DECISION TREE

A. Introduction

In initiating a disaster response program, expatriate relief organizations often find themselves with inadequate information on how best to respond to particular needs. Initial actions are often based on sketchy reports and information sent back is not always of sufficient quality on which to base decisions which will ultimately involve large expenditures.

One of the areas of great wastage in the past has been in the realm of shelter. While many of the discrepancies between what is needed and what is supplied are due to the need for immediate action and the lack of documentation of previous experience, much confusion has been the result of relief workers of various disciplines viewing their work myopically. It is increasingly being recognized, by government as well as VOLAGS, that satisfactory solutions can only be achieved if all factors relating to the environment are reviewed and integrated into a relief housing program.

When a disaster strikes, the problems encountered are diverse and varied, yet many of these problems are as recurrent as the disasters themselves. By identifying and cataloging the range of problems encountered, a program can be created that can facilitate the decision-making process, a program which will provide a framework for classifying problems and approaches to alleviating them with the maximum feasible interchange between various disciplines. This program can subsequently be used to generate an acceptable range of options, both for the home office (what to provide) and the field worker (what to build). Such a system would also provide a framework for disaster response agencies to develop and store usable data for future retrieval when a disaster breaks.

During the contract year, the team worked to develop such a program. It was decided that the best mechanism is a "decision tree," a process that can be either operated by hand, by means of a questionnaire with data selection lists or cards, or by computer. A sample procedure was developed using a brief questionnaire consisting of questions and linkages to subsequent data.

B. Format

The decision tree consists of the following parts:

- standard questionnaire with
 - questions
 - responses
 - code numbers
 - pointers
- link lists
- information tables or cards

The format of the system was structured so that data for immediate use in relief can be gathered as well as information for long-term development programs. Basic information for each country must be gathered in advance for the system to work; however, the questionnaire can be used for developing shelter options for a wide range of disasters and locations.

The tree is structured to provide specific questions and responses relating to tasks for the following disciplines: architects, planners, engineers (sanitation, transportation, structural, etc.), medical personnel, sociologists, psychologists, geographers, and economists. The format is open-ended so that all sections can be enlarged and updated and is designed so that it can be computerized to enable the storage and retrieval of large amounts of data.

C. Factors

Factors to be considered are grouped into the following categories: physical environment described by climatic conditions (wind forces, rain, temperature, humidity); geography (location, topography, transportation, natural resources, population density, etc.); socio-cultural environment described by value systems (beliefs, taboos, rituals, social interaction of individuals and groups); political structure; and socioeconomic realities (infrastructure, state of development and technology transfer, financial and material resources).

D. How It Works

Information is retrieved by checking relevant questions in sequence and choosing the appropriate response to a given question. Each response has a code number called a pointer which establishes connections between the response and the information stored by code numbers which are alpha numeric references assigned to the factors in the information tables.

Information tables contain factors, options and data with references according to the categories listed above.

The tree can be used in a variety of roles in both disaster response and pre-disaster planning. Below are two examples:

1) The ALPHA Organization decides to respond to an earthquake in Central America. As it is the rainy season, it is decided to get involved in housing activities for the refugees. Unfortunately, ALPHA has no experience in the area and they are generally unfamiliar with the housing styles before the disaster. Therefore, they decide to send a representative to the site before responding. The representative takes the questionnaire part of the tree with him to use as a basis of data gathering. By following the sequence, he establishes base data on the people, their pre-disaster culture and living styles, and basic data concerning their housing and community arrangements. By determining the materials that will be available, he is then presented with a range of options on the type of housing that can be used successfully in the region for refugee or replacement housing.

2) The BETA Organization realizes that the upcoming monsoon in an Asian country can spell disaster for the nation if flooding occurs again this year. A group is formed to plan for contingencies, including rehousing programs. By using the tree format, various staff members are assigned the job of gathering data on the various aspects of the country related to housing. A complete response program is then developed, centering on one type of housing selected from the options provided which will make maximum use of the agency's available resources. When the disaster does strike months later, the agency goes into immediate action.

E. Progress To Date

During the year the team developed a set of sample questions for use in the questionnaire of the system. In addition, a housing data bank on Bangladesh was set up using the codes established for classification. A linkage list was then developed for establishing links between responses and the data tables.

A full scale mock-up was then prepared which included a set of operating instructions, a questionnaire with responses encoded with pointers, a linkage list, and data tables. To use the tree, the questionnaire and link lists were made to fold out so that all three were juxtaposed. Persons using the tree read each question and selected the appropriate response noting the pointer. Referring to the link lists, the information code number was selected. In some cases additional pointers followed these which led in turn to more information code numbers. After completing the questionnaire, the operator then referred to the tables and retrieved the information corresponding to the codes. At the end of process, a general list of approaches was presented to the operator.

The field test in Bangladesh provided the staff with an opportunity to test the process as well as verify the data. From the tests it was determined that the range of responses to each question needs to be expanded and that data categories need to be expanded.

Part III

APPENDIX I

Excerpts from "Request for a Capital Grant from OXFAM"

5. Project Area: The area is a high density, unorganized non-Bengali encampment. It lies on a 1.3 acre field bounded on 4 sides by brick and mortar structures. One brick road provides access to the area and 4 unsurfaced roads bound each side. The entire area is square, approx. 250' on side, with a large open tank in the western one-third of the site. The entire area is above 61' MSL, the possible flood level.

One hundred and eight non-Bengali families occupy 64 structures, all made of various combinations of bamboo, bamboo mats and mud. Some occupants were provided or have obtained synthetic materials including fired bricks, polythene sheeting, and C.G.I. sheets, though the vast majority only use indigenous materials. Within the area there are a combination of single-family units, 2-family units, and 1 large 15-family structure built by the I.C.R.C. in 1972. All units have been in the area since 1972 and are dilapidated. Only a few could be expected to survive the upcoming monsoon.

Sanitation is provided by the OXFAM sanitation unit which lies to the west of the main settlement area. On site there are no tube wells, though one tap supplies water nearby which can be carried to the area.

6. Project:

- a) It is proposed that a demonstration rehousing project be conducted within boundaries of the project area. This scheme will utilize the CMU refugee housing unit in a planned community environment to rehouse those families currently occupying the site. The objectives of the project are:

- To rehouse the non-Bengali community in this area in structures which will be able to better withstand the environment (high winds, heat);
- To develop an integrated, planned community which will enable participating agencies and the government to test a variety of physical planning concepts designed to:
 - increase community cohesiveness
 - reduce long-range administrative costs

- increase usable space within the community which can be devoted to non-housing uses (ex. gardens, open space, fish ponds, etc.)
- To test the design, the concept of design, and the cultural acceptability of the CMU Refugee Housing Units (prototype II). This structure is described in detail in the attached "Construction Manual."
- To determine the CMU structure's cost in a refugee camp environment.

There are currently no other housing projects planned or proposed for the area by government or voluntary agencies.

No alternative plans have been proposed by government or voluntary agencies.

- b) It is proposed that all 108 families in the project area be rehoused. Construction is slated to begin in one week from the date of the proposal and all families are expected to be rehoused within a one-month period.
 - c) This area was chosen due to the proximity of the OXFAM sanitation unit; the persons chosen all reside in the area. Before the installation of the unit, this area was designated as the worst area in Mirpur Cantonment. The funds provided by OXFAM will continue the work in rehabilitating the entire community.
 - d) The OXFAM grant will pay for the materials to construct the units and to pay the salaries of the initial team of Bengalis who will train the non-Bengali construction team.
9. The project is part of a complete program of rehabilitation proposed by OXFAM-M.C.C. In addition to the housing and community redevelopment schemes, the following programs shall be carried out:
- a) Rehabilitation of a large tank into a fish pond, to be stocked with UNICEF fish and managed by the residents.
 - b) Planting of community vegetable gardens on interior lands to increase cash and foods for the residents.
 - c) Family planning outreach will be extended to the women working on the project.
 - d) Tube wells will be supplied to each interior space for drinking and cooling water; the runoff will be used in the gardens.

LAYOUT OF MIRPUR PROJECT

Existing Conditions

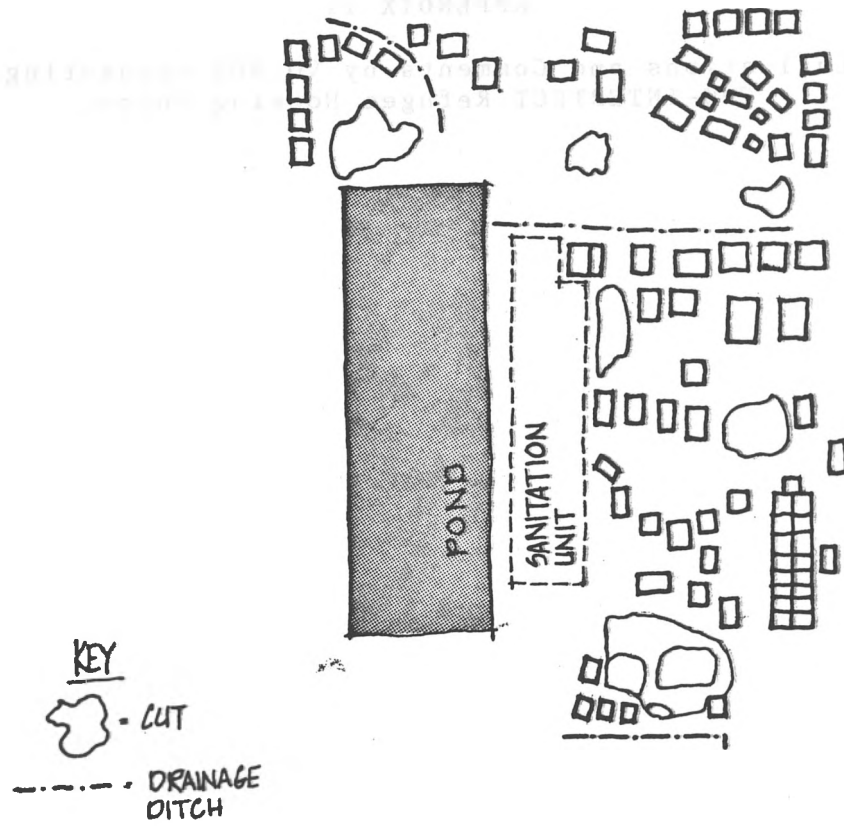

Revised Site

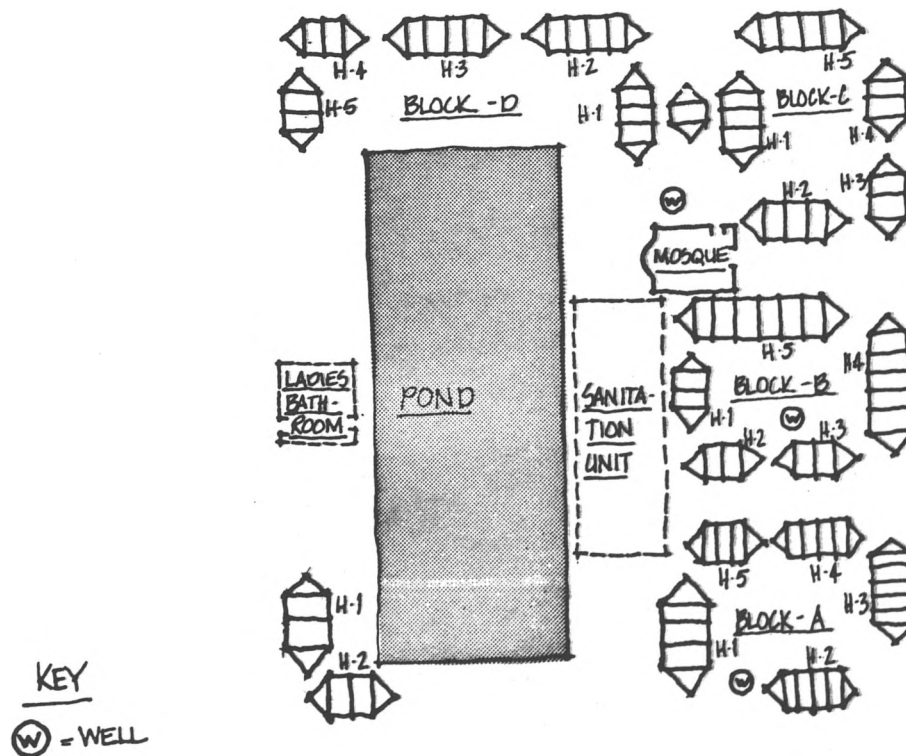

in the following

APPENDIX II

Evaluations and Comments by VOLAGS sponsoring
CMU-INTERTECT Refugee Housing Units.



Handwritten notes and a small sketch of a building layout.

in the following



Handwritten notes and a small sketch of a building layout.

Mennonite
Central
Committee

Box 785
Dacca 2
Bangladesh

Telephone
317065

Cable
MENCENCOM

MCC
A Christian
resource
for meeting
human
need

সানাইট
সেন্ট্রাল
কমিটি

বক্স ৭৮৫
ঢাকা-২
বাংলাদেশ

টেলিফোন
০১৭০৬৫

ক্যাবল
মেনসেনকম



May 13, 1975.

Frederick C. Cuny & Associates
INTERTECT
Box 10502 Dallas, Texas
75207, U.S.A.

NIRPUR HOUSING

I will try to catch you up on the progress being made in the construction of the houses. We now have the first block of houses completed and are starting to put up frames in the second block. The construction has been slower than we had anticipated, but it is starting to go faster.

The first block of houses has been completed using the shingles according to your design. People are impressed with the roofs, but most seem to think it would be too expensive for themselves, both in material and in the labour required to put it up. I discussed this with Cole and we have decided to change the roofing material for the next block of houses. Cole is getting some rolls of strong plastic sometime this week which he plans to pass on to us. We will be using it sandwiched between two sheets of bamboo matting in the traditional way. This should lower per unit costs as well as speed up construction.

About half the houses in the first block have V - shaped doors and half have square doors. Shabir says he discussed the different door designs with you. Anyway, public opinion is running heavily in favour of the square door.

The ropes used in the first houses have become quite slack since we put them up. Should these ropes be tightened, and if so, how important is it to keep them tight? I am a bit concerned that if they are too slack people will think they have no particular use and will cut them out.

Except for the "Guest House" all the houses in the first block are 7' x 12'. We've had quite a few complaints about the small size so in consultation with Rafiqu Hussain we're making the houses in the second block 10' x 12'.

The cost of the houses so far has been higher than what we had expected. Hopefully the different style of roofing will help bring the price down. Also, we have recently changed bamboo suppliers and are now getting our bamboo at a slightly lower price.

Unfortunately, about ten days ago we had a wind storm which damaged some of the older ICRC housing in the area. The next morning our bamboo craftsmen's services were in high demand, so they all come demanding higher wages. That's par for the course I suppose.

Material costs only on houses in the first block are as follows:

HOUSE	NO. OF UNITS (excluding end rooms)	PRICE PER House
No. 1	3	Tk. 4,994.80
2	5	3,948.00
3	3	3,419.25
4	4	3,638.75
5	5	3,954.90

These figures are not as exact as they might appear to be, but they are reasonably close.

We will welcome any comments you might have.

Sincerely,

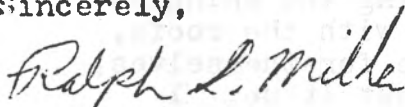

Ralph S. Miller
Program Director
Community Services

P.S. Tell Folker (spelling) the kids loved the balloons, etc.:

cc: Cole Dodge, OXFAM
Ken Koehn, MCC

Mennonite Box 785 Telephone Cable
 Central Dacca 2 317065 MENCENCOM
 Committee Bangladesh

মেনোনাইট বক্স ৭৮৫ টেলিফোন তার
 সেন্ট্রাল ঢাকা-২ ৩১৭০৬৫ মেনসেনকম
 কমিটি বাংলাদেশ



MCC
 A Christian
 resource
 for meeting
 human
 need

May 31, 1975.

Mr. Frederick C. Cuny & Associates,
 INTERPECT,
 Box 10502,
 Dallas, Texas 75207
 U.S.A.

Dear Fred:

Thanks for your letter. The plastic that we are using comes in rolls 4' 2" wide, and has about 150 yards per roll. One roll weighs 34.6 kilos and the name on the label is "Wavelock". The color is black and it has strings running through it for reinforcement. Compared to other plastic available locally it is very strong and seems like splendid stuff. I will try to get the price from Cole Dodge. Please find the enclosed sample of plastic.

Your suggestion concerning doors that hinge at the top sounds good. Shabir will be making several of the houses with these doors.

Yes, we are retaining the vent at the top of the houses. We are finding that we have too much vent on some of the houses and are having to lower the vents a bit to avoid rain blowing in. Thanks for the information concerning the ropes and also your suggestion for increasing floor space by lowering the vertical height of the houses.

The second and third blocks are now complete and we're starting on the last block. Construction goes much faster using the plastic. I will send costs on the third block as soon as possible.

Material costs, excluding plastic, on houses in the second block are as follows:

<u>House</u>	<u>No. of Units (excluding end rooms)</u>	<u>Price per House</u>
No. 1	2	Tk. 2349.00
No. 2	2	2349.00
No. 3	2	2349.00
No. 4	5	3302.00
No. 5	6	3720.75

The two houses at the south-west corner of the pond have been completed using shingles for the roof. This was before the plastic was available. Costs were as follows:

No. 1	2	4108.75
No. 2	2	4108.75

Cuny & Associates,
May 31, 1975,
Page 2.

We are having some difficulty with leaking in the houses that have the shingles. There's no problem in an ordinary rain, but we've had several rains with a lot of wind. The water blows in underneath the shingles and then drips inside. Do you have any suggestions on what we could do to stop this?

Rafiqul has been to Mirpur only once since your departure. I will try to contact him again.

Sincerely,

Ralph S. Miller,
Program Director,
Community Services.

RSM:vi

Enc.

cc Cole Dodge
Ken Koehn

P. S. I will try to send you the picture you wanted sometime next week. Cole said the price of the plastic is £3000 for 100,000 sq. ft.

House	No. of Units (including and cover)	Price per House
No. 1	5	2100.00
No. 2	5	2100.00
No. 3	5	2100.00
No. 4	5	2100.00
No. 5	5	2100.00

The two houses at the south-west corner of the road have been completed using shingles for the roof. This was before the plastic was available. Costs were as follows:

No. 1	5	2100.00
No. 2	5	2100.00

Mennonite
Central
Committee

Box 785
Dacca 2
Bangladesh

Telephone
317065

Cable
MENCENCOM

MCC

A Christian
resource
for meeting
human
need

নানাইট
স্ট্রোল
কমিটি

বক্স ৭৮৫
ঢাকা-২
বাংলাদেশ

টেলিফোন
০১৭০৬৫

তার
মেনসেনকম



June 13, 1975.

Frederick C. Cuny & Associates
INTERTECT
Box 10502
Dallas, Texas
75207

Dear Fred,

Except for a few odds and ends the housing project is finished. We finished the last house on June 7. It's hard to believe that it is the same place and the same people as before.

We made the doors in Block D as you recommended, hinged from the top, but the people don't like them. They say it makes their houses look like shops! Personally I think they will learn to appreciate the extra protection it gives them from rain and sun.

Mr. Singh was here a couple of weeks ago. I had a very pleasant and useful visit with him. He strongly suggested moving the mosque away from the sanitation unit. We recently desludged and the smell was pretty bad for several days. I discussed this with Cole and we have agreed to take action soon. Mr. Singh also suggested building a communal kitchen in each block. We'll look into this idea as time permits, but I would appreciate your thoughts. Mr. Singh also strongly encouraged a continuing appraisal and evaluation of the project.

One of the problems that has come up is the habit that people have of bathing inside their houses. The result is a small muddy drain trailing away from every house. We're trying to solve this problem by building public bathing facilities. As you will recall there is an open brick septic tank on the west side of the pond. We're putting a bamboo floor over it and will put walls around it. This will be the ladies bath house. We're also building a floating raft at each end of the pond for the men. This arrangement is according to their suggestions so it should be culturally acceptable.

Material costs on the houses excluding plastic, are as follows:

<u>House No.</u>	<u>No. of Units (excluding end rooms)</u>	<u>Price per House</u>
------------------	---	------------------------

Individual	1	Tk. 1864.50
------------	---	-------------

Block No. 3

1	3	2841.50
2	3	2841.50
3	2	2367.50
4	2	2367.50
5	4	3282.50

Block No. 3

1	3	2841.50
2	4	3290.00
3	4	3290.00
4	2	2373.50
5	2	2373.50

We have supplied the people in the first and second blocks with Papaya seedlings. The rest should be supplied within a week.

I recently sent you some black and white photographs by registered mail. Have you received them?

Sincerely,

Ralph S. Miller

Ralph S. Miller
Programme Director
Community Services

cc: Cole Dodge
Ken Koehn
Paul Myers

RSM: jmr

Mennonite
Central
Committee

Box 785
Dacca 2
Bangladesh

Telephone
317065

Cable
MENCENCOM

নানাইট
সেন্ট্রাল
কমিটি

বক্স ৭৮৫
ঢাকা-২
বাংলাদেশ

টেলিফোন
৩১৭০৬৫

ভার
মেনসেনকম



MCC

A Christian
resource
for meeting
human
need

June 20, 1975.

Mr. Frederick C. Cuny & Associates
INTERTECT
Box 10502
Dallas, Texas
75207

PICTURES

Please find the enclosed photos. A couple are not too good but I thought you might be interested.

Note the picture of the Concern School, located immediately adjacent to the first block of houses. The roof was damaged in a recent wind storm, but our houses were untouched.

Everything is going well here.

Sincerely,

Ralph S. Miller
Programme Director
Community Services

cc: Paul E. Myers
Cole Dodge

RSM:jmr

Mennonite
Central
Committee

Box 785
Dacca 2
Bangladesh

Telephone
317065

Cable
MENCENCOM

মেনোনাইট
সেন্ট্রাল
কমিটি

বক্স ৭৮৫
ঢাকা-২
বাংলাদেশ

টেলিফোন
৩১৭০৬৫

তার
মেনসেনকম



MCC

A Christian
resource
for meeting
human
need

July 28, 1975.

FREDERICK C. CUNY & ASSOCIATES
INTERTECT
Box 10502
Dallas, Texas 75207
U. S. A.

Dear Fred,

I am enclosing a general sketch of the final layout. We put second floors in Houses No.2, 3, 4, & 5 in Block A only. This was a result of complaints that the rooms were too small. The two houses isolated on the far edge of the pond do not have a second floor as such, but they do have a raised floor about 18 inches high.

We've had no real complaints of leaking for almost a month now. Most of the leaks were in Block A, which has the shingles, but people have made small adjustments and the problem seems to be well under control. I recently took shelter with a family in one of the houses during a heavy rain and didn't see a single leak.

Sincerely,

Ralph S. Miller
Program Director
Community Services

cc: Cole Dodge

RSM: jmr

**SAVE THE CHILDREN FEDERATION/
COMMUNITY DEVELOPMENT FOUNDATION**

MAILING ADDRESS
G. P. O. BOX 421. DACCA, BANGLADESH

To: Mr. Frederick Cuny
Box 10502
Dallas, Texas 75207
U. S. A.

June 19, 1975

Letter No.751065

From: David J. Hopkins
Director - SCF/CDF

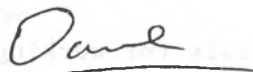

Subject: Local Material Houses

Dear Fred,

Just got back from Kunda last night at 12:00 and this morning I found your letter and slides etc. I will pass on the slides to Dilip when I go down there on Monday.

Yes, we made it to Laos in early May and out again. We managed to stay one night ahead of the Pathet Lao.

I have filled in the form you sent along with your letter. Since the rains are only just now beginning it is a bit early to pass judgement. They do seem to be slightly more fire prone than the straight walled huts though. On the other hand you can't fault their strength.

The two in Kunda are complete and are being used. Our total cost for each unit was around 1750 taka which used to be ~~\$150~~ and with devaluation becomes a little ~~less~~ ^{more} than \$100. ^{2/81}

The Chili Cook-off sounds pretty good. I will probably be in the U.S. in September but I don't think I'll be down in Texas.

Also, we will try to get you some photos of the houses in Kunda. Maybe we can get some during a flood etc.

Thanks again for your letter.

Regards.

Encl. filled in form

DJH:sb



HOUSING EVALUATION

Project: *two local material houses in Kunda village* Date: *June 20, 1975*

Agency: *Community Development Foundation*

Number of Units Built to Date 2 Since Last Report _____

1. Materials

- A. What materials were used? *Bamboo and Sungrass*
- B. Were they readily available? *Yes*
- C. Did the workers know how to use them? *After receiving instructions from team leaders.*
- D. Did the workers have tools for working with the materials? *Yes*
- E. What do you think is the re-use potential of the unit?

2. Durability

- A. How is the unit's wind resistance? *Very good*
- B. How is the unit's flood resistance? *Yet to be determined*
- C. Has the unit withstood any severe storms yet? If so, how well? *Nothing severe*
- D. Is the unit showing any signs of deterioration yet? If so, where? *No, it is still very early*
- E. Are all components working properly (windows, vents, etc.)? *Yes*

3. Acceptability

- A. Do the occupants like the structure? *They have not fully accepted the new idea as yet*
- B. What complaints do they have?

1) heat	4) security	7) leaking
2) ventilation	5) privacy	8) cost ✓
3) light ✓	6) mosquitoes	9) repairs
		10) Proud to live ✓
- C. What does the sponsoring agency/agencies think of the structure? What are the criticisms? *We feel that they are a bit expensive for the average villager. The structure is very sound, however they do not seem to be acceptable or at least desirable to the local people.*
- D. Has anyone — residents or agencies — decided to build more units? If so, who, and what problems have they had? *Not to my knowledge*
- E. Have the occupants made any additions or modifications to the unit? If so, please describe. *NO*

4. Costs (Please give as much detail as possible)

- A. Labor 690 taka : 345 TAKA each
B. Materials 924 taka : 462 " "
~~Approx 1000 taka each unit~~
C. Transport 125 taka " "
D. Other Carrying charge 305 taka : 152 taka each
per diem for supervisors plus travel 768 taka : 384 each
E. Was the project completed within the budget? If not, how much more was required and why? Slightly more than originally thought

5. Unit Data

- A. Size of Unit: Length 12' Height 10' Base 8
B. Number of families per unit: one
C. Number of persons per unit: between 3 and 6
D. Floor space per family:
E. Does unit have second floor? No
F. What modifications have been made to the design?
were omitted None except windows
Were these to: 1) reduce costs
2) speed construction
3) other Safety from thieves
G. Comments on size or occupancy:

6. Miscellaneous

- A. Please describe any additional technical assistance that is/was required? Two men from Dacca went to Kurda to supervise the construction.
B. Did the people we trained do a good job? I think most of the work was done by the two men from Dacca
C. Were the materials we provided adequate? Yes
D. Did we meet all our commitments to you? If not, please describe problems. Yes
E. Any other comments or problems not covered above:

HOUSING EVALUATION

Project: DEMRA CAMP

Date: June 17 1975

Agency: BDRC (Bangladesh Red Cross Soc)

Number of Units Built to Date 1 Since Last Report 1

1. Materials

- A. What materials were used? Bamboo with grass roof
- B. Were they readily available? Yes
- C. Did the workers know how to use them? Yes
- D. Did the workers have tools for working with the materials? Yes
- E. What do you think is the re-use potential of the unit? Good
(new roofing needed)

2. Durability

- A. How is the unit's wind resistance? Not tested.
- B. How is the unit's flood resistance? People living on ground level.
- C. Has the unit withstood any severe storms yet? If so, how well?
No
- D. Is the unit showing any signs of deterioration yet? If so, where?
Yes, roof leaking
- E. Are all components working properly (windows, vents, etc.)?
No doors mounted.

3. Acceptability

- A. Do the occupants like the structure? Yes, with reservations.
- B. What complaints do they have?
 - 1) heat
 - 2) ventilation
 - 3) light
 - 4) security
 - 5) privacy
 - 6) mosquitoes
 - 7) leaking
 - 8) cost
 - 9) repairs
- C. What does the sponsoring agency/agencies think of the structure?
What are the criticisms?
House not constructed according to specifications
Costs higher than initially indicated
- D. Has anyone -- residents or agencies -- decided to build more units? NO
If so, who, and what problems have they had?
Probably, BDRC will not build more now.
- E. Have the occupants made any additions or modifications to the unit?
If so, please describe. NO

4. Costs (Please give as much detail as possible)

- A. Labor 165 Taka
B. Materials 800 Taka (NO BAMBOO MATS)
C. Transport 0
D. Other
E. Was the project completed within the budget? If not, how much more was required and why? NO (1 house, 1 family 500 T agreement. Double family structure built)

5. Unit Data

- A. Size of Unit: Length ? Height ? Base ?
B. Number of families per unit: 2
C. Number of persons per unit:
D. Floor space per family:
E. Does unit have second floor? NO
F. What modifications have been made to the design? Grass roof

Were these to: 1) reduce costs Probably
2) speed construction
3) other

- G. Comments on size or occupancy:

6. Miscellaneous

- A. Please describe any additional technical assistance that is/was required? Ref. V Hartkopf
B. Did the people we trained do a good job? Roof not adequate
C. Were the materials we provided adequate?
D. Did we meet all our commitments to you? If not, please describe problems. Roof, not as specified
E. Any other comments or problems not covered above:

People in the camp were generally sceptical, but except for leakage the house performed according to expectations.

APPENDIX 3
TECHNICAL DATA

- | | | |
|---|--|-----------------------------|
| 1. Best angles for apex: (wood) | 45° | |
| Best angles for apex: (bamboo) | 45° | |
| 2. Maximum wind loading - roof: (wood) | 50 mph | dependent on |
| Maximum wind loading - roof: (bamboo) | | roof material |
| 3. Maximum wind loading - frame: (wood) | 150 mph | |
| Maximum wind loading - frame: (bamboo) | 120 mph | |
| 4. Design capacity (persons): | 10/unit | |
| 5. Optimum height: (wood) | | function of design capacity |
| Optimum width (at base): (wood) | | |
| 6. Optimum height: (bamboo) | | function of design |
| Optimum width (at base): (bamboo) | | |
| 7. Recommended size for single family: | d = 21 ft | |
| 8. Recommended size for multi-family (with number
of units): | 7'/unit/family | |
| 9. Optimum materials (length vs. diameter): (wood) | 6" dia per 29 ft | |
| 10. Optimum materials (length vs. diameter): (bamboo) | 4"-6" dia. per 29 ft
(function of wall thickness) | |

DN-AAA-069
ARC No. 301.54 G655
817/76