

**THE CARGO OF THE STEAMBOAT *HEROINE* AND THE ARMY
OF THE FRONTIER, 1838**

A Thesis

by

NINA MAYON CHICK

Submitted to the Office of Graduate and Professional Studies of
Texas A&M University
in partial fulfillment of the requirements for the degree of

MASTER OF ARTS

| | |
|---------------------|--------------------------------|
| Chair of Committee, | Kevin Crisman |
| Committee Members, | James C. Bradford |
| | Luis Filipe M Vieira De Castro |
| Head of Department, | Cynthia A. Werner |

May 2015

Major Subject: Anthropology

Copyright 2015 Nina Mayon Chick

ABSTRACT

In spring of 1838, the *Heroine* steamed up the Red River carrying subsistence supplies for the U.S. Army garrison at Fort Towson, Choctaw Nation. Two miles from its destination, it struck a snag and sank. Rediscovered in 1999, the site was excavated between 2001 and 2008 by the Oklahoma Historical Society, The Institute of Nautical Archaeology, and Texas A&M University, with Dr. Kevin Crisman of Texas A&M as principal investigator. Though most of the cargo had been salvaged, excavators recovered remains of barrels, including three intact pork barrels, and cargo-handling tools. The purpose of this thesis is two-fold: to describe the historical context for *Heroine*'s last cargo and to explain hand-cooperage technology as a basis for understanding barrel remains.

The 1830s saw rapid population growth and westward expansion, and rivers were the great highways for settlers and commerce. At the forefront was the Army of the Frontier, thinly spread in a line of forts reaching from the Red River to Canada. Fort Towson guarded the U.S. border with Mexico and, later, the Republic of Texas, but its first mission was protection of eastern tribes relocated to Indian Territory in the Indian Removals. This thesis traces the history of subsisting the army from 1775 to the creation of the Commissariat of Subsistence in 1818 under Colonel (later Major-General) George Gibson, and discusses the composition and use of the ration as reflections of contemporary medical knowledge and cultural expectations. The events surrounding the loss of the *Heroine* illustrate the system of supply under the Commissariat. This account

is taken from correspondence between Gibson, Lieutenant Colonel Josiah H. Vose, commander of Fort Towson, and the contractors William S. Sullivant and Christopher Niswanger, of Ohio.

The Catalog of Cargo-Related Artifacts includes descriptions of barrel remains, faunal remains (pig bones), and cargo-handling tools recovered in the Red River Project.

DEDICATION

This is dedicated to the one I love,

David Fenton Chick, Sr.

ACKNOWLEDGMENTS

The writing of this thesis has been a long road, and many were the kind folks who helped me on the way. First and foremost, I want to thank Kevin Crisman, chair of my thesis committee, master of the nautical program's New World Lab, and technical artist extraordinaire. Kevin hired me as a research assistant and introduced me to the exacting world of archaeological drawing, offered me the *Heroine* cargo for a thesis topic and tolerated my bits and pieces of barrels cluttering-up his lab for months on end. He sets a high standard to aspire to.

I would like to thank committee members James C. Bradford, whose timely editorial comments were much appreciated, and Luis Filipe Vieira De Castro, who introduced me to the wonders of ancient ship construction and the documentation thereof.

Many thanks also go to Cindy Hurt and Rebecca Luz in the Anthropology office, always helpful, friendly, and efficient.

Rebecca Chase and Amanda Pena were undergraduate assistants who did much of the tedious work of measuring and describing the artifacts. Their invaluable help with the cooperage study is much appreciated.

Special thanks go to Candace Schaefer, Nancy Vazquez and others who facilitate the thesis and dissertation writing groups in the University Writing Center for creating a community of writers and letting me be a part of it. Kathy Clark, then director of the

English Language Institute, gave me a teaching assistantship that provided not only income, but office and writing space. Her personal encouragement has been much appreciated as well.

I would like to thank my friends and classmates Dana Perterman, Katherine Sinsich, and Bradley Krueger.

I have seen editors acknowledged by many authors and thought, “That’s nice,” but never truly appreciated what editors contribute to a manuscript. Rhonda Brinkman has been amazingly helpful and supportive, and I could not have finished this thesis without her.

Thanks go to the good folks at the Denny’s restaurants on Hwy 6 and on Texas Avenue and at Starbucks around town—where congenial study space can be rented for the price of a cup of coffee.

And last but certainly not least, I thank my long-suffering family for putting up with me while I followed my archaeological dreams.

TABLE OF CONTENTS

| | Page |
|--|------|
| ABSTRACT | ii |
| DEDICATION | iv |
| ACKNOWLEDGMENTS..... | v |
| TABLE OF CONTENTS | vii |
| LIST OF FIGURES..... | xi |
| LIST OF TABLES | xii |
| CHAPTER I INTRODUCTION: A SHIPWRECK IN OKLAHOMA | 1 |
| An Ordinary Steamboat..... | 1 |
| The Red River Project | 6 |
| Organization of This Thesis | 9 |
| CHAPTER II THE FRONTIER AND THE ARMY OF THE WEST IN THE 1830s | 10 |
| America in the 1830s..... | 10 |
| The State of the Nation..... | 11 |
| The Indian Problem..... | 14 |
| The West | 15 |
| Cities on the Rivers | 16 |
| River Transportation | 17 |
| Ports and Landings | 20 |
| River-Borne Trade..... | 21 |
| <i>Heroine's</i> Cargo | 22 |
| Doing Business in the 1830s | 27 |
| The Army of the Frontier | 29 |
| The Army and the Western Economy | 29 |
| Garrison Life | 31 |
| Fort Towson | 32 |
| Supplying Fort Towson..... | 36 |

| | Page |
|--|------|
| CHAPTER III COOPERAGE..... | 42 |
| Some Terminology | 42 |
| A General History of Cooperage..... | 43 |
| Origins of Staved Containers | 43 |
| Medieval and Early Modern Periods..... | 45 |
| Cooperage in the New World..... | 46 |
| Regulation and Standardization | 47 |
| Marks | 49 |
| Some Universal Principles | 50 |
| Types of Cooperage | 52 |
| White Cooperage..... | 53 |
| Tight/Wet Cooperage | 53 |
| Slack/Dry Cooperage | 54 |
| Barrel Construction | 56 |
| Barrel Parts..... | 57 |
| Before the Cooper | 59 |
| At the Cooperage..... | 61 |
| Raising the Case | 64 |
| Chiming the Ends of the Case | 66 |
| Cleaning the Case..... | 70 |
| Making the Heads..... | 70 |
| Installing the Heads..... | 72 |
| Finishing the Barrel..... | 73 |
| Physics of Barrels..... | 73 |
| Robustness of Barrel Design | 73 |
| The Cooper's Skill | 77 |
| Barrels on the Move | 80 |
| Tools for Moving Barrels | 82 |
| Stowage | 85 |
| The End of the Age of Barrels | 89 |
| Remembering and Appreciating the Humble Barrel..... | 91 |
| CHAPTER IV SUBSISTING THE U.S. ARMY | 93 |
| Introduction | 93 |
| Legislative and Administrative History of U.S. Army Subsistence..... | 94 |
| The Revolutionary War Period | 94 |
| The Interim Period | 97 |
| Contract Supply Fails the Test of War | 99 |

| | Page |
|---|------|
| Congress Acts: The Commissariat of Subsistence | 105 |
| The Commissariat of Subsistence | 109 |
| The Ration | 110 |
| The Ration as Legislated | 111 |
| Nutritional Wisdom of the Day | 112 |
| Establishing the Ration under the Commissariat | 115 |
| The Ration in 1837 | 117 |
| The Sutler's Store | 118 |
| Post Gardens | 119 |
| Other Sources | 119 |
| Food in Garrison | 120 |
| The Officers Mess | 121 |
| Enlisted Messes | 122 |
| Uses of the Ration | 123 |
| Bread | 123 |
| Soup | 124 |
| The Small Parts of the Ration | 125 |
| Preservation Issues and the Importance of Barrels | 126 |
| In Transit | 126 |
| Provisions after Delivery | 129 |
| Conclusion | 131 |
| | |
| CHAPTER V IN CONCLUSION: FORT TOWSON AND THE WRECK OF THE <i>HEROINE</i> | 133 |
| Introduction | 133 |
| The Main Correspondents | 134 |
| Fort Towson, Spring 1838 | 139 |
| <i>Heroine's</i> Last Cargo | 145 |
| Call for Proposals | 145 |
| Niswanger and Sullivant's Proposal | 149 |
| The Contract | 150 |
| Cincinnati: Gathering the Cargo | 155 |
| The Cargo in Transit | 157 |
| Snagged, Sunk, and Salvaged—the Loss of the <i>Heroine</i> | 161 |
| After the Wreck: 'Til the Paperwork is Done | 162 |
| Afterward | 173 |
| The Men Most Closely Involved with <i>Heroine</i> and Its Cargo | 175 |
| Conclusion | 177 |

| | Page |
|--|------|
| REFERENCES | 180 |
| APPENDIX: CATALOG OF CARGO-RELATED ARTIFACTS | 188 |

LIST OF FIGURES

| | Page |
|---|------|
| Figure I-1 Map of the Western Rivers, 1832-1838. | 2 |
| Figure I-2 The Western River Steamboat <i>Heroine</i> , Plan of Wreck. | 8 |
| Figure III-1 Barrel Parts. | 58 |
| Figure III-2 Timber conversion for barrel staves. | 61 |
| Figure III-3 Wood hoops. | 62 |
| Figure III-4 Preparing the Stave. | 64 |
| Figure III-5 Assembling the Case. | 67 |
| Figure III-6 Finishing the Ends of the Barrel. | 68 |
| Figure III-7 Measuring for Capacity and an Un-crozed End. | 69 |
| Figure III-8 Making the Heads. | 71 |
| Figure III-9 “Sublime in Profanity.” | 83 |
| Figure III-10 Slings and Hooks. | 84 |
| Figure III-11 “Deluged and Careened.” | 86 |
| Figure A-1 Plan of <i>Heroine</i> Showing Distribution of Cargo-related Artifacts. | 192 |
| Figure A-2 Provenience Grid | 192 |

LIST OF TABLES

| | Page |
|--|------|
| Table V-1 Niswanger and Sullivant's 1837 Proposal for Fort Towson Subsistence Contract | 149 |
| Table V-2 Subsistence Department Statement of Niswanger and Sullivant's Account and Calculation of Damages to Government | 170 |
| Table V-3 Third Auditor's Statement of Niswanger and Sullivant's Account | 171 |

CHAPTER I

INTRODUCTION: A SHIPWRECK IN OKLAHOMA

AN ORDINARY STEAMBOAT

In the spring of 1838, a side-wheel steamboat waited at Jonesborough, Republic of Texas, for the Red River to rise. It was *Heroine* out of Shreveport, Louisiana, with a cargo of provisions for the United States Army garrison at Fort Towson, Choctaw Nation (now Oklahoma), about 4 mi (6.4 km) farther upriver. (Figure I-1) *Heroine's* presence in this part of the Red River was only possible because of Captain Henry Shreve's success in clearing a channel through the Great Raft, an enormous log jam that obstructed the Red River for over 160 mi (256 km). Previously, the Raft had been passable only at high water levels and by much smaller vessels than *Heroine*.

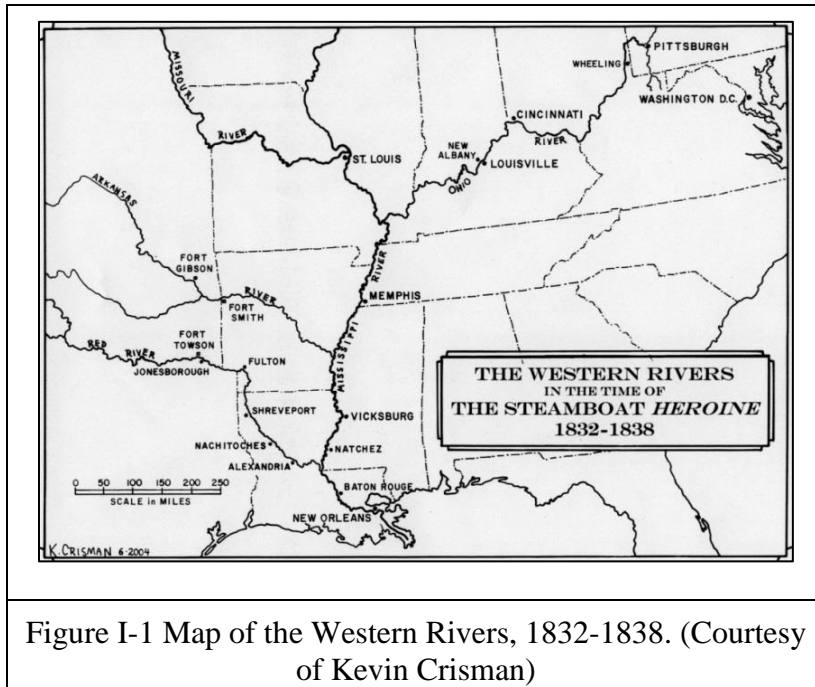

Figure I-1 Map of the Western Rivers, 1832-1838. (Courtesy of Kevin Crisman)

Heroine, built on the Ohio River in 1832 at a New Albany, Indiana, boat yard, was typical of early western river steamboats. Its 136 ft 8 in (41.65 m) length and 160 ton (144 mt) rating was about average for its period. The hull had a narrow moulded breadth of 20 ft 4 in (6.19 m), but the “guard,” an extension of the main deck beyond the hull on either side, gave the vessel a 36 ft (10.97 m) breadth of deck.¹ Constructed of strong white oak, it was nevertheless lightly built—its slim frame timbers, for example, were widely spaced along the keel, which was itself a timber only slightly thicker than adjacent hull planking.² Flat-bottomed and lightweight, *Heroine*’s shallow draft could

¹ Crisman, Lees, and Davis, “Western river steamboat,” 372.

² Crisman, “*Heroine* of the Red River,” 8.

navigate shifting river channels. If it did run aground or strike an obstacle, the semi-flexibility of the hull was meant to limit damage. *Heroine*'s wood-fired boilers powered two side paddlewheels 15 ft (4.6 m) in diameter. Most parts of the machinery were made of cast iron, a brittle material prone to breakage when stressed. Fortunately, the relatively simple technology could be repaired by men with basic skills and simple tools even in the remote regions traveled by such boats. Indeed, *Heroine*'s machinery had been much patched and repaired.³ With six years on the rivers, it was already considered an old steamboat.

During its career, *Heroine* had plied the Mississippi and Ohio Rivers and the lower reaches of the Missouri and Red Rivers. In early 1838, it was running a scheduled packet service for passengers and freight between Vicksburg, Mississippi, and towns of the lower Red River.⁴ As on most steamboats of the time, first class passengers traveled in individual berths on the upper deck with separate men's and women's salons and regular meals served. Steerage passengers found space where they could on the main deck amid firewood, machinery, and cargo and fended for themselves at mealtimes.⁵ *Heroine* was equipped to carry a wide variety of cargo stowed on the main deck and in the hold that ran nearly the length of the vessel. In May 1838, *Heroine*'s cargo consisted of barrels of pork, flour, beans, and salt, and boxes of soap and candles for Fort Towson.

³ Ibid., 8-9.

⁴ Ibid., 9-10.

⁵ Ibid., 9.

Additional cargo “on private account” was rumored to include barrels of whisky for the sutler at Fort Towson.⁶

An account of the loss of the *Heroine* was recorded by W.W. Wittenbury, himself a retired steamboat captain, in a series of reminiscences published in the *Cincinnati Commercial* in 1870 and 1871. He had heard the story about two years after the event and misremembered the name of the vessel as *New York*, but it is clear he wrote of the demise of the *Heroine*. After negotiating the Great Raft, according to Wittenbury, *Heroine* “reached Jonesboro with much difficulty, and [having] failed, after repeated attempts, to get over the next ‘crossing’ [stretch of low water], she dropped back to the town on the Texas side, where there was good [deeper] water and a better opportunity for social enjoyment and legitimate trading than on the ’Nation side, or among the snags in the middle of the river.”⁷

Heroine’s captain, according to Wittenbury, then waited at Jonesborough for the river to rise. Finally, an old keelboat pilot approached him, claiming that he could guide the vessel without difficulty to the public landing where the warehouse for Fort Towson stood. Townspeople advised against a premature attempt at negotiating the low waters, but the captain decided to risk it. On the bright morning of May 6, 1838, wrote Wittenbury, *Heroine* “steamed away from her comfortable moorings, [while] the whole populace stood upon the bank waving their adieus, and watching with doubts and fears

⁶ Wittenbury, “Red River Reminiscences,” January 8, 1871, 3. The series of letters to the newspaper was signed “Outsider.” Wittenbury was identified as the author in the August 24, 1871 edition of the *Cincinnati Commercial* and through internal evidence in the letters. Wittenbury, *Captain W.W.*, xii-xiii. The name was sometimes misspelled as “Wittenbury.”

⁷ *Ibid.*

her slow progress. Not a half an hour had passed when she suddenly stopped, swung around, and careened over, and the cry ‘She’s sunk! She’s sunk!’ went through the crowd like a flash and true enough she did sink, and there she lies to this day.”⁸

Heroine had hit a snag, a submerged log, which ripped a great tear in its port side.⁹ No one was killed, but *Heroine* was damaged beyond repair. The crew, aided by townspeople and a contingent of soldiers from Fort Towson, were able to save much of the cargo. More might have been saved but, “In a very few days after the accident, there came a sudden rise in the river and drove the wreckers away, and when the waters subsided again, the [*Heroine*] was so buried in the shifting sands as to be nearly out of sight.”¹⁰ Two years later, Wittenbury himself was making a delivery to Fort Towson when he “found much difficulty in passing over the bar where the [*Heroine*] was sunk and still to be seen....”¹¹

The steamboat would not be seen for long, however. The great flood of 1843 caused the river to change course, and *Heroine*’s resting place was eventually buried under some 20 to 30 ft (6.1 to 9.1 m) of river sediments. There it remained undisturbed for 148 years until another great flood in 1990 shifted that part of the river back to its old course, and the wreck was once again exposed.¹²

⁸ Ibid.

⁹ Crisman, “*Heroine* of the Red River,” 10.

¹⁰ Wittenbury, “Red River Reminiscences,” January 8, 1871, 3.

¹¹ Ibid.

¹² Crisman, “*Heroine* of the Red River,” 10.

THE RED RIVER PROJECT

In 1999, the Oklahoma Historical Society (OHS) learned of the shipwreck in the Red River and began investigations. Surveys and test excavations carried out in 2001 and 2002 found that the vessel was an early side-wheel steamboat about 140 ft (42.67 m) long. Several lines of evidence led researchers to its date and identity.¹³ First, the wreck's paddlewheels had been moved by a single, center-mounted piston—a technology made obsolete by twin-engine designs in the early 1840s; the vessel must have been constructed before then. The location of the wreck was highly significant; it would have been impossible for such a large steamboat to voyage so far up the Red River before Henry Shreve first opened the Great Raft in March 1838, nor could it have sunk in that spot any time after the great flood of 1843 that changed the river's course. *Heroine* is the only steamboat whose size, type, and location of sinking matched those of the Red River wreck under investigation. The first corroborating evidence for this identification was excavated in 2004: a barrelhead labeled "USA," indicating property of the United States Army, part of *Heroine*'s known final cargo.¹⁴

OHS teamed with the Institute for Nautical Archaeology (INA) and Texas A&M University (TAMU) to excavate and study the wreck. Full-scale excavations under the direction of Dr. Kevin Crisman of TAMU were carried out in summer and fall seasons from 2003 to 2006, with a short season in fall 2008 for the removal of some of *Heroine*'s heavy machinery. The Conservation Research Laboratory, part of the Center for

¹³ Ibid., 4.

¹⁴ Crisman and Brown, "News from the Red River," 4.

Maritime Archaeology and Conservation at TAMU, is charged with the conservation of all finds from the project.

Several tons of *Heroine*'s iron machinery were recovered for study, but because of the great expense involved in preserving and displaying or storing a vessel of this size, nearly all of the wooden parts of *Heroine* were left in the river. However, divers recorded hull measurements, curves, and construction techniques in great detail so that accurate drawings could be made of *Heroine*'s present condition, and its original design could be reconstructed. The complete rudder and a 10 ft (3.5 m) section of the port guard were removed and conserved for eventual museum display.

Though none of *Heroine*'s superstructure survived, and in spite of the efficiency of early salvagers and the river currents in removing objects from the wreck, hundreds of artifacts were recovered from the site for conservation and study. Some were related to the operation of the steamboat, such as rigging blocks, a heap of rope, numerous nails, spikes, iron wedges, and hundreds of bricks from the lining of the firebox. Several hand tools have been found, among them an iron wrench, a c-clamp, a hammer, and a wooden mallet, as well as a tole-painted tin box filled with nails. Among the personal possessions found were a boot and several shoes (no pairs), buttons, a small tin wash basin (crushed), an iron stirrup, bits of broken dishes and glass, and a nearly complete saucer with pink lusterware decoration. Some finds were clearly not original to *Heroine* but had washed in on river currents. Shards of Native American pottery and the bones of animal species found in or near western rivers are in this category, as are pieces of barbed wire (not yet invented in 1838) and a little blue plastic helicopter.

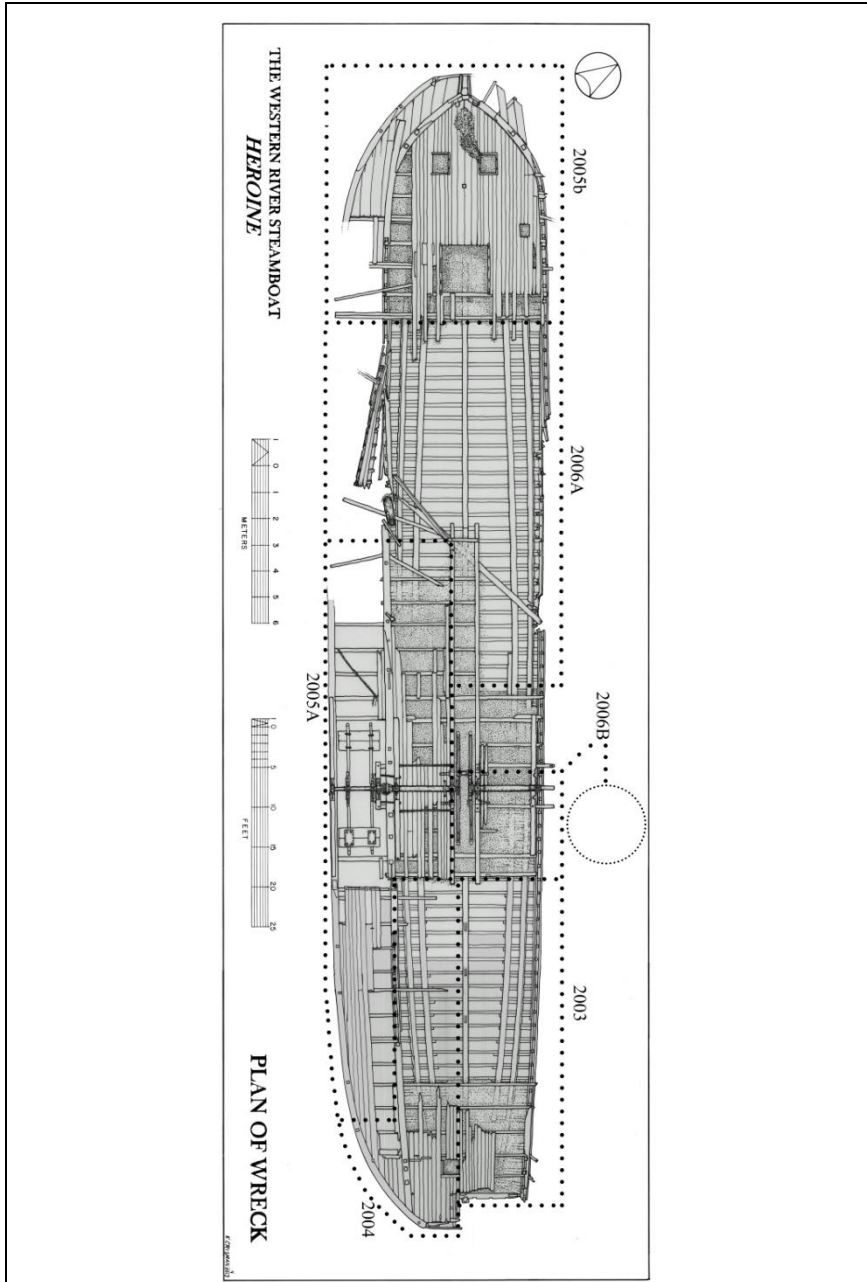

Figure I-2 The Western River Steamboat *Heroine*, Plan of Wreck. Drawing shows condition of *Heroine* at time of excavation but without the twisting of the hull. (Courtesy of Kevin Crisman)

Fortunately for the present study, most cargo-related artifacts are clearly identifiable as such and consist primarily of remains of barrels that contained the Army provisions. Most of these were found amidships in the port side of the hold, where the river quickly silted-in the unsalvaged cargo. A variety of iron cargo-handling implements was also found—such as cotton bale hooks, can hooks for lifting barrels, and two iron-wheeled handcarts or dollies.

ORGANIZATION OF THIS THESIS

This thesis provides the historical context for the final cargo of the steamboat *Heroine*. Chapter II places the wreck and its cargo in the context of the nation in the 1830s. It discusses transportation and commerce on western rivers, the Army of the frontier, and Fort Towson. To better the understanding and appreciation of the archaeological remains of the cargo, Chapter III explores the history and development of cooperage technology and the qualities that made barrels essential containers of commerce for over two millennia. Chapter IV traces the problems of subsisting the Army from Revolutionary War days to the 1830s and beyond. It explains how the administrative system under which Fort Towson was supplied in 1838 came to be, describes items that made up the ration and how they were used, and discusses some of the difficulties involved in keeping the U.S. Army fed. Chapter V recounts the story of the final cargo from newspaper announcements of the subsistence contract of 1837 to the wreck of the *Heroine* and loss of the cargo in 1838 and the long aftermath. An illustrated listing of the Cargo-related artifacts recovered from *Heroine* is provided in the Appendix.

CHAPTER II
THE FRONTIER AND THE ARMY OF THE WEST
IN THE 1830s

AMERICA IN THE 1830s

Heroine plied the western rivers from 1832 until 1838, one of thousands of steamboats, keelboats, flatboats, and other vessels linking cities, towns, and isolated landings up and down the Mississippi and Ohio Rivers and their tributaries. This was a period of relative peace between major wars: the War of 1812 was long over, and there would not be a major mobilization until the Mexican-American War in 1846. Surviving veterans of the American Revolution were now old men, and the youth who would fight in the armies of the Civil War were still boys or had yet to be born. The early nineteenth century has been described as the “Adolescence of the United States.” Americans were loud and boastful, full of energy and movement, and optimistic about prospects for a glorious national and personal future.¹⁵

For Americans of this era, their democracy was the ideal form of government, a model for the world. America was a modern, progressive nation; signs of material and social progress could be seen everywhere. Americans prided themselves on their individualism, their self-reliance, and their hard-working pursuit of land, wealth, and

¹⁵ Riegel, *Young America*, 22.

happiness. Though the term “Manifest Destiny” had yet to be coined, expansion into the interior of the North American continent was well under way, and the frontier was being pushed ever westward. In the vanguard of settlement, pioneering soldiers served in U.S. Army posts from the Great Lakes region to the Indian Territories of the Southwest.

The State of the Nation

The 1830s saw the American population increase from 13 to 17 million. Though there was some foreign immigration, mostly from Ireland and Germany, the rise was primarily the result of high birthrates among native-born Americans.¹⁶ Arkansas and Michigan were admitted to the union as the 25th and 26th states, respectively, and Iowa was organized as a territory. Eastern cities and towns continued to grow and prosper. Opportunities for economic advancement were proliferating: by investment in lands and in industry (if one had capital) or by wage earning (if one did not). The nation was, however, predominantly agrarian. Plantations, cotton, and slavery were features of the South, but most Americans, including southerners, lived on small subsistence farms. On these establishments, they raised crops and livestock for their own needs and perhaps a few acres of a cash crop. They traded surpluses for other necessities and a few small luxuries. Life could be quite primitive, especially in newly settled areas. It was not unusual for a frontier family to have only a small vegetable garden or none at all to supplement their regular diet of salt pork and cornbread.¹⁷

¹⁶ Ibid., 31.

¹⁷ Ibid., 89.

This was the era of Jacksonian Democracy and the Rise of the Common Man, when nearly all white male citizens had secured the right to vote. In the religious sphere, the Second Great Awakening was in full force. Revivals swept the nation, especially in the Northeast and the West; church attendance rose, and believers were encouraged to make the world a better place. Reformers, often encouraged by their religious convictions, addressed what they perceived as social ills, campaigning for temperance, homes for orphans and the handicapped, prison reform, and even birth control.¹⁸ Nat Turner's Rebellion in 1831 sparked renewed debate over slavery issues and energized both pro- and anti-abolitionists. Internationally, Texans won their independence from Mexico in 1836, and the Republic of Texas was recognized by the United States the following year.

The economy was expanding, though not without its crises, as when Andrew Jackson's banking policies provoked the Panic of 1837. Nevertheless, national and regional economies were benefiting from innovations in various fields. Inventors emphasized practical improvements in manufacturing, transportation, and agriculture. Steam power was being adapted to many purposes. Some factories turned out large machinery for farms, mills, and other industries, while others produced items, such as textiles and shoes, that had previously been made at home. Though electricity was little understood at the time, the first American electric motor was built in 1834 to run a

¹⁸ Ibid., 17-18, 228-229.

printing press and a model railroad.¹⁹ The movement of people and their goods was becoming more efficient as roads were improved and extended, more canals were dug to connect river and lake waterways, and steam-powered vessels became more common. The first short, primitive railways were being established in the East; railroad promoters worked energetically to overcome financial and technological obstacles to further their vision of a great railroad network connecting the nation. In agriculture, innovations in scientific stock-breeding and methods for increasing crop yields were reported in regional and local farm journals.²⁰

Science and education saw progress as well. Oberlin College in Ohio allowed women into its degree granting programs in 1837.²¹ American scientists, both professional and avocational, were dedicated to classifying the plants, animals, and minerals of North America and exploring its varied geography. Acceptance by the U.S. Congress of James Smithson's legacy in 1836 would result in the founding of the Smithsonian Institution a decade later. During this time, Samuel Morse publicly demonstrated his telegraph apparatus and its code for the first time, Samuel Colt invented his revolver, John James Audubon painted birds and other wildlife, and Abraham Lincoln was elected to the Illinois State Legislature. Americans of note born in the 1830s include Louisa May Alcott and Samuel Clemens, Andrew Carnegie and John D. Rockefeller, John Wilkes Booth and George Armstrong Custer.

¹⁹ Ibid., 328.

²⁰ Ibid., 7.

²¹ Ibid., 250.

The Indian Problem²²

Conflict between white European settlers and their descendants and the original inhabitants of North America had been part of the American story for over 200 years. Whites moving westward from the Atlantic seaboard in ever-increasing numbers had gradually displaced Native Americans from most eastern regions until, by the 1830s, white populations were firmly in control of all the lands east of the Mississippi River. Some of these regions, however, particularly in the South and the Old Northwest, were far from empty of Native Americans. In the South alone, 60,000 members of the Five Civilized Tribes—Choctaw, Chickasaw, Creek, Cherokee, and Seminole—held some 18 million acres.

Under pressure from white settlers eager to acquire Indian lands, politicians sought a solution to the “Indian problem.” They devised a plan, formalized by passage of the Indian Removal Bill in 1830, to relocate eastern tribes to permanent homes west of the Mississippi River in what is now Oklahoma—marginal lands of no interest to white settlers at that time. Under the protection of the U.S. Army, each tribe would have its own allotted land, from which white settlement would be barred.

The tribes were less than enthusiastic about the prospect of moving. Some fought the Removals through the legal system, taking their cases as far as the U.S. Supreme Court. Others resisted violently. In 1832, Black Hawk of the Sac and Fox with several hundred warriors attempted to reclaim their Illinois home-lands in a war that lasted

²² This section was taken from Riegel, *Young America*, 58-63.

several months and resulted in many deaths among both whites and Indians. In the winter of 1835-1836, the Seminoles of Florida fled into the swamps. From there, they carried on armed resistance until finally overcome by the Army in 1842.²³ In whatever ways the tribes resisted the Removal acts, however, the ultimate outcomes were the same: forced relocation of eastern tribes to Indian Territory. The infamous Cherokee Trail of Tears is only the most well-known of the tribes' ordeals. By the 1840s, most Native Americans were gone from east of the Mississippi.

THE WEST

America's western frontier in the 1830s extended from the present states of Minnesota and Wisconsin in the north through Iowa, eastern Nebraska and Kansas, to Oklahoma in the south. South of the Oklahoma Territories and west of the state of Louisiana was the international border with Mexico and, after 1836, the Republic of Texas. Lands east of the frontier were being filled with hopeful settlers and entrepreneurs who followed the Ohio and Mississippi Rivers and their tributaries in search of land and opportunity. Roads were few and generally poor; travel by stage coach or wagon was slow, rough, and dangerous and to be avoided for long journeys if at all possible.

²³ After this conflict, some of the Seminoles were removed west, while others were confined to a reservation in southern Florida. This was the second of the "Seminole Wars" fought by the U.S. Army. The first occurred in the 1810s when Florida still belonged to Spain; after the Third Seminole War in 1859, which reflected Seminole response to renewed removals, only a few isolated bands and families remained in Florida.

Water transportation, in contrast, was cheaper, faster, safer, and more comfortable—much preferred for distance travel or the transport of heavy loads. The rivers also had their dangers, however. Powerful currents, narrow channels, and constantly shifting sandbars challenged navigators. Water levels could change suddenly, high water increasing the currents, low water leaving channels impassable. Submerged tree trunks and other obstructions could rip out a vessel's bottom. Low water and winter ice regularly prevented navigation for months at a time.

Cities on the Rivers²⁴

At the northern end of the Ohio-Mississippi waterway, Pittsburgh—the Gateway to the West—was a transportation crossroads and manufacturing center, producing iron machinery and hardware, steam engines, glass, and other products. Use of soft coal in its industries had already given it a reputation for soot and smog-filled skies.²⁵ Cincinnati, over 450 mi (724 km) downriver, called itself the Queen of the West. It boasted attractive houses and numerous churches as well as cultural, charitable, and educational institutions.²⁶ In 1830, it was the seventh largest city in the nation and a major trade, banking, and commerce center with a thriving harbor.²⁷ Manufacturing, too, was strong—Cincinnati boasted fourteen iron foundries and ten machine shops with products

²⁴ Miles between cities via river transport were calculated using tables in the National Oceanic and Atmospheric Administration's *Distances between United States Ports*, 22-23, then rounded to the nearest five. River distances between points tend to be somewhat greater than straight-line distances, or even modern driving distances, owing to the bends and loops in a river's course. Because rivers change course due to natural forces or human modifications, the figures provided should be considered approximations of distances traveled by riverboats in the 1830s.

²⁵ Riegel, *Young America*, 42.

²⁶ Lyford, *Western Address Directory*, 277-278.

²⁷ Riegel, *Young America*, 53.

ranging from steamboat engines to printers' type.²⁸ In 1837, twenty-one packing houses were engaged in the growing pork processing industry.²⁹

Louisville, Kentucky, 130 mi (209 km) downriver from Cincinnati, was *Heroine's* home port. The Ohio River flowed into the Mississippi 380 mi (642 km) downriver from Louisville. Another 195 mi (313 km) up the Mississippi River from the mouth of the Ohio stood Saint Louis—Gateway to the Far West—at the mouth of the Missouri River. Over 1,050 mi (1,680 km) south of Saint Louis, the port of New Orleans rivaled that of New York. Vessels from the interior of the nation met ocean-going ships from the East Coast and from foreign lands, making New Orleans the major import/export center for the South and West. *Heroine* traveled often down the Mississippi to New Orleans, stopping at Cairo, Memphis, Vicksburg, Natchez, and other small towns along the way and sometimes venturing up the Missouri and Red Rivers and other tributaries.³⁰

River Transportation

The steamboat *New Orleans*, first of its kind on western rivers, steamed out of Pittsburgh headed for its namesake city in 1811. Twenty-five years later, an observer would write that “the Introduction of steamboats upon western waters...contributed more than any other single cause, perhaps more than all other causes which have grown

²⁸ Lyford, *Western Address Directory*, 282-284.

²⁹ *Ibid.*, 279.

³⁰ Crisman, Lees, and Davis, “Western river steamboat,” 377-379.

out of human skill, combined, to advance the prosperity of the west.”³¹ Steamboats could efficiently carry passengers and freight up the rivers as well as down. Improvements in technology and spirited competition among captains resulted in progressively quicker runs between major cities; in 1835, a good season’s average for larger boats was considered to be six round trips between Cincinnati and New Orleans.³²

Steamboat travel was relatively cheap and comfortable, not only on long journeys but for local transportation needs as well. As a later historian remarked, by the 1830s, steamboats had “appeared wherever there was water enough to take a bath.”³³ Steamboat construction increased rapidly in the 1820s and into the 1850s, so much so that “the capacity of the [shipping] industry was continually outstripping demand for its services.”³⁴ Competition among the many independent steamboat owners kept freight rates down.³⁵

Adapted for western river conditions, these steamboats were lightly built, long, and narrow, with flat bottoms and shallow drafts. They were constructed in shipyards up and down the rivers, notably in Pittsburgh, Cincinnati, and Louisville, but also in New Albany, Wheeling, and other centers.³⁶ This was new and often dangerous technology. Fires and exploding boilers all too often resulted in horrific injuries and loss of life.

³¹ James Hall, *Notes on the Western States*. (Philadelphia, 1838) 216, quoted in Berry, *Western Prices*, 30.

³² Berry, *Western Prices*, 35.

³³ Riegel, *Young America*, 160.

³⁴ Berry, *Western Prices*, 58.

³⁵ Berry estimates that “charges on imports via the Mississippi [from New Orleans to the interior] dropped over 95 per cent during the half century beginning around 1795...most spectacular[ly] in the 1820’s.” *Ibid.*, 42.

³⁶ *Ibid.*, 32.

These steamboats were used hard; their productive life expectancy was only around six years.³⁷

Steamboats were by no means the only craft on the rivers. Earlier vessel types continued to thrive, notably flatboats, keelboats, and barges. Flatboats were essentially floating boxes: rafts with built-up sides on which shelters were constructed. They were steered with long sweeps as they floated downstream. These were the legendary craft that carried early pioneers with their families, their animals, and all their belongings. Well into the steamboat era, they carried bulk cargos to cities along the rivers. As late as 1853, over 5,800 flatboats brought salt, coal, and other commodities to Cincinnati.³⁸ Due to their raft-like construction, the boats could be broken up and sold as timber at their destinations. The advent of steam-powered vessels saved many flatboat crews a long walk home.

Before steamboats, upstream river traffic was generally accomplished in keelboats. These long, narrow boats were pointed at both ends, and had, as the name implies, a sturdy keel. They could be propelled in several ways. A narrow gangway ran along the sides just inside the gunwale; crewmen moved along this walkway as they poled the vessel upstream. Keelboats could be pulled with ropes by horses, mules, or men trudging along the riverbank. They could also be rowed with long oars, and could even be sailed if conditions were right. Though relatively small, they were capable of towing barges that greatly increased their carrying capacity. After steam transport took

³⁷ Ibid., 33.

³⁸ Ibid., 24.

over most upriver carrying, keelboats continued to work the rivers. Being smaller and lighter, they could navigate in conditions impassible by most steamboats. Cargos and passengers were often transferred from steamboats to keels in order to reach less-accessible destinations.

Descriptions of nineteenth-century river barges vary considerably, but in general, barges were flat-bottomed vessels somewhat larger than keelboats or flatboats. They were ideal for large bulk cargos. Both keelboats and steamboats frequently towed one or more barges. Steamboats did not supplant earlier river craft, but supplemented them.³⁹

Ports and Landings

At major river ports, steamboats and other vessels docked along great levees—broad paved embankments that sloped down into the river. The steamboats' shallow draft and wide guards let them move in close enough to position their stages (or gangplanks) on the levees whether the water was high or low. Floating wharves—perhaps converted flatboats or old steamboats—helped relieve overcrowding at some ports. Levees were noisy, bustling centers of commercial activity and regulation. Great piles of freight waited to be loaded onto steamboats and barges or transferred to one of the many warehouses in the port district by a small army of laborers and carters. City governments set wharfage fees for different classes of vessels. The port warden was

³⁹ Ibid., 21.

charged with inspecting incoming cargos and certifying their condition as well as acting as mediator in disputes between steamboat captains and consignees of the cargo.⁴⁰

In smaller towns, unpaved levees might be improved by addition of a wooden walkway down the muddy slope. In more remote and less populated areas, however, landings required only a site near a small settlement where the steamboat could approach near enough for its landing plank to reach the shore. In places where the steepness of the riverbank or other conditions prevented vessels from approaching near enough, floating wharves were moored at an appropriate distance from the bank. These floating facilities were also able to respond to changing river levels.

River-Borne Trade

The western part of the country in the nineteenth century, what we now call the Midwest, was part of a great triangle of interregional trade. Western products such as corn, flour, pork, and whisky flowed down the rivers into the South. The southern region sent cotton to the mills of northeastern states, while manufactured goods came into the West from east coast industries.⁴¹ Imports also entered the region from the South, though the volume of upriver trade lagged far behind that sent downstream.⁴² Of the western products shipped to the South, some were intended for consumption there, while others were exported to American ports along the Atlantic or to the West Indies. Goods manufactured in Pittsburgh, Cincinnati, and elsewhere in the West, especially heavier

⁴⁰ “An ordinance to establish the office of Port Warden, and to regulate the duties thereof,” passed 1834, Woodruff, Hinman and Funk, *Cincinnati... Ordinances* 1835, 92-94.

⁴¹ Berry, *Western Prices*, 22.

⁴² *Ibid.*

goods such as hardware and cast iron machinery, found buyers in southern markets. Forests, particularly those in the Ohio Valley, provided abundant wood for homes and other buildings and for many wood products. Timber was an important export, often in the form of boards, shingles, and barrel staves. Though coal was gradually being introduced into homes and industry, wood was still the primary fuel for heating and cooking, and for powering industry and steamboats.⁴³ A partial list of agricultural products shipped in western river steamboats includes: flour, wheat (unground grain), whisky, corn, pork and beef, lard, rye, oats, barley, beans, flaxseed, linseed oil, hemp, tobacco, sugar, molasses, coffee, tea, rice, butter, cheese, and, of course, cotton.⁴⁴ Salt, that essential preservative in the pre-refrigeration age, was also a major commodity.

Heroine's Cargo

The items that were included among the contracted provisions making up *Heroine's* last cargo are discussed below. As the cargo certainly originated in and near Cincinnati, the following discussion focuses on that city in the 1830s.

Flour. Though most westerners, like their southern neighbors, preferred to eat corn meal, wheat was the great cash crop of the region.⁴⁵ Most of the wheat crop was sold as flour. The unground wheat trade was slower to develop than that of wheat flour because of the low price commanded by unground grain.⁴⁶ Early flour mills were horse-

⁴³ Riegel, *Young America*, 117.

⁴⁴ Berry, *Western Prices*, 180, 340.

⁴⁵ Riegel, *Young America*, 90.

⁴⁶ Berry, *Western Prices*, 160-161.

or water-powered, but steam-powered mills spread quickly after 1810.⁴⁷ Records of flour inspectors in Cincinnati indicate that “superfine” was the most usual grade, followed by “fine” and, more rarely, “common” (coarse).⁴⁸ A number of mills were active in Cincinnati, but flour milling never became an important industry there. Cincinnati was, however, the major re-shipment port for flour produced in the Ohio Valley. Thousands of barrels poured into Cincinnati via rivers and canals and overland by wagon every year. About 300,000 barrels came into the city in 1846.⁴⁹ Ohio Valley flour found markets in the southern states, along the eastern seaboard, and in the West Indies and South America.

Barreled meat. Pork was the staple meat of the United States for much of the nineteenth century. Pigs were easier and cheaper to raise than beef cattle—they reproduced and fattened more efficiently. Generations before cowboys drove herds of cattle across the open plains to railheads in the Wild West, drovers moved great herds of pigs, as well as cattle, from the Ohio Valley along forest roads to eastern population centers. Many more hogs were driven to packing houses to be turned into hams and bacon or to be salted in barrels. Meat packing was done in a number of centers along the Ohio River and its tributaries, but Cincinnati was the largest meatpacking center. The city’s huge output earned it the nickname “Porkopolis.” In the winter of 1837-1838, for example, an estimated 182,000 hogs were packed in the city.⁵⁰

⁴⁷ Ibid., 160-162.

⁴⁸ Ibid., 178.

⁴⁹ Ibid., 166, Table 12.

⁵⁰ Ibid., 223, Table 18.

The swine of choice on the frontier was the legendary razorback, and that breed continued to feed the meatpacking industry until widespread introduction of “foreign” breeding stock in the 1840s. Razorbacks had narrow bodies and long legs; their meat was often tough and stringy, and they produced little lard, a valuable by-product. They were, however, able to survive, reproduce, and thrive with little or no attention from the farmer. The hogs were allowed to roam freely in the woods, where they lived on mast—acorns, beechnuts, and other forage. A few weeks before market time, they were rounded up and turned loose in the cornfields to fatten; a period of corn-feeding corrected the undesirably soft, oily meat of totally mast-fed hogs. Hogs were ready for market at sixteen to twenty months of age, by which time they weighed upwards of 200 pounds.⁵¹

Before the introduction of artificial refrigeration, packing was done in winter, most of it between late November and early January.⁵² In the 1830s, slaughtering and packing were separate operations; slaughterhouses were located on the outskirts of the city, while packing houses were concentrated near the port area. Both operations were among the earliest examples of modern assembly-line production.⁵³ The processes were broken down into discrete steps, the workers performing their assigned tasks in close coordination with each other. At the slaughterhouse, hogs were killed by a hammer blow to the head. The carcasses were bled out in the sticking room, scalded in a large trough, then scraped to remove bristles from the hide. They were then hung on hooks, washed on

⁵¹ Walsh, M., *Midwestern Meat Packing*, 23.

⁵² *Ibid.*, 24-25.

⁵³ Gordon, “From Slaughterhouse to Soap-Boiler,” 56. Arms, “From Disassembly to Assembly,” 198.

the outside, gutted, and the insides washed. This entire process was “completed within three and one-half minutes from the last grunt.”⁵⁴ The dressed carcasses were hung in the cooling room for twenty-four hours before being delivered in huge wagons to the packing house.⁵⁵ The work of cutting the carcasses was also highly specialized, though it was not yet mechanized in 1837.⁵⁶ Some packing house workers “spent their entire day weighing carcasses, others severing heads, and still others cutting the hogs into various pieces, trimming the meat, salting and packing it into barrels, or preparing it for the smoke houses [working so efficiently that] less than a minute was required to process a carcass into hams, chops, and bacon.”⁵⁷

Salt. The importance of salt went far beyond its use as a seasoning for food: in the days before refrigeration, salt was an essential preservative. Every household required salt, and the meatpacking industry consumed vast quantities. Cincinnati was a major distribution point for salt in the Ohio Valley, both to nearby markets and for export downriver.⁵⁸ Most of the salt coming into Cincinnati originated in western Virginia’s Kanawha Valley. Salt from other smaller Ohio Valley producers was also traded in Cincinnati, as was Onondaga (New York) salt, but Kanawha was “the dominant source of supply to the Ohio-Mississippi watershed by reason of location, strength of brine, and technical facilities of manufacture.”⁵⁹

⁵⁴ Riegel, *Young America*, 36.

⁵⁵ Hurt, “Pork and Porkopolis,” 199-200.

⁵⁶ Ibid.

⁵⁷ Ibid.

⁵⁸ Berry, *Western Prices*, 295.

⁵⁹ Ibid., 305.

Kanawha salt companies drilled wells to access rich veins of brine. The brine was boiled in large sheet iron pans until the water evaporated. Coal from nearby hills fueled the many furnaces.⁶⁰ The salt companies delivered their product to Cincinnati and other points, one company maintaining “a fleet of three steamboats and scores of flatboats” for the purpose.⁶¹

Kanawha salt was not the fine table salt to which modern consumers are accustomed. It was coarse, and brown with impurities such as lime and magnesia.⁶² Those minerals negatively affected the quality of salted meats, seriously reducing the time they could be kept without spoiling. Even after improved methods introduced in the 1820s resulted in a purer product, Kanawha salt was not considered entirely satisfactory as a preservative for meats. There was an alternative—high-quality sea salt was imported from the British West Indies, specifically Turks Island. The cost of shipping Turks Island salt from the Gulf of Mexico to the upper Ohio River had long made it prohibitively expensive. After 1821, however, the proliferation of steamboats resulted in falling freight rates, and sea salt became an affordable commodity.⁶³

Candles and Soap. During the 1830s, the Cincinnati meatpacking industry was highly wasteful; little use was made of pork by-products beyond the rendering of lard and tallow. Lard was a higher-quality product used for cooking. Tallow, a low-grade animal fat rendered from scraps and waste from the slaughterhouse, was used for candle

⁶⁰ Ibid., 312.

⁶¹ Ibid., 310.

⁶² Hurt, “Pork and Porkopolis,” 195.

⁶³ Ibid.

and soap manufacture.⁶⁴ Before 1840, when the introduction of steam rendering technologies increased both the efficiency of the processes and the purity of the products, candle-making was slow and labor-intensive.⁶⁵ Traditional tallow candles had an unpleasant odor and became greasy and melted when the weather was warm,⁶⁶ a distinct disadvantage in the southern climates. Lower-grade tallows were used for making soap.⁶⁷

Beans. Beans were among a host of minor agricultural products gathered from the immediate area around Cincinnati for shipment to distant markets.⁶⁸ Of the approximately 2,600 barrels entering the city annually between 1846 and 1850, for example, 2,200 were exported.⁶⁹

Doing Business in the 1830s

Several fundamental conditions of conducting business in the early nineteenth century might be somewhat surprising to twenty-first-century observers. There were, for example, no nationally enforced standards for weights and measures. Individual states and municipalities had the power to regulate weights and measures for trade within their jurisdictions. The Treasury Department was authorized by Congress in 1836 to establish standards and furnish them to the states, but adoption was not mandatory.⁷⁰

⁶⁴ Gordon, "From Slaughterhouse to Soap-Boiler," 60.

⁶⁵ *Ibid.*

⁶⁶ *Ibid.*

⁶⁷ *Ibid.*, 61.

⁶⁸ Berry, *Western Prices*, 19.

⁶⁹ *Ibid.*, 166, Table 12.

⁷⁰ *Ibid.*, 141, Note 9.

Most commodities were sold by weight, the “pound avoirdupois” being the most commonly used unit.⁷¹ Heavy bulk goods were sold by the “ton,” which weighed 2,000 or 2,240 lb (907 or 1016 kg) depending upon the type of commodity and where it was sold, or by the “hundredweight” of 100 lb (45.4 kg), or the “gross hundred” of 112 lb (50.8 kg). Traditional usage had dictated a degree of standardization in the use of certain containers, which became measures of weight, not volume. A “barrel” of flour, for example, was accepted to contain 196 lb (88.9 kg), and a “barrel” of salted meat was accepted to contain 200 lb (90.7 kg). Similarly, 25 lb (11.3 kg) of gun powder was a “quarter keg” whether packaged in a cask or a box.⁷² Bushels, too, gradually became units of weight that were regulated by states or municipalities, and that varied according to the commodity. For example, using figures from 1861, a “bushel” of barley weighed 48 lb (21.8 kg); of corn, 56 lb (25.4 kg); of potatoes, 60 lb (27.2 kg); and of dried apples, 25 lb (11.3 kg).⁷³ Weights are easier to measure than volumes. It was, therefore, easier to comply with and to enforce standards established in terms of weight.⁷⁴

Another condition of doing business was that, in many areas of the West, there was a limited amount of money in circulation. The currency of the United States was based on gold and silver coins, which were often hoarded for the value of their metal. A scarcity of American coins led to common use of any coinage available, including

⁷¹ Ibid., 140.

⁷² Ibid., 146.

⁷³ Ibid., 152.

⁷⁴ Ibid., 146.

Mexican dollars and other foreign coins.⁷⁵ With regard to paper currency, banks literally printed their own money. Forgeries and fraudulent issues were common, and businessmen, travelers, and other citizens were of necessity wary of accepting notes from distant banks or from strangers.⁷⁶

THE ARMY OF THE FRONTIER

The Army and the Western Economy

The U.S. Army contributed significantly to the economic development of the western United States, quite apart from its role in making the region more secure. For one thing, the Army was instrumental in the expansion of transportation and communication networks. These were essential for keeping remote forts supplied with food and other necessities. The Army built or contracted for the building of roads, and brought about the clearing of obstructions from western rivers. The needs of the military contributed to the spread of postal services and, in later years, the Army was closely involved in extending the telegraph system across the country.⁷⁷ These improvements benefited civilians as well as the military. The Army also contributed more directly to local and regional economies. At the frontier forts, Quartermaster's Assistants contracted locally for fodder, firewood, fresh meat, and the like. These contracts, along with

⁷⁵ Riegel, *Young America*, 123.

⁷⁶ *Ibid.*, 124.

⁷⁷ Tate, *Frontier Army*, 52-60, 68-73.

purchases made by individual soldiers, provided settlers with welcome opportunities for cash income.⁷⁸

To keep the troops on the frontier fed, the Army annually procured large quantities of provisions, contracts for which were eagerly sought.⁷⁹ Until the late 1820s, subsistence contracts tended to be awarded to traders in the East. After about 1830, however, firms based in the West won an increasing share of the contracts.⁸⁰

The Army provisioning trade answered two particular needs of western producers and merchants. One need was for markets for their produce that were relatively close to home; the forts required huge amounts of staple foods year after year,⁸¹ and the government also contracted for Indian rations for distribution in the Indian Territories. Another need of western producers was for prompt and reliable payment. Once the contracted supplies had been accepted at the receiving post, traders could count on payments that were timely according to the standards of the day. By the 1830s, the Army was paying its accounts with government drafts on reputable banks in the contractors' localities, so "the trader knew that his claim would be honored in acceptable currency."⁸²

⁷⁸ Riegel, *Young America*, 63.

⁷⁹ Atherton, *Frontier Merchant*, 100.

⁸⁰ *Ibid.*, 101-102.

⁸¹ *Ibid.*, 99.

⁸² *Ibid.*, 99-100.

Garrison Life

The Army in the West in the 1830s numbered around 2,000 men thinly spread between the Great Lakes and the Gulf of Mexico.⁸³ The Army's primary mission was to provide a "military zone" between the settlers and Indians,⁸⁴ but relatively little time was spent engaged in hostilities with Native Americans.⁸⁵ The western forces were involved in a wide range of duties. For a start, the troops themselves generally constructed the frontier forts from locally available material.⁸⁶ Soldiers were also involved in exploration and map making,⁸⁷ in road building,⁸⁸ and in agricultural projects large and small,⁸⁹ and they were often called on to maintain law and order in otherwise lawless regions.⁹⁰ Day to day, the soldier was occupied with such mundane routines of garrison life as guard duty, roll call formations, training, cleaning quarters, preparing and consuming food in company messes, maintaining equipment, and filling out the reams of paperwork so integral to the functioning of any bureaucracy.

⁸³ Riegel, *Young America*, 69-70.

⁸⁴ Frazer, *Forts of the West*, xii.

⁸⁵ Tate, *Frontier Army*, x.

⁸⁶ *Post* is the general term for any position at which troops are stationed. Posts were given a variety of designations: *Fort Gibson*, *Cantonment Leavenworth*, *Jefferson Barracks*, and so on. Supposedly, a *fort* was a permanent position that may or may not have had a surrounding wall (Fort Towson did not) or other physical fortifications. The term *cantonment* (in later generations, *camp*) implied impermanence. In actual practice, the numerous terms used to designate Army posts were inconsistently applied. However, in 1832, the Army issued a general order that all cantonments were to be re-designated as forts. Frazer discusses the naming of Army posts and "the problem of nomenclature" at some length. Frazer, *Forts of the West*, xx-xxvii.

⁸⁷ Tate, "Discoverers: Military Scientists, Ethnographers, and Artists in the New Empire," chap. 1 in *Frontier Army*.

⁸⁸ Tate, "Across and On the Wide Missouri: The Army's Role in Western Transportation and Communication," chap. 3 in *Frontier Army*.

⁸⁹ Tate, "Uncle Sam's Farmers: Soldiers as Agriculturalists and Meteorologists," chap. 6 in *Frontier Army*.

⁹⁰ Tate, "*Posse Comitatus* in Blue: The Soldier as Frontier Lawman," chap. 4 in *Frontier Army*.

Fort Towson

Cantonment Towson was originally established in 1824 on a site 6 mi (9.7 km) north of the Red River to control conflicts among outlaws, Indians, and settlers along the United States frontier with Mexico.⁹¹ It was abandoned in June 1829, at least partly because the “difficulty of supplying the Post owing to the obstruction in Red River and the scarcity of inhabitants in that remote section of the Country, is a material objection to the establishment and with the frequent failures of the mail, leaving the Post for weeks & even months without orders or any intelligence from Head Quarters.”⁹² Soon, however, the pressing need for a military presence in that region forced the Army to reconsider.

This distant section of the country was “liable to an attack from the civilized forces of a neighboring empire [Mexico], as well as from several different tribes of Indians, with some of whom we have no treaties, and who know us only as their supposed enemies.”⁹³ Of more immediate concern was the need to protect the Choctaw Indians being relocated into the area from their homes in the East. The post was re-established near the original site in 1831. First called Camp Phoenix, then Cantonment Towson, it officially became Fort Towson in February 1832.⁹⁴

⁹¹ Frazer, *Forts of the West*, 125.

⁹² Lieutenant Geo Geshouse(?), 7th Inf. to Major James H. Cook, Washington, November 1, 1828, entry 225 (Consolidated Correspondence), box 1145 (Towson, Fort), record group 92 (Records of the Office of the Quartermaster General), National Archives and Records Administration, Washington, (hereafter NARA).

⁹³ General E.P. Gaines to General Alexander Macomb (Macomb), July 6, 1833; Adjutant General’s Office, old files division *Western Department*; Letter Book VI, 297; United States House *Document* No. 311; quoted in Foreman, *Advancing the Frontier*, 25-26.

⁹⁴ Frazer, *Forts of the West*, 125.

Fort Towson's mission was clearly stated in Major Stephen W. Kearny's orders for the establishment of the new post.⁹⁵ "You will," the orders read, "with the Battalion of the 3d Regiment as soon as practicable ascend the Red River as far as the vicinity of the Kiamichi Stream and on the north side of Red River, Establish a Military Post." The orders listed four "objects in view," three of which concerned the eastern Indians relocated to "the Territory beyond the line of the States and Territories and within the limits of the country beyond the United States." The first objective was to protect the Indians "against the white people who may illegally adventure among them; or attempt any interference with them contrary to our laws." The second was to maintain peace among "the several tribes" while preventing them from "marauding within the limits of the States and Territories." The third objective involved keeping the Indians from passing into Mexico "for the purpose of molesting the citizens and others" there. The final objective was "to maintain the Sovereignty of the United States...by preventing any settlements or intrusions" from across the Mexican frontier.⁹⁶

In the selection of a site for the post, Kearny was instructed to consider navigation facilities, the availability of necessary materials for constructing the post, good water and healthy position, and the defensibility of the ground. He was reminded "that as the object in establishing the post is in a great measure to benefit the Indians, in the position you feel inclined to select it is desirable that it should not in any way

⁹⁵ Major-General Alexander Macomb, commanding Army, to Major Stephen W. Kearny, January 14, 1831, entry 225, box 1145, record group 92, NARA.

⁹⁶ Ibid.

interfere with the Indians already settled and those who are settling in the Country. No uneasiness should be given to them by interfering [sic] with their settlements and therefore you will in such cases consult with them and as far as the public interest will permit regard their wishes.”⁹⁷

Fort Towson was one of nine posts established in what is now Oklahoma before 1860 for the protection of the removed tribes. These tribes were indeed in need of protection. One rather glaring problem with the Removal scheme was that the lands allotted to the incoming tribes were already occupied by powerful western tribes such as the Kiowa, Comanche, and Osage. Not surprisingly resentful of the intrusion, they carried out raids that significantly threatened the lives and property of the newcomers.⁹⁸ What is more, white settlers had already begun to move into the region. To make way for the eastern tribes, whites already settled in the Territories had to be evicted. Many of them moved south across the river, establishing Jonesborough, about 12 mi (11.6 km) below the Fort Towson landing, as the seat of Miller County, Arkansas Territory.⁹⁹ Much of the population of Miller County was rough and rowdy even by frontier standards: “men who have fled from justice and who are now engaged in kidnapping negroes—horse racing, gambling and selling whisky to soldiers and Indians....”¹⁰⁰ For some years, there was considerable argument over whether Miller County was in the

⁹⁷ Ibid.

⁹⁸ Tate, *Frontier Army*, 240-241.

⁹⁹ Foreman, *Advancing the Frontier*, 84, note.

¹⁰⁰ Lieutenant Colonel Josiah H. Vose, commander Fort Towson (Vose) to Maccomb, June 2, 1833; Adjutant General’s Office, old files division, 23 V 33; quoted in Foreman, *Advancing the Frontier*, 84.

United States or the Republic of Texas—an ambiguity of legal jurisdiction that encouraged increased lawlessness.¹⁰¹

At Fort Towson, as elsewhere along the frontier, officers and their men often found themselves in an impossible position, caught between the goals of conflicting policies toward Native Americans (e.g., “exterminate them” or “civilize them”), and vigorous pressure from advocates of both policies. Enforcement of laws that mandated keeping trespassers out of Indian lands, for example, was unreliable and sporadic due to lack of both the “physical means and legal backing” for carrying out that mission.¹⁰² During the Removals, the Army “came to occupy another untenable role as it oversaw some of the most inhumane of the mass exoduses and as it offered protection and services to those same tribes in their new western homelands.”¹⁰³ Contrary to the image of the Army as “a merciless killer of innocent Native Americans,”¹⁰⁴ it was not unusual for officers to find themselves advocating for the rights of Indians and bringing their points of view to Washington. It is telling to observe that the removed tribes never requested that any of the forts in Indian Territory be closed, but rather appealed for more soldiers and more posts.¹⁰⁵

¹⁰¹ Foreman, *Advancing the Frontier*, 84, note.

¹⁰² Tate, *Frontier Army*, 237-238.

¹⁰³ *Ibid.*, 240.

¹⁰⁴ *Ibid.*, 237.

¹⁰⁵ Brad Agnew, *Fort Gibson: Terminal on the Trail of Tears* (Norman: Univ. of OK Press, 1980), 208-211, referenced in Tate, *Frontier Army*, 242.

Supplying Fort Towson

The remoteness of Fort Towson and the vagaries of navigation on the Red River seriously complicated the business of maintaining the garrison. The post relied almost entirely on supplies provided by the Quartermaster and Subsistence Departments, as very little could be obtained from the surrounding country.¹⁰⁶ What roads existed were poor and unsuited to moving large amounts of heavy goods. It was generally far more practical to bring provisions and other bulky supplies by water even before a channel had been cut through the Great Raft, and land transport was resorted to only in extreme circumstances.

The Red River originates in what is now the Texas panhandle, and flows generally eastward to form the border between Texas and Oklahoma. It then crosses the southwestern corner of Arkansas before turning southeast across Louisiana to empty into the Mississippi River. Hazards encountered by travelers on the Red River, as elsewhere in the West, included powerful currents, narrow and shifting channels, sandbanks and submerged obstacles, and water levels that could rise and fall suddenly. Rising in a more arid region, the river was affected by seasonal lack of rainfall that frequently resulted in low water. Even smaller vessels of shallow draft found passage difficult or impossible and might be forced to tie up for weeks before continuing their journey. Periods of heavy rain and high water had their own risks. The stronger flood currents were dangerous in themselves, and boats could be rammed by floating branches and other debris hurtling

¹⁰⁶ Vose to Major-General Thomas F. Jesup, Quartermaster General (Jesup), August 7, 1832, entry 225, box 1145, record group 92, NARA.

downstream. More delays occurred when very high waters overflowed the banks, making it difficult for steamboats to obtain fuel, and forcing them to wait out the flood.¹⁰⁷

The biggest obstacle to navigation on the Red River was the enormous log jam known as the Great Raft. Where its course passed through flat Louisiana terrain, great loops of the river spread out to become more of a swamp, clogged with a near-solid mass of broken trees brought down with the flow. The dimensions of the Great Raft varied somewhat as the river deposited material at the head of the Raft and as lower portions broke away and floated downstream. The foot was near Shreveport, Louisiana, while the head was as far as 160 mi (256 km) upstream. When water conditions were favorable, keelboats of decent size, perhaps towing barges, could get through, though a change in water levels could leave even moderately sized boats stranded.

The relocation of Choctaw Indians to the region north of the Red River and the establishment of Fort Towson provided the impetus for improving Red River navigation. In 1832, the U.S. Army contracted Henry Shreve to clear a channel through the entire Raft.¹⁰⁸ The snag boat *Archimedes*, Shreve's own design, was a catamaran: snags could be trapped in the "V" between the twin hulls, pulled up out of the river bed with huge tackle, then passed through a saw mill located amidships. Cut in small pieces, the former snag safely floated downriver.¹⁰⁹ In addition to *Archimedes*, Shreve's operation required

¹⁰⁷ Vose to Macomb, June 2, 1833; Adjutant General's Office, old files division, 23 V 33, quoted in Foreman, *Advancing the Frontier*, 84.

¹⁰⁸ Donovan, *River Boats of America*, 104.

¹⁰⁹ *Ibid.*, 102-104.

a dozen flatboats, three small steamboats, and a crew of 160 men. They could work only when water was high in the spring, and then only when the U.S. Congress was willing to release funding. Thus it was five years before the channel was first opened in the spring of 1838.¹¹⁰ The Raft was constantly re-forming, however, and keeping a channel open would be the work of decades.

For the troops at Fort Towson, well above the head of the Raft, the Red River proved to be a rather capricious lifeline. All too often, the garrison suffered from delayed deliveries and losses of supplies en route. The logistical mess that occurred in 1832 provides a not atypical illustration.

According to a report received by the Quartermaster General, the extraordinarily early low water above the Raft was preventing the boats with the year's provisions from ascending the river.¹¹¹ Mr. D. R. Hopkins, agent for contractor James Harrison, had set out from Natchitoches on April 20 with the provisions in a steamboat with a keelboat in tow. The steamboat could go no farther than Coat's Landing (later Shreveport), about one-third the distance between Natchitoches and Fort Towson and about 45 mi (72 km) below the head of the Raft. There he had unloaded and stored nearly 600 barrels of pork and flour and 85 boxes of soap and candles. Hopkins proceeded upriver in keelboats with the rest of the provisions, but could get only as far as Fulton, Arkansas Territory, before being stopped by low water. Most of the shipment, some 147 barrels of pork,

¹¹⁰ *Ibid.*, 104.

¹¹¹ This account is taken from: Lieutenant Francis Lee, Assistant Quartermaster, Fort Jesup (Lee) to Jesup, July 11, 1832, and D.R. Hopkins, Agent for contractor James P. Harrison to Lee, July 12, 1832, entry 225, box 1145, record group 92, NARA.

flour, vinegar, salt, and beans, was put ashore there, while Hopkins continued on with the balance in smaller, or at least lightened, keelboats. By July, those keelboats were above the Raft, aground. Fort Towson's commander, Lieutenant Colonel Vose, arranged to send wagons,

by which means the post can be kept provisioned until a rise of water, (this however cannot be look'd for until fall) & of course now, is the only alternative; a bad one it is true but now the only one. . . . [A]t each heavy rain the river is a few feet up but for a short time; this of course will be taken advantage of by the upper boat with the 100 [bbls] flour, by which means it may get up earlier than by the genl rise. The lower boat cannot do so, should she [attempt it], she cannot be reached by wagons & where she is, is I believe the only landing from that [landing] to Towson to which wagons can get.¹¹²

The wagons succeeded in getting some goods through, but in August, Vose reported that “only a small part of the Qr Masters supplies & subsistence stores for the present year have yet arrived. . . . We are now living upon half rations of bread, and this of a very bad quality, having been condemned as totally unfit for issue—But bad as it is we must eat this or none—and it will only last till sometime in October.”¹¹³

Subsistence stores were not the only items gone astray in transit that year—none of the much-needed winter clothing arrived on time either. In November, Fort Towson's Assistant Quartermaster wrote to the Quartermaster General: “The public Stores are received Slowly and in very bad order. The remainder is still in the raft where they will probably remain for some months.”¹¹⁴

¹¹² Lee to Jesup, July 11, 1832, *ibid*.

¹¹³ Vose to Jesup, August 7, 1832, *ibid*.

¹¹⁴ Second Lieutenant Ch[arle]s L.C. Minor, Assistant Quartermaster, Fort Towson (Minor) to Jesup, November 1, 1832, *ibid*.

Evidently, an officer was dispatched to Natchitoches to purchase provisions sometime in October, for, at the end of December, Vose wrote:

I regret to be obliged again to inform you that no part of the public stores have yet arrived. An officer has just returned from the raft, where he had been sent with pack horses to procure some articles of clothing, of which we are in great want. He reports that he heard nothing from the boat which left Natchitoches about 50 days since with the provisions purchased by Capt Taylor.¹¹⁵

The long overdue Subsistence, Quartermaster, and Medical stores continued to arrive at Fort Towson well into March 1833.¹¹⁶ When one lot of Subsistence stores was delivered in January, a statement of deficiencies listed five barrels of pork, forty of flour, one of beans, and a box each of soap and candles as missing outright. Other containers had been opened and part of the contents removed—a total of 287 lb (129 kg) of flour taken from several barrels; 350 gal (1330 L) of vinegar, 390 lb (175.5 kg) of sugar, and 3 lb (1.35 kg) of coffee were missing, as were significant amounts of rice, salt, soap, and candles. To these losses were added the 68 64/196 barrels of flour and 11 barrels of beans that were “condemned by a Board of Survey as damaged & unfit for issue.”¹¹⁷

The trials and tribulations of 1832 illustrate some of the challenges of keeping Fort Towson supplied with basic necessities. Getting through the Great Raft and on to the Fort Towson landing when the water was low often required months of effort. Transshipment of cargos to smaller craft increased the chances of lost and damaged goods. It was worse when some or all of the cargo was stored ashore. Goods spoiled

¹¹⁵ Vose to General George Gibson, Commissary General, Washington, December 27, 1832, *ibid.*

¹¹⁶ Minor to Jesup, May 17, 1833, *ibid.*

¹¹⁷ Statement by Lieutenant E.B. Alexander, August 3, 1833, *ibid.* The standard barrel contained 196 lb (88.9 kg). The contents of partially filled barrels were commonly given as a fraction of 196.

because of inadequate warehouses, weather, heat, humidity, and careless handling. Both ashore and afloat, pilferage was common. Arranging for alternate transport by land was complicated by poor roads and slow communications. Meanwhile, the soldiers at the garrison endured short rations and other supply scarcities and carried on with their duties as best they could.

CHAPTER III

COOPERAGE

It has been observed that, “while the manufacture of tight barrels is a very ancient trade[,] there has been very little, if any, real improvement made in the details of its construction, which when considered as a whole, is in reality a work of art....”¹¹⁸

The archaeological evidence of *Heroine*'s last cargo consists primarily of the remains of barrels. Until the mid-twentieth century, barrels were the principal containers for shipping and storing a wide variety of goods. To provide for a better understanding of *Heroine*'s cargo, this chapter presents background material on the development of barrels, their construction, and their use throughout history.

SOME TERMINOLOGY

“Cooperage” covers any container made of staves and bound with hoops, both “closed,” such as barrels, or “open,” such as tubs and buckets. It can also refer to the workshop where staved containers are made. A cooper is one who makes or repairs such containers, and cooper can also be used as a verb. A barrel or cask is “a thin-walled cylinder with a bulging middle made of longitudinally-tapered wooden slats of varying widths, called staves, each having slightly beveled edges that fit closely together and [are] held in compression by strong outside hoops...made of strips wood [or] metal.”¹¹⁹

¹¹⁸ Coyne, *Cooperage Industry*, 7.

¹¹⁹ Shagena, *Barrel in America*, 27.

The ends of the barrel are closed with circular heads that fit into grooves cut around the inside of the shaped barrel. These containers have been constructed in many sizes, from the great Heidelberg Tun, with a capacity of nearly 50,000 gal (189,500 L),¹²⁰ to the tiny bever holding a couple of quarts. Traditionally, cask is the general term for closed, staved containers, and a barrel is just one size of cask. It is larger than a keg and smaller than a hogshead. Interestingly, while a nineteenth-century nautical manual published in England defines casks as “wooden vessels made of hoops, heads, and staves,” it specifies that “those made to contain fifty or sixty gallons are called casks; [and] such as contain thirty or forty gallons are called barrels.”¹²¹ It then lists hogsheads, tierces, butts, and pipes as large casks.

In American usage, however, barrel has come to be the general term, and a cask is a large barrel.¹²² In this thesis, the two terms are used more or less interchangeably, unless context makes a distinction clear. Conveniently, all the staved containers from *Heroine* are barrel-size, making them barrels in either usage.

A GENERAL HISTORY OF COOPERAGE

Origins of Staved Containers

At some unknown time in pre-history, early humans discovered a method of creating a dugout canoe by alternately burning and scraping away the insides of a tree

¹²⁰ Kilby, *Cooper and His Trade*, 119.

¹²¹ Bell, *Nautical Instructor*, 44.

¹²² Hankerson, *Cooperage Handbook*, 168.

trunk. Using the same method, according to the lore of the coopers' trade,¹²³ a section of a log set on end could be made into a useful container or perhaps a drum. The problem with such a container was that, as the wood dried out, it shrank and could crack. Resourceful early humans solved this problem by wrapping thin shoots of wood, perhaps hazel or willow, tightly around the container to hold it together, thereby prolonging its use-life. From such humble beginnings did cooperage evolve.¹²⁴ Innovation begat innovation until around 1900 BCE, when staved and hooped tubs that were narrower at the bottom than the top appeared in Egyptian tomb art—the first known depictions of coopered vessels.¹²⁵ By the Roman era, true casks were in use as transport containers alongside the more usual amphorae, as carvings on stone monuments testify.¹²⁶

Straight-sided (as opposed to bulging) staved containers—what would later become known in the western world as white cooperage—evidently occurred independently in different parts of the world. The Chinese “taru,” for example, were straight-sided closed casks, flared at the top, which grew out of the “oke” tradition of staved buckets and similar woodenwares.¹²⁷ The early appearance of staved tubs in Egyptian iconography notwithstanding, the true double-arch cask seems to have originated in the forested areas of Europe in the first few centuries BCE. In those regions, both suitable woods and strong woodworking traditions were abundantly available. In contrast, in the Middle Eastern countries, wood was relatively scarce and

¹²³ *Ibid.*, 2.

¹²⁴ Kilby, *Cooper and His Trade*, 87.

¹²⁵ *Ibid.*, 91.

¹²⁶ *Ibid.*, 98.

¹²⁷ Twede, “Cask Age,” 255.

expensive. Furthermore, the hot, arid climate of the region would have made it difficult to maintain large wooden casks in sound condition.¹²⁸ Around the Mediterranean, clay amphorae were the containers of choice. Both casks and amphorae were used concurrently in the later Roman Empire. It is difficult to track their relative popularity because of the scarcity of barrel remains in the archaeological record. Gradually over several centuries, however, casks replaced amphorae for commercial transport, earlier in the northern regions than in the south.¹²⁹

By the Roman era, the double-arch cask design was well established. For two millennia, casks were constructed in many different lands and adapted for many diverse uses, but the basic design remained remarkably little changed. Cooperage in the mid-nineteenth-century American West descended primarily from English traditions via the Atlantic colonies.

Medieval and Early Modern Periods

During the Middle Ages, craftsmen in the growing towns and cities of the British Isles established guilds to promote the interests of their trades. With the sanction of local civil authorities, they established monopolies within towns for protection against outside competition. In addition to providing their members with social support such as disability insurance and aid to widows and orphans, guilds regulated the practice of their crafts. Coopers' guilds set and enforced quality standards for cask materials and

¹²⁸ Kilby, *Cooper and His Trade*, 91.

¹²⁹ *Ibid.*, 96-97.

construction, set fair prices for casks, and oversaw the training of apprentices. Coopers' guilds also set standard cask sizes and capacities.¹³⁰

In an era notably lacking in standardization of weights and measures, cask sizes varied from town to town, and local regulations changed over time. Cask capacity also varied according to the intended contents. In Glasgow, for example, in 1578, a barrel of salmon held 12 gallons while a barrel of herring held 9 gallons. A century later, salmon was reduced to 10 gallons and herring to 8¾ gallons per barrel.¹³¹ Individual coopers who failed to comply with standards could be heavily fined. Guilds in most cities required each cooper to brand all his casks with his own registered mark. Even having unmarked casks in his possession could subject a cooper to heavy fines. For the reputable craftsman, these brands were marks of pride and a welcome advertisement for his work.¹³² Later, as the central government of England became stronger under the Tudors, regulatory responsibility began to shift from the guilds to the state.¹³³

Cooperage in the New World

From the seventeenth century, England's world trade increased rapidly, with concurrent increase in the demand for coopered containers. Coopers were among the first permanent settlers in her North American colonies.¹³⁴ In the first decades of colonization, barrels and other casks were in high demand both for local use and for the

¹³⁰ Ibid., 110-112.

¹³¹ Ibid., 123. Metric equivalents are not given, as sixteenth- and seventeenth-century "gallons" did not necessarily equate with modern Imperial gallons.

¹³² Ibid., 113-115.

¹³³ Ibid., 112.

¹³⁴ Shagena, *Barrel in America*, 45.

exports that steadily increased both in variety and quantity. To meet these needs, coopers were actively recruited from the British Isles with promises of higher pay. A short list of commodities shipped in barrels and casks from the colonies includes tobacco, whale oil, preserved beef, pork and fish, flour, molasses, rum, and naval stores—tar, pitch, and turpentine.¹³⁵ Finished casks filled with trade items were not the only cooperage-related exports. Abundant American forests produced timber exports for forest-depleted lands of Europe and the West Indies. By the mid-seventeenth century, significant numbers of staves cut from American white and red oak were being exported to England, Ireland, Spain, Portugal, and the West Indies.¹³⁶ Staves remained an important American export into the early twentieth century.

After the Revolutionary War, when immigrants poured over the mountains into the Ohio and Mississippi River valleys, barrels were used to haul food and other valuables overland in Conestoga wagons and on the rivers in flatboats and keelboats. Soon, they were transporting the region's produce back East or down the Mississippi to New Orleans and from there by ship back to the eastern United States or to Caribbean and other markets.

Regulation and Standardization

The regulation of trade in British North America was the province of individual colonies and, later, states, and there were no national standards. For the capacity of the

¹³⁵ *Ibid.*, chap. 3.

¹³⁶ Shagena, *Barrel in America*, 46-47. Coyne, *Cooperage Industry*, 11.

different classes of casks, all the colonies adopted the standards set by the London Assizes of 1707.¹³⁷ Colonial legislatures also issued supplemental capacity standards for a large number of export commodities not included in the London Assizes. Most of the London Assizes standards remained unchanged, but the supplemental standards varied between colonies/states and were frequently changed over time.¹³⁸ According to traditional usage, as discussed in Chapter II, a barrel of preserved meat contained 200 lb (90.8 kg) and a barrel of flour contained 196 lb (88.9 kg).

Such regulations did not necessarily result in standardized barrel construction because two casks with the same capacity did not necessarily have the same dimensions. Colonial/state legislatures sought to make their own products distinct from those of their neighbors by mandating cask dimensions as well as capacities. At one point, for example, flour barrels from Maryland and Pennsylvania with the same 196 lb (88.9 kg) capacity were both mandated to be constructed with 27 in (68.58 cm) staves. Pennsylvania, however, required 21 in (53.34 cm) head diameters and a 24½ in (62.23 cm) bilge, while Maryland required 17½ in (44.45 cm) heads and bilges of 21 in (53.34 cm).¹³⁹

Such differences created a multiplicity of barrel sizes that were the bane of exporters, who complained about the difficulty of stowing so many different sizes of casks in their ships' holds.¹⁴⁰ In the nineteenth century, the railroads complained of

¹³⁷ Walsh, J., "Capacity and Gauge Standards," 151.

¹³⁸ *Ibid.*

¹³⁹ *Ibid.*, 152

¹⁴⁰ *Ibid.*

similar problems with stowing many odd sizes of barrels in boxcars. Though there was some coordination between states on cask dimensions for some commodities, the “dichotomy of uniform capacities and differentiated dimensions” continued into the twentieth century. Finally, in the 1920s, the United States Congress set national standards for both capacities and dimensions of barrels used in interstate commerce and trade.¹⁴¹

Marks

States, cities, and other entities with regulatory responsibilities were empowered to require that certain information be displayed on barrels of goods bought and sold in their jurisdictions. The information required and the means of applying it varied considerably; it could be branded, incised, or painted, usually on the barrel heads. Some regulations called for the mark of the cooper or cooperage that produced the barrel¹⁴² along with the barrel’s tare (empty weight). Barrels used in commerce might be marked with the name of the person or company whose product it contained, the type and quality of the product, and the amount in pounds, gallons, or other measure.¹⁴³ Inspectors branded their name and the place of inspection on barrels that met requirements.¹⁴⁴

Not all marks were regulatory in nature. Merchants and others through whose hands barrels passed might put their brand symbols, or perhaps inventory or routing

¹⁴¹ *Ibid.*, 154.

¹⁴² Kilby, *Cooper and His Trade*, 113.

¹⁴³ Woodruff, *Cincinnati... Ordinances*, 70-71.

¹⁴⁴ *Ibid.*

codes, on the barrel. Some marks seen on heads and staves were those used by coopers in the process of barrel construction or of later repair work.

Some Universal Principles

Before discussing characteristics that made barrels dominant containers for commerce in the Western World for two millennia, it is informative to compare barrels with other important containers in history. In an article in *Packaging Technology and Science*, Twede proposes nine “universal principles of shipping containers,”¹⁴⁵ and applies them to barrels, to amphorae of the ancient Mediterranean, and to the corrugated fiberboard boxes used in modern palletized shipping container systems. She demonstrates how each type was (or is) ideally suited to the era and regions of use and the purposes for which it was (or is) used.

Barrels, amphorae, and boxes all were made from regionally plentiful and low-cost materials: timber in northern Europe, clay in the ancient Mediterranean, and straw- and wood-pulp in the present-day United States. The technologies necessary to design and produce each container type were in place, as were workers skilled in woodworking or ceramics or paper manufacture. All three types could be extensively reused and eventually recycled. Tons of broken amphorae, for example, were used as fill

¹⁴⁵ Twede, “Cask Age,” 262-263. Tweed’s nine principles are: 1. The package shape and weight facilitate material handling productivity. 2. The geometry facilitates transport by maximizing cube utilization and self-blocking and bracing in the vehicle. 3. Materials and technology are readily available and low-cost. 4. Construction protects from handling and transit forces. 5. Packaging trade associations cooperate to set standards for quality control and work with government to regulate standards. 6. Printing and graphics identify product and ‘brand.’ 7. Shelf-life of food products can be extended. 8. The closure permits easy filling and closing, stays closed during transit, and facilitates opening and emptying. 9. Containers are widely reused or recycled.

in civil engineering projects in ancient ports, and barrel staves might have ended up as fence posts, siding on a shanty, or worked into a piece of furniture. Corrugated fiberboard is readily recycled “back into the corrugated supply chain.”¹⁴⁶

To be effective for its purpose, a shipping container must be designed to fulfill two functions: movement and protection of contents. For most of history and even into the twentieth century, human-power was the primary means of handling cargos. Both barrels and amphorae were ideally suited to being moved around by hand (the former rolled, the latter carried) or moved with simple tools such as hooks, nets, and the like. Both could be securely stowed in the curved holds of the vessels of their day without wasting space. Now, corrugated boxes, stacked on pallets and stretch-wrapped, are easily moved with forklifts and are efficiently stowed in straight-sided truck trailers and freight containers on railcars and ships. During transit, the strength of the barrel’s double arch and the amphora’s egg-like form protected commodities contained within, while modern pallet handling deals gently with corrugated boxes in their stretch-wrapped shells. All three container types prolong the preservation of many foods by sealing out moisture, oxygen, and light. Furthermore, the design of each container allows it to be filled and emptied efficiently, and the contents to be secured against leakage.¹⁴⁷

Trade must also be administered; producers, merchants, inspectors, transporters, and customers all need readily accessible information about the goods with which they are concerned. Wherever trade is organized, package labeling contributes to the smooth

¹⁴⁶ Ibid., 263.

¹⁴⁷ Ibid.

flow of commerce. Barrels, amphorae, and fiberboard boxes have all been labeled with information branded, stamped, incised, painted, printed, or otherwise affixed to the exterior of the container.¹⁴⁸

Historically the shift from one type of container to another has occurred in response to changing conditions, notably, developments in manufacturing and transportation technologies and the availability of natural resources. The transition from amphorae to barrels occurred slowly; both types were in use for centuries. Gradually, though, coopered containers were adapted to fill most needs that had been met by amphorae. During the Age of Exploration, European sailing vessels carried cooperage technology around the world.

TYPES OF COOPERAGE

At some point (or points) in history, as coopers responded to the needs of their customers, to local circumstances and available resources, specialized branches began to emerge.¹⁴⁹ What came to be called white cooperage produced straight-sided staved containers; tight or wet cooperage produced barrels and casks for holding liquids; while slack or dry cooperage served for goods not requiring liquid-tight containers. It is convenient to refer to the craftsmen (and some women) making each type as white-coopers, tight-coopers, or slack-coopers. However, many coopers could and did turn

¹⁴⁸ Ibid.

¹⁴⁹ Kilby, *Cooper and His Trade*, 42-43.

their hands to whichever type offered the best opportunities for profitable employment.¹⁵⁰

White Cooperage

This branch is both the most ancient of the three, and the first to succumb to competition resulting from innovations of the industrial revolution.¹⁵¹ White wares were open, straight-sided staved containers, water-tight and usually splayed.¹⁵² White cooperage is often associated with household needs—buckets, tubs, butter churns, tankards, pitchers, bowls, etc. White coopers also made the larger tubs and vats used by dyers, brewers and distillers, miners, metal-workers, glass manufacturers, builders and others involved in all sorts of industrial processes through the centuries.¹⁵³ White-coopered containers were used on ships, and excavations of the *Mary Rose* and the *Vasa* shipwrecks, for example, have yielded many specimens. It survives today mainly to supply decorative objects and historical reproductions for what Kilby calls “a very small discerning market.”¹⁵⁴ As no examples were recovered from the *Heroine*, white cooperage is not part of the present study.

Tight/Wet Cooperage

Tight cooperage was and is considered the highest form of the craft and the one requiring the most skill. The best tight barrels were tough containers made from the

¹⁵⁰ Shagena, *Barrel in America*, 68.

¹⁵¹ Kilby, *Cooper and His Trade*, 43.

¹⁵² *Ibid.*, 42.

¹⁵³ *Ibid.*, 43.

¹⁵⁴ *Ibid.*, 44.

finest materials. They were capable of holding liquids without leaking and were resistant to both external strain from handling and internal strain—notably that from fermenting alcohol.¹⁵⁵ Tight barrels were also used for heavy, valuable, and/or dangerous materials such as gunpowder. On ships, precious water and whale oil were carried in large tight casks. As late as the 1940s, unlined tight barrels were recommended for carrying acids, liquid and dry chemicals, fruit juices, syrups, vinegar, meats and fish, lard, grease, and dry dyes.¹⁵⁶ Tight casks are still widely used in the production of wines, whisky, and some sauces (Worcestershire and Tabasco, for example) because of the flavor imparted from the wood to the product. A stout, well-maintained tight brewer's cask might have a use-life of 30 to 50 years.¹⁵⁷

Slack/Dry Cooperage

Slack cooperage was considered the least skilled of the three branches. Kilby writes somewhat disdainfully that, though the same basic principles apply to wet and dry cooperage,

dry work differs considerably. The timber used for dry casks is cheap, mostly soft, and often second-hand. The work is not so demanding as in other types of coopering as the goods held do not need expert packaging, and the casks are made to last one journey only.¹⁵⁸

¹⁵⁵ Twede, "Cask Age," 256.

¹⁵⁶ Hankerson, *Cooperage Handbook*, 29-31.

¹⁵⁷ Kilby, *Cooper and His Trade*, 29.

¹⁵⁸ *Ibid.*, 49.

Yet it was slack coopers who made most of the barrels and casks used in commerce.¹⁵⁹ Because not every commodity called for high-quality—and therefore expensive—casks, a tight barrel was not necessarily the *best* choice. Merchants and producers of goods were simply not interested in investing more than necessary in shipping and storage containers. A higher-quality barrel would also be heavier and more cumbersome.¹⁶⁰ Slack or dry coopers, therefore, drew upon centuries of tradition to create barrels and casks to answer a range of needs for hundreds of diverse commodities, varying the materials and the strength and precision of construction in order to balance function and cost. Accordingly, the cheapest slack barrels were relatively flimsy and were designed to hold bulk goods of low value, such as beans or potatoes. Barrels for hardware—nails, bolts, chains, tools and so on—were stronger, though often smaller because of the weight of the contents. Both salt and flour required the protection provided by somewhat higher-quality containers: both articles were affected by dampness in the environment, and flour, in particular, was prone to sift out between imprecisely jointed staves. A special category of cooperage referred to as “dry-tight”¹⁶¹ was capable of holding semi-liquid products like pickled fish or pork that were packed in brine. Some authorities include sift-proof barrels for powdered products in the dry-tight category.¹⁶²

¹⁵⁹ *Ibid.*, 46.

¹⁶⁰ Shagena, *American Barrel*, 28.

¹⁶¹ Kilby, *Cooper and His Trade*, 42-43.

¹⁶² Twede, “Cask Age,” 257.

BARREL CONSTRUCTION

The basic design of the barrel has not changed in over two millennia; a second-century Roman barrel stave might be virtually indistinguishable from a nineteenth-century American stave. Nevertheless, it would be astonishing if such an ancient craft did not encompass regional and temporal variations. Cooperage was practiced in many cultures over a wide geographical area, and barrels and casks were adapted for an equally wide range of available raw materials and intended uses. Even a cursory examination of the closely related traditions of Britain and America reveals divergence in terminology, construction procedures, and tool selection. The specific methods and choice of tools used by an individual cooper might be determined by regional and local traditions, the type of barrels involved, and the cooper's personal circumstances, such as whether he worked in a large cooper shop or carried his tools from place to place on his itinerant rounds.

To provide a basis for the discussions of barrel design in the next section, this section presents a somewhat simplified account of the basic steps involved in constructing most hand-crafted barrels and casks. While some steps in barrel construction are obviously prerequisite to other steps, the order of operation is not absolute, and doubtless any number of possible variations could result in a similar product. The description that follows presents one possible logical sequence. Similarly, most coopering operations could be done with any of several different tools. In this section, some tools are named, and a few are described, but for the present purpose tool choice is of secondary importance. Particular attention is given here to details relevant to

making slack barrels, in contrast to most accounts of barrel/cask-making, which tend to focus on tight/wet construction.

This account was drawn largely from the writings of Kilby¹⁶³ and Shagena,¹⁶⁴ with reference also to Sprague,¹⁶⁵ Ross,¹⁶⁶ Hankerson,¹⁶⁷ and Seymour¹⁶⁸ and from observations of the *Heroine* assemblage. Terminology generally follows nineteenth-century American usage as suggested by Shagena.¹⁶⁹

Barrel Parts

The three main components of a barrel were the staves, the heads, and the hoops (Figure III-1A). The chimes were the ends of the staves, while the bulging middle was the bilge. Holes were sometimes drilled into staves and heads, such as sample holes for removing small amounts of liquid, wet, or dry contents. Bungs of wood or cork were used to plug the holes and seal the barrel, thus the term bung hole. Both ends of a barrel were closed with heads. The top or front head was the one through which the contents were accessed: top if the barrel was standing upright, front if it lay on its side, as in a wine cellar. Holes, with or without taps inserted, were used for filling and removing liquids. (Liquid contents could, of course, also be accessed through bung holes in staves.) For non-liquids, the top head was taken out then replaced. The “bottom” or

¹⁶³ Kilby, “Life of a Craftsman,” part one of *Cooper and His Trade*, 15-84.

¹⁶⁴ Shagena, “Making an American Barrel,” chap. 4 of *Barrel in America*, 67-88.

¹⁶⁵ Sprague, “Cooper,” 33, 35-36, 38.

¹⁶⁶ Ross, *Basque Coopering Technology*, 221-226.

¹⁶⁷ Hankerson, *Cooperage Handbook*, 23-27, 83-84.

¹⁶⁸ Seymour, *Forgotten Crafts*, 27, 86-95.

¹⁶⁹ Shagena, “Making an American Barrel,” chap. 4 of *Barrel in America*, 67-88. An exception is the author’s preference for “chiv” over “howel.”

“back” head remained in place throughout the use-life of the barrel. All barrels containing military supplies shipped on *Heroine*, like most barrels and casks throughout history, were hooped with wood, not expensive iron or other metals.¹⁷⁰ (Metal hoops will not be discussed here.) Figure III-1 shows both partial-hooped and “full-hooped” barrels.

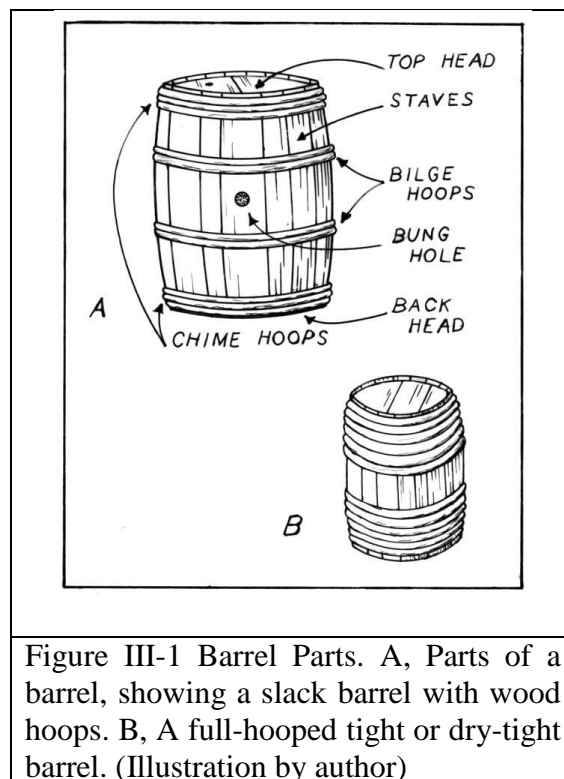

¹⁷⁰ One complete iron hoop and several fragments were found on *Heroine*, but they were not associated with any recovered barrels.

Before the Cooper

Depending on his circumstances, a cooper might undertake the entire process of turning a tree into a barrel. However, initial timber conversion was generally accomplished by craftsmen other than coopers, and the partially processed barrel components delivered to the cooperage.

Staves and Heads. The tree trunk was cut into bolts, sections a little longer than needed for the finished pieces. The bolts were split lengthwise into quarters, and, traditionally, the quarters were split with a froe into rough staves called blanks. Quarter-cutting staves from the bolts (Figure III-2) resulted in the ideal alignment of the wood grain, with the tree's growth rings running perpendicular to the front and back surfaces of the stave and the strengthening medullary rays running across the stave section (Figure III-2B). Quarter-cut staves were both stronger and more resistant to warping than other cuts. Slack staves were often sawn rather than split from the quarters, a quicker and cheaper practice, though the ideal grain alignment would be maintained as much as possible.

Head stock was similarly prepared. Most barrel heads were made from two or more pieces of wood, and head stock consisted of pieces of board that were a little longer than the expected diameter of the heads. Head stock was also quarter-cut. Before delivery to the cooperage, both blank staves and head stock were allowed to dry until properly seasoned.

Hoops. Hoopers were allied craftsmen who supplied cooperages with prepared wooden hoops. Hoop-making was often done by farmers during the winter months.¹⁷¹ They used long, slender branches perhaps 2 in (4.9 cm) in diameter from hickory, maple, or other trees. The hoop poles were cut into appropriate lengths, soaked in water to soften, then riven (split) into two strips. The inner surface was shaved with a drawknife or on a “hooper’s bench” on which the shaver sat astride and pulled the split pole along a fixed blade.¹⁷² Bark was not removed. Sometimes the long edges were trimmed, creating a bevel on one or both sides (Figure III-3). The ends might be notched or simply tapered.

There were many methods for bending the softened wood into a ring. One rather elaborate method was to use an easel on which were mounted several crossbars in a star shape. Adjustable pegs could be placed according to the size of hoop needed. A strip of hoop-wood was coiled *inside* the ring of pegs, its two ends overlapping as much as a quarter to a third of the circumference of the hoop (Figure III-3A). Then, the ends were tied together and the hoops bundled for transport to the cooperage.

¹⁷¹ Haines, “Handmade Barrel Hoop,” 60.

¹⁷² *Ibid.*

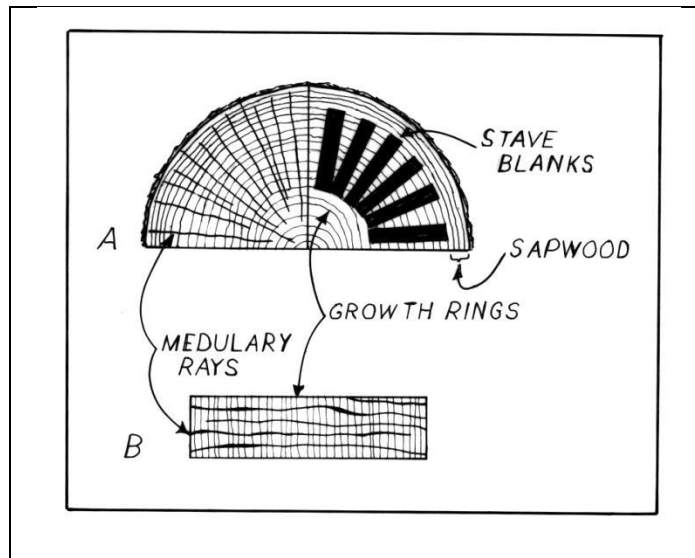

Figure III-2 Timber conversion for barrel staves. A, Cross-section of half a log, showing growth rings and medullary rays (left) and the orientation of stave blanks when quarter-cut (right). Higher-quality blanks will not extend into the sapwood of the log. B, Cross-section/end view of stave blank. (Illustration by author)

At the Cooperage

The cooper was said to do his work at the block. In order to craft pieces of wood into barrel components, the cooper needed something to hold and support them while he wielded ax, adz, saw, or plane. The cooper's block was a solid, heavy stump sunk into the floor upright, rising perhaps knee-high. One or more iron hooks embedded in the block helped secure the piece being worked. For working smaller pieces, perhaps for a keg, a shaving horse was useful. The cooper sat straddled on one end of the horse, controlling with his feet a wooden vise that held the stave immobile.

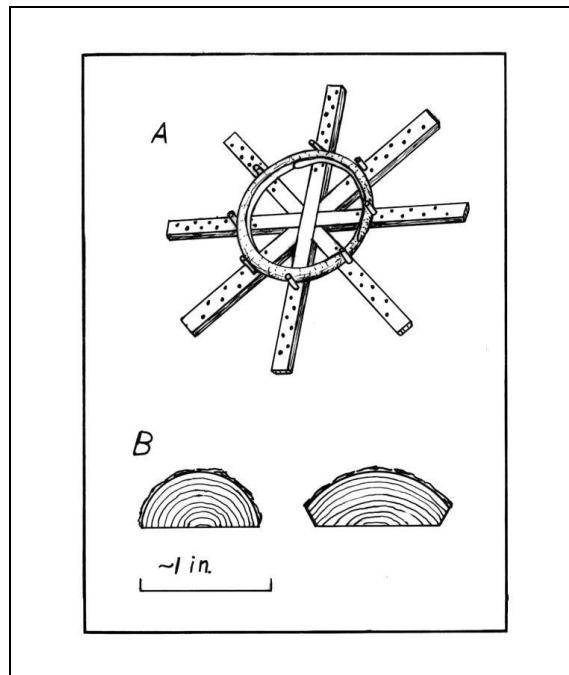

Figure III-3 Wood hoops. A, Hoop bending easel, one rather elaborate method of shaping and sizing wood hoops. B, Cross-sections of wood hoops; note bark intact. (A: Adapted from drawing by David Ashby in John Seymour, *The Forgotten Crafts*, New York: Alfred A. Knopf, 1984, 27; B: Illustration by author)

Dressing the Staves. Because the circumference of the finished barrel would be greater at the bilge than at the ends, the individual staves needed to be wider in the center than at the ends. Therefore, the cooper first listed the stave, using a cooper's ax (Figure III-4), removing wood from the edges of the blank so that it tapered toward the ends (Figure III-4B). A rough shot, or angle (see Figure III-4 caption), was put on the edges at the same time. Unlike most axes, the blade of a cooper's ax was not in line with

the handle, but offset to one side. Backing and hollowing refer to shaping the outer (back) and inner surfaces to fit the curve of the barrel's intended circumference and to facilitate bending robust staves to create the bilge (Figure III-4C). Backing was done with a drawknife having either a straight or curved blade, called a backing knife, by shaving the back of the stave along its edges. Hollowing required a curve-bladed hollowing knife. Wood was removed from a long oval from the center of the inner surface, leaving the edges and ends unshaved. The amount of wood shaved depended on the thickness of the stave. The thinner, more flexible staves of slack barrels required little or no backing and no hollowing; both steps were often omitted entirely.

A cooper's jointer or joiner is a very long carpenter's plane fixed in place with blade upwards; it was used to refine the shot on the edge of the stave. The cooper jointed the stave by passing it over the blade, tilting it so that the edge angled inward (Figure III-4E). The width of the back of the stave was thus slightly greater than that of the interior surface. The staves would then form a neat curve when fit together. (Figure III-4D).

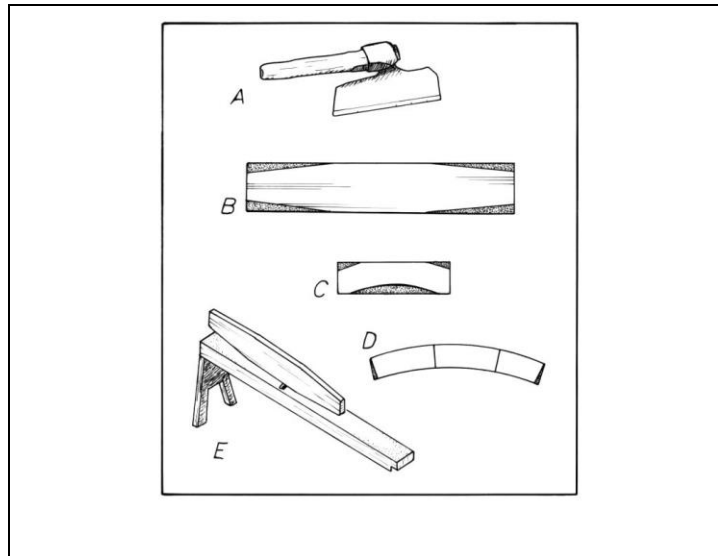

Figure III-4 Preparing the Stave. A, Cooper's ax, a broad ax with the blade offset. B, Stave blank; shaded areas indicate wood removed when stave is listed. C, Cross-section of stave near bilge; shaded areas indicate wood removed by backing (upper edges) and by hollowing (lower middle). D, Three listed staves viewed from end; shaded areas indicate wood removed by listing and jointing. E, Listed stave being run over cooper's joint to smooth the edges and put on the shot. (Illustrations by author)

Raising the Case

The case is the body of the barrel, shaped but without heads. Once sufficient staves were prepared, it was time to begin assembling the barrel. This step was accomplished using a set of special temporary wood or metal hoops of different sizes. These hoops were not adjustable. They were tightened by hammering them down toward a greater circumference using a mallet and a tool resembling a chisel, one type suitable for wood hoops, another for metal.

Staves were raised up by arranging them one at a time in a raising hoop held horizontally as a frame until their upper ends fit snugly in the hoop and the lower ends flared outward to rest on the floor (Figure III-5A). The raising hoop was then hammered down to secure the staves more tightly together. A larger hoop, a runner, was put down over the raising hoop past the bilge and tightened. A bilge hoop, possibly metal, of a size to fit one-third of the way down was put down and tightened. The runner hoop was then removed, leaving the raising-up hoop and the bilge hoop in place. The construction was placed over a small fire contained in a basket-like iron cresset. Firing made the staves pliable enough to be trussed—bent into the classic bulging shape. Very stout (thick) staves needed to be steeped in boiling water or steamed before firing.

Once the staves were hot enough, trussing began. With the raising hoop still uppermost, the first large runner hoop was put back on and hammered nearly to the ground, followed by a second slightly smaller one. Then, a truss hoop was driven tight near the bilge to prevent the staves from bending too far and cracking outward during the bending process (Figure III-5B).

At this point, the barrel was inverted, and the first runner removed. By driving the second runner down toward the bilge on one side only, the cooper forced the staves together until a smaller truss hoop could be lowered over the top (Figure III-5C). The tilted hoop was straightened to horizontal and the smaller one pounded aslant to bring the stave ends close enough to catch a still smaller hoop. This process was repeated until the final hoop matched the diameter of the raising-up hoop. Larger, stouter barrels required the coordinated efforts of more than one cooper to bend the staves into shape.

The slighter staves of slack barrels were much easier to shape. Once the large runner was driven to the ground and the barrel inverted, trussing could be achieved by a single craftsman hammering hoops aslant as described above. Alternately, a winch-rope cast around the flared ends of the barrel could be used to draw the staves close enough together to receive the trussing hoops. The cooper's windlass and the Dutch Hand are two traditional winching devices (Figure III-5, D and E).

The shaped barrel was then fired a second time over the cresset to give it set, so the staves would retain their shape when the temporary hoops were removed.

Chiming the Ends of the Case

This step prepared the ends of the barrel to receive the heads (Figure III-6A). With the end hoop placed about ½ in (2.5 cm) below the end of the barrel, the inside edge of the barrel was given a rough bevel with a short-handled adz or chiming adz (Figure III-6B). The bevel could then be smoothed with a finishing adz. The tip ends of the staves were smoothed either with an adz or by running a topping plane or sun plane around the barrel end.

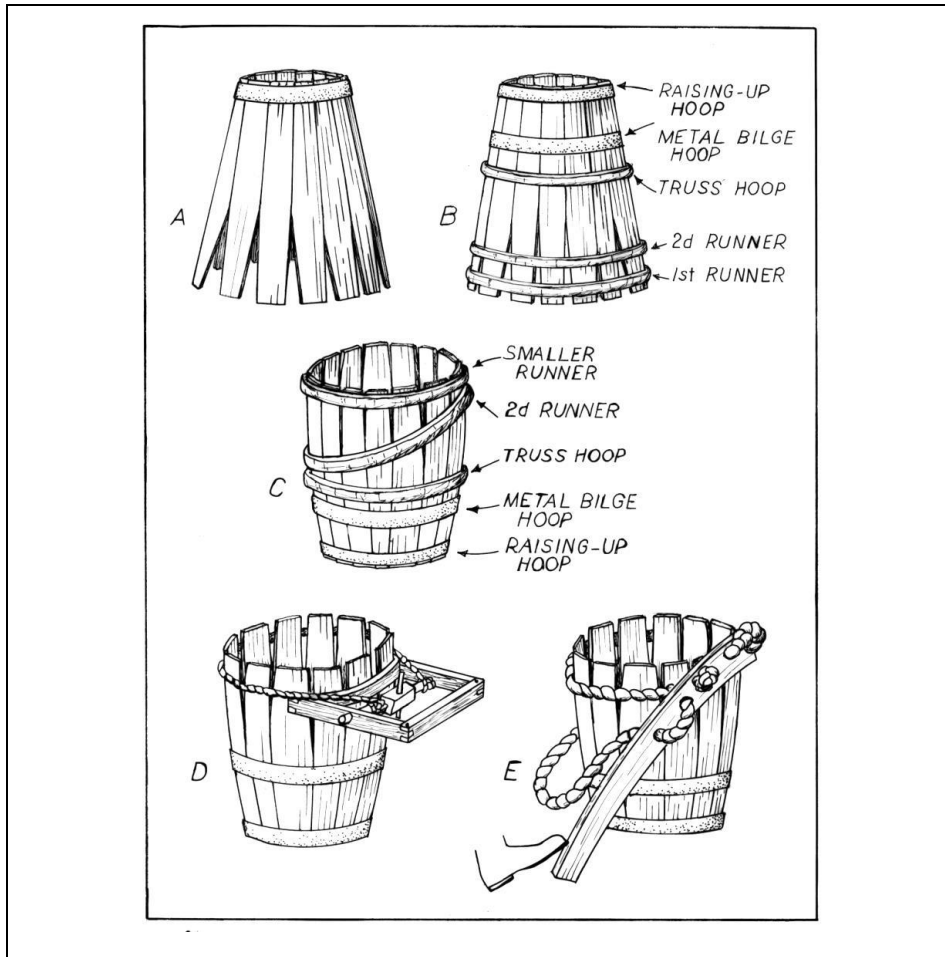

Figure III-5 Assembling the Case. A, Staves gathered in raising-up hoop. B, Additional temporary hoops added to secure the staves and begin shaping the barrel. C, Staves of a stout barrel that will be drawn together by hammering a trussing or runner hoop down on one side only until a smaller hoop can be caught over the stave ends. D and E, Drawing staves together using winch ropes. D, Spanish windlass used for stout or slight staves E, Dutch hand used with slight staves. (A, B, and C: Illustration by author; D: Adapted from drawing by Eric Thomas in John Seymour, *The Forgotten Crafts*, New York: Alfred A. Knopf, 1984, 89; E: Adapted from drawing by Kenneth Kilby, *The Cooper and His Trade*, Fresno, CA: Linden, 1989, 81.)

A shallow channel called a howel or chiv was cut below the bevel to make a smooth, even surface to receive the croze groove. The tools that cut the chiv and the croze groove, called a chiv and a croze, respectively, were similarly designed. They consisted of the appropriate blades suspended below a block of wood that the cooper slid around the top of the barrel, allowing the blades to shave the channel or cut the groove evenly around at a fixed distance from the end (Figure III-6C).

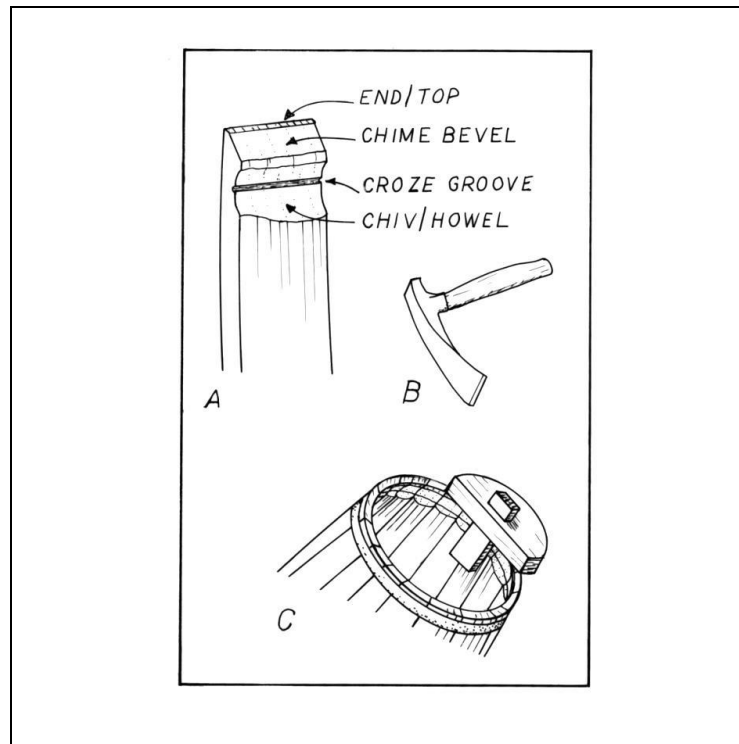
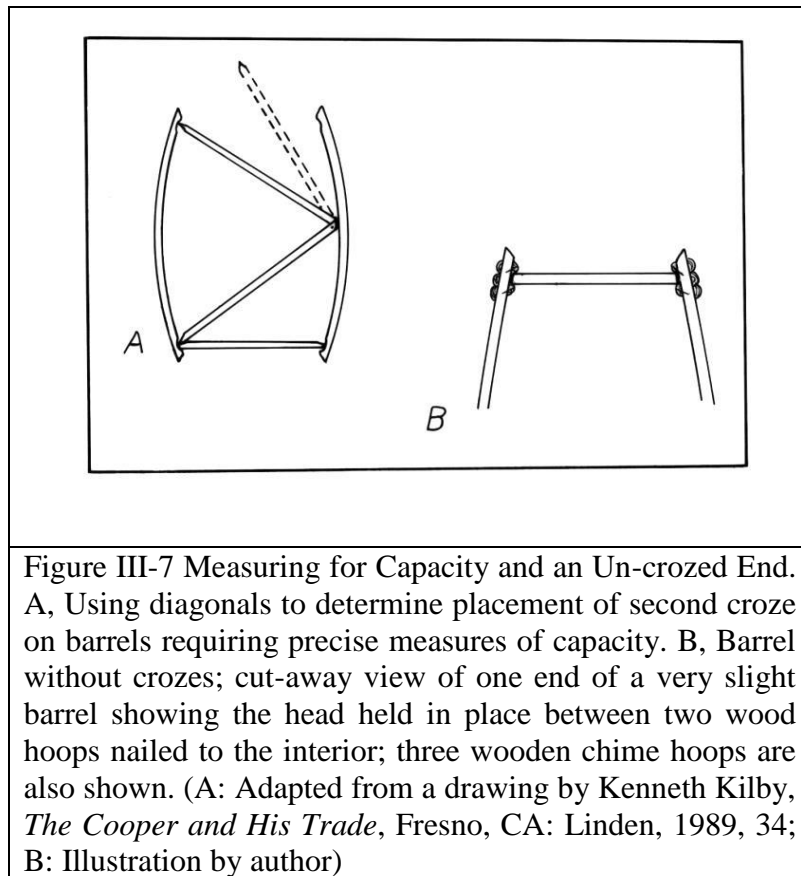

Figure III-6 Finishing the Ends of the Barrel. A, Parts of a finished stave end. B, Cooper's adz, used, among other things, to cut the chime bevel. C, A chiv or a croze; drawing represents either tool to show how it can be run around the end of the barrel, allowing the cutting blades to carve cut the chiv/howel or the croze groove at an even distance from the ends of the staves. (Illustrations by author)



The barrel could now be inverted and the other end finished. If a precise measure of barrel contents was required, the capacity would be checked with diagonals, a pair of hinged rods of wood or metal. The second croze could then be placed appropriately (Figure III-7A). Barrels with very slight (thin) staves were sometimes given neither croze nor chiv. A wooden hoop was nailed inside the barrel end to support the head, and a second hoop nailed down over the head to close the barrel (Figure III-7B).

Cleaning the Case

The inside of the barrel was shaved clean with an inside shave, stoup plane, or one-handed or two-handed scraper. To smooth the outside with a spoke shave or buzz, hoops were removed and replaced as necessary.

Making the Heads

Heads were cut to size for each barrel. The diameter of the head was determined by measuring the barrel at the croze using a large compass (Figure III-8A). The spread of the points was adjusted by trial and error until, when one point was placed in the croze, the compass could be swung exactly six times around the circumference back to the starting point. The spread of the points then equaled the radius of the head. Though the head of a small cask might be made with a single piece of wood, most heads were made in two or more pieces (Figure III-8B).

Pieces of head stock were selected and dressed to be as thin as needed on the underside, especially near the edges. Using the cooper's joint, the joins where the head pieces would abut each other were cut square or with a very slight angle. With the pieces arranged to fit correctly together, assembly marks in the form of diagonal or arc lines were etched across all the pieces. These marks could be easily realigned, ensuring that the matching edges remained together when the head was assembled or re-assembled later after the barrel was in use. The compass was then used to scratch a circle of the required circumference on the head (Figure III-8C).

If the head parts were to be joined together with dowels, the dowel positions were marked on adjacent head pieces. Dowel holes were drilled into the edges, dowels

fitted, and the head pieces secured together. Flagging was placed between the head pieces of tight casks. Flags are strips of dry reed that swell when exposed to liquid barrel contents and thus prevent leaking. Flagging could also be placed between the head and the croze and between staves. Slack barrel heads were often not doweled at all, and flagging was not used between the joins.

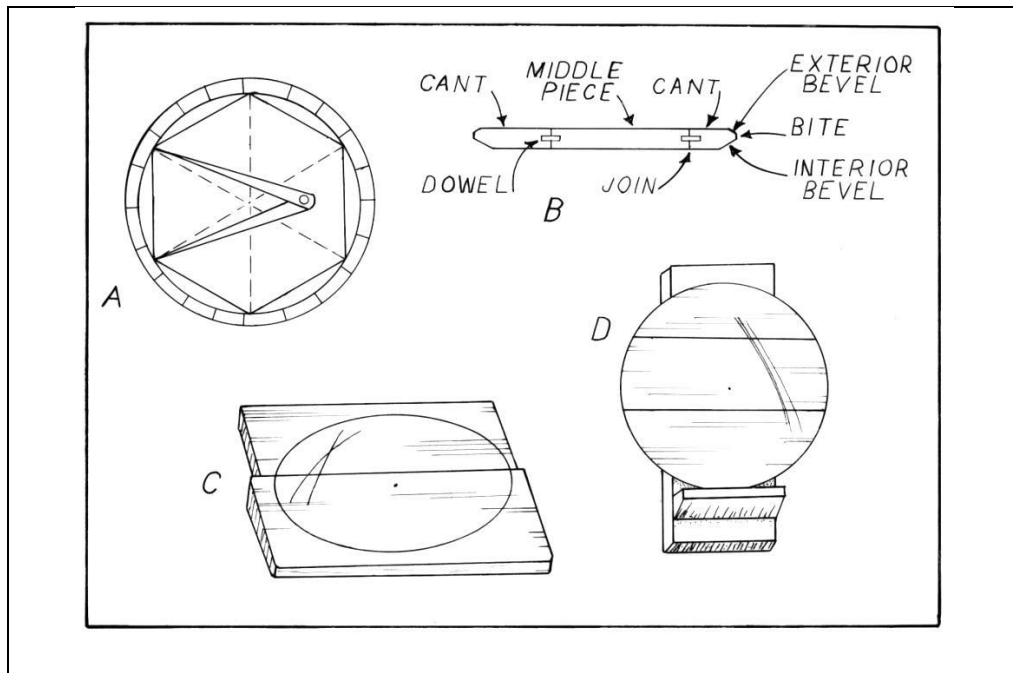

Figure III-8 Making the Heads. A, Determining the diameter of the head using a compass to “walk” exactly six times around the croze. B, Parts of a head; cross-section of a three-piece head, cut across the grain of wood. C, A two-piece head, already jointed, ready to be cut out with a bow saw; the join runs parallel to the grain of the wood; pieces may or may not have been doweled together; assembly marks are scribed across the pieces and the small center dot marks the hole left by compass point. D, A three-piece head on a heading board ready to be planed smooth; compass hole and assembly lines. (A: Adapted from a drawing by Jack L. Shagena in *An Illustrated History of the Barrel in America*, Bel Air, MD: privately printed by author, 2006, 83, fig. 4-21; B, C, and D: Illustrations by author)

The head was cut out with a bow saw to be slightly larger than the drawn circle. With the head held securely on a heading vise or heading board (Figure III-8D), the outer and inner surfaces were smoothed with a heading swift or two-handed plane. The exterior and interior bevels were cut using a heading knife. The interior bevel was generally somewhat wider than the exterior. The bite, the narrow edge of the head, was formed to complement the size and shape of the croze.

Installing the Heads

The bottom (back) head was installed first. The hoop at the chime was removed and the next hoop loosened by hammering it upwards, away from the bilge. An edge-joined head would be put in sideways then pushed into the croze from the inside. For heads with multiple separate pieces, the middle pieces were placed first, then the larger cant, or side piece, and finally the smaller cant piece. The wider half of a two-piece head was inserted first. The chime hoop was then replaced and tightened.

To install the top (front) head, the chime hoops were again removed or loosened. A joined head would be lowered into the barrel, and one edge fitted into the croze. Then the other side was pulled up into place with a small tool called a thief. This tool, like a tiny corkscrew, was screwed deeply enough into the head's surface to gain purchase for pulling. Multiple separate pieces were placed as above, larger pieces first, the last with aid of a thief if needed. If the barrel was intended for non-liquids, the head pieces might be dropped into the barrel for safekeeping and not be installed until after filling.

Finishing the Barrel

To complete the barrel, temporary hoops were replaced by permanent hoops. The outside surface of the barrel was smoothed if it had not been done earlier. Bung holes and/or tap holes were drilled and bungs or taps put in place.

PHYSICS OF BARRELS

Barrels were works of ancient engineering that were remarkably strong for their materials and weight. This strength was produced by the interplay between the material (wood) and the double-arch design. The craftsmanship of the cooper was also a significant determinant of barrel strength.

Robustness of Barrel Design

To explain the barrel's inherent strength, Shagena,¹⁷³ himself an engineer, applied the modern concepts of "damage tolerance" and "pre-stressed design" to the barrel. "Damage tolerance" refers to "the ability of an assembly or individual component to continue to function satisfactorily despite minor damage that is the direct result of use."¹⁷⁴ This ability is made possible by "a design technique that takes advantage of intrinsically desirable characteristics found in different materials," and which thereby "pre-stresses" the object so designed. Pre-stressing and damage tolerance were achieved in the barrel by its double-arch construction and the resiliency of woods used for staves, heads, and hoops (and in later centuries, metal for hoops).

¹⁷³ Shagena, *Barrel in America*, 28-32.

¹⁷⁴ *Ibid.*, 28.

The first key to the hardness of barrels was their double-arch construction, which is related to the ancient principle of the arch in architecture. An architectural arch consists of a series of wedge-shaped blocks placed so as to describe a curve, usually over open space, and held up by sturdy bases. Placement of the keystone completes the arch. Once the keystone is in place, the downward force of gravity and other forces from adjacent architectural elements compress the blocks together, increasing friction between them and preventing them from sliding out of position. Those forces are transmitted around the arch and through the base into the ground without compromising the arch's stability.

Though obviously not grounded to the earth, a barrel's structure formed an arch from two different views. As seen from either end, the staves described a circle around the head. Each stave was in cross-section essentially a wedge, the exterior surface being wider than the interior surface. Thus, each individual stave functioned as the keystone of an arch, with the other staves acting as the base. If viewed from the side, the stave was again the keystone, but here the two heads act as the base.¹⁷⁵

The essential compressive force that gravity contributes to architectural arches was provided by a barrel's hoops. Driven tightly around the staves, the hoops, whether wood or metal, were in a state of tension that compressed the staves together, forcing each stave against its neighbors and against the heads.¹⁷⁶ This pre-stressing allowed forces assailing the barrel to be distributed through the structure, rather than being

¹⁷⁵ Hankerson, *Cooperage Handbook*, 1. Twede, "Cask Age," 255.

¹⁷⁶ Shagena, *Barrel in America*, 29.

concentrated in a small area. From the inside, for example, the weight of a barrel's contents worked to force the staves apart. In a barrel of water standing upright, the full weight of the water pressed on the lower portions of the staves, but that pressure decreased to zero at the level of the water's surface. The tightly driven hoops kept "the staves in compression that oppose[d] the internal pressure, and therefore [kept] the barrel tight and free from leaks."¹⁷⁷

Because the hoops were driven toward the barrel's characteristic bulging middle, or bilge, they were forced into a state of tension greater than could be achieved on a straight-sided container. The bilge was created by the shape of the individual staves, wide in the middle and tapered toward either end. When the staves were bent in the raising-up process and held together by hoops, the diameter of the construction was greater in the middle than at either end. Each stave became part of an integrated whole with "a unified structural integrity found in only the best mechanical designs."¹⁷⁸ The heads in turn were securely seated in their crozes, both compressed by and protected by the chime hoops that encircled the two ends of the barrel.

The integrity of its structure and the resiliency of the wood in its construction enable the barrel to survive a variety of assaults occasioned by normal use. A barrel might be rolled on uneven surfaces; lifted with hooks, ropes, or nets; bumped against its neighbors or other structures; or dropped onto its end or side. External forces applied to different parts of a barrel were distributed through the structure, preventing or

¹⁷⁷ Ibid.

¹⁷⁸ Ibid., 30.

minimizing damage at the point of impact. A force might strike the end of a stave at the chime parallel to the length of the stave, for example, without dislodging it; its tapered edges were compressed against those of its neighbors restricting its movement,¹⁷⁹ while the hoops at the opposite end of the barrel acted to hold all the staves in position. The heads, firm in their crozes, further restricted the movement of individual staves.¹⁸⁰ A force applied to a stave's outer surface between the hoops might cause the stave to be slightly depressed and even provoke a small amount of movement and leakage. Even so, much of the force would be dissipated through the staves on either side, and the wood could spring quickly back into position.¹⁸¹ A hoop that received a jolting impact also distributed the force around the barrel's circumference. Wooden hoops were prone to breakage, hence the grouping of two, three, or more hoops. The remaining hoops would hold the barrel together until the broken ones could be replaced.

Certainly, a catastrophic event such as being dropped from a height could seriously damage a barrel or destroy it altogether, and repeated small abuses would damage a barrel's components, compromising its integrity. In many cases, however, a damaged barrel would continue to function satisfactorily until needed repairs could be made.

¹⁷⁹ Ibid.

¹⁸⁰ Ibid.

¹⁸¹ Ibid., 31.

The Cooper's Skill

In addition to the strength inherent in the barrel's design, the skilled cooper's knowledge of his craft contributed greatly to the durability of barrels. Oak was the preferred wood for tight cooperage, though many other woods were also used. First, the cooper selected the appropriate wood for the job, choosing pieces without faults that could cause cracks and structural failure.¹⁸² Ideally, the wood was quarter-sawn so that the growth rings were perpendicular to the exterior surface of the stave (as viewed from the end) while the strengthening medullary rays (most prominent in oak) ran parallel to the surface (Figure III-2). Such staves were able to resist shrinking and warping while bearing significant longitudinal pressure.¹⁸³ Wood for slack cooperage was of lesser quality and more economical than that used for tight cooperage, but the cooper took best advantage of whatever grade of wood he had. All grades of wood needed to be properly seasoned to prevent later shrinkage, but not allowed to become too dry, lest it lose its "life and resiliency."¹⁸⁴ In choosing pieces of wood for individual components, the cooper was careful to match staves according to toughness. A softer stave between harder ones was prone to being pushed out or cracked during firing or later during use.¹⁸⁵

The more precisely the parts were crafted, the stronger the final product was. The cooper knew from experience how sharply to taper the ends of the staves when he listed the blanks. Listing gave the staves a rough shape that would be refined on the cooper's

¹⁸² Kilby, *Cooper and His Trade*, 20-21.

¹⁸³ *Ibid.*, 71.

¹⁸⁴ Hankerson, *Cooperage Handbook*, 25.

¹⁸⁵ Kilby, *Cooper and His Trade*, 24.

joiner. Of particular importance was the shot put on the edges of a stave when it was jointed. He adjusted the angle to achieve the desired radius of the barrel at the ends and at the bilge: the jointing determined the “height,” or the amount of curve, of the bilge. It should be neither too great, resulting in a balloon-shaped barrel (liable to crack outwards), nor too little, making it box-shaped (losing the double-arch advantage).¹⁸⁶ The skilled cooper working by eye could vary the angle along the join according to the increasing and decreasing circumference of the barrel, producing staves that would fit snugly together along their entire lengths. Head pieces also needed to fit tightly together. Head joints, however, were made square (or nearly square) to prevent the head’s lifting or dropping during use, which would weaken the seal between head pieces and between the head and staves.¹⁸⁷ Proper jointing was essential to the barrel’s ability to function without leaking.

The chimes, projecting as they did beyond the heads, were prone to damage even in routine handling. Barrels were tipped from an upright position to lie on their sides, then rocked upright again, for example, or they might be lifted with hooks placed over both chimes. Such handling could cause the chimes to crack or even break, especially along the croze grooves. Aware of this vulnerability, the cooper reinforced this area by using the strongest, widest hoops as chime hoops.¹⁸⁸ Also, he would see that the croze groove was cleanly cut and that the head’s bite filled the croze completely, reducing the

¹⁸⁶ Ibid., 23.

¹⁸⁷ Ibid., 38.

¹⁸⁸ Ibid., 36.

chance of leaks and increasing the overall strength of the barrel.¹⁸⁹ A further detail of construction that affected stave performance was the chime bevel, also called a chamfer. It has been suggested that the chamfer was cut for aesthetic reasons or to facilitate lifting the barrel, but it is more likely that it helped prevent chipping or splintering.¹⁹⁰ The resulting wedge shape would give the chime a slightly increased flexibility, allowing it to better absorb the forces to which it was so often subjected.

The area around the bung, if there was one, was another notably vulnerable part of many barrels, and the bung stave was more likely than other staves to crack outward at the bilge. Here again, the cooper selected the toughest stave available, thereby compensating for the weakness.¹⁹¹

When the cooper shaved the exterior of the barrel smooth, it was not only for appearance sake. If the join between two staves was uneven, the hoop could not provide even tension, and the ability of the container to disperse forces would be diminished.¹⁹²

A final area where the skilled cooper could prolong the use-life of barrels was with prompt attention to routine maintenance, and many coopers were employed solely for this function. Replacing cracked staves involved partly disassembling the barrel to remove the broken staves. Replacements, often salvaged from old barrels, were selected to match the discards in width and amount of bilge so as to integrate into the

¹⁸⁹ Shagena, *Barrel in America*, 82.

¹⁹⁰ Bertrand, *Descriptions Des Arts Et Metiers*, Tome III,(Neuchatel, 1767), Art Du Tonnelier, 373, referenced in "Cooper's Chamfer Knife," 40.

¹⁹¹ Kilby, *Cooper and His Trade*, 18, 55.

¹⁹² Marshall Scheetz, journeyman cooper, Colonial Williamsburg Foundation, Williamsburg, Virginia, correspondence December 1, 2004, with Shagena, quoted in Shagena, *Barrel in America*, 85.

reconstructed barrel tightly and without significantly altering its capacity. The replacements and the adjacent staves all required re-jointing before the barrel was reassembled. Hoops required maintenance as well. Wooden hoops frequently broke and needed replacing. If wood or iron hoops became loose due to slipping or shrinkage of the staves, not only might the barrel leak, but much of its strength could be lost. Therefore, both tight and slack barrels needed to be examined regularly and the hoops tightened or replaced as needed.

BARRELS ON THE MOVE

The popularity of barrels over the millennia was due to their strength and economical construction, and also to the relative ease with which they could be handled by one man or a small gang, and stowed and transported in the available modes of transportation. The mobility of barrels is enthusiastically described by Hankerson:

The barrel is really a container on wheels. One man can handle it, even when it is loaded with several hundred pounds. When a barrel is resting on its side, only a small surface comes in contact with the floor, due to the bilge construction. This, of course, reduces friction to a minimum [,] and the barrel will roll easily and respond to a push in any direction. On an incline, the barrel will move of its own weight, and this fact often cuts down materially on handling costs. The barrel, on its bilge, is easily turned and guided in any direction, as it pivots on a small contact point.¹⁹³

Where the surface was not suitable for rolling, a barrel could be moved with a hand-truck.

¹⁹³ Hankerson, *Cooperage Handbook*, 33.

Muscle power, aided by a few simple tools, sufficed for all handling needs until the late nineteenth century. The legendary ruggedness of barrels notwithstanding, a certain degree of care prevented losses from damage and lengthened their service life. Hankerson, in the 1940s, suggested a few “rules of careful handling” that summed up the experience of generations of barrel handlers. How well and how consistently such recommended practices might have been followed would have depended on many variables—the size and skill of the crew, the type of landing facilities or lack thereof, and the vagaries of weather, to name but a few. The rules apply to all types barrels, though slack barrels with their thinner staves required extra care in handling:¹⁹⁴

- Never let a loaded barrel drop, even a few inches.
- Do not allow barrels to slam into each other when rolling down a skid.
- Do not roll barrels over rough surfaces such as cobbles.
- Never roll a barrel on its chime. Always roll a barrel on its side, or bilge.
- To up-end a barrel lying on its side, grasp it by the chime and rock it back and forth on its bilge until it rocks into an upright position.

Hankerson also advises that tight barrels should never be stored on end, but always on their sides, and always with the bung stave up. In contrast, slack barrels should always be stored on end, not on their sides, and in no more than two or three tiers.¹⁹⁵

¹⁹⁴ Ibid., 91, 33-34.

¹⁹⁵ Ibid., 41, 96.

Tools for Moving Barrels

No doubt one of the earliest handling tools was the skid, or ramp, for moving barrels and other casks to elevations a few feet higher or lower. The ramp could be as simple as a plank, or a parallel pair of planks, laid from the river bank to a boat. Wide, multipurpose ramps are often seen in depictions of steamboats along the levees. The slats running across the ramp to improve footing are missing their middle sections, leaving a smooth area wide enough for the bilges of barrels to roll. An illustration in Mark Twain's *Life on the Mississippi* (Figure III-9) shows two crewmen lowering what appears to be a skid down through the hatch to a steamboat's hold, while another rolls a barrel toward the hatch.¹⁹⁶ The barrel would be rolled down the skid into the hold where a crewman would be waiting to receive barrel and ease it down into the hold. Small skids also aided the placing of second and additional tiers of barrels in warehouses or in holds of ships.

- Barrels could be lifted aboard a ship or out of the hold with rope tackle of blocks/pulleys attached perhaps to a ship's mast or other structure or to a shore-side structure/crane (Figure III-9). Three common methods for lifting and lowering barrels are slings, hooks, and nets.
- Slings were made by wrapping ropes or chains around one or more barrels, and were preferred over cam hooks for handling valuable liquids.¹⁹⁷

¹⁹⁶ Twain, *Life on the Mississippi*, illustration 75: Sublime in Profanity.

¹⁹⁷ Stevens, *On the Stowage of Ships*, 101.

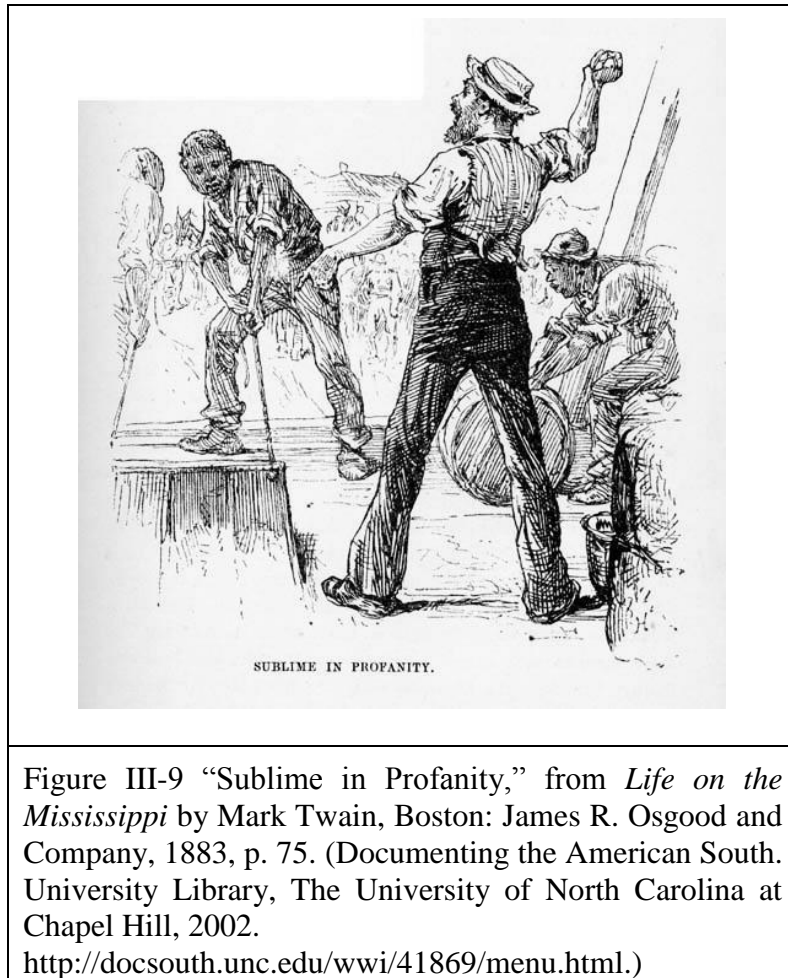

Figure III-9 “Sublime in Profanity,” from *Life on the Mississippi* by Mark Twain, Boston: James R. Osgood and Company, 1883, p. 75. (Documenting the American South. University Library, The University of North Carolina at Chapel Hill, 2002. <http://docsouth.unc.edu/wwi/41869/menu.html>.)

- Cam hooks, also called can hooks or chime hooks, had splayed ends, like a bent spatula, to hook over the chimes of the barrel. They worked in pairs connected with rope in the middle. With the correct tackle, several pairs might be used to lift several barrels at once.

- Several barrels might also be bundled together in a large net for lifting, though Hankerson strongly advises against this method.¹⁹⁸ He prefers slings over chime hooks for slack barrels to reduce the chance of damage to the chimes.

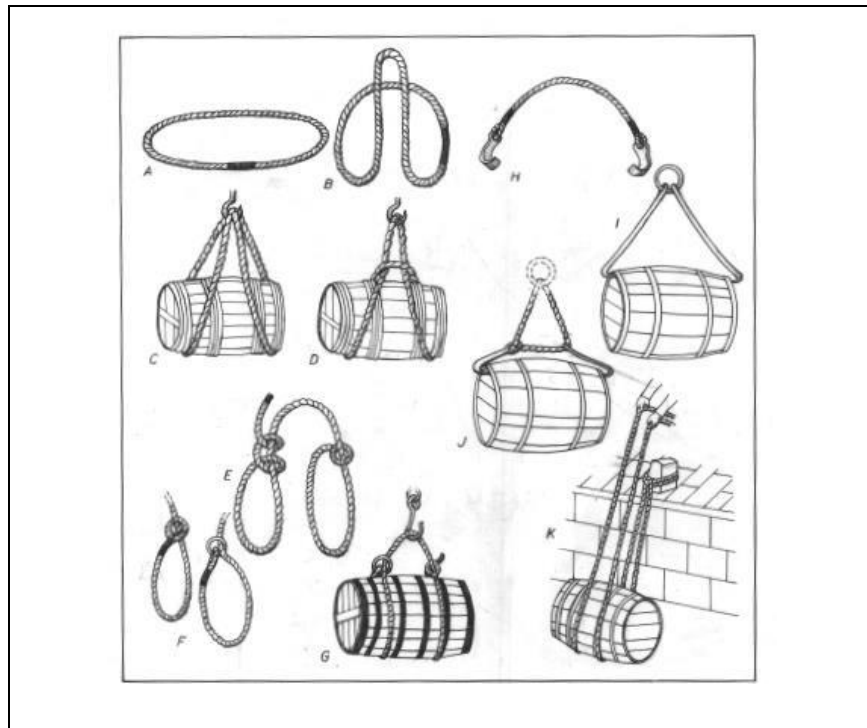

Figure III-10 Slings and Hooks. A, B, C, and D, Barrel or bale slings. E, F, and G, Butt or hogshead slings for larger casks. H, I, and J, Can, cam, or chime hooks. K, Parbuckling. (A, B, E, G, H, and K: Adapted from Biddlecombe, *Art of Rigging*, plate V, figures 8, 13, 12, 7, 6, and 1; C: Detail adapted from Brady, *Kedge Anchor*, figure “Gammoning the Bowsprit,” opposite p. 250; D, Detail adapted from Lever, *Young Officer’s Sheet Anchor*, figure 149, opposite p. 19; I and J, Drawn from photographs in Hankerson, *Cooperage Handbook*, figure 43, p. 93 and figure 13, p. 35, respectively; F, Illustration by author)

¹⁹⁸ Hankerson, *Cooperage Handbook*, 35-36.

Stowage

A nineteenth-century nautical text defined stowing cargo as “arranging bales, cases, casks, barrels, packages, &c, in such a manner that they shall occupy the least possible space, and that they shall be perfectly free from damage by salt water, or by proximity or contact with each other.”¹⁹⁹ This crucial skill involved more than simply the efficient use of space. Careful attention had to be given to the distribution of the weight of the cargo, with the lighter goods along the sides and toward both ends of the vessel, and heavier items longitudinally arranged down the center. The most serious consequence of badly stowed cargo aboard a sailing ship was (and is) that it could compromise the stability of the vessel, in extreme cases literally causing the ship to capsize in rough seas and high winds. Stability issues were of concern on river steamboats as well. Listing too far could cause higher boilers to lose water and overheat, setting up the possibility of an explosion.²⁰⁰ River waters could be rough as suggested in Mark Twain’s illustration “Deluged and Careened,” (Figure III-11) showing a storm-tossed side-wheel steamboat listing nearly 45 degrees.²⁰¹

Information regarding how cargos were stowed aboard river steamboats of the nineteenth century is scarce, particularly for earlier periods. It is helpful, however, to consider stowage in seagoing vessels.²⁰² Hold cargos of casks were stowed on their

¹⁹⁹ Bell, *Nautical Instructor*, 44.

²⁰⁰ Crisman, Kevin, personal communication, April 7, 2014.

²⁰¹ Twain, *Life on the Mississippi*, illustration 209.

²⁰² There are numerous published sources for this topic, and there is, not surprisingly, considerable redundancy between them. Four sources were consulted here: Bell, *Nautical Instructor*, 44-51; Reed,

sides, bedded and quoined to hold them secure. Beds were thick flat pieces of wood placed under the cask's quarters, the area between the chime end and the bilge and the strongest part of the container. At least two beds were required for each cask, though

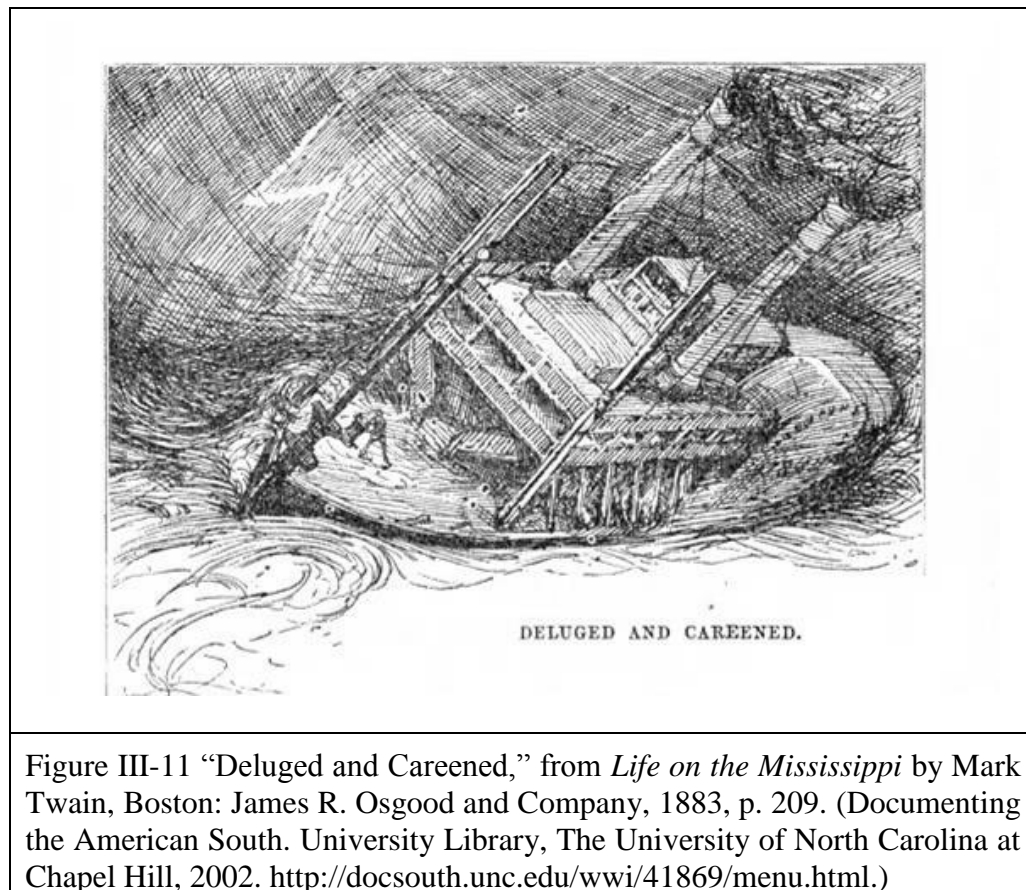

Figure III-11 “Deluged and Careened,” from *Life on the Mississippi* by Mark Twain, Boston: James R. Osgood and Company, 1883, p. 209. (Documenting the American South. University Library, The University of North Carolina at Chapel Hill, 2002. <http://docsouth.unc.edu/wwi/41869/menu.html>.)

Reed's Seamanship, 21-23; Stevens, *On the Stowage of Ships*, 101-102, 323-324, 513-514; and Young, *Nautical Dictionary*, 2, 29, 33, 36, 73, 84, 136-137, 393-394.

those containing valuable liquids might have four or six.²⁰³ Wedges called quoins were used to hold the cask steady on its bed, and short pieces of wood called chocks were driven into spaces between casks. Dunnage, wood branches, bamboo, or other material used to cushion cargo and keep it out of water that collected in the hold was not needed for bedded casks. Casks were generally laid fore and aft, lengthwise to align with the ship's keel, but sometimes were stowed a-burton—perpendicular to the keel, or athwartships. They were positioned bung-up, bilges free, chime to chime, head clear, and bilge and cantline. If a cask had a bung, the head pieces were installed to be perpendicular to the bung stave. Keeping the head pieces vertical increased the amount of stress a cask could bear.²⁰⁴ Beds and chocks kept the bilges, the weakest part of the cask, free, not only of the floor and sides of the hold, but also from contact with other casks beside, above, or below. A line of casks lying chime to chime was spaced to prevent contact between neighbors, or heads clear.

Bilge and cantline meant that adjacent lines of casks, whether beside, above, or below, were staggered so that the bilges of one line were close to the chime ends of the next line. Compared with bilge and bilge arrangement, bilge and cantline wasted little space and required less wood for beds and quoins. The number of tiers allowed depended on the type of cask, up to three tiers for the larger butts and pipes, four tiers for puncheons, and six for tierces or hogsheads. The smaller barrels might go as high as eight tiers, though one source allows only five tiers for barrels of provisions and tallow

²⁰³ Stevens, *On the Stowage of Ships*, 513.

²⁰⁴ *Ibid.*, 514.

casks.²⁰⁵ To make best use of the available room, smaller casks were stowed in the wings of the hold where the curved hull of the ship created an awkward space.

Like their counterparts at sea, those responsible for stowing cargo in the holds of river steamboats sought to use the space efficiently, secure the cargo from damage, and avoid compromising the stability of the vessel.²⁰⁶ Steamboat holds were long, narrow, and box-like. The weight of a well-stowed cargo would certainly have been distributed as evenly as possible along the length and breadth of the hold. As to the system of stowing barrels and casks in such a space, some ideas are suggested by Hankerson's instructions for loading barrels into railroad box cars.²⁰⁷ He calls for loading *all* barrels and kegs on end.²⁰⁸ In preparation for barrel cargos, two strips of wood should be attached horizontally to the back wall of the car to support the quarters of the barrels and keep the weaker bilges from contact with the wall. The two end barrels of the first row are placed firmly in the corners, and the remaining barrels evenly spaced between them. The second row is nested in the first, and has one fewer barrel. The third row repeats the first, and so on, and it is important to load them tightly together.²⁰⁹ To load a second layer, boards are laid on top of the floor layer, and another pair of strips is attached to the back wall at the appropriate height.²¹⁰ Hankerson describes several methods of securing the barrels involving wooden frameworks or metal ties attached to the walls of the car

²⁰⁵ Bell, *Nautical Instructor*, 51.

²⁰⁶ Both river steamboats and ocean-going vessels also carried "deck cargo," stowage of which is not discussed here.

²⁰⁷ Hankerson, *Cooperage Handbook*, 153-167.

²⁰⁸ *Ibid.*, 154.

²⁰⁹ *Ibid.*, 154-155, figures 83-85.

²¹⁰ *Ibid.*, 156, figure 87.

and wrapped around parts of the load. The floor and second layers are secured separately.²¹¹

Beyond issues of safety of the vessel and protection of the cargo, those responsible for overseeing stowage on steamboats had to consider the need for accessibility. Steamboats made frequent stops taking on and discharging passengers and freight whose destinations could be anywhere along the steamboat's route. Once its destination was reached, a given shipment of goods had to be accessible with minimal shifting of other cargo. Without skilled and efficient management of cargo handling, much time could be lost and the likelihood of damage to cargo would be increased.

An examination of the systems of cargo stowage practiced in nineteenth-century sailing ships and in twentieth-century railroad box cars provides a starting point for a study of stowage in early river steamboats.

THE END OF THE AGE OF BARRELS

It is somewhat ironic that a precipitating factor in the demise of hand cooperage in the United States was a sharp increase in demand for barrels by rapidly growing industries. In particular, the petroleum industry after 1860 created a constant shortage of barrels; to increase production, large mechanized coopering operations were set up in oil-producing regions.²¹² In these great barrel factories, ingenious machines operated by workers without skill or training as coopers took over more and more steps in the barrel-

²¹¹ *Ibid.*, 156-164.

²¹² Coyne, *Cooperage Industry*, 18-20.

making process from hand coopers. Though the products were at first inferior to handcrafted barrels, gradual improvements to machinery and innovations such as linings and tongue-in-groove stave joins overcame the deficiencies of machine-made barrels. Though Coyne could still call barrels “the king of packages” well into the twentieth century,²¹³ the old-fashioned hand cooper had long been largely obsolete outside the specialty wine, beer, and whisky trades.

Not even quality machine cooperage, however, could prevent the barrel’s ultimate fall from its ancient position as the pre-eminent shipping container. Just as the handcrafted wares of white coopers were slowly but surely replaced by mass-produced tin buckets, washtubs, and the like, so did convenient and inexpensive bags of fabric and paper replace barrels for powdered and granular products, while steel and plastic drums replaced tight barrels for most liquids.²¹⁴ The new types of packaging were adapted to advances in cargo handling and transportation technologies. Fork-lifts, conveyor belts, and other powered handling equipment favored rectangular containers at the expense of rollable barrels.²¹⁵ Not only could boxed goods be loaded more efficiently, they fit better than round barrels into rectangular box cars and, later, semi-truck trailers. The barrel’s advantages of cost-effectiveness and handling ease had been lost.

At sea, metal tanks increasingly replaced casks for water storage through the nineteenth century.²¹⁶ When refrigeration was introduced aboard ships around 1870,

²¹³ *Ibid.*, Title of Chapter VI, 33.

²¹⁴ Twede, “Cask Age,” 261.

²¹⁵ *Ibid.*

²¹⁶ Kilby, *Cooper and His Trade*, 156.

mariners' reliance on barrels of salted meats to sustain them during long sea voyages began to diminish.²¹⁷

A final factor in the fall of the barrel was the trend, begun in the late nineteenth century, toward consumer packaging for retail sales. Rather than receiving bulk quantities of goods in barrels and measuring out individual sales, modern shopkeepers could hand the customer a readymade box of crackers or a sack of flour. There was no need for reaching into the bottom of the pickle barrel when a neat jar of pickles sat waiting on the shelf.

Remembering and Appreciating the Humble Barrel

At the dawn of the twenty-first century, the once essential and ubiquitous barrel has become for most people little more than set-dressing for period films and country-style décor. Few are aware of how much most people relied on them in ordinary life and in great adventures of history. The barrel's contribution is even more remarkable when one considers the dazzling variety of containers that have replaced barrels and other casks in our lives. Consider the plethora of boxes and cartons, many lined with paper or plastic; the aluminum and steel cans; the glass and plastic jars, bottles, and tubs; the bags made of paper, plastic, and fabric; and the shrink-wrapped packages in which we purchase consumer products once delivered to the general store in barrels.

Delicate objects that once might have been shipped in tight barrels packed with sawdust or cornmeal now travel in specialized cartons of fiberboard, plastic, or metal,

²¹⁷ Ibid, 153.

and padded with shaped Styrofoam inserts. Commodities that once traveled in large casks now fill modern bulk containers that run the gamut from steel drums to wooden and plastic crates to railroad tank cars and tanker ships. As Twede observed:

Barrels deserve to be remembered for the important roles that they have played in history.... They appear in most of history's most colourful scenes. But theirs is a supporting role, humbly—almost invisibly—serving commerce, trade and markets. And then just as quietly they exit the stage.²¹⁸

²¹⁸ Twede, "Cask Age," 261.

CHAPTER IV

SUBSISTING THE U.S. ARMY

Food must take first place as a munition of war.²¹⁹
The great objects are, first, and mainly, to sustain the health and
spirit of the troops; and the next, to do it with the least possible
expense.²²⁰

INTRODUCTION

This chapter contains three major sections. The first describes how and why the system under which Fort Towson was supplied in 1838 came into being. Beginning with George Washington in the Revolutionary War, it highlights the organizational challenges involved and the injurious consequences for both efficiency and morale when the system proved inadequate. The second section explains the development of the ration itself—what items made up the ration, why they were included—then discusses feeding the Army at the garrison level. The final section is concerned with the importance of barrels in keeping the provisions fit to eat—or not.

²¹⁹ Prescott, *Survey of Rationing and Subsistence*, Preface, 4 (hereafter cited as Prescott).

²²⁰ John C. Calhoun, Secretary of War, Report to Congress, December 15, 1818. Barriger, *Legislative History of the Subsistence Department*, 67 (hereafter cited as Barriger).

LEGISLATIVE AND ADMINISTRATIVE HISTORY OF U.S. ARMY SUBSISTENCE

The Revolutionary War Period

When George Washington took command of the colonial militias assembled at Cambridge, Massachusetts, in July 1775, one of his first concerns was reorganizing the way his soldiers were fed. At that time, each militia was supplied by commissaries and committees from individual colonies, towns, and important places. In his first report to Congress on the status of his forces, Washington asked that body to consider appointing a Commissary General to oversee the subsistence of the Army, thereby avoiding the “vital and inherent principle of delay, incompatible with military service...[and] the inconvenience which must unavoidably ensue from a dependence on a number of persons for supplies.”²²¹ Washington knew the value of a centralized military organization responsible for procurement and issue of subsistence.

Washington had been favorably impressed by Joseph Trumbull’s efficiency in supplying the Connecticut militia, and recommended him to Congress for the post of Commissary General. Trumbull was a Harvard graduate with years of mercantile

²²¹ General George Washington to the Continental Congress, July 10, 1777, quoted in Barriger, 6.

experience in his family's business,²²² and he was appointed Commissary General of Stores and Provisions of the Army of the United Colonies on July 19, 1775.²²³

Trumbull faced enormous difficulties of procurement, transportation, and erratic communications inherent in supplying a wartime army spread over a wide area, much of it wilderness. He proceeded to institute "a plan by which the Army, during his continuance in office, was amply supplied, with much economy, and to the general satisfaction."²²⁴ His tenure was not without problems, however. When serious food shortages occurred among troops in Canada, a Congressional investigation blamed several employees of the Subsistence Department for "either a want of ability or integrity in discharging their trust."²²⁵ These persons used the system for their own benefit: "regardless of the general good [they] are raising the prices of the articles they purchase by bidding upon each other, under an idea of receiving commissions or compensations proportioned to the sums they expend."²²⁶ The presence or absence of ability and integrity among administrators and suppliers is a recurring theme in the history of Army subsistence.

²²² Victor L. Johnson. *The Administration of the American Commissariat during the Revolutionary War*, Philadelphia: University of Pennsylvania, 1941, 28, quoted in Gwin, *Food Procurement for the Armed Forces*, 41 (hereafter quoted as Gwin).

²²³ At about the same time, another Commissary General was appointed for the New York Department under Major-General Philip Schuyler. A deputy Commissary General was appointed for the Army of the United Colonies in Canada in March 1776 and one for the troops in Virginia a month later. Barriger, 7.

²²⁴ Richard Henry Lee, Josiah Bartlett, Oliver Ellsworth and Samuel Adams, Report to Congress regarding the services of Trumbull as Commissary General, March 31, 1799. Barriger, 19, note.

²²⁵ Lewis Morris, Abraham Clark and Jonathan B. Smith, Report to Congress regarding the conduct of the Commissaries, April 14, 1777. Barriger, 9.

²²⁶ Barriger, 10.

In response to the problems, in June 1777, Congress issued extensive regulations for the Subsistence Department. The new rules called for two Commissaries General, one for purchases and one for issues; prescribed in minute detail the duties of the two branches; and explicitly placed the Commissaries and their deputies and assistants under the jurisdiction of Military Law.²²⁷

Despite the thoroughness of this regulation, it contained a fatal flaw that lost Washington the services of the man on whose experience and efficiency he had relied. Appointed Commissary General of Purchases on June 18, 1777, Trumbull resigned a month later. He strongly objected to having the appointment of his deputies in the hands of Congress, and that he, as head of the department, lacked authority to discipline or remove unsatisfactory individuals.²²⁸ The central issue was the disruption of the chain of command and, thus, the chain of responsibility and accountability. A faulty and ambiguous chain of command was at the heart of the subsistence problems that would plague the Army for the next four decades.²²⁹

Between 1777 and the end of the war, food shortages caused serious morale and tactical problems for the American Army, exemplified by the legendary privations suffered at Valley Forge. After years of Congressional tinkering with the system, supervision of subsistence was removed from the Board of War and eventually handed

²²⁷ Ibid., 10-18.

²²⁸ Trumbull, letter of resignation, July 19, 1777, Barriger, 19, note.

²²⁹ Following his resignation from the Subsistence Department, Trumbull served as a commissioner of the Board of War until April 1778 when he resigned due to ill health. He died three months later. Ibid.

to the Finance (later Treasury) Department in July 1781.²³⁰ Some improvement resulted, but within a few weeks, British forces had surrendered to Washington at Yorktown, Virginia. The war was essentially over, and, with general demobilization, legislative interest in the Army's problems quickly faded.

The Interim Period

For most of the period between 1781 and 1798, the Treasury Department was in charge of providing all supplies, including food, to the Army.²³¹ This was a time of relative peace and a small military establishment. Army troop strength was sometimes as low as a few hundred officers and men. Under the Treasury Department system, the Secretary of War estimated the needs for all supplies and equipment for the Army and Navy and reported his estimates to Congress.²³² The Commissioners of the Treasury then contracted with individuals to deliver rations and other supplies to specific posts. Significantly, the contractors or their agents were generally responsible for storing the provisions and issuing rations daily to small units within garrisons. This arrangement was known as the Contract System, and it remained in effect under different names for some 37 years. In January 1794, President Washington, mindful of the Revolutionary War experience, strongly recommended the appointment of a Purveyor of Public Supplies, in effect a fully empowered Commissary General, under the War Department.

²³⁰ Gwin, 47-49.

²³¹ Gwin, 57-58. When the War Department was created in 1789, the Secretary of War was authorized to purchase its own subsistence stores. However, procurement was returned to the Treasury Department in 1792.

²³² Barriger, 26.

Unfortunately for the next generation of soldiers, Congress declined to authorize appointment of such a person.²³³

Under the threat of hostilities between France and the United States in 1798, Congress returned control of procuring supplies to the War Department.²³⁴ The system of procurement and delivery remained essentially the same. Though a land war with France did not materialize, the services continued to write their own contracts until 1802.

In 1802, Congress established the office of Civilian Military Agent. There were three agents operating in different regions of the country. They were contracted to “purchase, receive, and forward to their proper destination, all military stores and other articles for the troops in their respective departments [regions], and all goods and annuities for the Indians....”²³⁵ The Military Agency system was inefficient even in peacetime. Gwin makes the following observation on the Military Agent plan:

The scant records concerning this procurement plan indicate that the civilian phase was carried too far into the military organization. If supplies had been procured and officially turned over to the military for their own internal distribution, the problem might have been greatly simplified.²³⁶

Nevertheless, the system remained in effect for ten years until tensions between the United States and Great Britain once again turned the attention of Congress to the needs of the military.

²³³ Ibid., 30.

²³⁴ Ibid., 32. In 1798, Congress also created the Navy Department and gave it the power to procure its own supplies of all types.

²³⁵ An act fixing the Military Peace Establishment of the United States, approved March 16, 1802, Barriger, 33.

²³⁶ Gwin, 59.

Contract Supply Fails the Test of War

In March 1812, under threat of imminent war, Congress once again reorganized the system for procuring and distributing supplies. A Purchasing Department was created, headed by a Commissary General of Purchases.²³⁷ What the Army needed, but did not have, was a well-established peacetime system that could be transitioned to meet wartime conditions, and personnel with experience in large-scale procurement to administer the system.²³⁸ “Military management” notwithstanding, the system of Contract Supply remained essentially unchanged—with frequently disastrous consequences. Within a few months of the declaration of war, instances of failures in the system were littering official reports from the field. In the fall of 1812, one general wrote, “Do not rely on the contractor for provisions. He has no salt meat, and only damaged flour...,” and another officer reported that “We are literally starving on this end of the line for bread.”²³⁹

For a year and a half, Congress tried unsuccessfully to fix the system.²⁴⁰ In November 1814, Secretary of War James Monroe was directed to report on the efficacy of the Contract System and to suggest possible alternative modes of supply. Secretary Monroe solicited advice from three serving officers with field command experience. They were General Winfield Scott, General Edmund P. Gaines, and Colonel John Roger

²³⁷ An act to establish a Quartermaster Department and for other purposes, March 28, 1812, Barriger, 34-35.

²³⁸ Gwin, 6-7.

²³⁹ Brigadier General Alexander Smyth, from near Buffalo to the Secretary of War, October 20, 1812 and Colonel W.H. Winder to Brigadier General Smyth, from Fort Niagara, November 7, 1812, quoted in Barriger, 36.

²⁴⁰ Barriger, 38-40.

Fenwick. The officers' letters, which Monroe included in his report, provided a vivid picture of the Contract System in practice.²⁴¹ The following paragraphs summarize their main points.

Under the Contract System, the War Department entered into contracts with individuals to supply rations to troops in a given district. Once contracts were awarded, the process was in civilian hands until the daily issue of rations. The primary contractor was free to bid off portions of the contract to subcontractors, who in turn might subcontract further. Only the primary contractor was known by and accountable to the War Department.

The individuals actually providing the rations generally operated with extremely slim profit margins, and might keep on hand barely enough food to issue a single day's rations. Even if the rations were well below the quality stipulated in the contract, troops had little choice but to accept them. When quantities were insufficient, they drew short rations. Frequently, the "small parts" of the ration—vinegar, soap, and candles—would not be issued at all. The difficulty was most acute when the troops were on a forced march or actually confronting the enemy, and needed to draw rations for a week or more at a time. In such urgent circumstances, required inspections of the issues were cursory at best, and the contractor or his agent could take advantage of the situation to pass off poor and damaged goods. Should prices rise, or transportation costs be increased by movement of troops to a more remote area, the contractor's interests were served by

²⁴¹ James Monroe, Acting Secretary of War, Report to the House of Representatives, December 23, 1814, Barriger, 41-45.

simply not delivering the rations. He could cite lack of “reasonable notice” as an excuse. Even in garrison, the rations were sometimes so badly damaged that food had to be condemned, and troops might go all day without provisions.

The effect of bad and insufficient food on health and readiness of the troops was pronounced. Malnutrition left men prone to disease and unfit for duty; bad provisions irregularly supplied were blamed for more deaths than enemy fire. Constant privations took a toll on morale, causing serious discontent and unrest among the troops.

Few remedies were available to commanders. Civilian contractors did not come under the jurisdiction of Military Law. A contractor could be brought to account for failed deliveries or for substandard or ruined goods only by civil action in a civilian court. Amid the disruptions of war, such courts were rarely available to commanders in the field where abuses frequently occurred. This circumstance put the contractor, and, of course, the subcontractors and sub-subcontractors, beyond the control of commanding officers, whose orders and threats the contractors could ignore with impunity. As Colonel Fenwick wrote:

Contracts are never fulfilled to the letter, and never will be, so long as avarice exists; and where so many opportunities present themselves to the military contractor for imposition and fraud, we must expect he will avail himself of them...[and] every expedient is resorted to to increase his profits.²⁴²

In the event of contract failure, the commander did have the authority to appoint a special agent to find and purchase rations. A purchasing officer had to be pulled from his regular duties for the assignment. Acting on short notice and generally near the

²⁴² Fenwick to Monroe, December 23, 1814, quoted in Barriger, 44.

enemy, he would have to pay premium prices to ensure delivery, considerably increasing the cost to the public (e.g., the taxpayer).²⁴³

To these practical deficiencies of the Contract System, Secretary Monroe's informants added the serious threat to the security of military operations. Contractors and their agents, deputies, and subcontractors would know the troop strength of the units they were expected to supply. If the units were moved to a new location, the contractors had to be notified. Thus, contractors and their associates were in possession of military intelligence of great value to the enemy, and could easily pass the information along. If their sympathies lay with the British, they were in an excellent position to sabotage the United States war effort by withholding supplies at critical times and locations. Suspected traitors, like bad contractors, were outside the jurisdiction of Military Law. Within United States territory, they could be tried only in civilian courts. (In foreign territory, commanders did have the authority to summarily imprison suspected traitors.)

Monroe, Scott, Gaines, and Fenwick all endorsed the use of Commissaries for subsisting the Army. Commissaries, they advised, should be selected from among commissioned officers already known for their integrity, ability, and patriotism. Having

²⁴³ In one incident in the winter of 1813-1814, the contractors had so failed to deliver sufficient provisions that the troops commanded by Major-General William Henry Harrison were nearly starving, including those guarding captured British ships at Put-in-Bay on Lake Erie. An officer was appointed Special Commissary to make emergency purchases. In spite of their own failure, the contractors later officially claimed that General Harrison's orders were motivated by hostility toward themselves and a desire for personal financial gain. Harrison in turn requested a Congressional inquiry into their allegations. In his letter to Congress in December 1815, he defended his orders to purchase provisions. He asked whether he should have evacuated the posts, thereby permitting the enemy "to retake the ships in harbor at Put-in-Bay, which would have enabled them again to contend for superiority on the lakes, for fear I should deprive Mr. Orr of the opportunity of making three hundred thousand dollars instead of one hundred thousand?" General Harrison was completely exonerated on all counts. Barriger, 39-40.

procurement as their regular duty, they could take the time needed to find good prices. They would be empowered to make punctual payment for supplies, thereby improving the quality and reliability of the rations while reducing the cost. Commanders would have far fewer distractions from their other duties than occurred when they had to deal with the frequent contractor failures. Commissaries would be fully subject to Military Law for punishment in the event of neglect of duty or fraudulent practices, though it was expected that the commissary officers would “be actuated by feeling, honor and the fear of disgrace.”²⁴⁴

Such unequivocal testimony to the gross inadequacy of the Contract System finally resulted in action. In January 1815, “A bill making provision for subsisting the Army of the United States, by authorizing the appointment of Commissaries of Subsistence” was put before lawmakers.²⁴⁵ This bill included many of the needed reforms. By mid-February, it had been passed by the House of Representatives and approved by the Senate. Within a day or two of its becoming law, however, news of the signing of the Treaty of Ghent reached Washington; the war was over. Once again, interest in military issues faded quickly, and the bill was allowed to die when Congress adjourned in March.²⁴⁶

Congressional inaction and apathy toward the peacetime Army allowed the Contract System to continue. Within two years, however, the Army was called to

²⁴⁴ Fenwick to Monroe, December 23, 1814, quoted in Barriger, 44.

²⁴⁵ Barriger, 45.

²⁴⁶ *Ibid.*, 45-46.

Georgia's frontier with Spanish Florida in response to hostile action by the Seminole Indians. Very soon thereafter, the old pattern reasserted itself: contractors failed to deliver goods contracted for, the health and morale of soldiers suffered, and valuable time was lost as manpower and other resources were diverted from the pursuit of military objectives in order to meet basic subsistence needs. And, of course, the cost to the public increased.²⁴⁷

Major-General Andrew Jackson was in command of the Seminole Campaign, and reported frequently throughout 1817 on the subsistence crises and the herculean efforts involved in getting food and transporting it to where it was needed. In January 1818, he took decisive action when he tasked the Quartermaster General, Colonel George Gibson, with purchasing rations for the Army in New Orleans and bringing them by ship to Florida.²⁴⁸ This was accomplished by March 1818, and proved to be a turning-point in the campaign. As Barriger describes the situation:

General Jackson having improvised a commissariat, and through its instrumentality received a supply of rations, had virtually freed his army from subordination to its means of subsistence, and was thus enabled (as the commander of every army in the field should be) to give his unrestrained attention to matters of discipline and strategy. Accordingly, on the 26th of March, he broke camp and entered upon a vigorous campaign....²⁴⁹

Within a few weeks, the Seminole Uprising was over.

²⁴⁷ Ibid., 48-53.

²⁴⁸ Jackson to Calhoun, March 25, 1818, Barriger, 53-56.

²⁴⁹ Barriger, 56.

Congress Acts: The Commissariat of Subsistence

Congress finally abolished the disastrous Contract System with the passage of “An Act to Regulate the Staff of the Army,” signed by President James Monroe on April 11, 1818.²⁵⁰ This sweeping reorganization of the Army’s command structure contained five sections relating to the mode of subsisting the Army.²⁵¹ Section Six established the position of Commissary General of Subsistence to be appointed by the President, and Assistant Commissaries to be selected from among junior officers. The Subsistence Department would be responsible for both purchasing and issuing rations. Section Seven stipulated that supplies would be “purchased by contract to be made by the Commissary General, on public notice to be delivered on inspection, *in bulk*, and at such places as shall be stipulated” (italics added).²⁵² The authority of the President to make changes in the parts and amounts of rations was confirmed in Section Eight. Section Nine forbade the Commissary General or any of his Assistants from having commercial interests in any of the articles composing the ration. They were not to realize any personal gain from the conduct of their duties beyond that allowed by law. And they were all subject to martial law. Section Ten allowed for business-related letters to and from the Subsistence Department to be free from postage, and set the term for Sections Six through Ten at five years from passage of the act.

²⁵⁰ Ibid., 63.

²⁵¹ Ibid., 64.

²⁵² Ibid.

In a report to the House of Representatives concerning the reorganization of the Army,²⁵³ Secretary of War John C. Calhoun observed that “a well-organized commissariat, whose ordinary supplies are obtained by contract, founded on public notice, possesses (besides those peculiar to itself) all of the advantages fairly attributable to the system of issuing rations by contract.”²⁵⁴ The commissariat would be less susceptible to fraud, and provisions could be bought at better prices. Under the old contract system “of issuing the ration by contract...merchants and capitalists [were] deterred from bidding, by the hazard of issuing the ration; and thus the sphere of competition [was] contracted, and the contracts for supplying the Army often thrown into the hands of adventurers.”²⁵⁵ An open bidding process guarded against fraud, while delivery in bulk gave the Army control of food distribution, increasing efficiency and reducing risks to military security.

Colonel George Gibson, later Major-General, who had demonstrated his administrative skill during the hostilities in Florida, was appointed to head the new department in April 1818, but the new system did not go into full operation until June 1, 1819, allowing a year for organizing the Commissariat and phasing out the old system.²⁵⁶ The “Regulations of the Subsistence Department” were presented to Congress on December 15 appended to Calhoun’s report to the House of Representatives.

²⁵³ Calhoun, Report to the House of Representatives regarding Army staff organization, December 15, 1818, Barriger, 67-70.

²⁵⁴ *Ibid.*, 70.

²⁵⁵ *Ibid.*

²⁵⁶ Barriger, 66.

Much of the credit for the successful operation of the Subsistence Department is owed to the Assistant Commissaries serving at all major and most minor posts. Selected from among the junior officers at a post, they oversaw all aspects of receiving, maintaining, and issuing subsistence stores. They were “held accountable for the safekeeping and storage of all provisions entrusted to their charge,” and were financially liable for any losses determined to be caused by their own negligence.²⁵⁷ The Assistant Commissaries frequently examined the goods in the storehouse to keep track of stores on hand, to determine their condition, and to prevent damage and waste.

Army regulations reiterated and expanded upon the Subsistence Department regulations. The Assistant Commissaries were responsible for procuring those items of the ration not included in the annual contract, either by purchasing directly from merchants or by contracting locally for their supply. In the event of failure of the contract, they were authorized to purchase the necessary provisions.²⁵⁸ The Assistant Commissaries supervised the issue or sale of provisions to military and other authorized personnel, and also issued Indian rations as circumstances required.²⁵⁹ They kept copious accounts and records relating to all their main duties and made regular reports to their commanding officers and to the Commissary General in Washington.

The Assistant Commissary worked closely with his counterpart in the Quartermaster Department. The Assistant Quartermaster was charged with providing

²⁵⁷ “Regulations of the Subsistence Department,” para. 6 and 7, Barriger, 73-74.

²⁵⁸ U.S. War Department, *General Regulations 1821*, 259, Article 72 “The Subsistence Department,” para. 9.

²⁵⁹ *Ibid.*, 260-261, paras. 13-17.

“good and sufficient storehouses” for the provisions and transportation from one post to another, as might be required.²⁶⁰ Both Assistants were obedient to orders from both departments,²⁶¹ and it was not unusual at smaller posts for both positions to be held by one officer. Assistant Commissaries earned an additional ten to twenty dollars per month beyond their base pay, depending on the size of the unit and whether or not they also performed the duties of Assistant Quartermaster.²⁶²

Under the old contract system, so long as the provisions were “edible and in [the] quantity required, regardless of quality and size, the inspector was forced to accept it and approve the contractor’s voucher for pay.”²⁶³ The new regulations explicitly stated that subsistence stores were not to be received from the contractor “until duly inspected according to the terms of the contract.”²⁶⁴ If the initial inspection determined that all or part of the goods did not meet the quality specified in the contract, the substandard items would not be accepted. A Board of Survey consisting of at least two officers was then convened to confirm the Assistant Commissary’s finding.²⁶⁵ The contractor received payment only for goods deemed acceptable and officially received.

²⁶⁰ *Ibid.*, 258-259, paras. 4, 8.

²⁶¹ “An act to reduce and fix the military peace establishment of the United States,” approved March 2, 1822, section 8,” Cross, *Military Laws*, 214.

²⁶² U.S. War Department, *General Regulations 1821*, 266-267, Article 72 “The Subsistence Department,” paras. 43-45.

²⁶³ Gwin, 204.

²⁶⁴ “Regulations of the Subsistence Department,” para. 2, Barriger, 73.

²⁶⁵ *Ibid.*, 74, para. 7.

The Commissariat of Subsistence

The years following the Staff Act of 1818 were without major conflict, and the size of the Army was reduced. Although relatively small, this new peacetime Army was spread over increasingly vast territories as the frontier moved westward. The efficiency of Gibson's administration was such that, as early as December 1819, Secretary of War Calhoun could report to Congress that "the expense of the Army has been greatly reduced, while, at the same time, the various articles supplied have been improved in quality, and in the punctuality with which they have been issued."²⁶⁶ The Commissariat continued to perform well. In 1833, Secretary of War Lewis Cass wrote of George Gibson:

The Army is now well and promptly supplied and the faithful officer at the head of the Subsistence Department has established a system of purchasing, of issuing, and of responsibility, which, while it insures this result, guards the public interest against loss and imposition as far as a business necessarily so extended permits.²⁶⁷

After several extensions, supply by Commissariat was made permanent in 1835.²⁶⁸ The Commissariat of Subsistence was responsible for provisioning the Army until 1912, when the departments of the Quartermaster General, the Commissary General, and the Paymaster General were consolidated into the new Quartermaster Corps.²⁶⁹

²⁶⁶ Calhoun, Report to House of Representatives regarding a plan for the reduction of the Army, December 12, 1820, Barriger, 79.

²⁶⁷ Cass to Congress, annual report of 1833, quoted in Barriger, 87.

²⁶⁸ Barriger, 88.

²⁶⁹ Gwin, 74.

THE RATION²⁷⁰

A “ration” is the amount of provisions required for one man for one day. The items included in the ration and the amount of each allowed were set by Congress until 1818, when authority to do so was given to the President. Daily allowances for individuals were translated into bulk measures for supply purposes. For example, if the bread/flour ration was 18 oz (0.51 kg) per day, 112.5 lb (51 kg) of bread/flour would be required to feed 100 men for a day. For a month of daily bread for those same men, 3,375 lb (1530.9 kg) would be authorized. Some items, such as salt and beans, were calculated as so much for every 100 rations.

Rations were considered part of a soldier’s pay. One daily ration was provided for “every non-commissioned officer, private, and musician.”²⁷¹ Soldiers serving on the frontier in the late eighteenth and early nineteenth centuries were allowed an extra few ounces of meat, and an additional half a gill of rum.²⁷² Certain groups of men whose work was particularly arduous—among them blacksmiths, armorers, and laborers—were also authorized increased rations.²⁷³ In 1802, laundresses, hospital matrons, and nurses were authorized to receive one ration each,²⁷⁴ and other civilian employees of the Army were also allowed subsistence.

²⁷⁰ Weights and measures in use during the period under discussion were not generally standardized, and it is doubtful that the ounces, pounds, and quarts in the historical documents are exactly comparable with those measures as used today. The metric equivalents provided here are based on current conversion tables and are not intended to suggest quantities any more precise than the original units would imply.

²⁷¹ Prescott, II-7.

²⁷² Prescott, II-4,8.

²⁷³ Ibid., II-35, III-29.

²⁷⁴ Ibid., II-10.

From Revolutionary War days, soldiers could be paid in money for rations, or parts thereof, that were authorized but not drawn, as when their duties took them away from regular posts. The amount paid in lieu of a whole ration was 10/90ths of a dollar in 1777 and had risen to \$0.75 by 1841.²⁷⁵

It was not until after the Civil War that serious efforts were made to develop special rations for combat, emergencies, or travel situations.²⁷⁶ Before those innovations, the basic ration remained the same whether the units were in garrison or on the march, though food for travel could be prepared in an easily portable form suitable for the circumstances (the flour/bread ration, for example, being issued as hard bread).

The Ration as Legislated

Compared with the Army fare of the first half of the nineteenth century, the ration established by the Continental Congress in 1775 was marvelous in its variety.²⁷⁷ It not only included the staples of American cooking—meat (beef, pork, or fish) and bread (or flour)—it also provided for peas or beans, rice or cornmeal, butter or lard, and vegetables (onions, potatoes, and turnips). A pint of milk per man per day was allowed, to be replaced by an increased allowance of meat in winter. Soldiers could enjoy spruce beer or cider, but if they were not available, a pleasant and wholesome drink could be made from molasses and water. From these early times, the non-food consumables of candles (for guards) and soap were included in the ration items. Despite the intentions of

²⁷⁵ Ibid., I-12, III-58.

²⁷⁶ Ibid., IV-24ff.

²⁷⁷ Ibid., I-4-6.

Congress, however, such generous and varied fare was seldom available to the Revolutionary War troops. Shortages of different items were common. In order to help make equitable issues of limited food supplies, issuing officers were provided with detailed lists of substitutions. For example, a single ration could consist of “one pound of bread, or flour, twelve ounces of pork and six ounces of butter,” or “five pounds of bread or flour,” or “one gallon and a half of peas.”²⁷⁸

By 1785, the ration had become much more limited, or perhaps merely more realistic. Meat, bread, candles, and soap were still included. Beer and cider were replaced by one “gill” of rum (a gill, pronounced “jill,” being equivalent to $\frac{1}{4}$ pint or about 4 oz [118.3 ml] in today’s measure), and salt and vinegar were added.²⁷⁹ The ration saw little modification aside from adjustments to quantities allowed until after the establishment of the Commissariat of Subsistence in early 1800s.

Nutritional Wisdom of the Day

The Army has never lacked advice from medical professionals for keeping its soldiers healthy and fit for duty. Though not all the advice was heeded, these recommendations reflect the state of medical and nutritional knowledge of their day. As early as 1778, Dr. Benjamin Rush, a prominent physician and signer of the Declaration of Independence, wrote a pamphlet on “Directions for Preserving the Health of Soldiers.”²⁸⁰ In his discussion of diet, he stated that it should consist mainly of

²⁷⁸ Ibid., I-8-9.

²⁷⁹ Ibid., I-20-21.

²⁸⁰ Excerpted in Prescott, I-22-24.

vegetables—well cooked. (It should be remembered that “vegetables” referred at that time to a variety of plant-foods such as legumes and rice in addition to potatoes, onions, leafy greens, and the like.) He was also concerned with the quality of food used. Not only was damaged flour to be avoided, he warned against rendering good flour unwholesome “by an error in making it into bread.”²⁸¹ He suggested, instead of flour, issuing whole wheat grain, husked, to be well-boiled and eaten with a spoon, as nourished Roman troops in Gaul. It would be very tasty with a little sugar or molasses added, he noted.

Rush was an early opponent of the daily alcohol ration and wrote eloquently on the detrimental effects of the “drinking of spirituous liquors” on the health and discipline of the Army. He reluctantly conceded that in two circumstances only, that of soldiers on sentry duty or on fatigue duty in rainy weather, soldiers might benefit from a dilution of three or four parts of water to one of rum. His views were not shared by most Americans, however, and the regular issue of the spirit ration would continue for decades.

A generation later in 1808, Dr. Edward Cutbush, a physician in the United States Navy, wrote *Observations on the Means of Preserving the Health of Soldiers and Sailors*. In the chapter “On the Subsistence of Troops,”²⁸² he discussed the importance of water as “the principle drink of soldiers.” Good water was “that which is lively and agreeable, transparent and without odour, which boils beans or peas readily and

²⁸¹ Ibid., I-23.

²⁸² Excerpted in Prescott, II. 48-64.

dissolves soap without curdling.”²⁸³ He instructed the reader on finding sources of good water, offered methods for filtering and purifying muddy or stagnant water, and called for boiling water from marshy situations “to kill the animalcula(sic) which, it contains.”²⁸⁴ On the matter of spirits, Cutbush opposed the issue of undiluted whisky in garrisons. Instead, he promoted the use of cider or, especially, beer. He suggested that garrisons could brew their own beer and recommended using an extract of malt and hops with a preserved yeast. Similarly, he suggested and gave instructions for the production of an easily transportable citrus juice concentrate, for the benefit of soldiers on the frontier where such fruit was rarely available.²⁸⁵

Cutbush considered the ration in 1808 to be defective in that it included no vegetables. He advocated reducing the meat ration in hot weather and climates, and issuing vegetables instead. “A certain portion of cabbages, potatoes, onions, turnips, beans, peas or rice might be occasionally served out with fresh meat, and always [underline original] with salted beef or pork with great advantage on the score of health.”²⁸⁶ Adding vegetables to a good soup “gives an agreeable acidity which corrects that tendency to scurvy, which soldiers confined in garrisons are subject to; even celery tops... would make a grateful addition to soup.”²⁸⁷

²⁸³ Ibid., II-48.

²⁸⁴ Ibid., II-50.

²⁸⁵ The *General Regulations* of 1821 allowed among hospital stores one bottle of “lime juice,” certainly a concentrate, per 100 men per year. United States War Department, 291, “Standard Supply Table of Medicines...,” art. 73. Not until 1899 was fruit added to the official ration in the form of dried fruits, 2 ounces. General Order No. 78, A.G.O., April 21, 1899, Prescott, IV-42.

²⁸⁶ Prescott, II-61.

²⁸⁷ Ibid.

Establishing the Ration under the Commissariat

When Secretary of War Calhoun reported on the progress of the newly established Commissariat of Subsistence in 1818,²⁸⁸ he also addressed changes to the ration set in 1802. He considered the old ration to be “ample in quantity, but not of the quality best calculated to secure either health or economy.”²⁸⁹ Even the poorest Americans, he believed, were “accustomed to a plentiful mode of living,” and that “However well qualified for war in other respects, in the mere capacity of bearing privations we are inferior to most nations.”²⁹⁰ He went on to outline the changes that had been made to the ration. More vegetables (e.g., beans and peas) were now included, as was more fresh meat. Bacon and cornmeal could be substituted for pork and wheat flour in the South. He further announced that wherever possible, permanent posts were ordered to cultivate vegetable gardens.

Calhoun included with his report comments of Surgeon-General Joseph Lovell on the articles that should be included in the ration.²⁹¹ The articles should, according to Lovell, have high nutritive value and should retain their nutrients when simply and easily prepared, “as the soldier is, in general, his own cook.”²⁹² Lovell advised choosing articles that are easy to procure, of good quality, and that could be easily preserved in various climates. He was also concerned that the foods be adapted to the culinary habits of the soldiers before they enlisted. This consideration would be particularly important in

²⁸⁸ Calhoun, Report to House of Representatives, December 15, 1818, Prescott, III-4-13.

²⁸⁹ Ibid., III-5.

²⁹⁰ Ibid., III-5-6.

²⁹¹ Ibid., III-13-18.

²⁹² Ibid., III-13.

the event of rapid mobilization of militias. He cited recent experience (e.g., in the War of 1812 and the Seminole Campaign) of severe effects on citizen-soldiers suddenly exposed to the “hardships and privations of the soldier,” not the least of which being an unfamiliar diet.²⁹³

Elaborating on the types of ration capable of being preserved, Lovell reminded readers that wheat flour was highly susceptible to damage, and that noxious flour had contributed significantly to the high rates of illness and mortality among isolated garrisons in the War of 1812. He preferred to issue kiln-dried corn meal, if at all possible, for its keeping qualities, but if not, that flour should be baked into hard biscuits. It was a fact “well known to many valetudinarians, and most physicians, that hard bread or soft bread toasted is much more easily digested and affords more nutriment than any other form.”²⁹⁴ Similarly, Lovell preferred bacon over salted beef or pork, as an article less likely to become spoiled, especially in the southern climates. Bacon was also more familiar to soldiers from southern regions. He believed that fresh meat should be issued regularly. The best vegetables to include in the ration, in Lovell’s view, were peas, beans, and rice. These items should replace part of the meat ration and would “not only promote the health and comfort of the soldier, by approaching nearer to his accustomed food, but by enabling him to introduce frequent changes in his mode of preparing it.”²⁹⁵

²⁹³ Ibid., III-18.

²⁹⁴ Ibid., III-15.

²⁹⁵ Ibid., III-16.

Lovell repeated Cutbush's concerns regarding the negative effects of the spirit ration. He suggested substituting beer that soldiers could brew themselves or a drink made from molasses and water. He also pointed out that most people were used to having spices and condiments in their diet. He considered pickles especially valuable, not only as an accustomed food choice but for the vegetable acid, i.e., vinegar, that made them "a pleasant and healthy stimulant to the stomach."²⁹⁶ He recommended that enough vinegar should be issued so that cabbages, beets, cucumbers, etc. could be made into a regular supply of pickles.

The Ration in 1837

The ration changed little between 1818 and the Civil War. The most significant change was elimination of the whisky ration in 1832 and its replacement with coffee and sugar. According to the *General Regulations* of 1835,²⁹⁷ the ration consisted of:

Per man:

1¼ lb (0.57 kg) fresh or salt beef, or ¾ lb (0.34 kg) salt pork or bacon
18 oz (0.51 kg) bread or flour, or 12 oz (0.34 kg) hard bread, or 1¼ lb (0.57 kg) of corn meal

Per 100 rations:

8 qt (5.57 L) peas or beans, or 10 lb (4.54 kg) rice
4 lb (1.81 kg) coffee
8 lb (3.63 kg) sugar
2 qt (1.89 L) salt
4 qt (3.78 L) vinegar
1½ lb (0.68 kg) candles
4 lb (1.81 kg) soap

²⁹⁶ Ibid., III-17.

²⁹⁷ United States War Department, art. 47, para.20.

Salt pork, flour, beans, vinegar, salt, candles, and soap were supplied by civilian contractors and delivered once or twice a year. Other items were procured locally by the Assistant Commissaries. Beyond the official ration, soldiers in frontier posts had other opportunities to add variety and nutrition to their diets.

The Sutler's Store

The sutler's store was the ancestor of today's post exchanges: a well-stocked general store that offered necessities, comforts, and luxuries not issued by the Army. Appointment as sutler to an Army post granted a merchant a monopoly for selling to that post community. Sutlers carried a range of articles from razors and playing cards to sewing notions, fishing line, and musical instruments. Edible merchandise might include spices and teas, mustard and other condiments, fresh and dried fruits, molasses, crackers, candies, eggs, cheese, and many more tempting foodstuffs.²⁹⁸ Soldiers could make individual purchases or club together with their mess-mates to supplement their issued provisions.

The sutler was governed by the post Council of Administration.²⁹⁹ This body usually consisted of the four officers next in rank to the commanding officer. It was authorized to determine what the sutler should stock, to set his prices, to inspect the store and his books, and to ensure that debts owed the sutler by soldiers were paid.³⁰⁰ In return for his monopoly, the sutler was assessed a tariff not to exceed fifteen cents per month

²⁹⁸ Gamble, *Garrison Life*, 137-138.

²⁹⁹ U.S. War Department, *General Regulations 1835*, art. 32, para. 7.

³⁰⁰ *Ibid.*, para. 11.

for every soldier at the post.³⁰¹ These monies became the basis for the post fund, also administered by the Council of Administration. The fund's first priority was to provide temporary relief for widows and orphans of soldiers and for indigent or disabled veterans. Beyond that, it supported what might be termed quality-of-life improvements, such as a school for the post's children, a library, and a band.³⁰² To this day, profits from military exchanges finance recreational and community support activities for the armed forces.

Post Gardens

Perhaps the most significant and valuable sources of supplement to the ration were the company gardens cultivated at most Army posts. Orders to establish vegetable gardens were issued in 1818 to add nutrition and variety to the soldiers' diets while reducing the cost of provisioning distant posts.³⁰³ Grown with soldier-labor using seed and garden tools paid for by the post fund, the gardens were generally successful on both counts.

Other Sources

Hunting and fishing provided not only sport but also fresh meat for both officers' and soldiers' messes.³⁰⁴ Gardening and recreational hunting had the additional advantage of saving money. In order to encourage the "economical use of the ration," the Army

³⁰¹ Ibid., para. 6.

³⁰² Ibid., paras. 12, 16.

³⁰³ Calhoun, Report to House of Representatives, December 15, Barriger, 68.

³⁰⁴ Gamble, *Garrison Life*, 110,112.

allowed the savings accrued from such economies (except those related to baking bread, see below) to be placed in a company fund that would be “exclusively for the benefit of enlisted men.”³⁰⁵

FOOD IN GARRISON

“Mess” refers to the place soldiers eat, the act of eating together, and to the group of men who mess together. In his inspection tours of frontier forts between 1826 and 1845, Colonel George Croghan was especially attentive to the garrison messes, their cleanliness, and the quality of the cooking. He frequently mentions the post gardens. From Fort Snelling in 1838, he wrote that “the government ration is sufficient of itself, and to it may be added the abundant supply of vegetables at all times to be had from the gardens of the several companies.”³⁰⁶ “At some posts,” he wrote in 1842, “the fare is better than at others, but it is only that they have better gardens.”³⁰⁷ He observed that soldiers in garrisons generally ate better than their neighbors on the frontier and, indeed, “better by far than the laboring classes in any of our states are accustomed.”³⁰⁸ “If the general belief of the citizens about the several posts be received as correct,” he wrote from Fort Leavenworth in 1843, “they live rather too well.”³⁰⁹

³⁰⁵ U.S. War Department, *General Regulations 1835*, art. 32, paras. 31-33.

³⁰⁶ Croghan, *Army Life on the Western Frontier*, 66.

³⁰⁷ *Ibid.*, 67.

³⁰⁸ *Ibid.*

³⁰⁹ *Ibid.*

The Officers Mess

Rations were not issued to officers as they were to enlisted men. Officers received with their pay the cash equivalent of a certain number of rations, according to their rank: a lieutenant, for example, was paid his salary plus two rations, while a full colonel received pay plus six rations.³¹⁰ Officers were expected to purchase their own food off-post. An exception to this policy was granted for more remote posts, such as those established along the Red River, where outside sources of subsistence were frequently lacking. In those places, Assistant Commissaries were authorized to sell provisions to officers “for the subsistence of themselves and families [if dependents resided at the post] at the contract prices” plus transportation costs.³¹¹ It was to be “distinctly understood that this is an accommodation which must not be abused by drawing unnecessary supplies.”³¹² Single officers in the same regiment were encouraged to “form themselves into a mess, and live together as one family” for both social and economical benefits—“in which officers can live within their pay.”³¹³ In support of such arrangements, the government provided kitchens and fuel.

³¹⁰ “An act to raise, for a limited time, an additional military force, April 12, 1808,” sec. 4, Cross, *Military Laws*, 125. The provisions of this section were renewed by similar acts in 1815 (Cross, 183) and 1821 (Cross, 214).

³¹¹ U.S. War Department, *General Regulations 1835*, art. 47, para. 34.

³¹² *Ibid.*, para. 35.

³¹³ *Ibid.*, art. 9, para. 20.

Enlisted Messes

From the earliest days of the U.S. Army, the company has been the basic administrative unit.³¹⁴ It was also the basic social unit and, naturally, the basic mess unit.³¹⁵ Supplies were requisitioned by company commanders based on per capita allowances converted into bulk measures. The several squads of a company made up the individual messes. Privates of each squad took turns preparing meals for their squad. Full-time Army cooks did not appear until well after the Civil War.³¹⁶ Great stress was placed on cleanliness of the kitchen area and the washing and scouring of cooking utensils. Company officers were expected “frequently, during the day, to attend to the messing arrangements and economy of their respective companies” in addition to the daily kitchen inspections by the regimental officer of the day.³¹⁷

The bugle or drum call “roast beef” was the signal to draw provision (except at meal time when it signaled dinner).³¹⁸ Details of soldiers from the different companies in a regiment reported to the distribution point, where they were issued a four-day supply

³¹⁴ The size of an infantry company has varied considerably over time. It was set at three officers and fifty-one NCOs and enlisted men in 1821 (Cross, *Military Laws*, 213) and was augmented by the addition of one sergeant and thirty-eight privates in 1838 (261). Companies in a garrison, however, were not necessarily at full strength.

³¹⁵ Prescott, 7.

³¹⁶ U.S. War Department, *General Regulations 1835*, art. 9, para. 23. Centralized cooking facilities were introduced during the Civil War (Prescott, IV-8). These were manned by one private from each company, each soldier pulling a ten-day stretch of kitchen duty. Eventually, the Army’s School for Bakers and Cooks was established in 1905 (Prescott, V-3).

³¹⁷ U.S. War Department, *General Regulations 1835*, art. 9, para. 22.

³¹⁸ *Ibid.*, art. 18, para. 7.

of bread, salt, meat, and “the small parts” of the ration.³¹⁹ Once back in the company barracks, internal distribution was made to squads.

USES OF THE RATION

“Soup and bread,” proclaimed Army regulations, “are the great items of a soldier’s diet in every situation: to make them *well* is, therefore, an essential part of his instruction. Those great scourges of a camp life, the scurvy and diarrhea, more frequently result from a want of skill in cooking, than from the *badness* of the ration, or from any other cause whatever” (italics original).³²⁰

Bread

Neither soft bread nor hard bread was readily available in the frontier regions, as they were more difficult to transport without spoiling than flour. Troops were expected as much as possible to do their own baking, the money saved going into the post or regimental fund. Bake houses were important features of most frontier forts.³²¹ The Council of Administration directed the building, equipping, and supplying of the bakery and the hiring of a baker. Flour was generally sold to the bakery by the subsistence commissary and not issued to troops except already baked into loaves of bread. Some flour was made into the more compact and less perishable hard bread for use by soldiers

³¹⁹ The Army regulations of 1825 (art. 60, para. 725) required an officer from the regiment drawing supplies to be present to evaluate both the quantity and quality of the issues and, in case of deficiencies that were not immediately remedied, to direct his recourse to the chain of command. Perhaps because earlier provisioning woes were a recent memory, these officers were “expressly forbidden to redress themselves, or [their] regiment by resort to violence” (quoted in Prescott, III-54). The admonition regarding violence is not repeated in later editions.

³²⁰ U.S. War Department, *General Regulations 1821*, art. 27, para. 1.

³²¹ Gamble, *Garrison Life*, 112.

whose duty took them away from the fort. The bakery also sold bread to military families, civilian employees, and Indians. Priced at six to eight cents a loaf, these bread sales generated considerable profit for the benefit of the post fund.³²²

Good bread “ought not to be burnt, but baked to an equal brown colour. The crust ought not to be detached from the crum [sic]. On opening when fresh, one ought to smell a sweet and balsamic odor.”³²³ However delicious it smelled, bread fresh from the oven was considered potentially harmful. Troops were not to eat it in that state without first toasting it, a process which would render it “nearly as wholesome and nutritious as stale bread.”³²⁴

Soup

Meat, either fresh or salted, was usually boiled into a soup. It was sometimes roasted or baked, but was never to be fried.³²⁵ The regulations helpfully included a basic soup recipe:

To make soup, put into a vessel at the rate of five pints of water to a pound of fresh meat; apply a quick heat, to make it boil promptly; skim off the foam, and then moderate the fire; salt is then put in, according to the palate. Add the vegetables of the season one or two hours, and sliced bread some minutes before simmering is ended. When the broth is sensibly reduced in quantity, that is, after five or six hours’ cooking, the process will be complete.

If a part of the meat is to be withdrawn before the soup is fully made, the quantity of water will be proportionably less. Hard or dry vegetables [such as beans and rice] will be put in earlier than is above indicated.³²⁶

³²² Ibid., 113.

³²³ U.S. War Department, *General Regulations 1821*, art. 27, para. 6.

³²⁴ Ibid., para. 8.

³²⁵ Ibid., para. 9.

³²⁶ Ibid., paras. 11-12.

The typical Army mess served soup and bread for dinner, while slices of bread and boiled pork made a filling breakfast,³²⁷ with coffee as the preferred beverage.

The Small Parts of the Ration

Vinegar and salt were not only important for flavoring and preserving food. The procurement of good-quality vinegar was considered essential, especially in hot weather, for maintaining the troops' health.³²⁸ Vinegar was also useful for removing spots from scarlet cloth, and, mixed with fine brick dust, for cleaning brass mountings in the armory.³²⁹ The Assistant Commissary was authorized to issue small amounts of salt for the post's horses and cattle.³³⁰

Soap was used for personal hygiene as well as for other cleaning. Soldiers were encouraged to bathe at least once a week, if possible, and to wash their feet at least twice a week.³³¹ At 4 lb (1.9 kg) per 100 rations, the daily amount of soap for each soldier was only 0.64 oz (118 g). As early as 1808, Dr. Edward Cutbush observed that such a quantity was not enough for a soldier to keep himself and his clothing clean.³³² Evidently the Army did not agree, as the soap ration did not change between then and the Civil War period.

³²⁷ Gamble, *Garrison Life*, 108.

³²⁸ U.S. War Department, *General Regulations 1821*, art. 27, para.14.

³²⁹ *Ibid.*, art. 28, para. 7, and art. 31, para. 5.

³³⁰ U.S. War Department, *General Regulations 1835*, art. 47, para. 30.

³³¹ U.S. War Department, *General Regulations 1835*, art. 9, para. 25.

³³² Prescott, II-64.

Candles were issued to companies, and special provision was made for soldiers on guard duty. Up to 15 lb (6.8 kg) of extra candles could be issued to the principal guard of the garrison.³³³

Coffee and sugar were formally added to the ration by the President in 1832 to replace the regular issue of spirits.³³⁴ The *General Regulations* of 1835 included 4 lb (1.8 kg) of coffee and 8 lb (3.6 kg) of sugar but omitted spirits.³³⁵ The same paragraph still allowed one gill of whisky for troops engaged in heavy labor. The sutler, however, was not allowed to keep ardent spirits nor sell to the troops drinks that included spirits. If he did, he could lose his appointment as sutler.³³⁶ Despite the prohibition, sutlers generally stocked a selection of whisky, gin, and brandy for sale to officers in addition to wines and beer.³³⁷ So popular did coffee become that the ration was increased in 1838 to 6 lb (2.7 kg) of coffee and 12 lb (5.4 kg) of sugar, and again in 1859 to 10 lb (4.5 kg) and 15 lb (6.75 kg), respectively.³³⁸

PRESERVATION ISSUES AND THE IMPORTANCE OF BARRELS

In Transit

In an age when the main defenses against spoilage were tightly closed containers and salt, maintenance of provisions involved a constant struggle against time, climate,

³³³ U.S. War Department, *General Regulations 1835*, art. 47, para. 30.

³³⁴ Prescott, III-50.

³³⁵ U.S. War Department, *General Regulations 1835*, Art. 47, para. 20.

³³⁶ *Ibid.*, art. 32, para. 19.

³³⁷ Gamble, *Garrison Life*, 139.

³³⁸ Prescott, III-47-48, 51.

weather, and human carelessness. Shipments were repeatedly exposed to excessive heat or cold, rain, or snow during months aboard steamboats and wagons on the way to their destinations. Transshipment was especially common on Red River, where whole or parts of cargos would be stored ashore until transport through the Great Raft in smaller keelboats could be arranged. Every time barrels were loaded or unloaded, the risk of damage was increased.

Correspondence relating to a delivery of provisions to Fort Towson in 1833 illustrates some of the issues the Army supply system had to deal with and offers a glimpse into the world of western river trade. It also highlights the importance of good, well-maintained barrels.

In August that year, Captain Taylor, Commissary of Subsistence in Cincinnati, forwarded to General Gibson in Washington the information that sixty barrels of flour and eleven barrels of beans had been condemned by a Board of Survey at Fort Towson.³³⁹ He stated that the barrels had been in excellent condition when delivered into the care of steamboat Captain Harrison in Cincinnati: “as tight and as clean as when they left the coopers shop.” He blames a “French merchant” at Natchitoches where, according to Captain Harrison, “the stores were exposed for a day

³³⁹ Captain I.P. Taylor, Commissary of Subsistence, to General George Gibson, Commissary General (Gibson), August 31, 1833, entry 225 (Consolidated Correspondence), box 1145 (Towson, Fort), record group 92 (Records of the Office of the Quartermaster General), NARA.

or two to violent rains and that the flour was rolled end over end for some distance in mud to the store House to the great injury of the barrels.”³⁴⁰

The Assistant Quartermaster at Fort Jessup, Lieutenant Lee, challenged Captain Taylor’s account.³⁴¹ Lieutenant Lee had overseen the forwarding of the cargo from Natchitoches to Fort Towson, vehemently denied that the barrels were damaged in Natchitoches, and vouched for the French merchant, a Mr. Laplace of the well-respected firm of Cortes & Laplace. When the barrels arrived in town, Lee reported:

...an express was sent to me, notifying me of the fact—it was indeed stormy, the bayous higher, and the rain heavier, I think, than I ever before Knew it—I was obliged to swim, notwithstanding bridges, to get-in—When I arrived at Natchitoches, I found some of the stores in the warehouse; some out, but not such as could [be] injured.³⁴²

He quarreled with Captain Harrison, who “insisted on delivery or discharge, rain or no rain.” Lee directed Laplace to receive no more until the weather settled. Lee continued:

On my inspection of the stores received, I could see no damage, excepting one or two barrels, which Mr Laplace replaced, having got broken open, I understood, through inadvertence.— Cortes & Laplace’s ware house, (at the time far the best in Natchitoches,) is only about 60 feet from high-water mark, but as the water was not then at its highest...the boat discharged say 60 Yards lower down—a numbers of hoops were Knocked off it is true. Many more I am aware, than would be had the bbls been landed at a Northern wharf, as freight is handled rather rough in the south generally, but not in this instance unusually so—The hoops, however, were all renewed, & the stores in perfect order when delivered to Mr [illegible].— Red River mud cannot be avoided entirely, when there is any.³⁴³

³⁴⁰ Ibid.

³⁴¹ Captain Francis Lee, Assistant Quartermaster, Fort Jesup, to Major-General Thomas S. Jesup, Quartermaster General, Washington, October 26, 1833, entry 225, box 1145, record group 92, NARA.

³⁴² Ibid.

³⁴³ Ibid.

The Board of Survey at Fort Towson, Lee pointed out, were of the opinion that the damage to the barrels occurred “in the Transportation, and through the carelessness of the Transporters, as the Flour was wet, and appeared to have become so recently, as most of the Barrels were in very bad order, wanting hoops, staves—& covered with Red River Mud.” Lee doubted that any mud which got on the barrels when Harrison delivered them to Natchitoches *six months previously* “could still remain on—after having been in & out store-shipped & reshipped.— or that they should remain wet such a length of time.” One can only imagine, as Lee suggests, what happened to those barrels in the half a year they were passing through the Great Raft.³⁴⁴

Provisions after Delivery

The problem of spoiled provisions continued after they had been delivered, inspected, and accepted by the receiving garrison. The staple foods in the annual provision contract were expected to last a year *from delivery*. Even with the increased use of steamboats on western rivers, the great distances between sources of supply and many of the frontier forts translated into months in transit. Thus, a barrel of salt pork packed in November would be shipped out for April delivery. Fresh off the steamboat, it was already several months old, and might not be consumed until April or May the following year.

³⁴⁴ Ibid.

While storehouse facilities at some posts (and at some times) were exemplary, at others, the valuable supplies were only “indifferently protected from the weather.”³⁴⁵ Even in the best structures, time and climate worked to spoil the provisions; hence, the frequent examination of supplies on hand so that damage could be kept to a minimum. Most posts had icehouses, which were useful in northern regions where winters were cold enough that ample ice could be gathered. More southerly installations were less fortunate, and the icehouses were of limited use.³⁴⁶

More often than not, provisions fared well enough to adequately and safely nourish the frontier soldiers. Even so, the danger of spoilage and contamination of the rations was a constant threat to the well-being of the troops. In a bad year, the quality of the staples flour and pork suffered greatly. Poor-quality barrels made the problem much worse, as Croghan reported from Fort Atchison in 1842:

The barrels, if not before in use, are certainly badly made and quite shattered. It is thought that on average twenty pounds of flour in each barrel is caked on the outside and sour from exposure to the weather, either before or after its delivery on the bank of the Mississippi. The pork is even in a worse condition than the flour; some of it is quite soft and nearly unfit for use, and in many barrels it is rusty throughout. Lieutenant [Fowler] Hamilton has more than once poured fresh brine into the barrels, but they are so open that it very soon ran out. The fear is that long before the next delivery much of the flour and most of the pork must be condemned as unfit for issue.³⁴⁷

The manner of packing salt pork made a difference to its preservation. The Assistant Commissary at Fort Towson reported in 1840 that:

³⁴⁵ Croghan, *Army Life on the Western Frontier*, 90-91.

³⁴⁶ Gamble, *Garrison Life*, 289.

³⁴⁷ Croghan, *Army Life on the Western Frontier*, 87.

Pork is the most difficult article to preserve, & I would respectfully suggest that the Contractor be required (by the contract) to have the Pork well salted entirely with Turks Island Salt.—The Pork when it is inspected may be perfectly sweet & good, but if it is not extra well salted with T.I Salt, it will be impossible to preserve it during the summer.³⁴⁸

Flour and pork were not the only articles affected by climate. In 1840, the monthly reports of the Assistant Commissary at Fort Towson indicated a wastage of sugar, soap, and vinegar in the Fort Towson storehouse, and he hastened to explain:

The New Orleans Sugar, will lose a great deal, & it is impossible especially in the barrels that it is sent to prevent it from running.—The Soap also will shrink up, it is sent here when new and green & in this hot climate it will dry up. The Vinegar which came this year was put up in poor barrels, at first, & afterwards, being reshipped two or three times, hauled round the Raft &c, when I received it almost every Barrel was beginning to leak. I have used every exertion to prevent wastage & loss of Provisions, but in this climate the very best attention cannot altogether prevent it.³⁴⁹

CONCLUSION

The cumulated experience of generations put *Heroine* on the Red River full of barrels for Fort Towson. By 1838, a remarkably efficient system for the purchase and distribution of supplies to Army posts had been in effect for some years. The ration itself, if not extravagant, was at least in line with contemporary understanding of what constituted a healthful diet. It was also composed of foods which were common in the communities from which the soldiers were recruited. The Army, particularly the Assistant Commissaries of Subsistence, took pains to see that the provisions were

³⁴⁸ Second Lieutenant Josiah H. Vose, Assistant Commissary at Fort Towson (Vose, Jr.), to Gibson, May 20, 1840, entry 10 (Letters Received 1828-1887), box 56, record group 192 (Records of the Commissary General of Subsistence, 1818-1912), NARA.

³⁴⁹ Lt. Vose to Gibson, July 15, 1840, entry 10, box 56, record group 192, NARA.

maintained in as safe and as palatable a condition as possible. The events surrounding the wreck of the *Heroine* illustrate the workings of the Army's supply system in the context of the western frontier.

CHAPTER V

IN CONCLUSION:

FORT TOWSON AND THE WRECK OF THE *HEROINE*

INTRODUCTION

In the spring of 1838, the steamboat *Heroine* made its way through the Great Raft and into the upper Red River. The primary cargo aboard consisted of much-needed subsistence supplies for the garrison at Fort Towson. The Red River lived up to its reputation for dangerous navigation when *Heroine* hit a submerged tree trunk and sank with the loss of a large part of that cargo. Archaeological investigation of the wreck and recovery of cargo-related artifacts have brought attention to a little-known period in the history of river-borne commerce on the upper Red River. It is the purpose of this chapter to put *Heroine*'s last cargo into its immediate historical context and to trace its story from the 1837 public announcement calling for bids on subsistence contracts through the wreck and salvage, and the long aftermath.

The region around the upper Red River in 1838 was a wild frontier, remote from the more "civilized" regions to the east. The new Texas Republic lay to the south, while farther west were lands occupied by Plains Indians, some of whom were allied with Mexico. Disputed territories and conflicting interests among the residents of the area produced considerable unrest. Political and social tensions were high along the river, and there was a real danger of frontier war breaking out. In the great scheme of things,

Heroine's loss was a minor occurrence, but it touched the lives of many individuals. The people most involved with the cargo and loss of *Heroine* were General George Gibson, in his capacity as Commissary General; the contractors William S. Sullivant and Christopher Niswanger, and their supercargo Jonathan E. Fletcher; Captain J.R. Hord, master and owner of *Heroine*; Lieutenant Colonel Josiah H. Vose, commander of Fort Towson, and First Lieutenant Egbert B. Birdsall, Assistant Commissary at the fort.

The Main Correspondents

Most of what can be reconstructed of the events relating to *Heroine*'s last voyage has been gleaned from the correspondence of the office of the Commissary General with Fort Towson and with the winners of the 1837-1838 contract for Fort Towson, Christopher Niswanger and William S. Sullivant. Short biographies of these men follow.

The state of transportation and communication technologies of the day meant that the correspondents might wait weeks or months for news of events. Though mail often passed between Ohio and Washington, DC, in a week or less, communication between either of those places and the upper Red River required four to five weeks.³⁵⁰ Response

³⁵⁰ These estimates are based on evidence from the correspondence. Letters received by the Army in Washington were filed with their envelopes, which were marked with dates received and often annotated with notes of administrative interest. For example, the envelope of a letter dated April 21, 1838, from Vose to Gibson is marked "Rec'd 27 May." From April 21 to May 27 is 37 days or just over five weeks. In some cases, internal evidence can be used to estimate mail times. Responding to this same letter on May 28, Gibson acknowledges that "Your communication of the 21st ult[imate] is received." From April 21 to May 28 is 38 days. These calculations, of course, assume that letters were sent the day they were written and answered the day they arrived, an unreliable circumstance to be sure. Lieutenant Colonel Josiah H. Vose, commander of Fort Towson (Vose), to Brigadier-General George Gibson, Commissary General of Subsistence, Washington, (Gibson), April 21, 1838, entry 225 (Consolidated Correspondence), box 1145 (Towson, Fort), record group 92 (Records of the Office of the Quartermaster General), National Archives and Records Administration, Washington, DC (hereafter NARA). And Gibson to Vose, May 28, 1838,

time for a routine query sent from Fort Towson to Washington or vice versa was at best two months.

George Gibson, Brigadier-General, Commissary General of Subsistence, was born into a military family in 1775, and came of age in a time when the U.S. military establishment was limited.³⁵¹ He was not able to continue the family tradition of military service until the size of the Army was increased in 1808. During the intervening years, he was employed by a prominent Baltimore importer. In his work at the firm's home office and aboard ships as supercargo, young Gibson acquired skills in management and logistics that would serve him well in his military career. He entered the infantry as a captain and rose to the rank of lieutenant colonel during the War of 1812. Discharged when the war ended in 1815, he was called back to active duty the following year by President Madison to serve as Quartermaster General for the Army's Southern Division under General Andrew Jackson. He was sent to New Orleans, where major fighting had occurred in the War of 1812. His first task was the settlement of the many claims against the government arising out of that conflict. During the U.S. Army's first campaign against the Seminole Indians in Florida (1817-1818), Gibson displayed outstanding efficiency in getting urgently needed provisions to General Jackson's troops (see Chapter IV). He was appointed head of the new Department of Subsistence in 1818. As Commissary General, Gibson was instrumental in improving the system of provisioning

entry 1 (Letters Sent, 1818-1889), vol. 15, (135), record group 192 (Records of the Commissary General of Subsistence, 1818-1912), NARA.

³⁵¹ U.S. Army Quartermaster Foundation (Website). "Colonel George Gibson, 11th Quartermaster General."

the troops while reducing the cost to the government. He was awarded brevet ranks of Brigadier-General (1826) and Major-General (1848).

Josiah H. Vose, Lieutenant Colonel, commander of Fort Towson, was born in Milton, Massachusetts, in 1784.³⁵² He married in 1808, and he and his wife had six children. He worked in trade for a number of years before being commissioned as a captain of infantry in 1812. He remained in the Army after the war and saw service at posts all over the nation. Early in his career, he participated in an expedition led by Lieutenant Colonel Henry Leavenworth through the Great Lakes and on to the confluence of the St. Peters (now Minnesota) River and the Mississippi River. There he supervised the initial construction of what would become Fort Snelling. A map of the fort and its surroundings belonging to Vose and annotated by him has become an invaluable document for historians of Fort Snelling. Vose served at a number of posts in that region in the 1820s. In 1830, he was transferred to the 3d Infantry and took command of Fort Towson. He was accompanied by his wife and some of his children. His daughter Charlotte married a young officer in January 1836. She died the following September and is buried in the post cemetery. Part of the family was reunited when Josiah H. Vose, Jr., a new second lieutenant, was assigned to his father's command in December, 1837.³⁵³ Vose, Jr., was appointed Assistant Commissary of Subsistence for

³⁵² Minnesota Historical Society (Website), "The Map, the Map-maker Joseph E. Heckle, and the Map's Owner, Josiah H. Vose." And Teele, *History of Milton, Mass*, 441.

³⁵³ Gardner, *Dictionary of All Officers*, 463.

Fort Towson in December 1839.³⁵⁴ His correspondence with the Subsistence Department has also informed this thesis.

The contractors Christopher Niswanger and William S. Sullivant were prominent businessmen in Columbus, Ohio. Sullivant was born in 1803 in the tiny frontier settlement of Franklinton, near the site where Columbus would soon be established as capitol of the new state of Ohio.³⁵⁵ He graduated from Yale College in 1823. When his father died that same year, young Sullivant returned to Franklinton to supervise the family's extensive properties and other investments. The Sullivants owned, among other interests, a large grist mill for which he designed and implemented a number of mechanical improvements. He added a saw mill to the complex, and acquired a stone quarry that provided material for some of Columbus's great public buildings. Sullivant had interests in banking and in transportation and was among the first to invest in the new railroads. One biographer refers to Sullivant and his lifelong friends William Neil and David W. Deshler (who would act as sureties for the 1837 contract) as "an influential triumvirate in Columbus business."³⁵⁶ Possessed of an agile mind and an inquisitive disposition, Sullivant also found time to pursue his life-long interest in natural sciences.

³⁵⁴ Ibid.

³⁵⁵ Rodgers, *Noble Fellow*, Chapters 2-7.

³⁵⁶ Ibid., 96.

Though described with Sullivant as “among our wealthiest and most prompt and energetic businessmen” not much is known about Christopher Niswanger.³⁵⁷ He was born on January 3, 1792, in Lancaster, Pennsylvania, to David and Mary Niswanger. He married Lydia Spaythe and had at least one son, William.³⁵⁸ Niswanger was commissioned Quartermaster General for the Ohio State Militia on February 28, 1833.³⁵⁹ In honor of that position, which he held for about ten years, he was referred to as General Niswanger.³⁶⁰ He had business dealings with both Neil and Deshler. In April 1837, Deshler and Niswanger were awarded a contract for 200,000 Indian rations to be delivered to Little Rock, Arkansas, by May 20.³⁶¹ Niswanger was also involved in land speculation, as when he and Neil purchased about fifty acres of land in Wyandot County, Ohio, that same year.³⁶²

Niswanger and Sullivant probably had some type of partnership agreement drawn up for their joint venture into army provisioning. Atherton discusses several forms

³⁵⁷ Noah H. Swayne, U.S. Attorney, Ohio District to Gibson, September 27, 1837, Niswanger & Sullivant’s Contract for Provisioning Fort Towson, November 1, 1837, entry 76 (Contracts, 1825-1853) vol. 4, record group 192, NARA (The contract is hereafter cited as N&S Contract). Swayne’s letter was transcribed onto the copy of the contract.

³⁵⁸ Green Lawn Cemetery, family lots, interments 285 and 43324, Green Lawn Cemetery interment cards, ca. 1820-1981, Franklin County Genealogical Society, roll number 81-15, Ohio Historical Society Archives/Library, Columbus, OH (hereafter OHS).

³⁵⁹ General Records of the Governor, 1818-1856 vol. 4, 11 (microfilm GR3950), (OHS).

³⁶⁰ *American Almanac...1843*, 261, lists Niswanger among state officers as Quartermaster General, but *American Almanac...1844*, 276, does not.

³⁶¹ U.S. Congress, House of Representatives, *Executive Documents*, 42-43. An Indian ration consisted of $\frac{3}{4}$ lb (0.34 kg) salt pork; 1 lb (0.45 kg) wheat flour or 1 $\frac{1}{2}$ pt (0.47 l) of corn or corn meal; and 4 qt (3.78 l) salt per hundred rations. At \$0.16 per ration, the contract was worth \$32,000 and involved some 750 bbls of pork and, if only wheat flour were provided, 1020 bbls of flour. Niswanger was experienced in organizing large deliveries of provisions.

³⁶² Critchfield, *Reports of Cases*, 298-301.

of partnership used by western merchants in the early nineteenth century.³⁶³ Using Atherton's types, Niswanger and Sullivant's arrangement can be characterized as an "active partnership" because the names of both men appear on the subsistence contract and related documents. Their partnership agreement, if it followed the usage of the time, would have stipulated how much capital each partner was to contribute, described the duties of each one, and set a time limit on the agreement, in this case, presumably until the final settlement of whatever contracts they might be awarded.³⁶⁴ Both partners would have provided financial backing to the venture, though the relative percentage of funds contributed by the partners is unknown. The Sullivant family's ownership of a grist mill may have made it possible for the partners to submit a low bid on flour.³⁶⁵ Niswanger, though older, was the operating partner; he appears to have been the one who gathered the contracted goods and arranged for their shipping, and he handled the correspondence with the Commissariat of Subsistence.³⁶⁶

FORT TOWSON, SPRING 1838

The garrison at Fort Towson was fully occupied with its missions of guarding the borders of the United States, protecting the removed tribes, and keeping the peace among the Indians and between Indians and whites (see Chapter II). Tensions between

³⁶³ Atherton, *Frontier Merchant*, 116-123.

³⁶⁴ *Ibid.*, 121-122.

³⁶⁵ It is possible that flour from the Sullivant mill was used to fulfill at least part of the contract—shipping the barrels from Columbus via the Ohio and Erie Canal to the Ohio River and on to Cincinnati. On the other hand, Sullivant's connections with flour merchants may have facilitated an arrangement to procure flour cheaply in the Cincinnati area.

³⁶⁶ Most of these letters are signed by Niswanger only, though occasionally he added Sullivant's name to his own. Gibson's communications are invariably addressed to Niswanger and Sullivant. In this study, Niswanger's name only is used for correspondence to or from the contractors.

the United States and Texas were increasing in the wake of Texas independence from Mexico in 1836. The flash-point was disputed Miller County, Arkansas, established in 1820 with Jonesborough as county seat. The entire county lay on the south side of the river. This same region was organized as Red River County by the Republic of Texas in 1837, and, indeed, most of its inhabitants considered themselves to be Texan.³⁶⁷ They rejected the authority of the Arkansas courts at a time when the Texas legal system was in its infancy, resulting in a legal vacuum that contributed to the lawlessness of the region.³⁶⁸

Indians from the Territories were under the protection of Fort Towson, but they frequently crossed the river, attracted by opportunities for trade and by the availability of liquor. Vose expressed his concerns to General Matthew Arbuckle at Fort Gibson in April 1838:

The population bordering on the Red River & directly opposite the Choctaws has greatly increased during the last year & is still increasing. Difficulties are frequently taking place between the whites & Choctaws, and unless there is an improving military force on this frontier I fear we may have disasters of a serious nature.³⁶⁹

With all the threats to the peace that plagued the region, Vose was worried that the force at Fort Towson, though gradually being increased, would be insufficient to respond to the crises that threatened. “I take the liberty to recommend,” he urged, “that

³⁶⁷ Connor, “Miller County, Arkansas,”

³⁶⁸ Foreman, *Advancing the Frontier*, 84, note.

³⁶⁹ Vose to General Matthew Arbuckle, Commander 3d Infantry, Western Division at Ft. Gibson (Arbuckle), April 12, 1838, in Cooling, *New American State Papers*, 358-360.

the whole of the 3d Infantry be concentrated at this post with as little delay as possible.”³⁷⁰

In April, Vose reported a serious “affray”—i.e., drunken fights—between whites and Choctaws that occurred on the south side of the river.³⁷¹ One white and one Choctaw were killed and three whites wounded, including a woman and a child. “The white people were undoubtedly the aggressors, as is generally the case in all Indian difficulties,” Vose wrote.³⁷² Nevertheless, “in order to allay the great excitement among the white people,” he had “prevailed upon the Choctaws to give up two of the ringleaders in the affray,” and kept them in custody at the fort.³⁷³

The potential ramifications of such incidents went far beyond the local region. On April 20, 1838, Vose received intelligence that a large group of Mexicans and Plains Indians from tribes outside the U.S. territories was gathering several hundred miles to the west. Their intention was to make war upon Texas, and to recruit the relocated Creeks, Cherokees, and Choctaws of Indian Territory to join them, or, at least, to encourage them to remain neutral.³⁷⁴ Vose later gave this assessment of the situation:

The Choctaws I believe to be friendly to the United States, and I do not think they will engage in any act of hostility against the people living on our [Choctaw Nation’s] border, so long as they believe them to be citizens of the United

³⁷⁰ Ibid.

³⁷¹ Vose to Brigadier General Roger Jones, Adjutant General, Washington (Jones), April 13, 1838, in Cooling, *New American State Papers*, 359-360. Characterization of the incident as “drunken fights” is from Foreman, *Advancing the Frontier*, 159.

³⁷² Vose to Jones, April 13, 1838, Cooling, *New American State Papers*, 359-360.

³⁷³ Ibid.

³⁷⁴ Vose to Arbuckle, April 20, 1838, entry 14 (Letters Received 05/1834-1841), roll 2, M1302 (2d Military Dept. 1834-43, Records of Headquarters, Army of the Southwestern Frontier, and Headquarters, Second and Seventh Military Departments, 1835-1853), record group 393 (Records of the United States Army Continental Commands, 1821-1920), NARA.

States—But when they find they are no longer under our jurisdiction, I am of opinion the Indians would be ready to join Mexico against the people of Texas, and in that event, the war would probably extend to this frontier.³⁷⁵

During that spring and beyond, Vose worked to diffuse tensions, arranging for meetings between the Choctaws and Texans to discuss the recent troubles, all the time gathering intelligence of developing events and reporting on situations to his superiors at Fort Gibson and in Washington.³⁷⁶

While contending with the threat of war on the frontier, the Army also found itself dealing on a local level with an issue that would divide the nation over the next decades: slavery. The complexity of the Army's mission in the Indian Territories was increased by the presence of Blacks living among the different tribes. Some were slaves belonging to Indians, others were either freemen or fugitives. The latter two groups attracted slave hunters and traders from southern states and from Texas, and kidnappings of Blacks were frequent.³⁷⁷ Slave hunters in possession of warrants, some of dubious legality, for the capture of individual fugitives frequently approached the military for assistance in finding and apprehending their prey.³⁷⁸ The Army's official responses to such requests tended to be somewhat ambivalent. In his role as a frontier lawman, Vose did what he could to uphold justice as he saw it.³⁷⁹ He was involved in the celebrated case of the Beams, a family of free Blacks who lived near Fort Towson and were targets

³⁷⁵ Vose to Jones, May 30, 1838, entry 14, roll 2, M1302, record group 393, NARA.

³⁷⁶ Vose to Arbuckle, April 27, 1838, entry 14, roll 2, M1302, record group 393, NARA.

³⁷⁷ Foreman, *Advancing the Frontier*, 160-162.

³⁷⁸ Littlefield, "The Beams Family: Free Blacks in Indian Territory," 23.

³⁷⁹ This role of the Army is described by Tate in, "Posse Comitatus in Blue: The Soldier as Frontier Lawman," chap. 4 in *Frontier Army*.

of repeated attempts over many years to return them to slavery. During one such attempt in 1838, Vose, “a champion of the Beams family,” took them into the fort for their protection.³⁸⁰ Such small dramas were nonetheless matters of life and freedom to those involved.

Vose needed reinforcements in order to maintain order on the frontier, but increases in the post’s population created additional problems. A detachment that included four officers plus 174 men and two women, reached the fort on March 30, 1838.³⁸¹ Welcome as the new arrivals were, the need to feed and house additional troops put a strain on the resources of the post.

The subsistence stores at Fort Towson fed not only the enlisted troops, laundresses, and other authorized civilian workers, but, due to the fort’s remoteness, subsistence stores were also available for purchase by officers for themselves and their families. In addition, the commander drew on the stores for visiting Indians or official delegations or for other purposes as necessary. Though the situation in the winter of 1837-1838 was not desperate, it was becoming more serious from month to month. The subsistence accounts submitted monthly by the Assistant Commissary and duly recorded in the ledgers of the Subsistence Department show that by April’s inventory there were 165 bushels of beans but no rice and no cornmeal.³⁸² The 133 barrels of pork and 136 barrels of flour on hand were not as plentiful a supply as might appear. By now

³⁸⁰ Littlefield, “The Beams Family: Free Blacks in Indian Territory,” 23.

³⁸¹ Annotation on envelope, Lieutenant E. B. Alexander to Major Trueman Cross, acting Quartermaster General, March 14, 1838, entry 225, box 1145, record group 92, NARA.

³⁸² Subsistence Accounts for Fort Towson, 1837-1838, entry 36 (Provision Books, 1833-1881), record group 192, NARA.

these articles were well over a year old, and their quality was rapidly deteriorating. The previous year, before increases to the garrison began, Fort Towson used about twelve to fifteen barrels of pork and twenty-six to thirty barrels of flour per month. At those rates, pork and flour on hand might last for some months, if they remained edible. Moreover, the post gardens, which contributed so significantly to the soldiers' diet, were no doubt under cultivation. This early in the year, however, little if any of the produce would be ready for consumption.

Fort Towson, like some other forts, maintained its own herd of cattle, beef "on the hoof" being easier and safer to store than butchered meat.³⁸³ Developing this reliable food source as insurance against the vagaries of supply on the frontier, especially in the winter, would have been a priority for Vose. The size of the herd, which was measured in pounds, not by the head, varied considerably month to month, averaging around 8,000 lb (3,628 kg) 1837. In April 1838, only 3,701 lb (1,679 kg) were recorded, down from a high of 17,595 lb (7,981 kg) the previous August. Besides the beef herd, fresh pork was sometimes available to supplement the ration. Some 3,200 lb (1,451 kg), perhaps 16 to 20 animals, were received in December 1837. The herd gradually diminished to 820 lb (379 kg) in April and was gone in May. The provision book records that, while the fresh pork supply was diminishing early in the year, the use of salt pork dropped to an average of only eight barrels per month.³⁸⁴

³⁸³ Gamble, *Garrison Life*, 111.

³⁸⁴ Subsistence Accounts for Fort Towson, 1837-1838, entry 36, record group 192, NARA.

HEROINE'S LAST CARGO

Call for Proposals

The story of *Heroine's* final cargo begins with an announcement from the Office of Commissary General of Subsistence, dated July 1, 1837, that appeared in newspapers across the nation repeatedly over the summer:

Separate Proposals will be received at this office [it began] until the second day of October next, for the delivery of provisions for the use of the troops of the United States, to be delivered in bulk, upon inspection, as follows...³⁸⁵

Twelve Army posts were listed with the articles and quantities required by each.³⁸⁶ Most of the posts were located on the far frontiers of the nation: Forts Towson and Coffee in Indian country, and Forts Snelling, Crawford, Winnebago, Howard, and Brady in the north and northwest. The far northeast was represented by Maine's Hancock Barracks. Garrisons at New York, Baltimore, St. Louis, and New Orleans were also on the list.

The same six articles of the ration were required for each post—salt pork, fresh superfine flour, new white field beans, good hard soap, good hard tallow candles with

³⁸⁵ Office of the Commissary General of Subsistence, "Separate Proposals will be received" (hereafter cited as Call for Proposals, 1837), July 1, 1837. Among the newspapers to print the announcement was the *New Orleans Bee* of July 15.

³⁸⁶ In the 1830s and early 1840s, the number of posts listed in the call for proposals each year varied from as few as 12 to over 30. Entry 66 (List of Proposals for Subsistence Contracts, 1819-1841), vol. 1, record group 192, NARA.

cotton wicks, and good clean dry salt—except Baltimore and New York for which candles were omitted.³⁸⁷

The easily accessible posts—New Orleans, New York, Baltimore, and St. Louis—were to receive one-fourth of their allotments in each of four quarterly deliveries. Hancock Barracks received theirs in three deliveries. The year’s rations for all the other forts were due in a single bulk delivery in April, May, or June, as specified. Fort Towson’s rations were due in the month of April, and were to be shipped from Natchitoches not later than February 20. From Natchitoches to the Fort Towson landing was roughly 400 mi (664 km). Experience had shown that timely delivery depended on catching the high waters of early spring. A similar provision applied to contracts for Forts Snelling and Crawford whose supplies had to pass St. Louis by April 15. “A failure in this particular,” the announcement stressed, “will be considered a breach of contract, and the Department will be authorized to purchase to supply these posts.”³⁸⁸ No such stringent consequence was applied to failure to depart Natchitoches by February 20 on route to Fort Towson. Had one been in place, the fate of *Heroine*’s cargo might have been different.

The contractors were totally responsible for *all* costs relating to the provisions until they had been inspected “at the time and place of delivery,” were deemed

³⁸⁷ Vinegar was an important item of the ration that was usually part of the contractor’s stores. For whatever reason, from 1837 to 1840, vinegar was omitted from the annual contract and was procured by Assistant Commissaries through other means. Entry 66, vol. 1, record group 192, NARA.

³⁸⁸ Call for Proposals, 1837, para. 4.

acceptable, and had been deposited in the designated storehouses.³⁸⁹ No advance payments would be made under any circumstances. The receiving officer would provide the contractor or his agent with a certificate of inspection for the goods delivered. Only after the certificate was submitted to the Subsistence Department would the contractors be paid. Payments were made by Treasury warrants on banks, and contractors could choose a bank nearest where the provisions had been purchased or had been delivered or nearest their own residences.³⁹⁰ Bidders new to the system were required to submit with their proposals “evidence of their ability, together with the names of their sureties, whose responsibility must be certified by the District Attorney, or by some person well known to the Government.”³⁹¹

These contracts were a risky business.³⁹² Added to the danger of failure inherent in transporting large bulk cargos hundreds of miles and often over remote frontier passages, the government could adjust the amounts of provisions required. Before a contract was signed, the quantities of a given article might be altered, or one or more articles might be eliminated altogether. Even after signing, quantities could be increased or decreased by one-third, provided sixty days’ notice was given.³⁹³ As Atherton points out, slow transportation in the West meant that sixty days was often not enough warning of a reduction. The supplies would already be purchased and on their way before the contractor received the notice. Furthermore, the contractor was responsible for meeting

³⁸⁹ Ibid., para. 5.

³⁹⁰ Ibid., para. 8.

³⁹¹ Ibid., para. 7.

³⁹² Atherton, *Frontier Merchant*, 100.

³⁹³ Call for Proposals, para. 6.

“the rigid standards” set by the government, while “the government agents [were] the sole judges as to whether these conditions were fulfilled.”³⁹⁴ “Such conditions,” says

Atherton:

...called for caution in bidding. The reserved right of the government to alter a contract made bidders hesitate to offer low prices on some costly article in the hope of balancing this item against other provisions that could be purchased cheaply. An alteration of quantities could destroy all profit if it affected the bidder’s most lucrative items. On the other hand, an especially high price on some one article could cost the merchant loss of the whole contract.³⁹⁵

In making their bids, potential contractors had to consider the cost of transportation, usually by steamboat, but being prepared to hire alternative means of transport such as keelboats or wagons, and/or to pay for storage of the cargo ashore should need require. The wise contractor insured the cargo against loss. Someone would need to accompany the shipment to oversee the process, an added expense whether it was the contractor himself or someone hired for the job.³⁹⁶

All business transactions carried risk, however. The supply contracts were large orders and payments by Treasury warrants were reliable; if all went well, such a venture could be quite profitable. Niswanger and Sullivant submitted bids for nine of the posts in the 1837 announcement, excluding only the three on the east coast.³⁹⁷

³⁹⁴ Atherton, *Frontier Merchant*, 99.

³⁹⁵ *Ibid.*, 100.

³⁹⁶ The lowest proposal did not necessarily win the contract. Of the posts bid on by Niswanger and Sullivant in 1837, New Orleans, Coffee, and Crawford did not go to the lowest bidders. Niswanger and Sullivant, however, were well above the winning proposals. Entry 66, vol. 1, record group 192, NARA.

³⁹⁷ Fort Towson, 1837 Proposals, entry 66, vol. 1, record group 192, NARA.

Niswanger and Sullivant's Proposal

In the end, Niswanger and Sullivant were awarded only the contract for Fort Towson. Their low bid of \$9.50 per barrel on flour made their proposal attractive, since other contractors' bids ranged from a low of \$12 to \$20 per barrel. Their error in calculating their proposal was in underestimating the cost of transportation. The Red River, far to the south of Cincinnati, was never subject to the winter ice that plagued vessels on the Ohio River. News of Henry Shreve's success in cutting a channel through the Great Raft was expected at any moment. Surely, the contractors no doubt expected, the passage to Fort Towson would be open and the risks well within acceptable limits. Niswanger and Sullivant's Fort Towson proposal is summarized in Chart V-1.

**Table V-1 Niswanger and Sullivant's 1837 Proposal
for Fort Towson Subsistence Contract**

| <i>Commodity</i> | <i>Price per unit</i> | <i>Total</i> |
|----------------------|-----------------------|--------------|
| 240 barrels pork | \$21.00 | \$5040 |
| 500 barrels flour | \$9.50 | \$4750 |
| 220 bushels beans | \$3.50 | \$770 |
| 3,500 pounds soap | \$0.16 | \$560 |
| 1,600 pounds candles | \$0.18 | \$288 |
| 80 bushels salt | \$1.60 | \$128 |
| | | \$11,536 |

As required, they provided a letter from the U.S. Attorney for the Ohio District, Noah H. Swayne³⁹⁸ attesting to the reliability of Niswanger and Sullivant and of three men they proposed as sureties, David W. Deshler, William Neil, and Michael L. Sullivant (William’s brother). “I understand Genl. C. Niswanger and Wm. S. Sullivant Esq. now of this place are about forwarding proposals for a contract with your department...” Swayne wrote. “I take leave to say,” he continued:

...that Messers Sullivant & Niswanger are among our wealthiest & most prompt & energetic businessmen—You may rely confidently upon any Engagement they may Contract being punctually & faithfully fulfilled. Either two of the Gentlemen named as sureties are responsible for more than one hundred & fifty thousand dollars....³⁹⁹

The Contract⁴⁰⁰

The same standard contract for the annual subsistence stores was used from year to year—a printed document stating the terms in the legalese of the day with spaces where details relevant to particular agreements could be handwritten in. The 1837 Fort Towson contract was signed by Gibson in Washington then sent to Columbus for the signatures of Niswanger and Sullivant:⁴⁰¹

³⁹⁸ Swayne would later serve on the U.S. Supreme Court, appointed by President Lincoln in 1862. “Noah H. Swayne,” *Ohio History Central*.

³⁹⁹ Swayne to Gibson, September 27, 1837, N&S Contract.

⁴⁰⁰ N&S Contract.

⁴⁰¹ Printed text of the contract is here presented in Roman, handwritten text in *italics*. Strikethroughs original.

ARTICLES OF AGREEMENT

MADE ON THE *First* day of *November*

One thousand eight hundred and *Thirty Seven* between
George Gibson, *Commissary General of Subsistence*, on the one part, and
Christopher Niswanger and William S. Sullivant of the city of Columbus State of
Ohio on the other part.

This Agreement Witnesseth, that the said George Gibson, for and on behalf of
the United States of America, and the said *Niswanger and Sullivant* their heirs,
executors and administrators, have mutually agreed, and by these presents do
mutually covenant and agree, to and with each other, as follows, to wit:

1st. That the said *Niswanger and Sullivant* their heirs, executors or
administrators, shall deliver at *The public landing six miles from Fort Towson in*
~~the~~ *mouth of the Chiemichi....*

Paragraph 1 continued with the listing of the commodities contracted for, and six
more paragraphs followed.

No changes had been made in ration quantities from those in the announcement.
The particulars regarding the quality of the articles and packing containers as stated in
the contract were essentially the same as those in the announcement. The pork was to be
corn-fattened, “each hog to weigh not less than two hundred pounds (90.7 kg), excluding
the feet, legs, ears and snout,” and “side pieces” could be substituted for the hams. The
contract did not mention the use of Turk’s Island salt or packing in pieces not more than
ten pounds each, though these were common variations of packer’s products. The
provision that the pork should be packed “one hog to the barrel” was also omitted from
the contract. As to containers, the contract called for “strong and secure barrels” for
pork, beans, flour, salt, and vinegar, and “strong and secure boxes...of a convenient size

for transportation” for the soap and candles.⁴⁰² Though the announcement allowed either white oak or white ash for the pork barrels, the contract specified “seasoned heart of white oak” for both pork and flour. Pork barrels were to be “full hooped.”

Conditions of the agreement, such as the government’s right to alter the required quantities by one-third upon sixty days’ notice, were reiterated. A further elaboration of the inspection process emphasized the contractor’s financial responsibility. As described in the announcement, all the articles would be inspected on delivery. However, the contract stated that, if none of “the inspectors regularly appointed for *Fort Towson*” were available when the shipment arrived:

...the Assistant Commissary of Subsistence and the said *Niswanger & Sullivan [or their agent]* will appoint some person...qualified for that purpose...and the said *Niswanger & Sullivan* to be liable for the expense of inspection, and for all other expenses, until the articles are safely delivered at such store-house as may be designated by the United States, at *The public landing six miles from Fort Towson*.⁴⁰³

Thus, *any* costs incurred *before* delivery and acceptance were the contractor’s to bear, even if the “fault” was the government’s—in this case, if no inspector were provided. If nothing else, this provision served to underline just how particular the government was regarding enforcement of the letter of the contract.

⁴⁰² N&S Contract, Para 2. Vinegar was not listed among the contracted items, and the vinegar line in the list of prices for individual items was lined out. However, information regarding vinegar barrels remained unchanged.

⁴⁰³ *Ibid.*, para. 3.

Failure to deliver the required quality and quantity of provisions, for almost any reason, carried consequences that were clearly spelled out. An appropriate government agent, often the Assistant Commissary:

...shall have power to supply the deficiency, or any part thereof, by purchasing articles of the specific quality contracted for; or, if provisions of the specific quality designated in the contract cannot be purchased, then to supply provisions as near the specified quality as practicable, and the said *Niswanger & Sullivan* to be held liable for all damages, or loss sustained by the United States.⁴⁰⁴

Such an eventuality boded ill for the contractors. The Assistant Commissary's primary concern would be getting needed provisions back to the post, not trying to minimize the contractor's losses. He would likely have to pay more than the contracted prices, even for articles of identical quality. Any cost to the government beyond the agreed upon rates was considered a "loss" as stated:

...the measure of damages to be the difference between the contract price of the article contracted for, and its market value, at the place of purchase, at the time of delivery, adding thereto the cost of transportation, if any.⁴⁰⁵

Take, for example, a case where the contractor agreed to provide 500 barrels of flour at \$10 per barrel, but, all the flour being lost, the Assistant Commissary was authorized to supply by purchase to make up the deficiency. If the Assistant Commissary purchased flour at \$12 per barrel, the government's "loss" would be \$2 per barrel. A transportation cost of \$3 would bring the loss to \$5 for each barrel of flour purchased. Thus, if the Assistant Commissary purchased 500 barrels of flour to replace what the

⁴⁰⁴ Ibid., para. 5.

⁴⁰⁵ Ibid.

contractor had failed to deliver, the contractor would be liable to the government for \$2,500.

This authorization to supply by purchase under the Commissariat was an essential improvement over the former system. It ensured that the needs of the Army would be met without incurring additional expense to the government. An exception would be made *only* in case of “losses sustained by depredations of an enemy.”⁴⁰⁶ Once the circumstances of such a loss were confirmed, the government would pay the contracted price for the articles lost and would also compensate for other property used in transporting the contracted stores at an appraised value. Such instances would be rare in a peace-time Army.

David W. Deshler and William Neil served as sureties for Niswanger and Sullivan, somewhat like co-signing on a loan. Appended to the contract was a document signed by all four men holding them “firmly bound unto the United States of America, in the sum of *Eleven thousand five hundred & thirty six* dollars, lawful money of the United States, to be paid to the said United States.” When all the “covenants, conditions, and agreements” in Niswanger and Sullivan’s contract of November 1, 1837, were fulfilled, “then the above obligation to be null and void; otherwise to remain in full force and virtue.”⁴⁰⁷

⁴⁰⁶ Ibid., para. 6.

⁴⁰⁷ Ibid.

Cincinnati: Gathering the Cargo

Niswanger spent considerable time in Cincinnati gathering the contracted stores and arranging for their transportation to Fort Towson. As the cargo was shipped from Cincinnati, it is reasonable to suppose that most if not all the items were from that area, if not the city itself. There is no known documentary evidence as to the suppliers of the items of provisions. Archaeological evidence, however, indicates that Cincinnati meat packer Alfred S. Reeder supplied at least part of the pork, as his brand was found on one pork barrel-head. Barrel-head brands of two firms were found on flour barrels, but neither J. Phillip nor W&R Phares appear in the Cincinnati directories. Though the production of local mills around Cincinnati was relatively small, much of the flour produced for export in the Ohio Valley region came through the city.⁴⁰⁸ J. Phillip and W&R Phares were likely firms which had some associations with the Sullivants' milling interests. They may have been millers themselves or merchants dealing in groceries and provisions, perhaps from the Columbus area. All barrels of flour brought to Cincinnati for export were required to undergo inspection.⁴⁰⁹ Several barrel-heads from *Heroine* bore the brand of A.E. Armstrong, a flour inspector in Hamilton County.⁴¹⁰

As for the small parts of the rations—the beans, salt, soap, and candles—here again the suppliers are unknown. Soap and candles were by-products of the pork packing industry, making Cincinnati the most likely source for those items. The beans were

⁴⁰⁸ Berry, *Western Prices*, 163-164.

⁴⁰⁹ “An act for the inspection of certain articles therein enumerated,” passed March 9, 1831, Chase, *Statutes of Ohio*, Chap. 892, 1889-1894.

⁴¹⁰ Woodruff, *Cincinnati Directory...1837-8*, 11.

probably local, too, brought to market from the agricultural regions surrounding Cincinnati. Although salt works were operating in several locations in the Ohio Valley, such as along the Conemaugh River in western Pennsylvania and around Zanesville, Ohio, most of the salt in the Cincinnati market came from the Kanawha Valley in (West) Virginia, making it the most likely source for the cargo's salt.⁴¹¹

The whole cargo was contained in 740 barrels of pork and flour, around 80 barrels of beans and salt, and perhaps 140 boxes of soap and candles. Niswanger engaged a steamboat (whose name is not known) to transport the supplies to Shreveport. The plan was for the same steamboat to continue up the Red River and through the Great Raft, if possible.⁴¹² If Henry Shreve had not yet succeeded in opening a channel passable by larger vessels, the old method of transferring the cargo to keelboats for the last leg of the journey would be employed. The freight from Cincinnati was \$1.50 per barrel for flour and \$1.875 for pork⁴¹³ totaling \$1,050 for those commodities. (To this sum would be added the freight on the small parts of the ration.) Niswanger hired Colonel Jonathan Emerson Fletcher as supercargo to accompany the shipment to Fort Towson and expedite the delivery.⁴¹⁴

⁴¹¹ Berry, *Western Prices*, 294-295.

⁴¹² Niswanger to Gibson, February 17, 1838, entry 10 (Letters Received 1828-1887), box 46 (M-Z 1838), record group 192, NARA.

⁴¹³ Vose to Gibson, May 14, 1838, entry 225, box 1145, record group 92, NARA.

⁴¹⁴ Fletcher was a native of Vermont who moved to Ohio in the early 1830s. In 1835, "Fletcher won recognition and praise from Ohio Governor Robert Lucas for his cool handling of a border dispute when an armed militiamen from Michigan opened fire on surveyors (among them Fletcher) working for the State of Ohio." He evidently impressed Niswanger and Sullivan as a dependable young man. Crisman, Chick, and Davis, "Shipwrecked in Oklahoma," 291, note 16.

By the end of January 1838, all the cargo was loaded aboard the steamboat, ready in good time for the nearly 2,000 mi (3,020 km) journey. Winter weather upset the schedule, however—ice running in the Ohio River made navigation too dangerous and kept the vessel moored to the Cincinnati landing. A severe snow-storm in mid-February followed by days of below-zero temperatures made conditions even worse.⁴¹⁵ By February 17, when Niswanger wrote to apprise Gibson of the situation, the steamboat had been detained for nearly three weeks already, but Niswanger was still confident: “We have no doubt the delivery will be made in time and to your entire satisfaction [sic].”⁴¹⁶

Still the weather did not break. On February 22, the steamboat *Kentucky*, moored along the Cincinnati landing, was crushed by river ice.⁴¹⁷ Not until early March was the steamboat bearing the contract stores able to get under way. This delayed departure from Cincinnati was unfortunate, as it would now be impossible for the steamboat to pass Natchitoches by February 20, as stipulated in the contract.

The Cargo in Transit

Sometime before the end of March, the provisions reached Natchitoches, Louisiana, about 90 mi (145 km) below Shreveport on the Red River. Though Shreve’s crews were still at work removing obstacles from its upper reaches, several larger

⁴¹⁵ *Cincinnati Daily Gazette*, February 23, 26, March 2, 6, 1838.

⁴¹⁶ Niswanger to Gibson, February 17, 1838, entry 10, box 46, record group 192, NARA.

⁴¹⁷ *Cincinnati Daily Gazette*, March 6, 1838.

steamboats had managed to pass through the Great Raft.⁴¹⁸ Passage through the Raft was now possible, but even so, the Red River was notoriously dangerous and the upper river was both dangerous and relatively unknown. The master of the unnamed steamboat was unwilling to risk his vessel by taking it further. So, Fletcher arranged with J.R. Hord to carry the provisions from Natchitoches to the Fort Towson landing on the *Heroine*.⁴¹⁹

When he agreed to take the cargo, Hord had been running *Heroine* as a packet service with scheduled stops between Vicksburg and Natchez on the Mississippi River and Alexandria and Natchitoches on the Red River.⁴²⁰ He knew the Red River and was well acquainted with its dangers. His rates reflected the hazards of the venture as well as the urgency of Fletcher's need to find a vessel capable of completing the delivery. The rate of \$2.50 per barrel for pork and flour was well above the cost of transportation from Cincinnati. For those articles alone, the freight charges were \$1,850, to which would be added freight on the small parts of the ration.⁴²¹ This was undoubtedly a risky venture, but *Heroine* was already an old boat and, in the way of the early river steamboats, was depreciating rapidly. Prospects for a sizeable profit, however, and an opportunity to explore the newly opened upper river made Hord consider the risk worthwhile.

The cargo was transshipped in Natchitoches, and *Heroine* set off upriver. Cargo in addition to the military supplies was also on board. Hord may have contracted to carry

⁴¹⁸ Henry M. Shreve to General C. Gratiot, June 4, 1838, in *Army and Navy Chronicle*, vol. 6, June 14, 1838, 377-379.

⁴¹⁹ Niswanger to Gibson, April 28, 1838, entry 10, box 46, record group 192, NARA. This is the first mention of *Heroine* in the Subsistence Department's official correspondence.

⁴²⁰ Crisman, Chick, and Davis, "Shipwrecked in Oklahoma," 274.

⁴²¹ Vose to Gibson, May 14, 1838, entry 225, box 1145, record group 92, NARA.

goods for a local trader, or it might have represented an investment by Hord himself. In any event, the cargo “on private account” was rumored to include barrels of whisky for the sutler at Fort Towson.⁴²²

Fletcher reported to Niswanger from Shreveport on March 29 that the provisions were “all safe and in good order aboard of the Steam Boat *Heroine* J.R. Hord Master.”⁴²³ Niswanger received Fletcher’s letter a month later, and immediately informed Gibson. By that time, Niswanger presumed, the delivery had already been made. It had not.

It is known that *Heroine* was in Shreveport on March 29 and in Jonesborough on the morning of May 6. The vessel’s progress over the intervening five weeks is not documented and can only be surmised from available evidence. Hord brought *Heroine* successfully through the Raft early in April, but still had a long way to go. He may have passed the wreckage of two steamboats that had come safely through the Raft before him only to be snagged and sunk in the upper river in the first week of April—grim reminders, if any were needed, of the hazards that lay ahead.⁴²⁴ The river was falling, making passage difficult, even for as shallow-drafted a vessel as *Heroine*. Hord’s progress up the river was somewhat halting as he responded to river conditions—making miles when the waters were deep enough, but forced to tie up and wait when they were not.

⁴²² Withenbury, “Red River Reminiscences,” January 8, 1871, 3.

⁴²³ Niswanger to Gibson, April 28, 1838, entry 10, box 46, record group 192, NARA.

⁴²⁴ Crisman, Chick, and Davis, “Shipwrecked in Oklahoma,” 275.

By mid-April, the food situation at the fort was getting serious. The pork and flour, remainders of the previous year's supplies, were going bad. The pork was "so rusty," according to Vose, "that [a] considerable part of each piece must be cut off from the outside before it is fit for cooking."⁴²⁵ The fresh pork was gone, and there was neither cornmeal nor rice in the storehouse.⁴²⁶ Because of "the very inferior quality of the flour & especially the pork, and an entire destitution of vegetables,"⁴²⁷ Vose decided to increase the flour and pork rations by one third and to increase the beans by one half.⁴²⁸ Vinegar was also getting low, but a shipment of 16 barrels from New Orleans was expected within a week or two. The delivery would have been made already had not a sudden fall in river water level forced a delay.

Vose learned that the provisions had made it through the Raft and reached a point about 100 mi (161 km) below Fort Towson, probably Fulton, Arkansas. He sent his commissary clerk, an enlisted man who worked for the Assistant Commissary, to meet the boat, and to request that a few barrels of pork be sent ahead by keelboat "unless the S Boat has a prospect of soon getting up."⁴²⁹ The commissary clerk was evidently unable to intercept the shipment of provisions at Fulton as no part of the cargo was forwarded by keelboat or any other means.

By the end of April, Hord had brought the steamboat safely as far as Jonesborough on the Texas side of the river. After several unsuccessful attempts to

⁴²⁵ Vose to Gibson, April 21, 1838, entry 225, box 1145, record group 92, NARA.

⁴²⁶ Subsistence Accounts for Fort Towson, 1838, entry 36, record group 192, NARA.

⁴²⁷ Vose to Gibson, April 21, 1838, entry 225, box 1145, record group 92, NARA.

⁴²⁸ Ibid.

⁴²⁹ Ibid.

traverse the last few miles to the Fort Towson landing, he was forced once again to tie up and wait for the water to rise. Wittenbury's account (see Chapter I) suggests that Hord and his crew enjoyed the hospitality of the townsfolk for some days.⁴³⁰ As Jonesboro was only a few miles from Fort Towson, Vose would have soon learned of *Heroine's* presence in Jonesborough. In light of conditions at the fort, it seems odd that he did not send again to request a partial delivery of provisions. However, as the river might rise at any moment, and only a small rise would allow full delivery, he may have considered it reasonable to wait a few more days.

Snagged, Sunk, and Salvaged—the Loss of the *Heroine*

The water eventually rose enough for Hord to try again, this time with the aid of a local keelboat pilot.⁴³¹ On the morning of May 6, 1838, *Heroine* steamed away from Jonesboro. In less than half an hour, and still in view of the watching townsfolk, *Heroine's* port side rammed a submerged log, tearing a mortal wound in the hull.⁴³²

The steamboat sank, but was not lost to sight. The river was not high, and as the hull settled on the bottom canted slightly to port, the superstructure and probably the starboard side of the main deck remained above water. Water poured into the hull through the damaged port side, but at least for a while, the hold cargo remained accessible. The crew began immediately to save what could be reached of the cargo with help from townsfolk.

⁴³⁰ Wittenbury, "Red River Reminiscences," January 8, 1871, 3.

⁴³¹ *Ibid.*

⁴³² *Ibid.*

As soon as he learned of the disaster, Vose dispatched a party of two officers and thirty men to assist the crew and the contractor with the salvage and to bring what could be saved of the stores to the warehouse at the public landing.⁴³³ The salvagers were able to recover several hundred barrels and boxes before a sudden rise of the river put an end to the operation. By the time the river fell again, the hold was hopelessly silted-in, and the remainder of the cargo was abandoned.

After the Wreck: 'Til the Paperwork is Done

It was several weeks before Vose could rest assured that provisions in the storehouse would be sufficient for the growing needs of the garrison in the coming year. The Assistant Quartermaster was responsible for transporting the subsistence stores the 6 miles (9.7 km) from the landing to Fort Towson, where they became the responsibility of the Assistant Commissary, First Lieutenant Egbert B. Birdsall.⁴³⁴ Birdsall was required to inspect the stores and provide Fletcher, as the contractors' representative, with duplicate receipts for the goods received.⁴³⁵ Even had there not been a likelihood that some of the provisions were damaged by submersion in river water, Birdsall was required to ensure that the contents of each barrel were indeed good. The Assistant Commissary was accountable for all items in his charge; he personally was required to

⁴³³ Vose to Gibson, May 7, 1838, "Extracts of letters dated Fort Towson, May 7, 1838," in *Army and Navy Chronicle*, vol. 6, June 21, 1838, 393-394.

⁴³⁴ Birdsall of New York entered the Academy in 1818 and was commissioned as a second lieutenant in 1823. He was first appointed Assistant Commissary of subsistence in 1829. Gardner, *Dictionary of All Officers*, 69.

⁴³⁵ Regulations of the Subsistence Department, para. 2, in Barriger, *Legislative History of the Subsistence Department*, 73.

pay for any stores that became “damaged or unfit for issue” unless a cause other than his own neglect was found by a board of survey.⁴³⁶ Failure to make a thorough inspection would not excuse him if provisions were found later to be spoiled.

The barrel-by-barrel inspection was apparently not completely finished when Vose sent Gibson a preliminary estimate of the losses a week after the wreck:

The soap and candles are all saved and good—Beans totally lost—about 100 BBls Pork have been got out of the boat and will be saved good—The remainder is in the wreck, and may yet be saved should the water soon fall—From an examination of the flour it is not probable that much of it can be recd—Perhaps 50 barrels—It is all much more injured than was at first expected.⁴³⁷

Under the circumstances, Vose decided to send Birdsall to New Orleans to procure supplies from the Assistant Commissary at New Orleans Barracks or by purchasing them himself on the open market. He authorized Birdsall to purchase 400 barrels of flour, 150 barrels of pork, and 100 bushels of beans, or rice if beans were not available, and to replenish the post’s supply of sugar and coffee.

Birdsall left on May 14 aboard a steamboat (not named) that had just made the run from New Orleans to Fort Towson landing in only twelve days. The trip to New Orleans could be made in seven or eight days, barring accident, and the same steamboat planned to return immediately, presumably bringing the purchased supplies. Birdsall was expected to be gone about a month, and Lieutenant Smith was appointed Acting-Assistant Commissary until his return.⁴³⁸

⁴³⁶ Ibid., para. 6-7, 74.

⁴³⁷ Vose to Gibson, May 14, 1838, entry 10, box 46, record group 192, NARA.

⁴³⁸ Ibid.

News of the sinking reached Washington and Columbus in June, more than a month after the event. On June 11, Gibson acknowledged Vose's initial reports on the loss of subsistence stores and commended his quick action in sending Birdsall to New Orleans. The same day, Gibson forwarded to Niswanger and Sullivant a copy of Vose's report. He also informed them that he had received a receipt (from the Assistant Commissary) for the delivery on May 13 of fifteen barrels of pork and that Fletcher had endorsed a request for \$315 to pay Hord for freight charges.⁴³⁹ As the Subsistence Department did not have on file any record that Fletcher was authorized to draw on the Department for funds, Gibson requested instructions on the matter.

Niswanger received Fletcher's report of the sinking on June 14 and wrote at once to inform Gibson, and the communications from Washington and Columbus crossed in the mail. Fletcher's account of May 17, it would seem, was remarkably uninformative. "I am advised," wrote Niswanger:

...that the Boat Sunk Two miles below the Ft Towson Landing on 6th day of May the Flower[sic] and Beans only injured to what extent I am not advised—Some of the Pork was Still on the wreck, will be taken off when the river falls—I have no further information as to particulars. I infer the Troops at the Station will not Suffer for Supplies for the present—⁴⁴⁰

Surely by May 17 when he wrote to Niswanger, Fletcher should have had a better idea what the losses were likely to be.

⁴³⁹ At \$2.50 per barrel, \$315 would cover freight for 126 barrels—this may represent the number of barrels accepted by that date. Hord, too, would have been paid only for cargo delivered in sound condition. Vose seemed uncertain how much of the flour would pass inspection when he wrote to Gibson on May 14.

⁴⁴⁰ Niswanger to Gibson, June 14, 1838, entry 10, box 46, record group 192, NARA.

Vose's forwarded account of the sinking gave Niswanger a better picture of the extent of the disaster, and the picture was not good. "That we regret our Losses in the misfortune of our Boat Sinking Just at the Landing of Destination May be infered[sic]," he replied to Gibson. "We are happy however in the Idea that the officer at that Station having an oppertunity[sic] of supplying the Station"⁴⁴¹ Niswanger's agitation is evident in the deterioration of his spelling and punctuation and in the ink smears of hasty penmanship as he continued:

On the Subject of the order on your Dept Signed by J.E. Fletcher Our Suppercargo[sic] for \$315. In faviour[sic] of Capt J.R.Hord, we wish you not Except[sic]—nor any other order until further advice. Nor do we know Capt J.R. Hords address Col J.E. Fletcher was not authorized to draw on the Dept for funds But upon us at this place any Just claim due to Capt Hord will be promptly met here by us.⁴⁴²

The contractors would have to wait a month for more details.

Despite damage to many of the salvaged barrels, a considerable portion of the shipment passed inspection and was received at Fort Towson. Fletcher was issued three separate receipts for deliveries,⁴⁴³ the first on May 13 for fifteen barrels of pork, already mentioned. The remainder of the provisions salvaged from the wreck were accounted for in a second receipt dated May 20. In June, Fletcher made a further delivery of an unknown quantity of flour, salt, and pork.⁴⁴⁴ Where it was purchased and how much he paid are also unknown, but he was issued a third receipt on June 26. The total value of

⁴⁴¹ Niswanger to Gibson, June 17, 1838, *ibid.*

⁴⁴² *Ibid.*

⁴⁴³ Paul Hagmon, auditor, Third Auditor's office (Hagmon) to Albion K. Parris, Second Comptroller of the Treasury (Parris), March 13, 1839, entry 715 (Certificates of Settlement, 1817-1894), box 66, record group 217 (Records of the Accounting Officers of the Department of the Treasury), NARA.

⁴⁴⁴ Niswanger to Gibson, July 17, 1838, entry 10, box 46, record group 192, NARA.

the goods delivered under the contract was \$5,454.48, nearly half the contract's original value.

Birdsall returned from New Orleans sometime in June with 52 barrels of pork, 400 barrels of flour and 8 barrels (24 bushels) of beans as replacements for contract stores not delivered.⁴⁴⁵ Once these provisions were safely stowed in the commissary storehouse, Fort Towson was set for another year's subsistence.⁴⁴⁶ Birdsall's statements were duly forwarded to Gibson, and by the end of July, the Subsistence Department had all the documentation necessary for a preliminary settlement of Niswanger and Sullivant's account.

Niswanger and Sullivant finally received a payment in early August. The Treasury draft was accompanied by this explanation from Gibson:

Yours of 27th ult is received, with accounts for your deliveries in May & June last at Fort Towson, amounting to \$5454 [and] 48/100 of which Sum the Treasurer of the United States has this day been required to remit you \$4000; the residue will be reserved until the difference in the cost and transportation of the purchases made at New Orleans to supply your deficiencies is ascertained.⁴⁴⁷

⁴⁴⁵ Niswanger and Sullivant Statement, February 6, 1839, entry 58 (Blotters for Subsistence Accounts, 1819-1879), vol. 13, 11, record group 192, NARA. This statement was entered into the ledger nearly a month after it was issued—preceding and following entries are dated March 2.

⁴⁴⁶ Other supplies continued to arrive during that summer. In July, Vose acknowledged receipt of a shipment of clothing sent from Philadelphia the previous February. With the clothing was a flag (presumably the national flag) and halyard. This may well have been the flag requisitioned by Vose nearly three years before, in September, 1835. Also included in the shipment was a box containing six dozen bibles, evidently a gift from an unknown benefactor. Vose to Major-General Thomas Jesup, Quartermaster General, Washington, September 17, 1835, entry 225, box 1145, record group 92, NARA, and Vose to Callender Irvine, Esq., July 11, 1838, *ibid.*

⁴⁴⁷ Gibson to Niswanger, August 6, 1838, entry 1, vol. 15, 263, record group 192, NARA.

This outcome was unacceptable to Niswanger, who vigorously protested the retention of any part of the payment:

This course to us is very unexpected we were aware that our contract with the dept by a Strict verbal construction would autherise[sic] it—But from what we consive[sic] to be the Spirit & Tenor of that contract—from our intercourse with the department its usages and from the very peculiar nature of this case we did not Look for Such rigour[sic]—we are Sure that nothing on our part was left undone to fullfill[sic] the contract faithfully. After many houndred[sic] miles perlios[sic] navigation we were overtaken by this unfortunate accident within Sight of the Towson Landing.... we were deceived in the contract in the first place at best we Should have made nothing. as it is even with the \$1452.00 our Loss will be heavey[sic].⁴⁴⁸

He requested reconsideration of the case, pointing out that Fletcher had offered to go to New Orleans himself for supplies, but the offer was declined “in the belief that further requisition would not be made on us by the government.”⁴⁴⁹ None of these arguments carried any weight with the Department.

Gibson, evidently annoyed by this tirade, did not reply to Niswanger’s objections himself, instead delegating the task to his assistant, J.A. Hook. (Gibson himself had signed all previous correspondence with Niswanger and Sullivant.) Hook’s tone was coldly formal as he upheld the Department’s policies and addressed Niswanger’s suggestion of deceitful dealings by the Department. He regretted that monies were detained, but referred Niswanger to Section 5 of the contract. In withholding enough to cover the difference between the costs of replacements and the contract prices, he explained, the Commissary General was acting under the imperative advice of the

⁴⁴⁸ Niswanger to Gibson, August 18, 1838, entry 10, box 46, record group 192, NARA.

⁴⁴⁹ Ibid.

Second Comptroller of the Treasury, “who is the law office of the Government in settling accounts....This has been the invariable rule for years, and whatever may be our feelings of regret towards you, yet we have been constrained to do what has been done, by a sense of duty alone.”⁴⁵⁰ These are pointed comments in an era when regard for honor and duty was the mark of a gentleman.

Hook cited a similar case in 1827, when a whole cargo was lost within a quarter mile of its destination. Neither the Commissary General nor the Secretary of War had the power to make an exception to the rules, so the contractor had petitioned the U.S.

Congress:

...but Congress decided that he was not entitled to any relief from that body in as much as he could have effected insurance upon the vessel and cargo, and therefore could not view the United States as his underwriters.⁴⁵¹

In an earlier correspondence, Niswanger had stated that, “Insurance on Red River could not be had beyond Natchitoches at any price.”⁴⁵² It is probable that he had purchased insurance from underwriters in Cincinnati as far as Natchitoches, and instructed Fletcher to make inquiries locally once he had reached the Red River and to buy insurance for the remainder of the journey, if at all possible. In any case, none was found, and when *Heroine* rammed the fatal snag and river water poured into the hull, the cargo was not insured. Nevertheless, Hook’s letter made it quite clear that Niswanger

⁴⁵⁰ J.H. Hook, Assistant Commissary General of Subsistence, Washington, to Niswanger, August 22, 1838, entry 1, vol. 15, 293, record group 192, NARA.

⁴⁵¹ Ibid.

⁴⁵² Niswanger to Gibson, July 17, 1838, entry 10, box 46, record group 192, NARA.

and Sullivant should not expect special leniency from the government, however “special” the circumstances seemed to them.

The Subsistence Department’s final statement of the Niswanger and Sullivant contract was dated February 6, 1839.⁴⁵³ The details are presented in Chart V-2. Rows 1, 2, and 3 show the three items purchased by Birdsall in New Orleans with both the New Orleans price and the contract price. Note that Birdsall paid less than the contract price for both flour and beans, resulting in a “credit” to the contractors. The cost of the actual provisions was somewhat lower than the contract price, but then transportation costs were added. The monies retained the previous summer *almost* covered the damages—Niswanger and Sullivant were left owing the government \$81.52.⁴⁵⁴

The Subsistence Department’s statement along with the relevant documents was forwarded to the Treasury Department for review. On March 13, Third Auditor Paul Hagmon issued a statement summarized in Chart V-3.⁴⁵⁵ Hagmon made a slight adjustment to the calculation of the penalty, which resulted in Niswanger owing the

⁴⁵³ Niswanger and Sullivant Statement, February 6, 1839, entry 58, vol. 13, 11, record group 192, NARA. The reason it took the Department so long to prepare the statement is suggested by a letter from Gibson to Niswanger and Sullivant the previous October. Apparently, Niswanger had submitted a duplicate receipt for pork delivered in May. Gibson had requested clarification on the matter from Birdsall. However the error occurred, it would have been at least two months before he received a response. Gibson to Niswanger, October 15, 1838, entry 1, vol. 15, 414, record group 192, NARA.

⁴⁵⁴ The entry at Row 4 is rather perplexing on several counts. First, the difference between the contract and purchase prices per barrel of pork should be \$3 not \$4, an apparent error favoring the government by inflating the losses. However, Birdsall paid *more* than the contract price for pork, so the difference should have been entered as a loss against the contractors, not in their favor as was done. But the most puzzling aspect is why the entry “52 Bar. Pork @4\$ per difference in value between the contract pork and that purchased at New Orleans” appears in the statement at all. The government’s “loss” on the pork of \$156 was accounted for in Row 1, so where did this adjustment come from? Whatever the explanation, it does not seem to have been considered an error by the Treasury auditors.

⁴⁵⁵ Hagmon to Parris, March 13, 1839, entry 715, box 66, record group 217, NARA.

government \$84.34. The statement and the accompanying vouchers were sent to Albion K. Parris, Second Comptroller of the Treasury, who certified the adjusted balance on March 14, 1839.⁴⁵⁶

Table V-2 Subsistence Department Statement of Niswanger and Sullivant's Account and Calculation of Damages to Government⁴⁵⁷

| | | Birdsall's Cost per unit | Total | Contract Cost per unit | Total | <i>Differences Applied to N&S</i> | |
|--|-------------------------------|--------------------------------|----------|------------------------------|----------|---|-------------------|
| | | | | | | <i>Deficit</i> | <i>Credit</i> |
| 1 | 52 bbl pork | 24.00 | | 21.00 | | | |
| | | | 1,248.00 | | 1,092.00 | <i>156.00</i> | |
| 2 | 400 bbl flour | 7.75 | | 9.50 | | | |
| | | | 3,100.00 | | 3,800.00 | | <i>700.00</i> |
| 3 | 24 bu beans (8 bbl) | 3.00 | | 3.50 | | | |
| | | | 72.00 | | 84.00 | | <i>12.00</i> |
| 4 | 52 bbl pork @\$4 pr * | | | | | | <i>208.00</i> |
| 5 | Transportation for 460 bbl | 5.00 | 2,300 | | | <i>2,300</i> | |
| | | | | | | <i>2456.00</i> | <i>920.00</i> |
| *Difference in value between contract and Birdsall's purchase **\$5454.48 was due contractors for provisions delivered. \$4,000 was paid in August, 1838, and \$1,454.48 was retained and applied toward damages. <i>Figures added by author in italics.</i> | | | | | | <i>1536.00</i> <i>Damages</i> | <i>1,454.48**</i> |
| | | | | | | balance due 81.52 | |

⁴⁵⁶ Ibid.

⁴⁵⁷ Niswanger and Sullivant Statement, February 6, 1839, entry 58, vol. 13, 11, record group 192, NARA.

Table V-3 Third Auditor's Statement of Niswanger and Sullivant's Account

| | | <i>Deficit</i> | <i>Credit to N&S</i> |
|---|---|----------------|--------------------------|
| 1 | Credit for provisions delivered May and June 1837 | | 5454.48 |
| 2 | Payment made to N&S August 1838 | 4,000.00 | |
| 3 | Penalty | 1,538.82 | |
| 4 | Total | 5,538.82 | 5454.48 |
| 5 | Balance due to U.S. | 84.34 | |

Niswanger and Sullivant turned to their congressman for redress.⁴⁵⁸ In May 1840, Representative Joseph Ridgway of Ohio presented on behalf of Christopher Niswanger and William S. Sullivant a memorial stating that:

...in the year 1837, they contracted with the Commissary General of Subsistence, to deliver certain supplies at Fort Towson, that the boat on which they were shipped sunk before reaching the place of destination, and a part of the articles were lost; that they have received a part only of the value of the provisions actually delivered, and therefore pray for a payment of the balance with interest.⁴⁵⁹

The contractors hoped to recover the \$1,454.48 that had been retained by the Treasury from the payment they had received in August 1838. "With interest" suggests they also desired vindication of the justice of their claim. The petition was referred to the Committee of Claims. That committee seems to have been reluctant to address the

⁴⁵⁸ The penalty was actually somewhat less than it could have been. Birdsall had been authorized to purchase 150 barrels of pork and 100 bushels of beans. Had he purchased the full amount, the penalty would have been close to \$2,500.

⁴⁵⁹ *Journal of the House of Representatives*, 1st Session, 26th Congress, vol. 34, 940.

petition. It was presented again in December 1841,⁴⁶⁰ in December 1844,⁴⁶¹ in January 1852,⁴⁶² and in December 1853.⁴⁶³ Finally, in December 1856, Representative Samuel Galloway of Ohio motioned for the withdrawal from the House files of the papers pertaining to Niswanger and Sullivant's case, for the purpose of referring the case to the newly established United States Court of Claims.⁴⁶⁴ Galloway received the papers, but there is no record that the case was ever brought to that court.⁴⁶⁵

There is nothing to suggest that Niswanger and Sullivant's contract was handled in any way outside the legal and procedural parameters established by the Subsistence Department or the U.S. Treasury. Any citizen, though, has a right to petition Congress for redress of grievances whether or not he actually has a viable case. Succeeding generations of congressmen were quite willing to accommodate the prominent Sullivants. The evident "loss" of the relevant papers en route to the Court of Claims may have been a face-saving way of allowing the issue quietly to expire.

⁴⁶⁰ *Ibid.*, 2nd Session, 26th Congress, vol. 35, 167.

⁴⁶¹ *Ibid.*, 2nd Session, 28th Congress, vol. 40, 141-142.

⁴⁶² *Ibid.*, 1st Session, 32nd Congress, vol. 47, 288.

⁴⁶³ *Ibid.*, 1st Session, 33rd Congress, vol. 49, 98-99.

⁴⁶⁴ *Ibid.*, 3rd Session, 34th Congress, vol. 53, 156.

⁴⁶⁵ Email communication from NARA Archivist Robert Ellis to Nina Chick, February 3, 2010. With those papers would have been Vose's original report dated May 7, 1838. Among the records of the Subsistence Department is preserved an empty envelope with the tantalizing annotation, "Lt Col JH Vose Fort Towson May 7 1838 [document no] 2870. Relative to loss of Steam Boat with supplies of Subs. Original referred to 3 Auditor." Vose to Gibson, May 7, 1838, entry 10, box 46, record group 192, NARA. The full text of Vose's report would have been an invaluable aid to the present research. Fortunately, some passages were excerpted in *The Army and Navy Chronicle*, vol.6, June 21, 1838, 393-394.

AFTERWARD

Even while *Heroine* was approaching the end of its journey, negotiations were underway to end the border dispute. In April 1838, representatives from the Texas and the United States agreed on a convention for marking their mutual boundary that was ratified in October.⁴⁶⁶ It called for a survey of the border from the Gulf of Mexico to the Red River, which would be accomplished in 1840-1841.⁴⁶⁷ Meanwhile, according to Article II of the convention, “each of the contracting parties shall continue to exercise jurisdiction in all territory over which its jurisdiction has hitherto been exercised” without interference from the other. Texas effectively annexed the area south of the Red River in 1838. The U.S. post office at Miller Courthouse was closed in December, and Miller County, Arkansas, was abolished.⁴⁶⁸

The old town of Jonesborough no longer exists. Though incorporated by the Texas Congress in 1837, the town declined after losing its position as county seat to Clarksville the same year. The same great flood that shifted the river channel and buried *Heroine* in 1843 severely damaged its buildings and left their ruins a mile from the river.⁴⁶⁹

⁴⁶⁶ “Convention between the United States of America and the Republic of Texas for marking the boundary between them. Concluded April 25, 1838. Ratifications Exchanged October 12, 1838; Proclaimed October 13, 1838,” United States State Department, *Treaties and Conventions*, 835.

⁴⁶⁷ “Boundaries,” *Handbook of Texas Online*.

⁴⁶⁸ Baker, “Old Miller County, Arkansas,” 348. Connor, “Miller County, Arkansas.” Miller County, Arkansas, was reestablished from part of Lafayette County in 1874 with Texarkana as county seat. “Boundaries,” *Handbook of Texas Online*.

⁴⁶⁹ Strickland, “Jonesborough, TX,” *Handbook of Texas Online*.

The garrison at Fort Towson continued to perform its missions of protecting the Choctaw Indians and guarding the international border with Texas. Shreve's channel through the Great Raft was a source of optimism about the coming of civilization and progress. Vose anticipated reduced passage times and lower freight rates. He had it from a local steamboat captain, he reported to Gibson, that soon "the navigation for Steam Boats to our landing will be as good as it is to Fort Gibson [on the Arkansas River]."⁴⁷⁰ "Last year," he continued, "freight from N[ew] Orleans to our landing was 7\$ per BBL—It is already reduced to 5\$, and I think in the course of 2 years it will come down to 3\$!!"

His enthusiasm was a bit premature. The Raft may have been opened to steamboat traffic, but keeping it open was a constant endeavor that went on for decades. And there was still the Red River to be overcome. The 1839 delivery of subsistence stores was delayed once again. This time, a keelboat carrying a part of the shipment was snagged and sunk near the head of the Raft with loss of 150 barrels of flour and almost all of the beans.⁴⁷¹

In 1842, the Assistant Quartermaster expressed his frustration with supplies shipped to Fort Towson in steamboats that were too large to make the passage in low water. He recommended that the Quartermaster Department should procure a "strong light draft *iron Boat*" [italics added] to be commanded by an Army officer. If allowed to

⁴⁷⁰ Vose to Gibson, April 21, 1838, entry 225, box 1145, record group 92, NARA.

⁴⁷¹ Lieutenant Josiah H. Vose, Jr., Assistant Commissary at Fort Towson (Vose, Jr.), to Gibson, May 13, 1839, entry 10, box 50, record group 192, NARA.

carry private freights when not in use by the department, as he suggested, such a vessel could probably have paid for itself. Nothing came of this suggestion.

The Men Most Closely Involved with *Heroine* and Its Cargo

Hord lost his boat, and it is unlikely it was insured for the upper Red River. His payment from Niswanger and Sullivant amounted to \$315 for those stores officially received by the Assistant Commissary at Fort Towson.⁴⁷² *Heroine*'s engine and some other machinery were salvaged and transported to New Orleans, and Hord probably recovered part of his loss from their sale. He seems to have recovered quickly from this loss, though, and eventually acquired a small fleet of steamboats to carry livestock and other freight along the Red River and to New Orleans.⁴⁷³

Lieutenant Colonel Josiah H. Vose's duty as commander of Fort Towson ended in the summer of 1839 when he was assigned as superintendent of the recruiting service in New York.⁴⁷⁴ By October 1842, now a full Colonel, he was in Florida at Cedar Keys, writing to Gibson that the schooner bringing subsistence stores from Baltimore had been delayed by storm, much of cargo was severely damaged, and urgently requesting additional supplies to be sent as soon as possible.⁴⁷⁵

⁴⁷² Gibson to Niswanger, June 11, 1838, entry 1, vol. 15, 167, record group 192, NARA. Niswanger to Gibson, June 17, 1838, entry 10, box 46, record group 192, NARA.

⁴⁷³ Crisman, Chick, and Davis, "Shipwrecked in Oklahoma," 287, 293, note 27.

⁴⁷⁴ *Army and Navy Chronicle*, vol. 8, June 27, 1839, 416.

⁴⁷⁵ Vose to Gibson, October 8, 18, 1842, entry 10, box 67, record group 192, NARA.

Second Lieutenant Josiah H. Vose, Jr., took over the position of Assistant Commissary from recently promoted Captain Egbert B. Birdsall in January 1839,⁴⁷⁶ and was promoted to First Lieutenant in December.⁴⁷⁷ Both young officers were sent to Florida in the Second Seminole campaign. Vose, Jr., contracted one of the many diseases that plagued the troops in that climate. He was evacuated to New York, where he died in June 1841.⁴⁷⁸ Birdsall died at St. Augustine, Florida, in March 1845.⁴⁷⁹

Colonel Vose was commander of New Orleans Barracks at the time of his death in July 1845. While drilling the regiment on parade, he suddenly became ill. He turned the parade over to a subordinate and returned to his quarters, where he collapsed and died of a heart attack.⁴⁸⁰ He was buried in the cemetery attached to the garrison, with the expectation that his remains would be exhumed the following winter to be taken north for permanent burial.⁴⁸¹ He was reinterred near his son in their hometown of Milton, Massachusetts.⁴⁸²

Major-General George Gibson headed the Subsistence Department for forty-three years until his death in office in 1861 at age eighty-six, the oldest serving officer in the Army. He was honored with a large and elaborate military funeral attended by President Lincoln and many other prominent citizens.⁴⁸³

⁴⁷⁶ Vose, Jr. to Gibson, January 18, 1839, entry 10, box 50, record group 192, NARA.

⁴⁷⁷ Gardner, *Dictionary of All Officers*, 463.

⁴⁷⁸ *Ibid.*

⁴⁷⁹ *Ibid.*, 69.

⁴⁸⁰ *Jeffersonian Republican*, July 17, 1845.

⁴⁸¹ *Ibid.*

⁴⁸² Teele, *History of Milton*, 447.

⁴⁸³ U.S. Army Quartermaster Foundation, "Colonel George Gibson."

Christopher Niswanger died in 1852, several years before Representative Galloway removed the papers relating to the claim against the Subsistence Department from Congressional files. The cause of death was given as dropsy, a serious edema that might have been caused by heart disease, liver failure, or any number of other ailments.⁴⁸⁴

Though still active in business, by the late 1830s, William S. Sullivant was devoting more and more time to the study of botany. Aided and encouraged by his young wife Eliza, he discovered his passion for bryology, the study of mosses. By the time of his death in 1873, he was recognized in scientific circles worldwide as the leading authority on North American mosses.⁴⁸⁵

Jonathan Emerson Fletcher, the supercargo on *Heroine*'s last voyage, moved to the new Iowa Territory in the summer of 1838. He became one of the founding fathers of the state of Iowa and was a member of the state's constitutional convention. He also served as agent of the U.S. government with the Winnebago Indians.⁴⁸⁶

CONCLUSION

The story of *Heroine*'s last cargo involved a diverse and widely scattered cast of characters in addition to those mentioned above. They included the soldiers who needed the subsistence supplies and the Indians they were tasked to protect, bureaucrats in Washington who oversaw the running of the supply system, and entrepreneurs who bid

⁴⁸⁴ Green Lawn Cemetery, family lots, interment 285, Green Lawn Cemetery interment cards, ca. 1820-1981. Franklin County Genealogical Society, roll number 81-15, Ohio Historical Society, OHS.

⁴⁸⁵ Rodgers, *Noble Fellow*, 105-110, 287.

⁴⁸⁶ Crisman, Chick, and Davis, "Shipwrecked in Oklahoma," 287.

on Army contracts. Then there were the farmers, pork packers, soap and candle makers, and salt workers whose products the Army required, and the inspectors whose mark was an assurance of quality. Transporting supplies from where they were produced or purchased to their ultimate destination was the work not only of riverboat men, but of hog drovers, carters, and freight handlers at levees along the rivers. Not least, though unnamed and generally forgotten, are the coopers who converted abundant forest resources into essential containers for foodstuffs and other goods. Fulfillment of the twelve contracts in the 1837 announcement alone required over 11,000 barrels.

This historical study of *Heroine*'s cargo has highlighted the experiences of Lieutenant Colonel Vose and the soldiers of Fort Towson and of the contractors Niswanger and Sullivant in particular. The overarching finding of this study is this: The Army's response to the loss of *Heroine*'s cargo provides a detailed case study of the workings of Gibson's Commissariat of Subsistence. Birdsall's timely visit to New Orleans for replacement supplies, for example, assured that Vose could attend to the demands of his mission with relatively little distraction on account of the wreck. The inflexibility of the government in dealing with Niswanger and Sullivant over their failure to fulfill the contract is understandable in light of past abuses of the military provisioning system.

In the early 1830s, Fort Towson was beyond the edge of American "civilization," but by 1842, in response to the westward movement of American settlement, Fort Washita was established farther up the Red River. During the Mexican-American War (1846-1847), Fort Towson was a major staging point for troop movements, but soon it

was considered obsolete as a frontier fort. The post was abandoned by the Army in 1854 and the property turned over to the Choctaw Nation. It is now an Oklahoma State Park.

Other posts were established along the nation's southwest borders, among them Forts Duncan and Bliss along the Rio Grande River in 1849 and Fort Buchanan, Arizona, in 1856. Farther west, Fort Yuma protected emigrants along the southern overland route to California.⁴⁸⁷ Just as the need to supply Fort Towson provided the impetus for clearing a channel through the Great Raft of the Red River, finding a cost-effective supply route to Fort Yuma in the 1850s stimulated the opening of the lower Colorado River to steamboat operations.⁴⁸⁸ But that is another story.

⁴⁸⁷ Hart, *Old Forts of the Far West*, 57.

⁴⁸⁸ Frajola, "Steamboat Mail on the Colorado River, 34-35.

REFERENCES

Primary Sources

Manuscript Sources

National Archives Building, Washington, DC, Record Group 92 (Records of the Office of the Quartermaster General, 1774-1985), Entry 225-Consolidated Correspondence, 1794-1890, Fort Towson Box 1145.

---, Record Group 217 (Records of the Accounting Officers of the Department of the Treasury), Entry 715-Certificates of Settlement, 1817-1894.

---, Record Group 192 (Records of the Commissary General of Subsistence, 1818-1912), Entry 1-Letters Sent, 1818-1889; Entry 10-Letters Received, 1828-1887; Entry 36- Provision Books, 1833-1881; Entry 58-Blotters for Subsistence Accounts, 1819-1879; Entry 66-List of Proposals for Subsistence Contracts, 1819-1841; Entry 76-Contracts, 1825-1853.

---, Record Group 393 (Records of the United States Army Continental Commands, 1821-1920), Entry 14-Letters Received 05, 1834-1841.

Ohio Historical Society Archives/Library, Columbus, OH, General Records of the Governor, 1818-1856.

---, Franklin County Genealogical Society, Green Lawn Cemetery interment cards, ca. 1820-1981.

Printed Primary Sources

American Almanac and Repository of Useful Knowledge for the Year 1843. Boston: David W. Williams, 1842.
http://play.google.com/books/reader?id=ldATAAAAYAAJ&printsec=frontcover&output=reader&authuser=0&hl=en_US.

American Almanac and Repository of Useful Knowledge for the Year 1844. Boston: David W. Williams, 1843.
http://play.google.com/books/reader?id=hq80AAAAMAAJ&printsec=frontcover&output=reader&authuser=0&hl=en_US.

- Army and Navy Chronicle*, n.s., Vol. 6, January 1-June 30, 1838. Edited by Benjamin Homans. Washington: B. Homans, 1838.
- Army and Navy Chronicle*, n.s., Vol. 8, January 1-June 30, 1839. Edited by Benjamin Homans. Washington: B. Homans, 1839.
- Chase, Salmon P. ed. *The Statutes of Ohio and of the Northwestern Territory, Adopted or Enacted from 1788 to 1833 Inclusive: Together with the Ordinance of 1787; the Constitutions of Ohio and of the United States and Various Public Instruments and Acts of Congress*. Cincinnati: Corey & Fairbank, 1835.
- Cincinnati Daily Gazette*, February 23, 26, March 2, 6, 1838.
- Critchfield, Leander J. *Reports of Cases Argued and Determined in the Supreme Court of Ohio*, n.s., Vol. 11. Cincinnati: Robert Clarke & Co., 1874.
- Croghan, George. *Army Life on the Western Frontier: Selections from the Official Reports Made Between 1826 and 1845 by Colonel George Croghan*. Edited by Francis Paul Prucha. Norman: University of Oklahoma Press, 1958.
- Cross, Truman, comp. *Military Laws of the United States: Including Those Relating to the Marine Corps, To Which Is Prefixed the Constitution of the United States*. 2d ed. Washington: George Templeman, 1838.
<http://google.com/books?id=QNYvAAAAYAAJ>.
- Jeffersonian Republican* (New Orleans), July 17, 1845.
- Journal of the House of Representatives of the United States, Being the First Session of the Twenty-Sixth Congress, December 2, 1839*, Vol. 34. Washington: Blair and Rives, 1840. See also *Journals* of the 26th Congress, 2nd Session, Vol. 35. Washington: Blair and Rives, 1841; the 28th Congress, 2nd Session, Vol. 40. Washington: Blair and Rives, 1844-1845; the 32nd Congress, 1st Session, Vol. 47. Washington: A. Boyd Hamilton, 1851-1852; the 33rd Congress, 1st Session, Vol. 49. Washington: Robert Armstrong, 1853; the 34th Congress, 3rd Session, Vol. 53. Washington: Cornelius Wendell, 1856.
- Office of the Commissary General of Subsistence, "Separate Proposals will be received..." July 1, 1837. *New Orleans Bee*, July 15, 1837.
- United States Congress, House of Representatives, *The Executive Documents, 27th Congress, 3rd Session, Document Number 219*. Washington: Government Printing Office, 1843.

United States State Department. *Treaties and conventions concluded between the United States of America and other powers, since July 4, 1776*. Washington: Government Printing Office, 1871.

United States War Department. *General Regulations for the Army; or, Military Institutes*. Compiled by Major-General Scott. Philadelphia: M. Carey and Sons, 1821. <http://google.com/books?id=hQtLAAAAYAAJ>.

United States War Department. *General Regulations for the Army of the United States: Also the Rules and Articles of War, and Extracts from Laws Relating to Them*. Revised by Major-General Alexander Macomb. Washington: Globe, 1835. <https://archive.org/stream/0255003.nlm.nih.gov/0255003#page/n0/mode/2up>.

Withenbury, Wellington W. "Red River Reminiscences," *Cincinnati Commercial*, January 8, 1871, 3.

Withenbury, Wellington W. *Captain W.W. Withenbury's 1838-1842 Red River Reminiscences*. Edited by Jacques D. Bagur. Denton: University of North Texas Press, 2014.

Secondary Sources

Arms, Richard G. "From Disassembly to Assembly: Cincinnati, the Birthplace of Mass Production." *Bulletin of the Historical and Philosophical Society of Ohio* 17 (1959): 195-203.

Atherton, Lewis E. *The Frontier Merchant in Mid-America*. Columbia: University of Missouri Press, 1971.

Baker, Russell P. "Old Miller County, Arkansas." *Arkansas Historical Quarterly* 42 (Winter 1983): 346-348.

Barriger, John W. *Legislative History of the Subsistence Department of the United States Army from June 16, 1775, to August 15, 1876*, 2d ed. Washington: Government Printing Office, 1876. Facsimile. Ithaca, New York: Cornell University Library, 32/U Lib., 2010.

Bell, J. H. *The Nautical Instructor: a Compendium of Practical Navigation*. London: H. Hughes, 1865. <https://play.google.com/store/search?q=the+nautical+instructor&c+books>.

Berry, Thomas S. *Western Prices before 1861: A Study of the Cincinnati Market*, Harvard Economic Studies, Vol. 74. Cambridge: Harvard University Press, 1943)

- Biddlecombe, George. *The Art of Rigging, Containing an Explanation of Terms and Phrases and the Progressive Method of Rigging Expressly Adapted for Sailing Ships*. Salem, Massachusetts: Marine Research Society, 1925. Reprinted by Dover Publications, Inc. Mineola, New York, 1990.
- “Boundaries,” *Handbook of Texas Online*. Austin: Texas State Historical Association. Uploaded on June 12, 2010.
<http://www.tshaonline.org/handbook/online/articles/mgb02>.
- Brady, William. *The Kedge-Anchor: or Young Sailors' Assistant*. 4th ed. New York: published by author, 1849. Reprinted by Dover Publications, Inc. Mineola, New York, 2002.
- Connor, Seymour. “Miller County, Arkansas.” *Handbook of Texas Online*. Austin: Texas State Historical Association. Uploaded June 15, 2010.
<http://www.tshaonline.org/handbook/online/articles/hcm91>.
- Cooling, Benjamin F., ed. *The New American State Papers, Military Affairs*, Vol. 8, Combat Operations. Wilmington, Delaware: Scholarly Resources, 1979.
- “The Cooper’s Chamfer Knife,” *The Chronicle of the Early American Industries Association* 18 no. 3 (September 1965): 40-41.
- Coyne, Franklin E. *The Development of the Cooperage Industry in the United States, 1620-1940*. Chicago: Lumber Buyers Publishing Company, 1940.
- Crisman, Kevin. “The *Heroine* of the Red River.” *INA Quarterly* 32, no. 2 (Summer 2005): 3-10.
- Crisman, Kevin, and Heather Brown. “News from the Red River: A Mid-Season Update on the Steamboat *Heroine*.” *INA Quarterly* 32, no. 4 (Winter 2005): 3-6.
- Crisman, Kevin, Nina Chick, and John Davis. “Shipwrecked in Oklahoma: The last voyage of the steamboat *Heroine*, 1838.” *Chronicles of Oklahoma* 91, no. 3 (Fall 2013): 260-295.
- Crisman, Kevin, William B. Lees, and John Davis, “The western river steamboat *Heroine*, 1832-1838, Oklahoma, USA: Excavations, summary of finds, and history.” *International Journal of Nautical Archaeology* 42, no. 2 (September 2013): 365–381.
- Donovan, Frank. *River Boats of America*. New York: Thomas Y. Crowell, 1966.
- Foreman, Grant. *Advancing the Frontier, 1830-1860*. Norman: University of Oklahoma Press, 1933, second printing 1968.

- Frajola, Richard. "Steamboat mail on the Colorado River." *Chronicle* (Philatelic Classics Society), 61, no. 1 (February 2009): 33-36.
- Frazer, Robert W. *Forts of the West: Military Forts and Presidios and Posts Commonly Called Forts West of the Mississippi River to 1898*. Norman: University of Oklahoma Press, 1965.
- Gamble, Richard Dalzell. "Garrison Life at Frontier Military Posts, 1830-1860." PhD diss., University of Oklahoma, 1956.
- Gardner, Charles K. *A Dictionary of All Officers, Who have been Commissioned, or Have Been Appointed and Serve, in the Army of the United States*. New York: G.P. Putnam, 1853.
- Gordon, Steve C. "From slaughterhouse to soap-boiler: Cincinnati's meat packing industry, changing technologies, and the rise of mass production 1825-1870." *The Journal of the Society for Industrial Archeology* 16, no. 1 (1990): 55-67.
- Gwin, James M. "An Economic and Historical Study of Food Procurement for the Armed Forces of the United States." PhD diss., Cornell University, 1949.
- Haines, Ethel. "The handmade barrel hoop." *The Chronicle of the Early American Industries Association* 3, no. 6,7 (January and April 1946): 60.
- Hankerson, Fred P. *The Cooperage Handbook*. Brooklyn: Chemical Publishing Co., 1947.
- Hart, Herbert M. *Old Forts of the Far West*. Seattle: Superior Publishing, 1965.
- Hurt, R. Douglas. "Pork and Porkopolis." *Cincinnati Historical Society Bulletin* 40 (Fall 1982): 191-215.
- Kilby, Kenneth. *The Cooper and His Trade*. London: J. Baker, 1971; Fresno, CA: Linden Pub., 1989.
- Lever, Darcy. *The Young Sea Officer's Sheet Anchor: or a Key to the Leading of Rigging and to Practical Seamanship*. 2nd ed. London: J. Richardson, 1819. Reprinted by Dover Publications, Inc. Mineola, New York, 1998.
- Littlefield, Daniel F., and Mary Ann Littlefield. "The Beams Family: Free Blacks in Indian Territory." *Journal of Negro History* 16, no. 1 (January 1976): 16-35.
- Lyford, W.G. *The Western Address Directory: Containing the Cards of Merchants, Manufacturers, and other Business Men...together with Historical, Topographical, & Statistical Sketches, for the Year 1837*. Baltimore: Jos. Robinson, 1837.

- Minnesota Historical Society. "The map, the map-maker Joseph E. Heckle, and the map's owner, Josiah H. Vose." Accessed January 13, 2012. <http://www.mnhs.org/places/sites/hfs/map/vose.html> (page discontinued).
- National Oceanic and Atmospheric Administration. *Distances between United States Ports*. 12th ed. Washington: National Oceanic and Atmospheric Administration, 2012. <http://www.nauticalcharts.noaa.gov/nsd/distances-ports/distances.pdf>.
- "Noah H. Swayne," *Ohio History Central*, (Ohio History Connection). Accessed July 30, 2014. http://www.ohiohistorycentral.org/w/Noah_H._Swayne.
- Prescott, Samuel C. *A Survey of Rationing and Subsistence in the United States Army 1775 to 1940*. Final Report on Troop Feeding Programs, Service Directive QMC-23. Washington: National Defense Research Committee of the Office of Scientific Research and Development, 1944.
- Reed, Thomas and Co. *Reed's Seamanship: Compiled for Candidates Preparing to Pass the Marine Board Examinations for Certificates of Competency as Mates and Masters*. 12th ed. Sunderland, England: Thomas Reed, 1881. <https://play.google.com/store/search?q=reed%27s+seamanship+and+young+mariner%27s+guide&c=books>.
- Riegel, Robert E. *Young America 1830-1840*. Norman: University of Oklahoma Press, 1949.
- Rodgers, Andrew Denny. *Noble Fellow William Starling Sullivant*. New York: G. P. Putnam's Sons, 1940.
- Ross, Lester A. *Sixteenth Century Spanish Basque Coopering Technology: A Report of the Staved Containers Found in 1978-79 on the Wreck of the Whaling Galleon San Juan, Sunk in Red Bay, Labrador, AD 1565*. Manuscript Report Series No. 408. Ottawa: Parks Canada, 1980.
- Seymour, John. *The Forgotten Crafts*. New York: Alfred A. Knopf, 1984.
- Shagena, Jack. *An Illustrated History of the Barrel in America*. Privately printed, 2006. Library of Congress No. 2005911068; ISBN 0-9776866-0-4.
- Sprague, William B. "The Cooper." *The Chronicle of the Early American Industries Association* 2 no. 5 (June 1938): 33, 35-36, 38. Reprinted May 1956, Vol. 9(2) 16-17,19-20,24.

- Stevens, Robert White. *On the Stowage of Ships and their Cargoes: With Information Regarding Freights, Charter-Parties, &c. &c.* London: Longmans, Green, Reader, & Dyer; Plymouth: R White Stevens, 1858.
<https://play.google.com/store/search?q=on+the+stowage+of+ships+and+their+cargoes&c=books>.
- Strickland, Rex W. "Jonesborough, TX." *Handbook of Texas Online*. Austin: Texas State Historical Association. Uploaded June 15, 2010.
<http://www.tshaonline.org/handbook/online/articles/hvj16>.
- Tate, Michael L. *The Frontier Army in the Settlement of the West*. Norman: University of Oklahoma Press, 1999.
- Teele, Albert K., ed. *The History of Milton, Mass., 1640-1887*. Boston: Rockwell and Churchill, 1887.
https://openlibrary.org/books/OL7208677M/The_history_of_Milton_Mass._1640_to_1877.
- Twain, Mark. *Life on the Mississippi*. Boston: James R. Osgood, 1883. Documenting the American South, University Library, The University of North Carolina at Chapel Hill, 2004. <http://docsouth.unc.edu/southlit/twainlife/>.
- Twede, Diana. "The cask age: The technology and history of wooden barrels." *Packing Technology and Science* 18 (2005): 253-264.
- U.S. Army Quartermaster Foundation, Ft. Lee, Virginia. "Colonel George Gibson, 11th Quartermaster General, April 1816-April 1818." Last modified September 2, 2008. http://www.qmfound.com/COL_George_Gibson.htm.
- Walsh, James I. "Capacity and gauge standards for barrels and casks of early America." *Chronicle of the Early American Industries Association* 52, no. 4 (1999): 151-154.
- Walsh, Margaret. *The Rise of the Midwestern Meat Packing Industry*. Lexington: University Press of Kentucky, 1982.
- Woodruff, Edward, Ebenezer Hinman, and Henry B. Funk, eds. *An Act Incorporating the City of Cincinnati, and a Digest of the Ordinances of Said City of a General Nature, Now in Force*. By order of the City Council. Cincinnati: Lodge, L'Hommedieu and Co., 1835.
- Woodruff, J.H. *The Cincinnati Directory Advertiser for the Year 1836-7*. Cincinnati: J.H. Woodruff, 1836.

Young, Arthur. *Nautical Dictionary: Defining the Technical Language Relative to the Building and Equipment of Sailing Vessels and Steamers, Seamanship, Navigation, Nautical Astronomy*. London: Longman, Green, Longman, Roberts, & Green, 1863.
<https://play.google.com/store/search?q=arthur+young+nautical+dictionary&c=books>

APPENDIX: CATALOG OF CARGO-RELATED ARTIFACTS

THE ASSEMBLAGE

The cargo-related artifacts recorded here include remains of the barrels that contained subsistence supplies for Fort Towson: over 200 staves and head pieces, hundreds of pieces of wooden hoops, and numerous iron nails used to secure the hoops and heads. Cargo-related faunal remains include the contents of three pork barrels brought up more or less intact (meat, tallow, and bones) and some pork bones scattered around inside the steamboat's hull. Artifacts used for handling cargo are also listed here: a cotton dolly, a wheeled hand-cart, and a variety of hooks and thimbles. For the sake of simplicity, all the hooks found on *Heroine* are included. In addition, the complete soap box and some iron hoops are included, though they are evidently not related to the Army cargo or any other known cargo.

ARCHAEOLOGICAL CONTEXT

Heroine's port side struck the fatal snag about 17 ft (5.2 m) aft of the forward compartment bulkhead. The force of the collision tore a gash over 20 ft (6 m) long, allowing water to pour into the hold. As the steamboat came to rest on the river bottom, it was listing somewhat to port. The river being low, however, the superstructure and the starboard side of the hold remained above water. Rising waters a few days after the sinking forced a halt to salvage efforts, but not before most of the cargo and was

removed. By the time the flood abated, *Heroine*'s hull had filled with silt, and the steamboat was abandoned. Several years later, the great flood of 1843 changed the course of the Red River, and *Heroine*, by then stripped of its superstructure, was buried and lost.

EXCAVATION

Heroine was rediscovered in 1999 after another flood returned the river to its earlier course. The wreck was excavated between 2001 and 2006. The primary tools for excavation were 4 in (10 cm) dredges. The excavators uncovered a hull that lay tilted to port and was hogged, broken, and twisted. The mid-portion of the hull, which is defined by the sister keelsons and the cylinder timbers, lay higher than both bow and stern. The last 40 ft (12.2 m) of the stern twisted sharply to port. Opposite the point at which the snag had first pierced the hull, the frame tops and planking separated from the sheer to the turn of the bilge. The river current was able to flow into the wreck through the starboard side and out through the great gash on the port, at least until the hold filled with silt and debris. A similar crack in the hull was discovered on the starboard side just aft of the cylinder timbers. River water flowed in through this crack and out over the port quarter where some planking was missing. These breeches in the hull created diagonal swaths across the wreck that appeared swept clean of lighter artifacts, though littered with wash-in debris (Figure A-1).

There were at least two hatches large enough for barrels to pass through, a forward hatch 5 ft 9 in (1.8 m) square and a slightly larger hatch aft.⁴⁸⁹ Salvagers in 1838 accessed cargo through both hatches. Their efforts, perhaps augmented by river currents, had apparently removed the cargo from the starboard hull and roughly two thirds of the port hull before the water rose. Divers found most of the barrels and barrel components in the *Heroine* collection in two “caches” in the port side of the hull. One was located about 20 ft (6.1 m) forward of the stern compartment bulkhead, while the other began roughly midships working aft. There is an area of the port side hull about 15 ft (4.6 m) long between the two “caches” that remains unsalvaged and unexcavated. Smaller groups of barrels and barrel parts were also found just forward of the snag hole in the forward area on the port side of the hull and near the stern compartment bulkhead, also on the port side. These two areas were apparently where some barrels that had been damaged when *Heroine* was wrecked were cast aside out of the workers’ way.

PROVENIENCE

Two systems are used to enter the proveniences into the catalog of artifacts. One is a system of grid coordinates—a grid of 1 yd (0.91 m) squares having the zero line along the keel. Numbers increased from forward to aft and from the keel either port or starboard. A designation of “35P1” places an artifact 35 yd (32 m) aft and within 1 yd (0.91 m) port of the centerline (Figure A-2).

⁴⁸⁹ Other smaller hatches gave access to the forward and stern compartments which were separated from the main hold by bulkheads.

Not every object could be plotted so precisely, particularly the ones brought up through the dredges. A second system (Figure A-1) divides *Heroine*'s plan longitudinally into port (p) and starboard (s) halves, then athwartships into several general areas: the bow compartment (BC), three sections of the main hold—forward (HF), mid-ship (HM), and aft (HA)—and the stern compartment (SC). The letter (o), for outboard, places an object outside the hull. In this system, the provenience of an object dredged from the forward area of the hold on the starboard side would be HFs (Hold Forward starboard). That of an artifact found outside the hull near the port paddlewheel would be HMpo (Hold Mid-ship port outboard). Artifacts with grid coordinates are also assigned general area codes. In the listings, proveniences in parentheses, such as (25P2) /HMp, should be considered as probable but not confirmed.

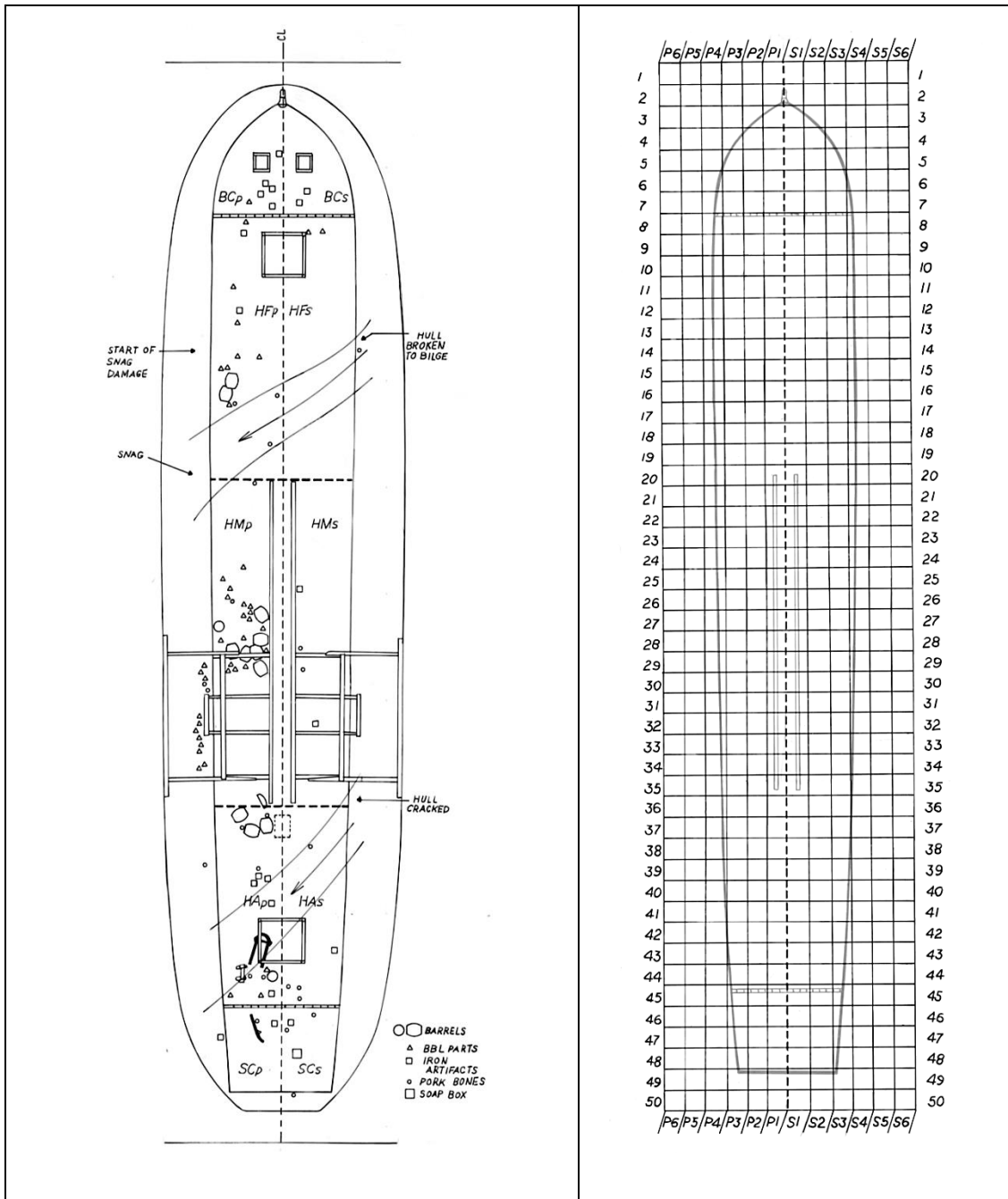

Figure A-1. Plan of *Heroine* Showing Distribution of Cargo-related Artifacts. Barrels, cotton dolly, and hand cart are approximate scale. Hoop fragment distribution not shown. Figure also shows provenience area sections. (Illustration by author, adapted from plan by Kevin Crisman)

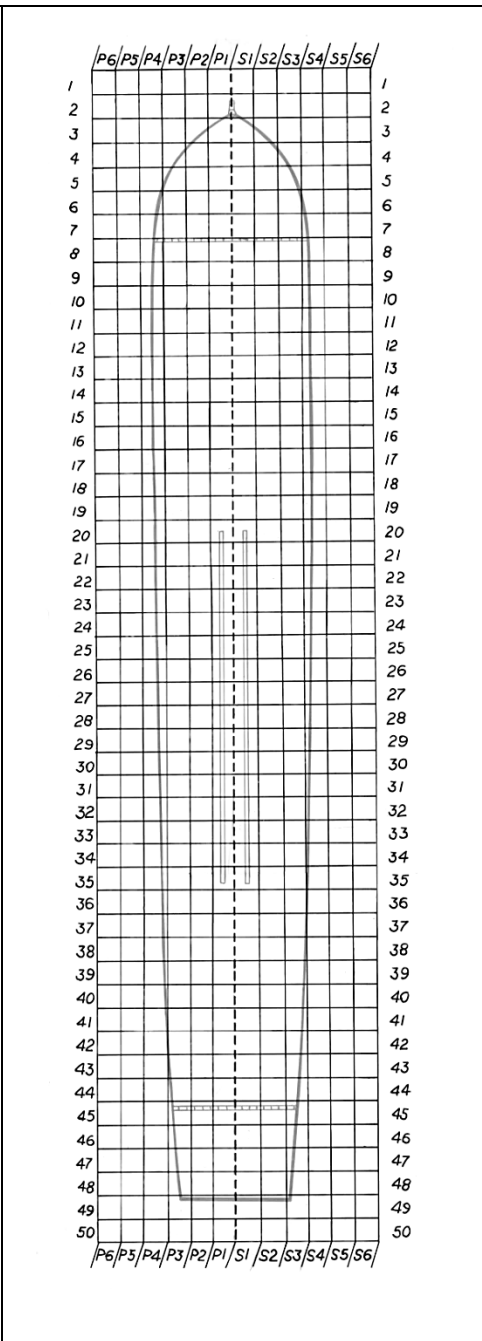

Figure A-2. Provenience Grid (Illustration by author)

ARTIFACT NUMBERING

The artifact number is unique for each artifact or set of artifacts recovered together. The first two digits indicate the predominant material of which the artifact is composed: 01 for stone and brick, 02 for wood, 03 for metals, 04 for leather, 05 for glass and ceramics, and 06 for other organics (including bone)⁴⁹⁰. Nineteen barrels were identified during the study of the assemblage, some complete and others represented by a few or even a single stave. These barrels are indicated with Roman numerals. Some of them were identified as Barrel Features (BFs) in situ and assigned BF numbers along with artifact numbers. Others of the nineteen are composed of staves that were excavated separately but reunited during the study. Barrel, BF, and artifact numbers are all included as appropriate.

MEASURES

All linear measurements are in inches to the nearest 1/8 in (0.32 cm) except for croze width and depth, and hoop width and thickness, which are to the nearest 1/16 in (0.16 cm). With those exceptions, all fractions of an inch are recorded as eighths—1/8, 2/8, 3/8, and so on.

Additionally:

- Wood identification is by Leslie L. Bush, Ph.D., R.P.A., Macrobotanical Analysis, 12388 Twin Creeks Rd., B-104, Manchaca, TX 78652.

⁴⁹⁰ Not all the materials are represented in this catalog.

- Bone identification for Barrel I (06-035), Barrel VI (06-472), and Barrel XVI (06-740) from Brophy, Juliet and Kevin Crisman, “Taphonomic Evaluation of Three Intact Pork Barrels from the Steamboat *Heroine* (1838)” *Historical Archaeology*, 18, No. 4 (2013): 71-85.
- Photographs are from the project files.
- Drawings are by the author unless otherwise indicated.

THE CATALOG

C. Cargo Related Artifacts

C.1. Cargo Handling Equipment

C.1.1. Hooks

| | | |
|---|-------------------------|--|
| 03-006 | Hook and Thimble |  |
| | Provenience: (HA) | |
| Length: 6 in (15.2 cm) Width: 2 2/8 in (5.7 cm) | | |
| Material: iron Length is total for hook and thimble. The two pieces appear to have been welded together. | | |



-

| | | |
|---|------------------|---|
| 03-101 | Hook |  |
| | Provenience: HAp | |
| Length: 7 in (17.8 cm) | | |
| Material: iron Shaft is square in cross-section, transforming to round in curve of hook. | | |

-

| | | |
|--|------------------|----------------|
| 03-140 | Thimble | |
| | Provenience: HAp | |
| Diameter: 3 6/8 in (9.5 cm) Width: 1 4/8 in (3.8 cm) | | Material: iron |

-

| | | |
|---|--|---|
| 03-150, 03-280 | Can Hoist [Cant Hook] with Thimble, 2 hooks Provenience: 03-150 44S1/SCs; 03-280 43P1 or 43S1/SC |  |
| <p>03-150—Hook Length: 8 4/8 (20.8 cm) Max Width: 6 in (14.7 cm) Thickness near eye of hook: 0.6 in (1.7 cm) Thimble diameter: 3 2/8 (8.9 cm) 03-280—(measurements not available, but similar to 03-150) 06-280—Length of attached rope: 16 4.8 in (40.4 cm)</p>  | | |

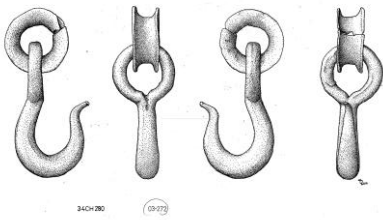
| | | |
|---|--|---|
| 03-272 | Hook and Thimble Provenience: 44P1/SCp |  |
| Maximum length of hook and thimble: 6 6/8 in (17.2 cm) Cross-section near base of hook: 6/8 in (1.9 cm) Thimble: Outer diameter: 2 4/8 in (6.4 cm) Inner diameter: 1 2/8 in (3.2 cm) | | |
| Material: iron | | |
| Drawing by Helen C. Dewolf | | |
| | | |

| | | |
|--|---|---|
| 03-319 | Hook Fragment Provenience: 40P1/HAp |  |
| Length: 3 5/8 in (8.8 cm) Diameter at break: 7/8 in (2.2 cm) | | |
| Material: iron | | |

| | | |
|--|---|---|
| 03-403 | Large Hook Provenience: 46P3/SCpo |  |
| Hook: Length: 6 4/8 in (16.5 cm) Cross-section at bottom of hook: 1 6/8 in (4.5 cm) Thimble: Outside diameter: 3 3/8 in (8.6 cm) | | |
| Material: iron Associated with double-sheaved block 02-404 Found on guard port of stern compartment | | |

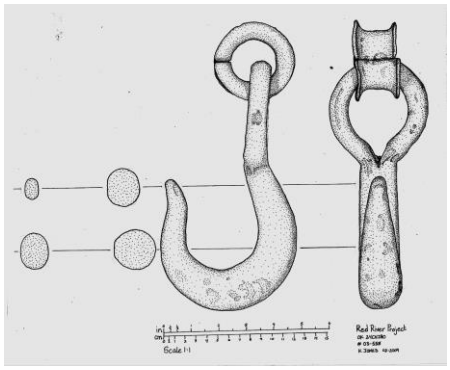
| | | |
|---|---|--|
| 03-558 06-559 | Hook and Thimble Rope from Thimble |  |
| | Provenience: 34P6/HAp0 | |
| Hook: Length: 8 7/8 in (22.5 cm) Thimble: Outer diameter: 2 7/8 in (7.3 cm) Rope: Length ~3 in (7.4 cm) Diam. 7/8 in (2 cm) | | |
| Material: iron Rope not shown Found near port paddle-wheel | | |
| Drawing by Heather Jones | | |

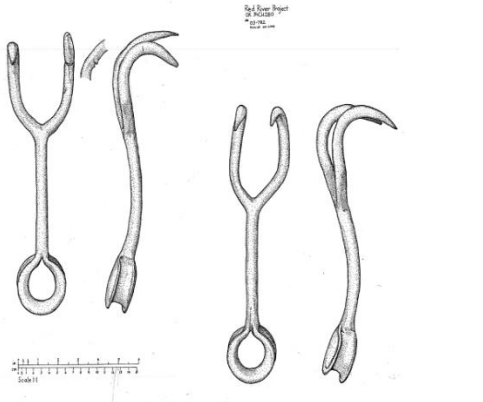
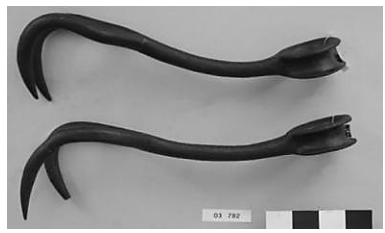
| | | |
|--|----------------------|---|
| 03-782 | Bale Hooks, 2 |  |
| | Provenience: 8P2/HFp | |
| Length: ~11 4/8 in (28.2 cm) | | |
| Material: iron | | |
|  | | |

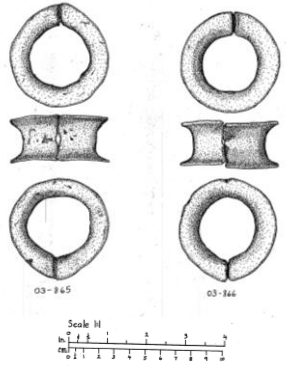

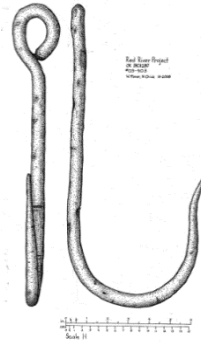

| | | |
|---|---|---|
| 03-854, 03-865 03-866 | Thimbles |  |
| | Provenience: 03-854 BC; 03-865 BCp; 03-866 (BC) | |
| 03-854—Diameter: 3 4/8 in (8.9 cm) Width: 3 5/8 in (9.2 cm) 03-865—Diameter: 3 1/8 in (7.9 cm) Width: 2 7/8 in (7.3 cm) 03-866—Diameter: 3 1/8 in (7.9 cm) Width: 2 7/8 in (7.3 cm) | | |
| Material: iron [03-854 not shown] | | |
| Drawing by William Moser and Nina Chick | | |

| | | |
|---|-------------------------|---|
| 03-903 | Large Hook |  |
| | Provenience: 5S1-5P1/BC | |
| Length: 14 4/8 in (35.5 cm) Cross-section: 5/8 in (1.6 cm) | | |
| Material: iron Found in bow compartment with coils of rope | | |

| | | |
|---|--------------------------------------|--|
| 03-1272 | Hook and Chain |  |
| | Provenience: NP (found by landowner) | |
| Hook: Length: 5 in (12.7 cm) Cross-section front to back: 4/8 in (1.3 cm) Large link: Length: 2 6/8 in (7 cm) Width: 1 7/8 in (4.8 cm) Small links: Length: 1 7/8 in (4.8 cm) Width: 1 in (2.5 cm) | | |
| Material: iron Hook is rectangular in section | | |

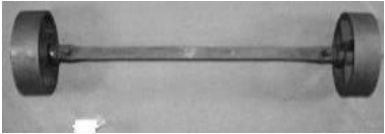
| | | |
|--|--------------------|--|
| 03-1383 | Cargo Hook |  |
| | Provenience: (HMs) | |
| Length: 18 in (45.7 cm) | | |
| Material: iron Hook is offset to one side from the shaft. | | |

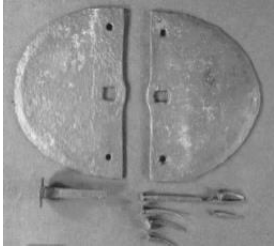
C.1.2. Handcarts

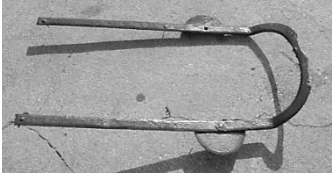

| | | |
|--|--|---|
| 03-142 02-189 | Cotton Dolly Provenience: 03-142 40P1-41P2/HAp; 03-189 46P1/SCp | |
| <p>03-142: Overall height: 71 in (180.3 cm) Width at “ears”: 31 in (79 cm) The iron “tongue” is 45 in (104 cm) in height, its iron 2 in (5.1 cm) wide and 4/8 in (1.3 cm) thick. Wooden uprights, 2 x 4 in (5.1 x 10.2 cm), comprised of multiple pieces are attached to underside of tongue, but single-piece handles extend ~30 in (76 cm) above tongue. Handles are 2 in (5.1 cm) in diameter and 21 in (53.3 cm) apart. Iron “ears” 6 in (15.2 cm) attach to tongue over wheels. Wheels are 7 4/8 in (19 cm) in diameter, 2 in (5.1 cm) wide, and 3/8 in (1 cm) thick. The 28-in (71-cm) axle extends 3/8 in (1 cm) beyond the wheels and is secured with pins. Wood piece 18 4/8 x 3 4/8 x 2 in (47 x 8.9 x 5.1 cm) found unattached but associated with dolly is branded J.WALTER. Crosspiece (02-189) is 22 3/8 in (58.8 cm) long, 2 5/8 in (6.7 cm) wide, and 1 4/8 in (3.8 cm) thick. A metal plate, 3 2/8 x 1 2/8 in (8.3 x 3.2 cm), nailed to crosspiece, is embossed with J.WALTER MAKER.</p> | | |
|  |  |  |
|  |  |  |
|  |  | |
| <p>Photo-shopped images courtesy of Carolyn Kennedy.</p> | | |

| | | |
|---|--|---|
| <p>03-309 02-343 02-345</p> | <p>Handcart Provenience: 03-309 42P2/HAp; 02-343 45P1-44P2/SCp; 02-345 45P1/SCp</p> | |
| <p>03-309 Overall height (with handle refitted): ~66 in (167.7 cm). Width at axle: 24 in (61 cm). Iron “tongue” is 18 in (45.7 cm) high and 19 in (48.3 cm) wide. Iron is 2 in (5.1 cm) wide at uprights and 2 6/8 in (7 cm) wide around the end. Small “ears” are bolted to tongue at wheels. Tongue uprights are backed with wood pieces 3 in (7.6 cm) thick, and an iron frame. Iron bolts 8 in (20.3 cm) long pass through the tongue assembly and attach to the axle. Axle is 1 in (2.5 cm) square in section. XII is etched on one face. Wheels are 10 in (25.4 cm) diameter, and 2 6/8 in (7 cm) wide. Wooden handle (02-343) is 48 4/8 in (123.2 cm) long. A 6-in (15.2 cm) V-shaped iron brace is bolted to underside 18 in (45.7 cm) from handle end. Handles were evidently scarfed to the tongue assembly. Wooden crosspiece (02-345), incomplete, 8 x 2 in (20.3 x 5.1 cm).</p> | | |
| <p>Evidently broken before wreck as the metal wheel assembly (03-309) was found in the far aft portion of the hold while one wooden handle (02-343) and a wooden cross piece (02-345) were found in the stern compartment. Wheels also showed signs of attempted repair. Handcart could stand upright or lie horizontal with the upper portion resting on triangular braces attached to the handles.</p> | | |
|  |  |  |
|  |  |  |
|  |  |  |
|  |  | |
| <p>Photo-shopped images courtesy of Carolyn Kennedy.</p> | | |

C.2. Containers

C.2.1. Barrels and Barrel Components

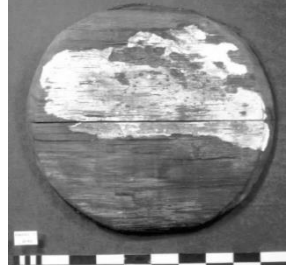
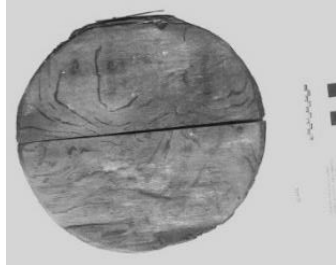
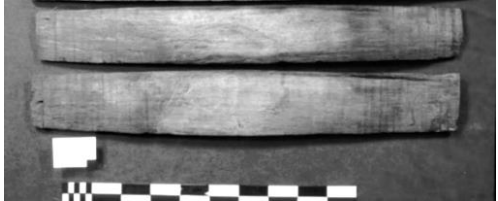
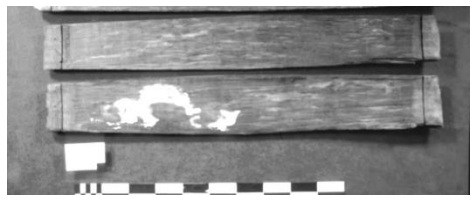
C.2.1.1 Barrel Features

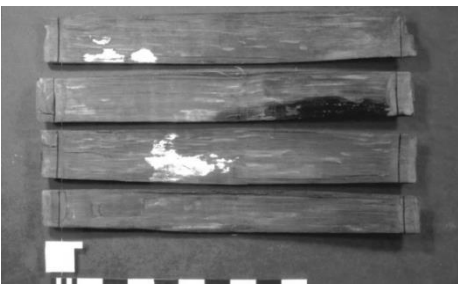
| | | |
|--|---|---|
| <p>02-031, 02-033, 02-034</p> | <p>Barrel I Pork, 2 two-piece heads; 6 staves; pork bones (06-035); tallow sample (06-036), BF1-01</p> | |
| <p>Provenience: 35P1/HAp</p> | | |
| <p>Staves: Length: 29 in (71.1 cm) Length between crozes: 26 4/8 in (64.9 cm) Width: 2 7/8 to 3 6/8 in (7 to 9.2 cm) Thickness: not available. [Measurements were taken from photographs]</p> | | |
| <p>Heads: Doweled. Faint traces of assembly arcs. No other markings evident. 02-034 has 2 sets of 2 pin-holes in oval depressions ~4/8 x 1 in (1.3 x 2.5 cm). Staves: Full-hooped. Croze from end: 1 4/8 in (3.8 cm) Traces of tallow remain on heads and some staves.</p> | | |
| <p>02-033 exterior</p>  | <p>02-033 interior</p>  | <p>02-034 exterior</p>  |
|  | |  |
|  | |  |

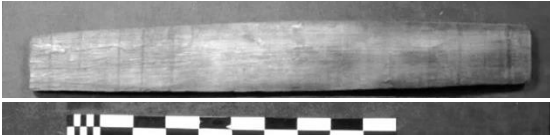
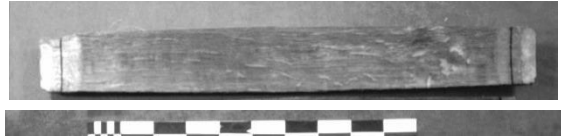
| | |
|--|--|
| 02-032 | Barrel II Pork (possible), 1 Stave |
| Provenience: 35P1/HAp | |
| Length: 30 in (73.5 cm) Length between crozes: 27 2/8 in (66.8 cm) Width: 3 4/8 in (8.6 cm) Thickness: not available | |
| Condition good. Full-hooped. Croze from end: 1 4/8 (3.7 cm) This stave was recovered with six staves from Barrel I (BF1-01), but is 1 in (2.5 cm) longer than they are. | |
|  |  |

| | |
|---|--|
| 02-149 | Barrel III Flour, 1 two-piece head; 22 staves; hoop fragments, BF1 03 |
| | Provenience: 42P1/HAp |
| <p>Head: Original diameter: 17 4/8 in (42.9 cm) A and B: Length: 16 7/8 and 15 5/8 in (41.3 and 38.3 cm) Width: 8 5/8 and 6 6/8 in (21.1 and 16.5 cm) Thickness: 4/8 and 3/8 in (1.2 and 1 cm) Staves: Length: 27 1/8 in (66.5 cm) Length between crozes: 25 5/8 in (62.6 cm) Width: 2 to 3 6/8 in (4.9 to 9.2 cm) Thickness: 4/8 in (1.2 cm)</p> | |
| <p>Condition poor to fair. Head: Compass point hole on A. Sharp bite. Exterior bevel 1/8 in (0.3 cm) Interior bevel 2/8 in (0.6cm). Sapwood present on A and B. Staves: Croze 1/8 in (0.3 cm) square. 1 each head-reinforcing nail and hoop nail in place on staves, both with 3/16 in (0.5 cm) diameter shafts. Sapwood present on 12 of 22 staves. Woods: Stave: <i>Quercus</i> subg. <i>Quercus</i> (Oak, white group); Hoop: <i>Carya</i> sp., true (Hickory).</p> | |
| | |

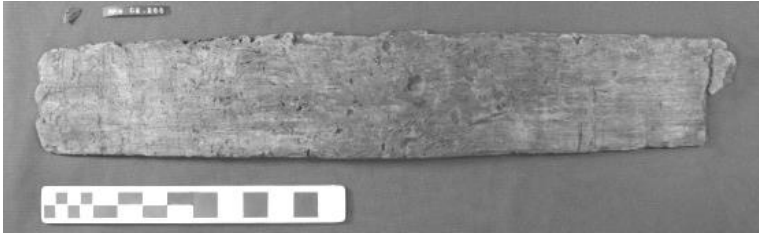
| | |
|--|---|
| 02-286 | Barrel IV Pork (probable), 1 stave |
| | Provenience: 43P3/HAp |
| Length: 27 6/8 in (68 cm) Length between crozes: 25 2/8 in (61.9 cm) Width: 5 in (12.3 cm) Thickness: 4/8 in (1.2 cm) | |
| Condition poor. Much worm/insect damage. Retains lateral arch. Croze worn from use and erosion, but originally 1/8 in (0.3 cm) square. Probably full-hooped. | |
| Wood: Quercus subg. Quercus (Oak, white group) | |
|  | |

| | |
|--|---|
| 02-463 | Barrel V Pork, 1 two-piece head; 9 staves; pork bones (06-463), BF1-04 |
| | Provenience: 35P2/HAp |
| Head: Original diameter: 17 4/8 in (42.9 cm) A and B: Length: 16 7/8 and 17 in (41.3 and 41.7 cm) Width: 7 3/8 and 9 2/8 in (18.1 and 22.7 cm) Thickness: 6/8 in (1.8 cm) Staves: Length: 29 6/8 in (72.9 cm) Length between crozes: 26 7/8 in (65.8 cm) Width at Bilge: 3 6/8 to 4 6/8 in (9.2 to 11.6 cm) Thickness: 6/8 in (1.8 cm) | |
| Head: Condition good. Very sturdy head pieces. Doweled. Two assembly arcs. Compass point hole. Exterior bevel 3/8 in (1 cm) Interior bevel 5/8 (1.6 cm). Staves: Condition good. Full hooped, 16 hoops total. Some bevel ends very well preserved. Bevels hollow. Croze 1/8 in (0.3 cm) square. Stave 7 shown. | |

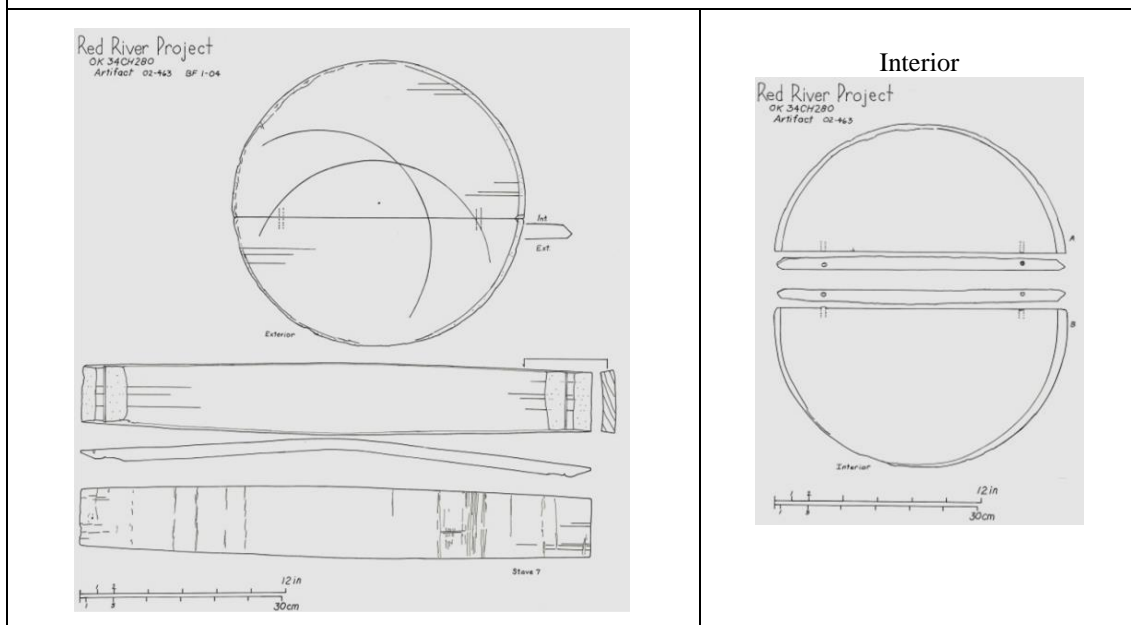

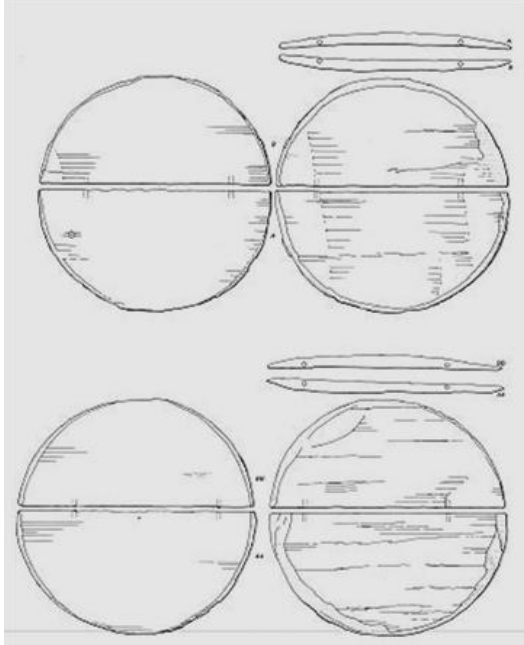
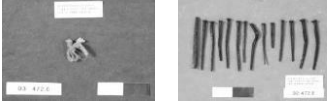
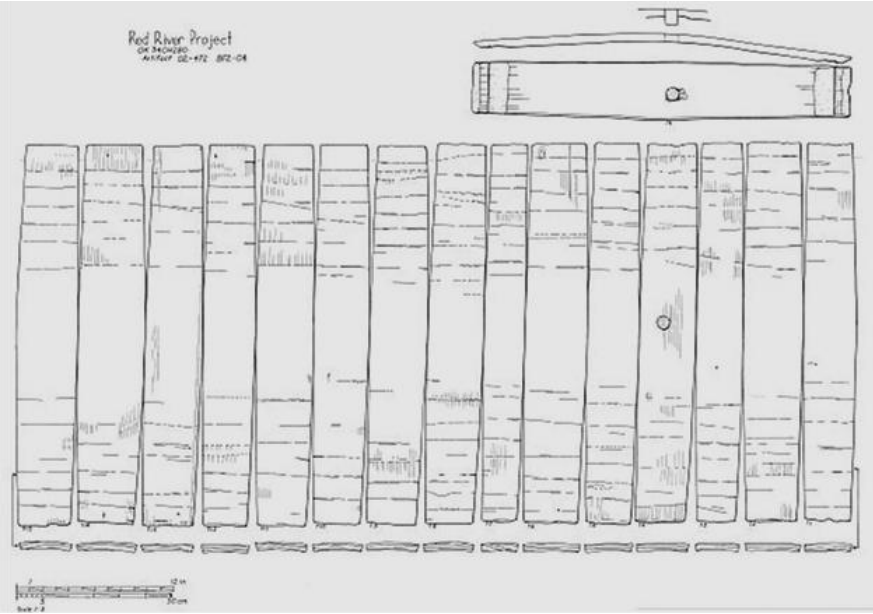

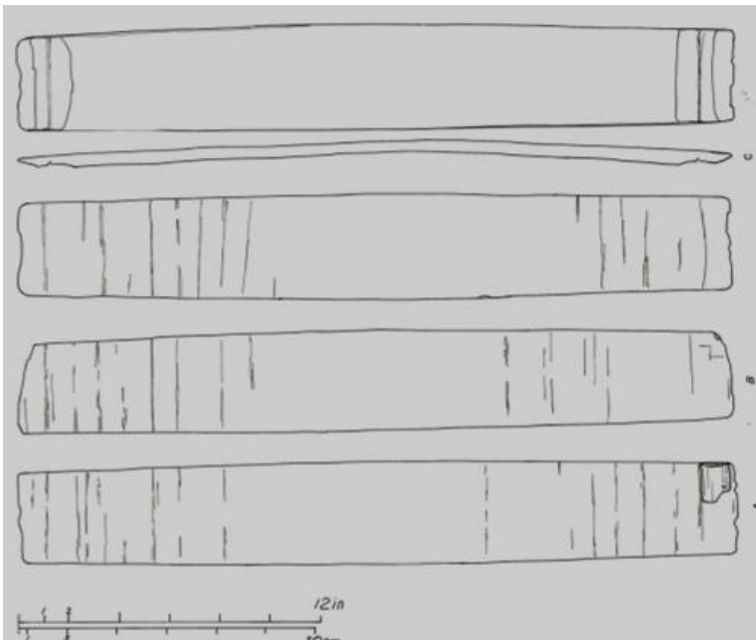

| | |
|--|---|
| 02-472 | Barrel VI Pork, 2 two-piece heads; 15 staves; hoop fragments; pork bones (06-472), BF2-04 |
| | Provenience: 35P2-34P2/Hap |
| <p>Heads: Original diameters: AB: 17 2/8 in (42.3 cm) AABB: 17 4/8 in (42.9 cm) A and B: Length: 17 in (41.7 cm) Width: 8 7/8 and 7 7/8 in (21.7 and 19.3 cm) Thickness: 7/8 in (2.1 cm) AA and BB: Length: 17 4/8 and 17 2/8 in (42.9 and 42.3 cm) Width: 8 7/8 and 7 7/8 in (21.7 and 19.3 cm) Thickness: 7/8 in (2.1 cm) Staves: Length: 29 2/8 in (71.7 cm) Length between crozes: 26 4/8 in (64.9 cm) Width at Bilge: 3 1/8 to 5 1/8 in (7.7 to 12.6 cm) Thickness: 5/8 in (1.5 cm) Stave Bung: Exterior diameter: 1 in (2.5 cm) Interior diameter: 7/9 in (2.1 cm) Length: 1 2/8 in (3.1 cm)</p> |  |
| <p>Heads: Condition good. Joints are doweled. Compass point hole on BB. Possible “thief hole” on A from tool used to lift heads when opening barrel. Axed interior shaping on AA suggests the two halves were not originally constructed together. Very robust heads. Exterior bevel 3/8 in (1 cm) Interior bevel 6/8 in (1.9 cm). Staves: full hooped. Croze 1/8 in (0.3 cm) square. Croze from end 1 4/8 in (3.8 cm). Woods: Stave T13 Quercus subg. Quercus (Oak, white group); Bung: Pinus sp. (Pine) Hoop: Carya sp., true (Hickory)</p> |  |
| |  |

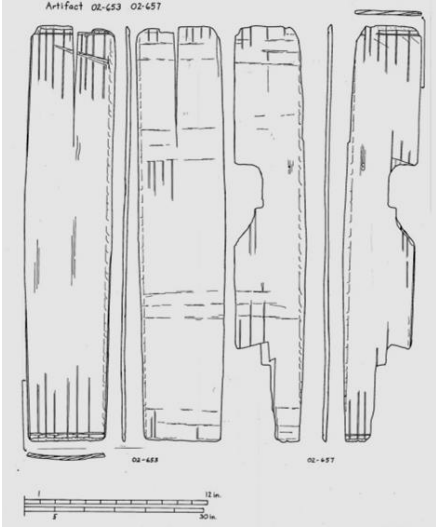
| | |
|--|--|
| 02-480 | Barrel VII Pork (probable), 3 staves; hoop fragments, BF3-04 |
| | Provenience: 34P1/HAp |
| Length: 28 4/8 in (69.8 cm) Length between crozes: 25 6/8 in (63.1 cm) Width: 3 7/8 to 4 2/8 in (9.5 to 10.4 cm) Thickness: 5/8 in (1.5 cm) | |
| <p>Condition good. Full hooped, 17 hoops total. Crozes 1/8 in (0.3 cm) square. Croze from end 1 3/8 in (3.5 cm). Several hoop pieces up to 9 in (22.1 cm) long were recovered. Ends were tapered but no notches evident. Hoops were 1 to 1 2/8 in (2.5 to 3.1 cm) wide and were nailed in place. Possible winch rope scar 5 2/8 in (12.9 cm) from end of staves. Wood: Hoop (3 samples, 1 still adhering to stave when found) <i>Carya</i> sp., true (Hickory). Stave <i>Quercus</i> subg. <i>Quercus</i>, (White oak)</p> |  <p>Note hoop nails still in place.</p> |
|  | |

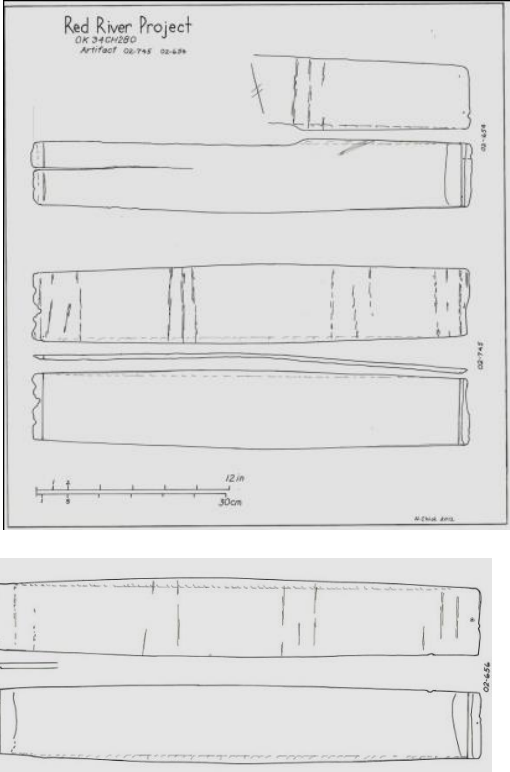
| | |
|---|---|
| 02-634 | Barrel VIII Type unknown, 1 stave |
| | Provenience: 31P3/HMp |
| Length: 26 4/8 in (64.9 cm) Length between crozes: 24 6/8 in (60.6 cm) Width at bilge: 3 2/8 in (8 cm) Thickness: 3/8 in (1 cm) | |
| <p>Condition poor. Smaller than most of the barrels. Large head reinforcing nail hole above croze, driven from exterior down toward head. Croze from end 6/8 in (1.9 cm) Croze 1/8 in (0.3 cm) square. Wood: <i>Quercus</i> subg. <i>Quercus</i> (Oak, white group)</p> |  |

| | | |
|---|--|--|
| 02-653, 02-657 | Barrel IX (Bean), 2 staves Provenience: 28P3/HMp |  |
| Length: 27 2/8 in (66.8 cm) Length between crozes: 26 1/8 in (64 cm) Thickness: 2/8 in (0.6 cm) 02-653—Width: 4 6/8 in (11.6 cm) 02-657—Width: 5 6/8 in (14.1 cm) | | |
| Condition fair and poor. Very slight, wide staves. Croze 1/16 in (0.2 cm) scratch. Croze from end about 4/8 in (1.2 cm). Partial hooped. Sapwood present on both staves. No or very slight chivs. Wood: Stave (02-653) Quercus subg. Lobatae (Oak, red group) | | |

| | | |
|--|--|---|
| 02-654, 02-656, 02-745 | Barrel X (Bean), 3 staves Provenience: 02-654 and 02-656 28P3/HMp; 02-745 (25P2)/HMp |  |
| Length: 27 1/8 in (66.5 cm) Length between crozes: 25 7/8 in (63.4 cm) 02-654—Width: 4 4/8 in (11 cm) Thickness: 2.8 in (0.6 cm) 02-656—Width: 4 2/8 in (10.4 cm) Thickness: 3/8 in (1 cm) 02-745—Width: 4 7/8 in (11.9 cm) Thickness: 2/8 in (0.6 cm) | | |
| Condition good to fair. Croze 1/16 in (0.2 cm) scratch. 02-656 and 02-654 have head nail holes above croze driven down toward head. Partial hooped. Hoop impressions are suggest 3 hoops at the chimes and 2 at the bilges, for total of 10 hoops on the barrel. Sapwood present on all staves. Wood: stave (02-656) Quercus subg. Quercus (Oak, white group) | | |

| | | |
|--|---|---|
| 02-659, | Barrel XI Flour (probable), 2 staves | |
| 02-746 | Provenience: 25P2/HMp | |
| Length: ~26 in (63.7 cm) Length between crozes: 25 2/8 in (61.9 cm) Thickness: 3/8 in (1 cm) 02-659—Width: 3 6/8 in (9.2 cm) 02-746—Width: 4 5/8 in (11.3 cm) | | |
| <p>Condition fair. Croze 1/16 in (0.2 cm) scratch. Croze from end 6/8 in (1.9 cm). Partial hooped. Both staves have large hoop nail holes that pierce the stave. 02-746 has large head nail hole above croze, and beside it a smaller hoop nail hole that angles sharply from exterior toward end.</p> | |  <p data-bbox="1138 699 1219 730">02-746</p> |
|  |  <p data-bbox="971 674 1008 695">FION AHOMA</p> | |

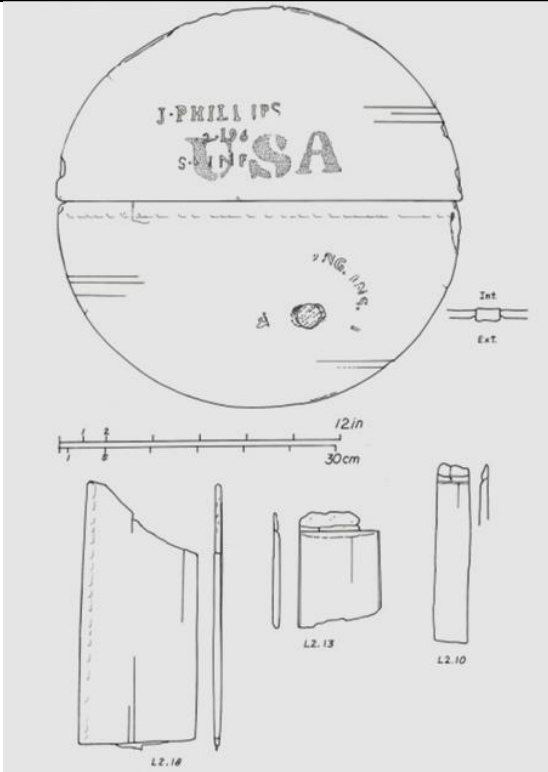
| | |
|---|---|
| 02-685 | Barrel XII Flour, 1 two-piece head; 20 fragments from at least 2 staves, BF2-05 |
| Provenience: 26P1-25P1/HM | |
| <p>Head: Original diameter: 17 4/8 in (42.9 cm) A and B: Length: 17 2/8 and 17 in (42.3 and 41.7 cm) Width: 8 2/8 and 8 7/8 in (20.2 and 21.7 cm) Thickness: 3/8 in (1 cm) Staves: Width at Bilge: 2 4/8 to 4 7/8 in (6.1 to 11.9 cm) Thickness: 3/8 in (1 cm) Bung: Diameter: 1 in (2.5 cm) Length: 1 in (2.5 cm)</p> <p>Head: Condition good. Flour merchant's brand: J.PHILLIPS .2.196 S.FINE Flour inspector's brand: <u>E.A.R. ONG.INS H</u></p> <p>Visible in field photo, stencil painted USA Sharp bite. Exterior bevel 1/8 in (0.3 cm). Bung is round, tapering slightly toward interior, but bung hole is 1 4/8 in (3.7 cm) oval on exterior.</p> <p>Sapwood present on B. Staves seem very slight for flour bbl and may represent different bbl from head or may be evidence of reuse of head. Sapwood present on several fragments.</p> <p>Woods: Stave: Quercus subg. Lobatae (Oak, red group) Head: Quercus subg. Quercus (Oak, white group) Bung: Pinus sp., hard (Pine)</p> |  <p>Three stave fragments of 20 shown.</p> |

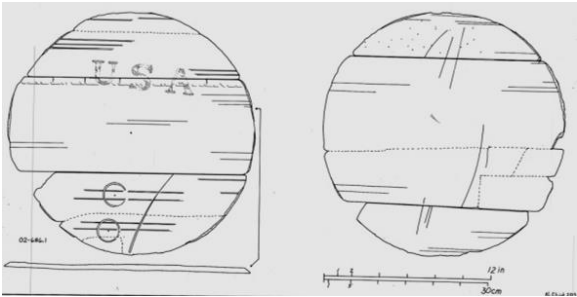
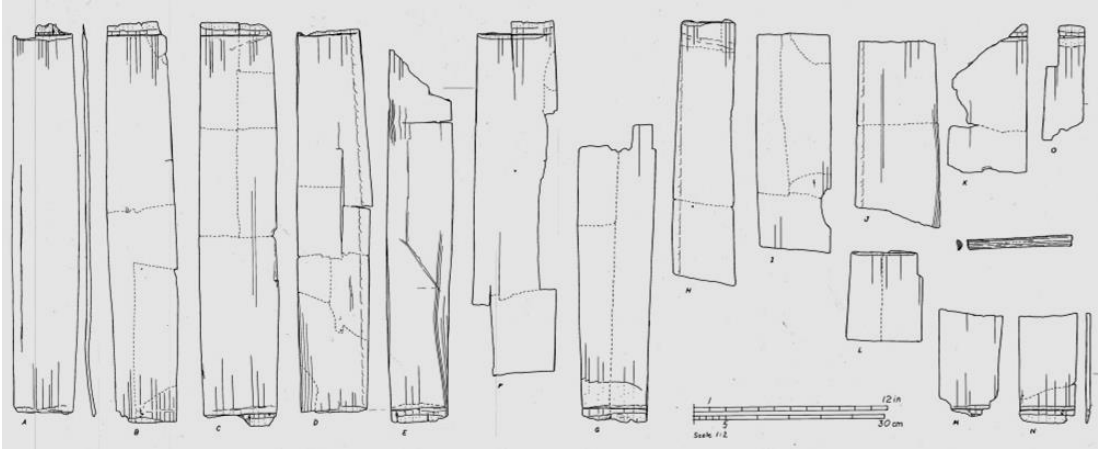
| | |
|--|---|
| 02-686 | Barrel XIII Type unknown, 2 three-piece heads; parts of at least 10 staves; hoop fragments, BF1-05 |
| Provenience: 27P1-26P1/HMp | |
| <p>Heads: Original diameter both heads: 17 6/8 in (43.5 cm) Top head: (02-686.1): Length: A 17 5/8 in (43.2 cm) B and C 15 2/8 in (37.4 cm) Width: A 6 6/8 in (16.5 cm) B 5 6/8 in (14.1 cm) C 4 5/8 in (11.3 cm) Thickness: A 3/8 in (0.9 cm) B and C 2/8 in (0.6 cm) Bottom head (02-686.2): Length: A 17 5/8 in (43.2 cm) B 12 4/8 in (30.6 cm) C 13 4/8 in (33.1 cm) Width: A 10 4/8 in (25.7 cm) B 3 5/8 in (8.9 cm) C 3 3/8 in (8.3 cm) Thickness: A B and C 3/8 in (1 cm) Staves: Length: ~25 in (61.3 cm) Width at Bilge: 2 3/8 to 5 2/8 in (5.8 to 12.9 cm) Thickness: 3/8 in (1 cm)</p> | |
| <p>Heads: Condition fair. Top head: Two scribe incised circles 1 5/8 in (4 cm) diameter set 1 in (2.5 cm) apart. Heavy incised line adjacent to them may or may not relate, but does not cross to A. Compass point hole. Stencil painted USA Bottom head: Short scored assembly lines on bottom head and the longer line on center piece that does not cross onto cant, indicate replacement of cant pieces. Both heads, external bevel 1/8 in (0.3 cm) interior bevel 4/8 in (1.3 cm). Bites sharp. Sapwood present on 686.1A Staves: Unusually short staves. Certainly represents more than one bbl. Length between crozes ranges from 22 1/8 in (56.1 cm) to 23 6/8 in (60.3 cm). Sapwood present on at least 3 staves.</p> | |
| <p>Woods: Head: 686.1 cant piece—Red oak 686.1A center piece—White oak 686.2A cant piece—Red oak 686.2C center piece—White oak Staves—Red oak Hoops: <i>Carya</i> sp., true (Hickory)</p> |  <p style="text-align: center;">Exteriors shown.</p> |
|  | |

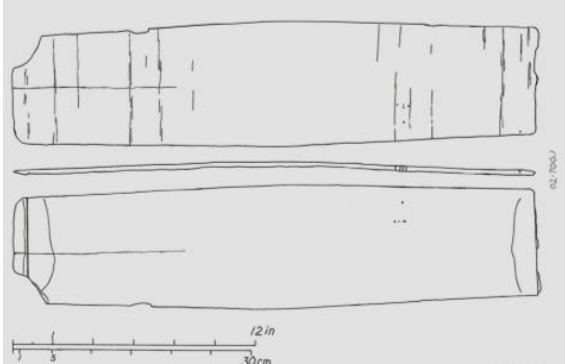
| | | |
|---|--|--|
| 02-700 | Barrel XIV (Bean), 2 staves Provenience: (25P2)/HMp |  <p data-bbox="1053 680 1162 709">02-700.1</p> |
| <p>02-700.1—Length (near complete): 26 3/8 in (64.6 cm) Length between crozes: 25 in (61.3 cm) Width: 6 1/8 in (15 cm) Thickness: 3/8 in (1 cm) 02-700.2 (<i>not shown</i>) Length (incomplete): 17 5/8 in (43.2 cm) Width: 3 2/8 in (8 cm) Thickness: 2/8 in (0.6 cm)</p> | | |
| <p>Condition fair. Croze 1/16 in (0.2 cm) scratch. Partial hooped. In 02-700, several hoop nail holes clustered together at bilge hoop area go through stave. 1 or 2 fragments of nails in place. Hoop fragment was in place when recovered. (02-700.2 not shown)</p> | | |



| | |
|----------------------------|---|
| 02-715, 02-714 | Barrel XV Flour, 1 half head; 1 two-piece head; 8 staves; hoop fragments, BF3-05 |
| Provenience: 27P1-27P2/HMp | |

Heads: Original diameter: 17 4/8 in (42.9cm)
 Top head (02-714): Length: 17 2/8 in (42.3 cm) Width: 6 6/8 in (16.5 cm) Thickness: 4/8 in (1.2 cm)
 Bottom head (02-715): A and B: Length: 17 3/8 and 17 in (42.6 and 41.7 cm)
 Width: 8 6/8 and 8 1/8 in (21.4 and 19.9 cm) Thickness: 4/8 and 3/8 in (1.2 and 1 cm)
 Staves: Length: 27 1/8 in (66.5 cm) Length between crozes: 25 4/8 in (62.5 cm)
 Width at Bilge: 3 3/8 to 5 in (8.3 to 12.3 cm) Thickness: 3/8 in (1 cm)

Top head: Condition poor. Number 18 consisting of a deeply etched **1** and scribed circles of two diameters, 1 4/8 in (3.7 cm) and 1 3/8 in (3.4 cm). No exterior bevel. Trace of possible straight assembly line. Part of stencil painted **S** visible in field photo. (U and A probably present but obscured by mud.) Sapwood present.

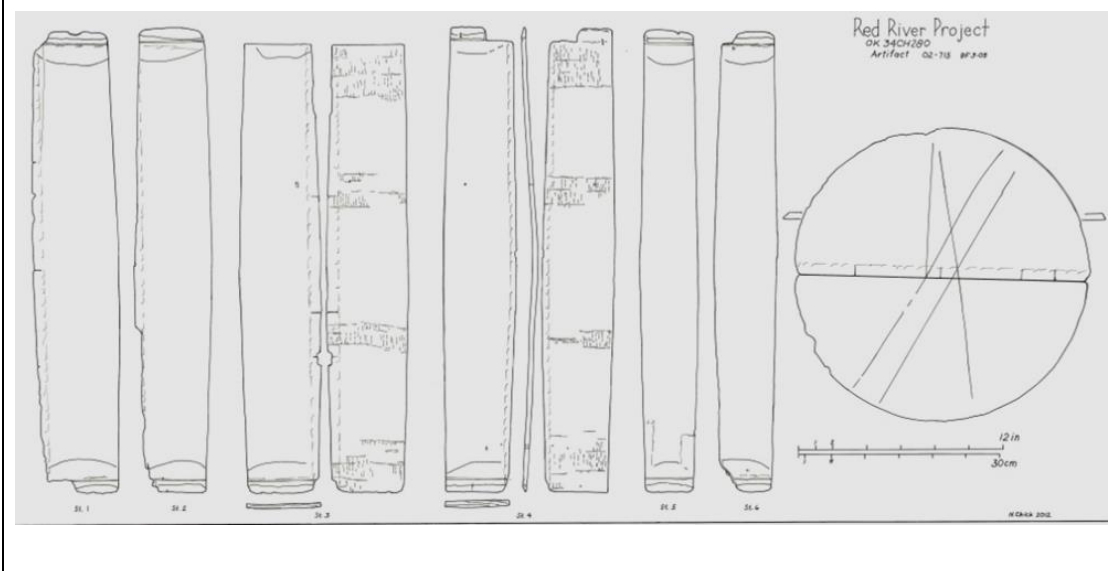
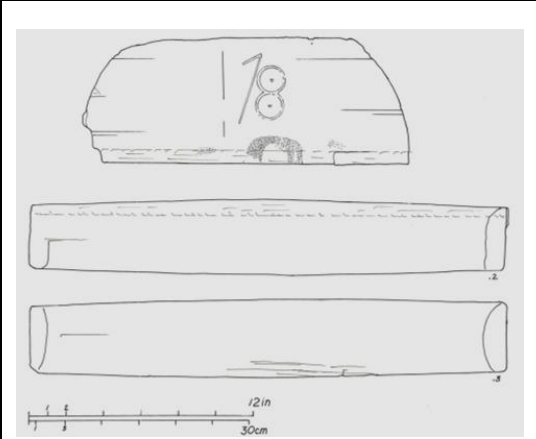
Bottom head: Condition fair. Unusual straight assembly lines. Sapwood present on A.
 Staves: Croze 1/8 in (0.2 cm) square, however, one end's croze is 1/16 in (0.2 cm) square. Croze from end 6/8 in (1.9 cm).
 3 hoops at chimes, 2 at bilges. Small hoop nail holes pierce staves. Sapwood present on 5 of 8 staves.
 Wood: Hoop (02-715) 1 sample, *Carya* sp., true (Hickory)
 Head: (02-714; 02-715L1.2) and Staves (714.2 and 715L2.1) all are *Quercus* subg. *Quercus* (Oak, white group),

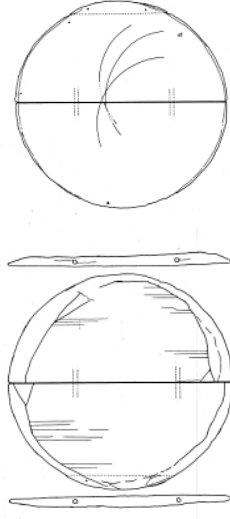

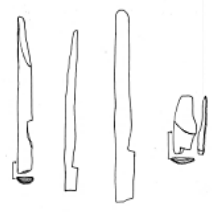
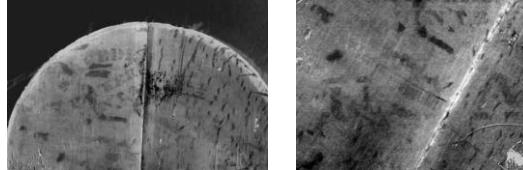
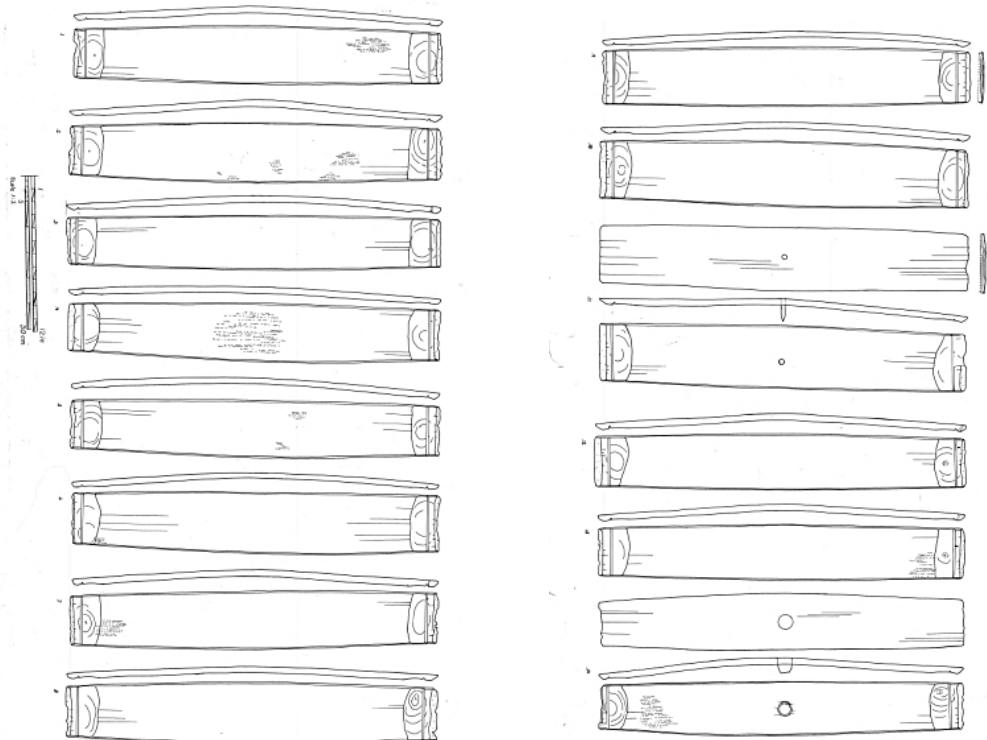
| | | |
|---|---|--|
| 02-740 | Barrel XVI Pork, 2 two-piece heads; 19 staves; wooden hoops; pork bones (06-740), BF5-05 | |
| Provenience: 27P2/HMp | | |
| Heads: Original diameter: 17 4/8 in (42.9cm) Staves: Length: 28 6/8 in (70.4 cm) Length between crozes: 26 6/8 in (65.5 cm) Width: 4 1/8 to 5 in (10.1 to 12.3 cm) Thickness: 5/8 in (1.5 cm) | | |
| Condition good. Full-hooped. Top head marks: USA and A.S. REEDER PACKER CIN'T Stave Bung: round Diameter: 1 in (2.5 cm) Length: 1 1/8 in (2.9 cm) Stave sample hole peg: Exterior Diameter: 3/8 in (1 cm) Length: 1 5/8 in (4.1 cm) Hoops are clearly notched. Neither head has a bung hole. What appears in field photos to be a metal bung hole cover was in fact an unrelated object . |  <p>Bottom head shown</p> |  <p>Molds of hoops made before they broke up.</p>  |
|  |  | |

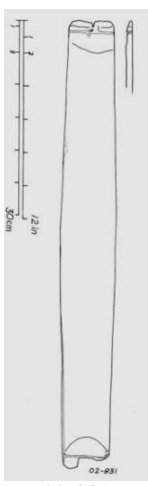
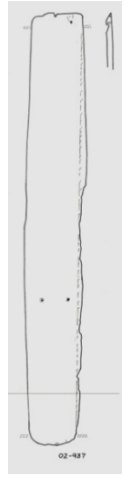
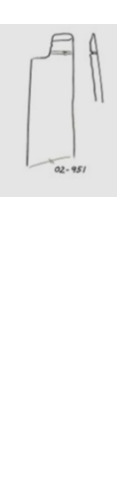
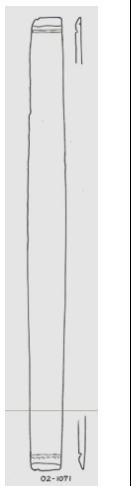
| | | | | |
|--|---|--|---|--|
| 02-831, 02-937, 02-938, 02-951 | Barrel XVII Type unknown, 5 staves | | | |
| | Provenience: 02-831 (11P3); 02-937, 02-938 and 02-951 14P3; 02-1071 (14P2)/ All HFp | | | |
| Length: 27 2/8 in (66.8 cm) Length between crozes: 25 6/8 in (63.1 cm) Thickness: 3/8 to 4/8 in (0.9 to 1.2 cm) Width: 2 2/8 to 3 4/8 in (5.5 to 8.6 cm) |  <p>02-831</p> |  <p>02-937</p> |  <p>02-951</p> |  <p>02-1071</p> |
| Condition good, fair. Partially hooped. Crozes 1/8 in (0.3 cm) square. Stave length taken from 02-1071, only one with both chime ends intact. 02-937 and 02-951 have large head/hoop nail holes that pierce stave. 02-1071 has hoop nail hole at chime that does not go through to interior. Sapwood present on 02-937. Wood: 02-938 and 01-1071 Quercus subg. Quercus (Oak, white group) (02-938 not shown) | | | | |

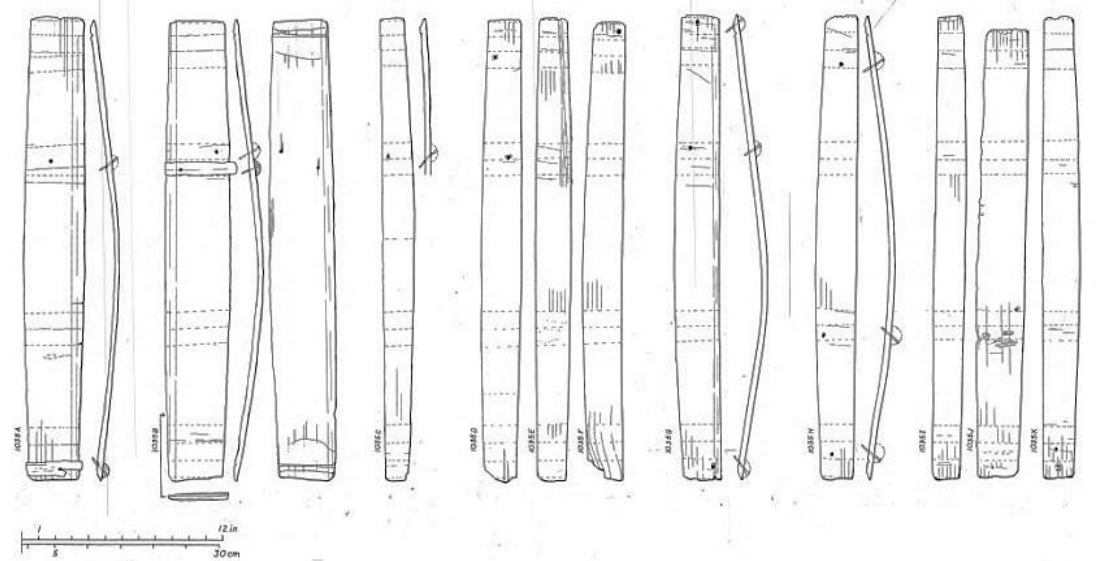
| | | | | |
|---|--|--|--|--|
| 02-1035 | Barrel XVIII Flour (probable), 11 staves; hoop fragments; nails, BF1-06 | | | |
| | Provenience: 15P2/HFp | | | |
| Staves: Length: 27 4/8 in (67.4 cm) Length between crozes: 25 6/8 in (63.1 cm) Width: 1 7/8 to 3 7/8 in (4.6 to 9.5 cm) Thickness: 4/8 in (1.2 cm) | | | | |
| Condition fair to good. Partial hooped; 3 hoops at ends, 2 at bilges. Numerous hoop nail holes ~1/8 in (0.3 cm) diameter; 4 head-reinforcing nail holes, the largest 3/8 x 1/8 in (0.9 x 0.3 cm). Crozes square 1/8 in (0.3 cm) wide and slightly deeper. Sapwood present on 3 staves. Many nails and several hoop pieces recovered in place. Wood: Hoop <i>Carya</i> sp., true (Hickory) | | | | |
|  | | | | |

| | |
|---|---|
| 02-1036, 02-1038 | Barrel XIX Pork, 4 staves; hoop fragments; pork bones (06-1052), BF2-06 |
| Provenience: 16P3/HFp | |
| Length between crozes: 26 7/8 in (65.8 cm) Thickness: 6/8 in (1.8 cm) 02-1038—Length: 30 in (73.5 cm) Width: 3 2/8 to 4 3/8 in (8 to 10.7 cm) 02-1036—Length: 29 4/8 in (72.3 cm) Width: 4 2/8 in (10.4 cm) | |
| Condition fair to good. Full hooped, ~18 hoops total. 02-1038C—Bung: 1 1/8 in (2.8 cm) diameter, round cross-section. Letters G.R are branded above bung. The best-preserved areas of croze are 1/8 in (0.3 cm) deep but 3/32 in (0.2 cm) wide. Orientation of medulary rays on 02-1038B and 02-1038C suggest natural twist in grain of wood. Woods: Hoop <i>Carya sp. true</i> (Hickory). Bung is <i>Pinus sp.</i> (Pine). | |
| <p>Red River Project OK 34 CH280 Artifact # 02-1036 02-1038</p> <p>02-1036A, 02-1038C, 02-1038B, 02-1038A</p> <p>Scale 1/2</p> | |

C.2.1.2. Barrel Heads and Head Pieces, Not Associated with Barrel Features

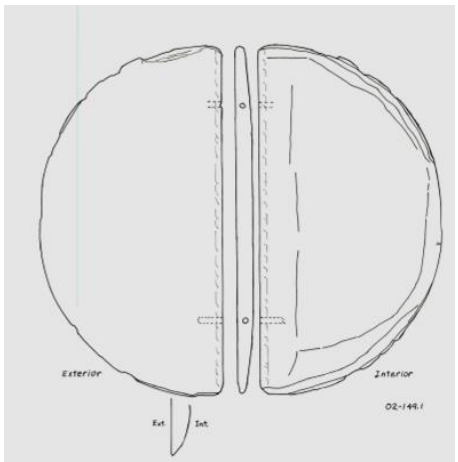
| | | |
|--|--------------------------------|--|
| 02-149.1 | Half Head Possible pork |  |
| | Provenience: 42P1/HAp | |
| Original Diameter: 17 2/8 in (42.3 cm) Length: 17 in (41.7 cm) Width: 8 7/8 in (21.7 cm) Thickness near center of joint: 7/8 in (2.1 cm) | | |
| Condition fair. Half of 2-piece head, probably from pork barrel. Interior of thick headstock shaped with ax. Narrow exterior bevel. Some areas of a sharp bite remain. Dowel holes 10 4/8 in (25.7 cm) apart, 2/8 in (0.6 cm) diameter and 1 1/8 in (2.8 cm) deep. Compass point hole (not shown in drawing) less than 4/8 in (1.2 cm) from joint edge. Sapwood present. (This head is not related to Barrel III, 02-149, BF1-03.) | | |

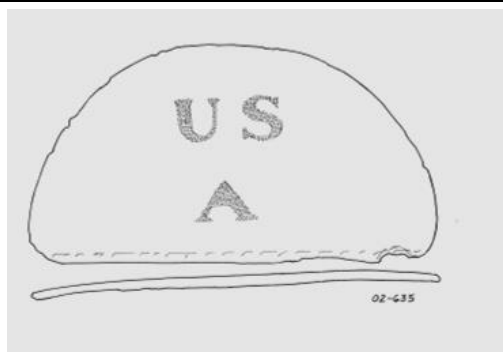
| | | |
|--|---|---|
| 02-635 | Half Head Possible flour or bean |  |
| | Provenience: 24P3/HMp | |
| Original Diameter: 17 in (41.7 cm) Length: 16 4/8 in (40.4 cm) Width: 8 7/8 in (21.7 cm) Thickness: 3/8 in (1 cm) | | |
| Condition fair. Half of 2-piece head, Thickness near cant edge less than 2/8 in (0.6 cm). Stencil painted USA . No exterior bevel. Interior bevel 3/8 in (1 cm). Sapwood present. Wood: head Quercus subg. Lobate (Red oak) | | |

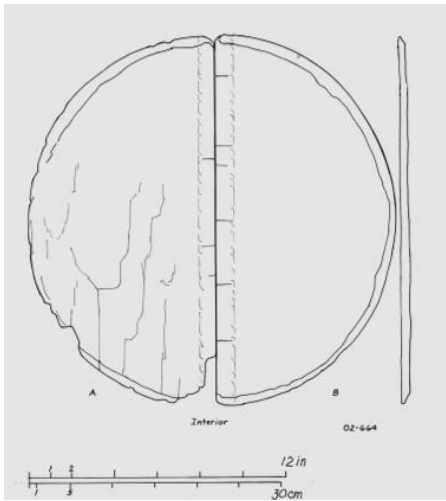
| | | |
|---|--|--|
| 02-664 | Two-piece Head Possible flour or bean |  |
| | Provenience: (24P3)/HMp | |
| Original Diameter: 17 4/8 in (42.9 cm) Length 17 2/8 in (43.3 cm) A and B: Width: 8 7/8 and 8 3/8 in (21.7 and 20.5 cm) Thickness: 4/8 and 3/8 in (1.2 and 1 cm) | | |
| Condition poor. Sapwood present on both halves. Bite sharp. Exterior bevel 1/8 in (0.3 cm). | | |

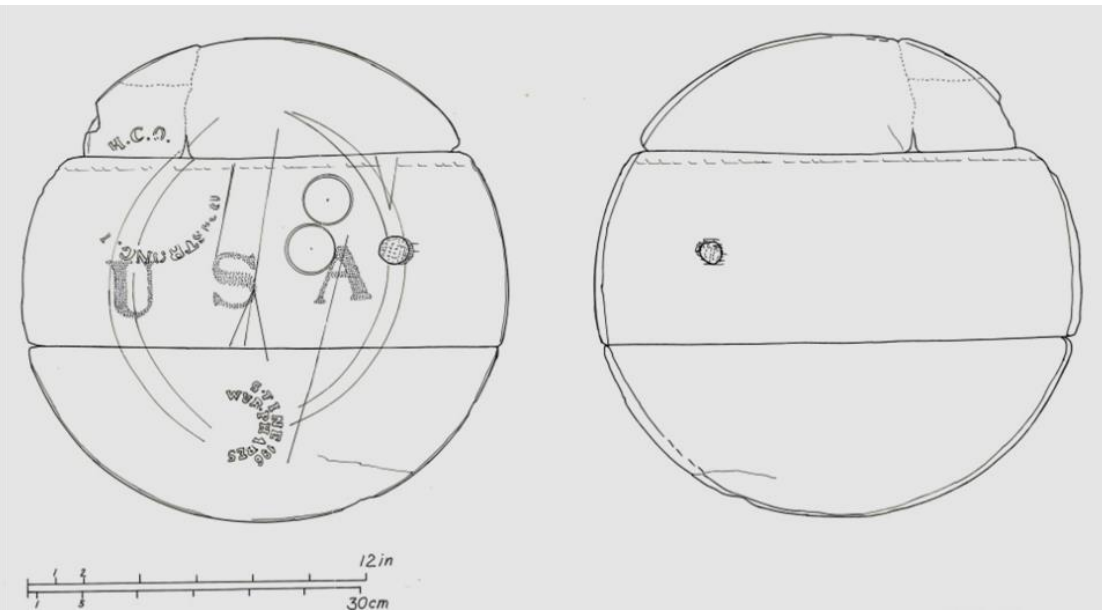
| | |
|--|-------------------------------|
| 02-684 | Three-piece Head Flour |
| | Provenience: 26P1/HMp |
| <p>Original Diameter: 17 2/8 in (42.3 cm) A: Length: 16 4/8 in (40.4 cm) Width: 6 1/8 in (15 cm) Thickness: 4/8 in (1.2 cm) B: Length: 14 2/8 in (34.9 cm) Width: 6 5/8 in (16.2 cm) Thickness: 5/8 in (1.5 cm) C: Length: 13 2/8 in (32.5 cm) Width: 4 1/8 in (10.1 cm) Thickness: 3/8 in (1 cm)</p> | |
| <p>Condition good. 3-piece head. This is the most extensively marked of the <i>Heroine</i> barrel heads. Flour inspector's brand: H.C.O. _ ARMSTRONG _ Flour supplier's brand: S.FINE 196 W&P. PHARES Stencil painted: USA. Two 1 3/4" circles (possibly a number 8) incised with scribe. Incised 3-pronged "trident" and other lines, including two sets of assembly arcs. Bite sharp. Exterior bevel 1/8 (0.3 cm) Interior bevel 4/8 in (1.3 cm). Bung length 5/8 in (1.5 cm); Bung hole diameter tapers from 1 1/8 in (2.8 cm) on the exterior to 7/8 in (2.1 cm) on the interior. Wood: Bung Pinus sp. (Pine).</p> | |
|  | |

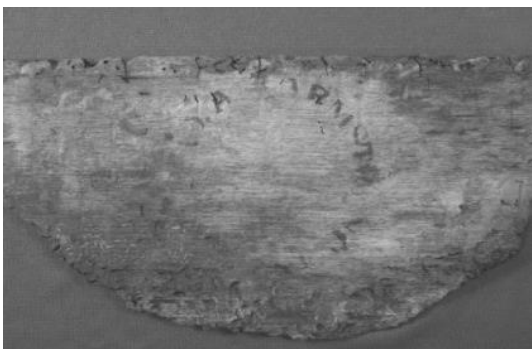
| | | |
|---|------------------------|--|
| 02-316 | Half Head Flour |  |
| | Provenience: 42P1/HAp | |
| <p>Original Diameter: 17 4/8 in (42.9 cm) Length: 017 4/8 in (42.9 cm) Width: 7 in (17.2 cm) Thickness: 4/8 in (1.2 cm)</p> | | |
| <p>Condition poor, insect/worm damage. Flour inspector's brand: _ O.A _ ARMSTR _ NG _ IN _ Bite sharp, no exterior bevel. Sapwood present.</p> | | |

| | |
|--|--|
| 02-1287 | Half Head (Partial) Flour |
| | Provenience: HMpo |
| Original Diameter: unknown Length: 10 1/8 in (24.8 cm) Width: 5 4/8 in (13.5 cm) Thickness: 4/8 in (1.2 cm) | |
| Condition poor. Flour inspector's brand did not survive conservation but shows clearly in field photograph: <u>O.A.R. ARM NG.</u> Two assembly arcs and part of a 1 4/8 in (3.7 cm) scribed circle. The purpose of two deep scores evidently cut with a knife cross the exterior and a similar wavy score across interior is not known, but may indicate piece was broken and used for scrap. Sapwood present. |  |

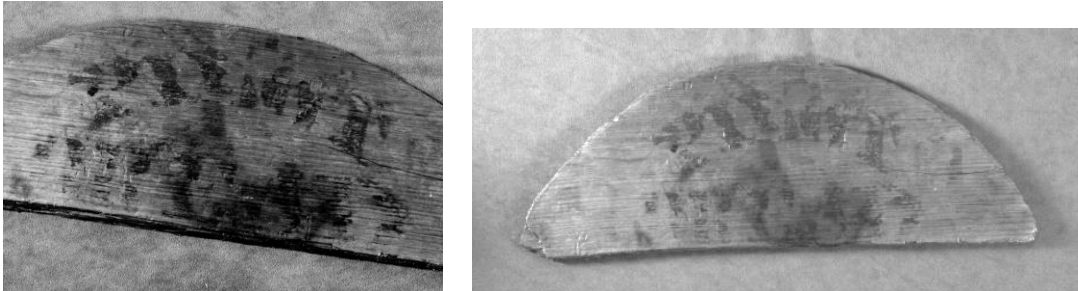
| | |
|--|-------------------------------|
| 02-813 | Half Head Bread Barrel |
| | Provenience: (8P2)/HFp |
| Original Diameter: 17 4/8 in (42.9 cm) Length: 15 4/8 in (38 cm) Width: 5 4/8 in (13.5 cm) Thickness at joint: 3/8 in (1 cm) Thickness near cant edge 2/8 in (0.6 cm) | |
| Condition poor. Long edge appears to be broken, not jointed. Pre-conservation photos show stencil painted P.U _ A BREAD though extraneous stains make deciphering difficult. Suggests barrel was re-used and/or was not part of Army contract cargo. Wood: Head Quercus subg. Lobatae (Oak, red group) | |
|  | |

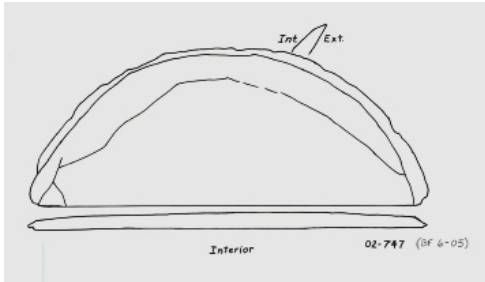
| | |
|--|--------------------------------|
| 02-747 | Half Head Possible pork |
| | Provenience: 26P3/HMp |
| Original Diameter: 17 in (41.7 cm) Length: 16 1/8 in (39.5 cm) Width: 6 2/8 in (15.3 cm) Thickness: 5/8 in (1.5 cm) | |
| Condition good though edges worn and broken. Probably from 3-piece head. Bite sharp. Exterior bevel 1/8 in (0.3 cm). Axed shaping on interior. | |
|  | |

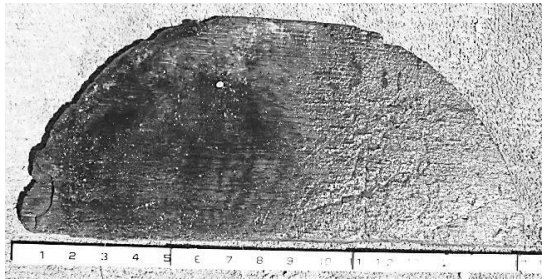
| | | |
|--|-------------------------------|--|
| 02-1303 | Half Head Type unknown |  |
| | Provenience: HMpo | |
| Original Diameter: 17 2/8 in (42.3 cm) Length: 17 2/8 in (42.3 cm) Width: 7 3/8 in (18.1 cm) Thickness: 3/8 in (1 cm) | | |
| Condition fair. Incised 18 at right of photo. The number 8 formed with two 1 4/8 in (3.7 cm) scribe circles. Pair of assembly arcs cross join near center. No exterior bevel at bite. | | |

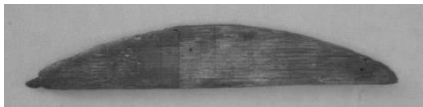
| | | |
|---|-----------------------|--|
| 02-250 | Head Fragment |  |
| | Provenience: 42P1/HAp | |
| Original Diameter: 17 4/8 in (42.9 cm) Length: 8 4/8 in (20.8 cm) Width: 1/3/8 in (3.4 cm) Thickness: 2/8 in (0.6 cm) | | |
| Wood: Quercus subg. Quercus (Oak, white group) | | |

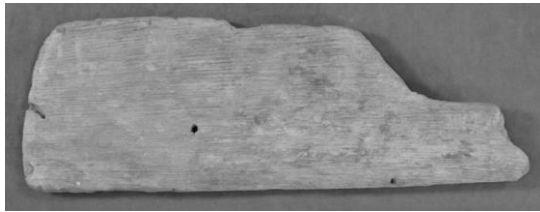
| | | |
|---|--|---|
| 02-904 | Half Head (Partial) Type unknown |  |
| | Provenience: 8S2/HFs | |
| Original Diameter: unknown Length: 15 3/8 in (37.7 cm) Width: 5 2/8 in (12.9 cm) Thickness: 5/8 in (1.5 cm) | | |
| Badly worn. Possible vent hole 2/8 in (0.6 cm) diameter. | | |

| | | |
|---|-------------------------------|--|
| 02-984 | Half Head Type unknown |  |
| | Provenience: HFp | |
| Original Diameter: 17 in (41.7 cm) Length: 16 1/8 in (39.5 cm) Width: 8 in (19.6 cm) Thickness: 4/8 in (1.2 cm) near join, thinning to 2/8 in (0.6 cm) near cant edge. | | |
| Condition poor. 1 in (2.5 cm) scribe circle near center of join. Possible traces of branded mark. One head-reinforcing nail in place. Sapwood present. (Diagonal line from center of join to cant edge is fishing line used to attach label.) | | |

| | |
|--|-------------------------------|
| NP 02-2 | Half Head Type unknown |
| | Provenience: Unknown |
| Original Diameter: 17 4/8 in (42.9 cm) Length: 17 1/8 in (42 cm) Width: 7 4/8 in (18.4 cm) Thickness: 3/8 in (1 cm) | |
| Condition fair, though cant edge broken off. Sapwood present. Possible planing tool marks across grain. | |

-

| | |
|---|-------------------------|
| NP 02-3 | Head Fragments 2 |
| | Provenience: Unknown |
| Original Diameter: 18 in (44.1 cm) NP 02-3A—Cant piece: Length: 14 6/8 in (36.1 cm) Width: 4 7/8 in (11.9 cm) Thickness: 3/8 in (1 cm) NP 02-3B—Cant piece, broken across grain. Length: 9 in (22.1 cm) Width: 5 in (12.3 cm) Thickness: 4/8 in (1.2 cm) | |
| Condition poor. Edge of A is broken, not jointed—original width of piece unknown. B has one dowel hole 2/8 in (0.6 cm) in diameter and 1 in (2.5 cm) deep located ~4 in (9.8 cm) from end of join. Dowel holes are not centered in joint. Probably from 3-piece head. Unique in assemblage, both pieces show considerable charring. | |

-

| | |
|---|--------------------------------------|
| 02-906 | Head Fragments 3 small pieces |
| | Provenience: 8S2/HFs |
| Original Diameter: not determined. Thickness: 2/8 in (0.6 cm) | |
| Two pieces refit: 7 x 2 in (17.3 x 4.9 cm) | |

C.2.1.3. Staves and Stave Pieces, Not Associated with Barrel Features

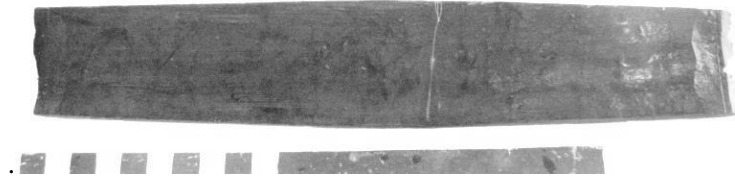
| | |
|--|-----------------------|
| 02-658 | Stave |
| | Provenience: 28P3/HMp |
| Length: 27 1/8 in (66.5 cm) Width: 5 in (12.3 cm) Thickness: 2/8 in (0.6 cm) | |
|  | |
| Artifact missing, not available for study | |

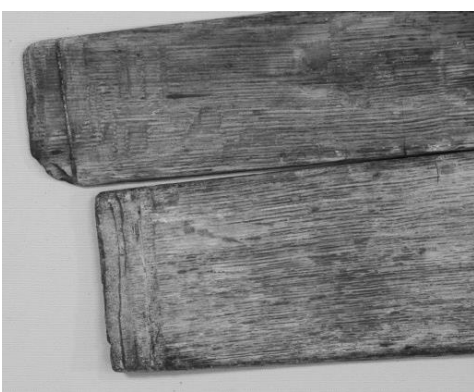
| | | |
|---|---------------------------|---|
| 02-701 A,B | Staves (Partial) 2 |  |
| | Provenience: (27P2)/HMp | |
| A: Length: 15 4/8 in (38 cm) Width: 3 1/8 in (7.7 cm) Thickness: 2/8 in (0.6 cm) | | |
| B: Length: 10 6/8 in (26.3 cm) Width: 4 in (9.8 cm) Thickness: 2/8 in (0.6 cm) | | |
| Condition fair. Crozes 1/16 in (0.2 cm) scratch. Croze from end: 6/8 in (1.9 cm). | | |

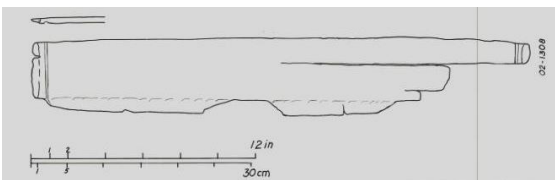
| | |
|---|-------------------|
| 02-1308 | Stave |
| | Provenience: HMpo |
| Length: 26 4/8 in (64.9 cm) Length between crozes: 25 1/8 in (61.6 cm) Width: 4 1/8 in (10.1 cm) Thickness: 2/8 in (0.6 cm) | |
| Condition very poor. Short slight stave. Crozes square, 1/8 to 3/16 in (0.3 to 0.5 cm) wide and 1/8 in (0.3 cm) deep. No chivs. Wide band of sapwood present. | |
|  | |

| Other Stave Pieces | | | |
|---------------------------|--------------------|---|---|
| <i>Artifact Number</i> | <i>Provenience</i> | <i>Measures: Length Width Thickness</i> | <i>Comments</i> |
| 02-NP3.1 | unknown | L: 24 7/8 in (60.9 cm) W: 3 3/8 in (8.3 cm) Th: 2/8 in (0.6 cm) | Very poor condition. Broken at both chimes. Unusual bands 1 in (2.5 cm) wide resemble hoop shadows, but cross exterior at diagonal. They are not grouped; the six bands are spaced at 2 to 4 in (4.9 to 9.8 cm) intervals, including in bilge area. Likely post-depositional. |
| 02-NP3.2 | unknown | L: 25 5/8 in (62.8 cm) W: 4 1/8 in (10.1 cm) Th: 3/8 in (1 cm) | Length between crozes: 25 5/8 in (62.8 cm). Partially hooped. Sapwood present. |
| 02-596 | 28P3 /HMp | L: 10 5/8 in (26 cm) W: 2 5/8 in (6.4 cm) Th: 2/8 in (0.6 cm) | Partial stave. |
| 02-674 | (28P2) /HMp | | Artifact missing. |
| 02-691 | (23P2) /HMp | | Stave and hoop fragments. Two fragments are stave ends with 1/16 in (0.2 cm) scratch crozes, and are 2/8 in (0.9 cm) thick. |
| 02-693b | (26P1) /HMp | | Small stave fragments. Two fragments have 1/16 in (0.2 cm) scratch crozes. |
| 02-702 | HMp | | Artifact missing. |
| 02-724 | (25P3) /HMp | L: 7/8 in (2.1 cm) | Stave fragment. |
| 02-851 | BCp | L: 4 2/8 in (10.4 cm) W: 2 7/8 in (7 cm) Th: 2/8 in (0.6 cm) | Stave fragment. |
| 02-1288 | HMpo | L: 5 4/8 in (13.5 cm) Th: 4/8 in (1.2 cm) | Stave fragment. |
| 02-1289 | HMpo | | Small stave fragment. |
| 02-1290 | HMpo | | Four stave fragments. |
| 02-1293 | HMpo | L: 9 4/8 in (23.3 cm) Th: 3/8 in (1 cm) | Stave fragment. |
| 02-1304 | HMpo | L: 26 6/8 in (65.5 cm) W: 3 5/8 in (8.9 cm) Th: 2/8 in (0.6 cm) | Condition poor. Near complete. Length between crozes: 25 7/8 in (63.4 cm). Scratch croze 1/16 in (0.2 cm) wide. Numerous small holes, probably worm damage. |
| 02-1307 | HMpo | L: 18 1/8 in (44.4 cm) W: 3 7/8 in (9.5 cm) Th: 3/8 in (1 cm) | Partial stave. |
| 02-1317 | HMpo | L: 15 in (36.8 cm) W: 3 7/8 in (9.5 cm) Th: 2/8 in (0.6 cm) | Partial stave. Very poor condition. |

C.2.1.4. Hoops

C.2.1.4.1. Iron Hoops/Fragments

| | |
|---|-----------------------------|
| 03-050 | Iron Hoop (Fragment) |
| | Provenience: 37S3/HAs |
| Length: 2 6/8 in (7 cm) Width: 1 1/8 in (2.9 cm) Thickness: 1/16 in (0.16 cm) | |

-

| | | |
|--|-----------------------------|--|
| 03-059 | Iron Hoop (Fragment) |  |
| | Provenience: 41S3/HAs | |
| Length: 14 6/8 in (37.5 cm) Width: 1 in (2.5 cm) | | |
| Rivet in place. Overlap is 2 3/4 in (4.5 cm) Rivet head diameter is 4/8 in (1.3 cm) | | |

-

| | | |
|--|-----------------------|---|
| 03-829 | Iron Hoop |  |
| | Provenience: 12P2/HFp | |
| Diameter: ~15 4/8 in (39.4 cm) Width: 1.5 in (3.8 cm) Thickness: 1/8 in (0.3 cm) | | |
| Rivet in place. Overlap ~4 in (10.2 cm) This hoop is somewhat smaller than barrel-size and probably was from a keg. | | |

-

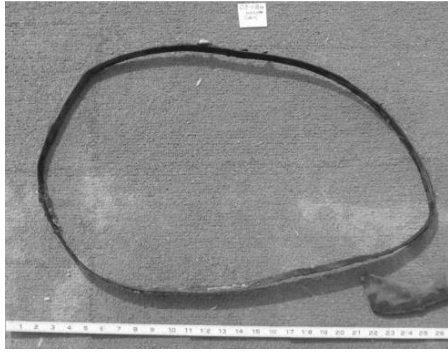
| | | |
|--|-----------------------|--|
| 03-1186 | Iron Hoop |  |
| | Provenience: 24S1/HMs | |
| Diameter: ~20 in (51 cm) Width 1 2/8 in (3.2 cm) | | |
| Rivet in place. Possibly a bilge-hoop from a barrel-size cask. | | |

-

C.2.1.4.2. Wood Hoops/Withies

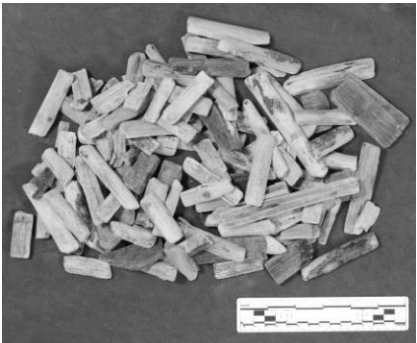
| | | |
|--|---|--|
| 02-693 | Hoop Fragments (Includes some small stave and other fragments) |  |
| | Provenience: (26P1)/HMp | |
| Approx. Nr. Pieces: 110 Weight: 13.5 oz (383 g) | | |
| Wood: 5 samples, <i>Carya</i> sp., true (Hickory) 1 sample, Salicaceae (Willow/Cottonwood/Aspen/Poplar)—this is undoubtedly a wash-in, not a hoop fragment. | | |

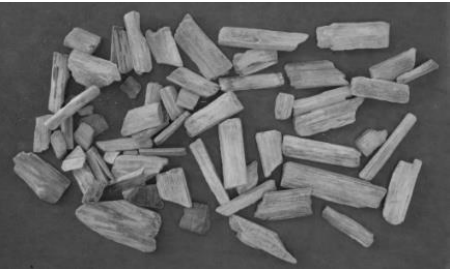
| | | |
|---|-------------------------|---|
| 02-705 | Hoop Fragments |  |
| | Provenience: (27P1)/HMp | |
| Approx. Nr. Pieces: 30 Weight: 5.3 oz (150 g) | | |
| Wood: 1 sample <i>Carya</i> sp., true (Hickory) | | |

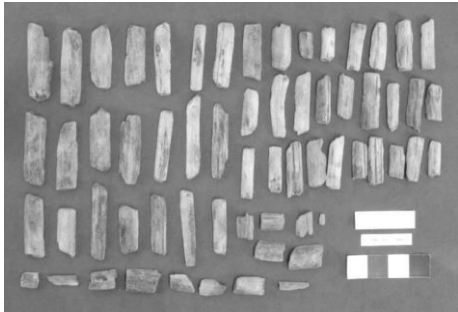
| | | |
|---|-----------------------|--|
| 02-788 | Hoop Fragments |  |
| | Provenience: 8P1/HFp | |
| Approx. Nr. Pieces: 60 Weight: 8.6 oz (244 g) | | |
| | | |

| | | |
|--|-----------------------|--|
| 02-808 | Hoop Fragments |  |
| | Provenience: HFp | |
| Approx. Nr. Pieces: 10 Weight: 1.6 oz (45 g) | | |
| One piece shows notching (lower left). | | |
| Wood: 1 sample, <i>Pinus</i> sp. (Pine) | | |

| | | |
|--|---|--|
| 02-1016 | Hoop Fragments (Include some stave and other wood fragments) |  |
| | Provenience: HFp | |
| Approx. Nr. Pieces: 60 Weight: 6.1 oz (173 g) | | |
| Wood: 1 sample, Acer sp. (Maple) 2 samples, Carya sp., true (Hickory) 1 sample, Quercus subg. Quercus (Oak, white group) | | |

-

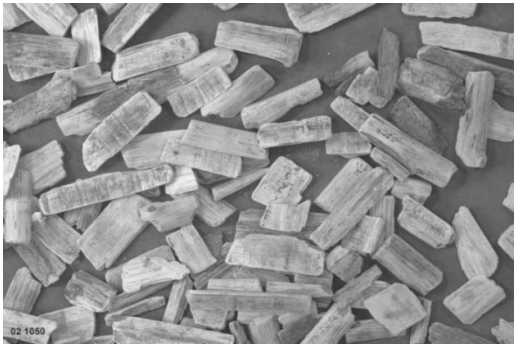
| | | |
|--|--|---|
| 02-1050 | Hoop Fragments (Includes some stave and other wood fragments; 2 pointed sticks) |  |
| | Provenience: HFp | |
| Approx. Nr. Pieces: 150 Weight: 12.7 oz (360 g) | | |
| This set includes 2 sticks ~7 in (17.8 cm) that had been whittled to points. Each stick had been broken into three pieces that were refitted. One piece can be seen in the center of this photo. Wood: Pointed sticks, Carya sp., true (Hickory) | | |

-

| Other Hoop Fragments | | | | |
|-----------------------------|--------------------|---------------------------|---------------------------------|---|
| <i>Artifact Number</i> | <i>Provenience</i> | <i>Approx. Nr. Pieces</i> | <i>Weight of Hoop Fragments</i> | <i>Comments</i> |
| 02-662 | (24P3) /HMp | 6 | 0.7 oz (20 g) | |
| 02-692 | (25P2) /HMp | 6 | 1.2 oz (34 g) | Some small stave fragments. |
| 02-722 | HMp | | | |
| 02-726 | (27P1) /HMp | 100 | 9.8 oz (278 g) | |
| 02-734 | (27P2) /HMp | 100 | 9.9 oz (281 g) | |
| 02-777 | HF(p) | 12 | 1.9 oz (54 g) | Some small triangular pieces, possibly sections of molding. |
| 02-783 | 8P2 /HFp | | | Hoop fragment, large [folder empty] |
| 02-787 | (8P1) /HFp | 1 | 0.1 oz (3 g) | |
| 02-793 | HF(p) | 12 | 1.7 oz (48 g) | |
| 02-796 | HF(p) | 10 | 1.4 oz (40 g) | |
| 02-803 | BC | 1 | 0.1 oz (3 g) | 2 1/8 x 1 x 1/4 in (5.4 x 2.5 x 0.6 cm) |
| 02-808 | HFp | | | Missing. |
| 02-819 | HFp | 10 | 1.7 oz (48 g) | |
| 02-822 | HFp | | W1: 10"x2 1/2"x1 1/8" | Hoop fragment and wood fragment. Hoop: 10 in (25 cm) long, 1 1/8 in (2.9 cm) wide. |
| 02-858 | (12P2) /HFp | 3 | 0.6 oz (17 g) | Recovered as one long piece. |
| 02-864 | BC | 1 | | 1 long piece of wooden hoop,[No file, no pictures] |
| 02-873 | BC | 2 | 0.3 oz (9 g) | Wood fragments. |
| 02-902 | (BC) | | | Piece of rope, hoop fragments. |
| 02-926 | BCp | 2 | 0.5 oz (14 g) | |
| 02-963 | BCp | 2 | 0.2 oz (6 g) | |
| 02-983 | HFp | 6 | 0.2 oz (6 g) | Wood fragments. |
| 02-990 | HFp | 2 | 0.1 oz (3 g) | |
| 02-996 | (HFp) | 1 | 0.1 oz (3 g) | |
| 02-1007 | HFp | 7 | 0.8 oz (14 g) | |
| 02-1014 | HFp | 13 | 0.8 oz (23 g) | |
| 02-1024 | HFp | 28 | 3.2 oz (91 g) | 3 stave fragments, other wood fragments. |
| 02-1028 | HF(s) | 11 | 1 oz (28 g) | |
| 02-1045 | HFp | 16 | 2.1 oz (60 g) | Barrel head fragment; stave end fragment with nail. |
| 02-1076 | HF(s) | 5 | 1.7 oz (48 g) | |
| 02-1080 | HFp | 12 | 1 oz (28 g) | |
| 02-1089 | HFp | | | Wood fragments. |
| 02-1093 | HF(s) | 9 | 1.3 oz (37 g) | Wood fragments. |
| 02-1096 | HF(s) | 6 | 1.7 oz (48 g) | |
| 02-1115 | HF(s) | 6 | 1.2 oz (34 g) | |
| 02-1122 | HFp | 3 | 0.4 oz (11 g) | Unidentified wood scraps. |
| 02-1124 | HF(s) | 1 | | |
| 02-1127 | HFp | 3 | 0.2 oz (6 g) | 1 unidentified wood fragment. |
| 02-1131 | HFp | 4 | 0.2 oz (6 g) | |
| 02-1163 | HFp | 2 | | 1 board fragment. |

C.2.2. Boxes

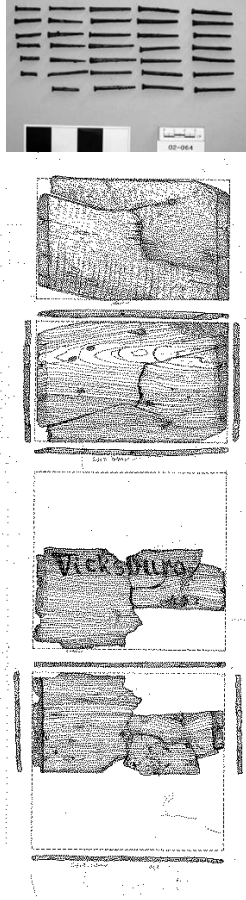
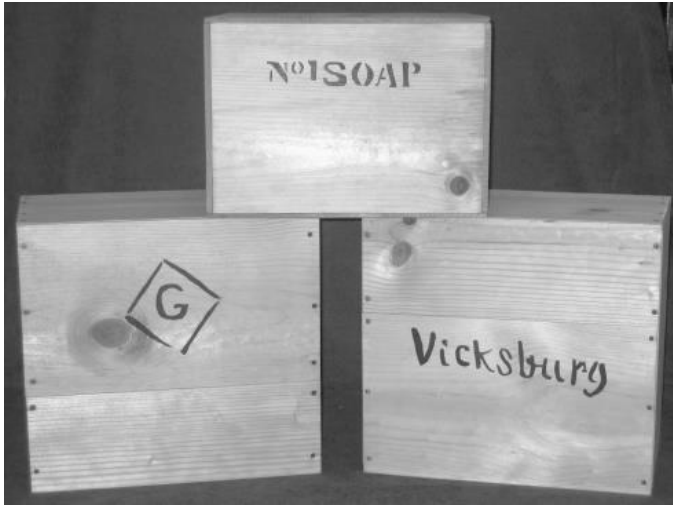
| | | |
|--|--------------------------|--|
| 02-064 | Soap Box |  |
| | Provenience: 45-46S1/SCs | |
| Length: 15 2/8 in (38.7 cm) Width: 16 in (40.6 cm) Height: 10 in (25.4 cm) Thickness: ~4/8 in (1.3 cm) | |  |
| Material: Wood, Pinus (Pine, soft group). Markings: G in a diamond; Vicksburg ; No 1 SOAP Fastened with 35 small nails. According to documentary evidence, all boxes of soap and candle that were part of the subsistence contract were salvaged after <i>Heroine</i> 's sinking. This box was found in the stern compartment and was most likely part of the vessel's own supplies. Shown below in reproduction. | | |

| <i>Box Fragments Artifact No.</i> | <i>Provenience</i> | <i>Measurements</i> | <i>Comments</i> |
|---------------------------------------|--------------------|---|--------------------------------|
| 02-093 | HAs | L: 2 2/8 in (5.7 cm) W: 1 6/8 in (4.5 cm) Th: 3/8 in (1 cm) | |
| 02-190 | 46P1/SCp | L: 6 6/8 in (17 cm) W: 4 6/8 in (12.1 cm) Th: 3/8 in (1 cm) | |
| 02-862 | (13P2)/HFp | | Large box(?) Object missing |

C.3. Cargo Contents

C.3.1. Pork Bones Associated with Barrel Features

| | |
|--|--|
| 06-035, 06-036 | Pork Bones from Barrel I , 124 identifiable bones (06-035), tallow sample (06-036). BF1-01 (02-031-034) |
| Provenience: 42P1/HAp | |
| <p>Minimum number of individuals: 3. Longitudinally halved heads: 3 right. Mandibles: 2 right. Pelvic pieces (acetabulum, ischium, part of ilium): 1 left and 1 right. Fore shank (ulna, radius): 1 left and 1 right. Femora: 1 left and 1 right. Several Humeri. Fragments of scapulae. Numerous Vertebrae (cervical, thoracic, lumbar, including atlases and axes). Numerous Rib fragments, most with part or all of rib head. Distal ends absent.</p> | |
|  | |

| | |
|--|---|
| 06-463 | Pork Bones Associated with Barrel V , 8 bones, BF1-04 (02-463) |
| Provenience: 35P2/HAp | |
|  | |

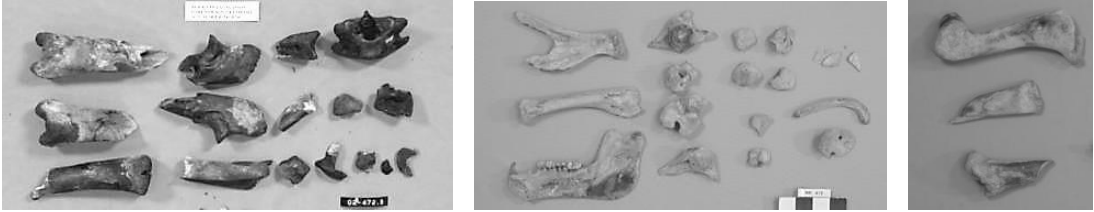
| | |
|--|--|
| 06-472 | Pork Bones from Barrel VI, 57 identifiable bones, BF2-04 (02-472) |
| | Provenience: 35P2-34P2/HAp |
| <p>Minimum number of individuals: 2. Longitudinally halved heads: 2 right. Mandibles: 2 right. Pelvic pieces (acetabulum, ischium, part of ilium): 2 left and 2 right. Hind shank (tibia, fibula): 2 tibia and 2 fibulae. Fore shank (ulna, radius): 1 left and 1 right. Femora: 1 left and 1 right. Several Humeri. Fragments of scapulae. Numerous Vertebrae (cervical, thoracic, lumbar, including atlases and axes). Numerous Rib fragments, most with part or all of rib head. Distal ends absent.</p> | |
|  | |

| | |
|--|--|
| 06-740 | Pork Bones from Barrel XVI, 117 identifiable bones, BF5-05 (02-740) |
| | Provenience: 27P2 /HMP |
| <p>Minimum number of individuals: 5 Longitudinally halved heads: 4 right. Mandibles: 5 right. Pelvic pieces (acetabulum, ischium, part of ilium): 4 left and 4 right. Hind shank (tibia, fibula): 4 tibiae and 2 fibulae. Fore shank (ulna, radius): 2 left and 2 right. Femora: 3 left and 1 right. Several Humeri. Fragments of scapulae. Numerous Vertebrae (cervical, thoracic, lumbar, including atlases and axes). Numerous Rib fragments, most with part or all of rib head. Distal ends absent.</p> | |

| | |
|---|--|
| 06-1052 | Pork Bones Associated with Barrel XIX, 6 bones, BF2-06 (02-1038, 02-1036) |
| | Provenience: 16P1 /HFp |
| <p>Vertebra fragment; 2 Rib fragments; Femoral head epiphysis (juvenile); Ilium; Unidentified bone.</p> | |

C.3.2. Pork Bones Not Associated with Barrel Features

| Artiodactyla; Suidae; Sus; Scrofa | | | |
|--|------------------------|--|-----------------------------------|
| <i>Artifact No.</i> | <i>Provenience</i> | <i>Bone Identification</i> | <i>Comment</i> |
| 06-074 | HAs | Rib | A bit big |
| 06-078 | (HAs) | Scapula fragment | |
| 06-159 | (HAp) | Axis | Small |
| 06-166 | HAp | Humerus | |
| 06-178 | HAp | Femur | Cut marks |
| 06-264 | By rudder, outboard | Radius | Juvenile |
| 06-295 | HAs | Pelvic fragment | Giant cut marks |
| 06-298 | HAs | Humeral fragment | Rodent gnawing, cleaved |
| 06-360 | HAp | Sacral fragment; Thoracic vertebra; Rib | Rodent gnawing on rib |
| 06-378 | HAp | Skull | |
| 06-434 | (HA) | Humerus fragment | Cleaved twice |
| 06-446 | SCp | Proximal femur | Broken, rodent gnawing, cut marks |
| 06-459 | HAp | Proximal humerus | |
| 06-468 | (HAp) | Rib fragment | |
| 06-495 | unknown | Epiphysis-tibia | Juvenile |
| 06-565 | HMpO | Sesamoid | |
| 06-603 | HMp | Radius | Juvenile-neonate |
| 06-604 | HMp | Rib | |
| 06-628 | HMp | Rib fragment | |
| 06-920 | HFfs | Distal femur | |
| 06-935 | HFp | Thoracic vertebra | |
| 06-947 | HFfsO | Ilium fragment | |
| 06-970 | HFp | Tooth, incisor | |
| 06-998 | HFp | Thoracic vertebra | |
| 06-1002 | HFp | Rib | |
| 06-1059 | HFp | Rib fragment | Rodent gnawing |
| 06-1305 | HMpO | Lumbar vertebra | |
| 06-1326 | HMpO | Metacarpal | Juvenile |
| 06-1369 | HMs | Cervical vertebra | |
| 06-1371 | HMs | Lumbar vertebra | Juvenile |