

**AN ADVISORY SYSTEM FOR SELECTING
DRILLING TECHNOLOGIES AND METHODS IN TIGHT GAS
RESERVOIRS**

A Thesis

by

NICOLAS PILISI

Submitted to the Office of Graduate Studies of
Texas A&M University
in partial fulfillment of the requirements for the degree of

MASTER OF SCIENCE

May 2009

Major Subject: Petroleum Engineering

**AN ADVISORY SYSTEM FOR SELECTING
DRILLING TECHNOLOGIES AND METHODS IN TIGHT GAS
RESERVOIRS**

A Thesis

by

NICOLAS PILISI

Submitted to the Office of Graduate Studies of
Texas A&M University
in partial fulfillment of the requirements for the degree of

MASTER OF SCIENCE

Approved by:

Co-Chairs of Committee,	Stephen A. Holditch
	Catalin Teodoriu
Committee Member,	Yuefeng Sun
Head of Department,	Stephen A. Holditch

May 2009

Major Subject: Petroleum Engineering

ABSTRACT

An Advisory System for Selecting Drilling Technologies and Methods in Tight Gas Reservoirs. (May 2009)

Nicolas Pilisi, BEN, University of Paris and Ecole Normale Supérieure de Cachan, France; MEN, University of Paris and Ecole Normale Supérieure de Cachan, France.

Co-Chairs of Advisory Committee: Dr. Stephen A. Holditch
Dr. Catalin Teodoriu

The supply and demand situation is crucial for the oil and gas industry during the first half of the 21st century. For the future, we will see two trends going in opposite directions: a decline in discoveries of conventional oil and gas reservoirs and an increase in world energy demand. Therefore, the need to develop and produce unconventional oil and gas resources, which encompass coal-bed methane, gas-shale, tight sands and heavy oil, will be of utmost importance in the coming decades.

In the past, large-scale production from tight gas reservoirs occurred only in the U.S. and was boosted by both price incentives and well stimulation technology. A conservative study from Rogner (1997) has shown that tight gas sandstone reservoirs would represent at least over 7,000 trillion cubic feet (Tcf) of natural gas in place worldwide. However, most of the studies such as the ones by the U.S. Geological Survey (U.S.G.S.) and Kuuskraa have focused on assessing the technically recoverable gas resources in the U.S. with numbers ranging between 177 Tcf and 379 Tcf.

During the past few decades, gas production from tight sands field developments have taken place all around the world from South America (Argentina), Australia, Asia (China, Indonesia), the Russian Federation, Northern Europe (Germany, Norway) and

the Middle East (Oman). However, the U.S. remains the region where the most extensive exploration and production for unconventional gas resources occur. In fact, unconventional gas formations accounted for 43% of natural gas production and tight gas sandstones represented 66% of the total of unconventional resources produced in the U.S. in 2006.

As compared to a conventional gas well, a tight gas well will have a very low productivity index and a small drainage area. Therefore, to extract the same amount of natural gas out of the reservoir, many more wells will have to be drilled and stimulated to efficiently develop and produce these reservoirs. Thus, the risk involved is much higher than the development of conventional gas resources and the economics of developing most tight gas reservoirs borders on the margin of profitability.

To develop tight gas reservoirs, engineers face complex problems because there is no typical tight gas field. In reality, a wide range of geological and reservoir differences exist for these formations. For instance, a tight gas sandstone reservoir can be shallow or deep, low or high pressure, low or high temperature, bearing continuous (blanket) or lenticular shaped bodies, being naturally fractured, single or multi-layered, and holding contaminants such as CO₂ and H₂S which all combined increase considerably the complexity of how to drill a well.

Since the first tight gas wells were drilled in the 1940's in the U.S., a considerable amount of information has been collected and documented within the industry literature. The main objective of this research project is to develop a computer program dedicated to applying the drilling technologies and methods selection for

drilling tight gas sandstone formations that have been documented as best practices in the petroleum literature.

DEDICATION

This thesis is dedicated to my family.

ACKNOWLEDGEMENTS

I would like to thank Dr. Stephen Holditch and Dr. Catalin Teodoriu who served as co-chairs of my graduate committee for their advice, guidance, support and help throughout the research.

I wish to thank Dr. Yuefeng Sun for serving as a member of my graduate committee.

I am grateful to Total E&P, The Crisman Institute and Dr. Stephen Holditch, head of the Petroleum Engineering Department, for funding this research.

I also want to extend my gratitude to Christian Chapuis (Total E&P), Steve Rosenberg (Weatherford), Suri Surynarayana, David Lewis, Patrick Brand (Blade Energy Partners), and Rick Watts (ConocoPhillips) for helping me during this research project.

Special thanks go to Baljit Dhami and Philippe Remacle, industry experts who inspired me to go to Texas A&M University. This prestigious institution has played an important part in both my personal and professional development.

I also thank my officemates and classmates for their friendship and support.

TABLE OF CONTENTS

	Page
ABSTRACT.....	iii
DEDICATION.....	vi
ACKNOWLEDGEMENTS.....	vii
TABLE OF CONTENTS.....	viii
LIST OF FIGURES	xi
LIST OF TABLES.....	xvii
1 INTRODUCTION.....	1
1.1 Natural Gas	1
1.2 Unconventional Gas.....	2
1.3 Resource Triangle.....	2
1.4 Tight Gas Reservoirs.....	3
1.5 Importance of Tight Gas Reservoirs	4
1.6 The U.S. as a Reference for Tight Gas Development.....	5
1.7 Problems Encountered When Drilling Tight Gas Reservoirs	7
1.8 Objectives of This Research	9
2 REVIEW OF DRILLING TECHNOLOGIES AND METHODS.....	11
2.1 Introduction.....	11
2.2 Conventional Drilling Technology	11
2.2.1. Introduction.....	11
2.2.2. Discussion	12
2.3 Fit For Purpose Land Rig.....	16
2.4 Slim-Hole Drilling	18
2.4.1. Introduction.....	18
2.4.2. Discussion	19
2.5 Coiled Tubing Drilling Technology.....	22
2.5.1. Introduction.....	22
2.5.2. Discussion	23
2.6 Casing Drilling Technology.....	27
2.6.1. Introduction.....	27
2.6.2. Discussion	28
2.7 Underbalanced Drilling Method	38

	Page
2.7.1. Introduction.....	38
2.7.2. Discussion.....	39
2.8 Managed Pressure Drilling Method.....	43
2.8.1. Introduction.....	43
2.8.2. Discussion.....	43
2.9 Horizontal Drilling Technology.....	47
2.9.1. Introduction.....	47
2.9.2. Discussion.....	47
2.10 Directional Drilling Technology.....	52
2.10.1. Introduction.....	52
2.10.2. Discussion.....	54
2.11 Multi-Lateral Drilling Technology.....	57
2.11.1. Introduction.....	57
2.11.2. Discussion.....	58
2.12 Using Multiple Technologies.....	62
2.12.1. Managed Pressure Casing Drilling Technology.....	62
2.12.2. Underbalanced Casing Drilling Technology.....	62
2.13 General Discussion.....	64
3 DRILLING ADVISORY MODULE.....	67
3.1 Introduction.....	67
3.2 Advisory and Expert Systems.....	67
3.2.1 Introduction.....	67
3.2.2 Expert Systems.....	68
3.2.3 Fuzzy Logic Systems.....	68
3.2.4 “Case-Based” Reasoning.....	69
3.2.5 Drilling Advisory System.....	69
3.3 Advisory System for Selecting Drilling Technologies and Methods.....	70
3.3.1 Introduction.....	70
3.3.2 Project Goal and Interaction with Other Similar Projects.....	70
3.3.3 Development Procedure.....	72
3.3.3.1 Definition of Tasks to Be Performed by the Drilling Module.....	72
3.3.3.2 Development Tool Selection and Programming Language Selection.....	73
3.3.3.3 Decision Chart Creation.....	74
3.3.3.4 Non-Productive Time.....	90
3.3.4 Drilling Advisor Design.....	93
3.3.4.1 Starting Menu.....	93
3.3.4.2 Central Menu.....	93
3.3.4.3 Well Data Screen.....	94
3.3.4.4 Drilling Parameters for Candidate Selection Screen.....	95
3.3.4.5 Technologies and Methods Feasibility.....	98
3.3.4.6 Drilling Time Estimation Sub-Module.....	99
3.3.4.7 Drilling Cost Estimation Sub-Module.....	104
3.3.4.8 Ranking Technologies and Methods Sub-Module.....	109

	Page
4 DRILLING ADVISOR APPLICATION	111
4.1 South Texas Tight Gas Reservoirs.....	111
4.1.1 Wilcox-Lobo Trend Well Data	111
4.1.2 Lobo Field Drilling Advisor Results.....	111
4.2 Wyoming Tight Gas Reservoirs.....	120
4.2.1 Lance Formation in Jonah/Pinedale Anticline Fields Well Data.....	120
4.2.2 Lance Formation Drilling Advisor Results.....	121
4.3 North Texas - Oklahoma Tight Gas Reservoir	130
4.3.1 Cleveland Sands Well Data	130
4.3.2 Cleveland Sands Drilling Advisor Results	131
4.4 Discussion	139
5 CONCLUSION	142
REFERENCES	144
NOMENCLATURE	159
VITA	161

LIST OF FIGURES

FIGURE	Page
Fig. 1—Worldwide look at proven reserves and production (After Oil & Gas Journal 2007).....	1
Fig. 2—The resource triangle featuring unconventional resources as larger volumes, difficult to develop and produce (Wood Mackenzie 2008).....	3
Fig. 3—Tight gas worldwide occurrence (Wood Mackenzie 2008).....	5
Fig. 4—Unconventional gas and tight gas sands share in the U.S. domestic production (After Kuuskraa 2007).....	6
Fig. 5—The main tight gas reservoir basins in the U.S. are located in Texas (East, South and North), New Mexico and the Rocky Mountain region around the states of Colorado, Utah and Wyoming (Spears and Associates 2006).	7
Fig. 6—Rotary drilling process (Bourgoyne et al. 1986).	13
Fig. 7—Top-drive (Tesco 2007).....	14
Fig. 8—Drilling activity in East Texas Basin (Oil & Gas Investor 2006).....	15
Fig. 9—Drilling activity in San Juan Basin (New Mexico Institute of Mining and Technology 2004).....	15
Fig. 10—Built-for purpose rigs in Pinedale Anticline (Ultra Petroleum 2009).	17
Fig. 11—Drilling time to total depth in Piceance Basin using built for purpose rig (After Kolstad et al. 2007).	18
Fig. 12—Slim-hole design for a tight gas field, Wyoming (Weatherl et al. 2005).	20
Fig. 13—Slim-hole completion using solid expandable tubular (EnvertureGT 2008).....	21
Fig. 14—Coiled tubing reel (Xtreme Coil Drilling Corp 2009).	24
Fig. 15—Hybrid coiled tubing rig moving from conventional drilling to coiled tubing drilling (Shafer 2007).....	25
Fig. 16—Horizontal underbalanced operation through coiled tubing drilling (Baihly et al. 2007).	26
Fig. 17—Specially designed casing drilling rig (Tesco 2008).	29

Fig. 18—Internal & external casing drive system (Warren et al. 2005).....	30
Fig. 19—Casing drilling equipment mounted on the rig: casing drive system + top-drive (Tesco 2008).....	30
Fig. 20—Casing drilling technologies comparison (Fontenot et al. 2005).....	31
Fig. 21—Drilling with casing non-retrievable assembly (Weatherford 2006).....	32
Fig. 22—Casing while drilling retrievable drilling assembly, vertical on the left, directional on the right (Tessari et al. 2006).	34
Fig. 23—Lost circulation (Air Drilling Associates 2005).	36
Fig. 24—Stuck pipe (Schlumberger 2008).	36
Fig. 25—Casing drilling application in the Lobo field, South Texas (Fontenot et al. 2003).	38
Fig. 26—Reservoir flowing with underbalanced method (Air Drilling Associates 2005).	39
Fig. 27—Typical underbalanced drilling operation using compressible fluids (Bennion et al. 1996).....	41
Fig. 28—Underbalanced drilling operation conducted in the Cleveland sands, Anadarko Basin (BP 2005).	42
Fig. 29—Drilling windows for managed pressure drilling, underbalanced drilling and conventional drilling (Malloy et al. 2009).	45
Fig. 30—Managed pressure drilling closed loop system on a land rig, (After Arnone et al. 2007).	46
Fig. 31—Horizontal and directional drilling (Biodiversity Conservation Alliance 2003).	48
Fig. 32—Drilling rig located in a sensitive environment, Piceance Basin, Colorado (Oil & Gas Investor 2005).	53
Fig. 33—Multi-well drilling pads in Pinedale anticline field (Questar Energy 2006).	55
Fig. 34—Directional S-shape drilling in Pinedale field, Wyoming (Shell 2005).....	56
Fig. 35—Multi-lateral drilling (Biodiversity Conservation Alliance 2003).....	58
Fig. 36—Dual lateral wellbore in the Sohlingen field, Germany (Heslop 1998).....	60

Fig. 37—Multi-lateral drilling in the Travis Peak formation (TAML 2004).	61
Fig. 38—Underbalanced drilling with casing drilling in a re-entry operation, Vicksburg sands, South Texas (Gordon et al. 2004).	63
Fig. 39—Well design using UBDWC, South Texas (Gordon et al. 2004).	64
Fig. 40—D&C Advisor workflow (Bogatchev 2007)	71
Fig. 41—Drilling advisory system and interaction with other programs	73
Fig. 42—Decision chart for drilling technologies and methods feasibility as a function of wellbore trajectory	78
Fig. 43—Decision chart for possible application of casing drilling technology	79
Fig. 44—Decision chart for possible application of coiled tubing drilling technology to drill production casing or tubing	81
Fig. 45—Decision chart for possible application of coiled tubing drilling technology for sidetrack drilling in directional, horizontal and multilateral wellbores	82
Fig. 46—Decision chart for possible application of underbalanced drilling method for production casing section (After Blade Energy Partners 2008).	86
Fig. 47—Decision chart for possible application of managed pressure drilling method for intermediate casing section	88
Fig. 48—Decision chart for possible application of managed pressure drilling method for production casing section	90
Fig. 49—Source of non-productive time for onshore wells (After Nexen 2008)	92
Fig. 50—Source of non-productive time for onshore wells in the U.S. (After Nexen 2008)	92
Fig. 51—Starting menu	93
Fig. 52—Central menu	94
Fig. 53—Well data sub-module	95
Fig. 54—Drilling parameters for candidate selection sub-module	97
Fig. 55—Add intermediate casing sub-module	97
Fig. 56—Technologies and methods feasibility sub-module	99

	Page
Fig. 57—Drilling time estimation sub-module.....	100
Fig. 58—NPT estimation.....	102
Fig. 59—ROP estimation.....	103
Fig. 60—Drilling cost estimation sub-module.....	106
Fig. 61—Conventional drilling components cost estimation sub-module.....	106
Fig. 62—Casing drilling components cost estimation sub-module.....	107
Fig. 63—Coiled tubing drilling components cost estimation sub-module.....	107
Fig. 64—Managed pressure drilling components cost estimation sub-module.....	107
Fig. 65—Underbalanced drilling components cost estimation sub-module.....	108
Fig. 66—Drilling reference cost normalized to CwO.....	108
Fig. 67—Ranking technology and method sub-module.....	110
Fig. 68—Well data sub-module for a tight gas well in the Wilcox-Lobo trend.....	112
Fig. 69—Drilling parameters sub-module for a tight gas well in the Wilcox-Lobo trend.....	113
Fig. 70—Technology feasibility sub-module for a tight gas well in the Wilcox-Lobo trend.....	114
Fig. 71—Non-productive time estimation sub-module for a tight gas well in the Wilcox-Lobo trend.....	115
Fig. 72—Rate of penetration estimation sub-module for a tight gas well in the Wilcox-Lobo trend.....	115
Fig. 73—Drilling time estimation sub-module for a tight gas well in the Wilcox-Lobo trend.....	116
Fig. 74—Conventional drilling technology cost estimation sub-module for a tight gas well in the Wilcox-Lobo trend.....	117
Fig. 75—Reference drilling cost estimation sub-module for a tight gas well in the Wilcox-Lobo trend.....	117
Fig. 76—Drilling cost estimation sub-module for a tight gas well in the Wilcox-Lobo trend.....	118

Fig. 77—Drilling technologies and methods ranking sub-module for a tight gas well in the Wilcox-Lobo trend.....	120
Fig. 78—Well data sub-module for a tight gas well in the Lance formation	122
Fig. 79—Drilling parameters sub-module for a tight gas well in the Lance formation...	123
Fig. 80—Technology feasibility sub-module for a tight gas well in the Lance formation.....	124
Fig. 81—Non-productive time estimation sub-module for a tight gas well in the Lance formation	125
Fig. 82—Rate of penetration estimation sub-module for a tight gas well in the Lance formation.....	125
Fig. 83—Drilling time estimation sub-module for a tight gas well in the Lance formation.....	126
Fig. 84—Conventional drilling technology cost estimation sub-module for a tight gas well in the Lance formation	127
Fig. 85—Reference drilling cost estimation sub-module for a tight gas well in the Lance formation	127
Fig. 86—Drilling cost estimation sub-module for a tight gas well in the Lance formation.....	128
Fig. 87—Drilling technologies and methods ranking sub-module for a tight gas well in the Lance formation	130
Fig. 88—Well data sub-module for a tight gas well in the Cleveland formation.....	131
Fig. 89—Drilling parameters sub-module for a tight gas well in the Cleveland formation.....	132
Fig. 90—Technology feasibility sub-module for a tight gas well in the Cleveland formation.....	133
Fig. 91—Non-productive time estimation sub-module for a tight gas well in the Cleveland formation.....	134
Fig. 92—Rate of penetration estimation sub-module for a tight gas well in the Cleveland formation.....	134

Fig. 93—Drilling time estimation sub-module for a tight gas well in the Cleveland formation.....	135
Fig. 94—Conventional drilling technology cost estimation sub-module for a tight gas well in the Cleveland formation.....	136
Fig. 95—Reference drilling cost estimation sub-module for a tight gas well in the Cleveland formation.....	136
Fig. 96—Drilling cost estimation sub-module for a tight gas well in the Cleveland formation.....	137
Fig. 97—Drilling technologies and methods ranking sub-module for a tight gas well in the Cleveland formation.....	139

LIST OF TABLES

	Page
TABLE 1—Drilling with casing versus casing while drilling (After Rosenberg 2008) ...	35
TABLE 2—Horizontal drilling application in the Panhandle region, North Texas and corresponding production improvement factor (PIF) (Baihly et al. 2007).....	51
TABLE 3—Horizontal drilling application in the East Texas region and corresponding production improvement factor (PIF) (Baihly et al., 2007).	51
TABLE 4—Drilling technologies and methods advantages and limitations.....	77
TABLE 5—ROP normalized to conventional drilling using overbalanced (CwO)	104
TABLE 6—Cost normalized to conventional drilling using overbalanced (CwO).....	109
TABLE 7—Summary: reservoir and drilling parameters for three field examples.....	140
TABLE 8—Summary: comparison field results and drilling advisory results for three field examples.....	141

1 INTRODUCTION

1.1 Natural Gas

Natural gas will be the fastest growing share of world primary energy consumption for the coming decades. The consumption of natural gas in 2030, at 180 trillion cubic feet, is projected to be nearly 90 percent higher than the 2003 total consumption of 95 trillion cubic feet according to the International Energy Administration in 2007.

Historically, world natural gas reserves have trended upward. As of January 1, 2008, proved world natural gas reserves were estimated at over 6,000 trillion cubic feet with Middle East and Eurasia accounting to about three quarters of the total (Fig. 1).

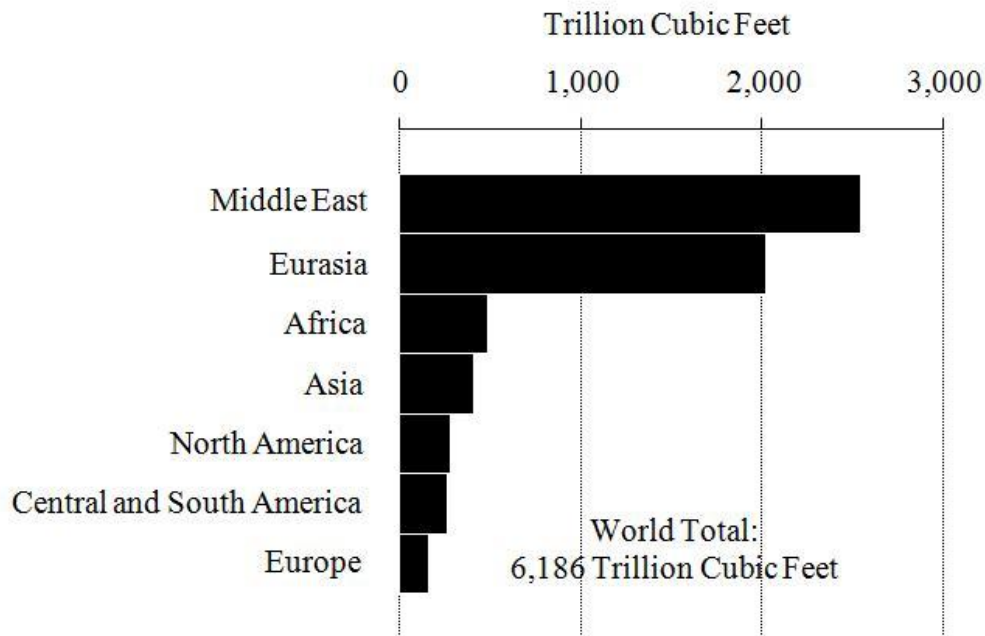

Fig. 1—Worldwide look at proven reserves and production (After Oil & Gas Journal 2007).

1.2 Unconventional Gas

When natural gas resources are more difficult and costly to explore, develop and produce, they are known as unconventional. These gas resources accumulated in low permeability environments are being targeted to contribute a significant part of the U.S. and world's natural gas supply in the near future. There are four different unconventional gas resources: coal-bed methane (CBM), gas shale (GS), methane hydrates (MH) and tight gas (TG).

1.3 Resource Triangle

Since all natural resources are distributed log-normally in nature (Holditch 2006), a resource triangle is often used to visualize the distribution of oil and gas reservoirs. Fig. 2 shows a three level pyramid with on top the “medium” and “high” quality conventional oil and gas reservoirs that constituted most of the development that occurred in the world during the 20th century.

The second level of the pyramid features much larger deposits of hydrocarbons associated with “lower” quality that are more difficult to develop and therefore require a higher price. These formations include heavy oil, coal-bed methane, gas shale and tight gas. To develop the low quality reservoirs economically, operating and contracting companies have to come up with new technologies to drill, complete, stimulate and produce these “unconventional” resources.

The third level represents vast deposits of hydrocarbon (shale oil and gas hydrates) that are currently under investigation but oil and gas price and technologies are not yet mature enough to enable their development.

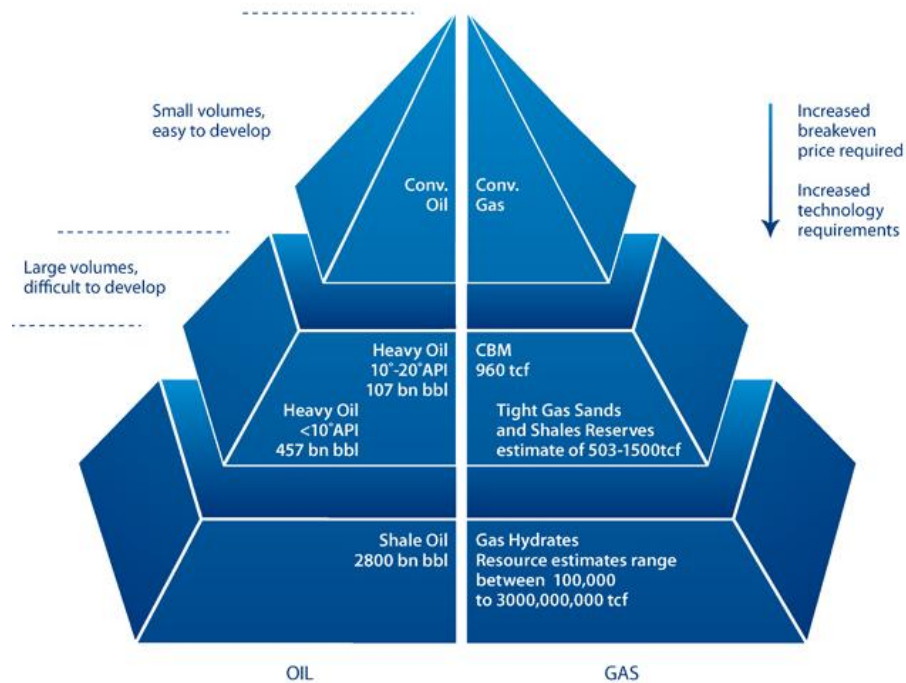

Fig. 2—The resource triangle featuring unconventional resources as larger volumes, difficult to develop and produce (Wood Mackenzie 2008).

1.4 Tight Gas Reservoirs

In general, a gas reservoir is said to be tight when the matrix permeability is in the range of 10-100 micro-Darcy (μd), exclusive of permeability caused by natural fractures. Tight gas reservoirs (TGR) are found throughout the world and can be found in both sandstone and carbonate formations.

Although these resources have been known for many decades, their commercial development was not extensive until the 1970's when the U.S. government came up with a political definition to determine which well would receive federal and/or state tax

credits for producing natural gas from tight gas reservoirs: the cut was for permeability below 0.1 md. In addition, the definition included ranges of maximum allowable flow rates for un-stimulated wells as a function of depth (FERC 1978).

Since the 1970's, technological advancements have enabled a sustained production growth in tight gas reservoirs even in the absence of tax incentives. In fact, production from unconventional gas resources in the U.S. has more than offset a decline in conventional gas production. In a distinguished author series article for the SPE, Holditch (2006) defined a tight gas reservoir as "a reservoir that cannot produce at economical rates nor recover economic volumes of natural gas unless the well is stimulated by a larger hydraulic fracture treatment or produced by use of a horizontal wellbore or multilateral wellbores."

1.5 Importance of Tight Gas Reservoirs

Natural gas is forecasted to be the fastest growing component of world primary energy consumption between the present day and 2030. The industrial and electric power sectors are the largest consumers of natural gas worldwide. Fig. 1 shows that conventional gas reserves are estimated to be above 6,000 Tcf. Rogner (1997) in its study of unconventional gas reservoirs stated that gas from only tight gas formations worldwide accounted for over 7,400 Tcf of natural gas in place. Therefore, constant improvements in technology for identifying, drilling, completing and stimulating tight gas reservoirs in every sedimentary basin will augment the technically recoverable gas resources to replace the conventional gas fields being presently depleted. Hence, the future for tight

gas reservoirs development appears to be bright and will increase significantly all around the world during the first half of the 21st century.

1.6 The U.S. as a Reference for Tight Gas Development

Even though tight gas reservoirs are present all around the globe (Fig. 3) and recent tight gas field developments have taken place in almost every regions (Argentina, Australia, China, Germany, Indonesia, Oman, Russian Federation), they have played an important part as a natural gas source only in the U.S. for the last three decades.

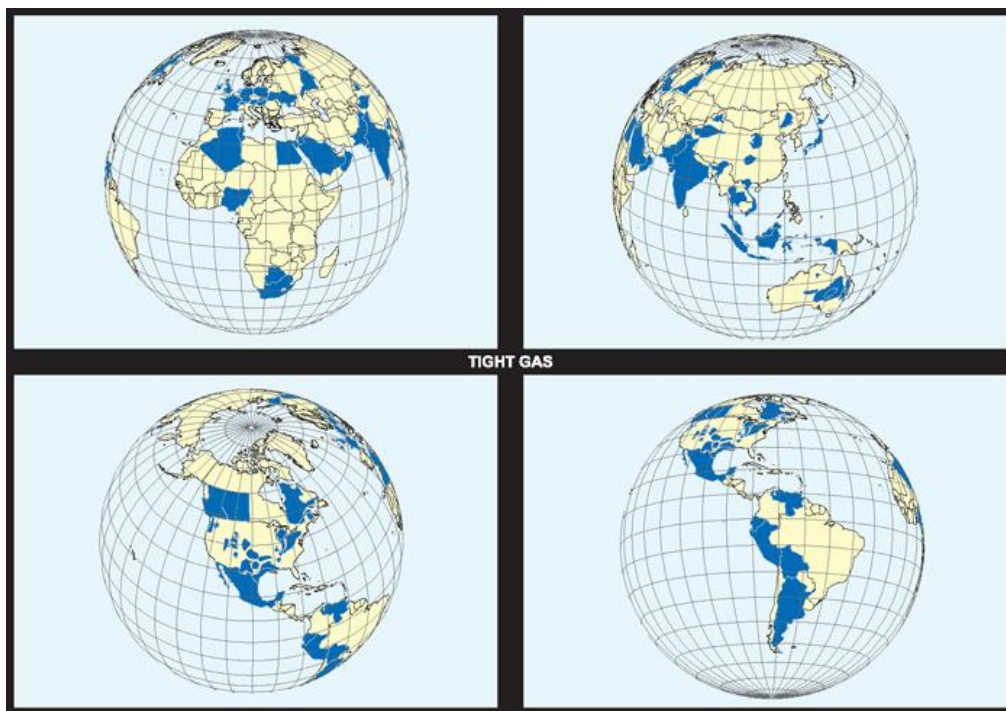

Fig. 3—Tight gas worldwide occurrence (Wood Mackenzie 2008).

The U.S. remains the region where the most extensive exploration and production for non-conventional gas resources and especially tight gas formations has occurred. In fact, in 2006, unconventional gas formations accounted for 43% of natural gas production in which tight gas sandstones represented 66% of the total of non-conventional (Fig. 4).

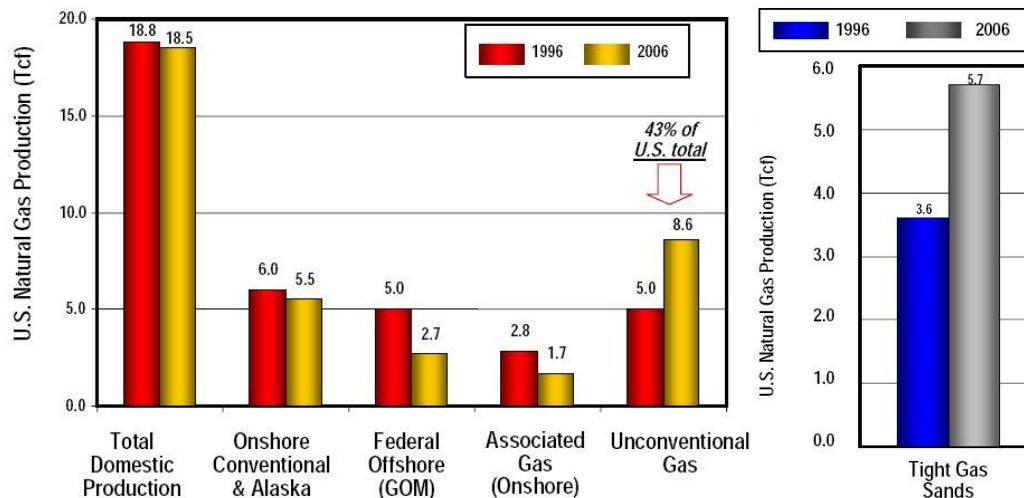

Fig. 4—Unconventional gas and tight gas sands share in the U.S. domestic production (After Kuuskraa 2007).

Fig. 5 shows the repartition of tight gas production in the U.S. as of 2006. Coming in order of importance, we have the East Texas/North Louisiana and South Texas basins, each, accounting for 19% of the total; the Greater Green River basin with 17% of the total; the San Juan basin with 15% of the total; the Appalachian and Permian basins, each, accounting for 5% of the total, the Anadarko, Uinta and Denver basins, each, accounting for 4% of the total, the Wind River basin with 3% of the total, the Arkoma and Piceance basins, each, accounting for 2% of the total, other basins account for 1% of the total tight gas production.

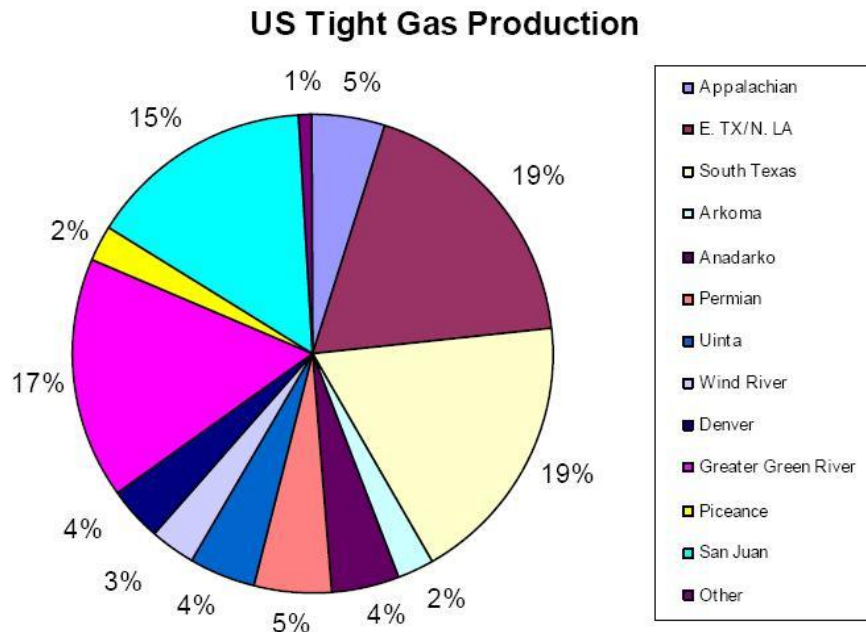

Fig. 5—The main tight gas reservoir basins in the U.S. are located in Texas (East, South and North), New Mexico and the Rocky Mountain region around the states of Colorado, Utah and Wyoming (Spears and Associates 2006).

1.7 Problems Encountered When Drilling Tight Gas Reservoirs

Drilling, completing and stimulating tight gas reservoirs remains a challenge for the petroleum industry because of the high costs and the low volumes that are normally recovered from wells drilled into such reservoirs. In this thesis, we will focus on the drilling process when developing tight gas formations and we will discuss the most important technological developments that address these challenges.

Typical drilling challenges in tight gas reservoirs are as follows:

- Unplanned circulation losses: despite the low permeability of the matrix, lost circulation problems are in fact more prevalent than one would expect in tight

gas reservoirs. The main causes of lost circulation are the presence of natural fractures coupled with field depletion.

- Stuck pipe incidents: the high degree of overbalance especially in depleted formations can also lead to stuck-pipe events.
- Shale sloughing: this problem is more frequent in multi-layered reservoirs where the sand bodies are present within shale strata and the well path has to traverse the shale layer. In particular, shale-sloughing problems can occur when lost circulation calls for a reduction in mud weight. The hole may remain open for a short period, after which the shale deteriorate causing problems in both drilling the well and running the production casing.
- Kicks due to uncertainty in pore pressure: particularly in multi-layered formations, a given well path may traverse through a depleted layer into a layer or lens at virgin or high reservoir pressure.
- Formation damage and mud invasion: especially during the drilling phase, tight formations are good candidates for fluid retention due to the small pore throats and high capillary forces.
- Low drilling penetration rate and drilling bit abrasion: many tight gas reservoirs are located in hard rock areas.

1.8 Objectives of This Research

Developing tight gas reservoirs efficiently and economically is a very complicated engineering problem. For every step that includes geophysics, geology, reservoir, drilling, formation evaluation, completion, stimulation and production, operators use a team of experts to develop an optimum development plan, then to go to the field and execute the plan.

In many cases, especially for tight gas basins outside of the U.S. operating and contracting companies have little experience in tight gas development. As such, the use of an advisory system based on the experience of industry experts and gathering the best engineering practices for each stage (drilling, completion, stimulation and production) could greatly help developing these tight reservoirs. In addition, an advisory system would certainly serve as training or checking tool for young or non-experienced engineers entering the unconventional tight formations business.

In this research, we are creating a Drilling Advisory Module (DAM) for tight gas that is part of a general Drilling & Completion Advisor for unconventional formations. This software, along two other programs called BASIN (basin analogy) and PRISE (resource evaluation) is part of the UGR (unconventional gas resources) Advisor under development at Texas A&M by a team of graduate students and professors.

To complete the Drilling Advisory Module for tight gas reservoirs, this thesis will first identify and review relevant data in the worldwide literature on tight gas reservoirs with strong emphasis on the latest drilling technologies used so far: casing drilling,

underbalanced drilling, managed pressure drilling, horizontal drilling, directional S-shaped drilling (well clusters) and coiled tubing drilling.

Then, we will analyze under which critical parameters one technology has been preferred or is currently being applied in comparison with other drilling techniques. Further, we will extract key criteria and build decisions charts, which mimic the thinking process of an expert drilling group. We will write Visual Basic programs using Microsoft Visual Studio implementing all the decisions charts created during this research. Finally, we will test and validate the Drilling Advisory Module with U.S. tight gas real cases.

2 REVIEW OF DRILLING TECHNOLOGIES AND METHODS

2.1 Introduction

The oil and gas industry constantly develops and implements new technologies and methods to solve drilling problems and decrease drilling costs. In this section, we are going to define, describe and analyze the best drilling practices currently available for drilling tight gas reservoirs.

We will start by studying the best technologies, which are conventional drilling, casing drilling and coiled tubing drilling. Then, we will review two other technologies, which are underbalanced drilling and managed pressure drilling. In addition, we will describe the wellbore trajectories that can be used to reach the productive zones: horizontal, directional and multi-lateral drilling. Moreover, we will discuss add-on technologies that assist and improve the process of drilling or designing a wellbore such as new built for purpose rigs and expandable tubular goods. Finally, we will discuss the possible technology blends between these technologies and methods.

2.2 Conventional Drilling Technology

2.2.1. Introduction

Most wells are drilled with conventional rotary technology. The conventional or rotary drilling process can be used in every type of reservoir (sandstones, carbonates, unconventional) and is usually associated with overbalanced conditions where the

equivalent drilling mud weight is greater than the fluid formation pressure gradient but is less than the fracture gradient pressure.

The Persian and the Chinese civilizations had already drilled hydrocarbons reservoirs centuries before the Common Era. However, it was in 1859 when E.L. Drake and his crew drilled the first modern oil well in Titusville, Pennsylvania using a cable-tool rig or drill bit percussion drilling (Brantly 2007). The cable hung from the top of a wooden structure called a derrick. The tool was raised and dropped, thus breaking the rock into small pieces. This early technology was replaced early in the 20th century by the rotary drilling process, which is still the technology used in oil and gas well drilling.

2.2.2. Discussion

As defined by the Society of Petroleum Engineers in their “Advanced Drilling Engineering” Textbook and shown in Fig. 6: “The hole is drilled by rotating a bit to which a downward force is applied. Usually, the bit is turned by rotating the entire drill string” (many joints of steel alloy), “using in general a rotary table at the surface, and the downward force is applied to the bit by using sections of heavy-cylinders, called drill collars, in the drill string above the bit. The cuttings are lifted to the surface by circulating a fluid down the drill string, through the bit, and up the annular space between the hole and the drill string.” (Bourgoyne et al. 1986).

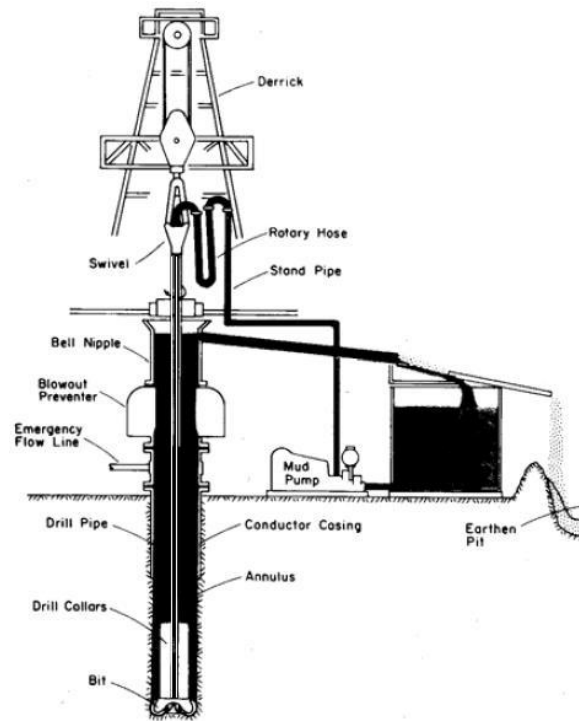

Fig. 6—Rotary drilling process (Bourgoyne et al. 1986).

Two main systems are currently used to rotate the drill bit. As of 2007, for onshore drilling, 55% of the drilling rigs are equipped with a rotary table and Kelly-bushing while 45% used the top-drive technology. As illustrated in Fig. 7, “a top drive is a hydraulic or electric motor suspended in the derrick mast of a drilling rig, which rotates the drill string and bit and is used in the actual process of drilling the well. Using a top drive eliminates the need for the traditional Kelly-bushing and rotary table and reduces the amount of manual labor and associated hazards that have traditionally accompanied this task.” (Tesco 2007).



Fig. 7—Top-drive (Tesco 2007).

Rotary drilling technology has over a century of application and is well known by drilling personnel. Rotary drilling technology is currently said to be the lowest cost technology on the market and can be used with all wellbore trajectories. Even though conventional technology works very well most of the time, conventional overbalanced drilling technology comes with several disadvantages. First, it often creates drilling problems such as lost circulation, differential sticking, or well control issues. Other issues are possible such as low penetration rates when hard rock formations are encountered or difficulties to handle pressure regime when changes occur along the formations. Indeed, conventional technology cannot deal with highly pressured or severely depleted formations without creating formation damage or impairment.

Conventional overbalanced rotary drilling has been the most cost effective practice for decades until the beginning of the 1990's. As shown in Fig. 8 and Fig. 9, respectively, the East Texas Basin and the San Juan Basin are two regions in the U.S. that

can testify of large-scale vertical conventional overbalanced drilling program where thousands of wells were drilled to access tight gas reservoirs.

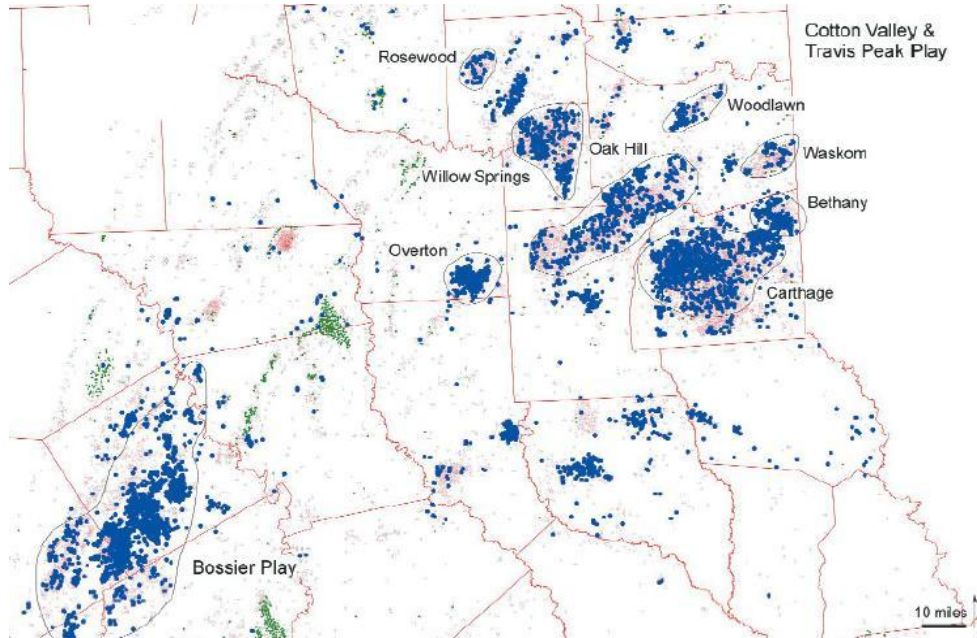

Fig. 8—Drilling activity in East Texas Basin (Oil & Gas Investor 2006).

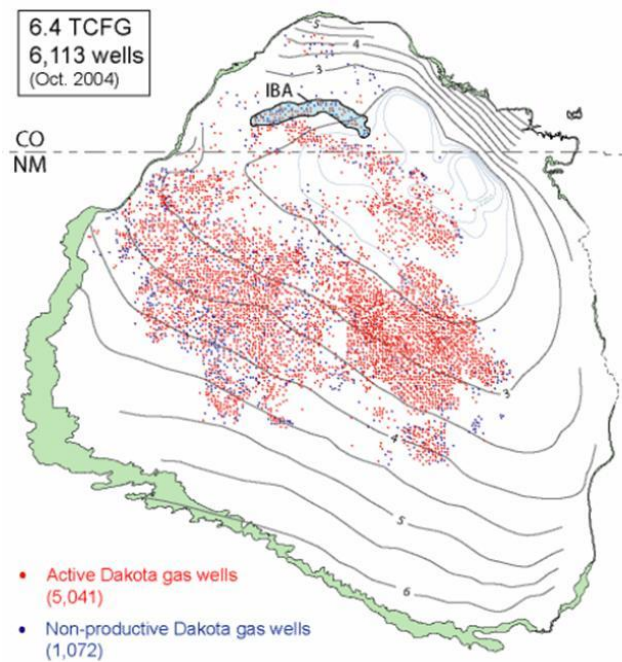

Fig. 9—Drilling activity in San Juan Basin (New Mexico Institute of Mining and Technology 2004).

Therefore, rotary drilling technology is always a candidate to consider for unconventional gas development. Nonetheless, under certain circumstances, conventional technology will have to be compared with others drilling technologies and methods that could work better by solving disadvantages mentioned previously.

2.3 Fit For Purpose Land Rig

New drilling rig technology that has the ability to change the landscape of tight gas reservoirs development is now available. For the last few years, drilling rig contractors have been working in partnership with operating companies to design and build “fit for purpose” land rigs which integrate the latest technologies coming from the offshore rig technology which include top drive, automated tubular handling, satellite data transmission and alternating current power systems, just to name a few of the improvements (Kolstad et al. 2007).

One of these new land rigs is called FlexRig4 and is manufactured by Helmerich & Payne. This rig is routinely used in the development of tight gas reservoirs in the San Juan basin and the Piceance basin. A second rig is the RapidRig from National Oilwell Varco designed for application in the shallow unconventional tight formations. A third rig is the Huisman-Itrec LOC 250, a casing-drilling rig currently working in tight gas formations of South Texas.

This new generation of drilling rigs is mainly dedicated for drilling holes ranging from 5,000 to 14,000 feet, which is the usual tight gas reservoirs depth range. These rigs possess large hydraulic pump capacity, fuel-efficient equipment, better directional drilling ability as well as customization for underbalanced drilling and coiled tubing

drilling operations. In addition, part of the evolution is the reduction in size of all the major rig components, which lowers weight and cost to move the rigs. In addition, the rig crew is kept to a minimum with three to four men operating in order to reduce labor cost and improve safety. Moreover, ingenious skid systems allow the motion of the rig in four directions (Williams Energy 2006). Fig. 10 shows an example of pad drilling application in the Pinedale Anticline, Wyoming using two built-for purpose drilling rigs to drill between two and three dozens of directional S-shaped wells from one surface pad where production facilities are shared.



Fig. 10—Built-for purpose rigs in Pinedale Anticline (Ultra Petroleum 2009).

The following chart in Fig. 11 illustrates the efficiency of built-for purpose drilling rigs in the Piceance basin. In 1994, conventional drilling rigs drilled tight gas reservoirs in about 30 days to a total depth of 10,000 ft. In 2006, improved conventional drilling rigs and conventional drilling technology performed much better averaging only

13 days to access tight gas reservoirs at depths of 10,000 ft. Finally, the same year, in 2006, the new built-for purpose rigs decreased even more the total drilling time and reached total depth in about 8-9 days.

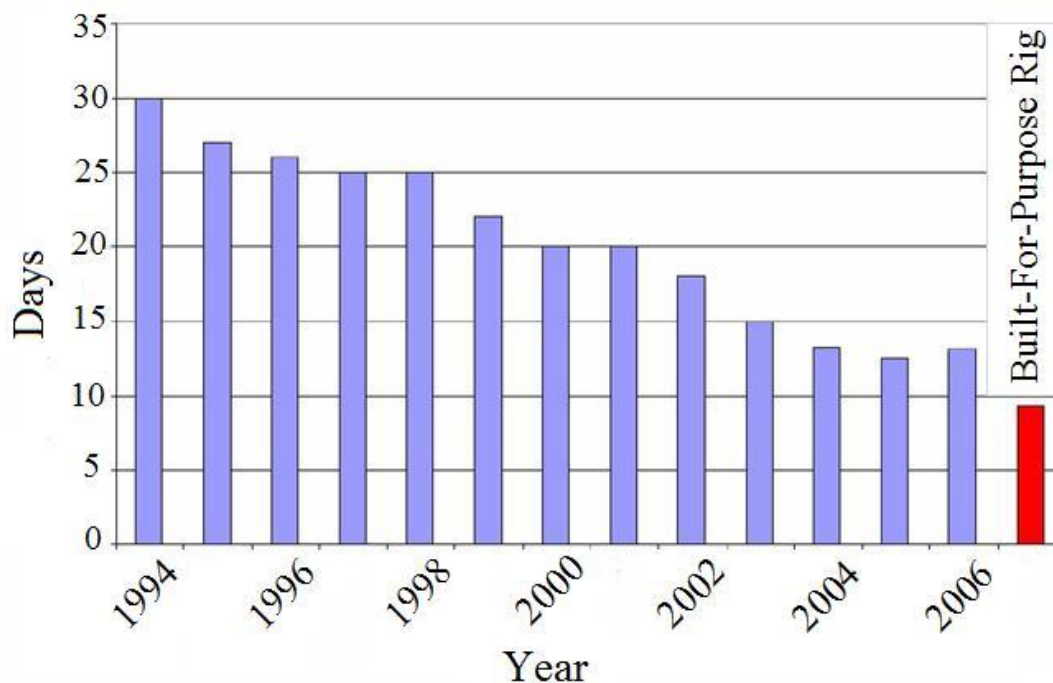

Fig. 11—Drilling time to total depth in Piceance Basin using built for purpose rig (After Kolstad et al. 2007).

2.4 Slim-Hole Drilling

2.4.1. Introduction

To recover a reasonable percent of the gas-in-place in a tight gas field, a large number of wells have to be drilled. To make a profit, the cost to drill and complete each well has to be minimized. Technologies such as slim-hole drilling that allow reducing hole sizes, which help to reduce the overall well, cost are important when drilling many unconventional tight sandstone reservoirs.

Slim-hole drilling was used as early as the 1960's in the United States. For instance, about 1,300 shallow wells were drilled in Texas, Kansas and Canada using slim-hole drilling where 2-1/2 to 2-7/8 inch casing (1,000 to 3,000 ft) was used to complete the wells. Operators realized a 17% cost savings overall. In Indonesia, in the mid 1980's, using slim-hole drilling allowed Conoco to realize cost reductions of 70%. In the Gulf of Thailand, in 1999, Unocal used slim-holes, realizing over 40% savings (Hibbeler et al. 2004).

2.4.2. Discussion

To establish the definition of slim-hole drilling, we have reviewed the petroleum literature. According to the Society of Petroleum Engineers and the National Energy Technology Laboratory, slim-hole drilling is usually defined as a well with more than 90% of the overall measured depth with casing size less than 7 in (Long 2005). The rig used can be a conventional rig or a smaller size specially designed rig.

Fig. 12 shows a typical example of an application of slim-hole well design. The original well design required four strings of casing using 20 in surface casing, two intermediate casing strings with first, a 13-3/8 inch casing and then, a 9-5/8 inch casing; finally, a 7 in production casing was set at total depth. The slim-hole well design used only three strings of casing and one liner. The design started with a smaller surface casing size (16 in), continued with a first intermediate casing (9-5/8 in) and a second intermediate casing (7 in); finally, the production liner was 4-1/2 in, in size, which is much smaller than the production casing size chosen for the original design.

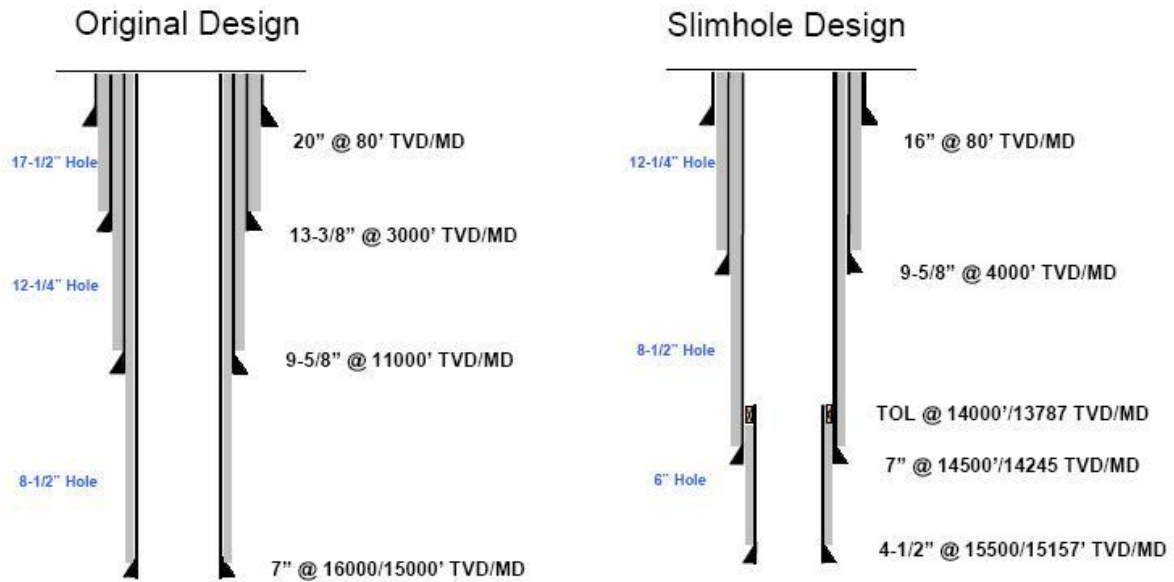

Fig. 12—Slim-hole design for a tight gas field, Wyoming (Weatherl et al. 2005).

To design slim-hole wells, the well construction engineer can use either conventional casing or solid expandable tubular technology. The expandable technology came from the automotive industry. The technology has been developed to design wells with fewer casing strings and has been successful in some deepwater and long extended-reach drilling wells. During a cold-drawing process, the pipe made of steel is pushed beyond its elastic limit. Even though plasticized and permanently deformed with a solid tapered cone (the cone is pumped through the casing or the liner) the material remains below its ultimate tensile strength (EnvertureGT 2008). Thus, wells are equipped with smaller casing size and have a smaller diameter. The main drawback is the cost of this technology, which still remains high and does not always offset the savings realized by drilling smaller wells. Therefore, because of the cost, expandable casing is not used very often in tight gas sand reservoirs where drilling and completion costs have to be minimized to make a profit.

The following Fig. 13 illustrates the application of solid expandable tubular where a liner or a casing is run through an existing casing string already set in the hole. Then, a solid expansion cone is pumped through the liner or the casing and is going to set this liner or casing in the hole. Many times, expandable casing is used to seal off lost circulation intervals.

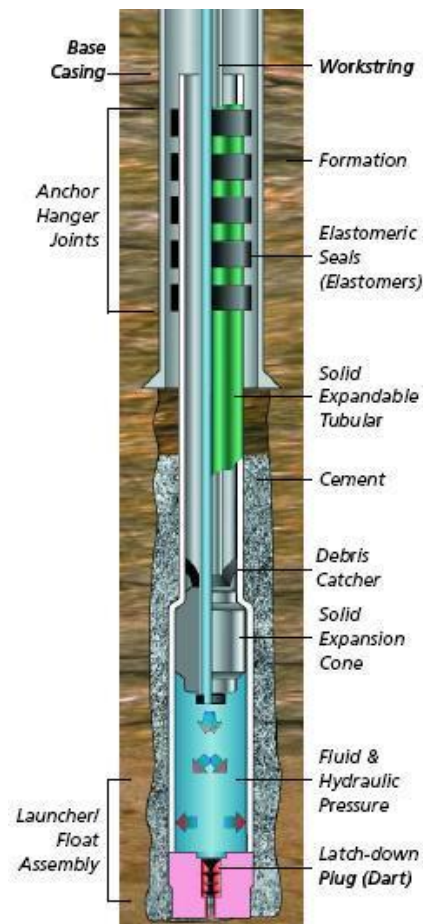

Fig. 13—Slim-hole completion using solid expandable tubular (EnventureGT 2008).

One of the benefits to slim-hole drilling is that a smaller hole size will result directly in a higher rate of penetration and a decrease in well cost. Most of the tight gas sandstone reservoirs use slim-hole drilling technology running production casing on the size of 4-1/2 to 5-1/2 in. Furthermore, recent developments in the Rocky Mountain region

have used multi small-size lateral wellbores to drain the multi-layered pay zones (BP 2007). The idea of drilling and completing a slim wellbore has been around in the industry for decades but is now technically achievable in many applications due to the maturity of coiled tubing drilling technology.

2.5 Coiled Tubing Drilling Technology

2.5.1. Introduction

Coiled tubing drilling (CTD), which is actually a combination of slim-hole drilling and continuous drill-stem concepts, seems set to provide the well construction engineer a number of economic advantages and health, safety and environmental (HSE) benefits under certain conditions. The main idea of coiled tubing drilling is to replace the standard 30 or 40-foot long jointed casing by a continuous flexible tube made of steel. A down-hole motor is used to rotate the drilling bit since it cannot be rotated from surface. When tripping is required the coiled tubing is rolled/wound or unrolled from a large reel at surface (ICOTA 2005).

In 1944, British engineers developed long and continuous pipelines to transport fuel from the United Kingdom to the European continent in order to supply the allied armies. This continuous flexible pipeline project provided the foundation for future developments of today coiled tubing technology. In 1962, in California, the first coiled tubing unit was developed to wash out sand bridges in wells. Currently, well service and work-over operations still account for 75% of coiled tubing applications (ICOTA 2005). However, coiled tubing drilling is increasing among the drilling industry with numerous applications in unconventional heavy oil reservoirs of Canada and Venezuela through

multi-lateral drilling technology (Brillon et al. 2007) and in Prudhoe Bay oil field on Alaska's North Slope (Rixse et al. 2002).

2.5.2. Discussion

Coiled Tubing (CT) has been defined by the Intervention and Coiled Tubing Association (ICOTA 2005) as “any continuously-milled tubular product manufactured in lengths that require spooling onto a take-up reel”. Tubing diameter usually ranges from 0.75 in to 4 in and reel tubing may have lengths up to 30,000 ft. Common coiled tubing steels have yield strengths ranging from 55,000 psi to 120,000 psi. A coiled tubing unit is comprised of four basic elements: a reel for storage and transport of the coiled tubing, an injector head which provides the surface drive force to run and retrieve the coiled tubing, a power pack that generates hydraulic and pneumatic power to operate the coiled tubing unit and finally a control cabin (ICOTA 2005).

Fig. 14 shows a massive coiled tubing reel used to reach well depths greater than 10,000 feet in certain application in North America (Texas, the Rocky Mountain Region in the U.S. and the Alberta province of Canada) and Mexico (Chicontepepec field) (Xtreme Coil Drilling 2009).

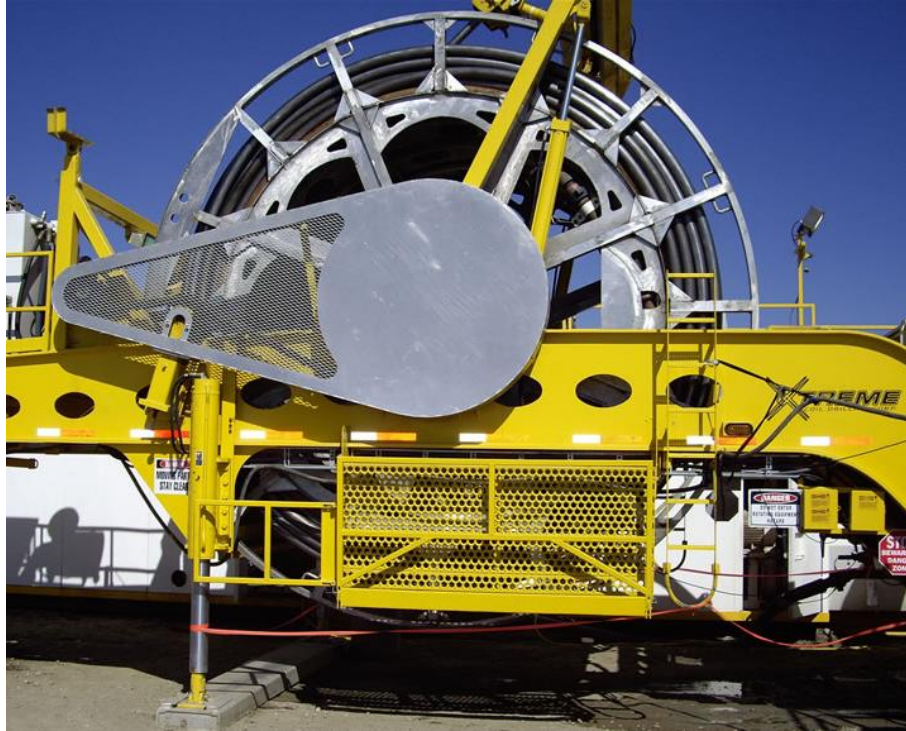

Fig. 14—Coiled tubing reel (Xtreme Coil Drilling Corp 2009).

Coiled tubing drilling (CTD) has been used for several years because it provides a new way to significantly improve economics when used in the proper application. The technology uses a conventional drilling assembly with a down-hole motor. One difference is that coiled tubing drilling uses higher bit speeds at lower weight on bit due to the structural differences in coiled tubing compared to jointed pipe (ICOTA 2005).

A hybrid coiled tubing drilling rig is a unit that can drill conventionally using rotary drilling technology or drill with coiled tubing. Typically, surface and intermediate holes are drilled conventionally, using a top-drive. The largest units currently on the market are set-up for 7,000 feet with 3-1/2 or 4-1/2 in coiled tubing and 10,000 feet with 2-7/8 in coiled tubing (Brillon et al. 2007; Xtreme Coil Drilling 2008). Hybrid coiled tubing drilling technology's goal is to merge the respective benefits of both conventional

drilling and coiled tubing drilling; conventional drilling can be faster and less expensive for large hole diameter while coiled tubing drilling associated with overbalanced or underbalanced conditions is faster and less expensive to drill the reservoir interval. The following Fig. 15 shows a hybrid coiled tubing drilling rig application in western Canada to drill directional wells using this technology. The hybrid rig shown in Fig. 15 is switching from conventional drilling to coiled tubing drilling technology.



Fig. 15—Hybrid coiled tubing rig moving from conventional drilling to coiled tubing drilling (Shafer 2007).

Coiled tubing drilling and hybrid coiled tubing drilling technologies present many advantages. Among the advantages is a faster mobilization and demobilization of the drilling components. In addition, tripping times are faster than can be achieved with conventional technology. Moreover, using coiled tubing drilling improves safety, lowers the footprint impact and enables underbalanced conditions. The main disadvantages are

the depth limitation, the coiled tubing size restriction and the mechanical issues associated, buckling and fatigue notably.

Coiled tubing drilling or hybrid coiled tubing drilling have shown the best results when drilling small diameter wells and reducing rig footprint are essential; and has also proven to be an optimal choice for re-entering or sidetracking wells and drilling reservoirs under underbalanced conditions. Besides, coiled tubing drilling implementations in tight gas reservoirs were, as of today, only for re-entry wellbores as shown in Fig. 16 and sidetracks from mother-bore in multi-lateral implementations (BP 2005 and 2007). The best targets for coiled tubing drilling technology are the multi-layered and highly depleted tight gas reservoirs.

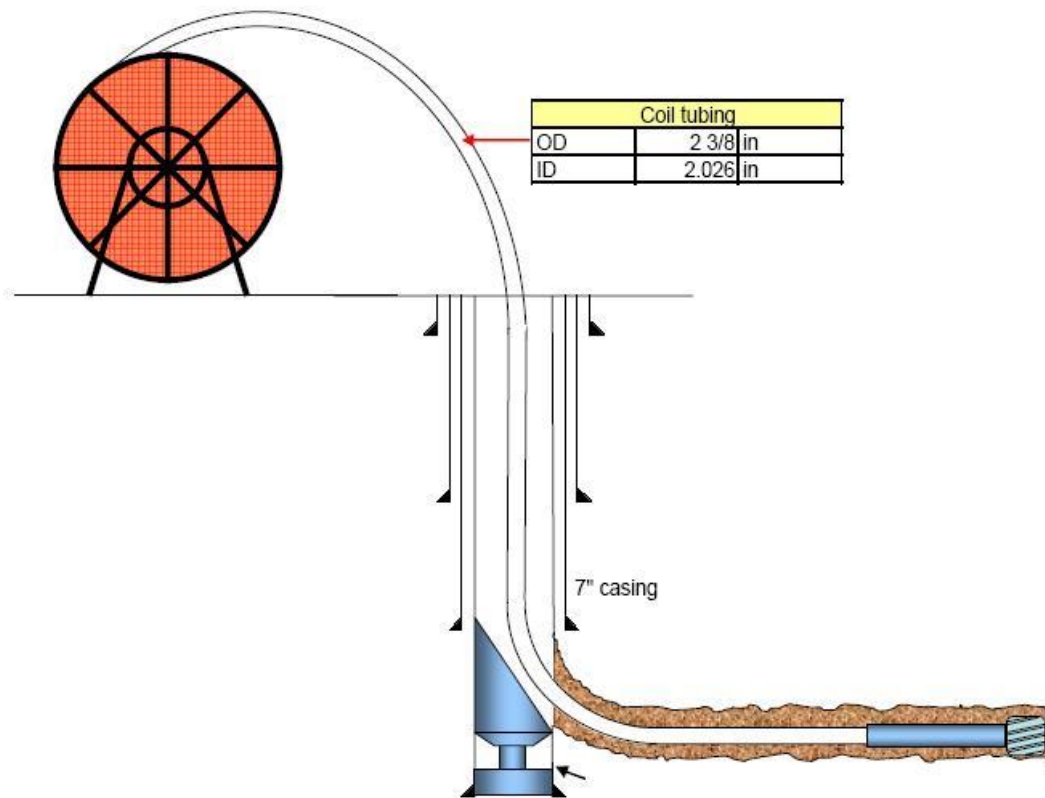

Fig. 16—Horizontal underbalanced operation through coiled tubing drilling (Baihy et al. 2007).

2.6 Casing Drilling Technology

2.6.1. Introduction

Casing drilling is probably the technology that has grown from pilot projects to large-scale field development at the fastest rate within the drilling industry in recent years. Since the rotary process was introduced in the late 1800's, some drillers have dreamed about a system that could allow one to simultaneously drill and case a well by using conventional oilfield casing as the drill-string (Tessari et al. 2006). Several patents that describe the casing-drilling concept were filed early on in the oil industry. For instance, one patent dated from 1890 describes a rotary drilling process for drilling with the casing and then retrieving an expandable bit (U.S. Patent 443,070).

In Russia, during the 1930's, engineers wanting to reduce the time spent tripping to replace bits began the development of a system for replacing the drill bit without having to trip the drill-string (U.S. Patent 1,766,253). However, it was just in the late 1960's that the first development of all the surface and down-hole components needed to drill with casing was actually developed. The casing-drilling system included an electric top-drive for rotating the casing with, a system to grip the casing without using its threads and a wire-line retrievable BHA using an under-reamer to enlarge the borehole. However, due to many factors these technologies failed to find field applications until recently (Tessari et al. 2006).

In the mid 1990's, two contracting companies Weatherford and Tesco, both developed similar casing drilling systems inspired from the work described previously and convinced several operating companies to try this new technology. Mobil Oil, BP

and Conoco used successfully this technology for either liner or casing drilling through salt zones offshore in the Gulf of Mexico or for lost circulation problems in tight gas reservoirs in South Texas (Fontenot et al. 2003). Currently, casing drilling technology has been used with great success in several regions for different reservoirs both offshore and onshore; mainly throughout the U.S., in Canada, in the Gulf of Thailand and Brazil.

2.6.2. Discussion

Casing drilling uses down-hole and surface components allowing to application of standard oil field casing as the drill-string; hence, the well is drilled and cased simultaneously. The casing is rotated from the surface with a top-drive while drilling fluid is circulated down the casing and up the annulus just as the process used for conventional drilling with drill-pipe (Warren et al. 2001).

One of the main differences between drilling with a conventional drill-string and drilling with casing is that drill collars are not used to provide weight-on-bit for casing drilling. The casing used during the casing drilling process is generally the same (size, weight, and grade) that would normally be used for setting casings in a conventionally drilled well. However, the connections for the casing strings may be different. Generally eight-round connections are replaced with buttress connections that include a torque ring for additional torque capacity but other connections such as premium integral or coupled connections may be used as well. The drilling rigs used for the casing drilling process can be either specially designed to apply this technology as shown in Fig. 17 or be modified from conventional rigs (Warren et al. 2001).



Fig. 17—Specially designed casing drilling rig (Tesco 2008).

On the rig, the most important component is the casing drive system (CDS) which supports the full weight of the casing string, applies torque for both drilling and make-up and provides connection between the top-drive and casing string as shown in Fig. 19. There are two types of casing drive systems: internal for casing radius above 9-5/8 in and external for smaller casing radius as shown in Fig. 18. Moreover, the casing drive system includes a slip assembly, which grips the interior of large casing or the exterior of small casing. An internal spear assembly provides a fluid seal to the pipe. Hence, connections are made in a similar manner when compared to conventional drill-pipe connections; therefore, rig floor activity is minimized while making a connection and rig safety is improved (Tesco 2008).

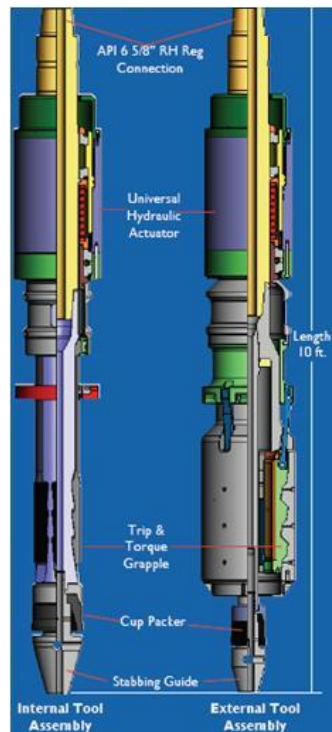

Fig. 18—Internal & external casing drive system (Warren et al. 2005).



Fig. 19—Casing drilling equipment mounted on the rig: casing drive system + top-drive (Tesco 2008).

Two main systems currently share the casing drilling market: rotating the casing at surface to transmit torque to the drilling bottom-hole assembly (BHA) (Weatherford), or having a retrievable BHA latched inside the casing that incorporates a motor that drives a conventional bit and an under-reamer (Tesco). Fig. 20 sketches both casing drilling technologies and conventional drilling.

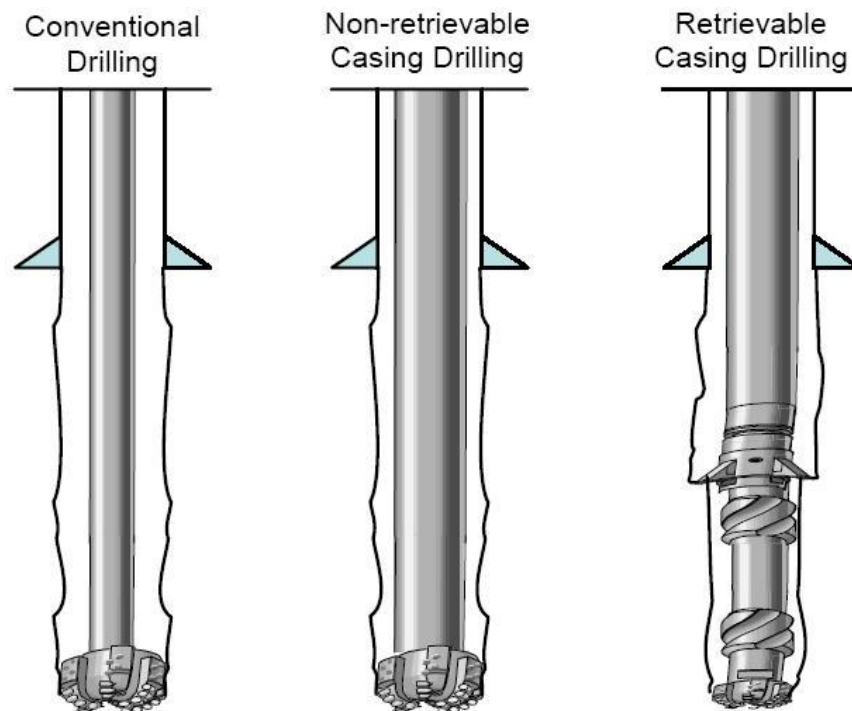

Fig. 20—Casing drilling technologies comparison (Fontenot et al. 2005).

The Weatherford drilling with casing (DwC) system has been designed to be applied for multi-well drilling on offshore platforms, multi-well operations on land (unconventional resources development), and more recently, for deep-water operations. The drilling with casing system is used for applications where specific hole sections are drilled with casing when drilling problems are encountered. Usually, 9-5/8 to 13-3/8 inch casing are run to depths of no more than 15,000 feet while 16 to 20 inch casing are limited to depths of 5,000 feet or less. The drilling with casing system rotates the casing

at surface and incorporates at the end of the drilling assembly (BHA) a drillable drill-shoe as shown in Fig. 21. This drill-shoe comes in three different sizes and thus allows a one trip drilling system, which is cemented in place at casing point depth, and drilled out conventionally later on with the next drilling assembly (Weatherford, 2005-2009).

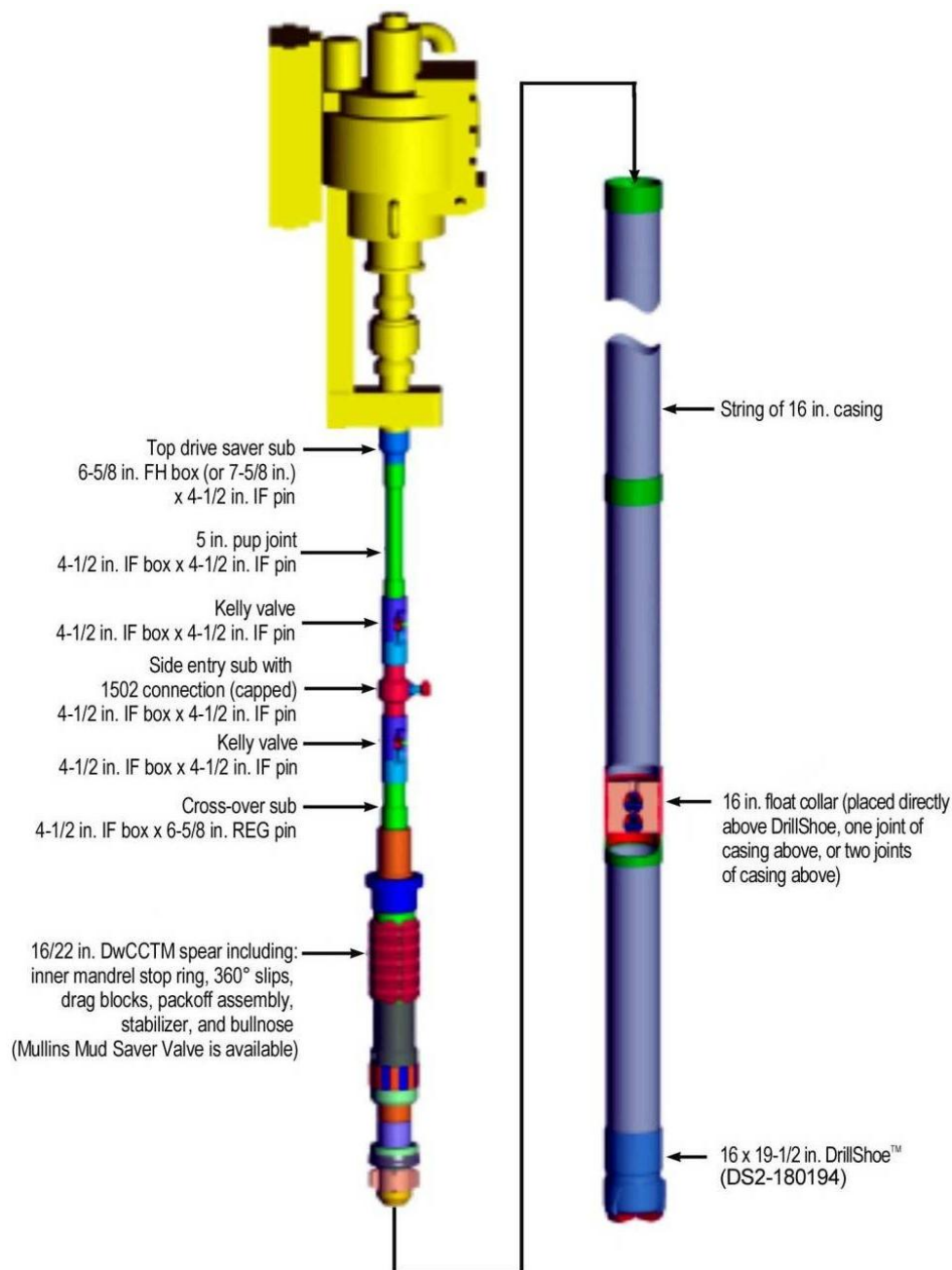

Fig. 21—Drilling with casing non-retrievable assembly (Weatherford 2006).

Tesco developed the casing while drilling (CwD) system. This system has proven to be a very efficient method for solving drilling problems such as lost circulation, stuck pipe, reducing drilling time and cost. Casing while drilling has mainly been used in onshore applications where hundreds of wells are drilled for developing tight gas reservoirs (Fontenot et al. 2003). CwD applications range from drilling shallow wells to wells as deep as 13,000 feet. For the casing while drilling process, a retrievable drilling assembly consists of a pilot bit with an under-reamer located above it in order to open the hole to the final well-bore diameter. The casing while drilling tools are designed to be retrieved with a wire-line to allow the BHA to be run under any normal well condition. This drilling assembly is attached to the casing with a special latching tool and eliminates borehole damage. As the hole is deepened and the casing string is drilled down, joints of casing are added with a casing drive system located just below the top-drive. Fig. 22 presents two different casing while drilling assemblies. On the left side of Fig. 22, the casing while drilling assembly (mainly DLA + Under-reamer + PDC bit) is designed for drilling vertical wells while on the right side of Fig. 22, the casing while drilling assembly (mainly DLA + Motor + Under-reamer + MWD + RSS + PDC bit) is designed for drilling directional wells.

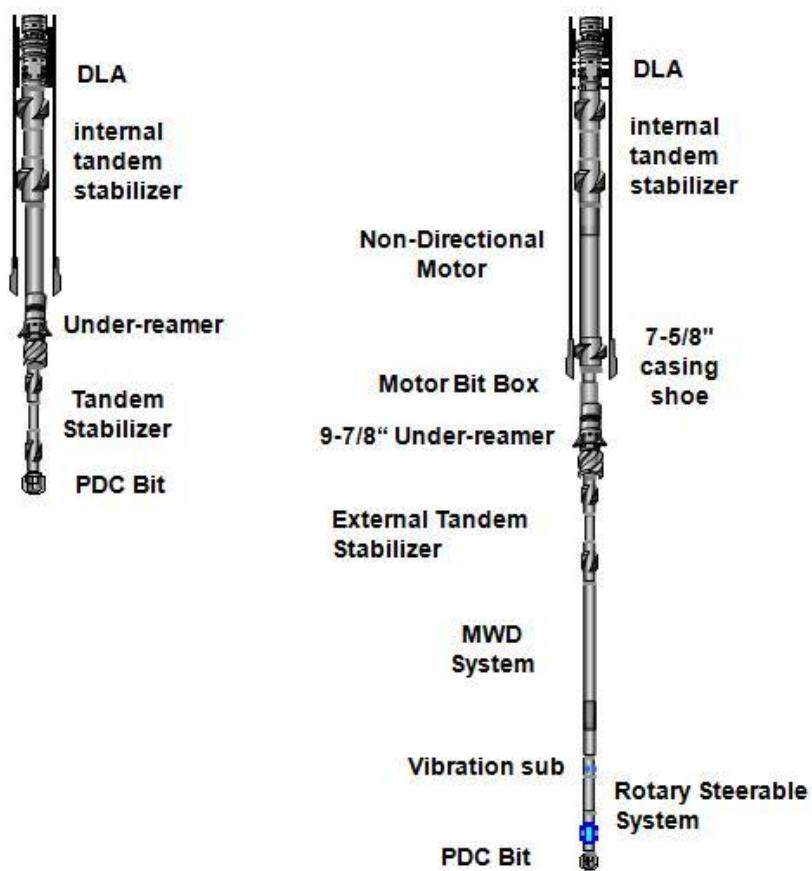

Fig. 22—Casing while drilling retrievable drilling assembly, vertical on the left, directional on the right (Tessari et al. 2006).

The following Table 1 summarizes the main benefits and limitations for both casing-drilling techniques available. Usually, drilling with casing is used to drill only a specific section of the wellbore while casing while drilling is used to drill from surface to total depth.

TABLE 1—Drilling with casing versus casing while drilling (After Rosenberg 2008)	
Drilling with Casing	Casing while Drilling
ADVANTAGES	ADVANTAGES
Low cost	Ability to steer
Simple to operate	MWD/LWD capability
No rig modification required	Wide range of bits selection to suit formation and distance
Zero risk of irretrievable tools in the hole	DISADVANTAGES
Cementing can start after TD is reached	Higher rig cost
DISADVANTAGES	More complicated to set-up and operate
Directional capability limited	Risk of irretrievable tools left in the hole
Cased hole logs only	Unable to cement after TD is reached
Limited drill-shoe selection	

The advantage of casing drilling is its ability to decrease drilling problems and specifically lost circulation and stuck pipe. Lost circulation involves a decrease in drilling fluid flow in the annulus as some or all of the mud exits the wellbore and enters a formation or a natural fracture. Fig. 23 illustrates a lost circulation zone where drilling mud leaks into the formation and migrates in the fractures near the wellbore region. In fields, where pay zones have very different pressure characteristics (some being severely depleted and others are at original pressure), drilling conventionally may lead to lost circulation. When drilling fluid invades the reservoir, formation damage can occur. If casing drilling is used to drill through low-pressure zones, the amount of mud loss can be minimized.

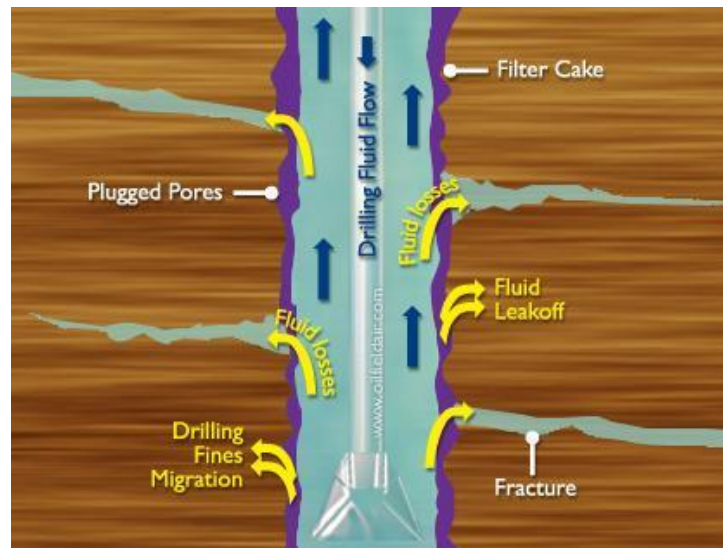

Fig. 23—Lost circulation (Air Drilling Associates 2005).

Differential sticking or stuck pipe incidents occur when the drill-string or the drill-collars become stuck against or within the filter cake formed within the borehole when overbalanced method is used as shown in Fig. 24. Thus, the drill-string or the drill-collars cannot be moved or rotated due to a difference between low reservoir pressures and high wellbore pressures.

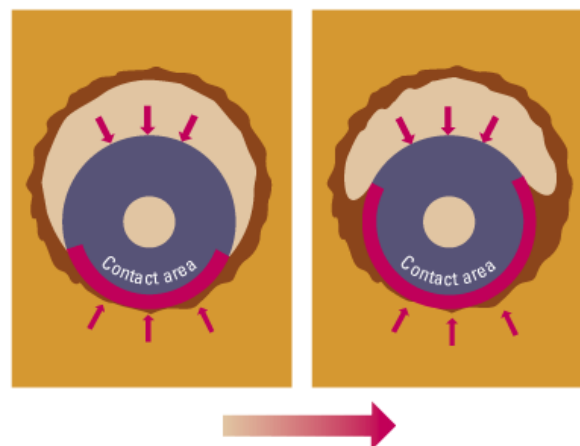

Fig. 24—Stuck pipe (Schlumberger 2008).

Drilling technologies such as casing drilling technology, underbalanced drilling and managed pressure drilling technologies that will be discussed later in this section can reduce or eliminate lost circulation and differential sticking significantly and therefore reduce drilling time and cost. Since casing drilling technology has proven to be successful with minimal drilling and well control problems (incidents are avoided with the casing drilling technology because tripping pipe is eliminated), the risk analysis associated with the casing design may lead to a better casing program. Thus, casing drilling requires fewer casing strings to be set thus reducing costs by allowing the well design with fewer and smaller casing (Tessari et al. 2006). Besides, the drilling crew needs a special training to be familiar with casing drilling components.

The tight gas reservoirs of South Texas have been the location where casing drilling first achieved widespread use and success. Indeed, the largest single casing drilling field application has been implemented using the casing while drilling system in the Wilcox-Lobo fields. Typically, fields have several lost circulation zones interspersed in these tight sandstone reservoirs (Fontenot et al. 2003). Casing while drilling technology proved that lost circulation was almost totally eliminated in the field. Thus, casing while drilling technology avoided running additional intermediate casings or liners to reach the planned intermediate casing point as shown in Fig. 25. Equally, stuck pipe incidents have been negligible using drilling with casing in comparison with conventional drilling technology. In addition to these resolved issues, the speed of drilling and the amount of gas production were improved. After this large-scale field application, it took little time for casing drilling technology to spread out and be applied to others low permeability reservoirs; notably those of New Mexico and the Rocky Mountains region.

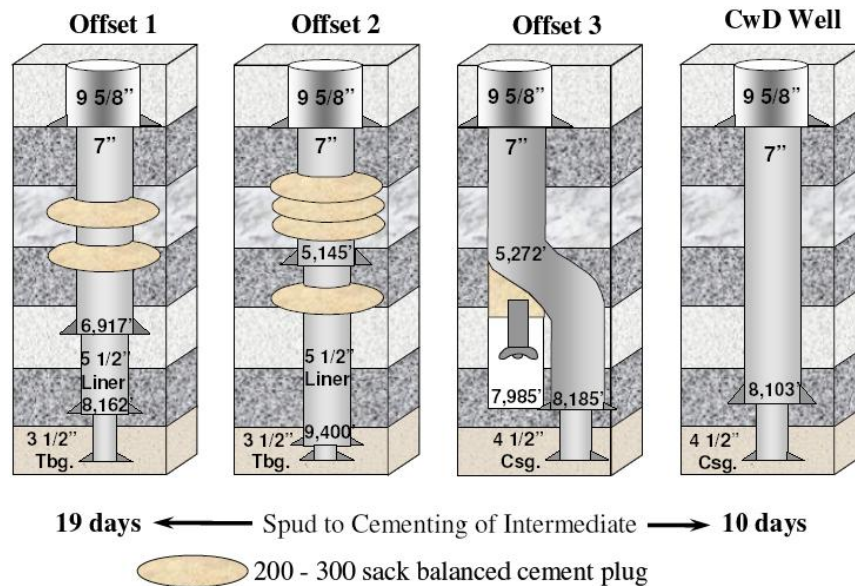

Fig. 25—Casing drilling application in the Lobo field, South Texas (Fontenot et al. 2003).

Casing drilling is a technology that stands as a viable alternative to conventional drilling in many tight gas reservoirs. Casing drilling technology has been used in many oil and gas fields as a very efficient way of significantly decreasing drilling problems and reducing the overall drilling cost.

2.7 Underbalanced Drilling Method

2.7.1. Introduction

When developing a tight gas reservoir using overbalanced drilling, reservoir damage can sometimes occur. Well stimulated by hydraulic fracturing can be used to overcome the damage. However, underbalanced drilling technology can also be used to minimize the damage and relieve other problems such as slow penetration rate and differential sticking. One of the first indications of an underbalanced drilling method design was a patent named “use of compressed air to clean a hole” and issued in the U.S.

in 1866 (Schubert 2008). A few decades later, an air drilling operation took place in Mexico. However, the modern age of underbalanced drilling is said to have started in the San Juan Basin in the 1950's with the first gas wells being drilled under these conditions. Underbalanced drilling technology moved rapidly across North America towards Texas, California and Canada (Rehm 2002). Currently, underbalanced operations are implemented with an increasing frequency for difficult formations and challenging wells.

2.7.2. Discussion

Underbalanced drilling can be defined as a drilling process that intentionally keeps the wellbore fluid gradient less than the natural pore pressure gradient, typically at 100-200 psi below the formation pressure (BP 2008). Thus, the well starts flowing while the drilling operation is still ongoing as shown in Fig. 26.

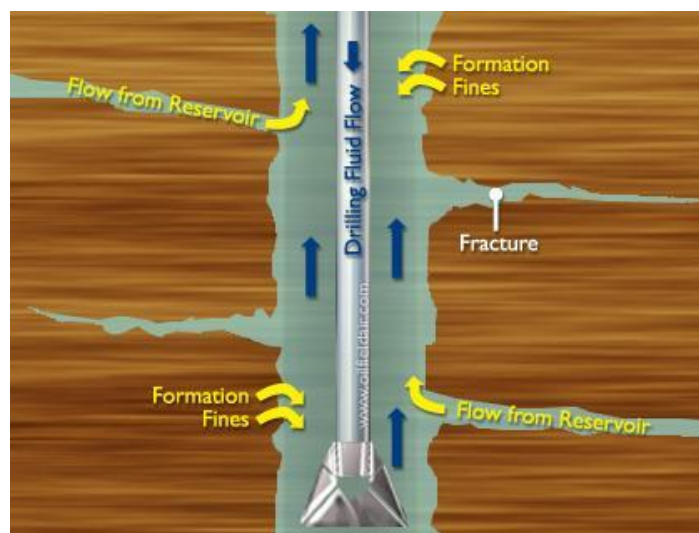

Fig. 26—Reservoir flowing with underbalanced method (Air Drilling Associates 2005).

To achieve underbalanced conditions, three types of fluids can be used: gaseous or compressible fluids (air, nitrogen, methane) as shown in Fig. 27, two-phase fluids (foams, aerated mud), and liquid or incompressible fluids (conventional drilling fluids lighter than the formation pressure in over-pressured wells).

Jointed or conventional drill pipe has been the most routinely applied technique in underbalanced drilling operations. This technique has a long history of success through many different applications worldwide because it has the mechanical ability to drill to deeper depths and large hole sizes. However, the main risk using jointed pipe is the constant possibility of shifting to overbalanced conditions under certain parameters (well type, well design, well control, connections make-up, skills and experience of the drilling team) and thus jeopardizing the reservoir production (Blade Energy Partners 2008).

As compared with jointed pipe, coiled tubing drilling (CTD) is well suited for underbalanced drilling. Despite mechanical limitations on depth and restrictions on hole size, coiled tubing drilling can solve or reduce greatly many of the jointed pipe issues previously mentioned: no connection make-up and easy pipe tripping (Blade Energy Partners 2008).

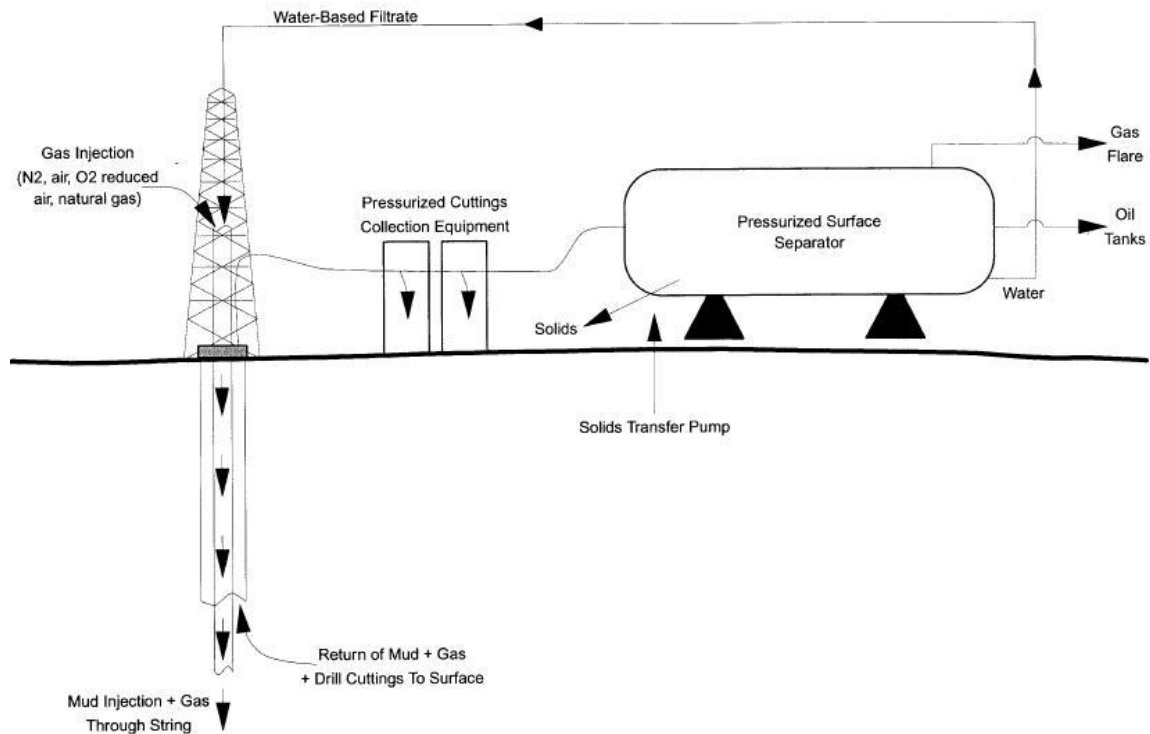

Fig. 27—Typical underbalanced drilling operation using compressible fluids (Bennion et al. 1996).

If a tight gas reservoir is naturally fractured or depleted, underbalanced drilling might enable the wellbore to intersect fractures without lost circulation and subsequent formation damage. Underbalanced drilling can also increase the rate of penetration (performance drilling in hard rock environments using compressed air), avoid differential sticking and allow the reservoir to produce oil and gas to the surface while drilling. Moreover, drilling underbalanced can help discover other hydrocarbon zones by-passed or unrecognized where conventional drilling methods are applied. The main disadvantage of underbalanced drilling is the threat of a blow-out if an unexpected permeable zone is penetrated and the rig does not have adequate surface pressure control equipment. Also, underbalanced drilling requires more equipment and attention in comparison with

overbalanced drilling. In case of sloughing shale, underbalanced drilling may lead to hole problems. Finally, underbalanced drilling can be more expensive than conventional drilling depending on the drilling fluid used and other factors. In several tight sandstones (East Texas Basin, South Texas Basin, Anadarko Basin, North America, Neuquen Basin, Argentina), drilling problems have lead operators to use underbalanced drilling as a solution for developing their assets. Results have shown that the rate of penetration can be increased in hard rock formations when underbalanced method is applied. Underbalanced drilling also improves formation evaluation and minimizes mud invasion and formation damage. Fig. 28 illustrates the application of underbalanced drilling associated with coiled tubing drilling also shown in Fig. 16 in Anadarko tight gas basin.



Fig. 28—Underbalanced drilling operation conducted in the Cleveland sands, Anadarko Basin (BP 2005).

2.8 Managed Pressure Drilling Method

2.8.1. Introduction

Managed Pressure Drilling (MPD) uses similar technology components as those of used in underbalanced drilling in order to better control pressure variations while drilling. The difference between the two methods is that underbalanced is chosen to prevent reservoir damage and encourage the influx of fluids while the goal of managed pressure drilling is to reduce greatly drilling problems across the entire wellbore and does not encourage influx from the reservoir (Malloy et al. 2009). Drilling with a closed and adjustable drilling fluid return system has been an evolving technique on land drilling programs since the 1990's. Managed pressure drilling has been very successful in South-East Asia and in North America. In the U.S., today, about one-fourth of all U.S. land drilling programs are drilled with this system (Kozicz 2006).

2.8.2. Discussion

Managed pressure drilling (MPD) is defined by the International Association of Drilling Contractors as “an adaptive drilling process to precisely control the annular pressure profile throughout the well”. The goal is to control the pressure profile in the well staying within the wellbore operating envelope (Malloy et al. 2009). Managed pressure drilling can be then divided into reactive or pro-active techniques. Reactive managed pressure drilling uses a basic configuration (a rotating control device and a choke) to deal with drilling problems that could occur in the wellbore. However, proactive managed pressure drilling includes the entire well design (casing, tubing,

fluids) to precisely manage the wellbore pressure profile since the beginning of the drilling operations (Malloy et al. 2009).

In conventional drilling, the bottom-hole pressure is the sum of the hydrostatic mud weight and the annular friction pressure. The annular friction is the pressure resulting from the circulation of the mud while drilling. The conventional drilling system is open to the atmosphere. In managed pressure drilling, the drilling engineer is to be able to change the bottom-hole pressure and the pressure profile when needed by using a closed and pressurizable mud system. Thus, the closed system allows the engineer to add backpressure to the bottom-hole pressure. The rotating control device diverts the pressurized mud return from the annulus to the choke manifold when the choke with the pressurized mud return system allows the driller to apply backpressure to the wellbore. If the pressure starts to climb above the fracture pressure of the formation, the driller can open the choke to reduce the backpressure and the bottom hole pressure. If the driller needs to increase the pressure throughout the well, closing the choke will increase the backpressure (Kozicz 2006).

The following Fig. 29 compares the different drilling windows for conventional drilling associated with overbalanced drilling method, underbalanced drilling and managed pressure drilling methods. In this example, we can see some of the benefits of managed pressure drilling. For instance, the managed pressure drilling window (yellow zone) follows the pore pressure curve (blue line) staying almost “at balance” and, avoids lost circulation problems at this point and throughout the wellbore. However, in the lower part of the plot, where the pore pressure curve and fracture curve (red line) are very close to each other, conventional overbalanced drilling shows its limitations by showing the

difficulty to drill this part of the well conventionally without having to lose drilling mud in the formation. Equally, in the middle part of the plot where pore pressure curve (blue line) and borehole stability curve (brown line) are converging, underbalanced drilling method window (red zone) is supposed to stay, by definition, 100 to 200 psi below the pore pressure curve but encounters wellbore stability problems and therefore, shows its limitations as compared to managed pressured drilling in this part of the plot.

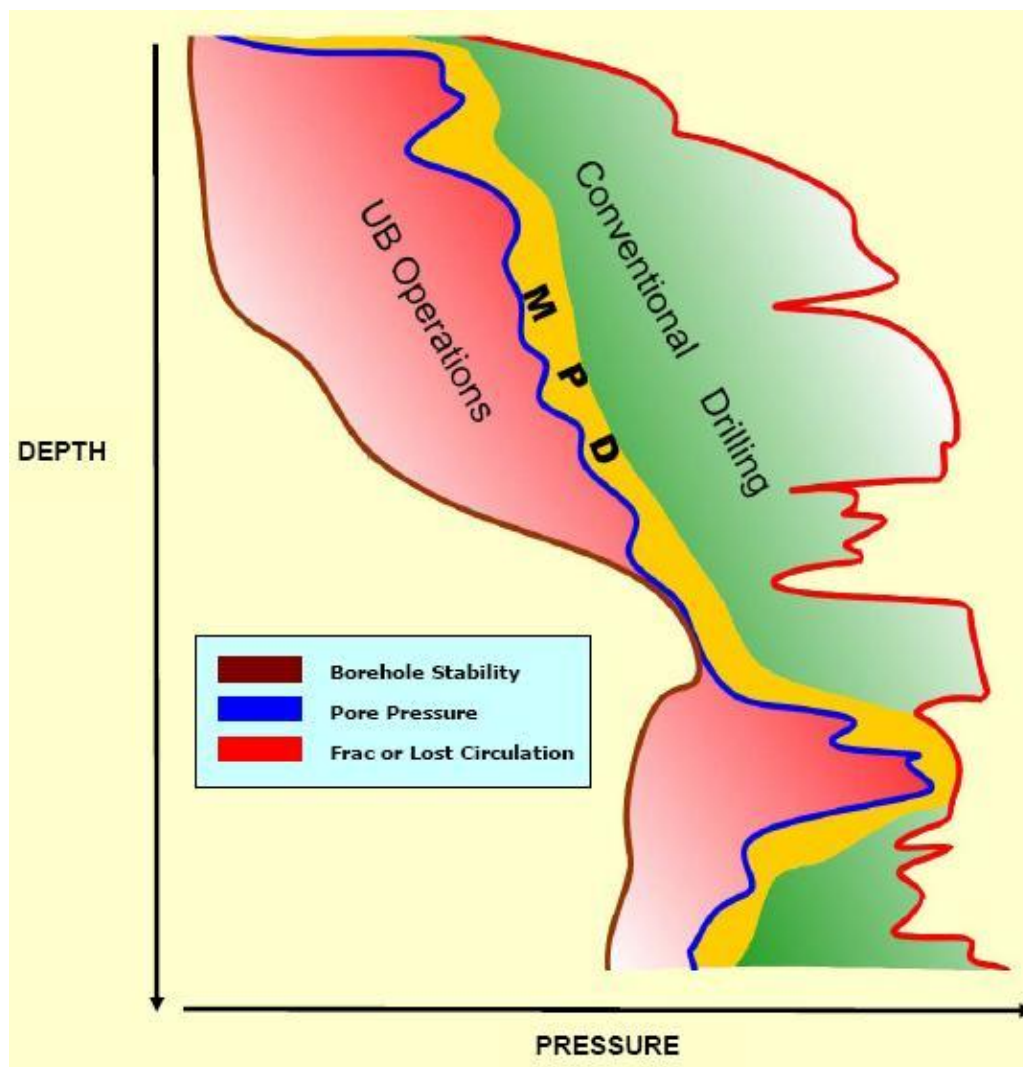

Fig. 29—Drilling windows for managed pressure drilling, underbalanced drilling and conventional drilling (Malloy et al. 2009).

With managed pressure drilling, drilling through depleted zones is usually easier than using other drilling technologies (overbalanced) and problems such as lost circulation and differential sticking are avoided by staying always at balance. Moreover, the closed system prevents gas or liquid emissions at the surface (H₂S, CO₂, Brines) as shown in Fig. 30.

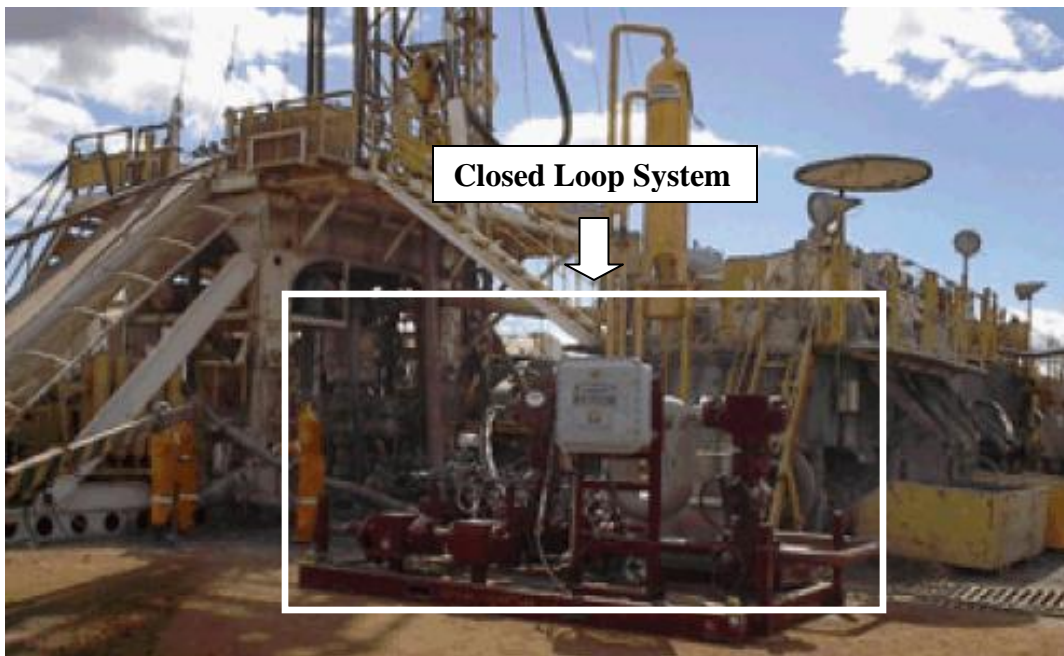

Fig. 30—Managed pressure drilling closed loop system on a land rig, (After Arnone et al. 2007).

Managed pressure drilling is a technology that improves the economic ability to drill certain wells. It can help solving many of the drilling problems resulting from pressure variations in the formations. Several variations exist; some are currently being developed and could result in increasing the speed of drilling while controlling the pressure within a narrow gradient window. As MPD technology improves and becomes more widely used, it will most certainly be used in many unconventional gas reservoirs. The main disadvantage of managed pressure drilling is the cost increase using special

components and training the drilling crew. Finally, managed pressure drilling has not been used extensively in tight gas reservoir applications. However, in certain cases where lost circulation could be an issue, MPD with a foam fluid could be of benefit.

2.9 Horizontal Drilling Technology

2.9.1. Introduction

Horizontal wells are often the best choice for reservoir development and oil and gas recovery. Even though a horizontal well cost can be 2-3 times more than the cost of a vertical well, the oil and gas reserves in a horizontal well can easily be 5-10 times more than a vertical well.

The first non-vertical drilling concept is documented in a U.S. patent back in 1891. The first successful attempt occurred in North America in 1929 within the state of Texas. Later on, the technique was improved in China and the Soviet Union, but no breakthroughs took place until the early 1980's. The first commercial horizontal drilling success occurred in southwestern France. As a result, in the 1990's, over a thousand wells were drilled horizontally worldwide. Almost eight hundred of these horizontal wells were drilled in the Austin Chalk formation in Texas (Helms 2008). The Austin Chalk is a naturally fractured shaly carbonate that produces both oil and gas.

2.9.2. Discussion

Several definitions and terminologies need to be introduced to understand non-vertical drilling concept (horizontal, directional and multi-lateral drilling). Drilling a well

horizontally usually starts by drilling a vertical section and then kicking off at a certain depth with a desired angle (arc) and finally keeping the horizontal or near-horizontal wellbore trajectory within required length of the borehole is reached (Aguilera et al. 1991). For non-vertical wells, one usually defines the total trajectory to the ultimate bottom-hole location in terms of horizontal displacement (lateral displacement from well surface location), true vertical depth (vertical depth measurement from the well surface location) and measured depth (length of borehole drilled). Horizontal wells are classified according to their build-up rate (BUR). Those wells with BUR up to 6 degrees per 100 feet drilled are long radius wells (arc length greater than 1,000 feet). Those wells with BUR of 7 to 30 degrees per 100 feet drilled are medium radius wells (arc length between 200 and 1,000 feet). Those wells with BUR greater than 30 degrees per 100 feet drilled are short radius wells (arc length less than 200) (Aguilera et al 1991 and Fig. 31).

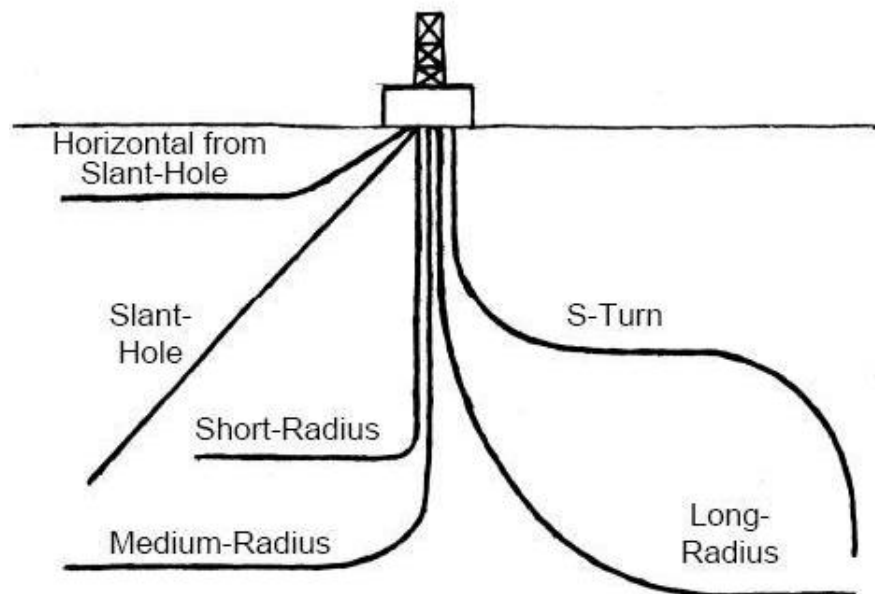

Fig. 31—Horizontal and directional drilling (Biodiversity Conservation Alliance 2003).

Horizontal drilling can be performed with any of these three methods:

1. rotating and sliding the drill-string using a top-drive or a Kelly-bushing rig;
2. coiled tubing drilling; or
3. Rotary steerable systems.

When planned for drilling a horizontal well in naturally fractured, layered or heterogeneous reservoirs, horizontal wells have usually a higher productivity and contact area than vertical wells. Thus, fewer wells will be required to efficiently drain the reservoir. The major disadvantage is the increase cost associated with horizontal drilling technology implementation in a given field because more hole must be drilled and more casing used, the costs can be 2-3 times more than a vertical well. In addition, it is sometimes difficult to steer the bit within the pay zone, especially in thin layers.

A few horizontal drilling campaigns have been conducted successfully in tight gas sands in the U.S. For instance, there is a recent one that took place in the Cleveland sands of North Texas and Oklahoma Panhandle region (Baihly et al. 2007). Others projects have launched in the Bossier and Cotton Valley sands of East Texas and North Louisiana (Baihly et al. 2007). Horizontal drilling for tight gas sands is a common practice in Northern Europe, especially in the Rotliegendes sands of Lancelot field in the U.K. (Paterson et al., 1996) and of Sohlingen field in Germany (Heslop et al. 1998). In tight gas sand formations, the wellbore designs are generally conventional horizontals (3,000 feet or less) or extended horizontals (up to 6,000 feet) with production improvement factor ranging from 1.1 to 4.7 (Baihly et al. 2007).

The following Table 2 and Table 3 show the respective percentage of wells drilled horizontally for four different tight gas formations in the U.S. and the production improvement factors associated with these four reservoirs. Table 2 illustrates the evolution of horizontal wells drilled in the Cleveland formation in the Texas Panhandle region, which was about 4% in before 2003 and has risen up to 71% in 2006. This sharp progression has been associated with constant increase in production improvement factor, which averaged 3.5 in 2006. Table 3 compares three tight gas reservoirs in the East Texas basin: Bossier sands, Cotton Valley sands and Travis Peak sands. For Bossier sands, the percentage of horizontal wells drilled has increased from 1.1 % to 8.3 % between before 2005 and 2006 but still remains low as compared to what happened in the Panhandle region at the time. However, the good production improvement factors let assume that more horizontal wells are going to be drilled in the Bossier sands after 2006. Finally, in the Cotton Valley and Travis Peak sands, horizontal drilling campaigns did not have a significant impact on the percentage of wells drilled horizontally in 2006 (1.25% and 0.6% respectively). The low ratio of vertical/horizontal wells can perhaps be explained by the low value of production improvement factors associated with horizontal drilling in the Cotton Valley and Travis Peak tight sands.

Year	PIF	Percentage of Wells Which are Horizontal
<2003	1.1	4.08%
2003	2.6	27.54%
2004	2.6	62.50%
2005	3.4	69.09%
2006	3.5	71.72%

Formation	Bossier Sand		Cotton Valley Sand		Travis Peak Sand	
Year	PIF	Percentage of Wells Which are Horizontal	PIF	Percentage of Wells Which are Horizontal	PIF	Percentage of Wells Which are Horizontal
<2005	1.5	1.10%	1.1	0.29%	1.2	0.11%
2005	3.8	2.70%	2.6	0.44%	N/A	0.00%
2006	4.7	8.30%	1.9	1.25%	1.9	0.60%

As shown in Table 2 and Table 3, field results have proven that horizontal wells may be an efficient way to drain certain tight gas sandstone reservoirs. Besides, the wells need to be planned with caution because not every tight sandstone reservoir is a good candidate for horizontal drilling. The production improvement factor has to overcome the cost increase associated with horizontal drilling technology.

2.10 Directional Drilling Technology

2.10.1. Introduction

Directional drilling emerged around during the last half of the 20th century. Historically, most tight gas wells have been drilled vertically. Vertical hydraulic fracturing has been used to “extend” the wellbore horizontally. Directional drilling has become a common practice with a growth of about 2% per year and account now for nearly 40% of the total wells drilled in the U.S (Kreckel 2008). Directional technology is currently at a mature stage setting numerous records with directional wellbores currently reaching targets over a mile away laterally. The Wytch Farm field, located in the southern part of England, has seen a long directional wellbore reaching a horizontal displacement of over 33,000 feet at a true vertical depth of around 5300 feet (Schubert et al. 2002).

However, environmental constraints have recently encouraged the industry to consider using directional drilling from pads to minimize the environmental footprint. The best examples of this current practice are in the Rocky Mountain region, which holds enormous volumes of tight gas. Fig. 32 shows a drilling rig in the Piceance basin, Colorado. In a mountainous environment where natural parks and protected animal species are numerous, the different states Bureau of Land Management constrained the operators to use pad drilling and therefore directional drilling to access the different tight gas reservoirs (Wyoming BLM 2006). The current drilling practice in the Rocky Mountain region is called “pad drilling”. From a single well pad, using built-for purpose drilling rig with skid system, operators drill dozen of directional wells from the well pad.



Fig. 32—Drilling rig located in a sensitive environment, Piceance Basin, Colorado (Oil & Gas Investor 2005).

Directional drilling emerged around during the last half of the 20th century. Directional drilling has become a common practice with a growth of about 2% per year and account now for nearly 40% of the total wells drilled in the U.S (Kreckel 2008). Directional technology is currently at a mature stage setting numerous records with directional wellbores currently reaching targets over a mile away laterally. The Wytch Farm field, located in the southern part of England, has seen a long directional wellbore reaching a horizontal displacement of over 33,000 feet at a true vertical depth of around 5300 feet (Schubert et al. 2002).

2.10.2. Discussion

A well is defined as directional when drilled at an angle other than vertical. Control of hole inclination is enabled with the use of a steerable down-hole motor and bent subs. In tight gas wells that need to be fractured treated, well planners use S-shape wellbores with horizontal displacements ranging from 2,000 to 3,000 feet depending on the geology and target depth. There are several reasons that S-shaped wells are preferred in tight gas sand reservoirs. First, since most tight gas reservoirs are highly layered and do not have much vertical permeability (due to shale layers), then horizontal wells do not work well. By drilling tight gas vertically, the engineer can run logs to determine net pay and gas-in-place. The success rate of hydraulically fracturing vertical wells is much higher than when horizontal or slanted wells are fracture treated in tight gas sands.

Fig. 33 shows a drilling program with 20 directional wells from a single pad. To drill these 20 wells in such a small area, Questar Energy used built-for purpose rigs with skid system going in the north/south direction. A direct effect to this “well cluster concept” is an important reduction of surface disturbance while operating because it concentrates not only surface facilities but also lessens the number of roads required to access the well site and optimizes pipeline network. In addition, there will be no environmental disturbance after abandonment of the well pad.

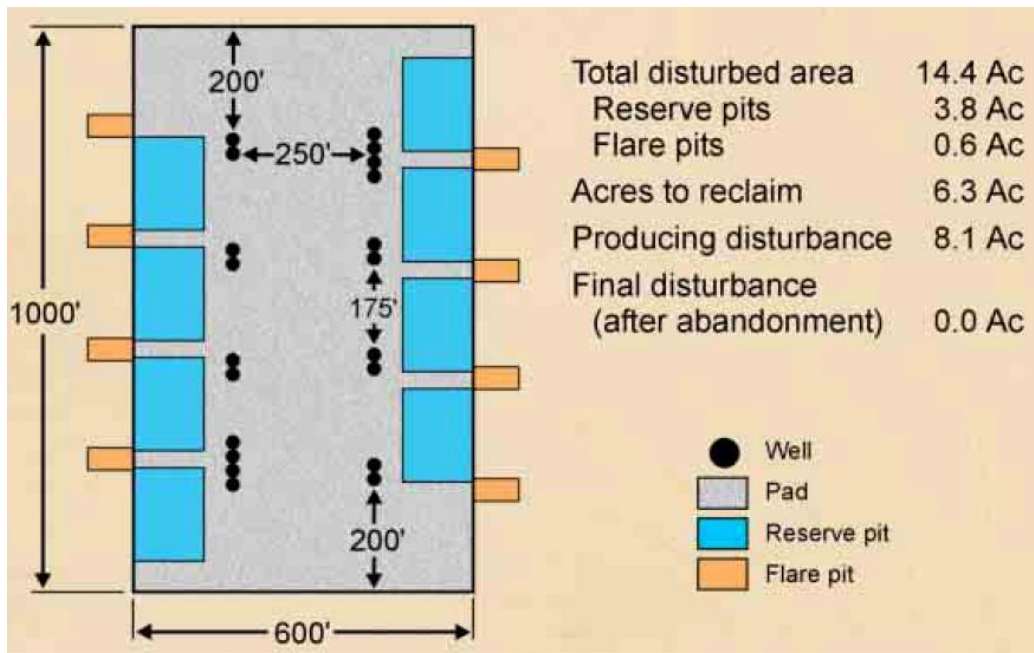

Fig. 33—Multi-well drilling pads in Pinedale anticline field (Questar Energy 2006).

In the Pinedale field, Jonah field, Natural Buttes field and in the Roan Plateau area located respectively in Wyoming, Utah and Colorado, operating companies are using well pads with up to 30 wells to produce gas reserves from the multiple, stacked reservoirs in the tight Lance, Mesaverde and Wasatch formations (Fig. 34). These wells have a true vertical depth ranging from 7,000 feet to over 14,000 feet with a horizontal displacement of 2,500 feet. Average cost for directional wells in these two fields range from 11% to 15% over vertical wells (completed well cost of \$2,200,000 in Jonah field and \$4,000,000 in Pinedale field in 2006). For Pinedale field, the Bureau of Land Management of Wyoming estimated an environmental impact reduction ranging between 50% and 90% (Kreckel 2008).



Fig. 34—Directional S-shape drilling in Pinedale field, Wyoming (Shell 2005).

The need for directional wells is a much-needed technology for the development of tight gas reserves in the Rocky Mountain region in the U.S mainly for environmental reasons. However, the use of directional drilling from pads is also a good way to oil and gas reserves in the arctic, under cities, lakes or other areas where surface access is limited or difficult.

Directional drilling is no longer an emerging technology for the development of tight gas sandstone reservoirs. Indeed, the successful application of directional drilling in the Rockies coupled with the need of drastically reduce surface disturbance in many areas where tight gas reserves are located could serve as an example for an economical an cheaper development of tight gas fields across the world.

2.11 Multi-Lateral Drilling Technology

2.11.1. Introduction

Drilling a multi-lateral well is a proven concept. However, successful applications have only occurred since the 1990's. Multi-lateral drilling technology represents a further step in well construction to add to directional, horizontal and extended reach well trajectories. Multi-lateral drilling applies for both existing wells (re-entry, sidetracks) and new wells in low permeability gas reservoirs. Like a horizontal well, maximum reservoir exposure (increase in production) and economics (decrease cost) justify the design and implementation of a multi-lateral in a given field. The multi-lateral well can be either a development well, an exploration well or a re-entry well.

In 1949, a Russian engineer, Alexander Grigoryan pushed a step further, the theoretical work already started on horizontal drilling and came up with the design of an original mother bore (1,886 feet, total depth) with nine others branches (446 feet from kick-off point). This application took place in 1953 in the former U.S.S.R.'s Bashkiria field and was the world's first multi-lateral well. In comparison with other wells drilled in the same field, it produced 17 times more oil per day. Therefore, over 100 multi-lateral wells followed this successful application in this area (TAML 2004). Since then, multi-lateral drilling evolved from the open-hole sidetracks techniques mentioned previously to a wide range of geometrical settings and complexities now made available for the reservoir engineer. As of today, multi-lateral drilling is used significantly all over the world with the biggest number of installations in South America, Middle East, the U.S. and Canada (TAML 2004).

2.11.2. Discussion

The general definition of a multi-lateral well by The Technical Advancement of Multilaterals (TAML) is “one in which there is more than one horizontal or near horizontal lateral well drilled from a single side (mother-bore) and connected back to a single bore. The branch may be vertical, horizontal, inclined or a combination of the three” (TAML 2004).

A multi-lateral well geometry is usually describes by its configuration (stacked, planar, radial, opposed as shown in Fig. 35) and number of laterals (dual-lateral, tri-lateral, etc.).

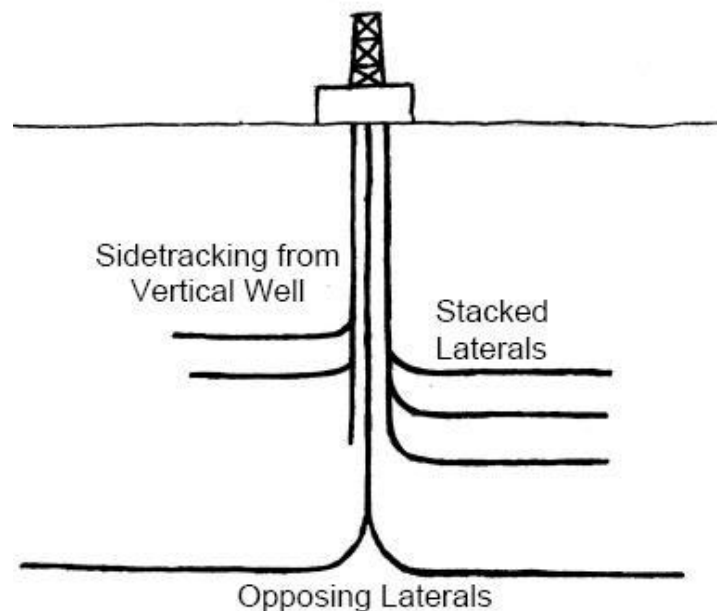

Fig. 35—Multi-lateral drilling (Biodiversity Conservation Alliance 2003).

TAML classifies multi-lateral wellbores according to their complexity ranking and functionality classification. This is the most popular way of classification among the well construction engineers. The complexity ranking relies on an assessment of the

mechanical configuration of the well, its mechanical stability and hydraulic isolation of the junction to give a 7 levels of complexity (level 1: open /unsupported junction, level 2: mother-bore cased and cemented lateral open, level 3: mother-bore cased and cemented lateral cased but not cemented, level 4: mother-bore and lateral cased and cemented, level 5: pressure integrity at the junction, level 6: pressure integrity at the junction achieved with the casing, level 6S: down-hole splitter) (TAML 2004).

The functionality classification provides thorough technical details on the wellbore. It specifies if the well is an existing well or a new well, its number of junctions, if the well is a producer with or without artificial lift, an injector or a multi-purpose well type. Moreover, the completion type: single, dual or concentric is described. Different reasons lead to drilling a reservoir with multi-lateral wells. However, the final goal is twofold: increasing the hydrocarbons recovery by maximizing reservoir exposure and drainage, and reducing the cost of drilling, completion and production. One main reason to use multi-lateral wells is to expose more reservoir per well (productivity index). For instance, a multi-lateral well can contact many different reservoir layers through one main single wellbore. Finally, using multi-lateral wells also reduce surface facilities and total footprint, therefore minimizing the environmental impact. Finally, costs are reduced (lower capital expenditure for drilling the upper section) when compared to having to drill multiple vertical wells to contact the same amount of reservoir.

Before implementing a multi-lateral well configuration, reservoir and well construction engineers must consider the possible risks or difficulties that might be encountered. The well design must consider the vertical permeability distribution in the rock layers. The costs of a single well can be high and must be compared to the costs of

drilling multiple vertical wells. The engineer should also recognize that work-over in multi-lateral wells can be expensive and difficult.

Multi-lateral well drilling has been applied successfully and is currently under development in two main regions within the U.S.: the Great Green River basin, Wyoming and the East Texas basin. In the Wamsutter field, Wyoming, a typical well encounters up to 20 sand layers averaging less than 10 feet in thickness over a 500 feet gross thickness in the tight Almond formation. Overall, there are thousands of tiny gas pay zones that need to be produced through an entire reservoir section (BP 2007). Several different types of multi-laterals have been designed by well construction engineers such as stacked laterals; stacked opposed laterals; stacked radial laterals; and fishbone geometries with up to 30 small boreholes coming from one single mother bore. In the Travis Peak formation, Texas, which is a more continuous sand body formation, only stacked laterals and Y-laterals are being used in place of long horizontal extended reach wells as shown in Fig. 37 (TAML 2004). Also, in the Sohlingen field, Germany, multilateral well construction is being implemented through dual lateral wellbores as shown in Fig. 36 (Heslop 1998).

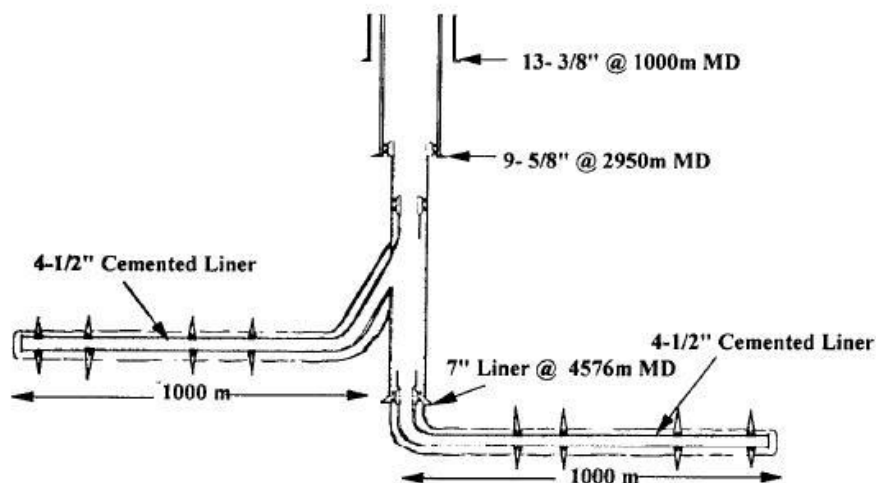

Fig. 36—Dual lateral wellbore in the Sohlingen field, Germany (Heslop 1998).

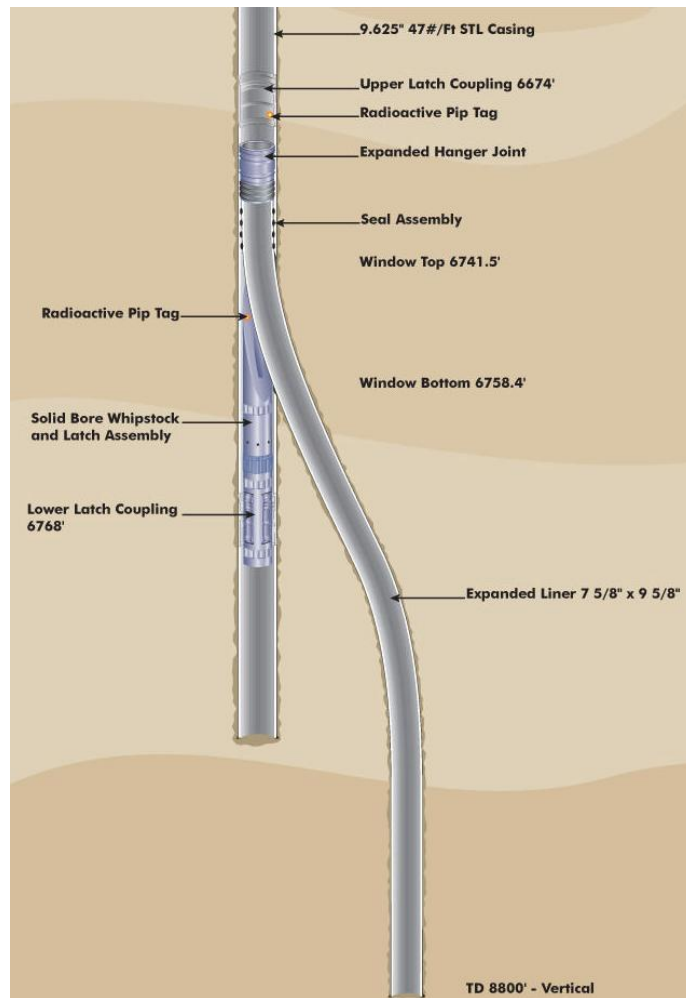

Fig. 37—Multi-lateral drilling in the Travis Peak formation (TAML 2004).

Multi-lateral well drilling technology has evolved rapidly over the last few years to the point of becoming an option in both continuous and multi-layered tight gas formations. The complexity of multilateral wells is quite diverse. They may be as simple as a vertical wellbore with only one sidetrack or as complex as a long extended-reach well several laterals.

2.12 Using Multiple Technologies

Using the above discussion on each individual drilling technology or method currently available on the market, several techniques seem to have a brighter future, especially when applied simultaneously.

2.12.1. Managed Pressure Casing Drilling Technology

Among the most promising are the casing drilling and managed pressure drilling technologies. The managed pressure casing drilling (MPCD) blend, used only for vertical wells so far, combines the most efficient aspects of managed pressure drilling and casing drilling in order to reduce the weaknesses the two techniques have shown sometimes when applied solely. MPCD offers potential for application in naturally fractured tight gas sands and for fields where the pressure gradient changes importantly along the borehole. Currently, MPCD has best results with soft rock formations and expensive drilling areas (Stone et al. 2006).

2.12.2. Underbalanced Casing Drilling Technology

Casing drilling has been implemented with underbalanced conditions in recent years with success. The best example of this technology blend happened in highly depleted tight Vicksburg sandstones from South Texas at depths ranging from 10,000 to 16,000 feet, high pressures (10,000 psi) and high temperatures (280 - 400 °F). As shown in Fig. 38, the wells were typically re-entry slim borehole drilled underbalanced to avoid formation damage and have been equipped with casing drilling technology to solve

severe lost circulation and well control problems (modified drilling assembly designed). In addition, cost savings are significant by reducing the well plan (Gordon et al. 2004).

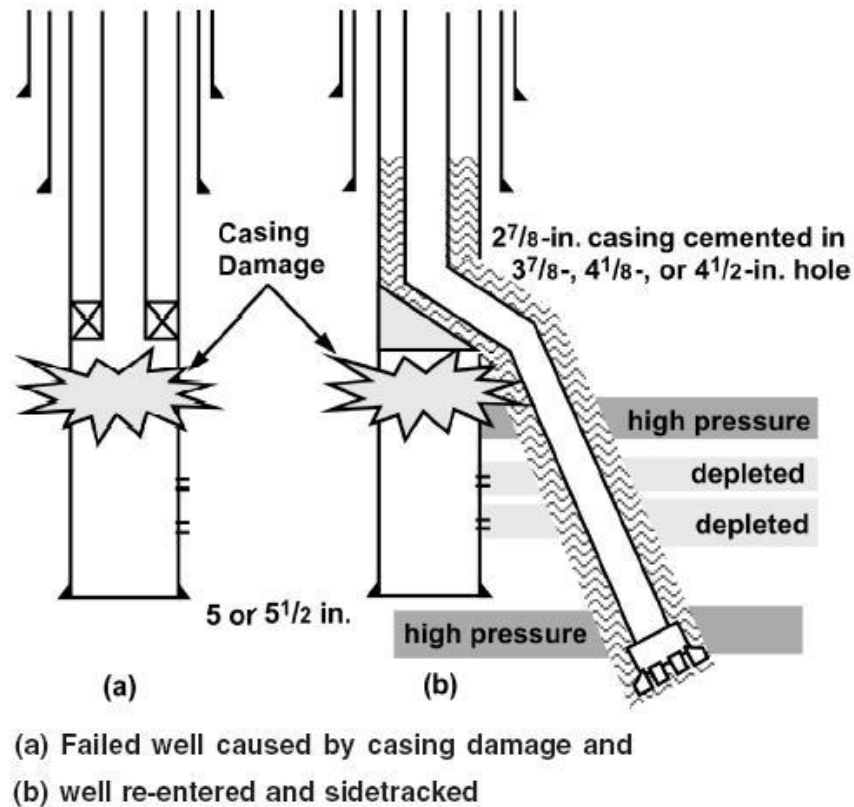

Fig. 38—Underbalanced drilling with casing drilling in a re-entry operation, Vicksburg sands, South Texas (Gordon et al. 2004).

Fig. 39 illustrates a second application of underbalanced drilling with casing in the Vicksburg sands of South Texas. The original conventional drilling well planning used four strings of casing and three liners to deal with the fault zones, the high-pressure zones and the depleted sands. By using underbalanced drilling with casing, the well planning required only three casing strings and two liners. Thus, two liners set in the original conventional drilling well plan were saved in the new well plan because underbalanced drilling with casing performs well in depleted sands. Finally, the new planning well has a smaller surface casing and a larger production casing diameter.

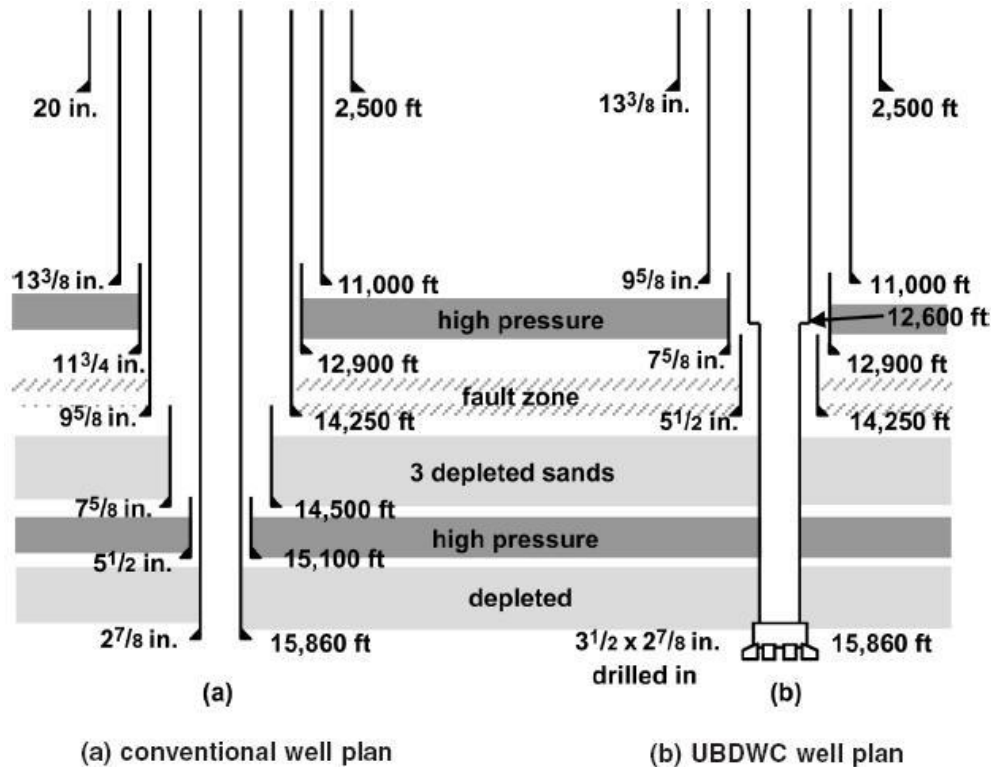

Fig. 39—Well design using UBDWC, South Texas (Gordon et al. 2004).

2.13 General Discussion

Tight gas production dates back to the 1940's in the San Juan Basin in New Mexico. Until the mid 1990's, mostly in the U.S., tight gas wells were drilled and completed vertically by conventional overbalanced rotary drilling technology. The tight gas fields in the East Texas and North Louisiana Cotton Valley play was one area where thousands of wells were drilled in the 1970's and 1980's. Equally, thousands of wells were drilled in the Wilcox-Lobo and Vicksburg trends of South Texas during the 1970's, 1980's and 1990's (Robinson et al. 1986).

However, driven by strong environmental constraints, operating and contracting companies have developed more efficient solutions to drill tight lenticular gas formations

in the Rocky Mountain region (Piceance basin, Uintah basin, Great Green River basin and the northern part of the San Juan basin). Industry has also improved ways to drill multiple wells from a single drilling pad. The directional S-shaped wells are drilled using specially designed rigs with a skid system, thus allowing considerable reduction in footprint impact and optimization of surface facilities. Not only has this made for a more environmentally sound solution (as evidenced by comparing before-and-after satellite images from conventional and pad-based developments), it has also significantly reduced the time and cost associated with drilling, completion and production (Kreckel 2008). So far, these built for purpose rigs have been associated with conventional and overbalanced drilling technologies. However, they represent a significant step forward, because not only have they managed to improve performance, but they also offer a bright future for drilling in general. Future developments are likely to center around such purpose-built flex rigs, equipping them with some of the components of other emerging technologies such as under-balanced drilling, managed pressure drilling, coiled tubing drilling, and casing drilling.

Emerging technologies have proved to be more successful in specific applications. This is the case with casing drilling in the high-pressured and depleted sands of South Texas, where the application solved important drilling problems (lost circulation, stuck pipe, well control) and has currently taken over from conventional drilling to develop the tight gas reservoirs in this area. Equally, in the North Texas Panhandle region, horizontal drilling has risen (currently over 70% of the wells drilled) and increased the productivity of the Cleveland sands (productivity improvement factor that is averaging 3.5). Other techniques such as underbalanced drilling, managed pressure

drilling, coiled tubing drilling and multi-lateral wellbores show a strong potential in the coming years because they address some important issues that are routinely encountered when drilling tight gas formations: formation damage, low rate of penetration, drilling problems, re-entry wells.

3 DRILLING ADVISORY MODULE

3.1 Introduction

Due to the increase in risks, uncertainties, complexities and costs when developing tight gas reservoirs, a team of experts should work together to plan and design each critical stage of the development of these unconventional resources.

The number of tight gas wells being drilled in the U.S. and worldwide has increased considerably over the past few decades. With more tight gas fields to be developed outside of North America and a shortage of experienced engineers, a system collecting expertise and knowledge from the public domain, and providing reasonable solutions could be a useful tool to assist drilling engineers making decision when drilling tight gas formations.

3.2 Advisory and Expert Systems

3.2.1 Introduction

Advisory and expert systems have been used in many industries for decades. Petroleum engineers are exposed daily to decision making to solve complex problems. Expert systems help engineers by gathering expert's knowledge, providing solutions and can prove to be useful when making many decisions in the petroleum industry.

3.2.2 Expert Systems

Expert systems are computer programs created to simulate behavior of a human expert facing complex problems (Hayes-Roth et al. 1983; Giarratano et al. 2005). The main advantage of an expert system for petroleum engineers, and in our case, drilling engineers, is the possibility of processing an incomplete drilling dataset. For instance, when trying to design a drilling program for a new reservoir, the dataset will most likely be incomplete, lacking reservoir, geology and drilling measurements. Thus, such a system will provide one or more drilling technology recommendations to the drilling engineer. This expert advice is sometimes ranked with a degree of certainty that the expert previously assigned during the development phase of the system.

However, expert systems are not always the best solutions to solve large problems. In this research, drilling tight gas reservoirs is a quite vast domain and, therefore, an expert system resulting in only one answer may not be appropriate. We are developing a tool that may not be as firm as an expert system. Drilling expert systems started to be built in the 1980's dealing with one topic at a time such as mud rheology (Kahn et al. 1984), well planning (Fenoul 1989), lost circulation (Hyodo et al. 1992), or more recently underbalanced candidate (Garrouch et al. 2004), casing design (Schlumberger 2007).

3.2.3 Fuzzy Logic Systems

Fuzzy logic enables a computer program to process all the values between 0 (true) and 1 (false) (Zadeh 1965). This method improves upon the so-called Boolean logic manipulating only two values (0 or 1). For example, in the case of a potential blow-out,

this hazard could have different values such as “low”, “moderate” or “high”. Fuzzy logic systems are defined by membership functions and may be efficient processes to program when dealing with approximate dataset.

3.2.4 “Case-Based” Reasoning

When reasoning with a “case-based” system, problems are solved using prior experiences knowledge (Aamodt et al. 1994). For instance, a drilling engineer who already encountered lost circulation problems in a given depleted formation will rapidly take actions as soon as measurements from the bottom-hole assembly match those he experienced previously in similar conditions. In fact, this system yields an “IF-THEN” approach.

3.2.5 Drilling Advisory System

We are calling our research product a “drilling advisory system”. To solve a complex problem such as drilling tight gas formations, we are creating a computer program that will deliver advice to the drilling engineer about drilling technologies, methods selection, drilling time and cost estimation.

The program reasoning is based on a mixture of methods that include historical best practices (“case-based” reasoning), “IF-THEN” methodology, Boolean and fuzzy logic functions and also borrowing some elements belonging to expert systems (providing one or more reasonable solutions for a given problem and not only one answer). However, it is not guaranteed that the recommendations from the advisory system will be the optimal solutions but the advisory system results will first tend

towards the industry current drilling best practices and; secondly will help avoid mistakes that can be numerous when drilling unconventional tight gas reservoirs.

3.3 Advisory System for Selecting Drilling Technologies and Methods

3.3.1 Introduction

Tight gas reservoirs have been studied in the U.S. for over 60 years. As such, there is a considerable amount of information present in the petroleum literature on tight gas reservoirs. Indeed, hundreds of papers have been describing best practices to drill tight gas formations. Several organizations such as Society of Petroleum Engineers, American Association of Drilling Engineers and various drilling contractors have documented the challenges that must be overcome when drilling tight gas reservoirs.

3.3.2 Project Goal and Interaction with Other Similar Projects

This research consists of creating a drilling module that is part of a larger advisory system called Drilling and Completion (D&C) Advisor (Bogatchev 2007; Ogueri 2007; Wei 2009) interacting with two other programs named BASIN (basin analogy) (Singh 2006) and PRISE (resources evaluation) (Old 2008). The final goal is that all these programs work together to provide advice to an engineering team for the drilling, completion and stimulation of tight gas assets. The global software is called Unconventional Gas Resources (UGR) Advisor. All these programs are being developed at Texas A&M by a team of graduate students and professors under the supervision of Dr. Holditch, the team leader.

The following Fig. 40 describes the overall process of designing the completion of a tight gas well. The decision chart is divided into four parts: drilling design, completion design, stimulation design and production design. The decision chart starts with the completion design which has a direct influence on the required production casing diameter. Then, an iterative process checks if the production casing diameter calculated for the completion design d_1 is larger than the production casing diameter given by the production design d_2 . As long as this condition is not satisfied, the process loops. Then, a second iterative process checks if the production casing diameter needed for the completion design d_1 is larger than the production casing diameter calculated in the stimulation design d_3 . As soon as this second condition is satisfied, the drilling design can start. Even though this drilling module will eventually interact with the UGR Advisor, it is also a stand-alone program.

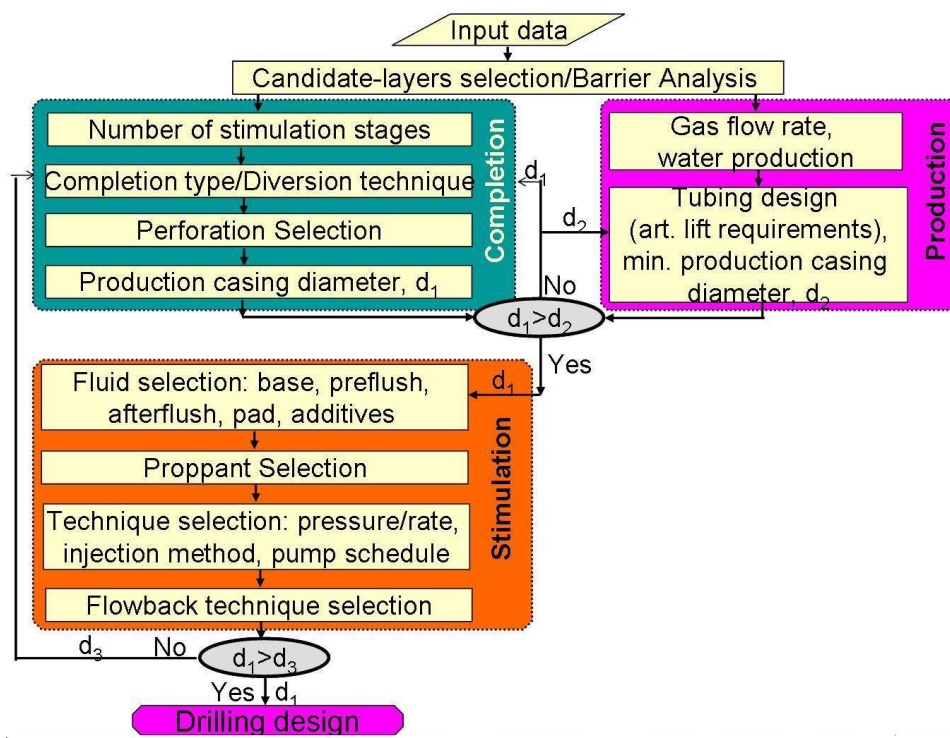

Fig. 40—D&C Advisor workflow (Bogatchev 2007).

3.3.3 Development Procedure

3.3.3.1 Definition of Tasks to Be Performed by the Drilling Module

The drilling design of a tight gas well involves many decisions and calculations. As summarized in Fig. 41, the drilling module uses input values from geology, reservoir evaluation, materials availability, well trajectory, surface, intermediate and production casing dataset and delivers advice to the drilling engineer. The drilling advisory system covers the following four topics:

1. What is the best drilling technology to use to access a specific tight gas reservoir?
The three choices are conventional drilling, casing drilling and coiled tubing drilling. For a given reservoir condition, more than one drilling technology can be used successfully. Calculations are performed for each section of hole: surface, intermediate and production.
2. What is the best drilling method to associate with the main drilling technologies that are eventually recommended? These methods are overbalanced drilling, underbalanced drilling and managed pressure drilling. More than one method can be successfully used depending on the well and reservoir parameters. Calculations are performed for each section of hole as well.
3. Drilling time estimation, in days, for each drilling technology and method and for each section of hole from surface casing to production casing at total depth.

4. Cost estimation based on the technology and drilling method chosen, in U.S. dollars. Results are calculated for each drilling technology and method and for each section of hole from surface casing to production casing at total depth.

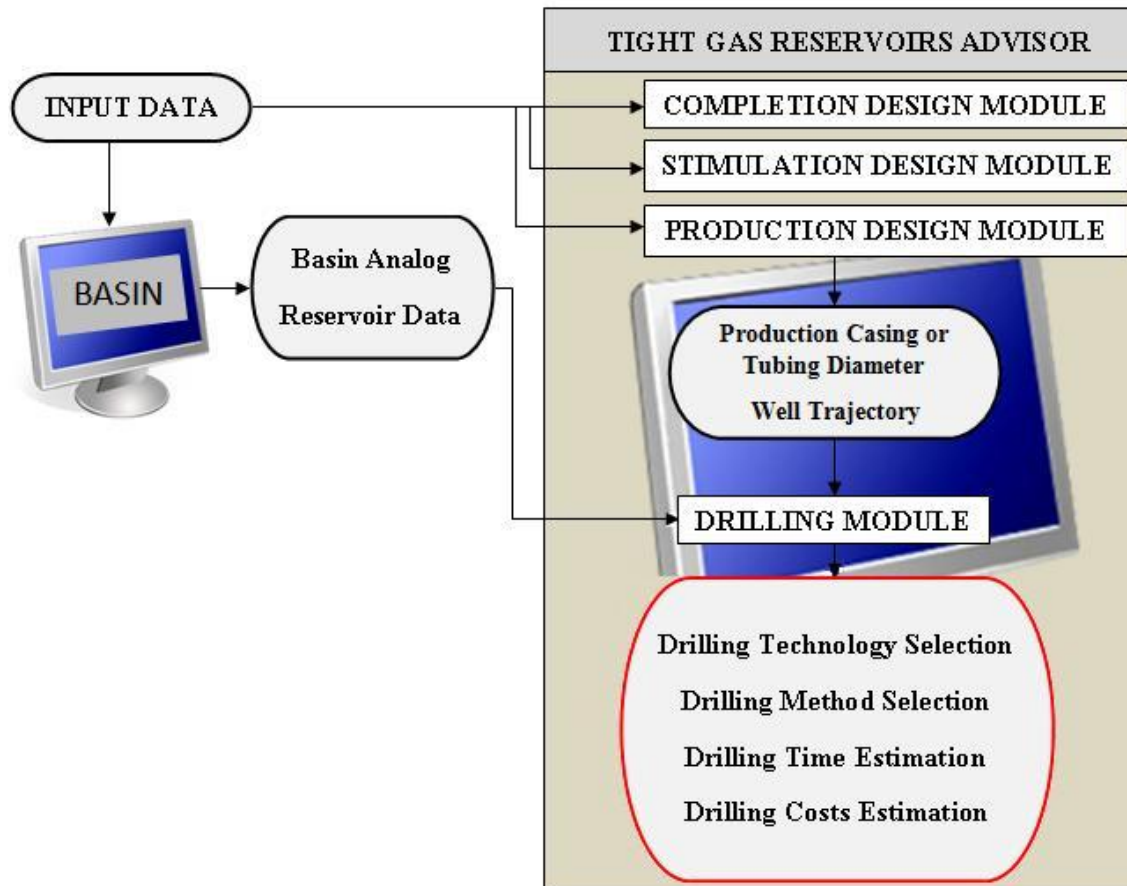

Fig. 41—Drilling advisory system and interaction with other programs.

3.3.3.2 Development Tool Selection and Programming Language Selection

To develop the drilling module, we have used Microsoft Visual Studio 2008. This “Integrated Development Environment” appeared to be a good tool to build a simple user interface to be compatible with the other parts of UGR Advisor. Besides, its flexibility, easy maintenance, availability, and direct application on every Windows O.S platforms,

which constitute the major part of computer used by many organizations in the petroleum industry. Microsoft Visual Studio supports several programming languages (C++, C#, Java and Visual Basic). We chose to use the latest version of Visual Basic to write all the code for all the routines and sub routines named VB.NET.

3.3.3.3 Decision Chart Creation

Once we completed the literature review of the different drilling technologies and methods available for drilling tight gas reservoirs, we listed the advantages and limitations of each in tight gas applications. As shown in Table 4, we selected six different criteria, such as drilling problems (lost circulation and stuck pipe), rate of penetration improvements, formation damage reduction, reservoir characterization, kick detection and surface equipment complexity. A summary of our decision making thought processes are presented in the following paragraphs.

- Casing drilling and managed pressure drilling greatly reduces lost circulation and stuck pipe while underbalanced drilling reduces drilling problems at a lower scale because it is not the main goal of underbalanced drilling method. In addition, conventional drilling and overbalanced drilling may increase lost circulation and stuck pipe while using coiled tubing drilling technology has no effects on lost circulation and stuck pipe incidents.
- Coiled tubing drilling, underbalanced drilling and managed pressure drilling improves significantly the rate of penetration while conventional drilling and overbalanced drilling do not improve the rate of penetration. Casing drilling does not improve the rate of penetration but does reduce the total drilling time

because tripping time is kept at a minimum since the well is drilled and cased simultaneously.

- Underbalanced drilling and managed pressure drilling do reduce formation damage by monitoring the pore pressure gradient and drilling equivalent mud weight. Casing drilling has proven to have little effect on reducing formation damage. Conventional drilling and coiled tubing drilling have no effect on reducing formation damage while overbalanced drilling may increase formation damage and produces formation impairment.
- All the drilling technologies and methods can help characterize the reservoir by using logging while drilling on the conventional drilling, casing drilling and coiled tubing drilling assemblies. Overbalanced drilling, underbalanced drilling and managed pressure drilling methods can help one monitor the reservoir fluids as well. Only managed pressure drilling and overbalanced drilling at a lower scale can help detecting drilling hazards (kick and blow-out) while underbalanced drilling must not be used if drilling hazards are expected.
- Surface equipment complexity varies among the different drilling technologies and methods. Conventional drilling and overbalanced drilling have relatively lower costs and do not need special training for the drilling crew as compared to casing drilling and coiled tubing drilling which need more expensive drilling components and specific training for the drilling crew. Finally, underbalanced drilling and managed pressure drilling methods

require pricey surface equipment and specially trained drilling crew to operate and monitor all the surface equipment.

Using these ideas, we developed decision charts to mimic a drilling engineer's decision-making process. The design of the decision charts is similar to the underbalanced drilling candidate selection decision chart developed by the International Association of Drilling Contractors (Blade-Energy Partners 2008).

The decision chart shown in Fig. 42 illustrates the feasibility of drilling technologies and methods as a function of the wellbore trajectory given by the production design module (Fig. 41). If the wellbore is planned to be either vertical or directional, all the drilling technologies and methods (conventional drilling, casing drilling, and coiled tubing drilling, overbalanced drilling, underbalanced drilling and managed pressure drilling) are applicable. However, if the wellbore is planned to be either horizontal or multilateral, casing drilling technology is not yet mature to be used but all the other drilling technologies and methods (conventional drilling, coiled tubing drilling, overbalanced drilling, underbalanced drilling and managed pressure drilling) are feasible.

TABLE 4—Drilling technologies and methods advantages and limitations

<i>Technologies/Methods Advantages and Limitations</i>	Conventional Drilling	Casing Drilling	Coiled Tubing Drilling	Overbalanced Drilling	Underbalanced Drilling	Managed Pressure Drilling
Drilling Problems (Lost Circulation, Stuck Pipe)	May Increase	Greatly Reduces	No Effects	May Increase	Reduces	Greatly Reduces
ROP Improvements	No	No (but overall drilling time saved)	Yes (smaller diameter)	No	Yes	Yes
Reduce Formation Damage	No	Little (Plastering Effect)	No	No	Yes	Yes
Reservoir Characterization	Yes	Yes	Yes	Yes	Yes	Yes
Kick Detection	N/A	N/A	N/A	Yes (Less than MPD)	No	Yes
Surface Equipment Complexity	Low	Medium	Medium	Low	High	High

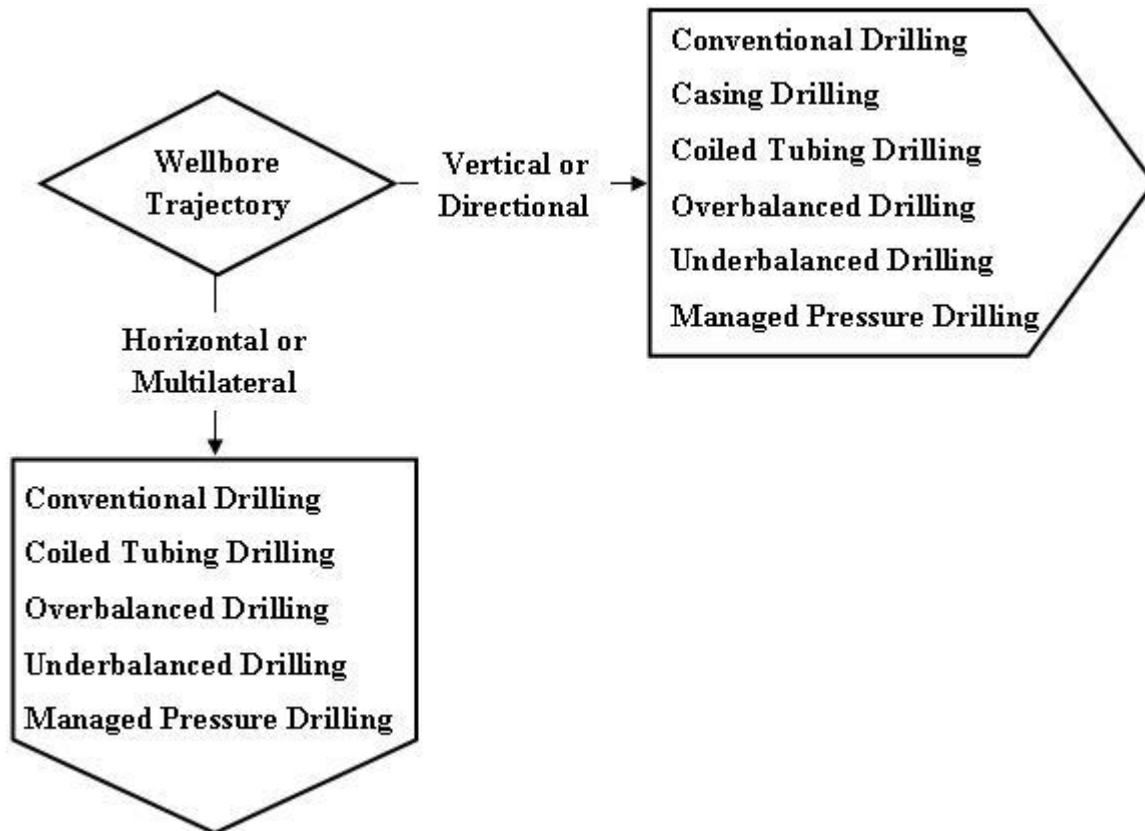

Fig. 42—Decision chart for drilling technologies and methods feasibility as a function of wellbore trajectory.

Based on the decision chart shown in Fig. 43, it is possible to determine whether casing drilling is feasible or not recommended. The process of casing drilling candidate selection starts with the answer to the question: “Are drilling problems anticipated in this well or field?” If no drilling problems are anticipated, then casing drilling technology is not recommended in this well or field. Then, if any of the drilling problems such as lost circulation, stuck pipe or salt zones is likely to happen, the casing drilling candidate selection continues with the answers to the following questions: “Are the casing drilling surface equipment available for this well or field?” and “Do total drilling time and cost make casing drilling technology a possible candidate?” If surface equipment for casing drilling technology are not available or, if drilling time and cost values are too high,

casing drilling technology is not a good candidate for this well or field. If surface equipment for casing drilling technology are available and, if drilling time and cost for casing drilling are lower than drilling time and cost for conventional drilling technology, casing drilling is a feasible technology and is applicable to the well or field.

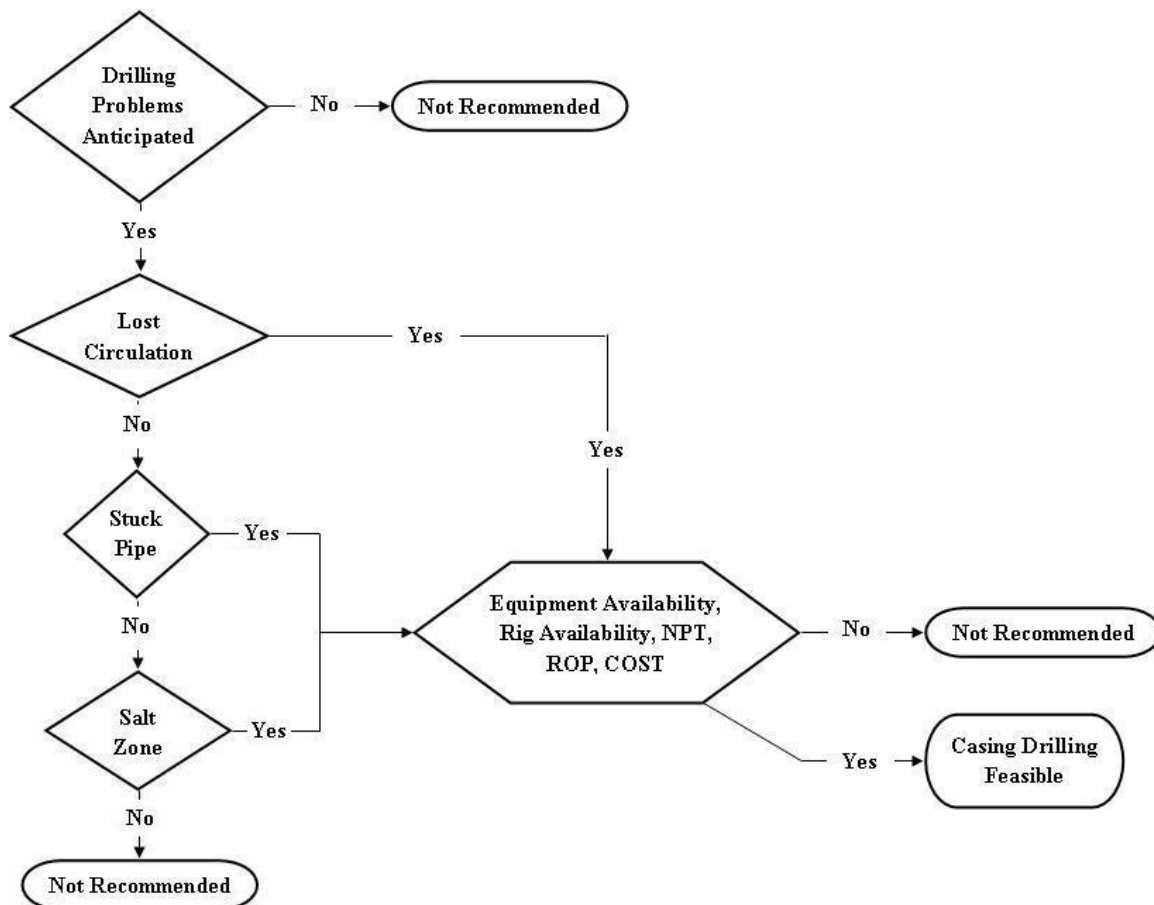

Fig. 43—Decision chart for possible application of casing drilling technology.

The decision chart shown in Fig. 44 helps to determine whether coiled tubing drilling is feasible or not recommended to drill the production casing section for a well. The process of coiled drilling candidate selection starts with the answer to the question: “What is the production casing or tubing size for this well?” If the casing diameter is greater than 4.5 in, coiled tubing drilling technology is not recommended to be applied in

this well or field. However, if the casing diameter is comprised between 2.875 in and 4.5 in, the coiled tubing drilling candidate selection continues with the answer to the following question: “Is the wellbore length less than 7,000 feet?” If the wellbore length is shallower than 7,000 feet then the process continues. If surface equipment for coiled tubing drilling technology are not available or, if drilling time and cost values are too high, coiled tubing drilling technology is not a good candidate for this well or field.

If surface equipment for coiled tubing drilling technology are available and, if drilling time and cost for coiled tubing drilling are lower than drilling time and cost for conventional drilling technology, coiled tubing drilling is a feasible technology and is applicable to the well or field. If the wellbore length is deeper than 7,000 feet then coiled tubing technology is not recommended. Finally, if the casing diameter is smaller than 2.875 in, the coiled tubing drilling candidate selection goes through the same process answering the following question: “Is the wellbore length less than 10,000 feet?” If the wellbore length is shallower than 10,000 feet then the process goes to the next question: “Are the coiled tubing drilling surface equipment available for this well or field?” and “Do total drilling time and cost make coiled tubing drilling technology a candidate?” If surface equipment for coiled tubing drilling technology are not available or, if drilling time and cost values are too high, coiled tubing drilling technology is not a good candidate for this well or field. If surface equipment for coiled tubing drilling technology are available and, if drilling time and cost for coiled tubing drilling are lower than drilling time and cost for conventional drilling technology, coiled tubing drilling is a feasible technology and is applicable to the well or field. If the wellbore length is deeper than 10,000 feet then coiled tubing technology is not recommended.

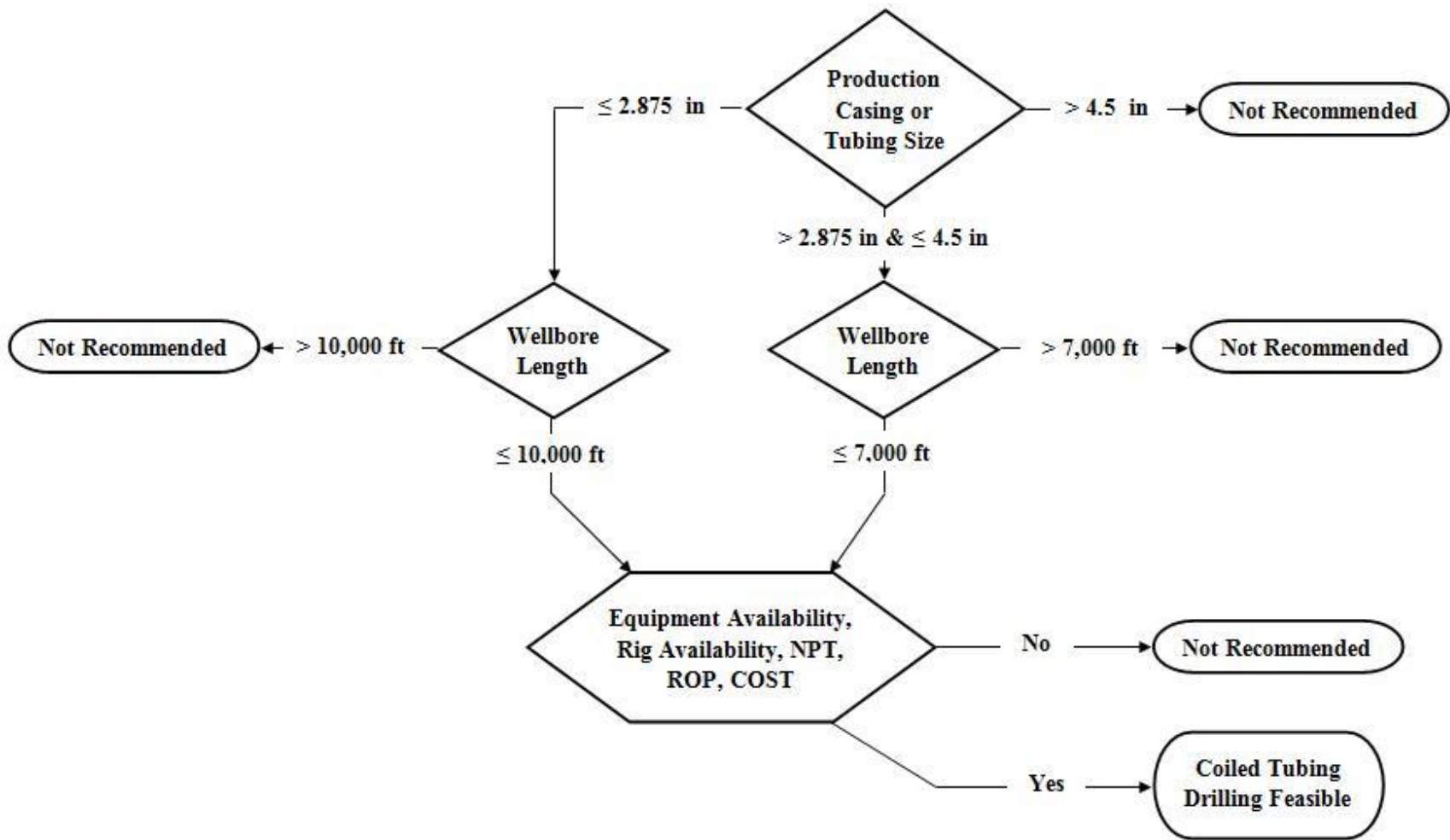

Fig. 44—Decision chart for possible application of coiled tubing drilling technology to drill production casing or tubing.

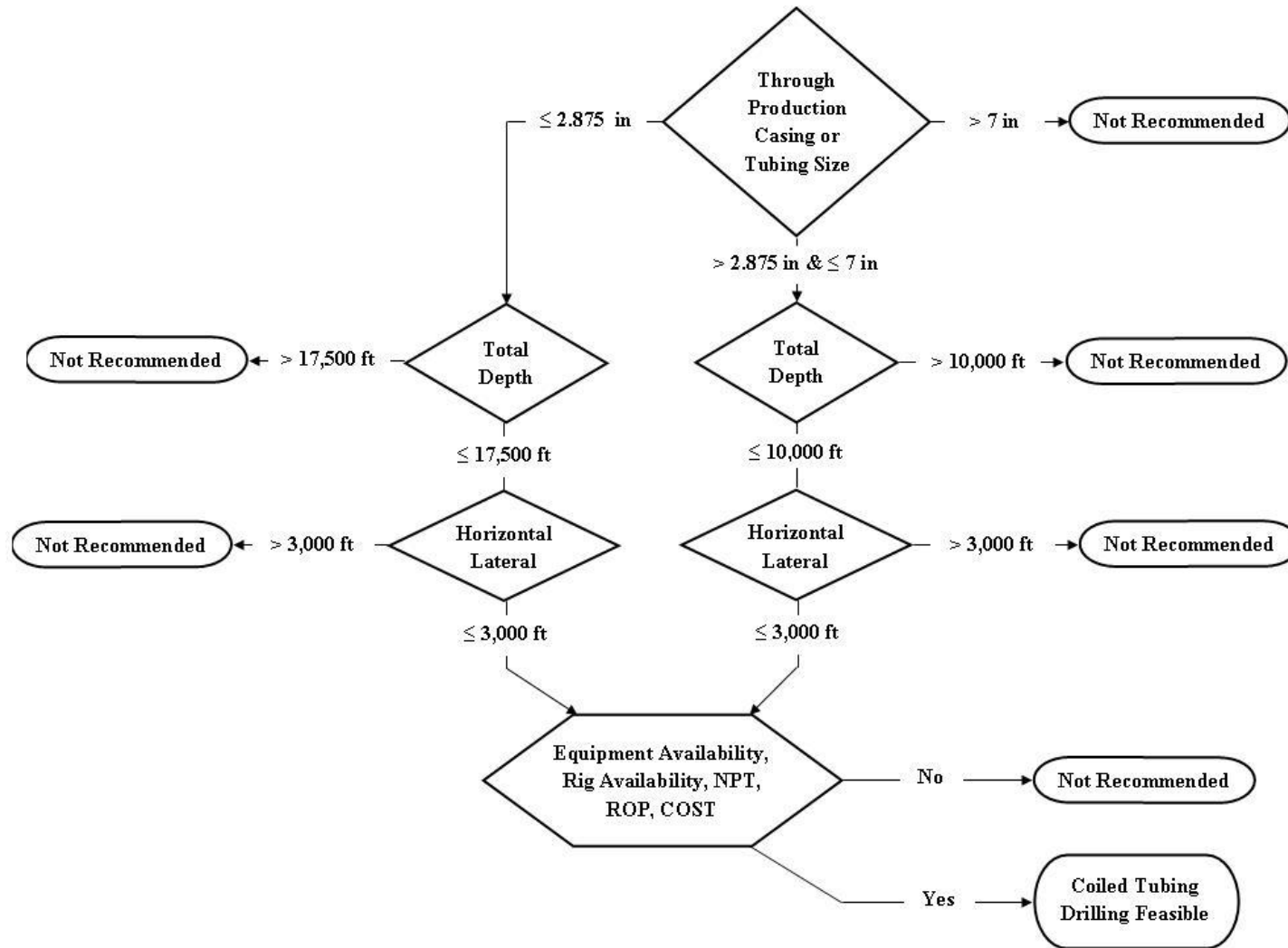

Fig. 45—Decision chart for possible application of coiled tubing drilling technology for sidetrack drilling in directional, horizontal and multilateral wellbores.

The decision chart shown in previous Fig. 45 helps to determine whether coiled tubing drilling is feasible or not recommended to re-enter or sidetrack wells for new a production casing section. The process of coiled drilling candidate selection for sidetrack wells starts with the answer to the question: “What is the production casing or tubing size that the coiled tubing has to go through?” If the casing diameter is greater than 7 in, coiled tubing drilling technology is not recommended to be applied in this well or field. However, if the casing diameter is comprised between 2.875 in and 7 in, the coiled tubing drilling candidate selection continues with the answer to the following question: “Is the wellbore length less than 10,000 feet?” If the wellbore length is shallower than 10,000 feet then the process goes to the next question: “Is the horizontal lateral length less than 3,000 feet?” If the horizontal section to drill is greater than 3,000 feet then coiled tubing drilling technology is not recommended to re-enter the well. If the horizontal lateral length is shorter than 3,000 then the process goes to the next question: “Are the coiled tubing drilling surface equipment available to re-enter this well?” and “Do total drilling time and cost make coiled tubing drilling technology a sidetrack candidate?” If surface equipment for coiled tubing drilling technology are not available or, if drilling time and cost values are too high, coiled tubing drilling technology is not a good candidate to re-enter this well. If surface equipment for coiled tubing drilling technology are available and, if drilling time and cost for coiled tubing drilling are lower than drilling time and cost for conventional drilling technology, coiled tubing drilling is a feasible technology and is applicable to sidetrack the well. Finally, if the casing diameter is smaller than 2.875 in, the coiled tubing drilling sidetrack candidate selection continues with the answer to the following question: “Is the wellbore length less than 17,500 feet?” If the

wellbore length is shallower than 17,500 feet then the process goes to the next question: “Is the horizontal lateral length less than 3,000 feet?” If the horizontal section to drill is greater than 3,000 feet then coiled tubing drilling technology is not recommended to re-enter the well. If the horizontal lateral length is shorter than 3,000 then the process goes to the next question: “Are the coiled tubing drilling surface equipment available to re-enter this well?” and “Do total drilling time and cost make coiled tubing drilling technology a sidetrack candidate?” If surface equipment for coiled tubing drilling technology are not available or, if drilling time and cost values are too high, coiled tubing drilling technology is not a good candidate to re-enter this well. If surface equipment for coiled tubing drilling technology are available and, if drilling time and cost for coiled tubing drilling are lower than drilling time and cost for conventional drilling technology, coiled tubing drilling is a feasible technology and is applicable to sidetrack the well.

Based on the decision chart shown in Fig. 46, it is possible to determine whether underbalanced drilling is applicable or not recommended. The process of underbalanced drilling method candidate selection starts with the answer to the question: “Are drilling problems anticipated in this well or field?” If no drilling problems are anticipated, then the process continues with the following question: “Is reservoir damage or formation impairment expected?” If no reservoir damage is expected to happen then underbalanced drilling method is not recommended for this well or field. However, if reservoir damage is likely to happen, the underbalanced drilling candidate selection continues with the answers to the following questions: “Are the underbalanced drilling surface equipment available for this well or field?” and “Do total drilling time and cost make underbalanced drilling method a possible candidate?” If surface equipment for underbalanced drilling

method are not available or, if drilling time and cost values are too high, underbalanced drilling method is not a good candidate for this well or field. If surface equipment for underbalanced drilling method are available and, if drilling time and cost for underbalanced drilling method are lower than drilling time and cost for conventional drilling technology associated with overbalanced drilling method, then underbalanced drilling is a feasible technology and is applicable to the well or field. Moreover, if any of the drilling problems such as lost circulation, stuck pipe or hard rock is expected to happen, the underbalanced drilling candidate selection continues with the answers to these questions: “Are the underbalanced drilling surface equipment available for this well or field?” and “Do total drilling time and cost make underbalanced drilling technology a possible candidate?” If surface equipment for underbalanced drilling method are not available or, if drilling time and cost values are too high, underbalanced drilling method is not a good candidate for this well or field. If surface equipment for underbalanced drilling method are available and, if drilling time and cost for underbalanced drilling method are lower than drilling time and cost for conventional drilling technology associated with overbalanced drilling method, then underbalanced drilling is a feasible technology and is applicable to the well or field. Finally, if any of the drilling problems such as sloughing shale, H₂S contained in reservoir fluids or kick is expected to happen, underbalanced drilling method is not a good candidate for this well or field.

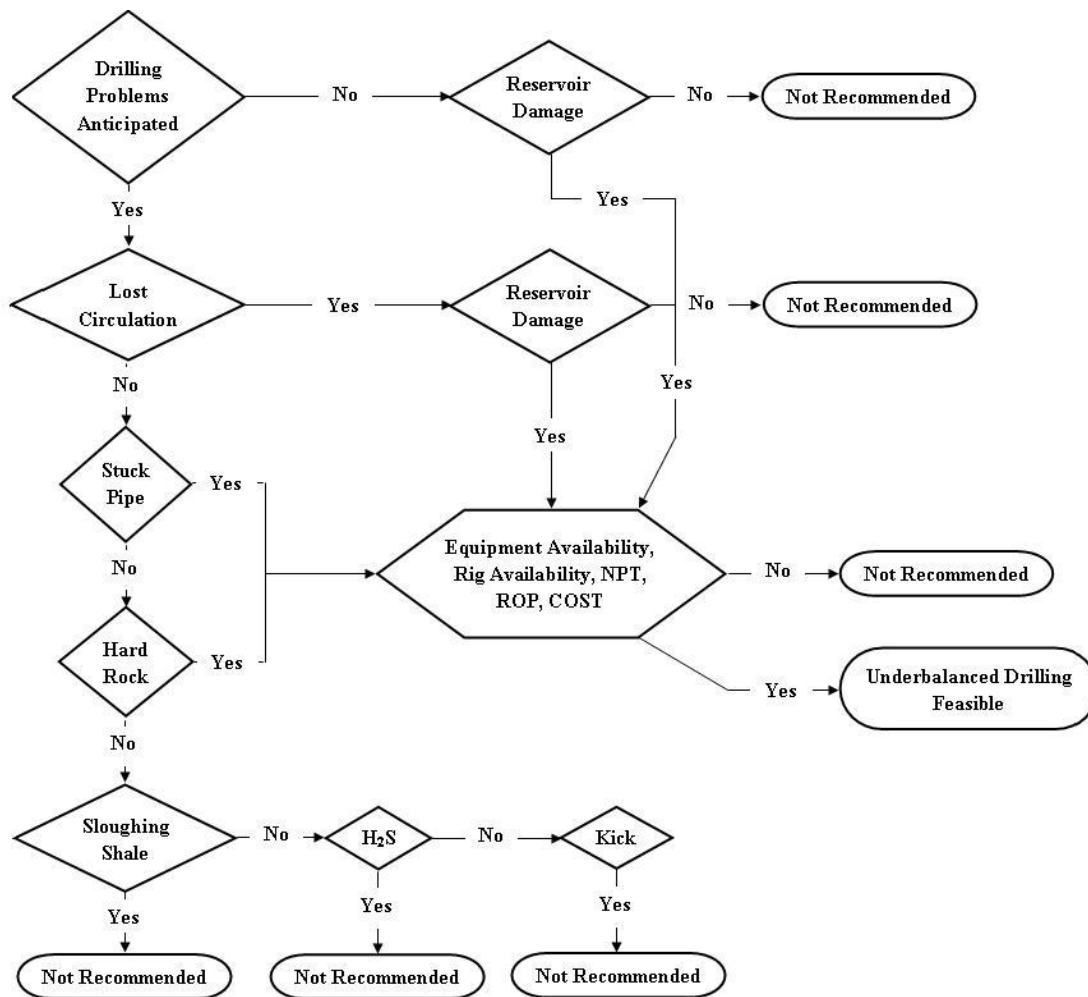

Fig. 46—Decision chart for possible application of underbalanced drilling method for production casing section (After Blade Energy Partners 2008).

The decision chart shown in Fig. 47 helps to determine whether managed pressure drilling method is applicable or not recommended to drill the intermediate casing section. The process of managed pressure drilling method candidate selection starts with the answer to the question: “Are drilling problems anticipated in this well or field?” If no drilling problems are anticipated, managed pressure drilling method is not recommended for this well or field. However, if any of the drilling problems such as lost circulation, stuck pipe or hard rock is expected to happen, the managed pressure drilling candidate selection continues with the answers to these questions: “Are the managed pressure

drilling surface equipment available for this well or field?” and “Do total drilling time and cost make managed pressure drilling method a possible candidate?” If surface equipment for managed pressure drilling method are not available or, if drilling time and cost values are too high, managed pressure drilling method is not a good candidate for this well or field. If surface equipment for managed pressure drilling method are available and, if drilling time and cost for managed pressure drilling method are lower than drilling time and cost for conventional drilling technology associated with overbalanced drilling method, then managed pressure drilling is a feasible technology and is applicable to drill the intermediate casing section for this well or field. Finally, if sloughing shale is expected to happen, managed pressure drilling method is not a good candidate to drill the intermediate section in this well.

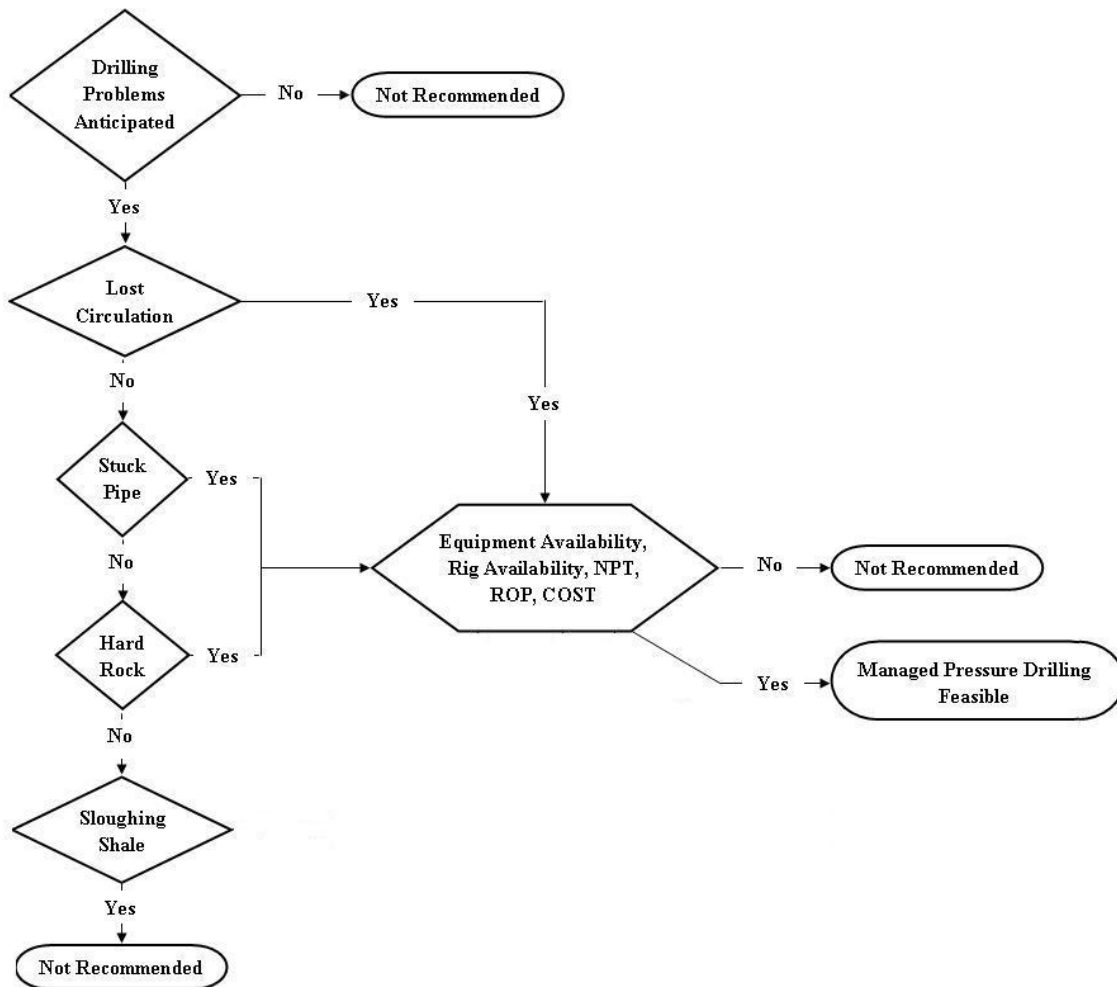

Fig. 47—Decision chart for possible application of managed pressure drilling method for intermediate casing section.

The decision chart shown in Fig. 48 helps to determine whether managed pressure drilling method is applicable or not recommended to drill the production casing section. The process of managed pressure drilling method candidate selection for production casing starts with the answer to the question: “Are drilling problems anticipated in this well or field?” If no drilling problems are anticipated, managed pressure drilling method is not recommended to drill the production casing section. However, if any of the drilling problems such as lost circulation, stuck pipe, hard rock, H₂S, CO₂ or brines contained in the formation fluids is expected to happen, the managed pressure drilling candidate

selection continues with the answers to these questions: “Are the managed pressure drilling surface equipment available for this well or field?” and “Do total drilling time and cost make managed pressure drilling method a possible candidate?” If surface equipment for managed pressure drilling method are not available or, if drilling time and cost values are too high, managed pressure drilling method is not a good candidate to drill the production casing section of this well. If surface equipment for managed pressure drilling method are available and, if drilling time and cost for managed pressure drilling method are lower than drilling time and cost for conventional drilling technology associated with overbalanced drilling method, then managed pressure drilling is a feasible technology and is applicable for drilling the production casing section of this well. Finally, if sloughing shale is expected to happen, managed pressure drilling method is not a good candidate to drill the production section of this well.

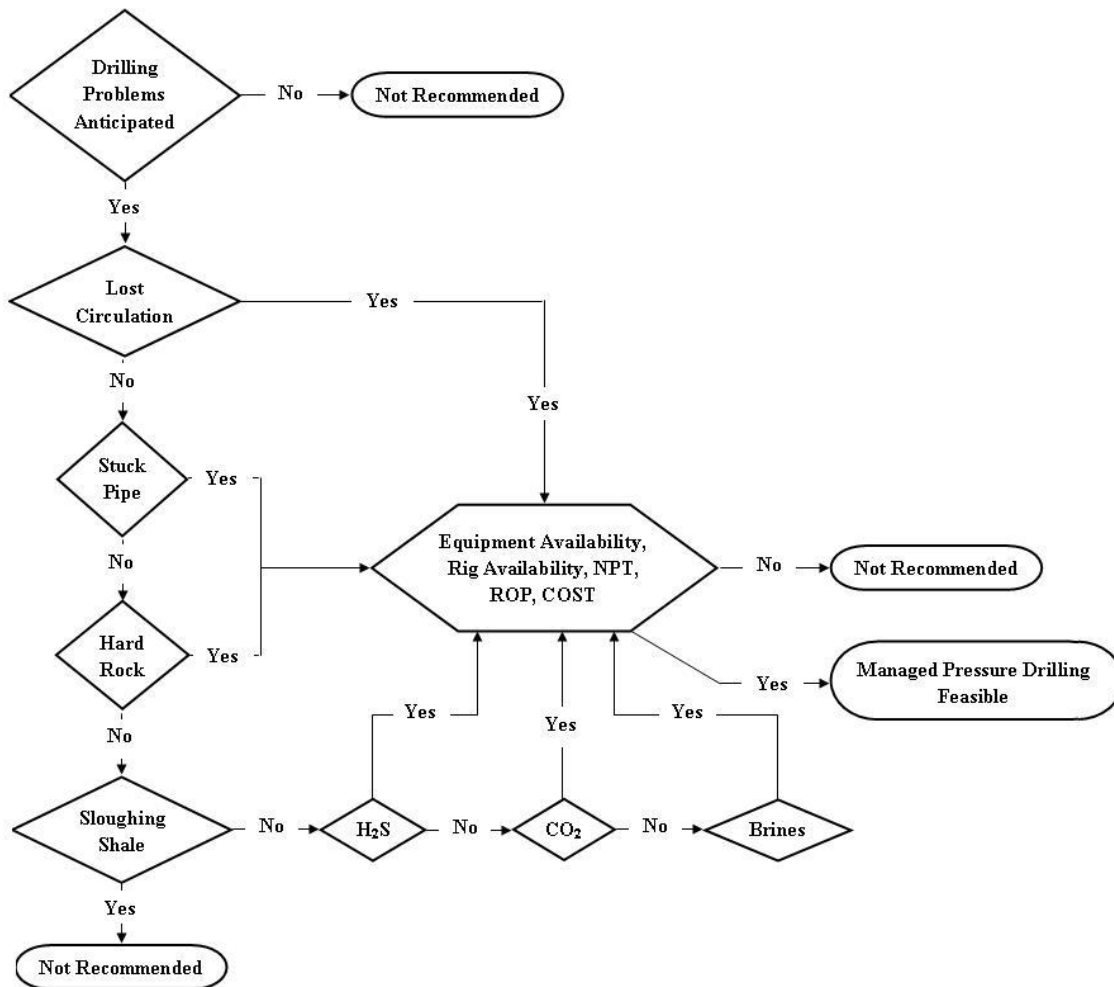

Fig. 48—Decision chart for possible application of managed pressure drilling method for production casing section.

3.3.3.4 Non-Productive Time

The economic impact of drilling non-productive time (NPT) increases as a function of drilling rig rate. Any technology or method that reduces drilling non-productive time can result into millions of dollars in drilling cost savings (Whitfill 2008). Therefore, to calculate drilling time for each technology and method, we need to estimate drilling non-productive time. Non-productive time is the time when the drilling process is stopped and appears as a flat curve on the time versus depth drilling plot (Reid et al.

2006). Thus, we identified nine key factors that are commonly known to be the source of non-productive time when drilling onshore wells. These factors represented with equal importance, in the Fig. 49 pie chart, are: lost circulation, stuck pipe, kick, wellbore instability, equipment failure (rig, wellhead, casing, connections, fatigue, drill-string twist, etc...), cement squeeze, directional control, weather delay and other (equipment handling, etc...) (After Nexen 2008). Even though these factors may vary greatly depending on the location, the type of well and the reservoir targeted, Fig. 50, gives average values for drilling problems in onshore wells in the U.S. Lost circulation (25%), stuck pipe incidents (15%) and wellbore stability issues (10%) account for 50% of the total non-productive time. However, the values given in Fig. 50 might not apply in some new tight gas developments. Indeed, directional drilling account now for about 40% of directional wells drilled in the U.S. and is routinely used in the Rocky Mountain region that holds the largest amount of tight gas in place. The weather delay, directional control and wellbore stability parameter values for tight gas reservoirs in the Rockies could be very different from those shown in Fig. 50. New drilling technologies and methods are more and more implemented in tight gas fields that will probably result in an increased value of the equipment failure parameter.

The repartition of non-productive time given in Fig. 50 should be looked at carefully before applied to any tight gas wells or fields. In certain tight gas basins such as East Texas, the values presented in Fig. 50 are a good estimate. However, for example, in the Cleveland sands located in the Anadarko basin where over 70% of wells are drilled horizontally and often associated with underbalanced method, the repartition of NPT in Fig. 50 will probably be different. In addition, in the South Texas basin, field results have

shown values much higher for lost circulation and stuck pipe incidents (Fontenot et al. 2003).

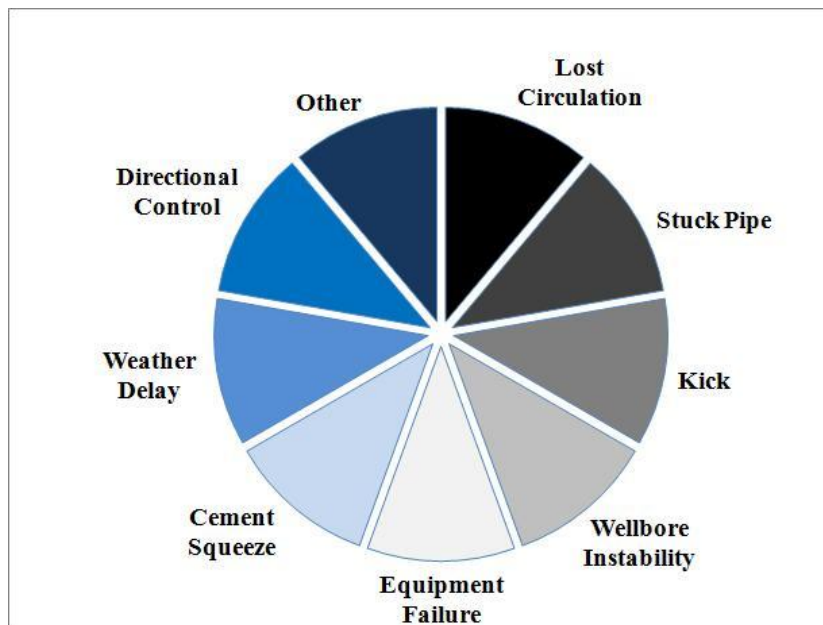

Fig. 49—Source of non-productive time for onshore wells (After Nexen 2008).

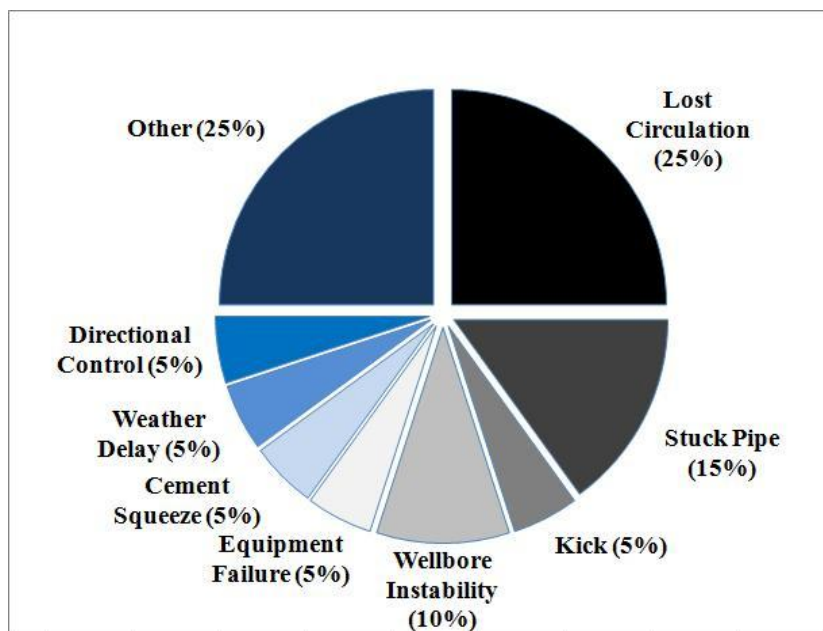

Fig. 50—Source of non-productive time for onshore wells in the U.S. (After Nexen 2008).

3.3.4 Drilling Advisor Design

3.3.4.1 Starting Menu

The drilling module of D&C Advisor is designed with several menus and screens to execute the following tasks: drilling technologies and methods selection, drilling time and cost estimation. The starting menu shown in Fig. 51 serves as an entry screen to present the main objective of the advisory module along with the professors who supervised this research and the place where this work has been done.

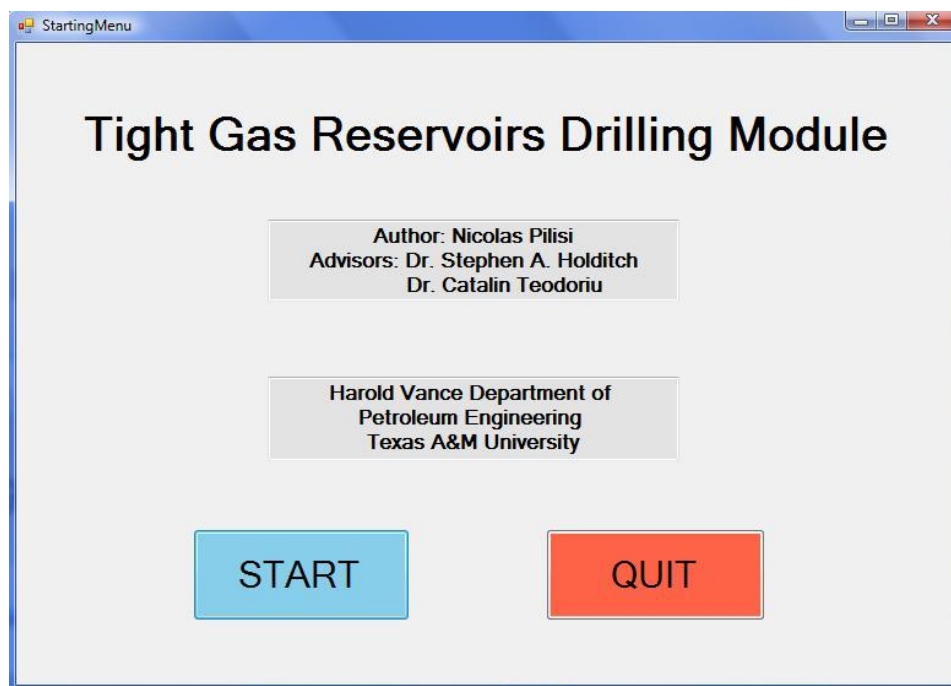

Fig. 51—Starting menu.

3.3.4.2 Central Menu

The central menu shown in Fig. 52 is the main screen in the software. It displays all the six different sub-modules that the user can access: well data, drilling parameters,

technologies and methods selection, drilling time, drilling cost, technologies and methods ranking.

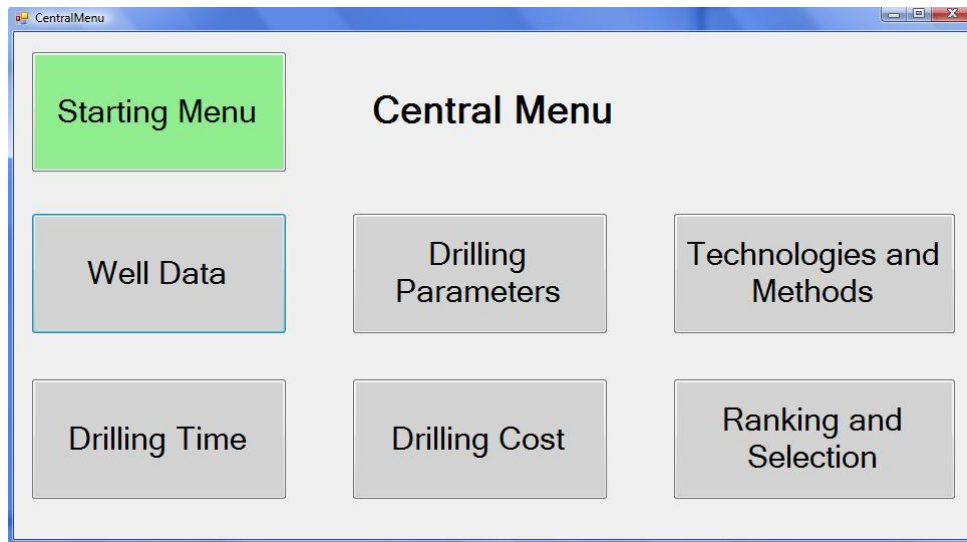

Fig. 52—Central menu.

3.3.4.3 Well Data Screen

Fig. 53 shows the first sub-module (Well Data) where the user can either enter reservoir/well dataset or load it from a text file. Eventually, the reservoir and well dataset will also be linked to the other design modules (basin analogy, completion, stimulation and completion) as shown in Fig. 40. The sub-module is divided in two main parts. The left side of the Well Data screen is dedicated to the reservoir data with several important parameters (reservoir pressure, reservoir temperature, type of tight sandstones, presence of natural fractures, type of fractures, reservoir depletion, reservoir permeability, vertical/horizontal permeability ratio). The right side of the Well Data screen displays the well trajectory, its measured depth, true vertical depth and horizontal departure. In addition, the number of reservoir targets, the production casing or tubing size calculated by the completion, stimulation and production design modules and if the well is planned

to be sidetracked are input values in the Well Data sub-module. Then, the dataset can be saved in a text file. Finally, the Well Data screen links to the next sub-module named Drilling Parameters.

The screenshot shows the 'WellData' software window. It is divided into two main sections: 'Reservoir' and 'Well Trajectory'.

Reservoir Section:

- Reservoir Pressure, psi: [Text Input] [Reset]
- Reservoir Temperature, °F: [Text Input]
- Type of Sandstones: [Dropdown Menu]
- Naturally Fractured Reservoir: [Dropdown Menu]
- Type of Fractures?: [Dropdown Menu]
- Reservoir Depleted?: [Dropdown Menu]
- Permeability, md: [Text Input]
- kv/kh Ratio: [Dropdown Menu]

Well Trajectory Section:

- Well Trajectory: Vertical, Directional, Horizontal, Multilateral
- Result Trajectory: [Dropdown Menu] [Enter]
- Measured Depth, ft: [Text Input] [Reset]
- True Vertical Depth, ft: [Text Input]
- Horizontal Departure, ft: [Text Input]
- Number of Targets: [Text Input]
- Production Casing or Tubing Size, in: [Text Input]
- Sidetrack Well?: [Dropdown Menu]

Navigation Buttons:

- LOADING DATA (From Text File)
- SAVING DATA (In Text File)
- ENTER (To Drilling Parameters)
- CENTRAL MENU

Fig. 53—Well data sub-module.

3.3.4.4 Drilling Parameters for Candidate Selection Screen

Once reservoir and well data have been entered or imported in the Well Data screen, there are two ways of using the Drilling Parameters sub-module shown in Fig. 54. On the one hand, the Drilling Parameters sub-module works as a stand-alone sub-module where the user has to enter the well plan dataset divided by hole section. Thus, for each section of casing (surface, intermediate and production casing), the user has to input well plan parameters such as the casing setting depth, the drilled length to set the casing and the casing outer diameter. Then, for each section of casing, the user is asked several

questions about potential drilling problems while drilling the well such as hard rock formations, lost circulation zones, stuck pipe incidents, wellbore stability issues, sloughing shale or salt zones. In addition, surface and intermediate hole section deal only with drilling problems across the wellbore while production hole section takes in consideration the magnitude of fluid invasion in and out of the reservoir such as formation damage, H₂S, CO₂, brines. On the other hand, the Drilling Parameters sub-module will eventually load parameters from the other design modules (completion, stimulation and production). By clicking on the casing design button located in the production casing part of the Drilling Parameters sub-module, a casing design will be generated. To generate the casing design, the program loads the production casing or tubing size calculated by the other design modules as shown in Fig. 40 and then uses standard casing design procedure to determine casing outer diameters for intermediate casings and surface casing (Economides et al. 1998). Besides, if more than one intermediate casing is needed to drill the well, the user can click on the Add Intermediate Casing button to display the screen shown in Fig. 55. All the dataset entered or loaded can be saved in a text file as well. Finally, the Drilling Parameters screen links to the next sub-module named Technologies and Methods Candidate Selection.

Fig. 54—Drilling parameters for candidate selection sub-module.

Fig. 55—Add intermediate casing sub-module.

3.3.4.5 Technologies and Methods Feasibility

The Technologies and Methods Feasibility sub-module is divided in two parts. On the left side of the screen shown in Fig. 56, the user is asked about the availability for drilling technologies and methods surface equipment where the company is planning to operate the tight gas field. These surface equipment are listed as follow: availability of conventional drilling rig, built-for purpose drilling rig (Fig. 10), casing drilling rig (Fig. 17), hybrid coiled tubing drilling rig (Fig. 15), casing drilling special components (Fig. 19 and Fig. 22), coiled tubing components (Fig. 14), managed pressure drilling components (Fig. 30) and underbalanced drilling components (Fig. 27). For instance, in the U.S. where numerous contractors are present, there are no limitation for using all the technologies and methods available to drill tight gas reservoirs. However, in other part of the globe, some technologies and methods such as casing drilling technology or managed pressure drilling may not be available to the company to produce the tight gas field. On the right part the sub-module shown in of Fig. 56, by clicking on the Results button, the user displays whether drilling practices (technologies and methods) are feasible or not recommended to drill the tight gas well. To determine which drilling practice is feasible to drill the tight gas well or field, the program runs the several decision charts have been described from Fig. 42 to Fig. 49 and take as input values the ones entered in the Well Data and Drilling Parameters sub-modules and also the drilling equipment availability. The technologies and methods feasibility is displayed for each section of hole (surface, intermediate and production casing). The results can be saved in a text file for comparison with other tight gas well configurations. Then, from this sub-module, the user can access the Drilling Time Estimation sub-module.

Fig. 56—Technologies and methods feasibility sub-module.

3.3.4.6 Drilling Time Estimation Sub-Module

The Drilling Time Estimation sub-module is shown in Fig. 57. To estimate drilling time for each section of hole (surface, intermediate and production casing), the sub-module uses the following equations (After Bourgoyne et al. 1986):

$$\text{Drilling Time} = \sum_{\text{surface}}^{\text{production}} \text{DT}_{\text{casing}}$$

$$\text{DT}_{\text{casing}} = \frac{\text{DrilledLength}}{(\text{RateOfPenetration} * 24 * \text{ROPnormalized})} * \frac{1}{1 - \frac{\text{Non ProductiveTime}}{100}}$$

with:

- Drilling Time in days.
- Drilled Length in feet (ft) given by the Drilling Parameters sub-module.
- Rate Of Penetration (ROP) in feet per hour (ft/hr) given by the Drilling Parameters sub-module.
- $0 < \text{Non Productive Time (NPT)} \leq 40$

The screenshot shows a software window titled "Drilling Time". On the left side, there is a vertical menu with five buttons: "NON PRODUCTIVE TIME" (grey), "DRILLING RATE OF PENETRATION" (grey), "RESULTS" (blue), "SAVING DATA (In Text File)" (white), and "ENTER (To Drilling Cost)" (light blue). Below these is a green button labeled "CENTRAL MENU". The main area of the window is titled "Drilling Time Results" and is organized into three sections: "Surface Casing", "Intermediate Casing", and "Production Casing". Each section contains a list of drilling methods with corresponding input fields and checkboxes. At the bottom, there is a "TOTAL DRILLING TIME TO TD, day" field and a "Calc" button.

Section	Method	Input Field	Checkbox
Surface Casing	Conventional with Overbalanced, day	<input type="text"/>	<input type="checkbox"/>
	Casing Drilling with Overbalanced, day	<input type="text"/>	<input type="checkbox"/>
Intermediate Casing	Conventional with Overbalanced, day	<input type="text"/>	<input type="checkbox"/>
	Conventional with Managed Pressure, day	<input type="text"/>	<input type="checkbox"/>
	Casing Drilling with Overbalanced, day	<input type="text"/>	<input type="checkbox"/>
	Casing Drilling with Managed Pressure, day	<input type="text"/>	<input type="checkbox"/>
Production Casing	Conventional with Overbalanced, day	<input type="text"/>	<input type="checkbox"/>
	Conventional with Underbalanced, day	<input type="text"/>	<input type="checkbox"/>
	Conventional with Managed Pressure, day	<input type="text"/>	<input type="checkbox"/>
	Casing Drilling with Overbalanced, day	<input type="text"/>	<input type="checkbox"/>
	Casing Drilling with Underbalanced, day	<input type="text"/>	<input type="checkbox"/>
	Casing Drilling with Managed Pressure, day	<input type="text"/>	<input type="checkbox"/>
	Coiled Tubing Drilling with Overbalanced, day	<input type="text"/>	<input type="checkbox"/>
	Coiled Tubing Drilling with Underbalanced, day	<input type="text"/>	<input type="checkbox"/>
TOTAL DRILLING TIME TO TD, day		<input type="text"/>	<input type="button" value="Calc"/>

Fig. 57—Drilling time estimation sub-module.

Therefore, to calculate drilling time for each section of hole, we need to estimate the rate of penetration for each technology and method normalized to conventional drilling technology associated with overbalanced method. In addition, we need to

estimate the drilling non-productive time that are anticipated when drilling a tight gas well. In the Drilling Time Estimation sub-module shown in Fig. 57, a first sub-module estimates drilling non-productive time (NPT) as shown in Fig. 58. A second sub-module shown in Fig. 59 estimates the drilling rate of penetration (ROP) for each drilling technology and method.

The Non-Productive Time sub-module uses fuzzy-logic systems for each of the main parameters found to be a source of NPT for onshore wells as shown in Fig. 49 (lost circulation, stuck pipe, kick, wellbore instability, drilling equipment failure, cement squeeze, weather delay, directional control, other). In the Non-Productive Time sub-module, each source of non-productive time parameter can take 11 different values ranging between 0 and 1 (0, 0.1, 0.2, 0.3, 0.4, 0.5, 0.6, 0.7, 0.8, 0.9, 1). Then, we defined membership functions for each source of non-productive time parameter. Field studies have proven that NPT usually range between 10% and 40% of the effective drilling time (York et al., 2009). Even though, in certain areas, NPT can be higher than 40%, common values for NPT in tight gas applications range between 10%-30%. The membership functions implemented in the NPT sub-module are defined in the following equations by setting at 40% the maximum taken by NPT and taking source of NPT values in onshore wells from Fig. 50. Thus, we obtain the following membership functions in order of importance:

$$F_{\text{LostCirculation}} = F_{\text{Other}} = \begin{cases} F(0) = 0 \\ F(1) = 10 \end{cases}$$

$$F_{\text{StuckPipe}} = \begin{cases} F(0) = 0 \\ F(1) = 6 \end{cases}$$

$$F_{\text{WellboreInstability}} \begin{cases} F(0) = 0 \\ F(1) = 4 \end{cases}$$

$$F_{\text{Kick}} = F_{\text{EquipmentFailure}} = F_{\text{CementSqueeze}} = F_{\text{WeatherDelay}} = F_{\text{DirectionalControl}} \begin{cases} F(0) = 0 \\ F(1) = 2 \end{cases}$$

Thereafter, non-productive time can be estimated adding the values from each of the 9 main parameters. The result is display in percentage of NPT (flat time) in comparison with effective drilling time (bottom of Fig. 58). If the user already knows the average non-productive time value for a given tight gas field, the NPT value can be input in the NPT sub-module without using the membership functions and moving the track bars shown in Fig. 58.

Fig. 58—NPT estimation.

The drilling Rate Of Penetration sub-module shown in Fig. 59 loads ROP for each technology and method in comparison with the reference ROP that is conventional drilling associated with overbalanced method (CwO). The drilling rate of penetration for conventional drilling technology associated with overbalanced method takes the value 1. The other rates of penetration are compared or normalized to the value 1. Several industry papers have tested and compared drilling technologies such as casing drilling (Warren et al. 2005) or coiled tubing drilling (Brillon et al. 2007) with conventional drilling. In addition, similar works have compared drilling methods such as underbalanced drilling (Garcia et al. 2007) or managed pressure drilling (Stone et al., 2006) with overbalanced drilling.

Fig. 59—ROP estimation.

The following Table 5 references ROP normalized to conventional drilling with overbalanced method. The left column in Table 5 gives a range of values for each

technology and method because ROP values from field applications are often dispersed. The right column in Table 5 gives an average ROP value normalized to CwO. If the user has different ROPs for a given tight gas field, different values can be entered in the ROP sub-module. After estimation of NPT and ROPs, drilling time is then calculated for each section of hole for the drilling technologies and methods that have been found feasible in the Drilling Technology Selection sub-module. Then, the user can access the Drilling Cost Estimation sub-module.

ROP Range	Technologies & Methods	ROP Normalized to CwO
1.0	Conventional Drilling with Overbalanced	1.0
1.5 – 3.0	Conventional Drilling with Underbalanced	2.0
1.5 – 2.5	Conventional Drilling with Managed Pressure	1.5
1.1 – 1.3	Casing Drilling with Overbalanced	1.3
2.5	Casing Drilling with Underbalanced	2.5
2.0	Casing Drilling with Managed Pressure	2.0
1.0 – 3.0	Coiled Tubing Drilling with Overbalanced	1.5
1.0 – 5.0	Coiled Tubing Drilling with Underbalanced	3.0

3.3.4.7 Drilling Cost Estimation Sub-Module

The Drilling Cost Estimation sub-module is shown in Fig. 60. To estimate drilling cost for each section of hole (surface, intermediate and production casing), the sub-module uses the following equations:

$$\text{Drilling Cost} = \sum_{\text{surface}}^{\text{production}} \text{DC}_{\text{casing}}$$

$$DC_{\text{casing}} = \text{Technology Daily Cost} * DT_{\text{casing}} * DC_{\text{normalized}}$$

with:

- Drilling Cost in \$.
- Technology Daily Cost in \$/day.
- DT_{casing} in days.

To estimate the cost of drilling technologies and methods, the user has two ways to proceed. On the one hand, if drilling costs for each technology and method have been obtained from the contractors providing the special surface equipment, the user can use each of the five sub-modules shown from Fig. 61 to Fig. 65 to estimate drilling cost for each section of hole. On the other hand, if the user do not obtain prices associated with special surface equipment required to use casing drilling or coiled tubing drilling technologies or to apply underbalanced drilling or managed pressure drilling methods, then, the sixth sub-module named Drilling Cost Coefficients shown in Fig. 66 estimates drilling costs by using coefficients normalized to conventional drilling technology associated with overbalanced drilling method.

Drilling Cost Results

Surface Casing

Conventional with Overbalanced, \$

Casing Drilling with Overbalanced, \$

Intermediate Casing

Conventional with Overbalanced, \$

Conventional with Managed Pressure, \$

Casing Drilling with Overbalanced, \$

Casing Drilling with Managed Pressure, \$

Production Casing

Conventional with Overbalanced, \$

Conventional with Underbalanced, \$

Conventional with Managed Pressure, \$

Casing Drilling with Overbalanced, \$

Casing Drilling with Underbalanced, \$

Casing Drilling with Managed Pressure, \$

Coiled Tubing Drilling with Overbalanced, \$

Coiled Tubing Drilling with Underbalanced, \$

TOTAL DRILLING COST, \$

Fig. 60—Drilling cost estimation sub-module.

Conventional Drilling Equipment

Conventional Drilling Rig Rate, \$/d

Built For Purpose Rig Rate, \$/d

Miscellaneous, \$/d

Global Cost, \$/d

Fig. 61—Conventional drilling components cost estimation sub-module.

The screenshot shows a window titled "CasingDrillingComponents". Inside, under the heading "Casing Drilling Equipment", there are four input fields: "Casing Drilling Rig, \$/d", "Casing Drive System, \$/d", "Casing Drilling Assembly, \$/d", and "Miscellaneous, \$/d". Below these is a "Global Cost, \$/d" field and a "Calc" button. At the bottom, there is a large blue button labeled "ENTER (To Drilling Costs)".

Fig. 62—Casing drilling components cost estimation sub-module.

The screenshot shows a window titled "CoiledTubingComponents". Inside, under the heading "Coiled Tubing Drilling Equipment", there are three input fields: "Coiled Tubing String, \$/d", "BHA, \$/d", and "Miscellaneous, \$/d". Below these is a "Global Cost, \$/d" field and a "Calc" button. At the bottom, there is a large blue button labeled "ENTER (To Drilling Costs)".

Fig. 63—Coiled tubing drilling components cost estimation sub-module.

The screenshot shows a window titled "ManagedPressureComponents". Inside, under the heading "Managed Pressure Drilling Equipment", there are two input fields: "Fluid Supply + Equipment, \$/d" and "Miscellaneous, \$/d". Below these is a "Global Cost, \$/d" field and a "Calc" button. At the bottom, there is a large blue button labeled "ENTER (To Drilling Costs)".

Fig. 64—Managed pressure drilling components cost estimation sub-module.

Fig. 65—Underbalanced drilling components cost estimation sub-module.

The drilling Reference Cost sub-module shown in Fig. 66 loads drilling cost for each technology and method in comparison with the reference cost that is conventional drilling associated with overbalanced method (CwO). The drilling cost for conventional drilling technology associated with overbalanced method takes the value 1. The other drilling costs are compared or normalized to the value 1.

Fig. 66—Drilling reference cost normalized to CwO.

The following Table 6 references drilling costs normalized to conventional drilling with overbalanced method. The left column in Table 6 gives a range of values for each technology and method because drilling costs are often dispersed. The right column in Table 6 gives an average drilling cost value normalized to CwO. Drilling costs can be modified in the Reference Cost sub-module. Then, drilling costs are calculated for each section of hole for the drilling technologies and methods that have been found feasible in the Drilling Technology Selection sub-module. Then, the user can access the Ranking Technology and Method sub-module.

TABLE 6—Cost normalized to conventional drilling using overbalanced (CwO)		
Drilling Cost Range	Technologies & Methods	Cost Normalized to CwO
1	Conventional Drilling with Overbalanced	1
1.3 - 2.0	Conventional Drilling with Underbalanced	1.5
1.3 – 2.0	Conventional Drilling with Managed Pressure	1.5
1.2 – 1.5	Casing Drilling with Overbalanced	1.2
1.5 – 2.5	Casing Drilling with Underbalanced	1.8
1.5 – 2.5	Casing Drilling with Managed Pressure	1.8
1.3 – 2.0	Coiled Tubing Drilling with Overbalanced	1.3
1.8 – 2.5	Coiled Tubing Drilling with Underbalanced	2.0

3.3.4.8 Ranking Technologies and Methods Sub-Module

The Ranking Technology and Method sub-module is shown in Fig. 67. This is the last sub-module in the Drilling Advisory program that summarized calculations performed in the previous sub-module (Drilling Technology Selection, Drilling Time, and Drilling Cost) and gives a ranking of drilling technologies and methods. The left side of Fig. 67 displays total drilling time and cost for the tight gas well while the right side of

Fig. 67 ranks from 1 to 8 drilling technologies and methods found feasible in the Drilling Technology Selection sub-module.

The screenshot shows a software window titled "RankingSelection". It is divided into several sections:

- Total Drilling Time (Surface To Total Depth):** A list of eight drilling methods with corresponding input boxes for time in days:
 - Conventional with Overbalanced, day
 - Conventional with Underbalanced, day
 - Conventional with Managed Pressure, day
 - Casing Drilling with Overbalanced, day
 - Casing Drilling with Underbalanced, day
 - Casing Drilling with Managed Pressure, day
 - Coiled Tubing Drilling with Overbalanced, day
 - Coiled Tubing Drilling with Underbalanced, day
- Total Drilling Cost (Surface To Total Depth):** A list of the same eight drilling methods with corresponding input boxes for cost in dollars:
 - Conventional with Overbalanced, \$
 - Conventional with Underbalanced, \$
 - Conventional with Managed Pressure, \$
 - Casing Drilling with Overbalanced, \$
 - Casing Drilling with Underbalanced, \$
 - Casing Drilling with Managed Pressure, \$
 - Coiled Tubing Drilling with Overbalanced, \$
 - Coiled Tubing Drilling with Underbalanced, \$
- Ranking:** A vertical list of eight numbered boxes (1-8) for ranking the technologies.
- Buttons:** A "TOTAL DRILLING TIME" button, a "TOTAL DRILLING COST" button, a blue "RESULTS" button, and a green "CENTRAL MENU" button.

Fig. 67—Ranking technology and method sub-module.

4 DRILLING ADVISOR APPLICATION

In the following section, we are going to run the Drilling Advisory system with three different tight gas reservoirs wellbore configurations: vertical drilling, horizontal drilling, and directional S-shaped drilling. We chose three tight gas reservoirs located in different regions in the U.S.: South Texas, North Texas-West Oklahoma, and Rocky Mountains Region.

4.1 South Texas Tight Gas Reservoirs

4.1.1 Wilcox-Lobo Trend Well Data

The Wilcox-Lobo trend is located near the U.S. and Mexican border in Webb and Zapata counties, South Texas. Tight gas reservoirs depth in the Wilcox-Lobo trend range from 5,000 ft to 12,000 ft. Also, reservoir permeability is very low between 0.0003 md and 0.5 md. In addition, the Wilcox-Lobo trend produced from geo-pressured sands with pore pressure gradient up to 0.9 psi/ft. Reservoir temperatures range between 175°F and 325°F (Robinson et al. 1986).

4.1.2 Lobo Field Drilling Advisor Results

In the Well Data sub-module shown in Fig. 68, we loaded a reservoir dataset (Robinson et al. 1986) and a well construction dataset (Fontenot et al. 2003) taken from the petroleum industry literature. The tight well has a vertical trajectory using a 4.5 inch

production casing at 9,950 ft. At 9,950 ft, reservoir pressure is about 7,500 psi and reservoir temperature is about 275°F.

The screenshot shows the 'WellData' software window with two main sections: 'Reservoir' and 'Well Trajectory'.

Reservoir Section:

- Reservoir Pressure, psi: 7500 (with a 'Reset' button)
- Reservoir Temperature, °F: 275
- Type of Sandstones: Continuous Multiple Layers (dropdown)
- Naturally Fractured Reservoir: Yes (dropdown)
- Type of Fractures?: Moderate Opened Fracture Network (dropdown)
- Reservoir Depleted?: Yes (dropdown)
- Permeability, md: 0.01
- kv/kh Ratio: < 0.1 (dropdown)
- Buttons: 'LOADING DATA (From Text File)' and 'SAVING DATA (In Text File)'

Well Trajectory Section:

- Well Trajectory: Vertical, Directional, Horizontal, Multilateral (dropdown)
- Vertical: **Vertical** (dropdown, highlighted in red, with an 'Enter' button)
- Measured Depth, ft: 9950 (with a 'Reset' button)
- True Vertical Depth, ft: 9950
- Horizontal Departure, ft: 0
- Number of Targets: 1
- Production Casing or Tubing Size, in: 4.5
- Sidetrack Well?: No (dropdown)
- Buttons: 'ENTER (To Drilling Parameters)' (blue) and 'CENTRAL MENU' (green)

Fig. 68—Well data sub-module for a tight gas well in the Wilcox-Lobo trend.

Fig. 69 presents the well planning with a 9-5/8 inch surface casing set at 1,200 ft followed by a 7 inch intermediate casing set at 8,100 ft. As given in the Well Data sub-module, a 4.5 inch production casing is set at 9,950 ft (Fontenot et al. 2003). For surface casing, no drilling problems are anticipated and therefore textboxes take “No” as input values. For intermediate casing, drilling problems such as severe lost circulation zones and stuck pipe incidents are expected. For production casing, lost circulation zones and stuck pipe incidents are anticipated along with reservoir damage. The rate of penetration decreases between surface casing (40 ft/hr) and production casing (15 ft/hr). In addition, the well is drilled without any surface limitations.

Drilling Parameters for Candidate Selection

General

Surface Limitations: None

Existing Wells in the Vicinity?: Yes

Surface Casing

Casing Setting Depth, ft: 1200 [Reset]

Drilled Length, ft: 1200 [Calc]

Casing Size, in: 9.625

Hard Rock Formations Expected: No

Estimated Rate of Penetration, ft/hr: 40

Anticipated Drilling Problems?: No

Lost Circulation Zones?: No

Stuck Pipe Incidents?: No

Wellbore Stability Issue?: No

Sloughing Shale?: No

Salt Zones?: No

LOADING DATA (From Text File) | SAVING DATA (In Text File)

Intermediate Casing N°1

Casing Setting Depth, ft: 8100 [Reset]

Drilled Length, ft: 6900 [Calc]

Casing Size, in: 7

Hard Rock Formations Expected: No

Estimated Rate of Penetration, ft/hr: 25

Anticipated Drilling Problems?: Yes

Lost Circulation Zones?: Yes

Stuck Pipe Incidents?: Yes

Wellbore Stability Issue?: No

Sloughing Shale?: No

Salt Zones?: No

LOADING DATA (From Text File) | SAVING DATA (In Text File)

Production Casing

Casing Setting Depth, ft: 9950 [Reset]

Drilled Length, ft: 1850 [Calc]

Casing Size, in: 4.5 [Casing Design]

Hard Rock Formations Expected: No

Estimated Rate of Penetration, ft/hr: 15

Anticipated Drilling Problems?: Yes

Lost Circulation Zones?: Yes

Stuck Pipe Incidents?: Yes

Wellbore Stability Issue?: No

Sloughing Shale?: No

Salt Zones?: No

Formation Damage Expected?: Yes

Kick, Blow-Out?: No

H2S?: No

CO2?: Yes

Brines?: No

LOADING DATA (From Text File) | SAVING DATA (In Text File)

ENTER (To Technology Selection) | CENTRAL MENU

Fig. 69—Drilling parameters sub-module for a tight gas well in the Wilcox-Lobo trend.

In Fig. 70, surface equipment for each technology and method are available because in North America and especially in South Texas, all special components needed for casing drilling and coiled tubing drilling technologies and for underbalanced drilling and managed pressure drilling technologies are available. The results on Fig. 70 show that most of the drilling technologies and methods are feasible to drill tight gas reservoirs in the Wilcox-Lobo trend. However, coiled tubing drilling technology appears as a not recommended drilling practice.

Rig Availability	
Conventional Drilling Rig Available ?	Yes
Built For Purpose Rig Available ?	Yes
Casing Drilling Rig Available ?	Yes
Hybrid Coiled Tubing Rig Available ?	Yes

Special Equipment and Trained Crew Availability	
Casing Drilling Components Available ?	Yes
Coiled Tubing Components Available ?	Yes
Managed Pressure Drilling Components Available ?	Yes
UnderBalanced Drilling Components Available ?	Yes

Drilling Technology and Method Results	
Surface Casing	
Conventional with Overbalanced	Feasible
Casing Drilling with Overbalanced	Feasible
Intermediate Casing	
Conventional with Overbalanced	Feasible
Conventional with Managed Pressure	Feasible
Casing Drilling with Overbalanced	Feasible
Casing Drilling with Managed Pressure	Feasible
Production Casing	
Conventional with Overbalanced	Feasible
Conventional with Underbalanced	Feasible
Conventional with Managed Pressure	Feasible
Casing Drilling with Overbalanced	Feasible
Casing Drilling with Underbalanced	Feasible
Casing Drilling with Managed Pressure	Feasible
Coiled Tubing Drilling with Overbalanced	Not Recommended
Coiled Tubing Drilling with Underbalanced	Not Recommended

Fig. 70—Technology feasibility sub-module for a tight gas well in the Wilcox-Lobo trend.

Fig. 71 shows the NPT estimation in the Wilcox-Lobo Trend according to field results (Fontenot et al. 2003). Since lost circulation zones and stuck pipe incidents are severe, the track bar on Fig. 70 is set at its maximum. In addition, equipment failure and other drilling problems are set as moderate while directional control and weather delay are kept at their minimum values. Therefore, total non-productive time is estimated to be equal to 21% of effective drilling time that seems to be a reasonable value for a tight gas well drilled in South Texas. In addition, Fig. 72 loads default values discussed in Table 5.

Non Productive Time Estimation

Lost Circulation 0 0.5 1

Stuck Pipe 0 0.5 1

Kick 0 0.5 1

Wellbore Instability 0 0.5 1

Equipment Failure 0 0.5 1

Cement Squeeze 0 0.5 1

Weather Delay 0 0.5 1

Directional Control 0 0.5 1

Other 0 0.5 1

NPT, % 21

CALCULATION

ENTER
(To Drilling Time)

Fig. 71—Non-productive time estimation sub-module for a tight gas well in the Wilcox-Lobo trend.

ROP

Drilling Technology and Methods	Normalized ROP to CwO
Conventional with Overbalanced	1
Conventional with Underbalanced	2
Conventional with Managed Pressure	1.5
Casing Drilling with Overbalanced	1.3
Casing Drilling with Underbalanced	2.5
Casing Drilling with Managed Pressure	2
Coiled Tubing Drilling with Overbalanced	1.5
Coiled Tubing Drilling with Underbalanced	3

ENTER
(To Drilling Time)

Load Default

Fig. 72—Rate of penetration estimation sub-module for a tight gas well in the Wilcox-Lobo trend.

The following Fig. 73 presents drilling time estimation, in days, for each drilling technology and drilling method for each section of hole.

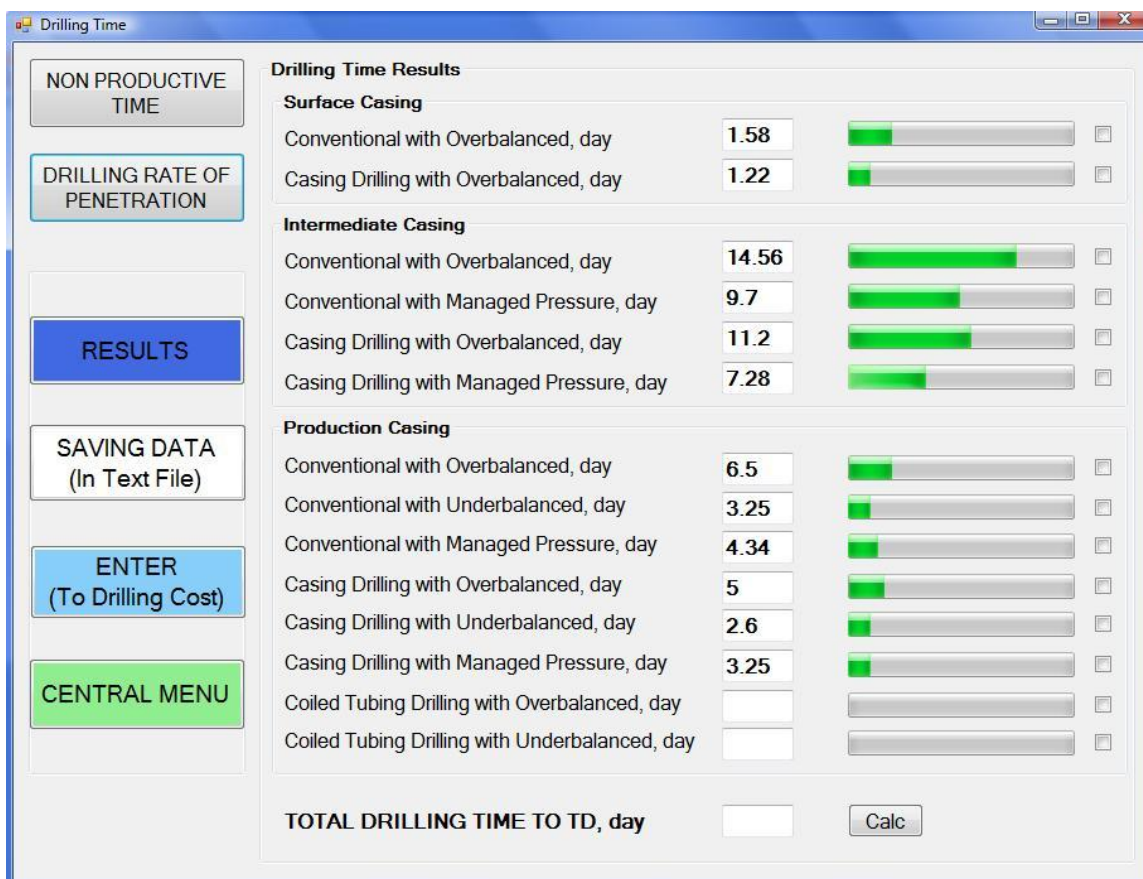

Fig. 73—Drilling time estimation sub-module for a tight gas well in the Wilcox-Lobo trend.

In Fig. 74, global daily cost for conventional drilling technology associated with overbalanced drilling is set at about 50,000 \$/day. This value can vary greatly according to the well location and the drilling rig supply and demand but 50,000 \$/day is a reasonable value as of early 2009 in South Texas. In addition, Fig. 75 illustrates the case where the user does not know the prices associated with drilling technologies and methods that have been found feasible in the Technology and Method Feasibility sub-

module (casing drilling, underbalanced drilling and managed pressure drilling). Thus, default values shown in Table 6 are loaded in the Reference Cost sub-module.

The screenshot shows a window titled "ConventionalDrillingComponents". It contains the following elements:

- Conventional Drilling Equipment** section with input fields for:
 - Conventional Drilling Rig Rate, \$/d
 - Built For Purpose Rig Rate, \$/d
 - Miscellaneous, \$/d
- A "Global Cost, \$/d" input field with the value "50000" entered.
- A "Calc" button.
- A large blue button at the bottom labeled "ENTER (To Drilling Costs)".

Fig. 74—Conventional drilling technology cost estimation sub-module for a tight gas well in the Wilcox-Lobo trend.

The screenshot shows a window titled "Reference_Costs". It contains the following elements:

- Drilling Technology and Methods** section with a list of technologies and their corresponding normalized cost factors:

Drilling Technology and Methods	Normalize Cost to CwO
Conventional with Overbalanced	1
Conventional with Underbalanced	2
Conventional with Managed Pressure	1.5
Casing Drilling with Overbalanced	1.2
Casing Drilling with Underbalanced	1.8
Casing Drilling with Managed Pressure	1.8
Coiled Tubing Drilling with Overbalanced	1.3
Coiled Tubing Drilling with Underbalanced	2
- A "Load Default" button.
- A large blue button at the bottom labeled "ENTER (To Drilling Costs)".

Fig. 75—Reference drilling cost estimation sub-module for a tight gas well in the Wilcox-Lobo trend.

Fig. 76 displays drilling cost results for each section of hole in U.S. dollars. Total drilling cost results will be discussed after presenting the Ranking Drilling Technologies sub-module in Fig. 77.

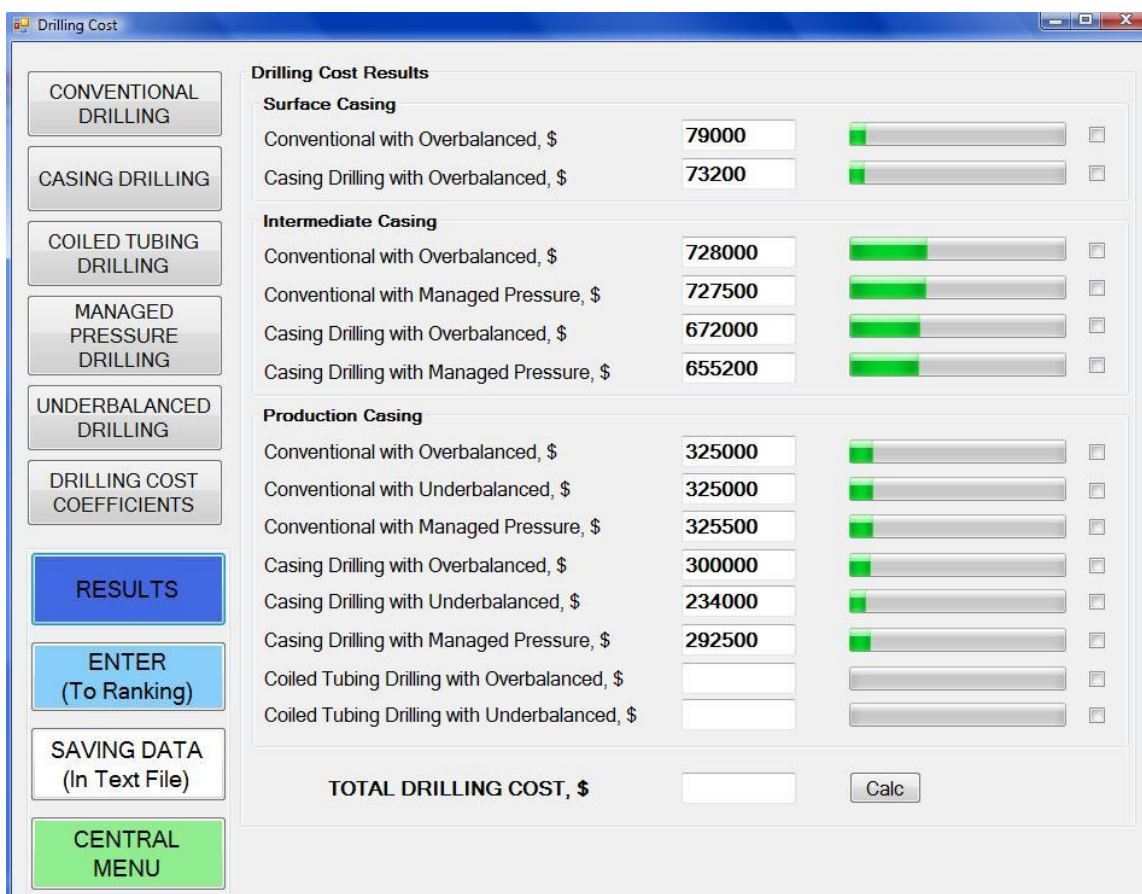

Fig. 76—Drilling cost estimation sub-module for a tight gas well in the Wilcox-Lobo trend.

As shown in the following Fig. 77, total drilling time from surface to total depth is estimated to be greater than 22 days using conventional drilling technology with overbalanced drilling method while casing drilling technology associated with overbalanced drilling method is estimated to save more than 5 days in total drilling time. The 5 day gap in total drilling time remains the same when comparing drilling methods. Indeed, conventional drilling technology using managed pressure drilling method total

drilling time is estimated to be greater than 17 days while casing drilling technology using the same drilling method is estimated to be less than 12 days. In addition, Fig. 77 shows that total drilling cost for conventional drilling technology associated with any drilling method is estimated to be around \$1,130,000 while casing drilling technology using any drilling method has an estimated total drilling cost that ranges between \$980,000 and \$1,076,000. Such cost savings when multiplied by the number of tight gas wells needed to efficiently produce a tight gas field are significant. Finally, Fig. 77 gives the user a ranking for each technology and method. In this example, casing drilling technology ranks 1st (associated with underbalanced drilling method), 2nd (associated with managed pressure drilling method) and 3rd (associated with overbalanced drilling method) while conventional drilling technology ranks 4th, 5th and 6th.

The current drilling best practice in South Texas for the Wilcox-Lobo trend is casing drilling technology using overbalanced method (Tessari et al. 2006). In addition, field results in South Texas in the Vicksburg tight sandstone reservoirs trend that lies deeper than the Wilcox-Lobo trend have shown that casing drilling technology associated with underbalanced drilling method worked even better than casing drilling technology using overbalanced drilling method (Gordon et al. 2004). Moreover, laboratory and pilot studies have shown that casing drilling technology associated with managed pressure drilling method would solve some of the casing drilling technology limitations such as high equivalent circulating density, absence of pore pressure monitoring, low rate of penetration in hard rock formations (Stone et al. 2006). Therefore, the ranking given by the drilling advisory system match the current drilling best practice by selecting the right technology (casing drilling) and methods.

Total Drilling Time (Surface To Total Depth)	
Conventional with Overbalanced, day	22.64
Conventional with Underbalanced, day	19.39
Conventional with Managed Pressure, day	17.78
Casing Drilling with Overbalanced, day	17.42
Casing Drilling with Underbalanced, day	15.02
Casing Drilling with Managed Pressure, day	11.75
Coiled Tubing Drilling with Overbalanced, day	
Coiled Tubing Drilling with Underbalanced, day	

Total Drilling Cost (Surface To Total Depth)	
Conventional with Overbalanced, \$	1132000
Conventional with Underbalanced, \$	1132000
Conventional with Managed Pressure, \$	1131500
Casing Drilling with Overbalanced, \$	1076000
Casing Drilling with Underbalanced, \$	979200
Casing Drilling with Managed Pressure, \$	1059200
Coiled Tubing Drilling with Overbalanced, \$	
Coiled Tubing Drilling with Underbalanced, \$	

Ranking	
1.	Casing Drilling Technology with Underbalanced Drilling Method
2.	Casing Drilling Technology with Managed Pressure Drilling Method
3.	Casing Drilling Technology with Overbalanced Drilling Method
4.	Conventional Drilling Technology with Managed Pressure Drilling Method
5.	Conventional Drilling Technology with Overbalanced Drilling Method
6.	Conventional Drilling Technology with Underbalanced Drilling Method
7.	
8.	

Fig. 77—Drilling technologies and methods ranking sub-module for a tight gas well in the Wilcox-Lobo trend.

4.2 Wyoming Tight Gas Reservoirs

4.2.1 Lance Formation in Jonah/Pinedale Anticline Fields Well Data

The Jonah and Pinedale Anticline fields are located in the Green River Basin, Wyoming. These fields are among the top five largest natural gas producers in the U.S. in 2008 (EIA 2008). They produced natural gas from four main tight gas reservoirs: Frontier, Mesaverde, Fort Union and Lance formations. In this example, we target the Lance Formation which holds over 46 Tcf of recoverable natural gas (Ultra Petroleum 2009). Tight gas reservoirs depth in the Jonah/Pinedale fields range from 9,000 ft to 14,000 ft. In addition, reservoir permeability is very low between 0.0006 md and 0.015

md. In addition, tight gas reservoirs may have pore pressure gradient between 0.45 psi/ft and 0.85 psi/ft. Reservoir temperatures range between 200°F and 300°F (Garcia et al. 2004).

4.2.2 Lance Formation Drilling Advisor Results

In the Well Data sub-module shown in Fig. 78, we loaded reservoir dataset (Garcia et al. 2004) and well construction dataset (Questar 2006) coming from the petroleum industry literature. The tight well has a directional S-shaped trajectory because of the environmental constraints in the Rocky Mountain Region in the U.S. and particularly in Wyoming. In addition, since the Lance formation is a tight gas sand reservoir and needs hydraulic fracture technology to produce the reservoir at economic flow rates, the trajectory had to intersect the tight gas reservoirs vertically because of the better results using well stimulation with vertical wells than with slanted wells. The directional well sets a 4.5 in production casing at 14,000 ft measured depth and 12,000 ft true vertical depth. Reservoir temperature is at about 8,000 psi while reservoir temperature is at 280°F.

The screenshot shows the 'WellData' software window with two main sections: 'Reservoir' and 'Well Trajectory'.

Reservoir Section:

- Reservoir Pressure, psi: 8000
- Reservoir Temperature, °F: 280
- Type of Sandstones: Lenticular
- Naturally Fractured Reservoir: Yes
- Type of Fractures?: Moderate Opened Fracture Network
- Reservoir Depleted?: No
- Permeability, md: 0.001
- kv/kh Ratio: < 0.1

Well Trajectory Section:

- Well Trajectory: Directional
- Measured Depth, ft: 14000
- True Vertical Depth, ft: 12000
- Horizontal Departure, ft: 1500
- Number of Targets: 4
- Production Casing or Tubing Size, in: 4.5
- Sidetrack Well?: No

Buttons at the bottom include: 'LOADING DATA (From Text File)', 'SAVING DATA (In Text File)', 'ENTER (To Drilling Parameters)', and 'CENTRAL MENU'.

Fig. 78—Well data sub-module for a tight gas well in the Lance formation.

Fig. 79 presents the well planning with a 9-7/8 inch surface casing set at 2,500 ft followed by a 7-5/8 inch intermediate casing set at 8,000 ft true vertical depth. As given in the Well Data sub-module, a 4.5 inch production casing is set at 14,000 ft (Questar 2006). For surface casing and production casing, no drilling problems are anticipated and therefore textboxes take “No” as input values. For the intermediate casing, drilling problems such as lost circulation zones, stuck pipe incidents and wellbore instability are expected. The rate of penetration decreases between surface casing (30 ft/hr) and production casing (15 ft/hr). In addition, the well has to be drilled with the lowest footprint impact at surface.

Drilling Parameters for Candidate Selection

General

Surface Limitations: Lowest Footprint Impact

Existing Wells in the Vicinity?: Yes

Surface Casing

Casing Setting Depth, ft: 2500 [Reset]

Drilled Length, ft: 2500 [Calc]

Casing Size, in: 9.875

Hard Rock Formations Expected: No

Estimated Rate of Penetration, ft/hr: 30

Anticipated Drilling Problems?: No

Lost Circulation Zones?: No

Stuck Pipe Incidents?: No

Wellbore Stability Issue?: No

Sloughing Shale?: No

Salt Zones?: No

[LOADING DATA (From Text File)] [SAVING DATA (In Text File)]

Intermediate Casing N°1

Casing Setting Depth, ft: 8000 [Reset]

Drilled Length, ft: 7000 [Calc]

Casing Size, in: 7.625

Hard Rock Formations Expected: No

Estimated Rate of Penetration, ft/hr: 20

Anticipated Drilling Problems?: Yes

Lost Circulation Zones?: Yes

Stuck Pipe Incidents?: Yes

Wellbore Stability Issue?: Yes

Sloughing Shale?: No

Salt Zones?: No

[LOADING DATA (From Text File)] [SAVING DATA (In Text File)]

Production Casing

Casing Setting Depth, ft: 12000 [Reset]

Drilled Length, ft: 4000 [Calc]

Casing Size, in: 4.5 [Casing Design]

Hard Rock Formations Expected: No

Estimated Rate of Penetration, ft/hr: 15

Anticipated Drilling Problems?: No

Lost Circulation Zones?: No

Stuck Pipe Incidents?: No

Wellbore Stability Issue?: No

Sloughing Shale?: No

Salt Zones?: No

Formation Damage Expected?: No

Kick, Blow-Out?: No

H2S?: No

CO2?: No

Brines?: No

[LOADING DATA (From Text File)] [SAVING DATA (In Text File)]

[ADD INTERMEDIATE CASING]

[ENTER (To Technology Selection)] [CENTRAL MENU]

Fig. 79—Drilling parameters sub-module for a tight gas well in the Lance formation.

In Fig. 80, surface equipment for each technology and method are available since the operation takes place in North America, in Wyoming. Therefore, all special components needed for casing drilling and coiled tubing drilling technologies and for underbalanced drilling and managed pressure drilling technologies are available to drill the well. The results on Fig. 80 show that conventional drilling technology associated with overbalanced drilling method is feasible to drill each section of hole. Besides, since drilling problems are anticipated in the intermediate section, casing drilling is also a feasible drilling technology along with managed pressure method to reduce drilling problems. However, coiled tubing drilling technology and underbalanced drilling method appear as not recommended drilling practices to drill this tight gas well.

Technology Available for Candidate Selection

Availability	Reset
Conventional Drilling Rig Available ? Yes ▾	<input type="button" value="Reset"/>
Built For Purpose Rig Available ? Yes ▾	
Casing Drilling Rig Available ? Yes ▾	
Hybrid Coiled Tubing Rig Available ? Yes ▾	

Special Equipment and Trained Crew Availability	
Casing Drilling Components Available ? Yes ▾	
Coiled Tubing Components Available ? Yes ▾	
Managed Pressure Drilling Components Available ? Yes ▾	
UnderBalanced Drilling Components Available ? Yes ▾	

<input type="button" value="LOADING DATA (From Text File)"/>	<input type="button" value="SAVING DATA (In Text File)"/>
<input type="button" value="SAVING RESULTS (In Text File)"/>	

Drilling Technology and Method Results	
Surface Casing	
Conventional with Overbalanced	<input type="text" value="Feasible"/>
Casing Drilling with Overbalanced	<input type="text" value="Not Recommended"/>
Intermediate Casing	
Conventional with Overbalanced	<input type="text" value="Feasible"/>
Conventional with Managed Pressure	<input type="text" value="Feasible"/>
Casing Drilling with Overbalanced	<input type="text" value="Feasible"/>
Casing Drilling with Managed Pressure	<input type="text" value="Feasible"/>
Production Casing	
Conventional with Overbalanced	<input type="text" value="Feasible"/>
Conventional with Underbalanced	<input type="text" value="Not Recommended"/>
Conventional with Managed Pressure	<input type="text" value="Not Recommended"/>
Casing Drilling with Overbalanced	<input type="text" value="Not Recommended"/>
Casing Drilling with Underbalanced	<input type="text" value="Not Recommended"/>
Casing Drilling with Managed Pressure	<input type="text" value="Not Recommended"/>
Coiled Tubing Drilling with Overbalanced	<input type="text" value="Not Recommended"/>
Coiled Tubing Drilling with Underbalanced	<input type="text" value="Not Recommended"/>

<input type="button" value="RESULTS"/>	<input type="button" value="ENTER (To Drilling Time)"/>	<input type="button" value="CENTRAL MENU"/>
--	---	---

Fig. 80—Technology feasibility sub-module for a tight gas well in the Lance formation.

By proceeding in a same manner than the previous example, total non-productive time are estimated to be equal to 18% of effective drilling time as shown in Fig. 81 and Fig. 82 loads default values discussed in Table 5.

Non Productive Time Estimation

Lost Circulation 0 0.5 1

Stuck Pipe 0 0.5 1

Kick 0 0.5 1

Wellbore Instability 0 0.5 1

Equipement Failure 0 0.5 1

Cement Squeeze 0 0.5 1

Weather Delay 0 0.5 1

Directional Control 0 0.5 1

Other 0 0.5 1

NPT, % 18

CALCULATION

ENTER
(To Drilling Time)

Fig. 81—Non-productive time estimation sub-module for a tight gas well in the Lance formation.

ROP

Drilling Technology and Methods	Normalized ROP to CwO
Conventional with Overbalanced	1
Conventional with Underbalanced	2
Conventional with Managed Pressure	1.5
Casing Drilling with Overbalanced	1.3
Casing Drilling with Underbalanced	2.5
Casing Drilling with Managed Pressure	2
Coiled Tubing Drilling with Overbalanced	1.5
Coiled Tubing Drilling with Underbalanced	3

ENTER
(To Drilling Time)

Load Default

Fig. 82—Rate of penetration estimation sub-module for a tight gas well in the Lance formation.

Fig. 83 presents drilling time estimation for each section of hole. Total drilling time results will be discussed after presenting the Ranking Drilling Technologies and Methods sub-module in Fig. 87.

The screenshot shows a software window titled "Drilling Time" with a sidebar on the left containing buttons for "NON PRODUCTIVE TIME", "DRILLING RATE OF PENETRATION", "RESULTS", "SAVING DATA (In Text File)", "ENTER (To Drilling Cost)", and "CENTRAL MENU". The main area displays "Drilling Time Results" for three casing sections: Surface Casing, Intermediate Casing, and Production Casing. Each section lists drilling methods with their respective times in days and progress bars. A "TOTAL DRILLING TIME TO TD, day" field and a "Calc" button are at the bottom.

Section	Method	Time (day)	Progress
Surface Casing	Conventional with Overbalanced, day	4.23	~25%
	Casing Drilling with Overbalanced, day		0%
Intermediate Casing	Conventional with Overbalanced, day	17.78	~75%
	Conventional with Managed Pressure, day	11.86	~50%
	Casing Drilling with Overbalanced, day	13.68	~60%
	Casing Drilling with Managed Pressure, day	8.89	~30%
Production Casing	Conventional with Overbalanced, day	13.55	~25%
	Conventional with Underbalanced, day		0%
	Conventional with Managed Pressure, day		0%
	Casing Drilling with Overbalanced, day		0%
	Casing Drilling with Underbalanced, day		0%
	Casing Drilling with Managed Pressure, day		0%
	Coiled Tubing Drilling with Overbalanced, day		0%
Coiled Tubing Drilling with Underbalanced, day		0%	
TOTAL DRILLING TIME TO TD, day			

Fig. 83—Drilling time estimation sub-module for a tight gas well in the Lance formation.

In Fig. 84, global daily cost for conventional drilling technology associated with overbalanced drilling is set at about 60,000 \$/day. This value is greater than the one used in South Texas because of the rig type often used to drill tight gas reservoirs in Colorado, Utah or Wyoming. Indeed, built-for purpose rigs are commonly used to access tight gas reservoirs by using pad drilling but are pricier than conventional rigs used in South Texas. Fig. 85 illustrates the case where the user does not know the prices associated with

drilling technologies and methods that have been found feasible in the Technology and Method Feasibility sub-module (casing drilling, underbalanced drilling and managed pressure drilling). Default values shown in Table 6 are loaded in the Reference Cost sub-module.

ConventionalDrillingComponents

Conventional Drilling Equipment

Conventional Drilling Rig Rate, \$/d

Built For Purpose Rig Rate, \$/d

Miscellaneous, \$/d

Global Cost, \$/d

Fig. 84—Conventional drilling technology cost estimation sub-module for a tight gas well in the Lance formation.

Reference_Costs

Drilling Technology and Methods	Normalize Cost to CwO
Conventional with Overbalanced	<input type="text" value="1"/>
Conventional with Underbalanced	<input type="text" value="2"/>
Conventional with Managed Pressure	<input type="text" value="1.5"/>
Casing Drilling with Overbalanced	<input type="text" value="1.2"/>
Casing Drilling with Underbalanced	<input type="text" value="1.8"/>
Casing Drilling with Managed Pressure	<input type="text" value="1.8"/>
Coiled Tubing Drilling with Overbalanced	<input type="text" value="1.3"/>
Coiled Tubing Drilling with Underbalanced	<input type="text" value="2"/>

Fig. 85—Reference drilling cost estimation sub-module for a tight gas well in the Lance formation.

Fig. 86 displays drilling cost results for each section of hole in U.S. dollars. Total drilling cost results will be discussed after presenting the Ranking Drilling Technologies sub-module in Fig. 87.

Drilling Cost Results

Section	Method	Cost (\$)	Progress	Checkbox
Surface Casing	Conventional with Overbalanced, \$	253800	~10%	<input type="checkbox"/>
	Casing Drilling with Overbalanced, \$		0%	<input type="checkbox"/>
Intermediate Casing	Conventional with Overbalanced, \$	1066800	~20%	<input type="checkbox"/>
	Conventional with Managed Pressure, \$	1067400	~15%	<input type="checkbox"/>
	Casing Drilling with Overbalanced, \$	984960	~10%	<input type="checkbox"/>
	Casing Drilling with Managed Pressure, \$	960120	~15%	<input type="checkbox"/>
Production Casing	Conventional with Overbalanced, \$	813000	~10%	<input type="checkbox"/>
	Conventional with Underbalanced, \$		0%	<input type="checkbox"/>
	Conventional with Managed Pressure, \$		0%	<input type="checkbox"/>
	Casing Drilling with Overbalanced, \$		0%	<input type="checkbox"/>
	Casing Drilling with Underbalanced, \$		0%	<input type="checkbox"/>
	Casing Drilling with Managed Pressure, \$		0%	<input type="checkbox"/>
	Coiled Tubing Drilling with Overbalanced, \$		0%	<input type="checkbox"/>
	Coiled Tubing Drilling with Underbalanced, \$		0%	<input type="checkbox"/>
TOTAL DRILLING COST, \$				<input type="button" value="Calc"/>

Navigation Sidebar:

- CONVENTIONAL DRILLING
- CASING DRILLING
- COILED TUBING DRILLING
- MANAGED PRESSURE DRILLING
- UNDERBALANCED DRILLING
- DRILLING COST COEFFICIENTS
- RESULTS
- ENTER (To Ranking)
- SAVING DATA (In Text File)
- CENTRAL MENU

Fig. 86—Drilling cost estimation sub-module for a tight gas well in the Lance formation.

Fig. 87 shows that total drilling time from surface to total depth is estimated to be greater than 35 days using conventional drilling technology with overbalanced drilling method while casing drilling technology associated with overbalanced drilling method is estimated to save over 4 days in total drilling time. Conventional drilling technology using managed pressure drilling method total drilling time is estimated to be greater than 29 days while casing drilling technology using the same drilling method is estimated to

be more than 26 days. In addition, Fig. 87 shows that total drilling cost for conventional drilling technology associated with overbalanced drilling method or managed pressure drilling method is estimated to be around \$2,134,000 while casing drilling technology using the same drilling methods has an estimated total drilling cost of about \$2,040,000. Again, such cost savings when multiplied by the number of tight gas wells needed to efficiently produce the Lance formation are significant. Finally, Fig. 87 gives a ranking for each technology and method. In this example, casing drilling technology ranks 1st (associated with managed pressure drilling method), 2nd (associated with overbalanced drilling method) and while conventional drilling technology ranks 3rd, 4th.

Currently, there is no clearly defined drilling best practice in the Rocky Mountain region in the U.S. Even though to access tight gas reservoirs such as the Lance formation operators have routinely used conventional drilling technology using overbalanced method (Questar 2006), some operators have tried casing drilling technology, managed pressure drilling method or underbalanced drilling method (Ultra Petroleum 2009). Therefore, the ranking given by the Drilling advisory matches the current trend in drilling practice used in the Rockies.

The screenshot shows a software window titled "RankingSelection" with the following data and controls:

Total Drilling Time (Surface To Total Depth)	
Conventional with Overbalanced, day	35.56
Conventional with Underbalanced, day	
Conventional with Managed Pressure, day	29.64
Casing Drilling with Overbalanced, day	31.46
Casing Drilling with Underbalanced, day	
Casing Drilling with Managed Pressure, day	26.67
Coiled Tubing Drilling with Overbalanced, day	
Coiled Tubing Drilling with Underbalanced, day	

TOTAL DRILLING TIME

Total Drilling Cost (Surface To Total Depth)	
Conventional with Overbalanced, \$	2133600
Conventional with Underbalanced, \$	
Conventional with Managed Pressure, \$	2134200
Casing Drilling with Overbalanced, \$	2051760
Casing Drilling with Underbalanced, \$	
Casing Drilling with Managed Pressure, \$	2026920
Coiled Tubing Drilling with Overbalanced, \$	
Coiled Tubing Drilling with Underbalanced, \$	

TOTAL DRILLING COST

Ranking

1. Casing Drilling Technology with Managed Pressure Drilling Method
2. Casing Drilling Technology with Overbalanced Drilling Method
3. Conventional Drilling Technology with Overbalanced Drilling Method
4. Conventional Drilling Technology with Managed Pressure Drilling Method
- 5.
- 6.
- 7.
- 8.

Buttons: RESULTS, CENTRAL MENU

Fig. 87—Drilling technologies and methods ranking sub-module for a tight gas well in the Lance formation.

4.3 North Texas - Oklahoma Tight Gas Reservoir

4.3.1 Cleveland Sands Well Data

The Cleveland sandstones formation is located across North Texas and Oklahoma Panhandle region. Tight gas reservoir depth for the Cleveland sands range from 6,500 ft to 8,200 ft. Also, reservoir permeability is very low between 0.003 md and 0.015 md. Current tight gas reservoirs pore pressure ranges between 1,200 psi and 2,000 psi. Reservoir temperatures range between 150°F and 180°F (BP 2005).

4.3.2 Cleveland Sands Drilling Advisor Results

In the Well Data sub-module shown in Fig. 88, we loaded reservoir dataset and well construction dataset (BP 2005). The tight gas well has a horizontal trajectory. The horizontal well sets a 2-7/8 inch production casing at 9,250 ft measured depth and 7,300 ft true vertical depth. Reservoir pressure is at about 2,000 psi while reservoir temperature is at 160°F.

The screenshot displays the 'WellData' software interface, which is divided into two main sections: 'Reservoir' and 'Well Trajectory'.

Reservoir Section:

- Reservoir Pressure, psi: 2000 (with a 'Reset' button)
- Reservoir Temperature, °F: 160
- Type of Sandstones: Continuous Single Layer (dropdown menu)
- Naturally Fractured Reservoir: Yes (dropdown menu)
- Type of Fractures?: Moderate Opened Fracture Network (dropdown menu)
- Reservoir Depleted?: Yes (dropdown menu)
- Permeability, md: 0.015
- kv/kh Ratio: > 0.1 (dropdown menu)

Well Trajectory Section:

- Well Trajectory: Horizontal (dropdown menu, with 'Enter' button)
- Measured Depth, ft: 9250 (with a 'Reset' button)
- True Vertical Depth, ft: 7300
- Horizontal Departure, ft: 1500
- Number of Targets: 1
- Production Casing or Tubing Size, in: 2.875
- Sidetrack Well?: No (dropdown menu)

At the bottom of the interface, there are three buttons: 'LOADING DATA (From Text File)', 'SAVING DATA (In Text File)', and 'ENTER (To Drilling Parameters)'. A 'CENTRAL MENU' button is also visible at the bottom right.

Fig. 88—Well data sub-module for a tight gas well in the Cleveland formation.

Fig. 89 presents the well planning with a 8-5/8 inch surface casing set at 1,800 ft followed by a 4.5 inch intermediate casing set at 7,500 ft measured depth. As given in the Well Data sub-module, a 2-7/8 inch production casing is set at 9,260 ft (BP 2005). For surface casing, no drilling problems are anticipated and therefore textboxes take “No” as input values. For intermediate and production casing, drilling problems such as lost

circulation zones, stuck pipe incidents, wellbore instability and sloughing shale are expected. The rate of penetration decreases between surface casing (30 ft/hr) and production casing (10 ft/hr).

Fig. 89—Drilling parameters sub-module for a tight gas well in the Cleveland formation.

In Fig. 90, surface equipment for each technology and method are available since the operation takes place in Texas. All special components needed for casing drilling and coiled tubing drilling technologies and for underbalanced drilling and managed pressure drilling technologies are available to drill the well. The results on Fig. 90 show that conventional drilling technology associated with overbalanced drilling method is feasible to drill each section of hole. Moreover, since drilling problems are anticipated in the intermediate section, casing drilling is also a feasible drilling technology along with managed pressure method to reduce drilling problems. Finally, coiled tubing drilling

technology associated with both overbalanced and underbalanced drilling method is a feasible drilling practice to drill this tight gas well.

Category	Method	Feasibility
Surface Casing	Conventional with Overbalanced	Feasible
	Casing Drilling with Overbalanced	Not Recommended
Intermediate Casing	Conventional with Overbalanced	Feasible
	Conventional with Managed Pressure	Feasible
	Casing Drilling with Overbalanced	Feasible
	Casing Drilling with Managed Pressure	Feasible
Production Casing	Conventional with Overbalanced	Feasible
	Conventional with Underbalanced	Not Recommended
	Conventional with Managed Pressure	Feasible
	Casing Drilling with Overbalanced	Not Recommended
	Casing Drilling with Underbalanced	Not Recommended
	Casing Drilling with Managed Pressure	Not Recommended
	Coiled Tubing Drilling with Overbalanced	Feasible
	Coiled Tubing Drilling with Underbalanced	Feasible

Fig. 90—Technology feasibility sub-module for a tight gas well in the Cleveland formation.

By proceeding in a same manner than the previous examples, total non-productive time is estimated to be equal to 20% of effective drilling time as shown in Fig. 91 and Fig. 92 loads default values discussed in Table 5.

Non Productive Time Estimation

Lost Circulation 0 0.5 1

Stuck Pipe 0 0.5 1

Kick 0 0.5 1

Wellbore Instability 0 0.5 1

Equipement Failure 0 0.5 1

Cement Squeeze 0 0.5 1

Weather Delay 0 0.5 1

Directional Control 0 0.5 1

Other 0 0.5 1

NPT, % 20

CALCULATION

ENTER
(To Drilling Time)

Fig. 91—Non-productive time estimation sub-module for a tight gas well in the Cleveland formation.

Drilling Technology and Methods	Normalized ROP to CwO
Conventional with Overbalanced	1
Conventional with Underbalanced	2
Conventional with Managed Pressure	1.5
Casing Drilling with Overbalanced	1.3
Casing Drilling with Underbalanced	2.5
Casing Drilling with Managed Pressure	2
Coiled Tubing Drilling with Overbalanced	1.5
Coiled Tubing Drilling with Underbalanced	3

ENTER
(To Drilling Time)

Load Default

Fig. 92—Rate of penetration estimation sub-module for a tight gas well in the Cleveland formation.

The following Fig. 93 presents drilling time estimation, in days, for each drilling technology and drilling method for each section of hole.

The screenshot shows a software window titled 'Drilling Time'. On the left side, there are several buttons: 'NON PRODUCTIVE TIME', 'DRILLING RATE OF PENETRATION', 'RESULTS', 'SAVING DATA (In Text File)', 'ENTER (To Drilling Cost)', and 'CENTRAL MENU'. The main area is titled 'Drilling Time Results' and is divided into three sections: 'Surface Casing', 'Intermediate Casing', and 'Production Casing'. Each section lists drilling methods with their respective time estimates in days and progress bars. At the bottom, there is a 'TOTAL DRILLING TIME TO TD, day' field with a 'Calc' button.

Section	Drilling Method	Time (days)	Progress Bar	Checkbox
Surface Casing	Conventional with Overbalanced, day	3.12	~10% green	<input type="checkbox"/>
	Casing Drilling with Overbalanced, day		0% green	<input type="checkbox"/>
Intermediate Casing	Conventional with Overbalanced, day	14.84	~50% green	<input type="checkbox"/>
	Conventional with Managed Pressure, day	9.9	~30% green	<input type="checkbox"/>
	Casing Drilling with Overbalanced, day	11.42	~40% green	<input type="checkbox"/>
	Casing Drilling with Managed Pressure, day	7.42	~20% green	<input type="checkbox"/>
Production Casing	Conventional with Overbalanced, day	9.11	~10% green	<input type="checkbox"/>
	Conventional with Underbalanced, day		0% green	<input type="checkbox"/>
	Conventional with Managed Pressure, day	6.08	~10% green	<input type="checkbox"/>
	Casing Drilling with Overbalanced, day		0% green	<input type="checkbox"/>
	Casing Drilling with Underbalanced, day		0% green	<input type="checkbox"/>
	Casing Drilling with Managed Pressure, day		0% green	<input type="checkbox"/>
	Coiled Tubing Drilling with Overbalanced, day	6.08	~10% green	<input type="checkbox"/>
	Coiled Tubing Drilling with Underbalanced, day	3.04	~5% green	<input type="checkbox"/>
TOTAL DRILLING TIME TO TD, day				<input type="button" value="Calc"/>

Fig. 93—Drilling time estimation sub-module for a tight gas well in the Cleveland formation.

In Fig. 94, global daily cost for conventional drilling technology associated with overbalanced drilling is set at about 50,000 \$/day. Fig. 95 illustrates the case where the user does not know the prices associated with drilling technologies and methods that have been found feasible in the Technology and Method Feasibility sub-module (casing drilling, underbalanced drilling and managed pressure drilling). Default values shown in Table 6 are loaded in the Reference Cost sub-module.

Fig. 94—Conventional drilling technology cost estimation sub-module for a tight gas well in the Cleveland formation.

Drilling Technology and Methods	Normalize Cost to CwO
Conventional with Overbalanced	1
Conventional with Underbalanced	2
Conventional with Managed Pressure	1.5
Casing Drilling with Overbalanced	1.2
Casing Drilling with Underbalanced	1.8
Casing Drilling with Managed Pressure	1.8
Coiled Tubing Drilling with Overbalanced	1.3
Coiled Tubing Drilling with Underbalanced	2

Fig. 95—Reference drilling cost estimation sub-module for a tight gas well in the Cleveland formation.

Fig. 96 displays drilling cost results for each section of hole in U.S. dollars. Total drilling cost results will be discussed after presenting the Ranking Drilling Technologies and Methods sub-module in Fig. 97.

Drilling Cost Results

Surface Casing		
Conventional with Overbalanced, \$	156000	<input type="checkbox"/>
Casing Drilling with Overbalanced, \$		<input type="checkbox"/>
Intermediate Casing		
Conventional with Overbalanced, \$	742000	<input type="checkbox"/>
Conventional with Managed Pressure, \$	742500	<input type="checkbox"/>
Casing Drilling with Overbalanced, \$	685200	<input type="checkbox"/>
Casing Drilling with Managed Pressure, \$	667800	<input type="checkbox"/>
Production Casing		
Conventional with Overbalanced, \$	455500	<input type="checkbox"/>
Conventional with Underbalanced, \$		<input type="checkbox"/>
Conventional with Managed Pressure, \$	456000	<input type="checkbox"/>
Casing Drilling with Overbalanced, \$		<input type="checkbox"/>
Casing Drilling with Underbalanced, \$		<input type="checkbox"/>
Casing Drilling with Managed Pressure, \$		<input type="checkbox"/>
Coiled Tubing Drilling with Overbalanced, \$	395200	<input type="checkbox"/>
Coiled Tubing Drilling with Underbalanced, \$	304000	<input type="checkbox"/>
TOTAL DRILLING COST, \$		<input type="button" value="Calc"/>

Navigation sidebar (from top to bottom):

- CONVENTIONAL DRILLING
- CASING DRILLING
- COILED TUBING DRILLING
- MANAGED PRESSURE DRILLING
- UNDERBALANCED DRILLING
- DRILLING COST COEFFICIENTS
- RESULTS
- ENTER (To Ranking)
- SAVING DATA (In Text File)
- CENTRAL MENU

Fig. 96—Drilling cost estimation sub-module for a tight gas well in the Cleveland formation.

As shown in the following Fig. 97, total drilling time from surface to total depth is estimated to be greater than 27 days using conventional drilling technology with overbalanced drilling method while casing drilling technology associated with overbalanced drilling method is estimated to save over 3 days in total drilling time. Conventional drilling technology using managed pressure drilling method total drilling time is estimated to be greater than 22 days while casing drilling technology using the same drilling method is estimated to be more than 16 days. Coiled tubing drilling technology total drilling time is estimated to be around 24 days when associated with overbalanced drilling method and equal to 21 days when associated with underbalanced

drilling method. In addition, Fig. 97 shows that total drilling cost for conventional drilling technology associated with overbalanced drilling method or managed pressure drilling method is estimated to be around \$1,354,000 while casing drilling technology using the same drilling methods has an estimated total drilling cost of about \$1,290,000. Also, coiled tubing drilling technology total drilling cost is estimated to be about \$1,293,000 when used with overbalanced drilling method and is equal to \$1,200,000 when associated with underbalanced drilling method. Cost savings are significant between conventional drilling technology and coiled tubing drilling technology. Finally, Fig. 97 gives a ranking for each technology and method. In this example, coiled tubing drilling technology ranks 1st and 3rd (associated with underbalanced drilling method and overbalanced drilling method, respectively), casing drilling technology ranks 2nd and 4th (associated with managed pressure drilling method and overbalanced drilling method, respectively) and conventional drilling technology ranks 5rd, 6th.

The current drilling best practices in the Cleveland formation is to use coiled tubing drilling technology using both overbalanced drilling and underbalanced drilling methods (BP 2005; Baihly et al. 2007). Therefore, the ranking given by the Drilling advisory matches the current drilling practice used in the Cleveland formation trend.

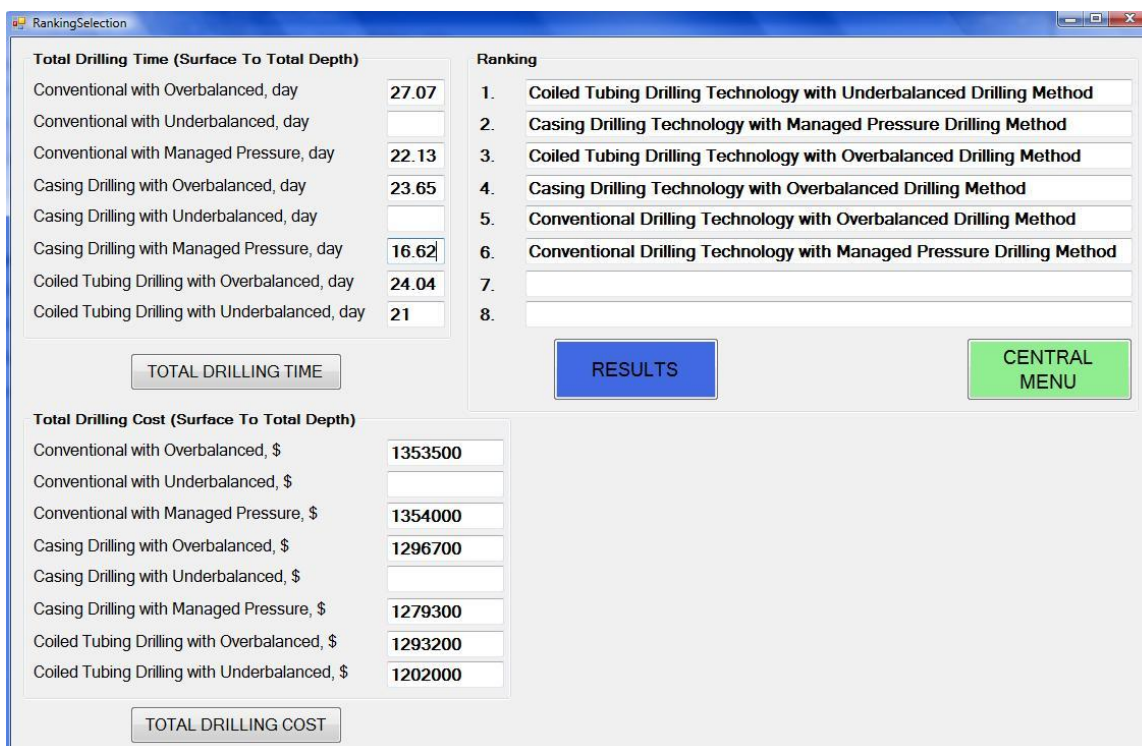

Fig. 97—Drilling technologies and methods ranking sub-module for a tight gas well in the Cleveland formation.

4.4 Discussion

We have run and described three different cases comparing the drilling advisory system and current industry drilling best practices using examples published in the petroleum industry literature. We chose, on purpose, different regions having different drilling best practices : vertical (South Texas), directional (Wyoming), horizontal (North Texas) wellbore trajectories; conventional drilling (Wyoming), casing drilling (South Texas, Wyoming), coiled tubing drilling (North Texas) technologies; overbalanced, underbalanced (North Texas, South Texas), managed pressure drilling methods (South Texas, Wyoming). As shown in table 7 and 8, for each case, the results either match the industry current practices or anticipate on what could become a new drilling best practice to drill tight gas reservoirs.

TABLE 7—Summary: reservoir and drilling parameters for three field examples

Country/State/Trend	Depth (ft)	Reservoir Pressure (psi)	Reservoir Temperature (°F)	Type of Sandstones	Permeability (md)	Porosity (%)
USA/South Texas/Wilcox-Lobo (data from SPE)	5,000 – 12,000	4,000 – 11,000	175 - 325	Continuous Multiple Layers	0.0003 – 0.5	12 - 25
USA/Wyoming/Lance (data from SPE)	9,000 – 14,000	4,000 – 12,000	200 - 300	Lenticular	0.0006 – 0.015	8 - 12
USA/North Texas/Cleveland (data from SPE and BP)	6,500 – 8,200	1,200 – 2,000	150 - 180	Continuous Single Layer	0.003 – 0.015	8 - 14

TABLE 8—Summary: comparison field results and drilling advisory results for three field examples			
Country/Trend	Drilling Problems	Industry Current Best Practices	Drilling Advisory Results
USA/South Texas/Wilcox-Lobo	None	Conventional Drilling Technology with Overbalanced Drilling Method	Conventional Drilling Technology with Overbalanced Drilling Method
	Important Lost Circulation and Stuck Pipe Incidents	1. Casing Drilling Technology with Overbalanced Drilling Method 2. Casing Drilling Technology with Underbalanced Drilling Method	1. Casing Drilling Technology with Underbalanced Drilling Method 2. Casing Drilling Technology with Managed Pressure Drilling Method
USA/Wyoming/Lance	None	Conventional Drilling Technology with Overbalanced Drilling Method	Conventional Drilling Technology with Overbalanced Drilling Method
	Lost Circulation, Stuck Pipe Incidents and Wellbore Stability	1. Conventional Drilling Technology with Overbalanced Drilling Method 2. Casing Drilling/Underbalanced Drilling/Managed Pressure Drilling	1. Casing Drilling Technology with Managed Pressure Drilling Method 2. Casing Drilling Technology with Overbalanced Drilling Method
USA/North Texas/Cleveland	None	1. Coiled Tubing Drilling Technology with Overbalanced Drilling Method 2. Coiled Tubing Drilling Technology with Underbalanced Drilling Method	1. Coiled Tubing Drilling Technology with Underbalanced Drilling Method 2. Casing Drilling Technology with Managed Pressure Drilling Method
	Stuck Pipe Incidents and Wellbore Stability		

5 CONCLUSION

The results of the research presented in this thesis have led to the following conclusions:

1. A drilling advisory system can be designed and programmed for a Windows O.S. environment in order to capture the industry best drilling practices from tight gas reservoirs.
2. The advisory system has been divided in several sub-modules to guide the user through the multiple steps to make decision selecting drilling technologies and methods to drill tight gas reservoirs. Each of the sub-module is dealing with a specific topic (well data, drilling parameters, drilling time, drilling cost, ranking). Each dataset can be either loaded or saved in a text-file for analysis or post-processing using other software (Microsoft Excel).
3. Designed with a user-friendly interface, the advisory system is a very good tool to help selecting efficiently and successfully drilling technologies and drilling methods for tight gas reservoirs.
4. The drilling advisory system outputs more than one feasible solution for a given tight gas well or field.

5. The logic behind the advisory system, mainly based on decision charts developed by collecting relevant data from the petroleum engineering literature and discussing with industry experts in drilling, is a good approach to mimic expert decision-making.

6. This thesis has illustrated several examples that all happen to match the current industry drilling best practices or to anticipate on upcoming drilling practices in the studied area. These simulations showed that the drilling advisory system for selecting drilling technologies and methods could deliver similar recommendations in comparison with a team of experienced drilling experts.

7. Drilling time, drilling cost estimation and ranking technologies and methods sub-modules provide the user with an extended decision making tool when several solutions are feasible.

8. The drilling advisory system has been designed and programmed in a way that its integration within the Unconventional Gas Resources Advisor will be easy.

9. The advisory program can be further upgraded with other drilling sub-modules or new drilling technologies when they are mature on the market.

REFERENCES

- Aamodt, A., Plaza, E. 1994. Case-Based Reasoning: Foundational Issues, Methodological Variations, and System Approaches. *European Journal of Artificial Intelligence*, 7 (1): 39-59.
- Aguilera, R., Artindale, J. S., Cordell, G. M., Ng, M. C., Nicholl, G. W., and Runions, G. A. 1991. *Horizontal Wells – Formation Evaluation, Drilling, and Production*. Houston: Gulf Publishing Co.
- Air Drilling Associates, Inc. 2008. www.airdrilling.com/applications/underbalanced-drilling.php. Downloaded on 10/01/2008.
- Amos, J. F. 2003. Environmental Aspects of Modern Onshore Oil and Gas Development. Subcommittee on Energy and Mineral Resources, September 17. www.skytruth.org/pdffiles/Amos%20testimony%2017sep03.pdf. Downloaded on 02/23/2008.
- Arnone, M. A., Qutob, H. H., Chopty, J. R., Barakat, N., Schoch, F., Ben Amor, B., and Ferhat, A. 2007. Underbalanced Coiled Tubing Drilling Practices in Horizontal Short Radius Re-Entry Well Applied in Hassi Messaoud – Algeria, Case Study. Paper SPE 106870 presented at the Asia Pacific Oil and Gas Conference and Exhibition, Jakarta, Indonesia, 31 October.
- Baihly, J., Grant D., Fan, L., and Bodwadkar, S. 2007. Horizontal Wells in Tight Gas Sands – A Methodology for Risk Management To Maximize Success. Paper SPE

- 110067 presented at the SPE Annual Conference and Exhibition, Anaheim, California, 11-14 November.
- Bennion, D. B., Thomas, F. B., Bietz, R. F., and Bennion, D. W. 1996. Underbalanced Drilling, Praises and Perils. Paper SPE 35242 presented at the SPE Permian Basin Oil&Gas Recovery Conference, Midland, Texas, 27-29 March.
- Blade Energy Partners. 2008. A Course in Advanced Underbalanced Well Design, Version 1.3, Chapter 2, Dallas, Texas.
- Bogatchev K.: 2007. Developing a Tight Gas Sand Advisor for Completion and Stimulation in Tight Gas Reservoir Worldwide. MS thesis, Texas A&M University, College Station, Texas.
- Bourgoyne, A. T., Chenevert, M.E., and Millheim, K.K. 1986. *Applied Drilling Engineering*. Textbook Series, SPE, Richardson, Texas 2.
- BP. Cleveland CTD Pilot Review.
microtech.thepttc.org/current_industry_effort/bp_08162006.pdf. Downloaded on 02/04/09
- BP. Unlocking Tight Gas. *Frontiers* online magazine, August 2007.
www.bp.com/sectiongenericarticle.do?categoryId=9019302&contentId=7035200.
Downloaded on 01/30/08.
- BP. 2008. Pros and Cons of Underbalanced Drilling for Tight Gas. Research Partnership to Secure Energy for America Conference, Anchorage, Alaska, 7 April.
- Brantly, J. E. 2007. *History of Oil Well Drilling*. Houston, Texas: Gulf Publishing Company.

- Brillon, C. L., Shafer, R. S., and Bello, A. A. 2007. Pushing the Envelope with Coil Tubing Drilling. Paper AADE-07-NTCE-31 presented at the AADE National Technical Conference, Houston, Texas, 10-12 April.
- Brillon, C. L., Shafer, R. S., and Segal, S. 2008. Coiled Tubing Drilling Reaches New Depths Technology Solutions Help Optimize Drilling Performance in Tight Margin Plays. *World Oil*, **229**: 109-114.
- Chew, K. 2005. World Oil and Gas Resource and Production Outlook. Paper presented at the Organization of Arab Petroleum Exporting Countries-French Petroleum Institute Joint Seminar, Paris, France, 28 June.
- Coleman, J. C. Jr. 2005. Tight-gas Sandstone Reservoirs: 25 Years of Searching for “The Answer”. AAPG Hedberg Series, Vail Hedberg Conference. **3**: 221-250.
- Dennison, D. Drilling of a Natural Gas Well and Natural Gas Production in the Piceance Basin, Garfield County Oil & Gas Liaison, Colorado.
www.garfield-county.com/Modules/ShowDocument.aspx?documentid=2185.
Downloaded on 05/22/08.
- Dunn, M. D., Crane, L. R., and Thomas, R. L. 2005. North Slope Drilling Practices – Ever Adapting to New Challenges. Paper AADE-05-NTCE-07 presented at the AADE National Technical Conference and Exhibition, Houston, Texas, 5-7 April.
- Economides, M. J., Watters, L. T., and Dunn-Norman, S. 1998. *Petroleum Well Construction*, Hoboken, New Jersey: John Wiley and Sons.
- Energy Information Administration. Office of Integrated Analysis and Forecasting, U.S. Department of Energy. International Energy Outlook.
www.eia.doe.gov/oiaf/ieo/index.html. Downloaded on 09/11/08.

- Energy Information Administration. 2008. International Energy Outlook. Chap 3, p37-46, Washington, DC.
- EnvertureGT. Solid Expandable Tubular Technology: The Facts. www.enverturegt.com. Downloaded on 10/05/08.
- Fenoul, R. G. 1989. Enhanced Drilling Softwares and Integrated Advisor Expert Systems. Paper SPE 19133 presented at the Petroleum Computer Conference, San Antonio, Texas, 26-28 June.
- Federal Energy Regulatory Commission. 1978. Definition of Tight Gas, Chapter 270.305, Washington, DC.
- Fontenot, K., Highnote, J., Warren, T., and Houtchens, B. 2003. Casing Drilling Activity Expands in South Texas. Paper SPE/IADC 79862 presented at the SPE/IADC Drilling Conference, Amsterdam, The Netherlands, 19-21 February.
- Fontenot, K., R., Lesso, B., Strickler, R. D., and Warren, T. M. 2005. Using Casing to Drill Directional Wells. *Oilfield Review*, **17**: 44-61.
- Foremost. Coiled Tubing Rigs from Concept to Reality. www.foremost.ca. Downloaded 05/22/08.
- Frajia, J., Ohmer, H., Pulick, T., Jardon, M., Kaja, M., Paez, R., Sotomayor, G. P. G., and Umudjoro, K. 2002. Aspects of Multilateral Well Construction. *Oilfield Review*, **13**: 52-69.
- Gantt, L. L., Oba, E. M., Leising, L., Stagg, T., Stanley, M., Walker, E., and Walker, R. 1998. Coiled Tubing Drilling on the Alaskan North Slope. *Oilfield Review*, **10**: 20-35.

- Garcia, D. G., and Moreyra, J. D. 2007. Underbalanced Drilling Technology for the Exploration of Tight Sands in the Neuquen Basin: An Evaluation of Results from 11 Wells. Paper IADC/SPE 108335 presented at the IADC/SPE Managed Pressure Drilling and Underbalanced Operations Conference and Exhibition, Galveston, Texas, 28-29 March.
- Garcia, J., Huckabee, P., Hailey, B., and Foreman, J. 2004. Integrating Completion and Drilling Knowledge Reduces Trouble Time and Costs on the Pinedale Anticline. Paper SPE 90467 presented at the SPE Annual Technical Conference and Exhibition, Houston, Texas, 26-29 September.
- Garrouch, A. A., Lababidi, H. M.S., and Ebrahim A. 2004. A Fuzzy Expert System for the Completion of Multilateral Wells. Paper SPE 87963 presented at the IADC/SPE Asia Pacific Drilling Technology Conference and Exhibition, Kuala Lumpur, Malaysia, 13-15 September.
- Giarratano, J.C. and Riley, G.D. 2005. *Expert Systems Principles and Programming*, 4th ed., Boston, Massachusetts: Thompson Course Technology.
- Godec, M., Van Leeuwen, T., and Kuuskraa, V. 2007. Economics of Unconventional Gas. *OGJ*, **5**: 1-14.
- Gordon, D., and Billa, R. 2004. Underbalanced Casing Drilling Enhanced Well Economics in South Texas Vicksburg. *The American Oil and Gas Reporter*, **47**: 1-7.
- Grantprideco. Drilling with Casing, Tubular Technology and Services. www.grantprideco.com/dwc. Downloaded on 02/28/08.

- Hayes-Roth, F., Waterman, D. A., and Lenat, D. B. 1983. *Building Expert System*. Boston, Massachusetts: Addison Wesley Publishing.
- Helms, L. 2008. Horizontal Drilling. *North Dakota Department of Mineral Resources Newsletter*, **35**: 1-3.
- Heslop, D. O., Schuler, S., and Calvo, J. J., Copeland, D. L. 1998. Multidisciplinary Risk Assessment for Tight Gas Development. Paper SPE 39935 presented at the SPE Rocky Mountain Regional/Low Permeability Reservoir Symposium, Denver Colorado, 5-8 April.
- Hibbeler, J., Seymour, R., and Rae, P. 2004. Faster, Deeper, Cheaper – Slim hole Well Construction in the Gulf of Thailand. Paper SPE 90999 presented at the SPE Annual Technical Conference and Exhibition, Houston, Texas, 26-29 September.
- Hill, D., Neme, E., Ehlig-Economides, C., and Mollinedo, M. 1996. Reentry Drilling Gives New Life to Aging Fields. *Oilfield Review*, **8**: 4-57.
- Holditch, S.A. 2006. Tight Gas Sands. *Journal of Petroleum Technology* p86-93 and SPE Distinguished Author Series paper 103356, June.
- Holditch, S.A. and Bogatchev, K.Y. 2008. Developing Tight Gas Sand Advisor for Completion and Stimulation in Tight Gas Sand Reservoir Worldwide. Paper SPE 114195 presented at the CIPC/SPE Gas Technology Symposium Joint Conference, Calgary, Canada, 16-19 June.
- Hyodo, M., Takasugi, S., and Muramatsu, S. 1992. Development of Expert System for Lost Circulation Problems. Paper presented at the 17th Workshop on Geothermal Reservoir Engineering, Stanford, California, 29-31 January.

- ICOTA (Intervention and Coiled Tubing Association). 2005. An Introduction to Coiled Tubing: History, Applications and Benefits, Montgomery, Texas, p1-32.
- Johnson, M., Brand, P., French, S., Sarber, G., Hildreth, D., Harris, B., Rangel, P., Cassee, U., and Clark, J. 2007. Coiled-Tubing Underbalanced Drilling Applications in the Lisburne Field, Alaska. Paper IADC/SPE 108337 presented at the IADC/SPE Managed Pressure Drilling and Underbalanced Operations Conference and Exhibition, Galveston, Texas, 28-29 March.
- Joshi, S. D. 2003. Cost/Benefits of Horizontal Wells. Paper SPE 83621 presented at the SPE Western Regional/AAPG Pacific Section Joint Meeting, Long Beach, California, 19-24 May.
- Justus, J. R. Shell's Development of the Pinedale Anticline. Achieving Operational Excellence from Technology and Innovation, Shell US Onshore Assets, September 2005, p1-18.
- Kahn, G., and Mc Dermott, J. 1984. The MUD System presented at the 1st Conference on Artificial Intelligence Applications, IEEE Computer Society, Denver, Colorado, December.
- Kneller, S. R., Zinke, S. G., Vigil, G. R., Benko, R., and Throne, S. T. 2005. Ultra Petroleum Corp. Pinedale Field Increased Drilling Density Application, Pinedale, Wyoming Oil & Gas Conservation Commission, 10 May.
- Kolstad, E. S., Steinke, L. D., Brady, L. S., and Marchand, S. P. 2007. Application of Purpose-Built Rig Technology Results in Step Change of Drilling Time, Cost, and Opportunities. Paper SPE/IADC 105644 presented at the Drilling Conference, Amsterdam, The Netherlands, 20-22 February.

- Kozicz, J. 2006. Managed Pressure Drilling-Recent Experience, Potential Efficiency Gains, and Future Opportunities. Paper IADC/SPE 103753 Presented at the Asia Pacific Drilling Technology Conference and Exhibition, Bangkok, Thailand, 13-15 November.
- Kreckel, K. 2008. Directional Drilling: The Key to the Smart Growth of Oil and Gas Development in the Rocky Mountain Region. wilderness.org/content/directional-drilling-rocky-mountain-region. Downloaded on 02/23/08.
- Kuuskræa, V. 2007. A Decade of Progress in Unconventional Gas. *OGJ*, Unconventional Gas Article#1, 24 July.
- Kuuskræa, V.A. 2006. Is the Unconventional Gas Resource Base Sufficiently Large and High Quality? Paper presented at the EIA Energy Outlook and Modeling Conference, Washington DC, 27 March.
- Long, R. 2005. Slimhole Drilling Session. Presentation made during the SPE/ATCE Conference, Dallas, Texas, 10 October.
- Malloy, K. P., Stone, C. R., Medley, G. H. Jr, Hannegan, D., Coker, O., Reitsma, D., Santos, H., Kinder, J., Eck-Olsen, J., MacCaskill, J., May, J. Smith, K., and Sonneman, P. 2009. Managed Pressure Drilling: What It Is and What It Is Not. Paper SPE 122281 presented at the IADC/SPE Managed Pressure Drilling and Underbalanced Operations Conference and Exhibition, San Antonio, Texas, 12-13 February.
- Martin, D., and Jacobsen, J. 2002. New Hard Rock Roller Cone Bit Technology/Operational Excellence Improves Economics in Mature East Texas

- Gas Fields. Paper IADC/SPE 74527 presented at the IADC/SPE Drilling Conference, Dallas, TX, 26-28 February.
- Mc Dougal, F. 2005. Case History: Updated Drilling Practices for the Carthage (Cotton Valley) Field. Paper AADE-05-NTCE-33 presented at the National Technical Conference, Houston, TX, 5-7 April.
- Meeks, M. H., Susewind, K. D., and Templeman, T. L. 2006. Maximizing Gas Recovery From Tight Gas Reservoirs in Trawick Field. Paper SPE 101221 presented at the International Petroleum Exhibition and Conference, Abu Dhabi, U.A.E., 5-8 November.
- Molvar, E. M. 2003. Drilling Smarter: Using Directional Drilling to Reduce Oil and Gas Impacts in the Intermountain West. Biodiversity Conservation Alliance, Laramie, Wyoming, 18 February.
- Nehring, R. 2005. Growing and Indispensable: The Contribution of Production from Tight-gas Sands to U.S. Gas Production. AAPG Hedberg Series, Vail Hedberg Conference, **3**: 5-12.
- Oberkircher, J., Smith, R., and Thackwray, I. 2003. Boon or Bane? A Survey of the First 10 Years of Modern Multilateral Wells. Paper SPE 84025 presented at the SPE Annual Technical Conference and Exhibition, Denver, Colorado, 5-8 October.
- Ogueri, O. S. 2007. Completion Methods in Thick Multilayered Tight Gas Sand. MS Thesis, Texas A&M University, College Station, Texas.
- Oil and Gas Investor. 2005. An Investor's Guide to the Rockies: *A Supplement to Oil and Gas Investor*, **19**: 12.
- Oil and Gas Investor. 2006. Tight Gas: *A Supplement to Oil & Gas Investor*, **20**: 9.

- Old, S. 2008. Resource Quantification System Gives Incentive for Exploration and Development of Unconventional Reservoirs in Frontier Basins. MS Thesis, Texas A&M University, College Station, Texas.
- Paterson, R., Moss, J., and Williamson, B. 1996. Developing Small Tight Gas Reservoirs Through Horizontal Drilling. Paper SPE 36865 presented at the European Petroleum Conference, Milan, Italy, 22-24 October.
- Pust, G., and Schamp, J. 1995. Soehlingen Z10: Drilling Aspects of a Deep Horizontal Well for Tight Gas. Paper SPE 30350 presented at the Offshore Europe Conference, Aberdeen, Scotland, 5-8 September.
- Questar Market Resources Group. 2005. Natural Gas Development & Wildlife: Sustainable Development on the Pinedale Anticline. National Conference for Sage Grouse Local Working Groups, Reno, Nevada, 12 February.
- Questar. 2006. Pinedale Field Trip, 7 September.
- Rehm, B. 2002. *Practical Underbalanced Drilling and Work-over*. Petroleum Extension Service, Austin: The University of Texas at Austin.
- Reid, D., Rosenberg, S., Montgomery, M., Sutherland, M., and York, P. 2006. Drilling Hazard Mitigation-Reducing Non-Productive Time by Application of Common Sense and High Value Well Construction Techniques. Paper OTC 18084 presented at the Offshore Technology Conference, Houston, Texas, 1-4 May.
- Rixse, M., and Johnson, M. O. 2002. High Performance Coil Tubing Drilling in Shallow North Slope Heavy Oil. Paper SPE 74553 presented at the IADC/SPE Drilling Conference, Dallas, Texas, 26-28 February.

- Robinson, B. M., Holditch, S. A., and Lee, W. J. 1986. A Case Study of the Wilcox (Lobo) Trend in Webb and Zapata Counties, TX. *Journal of Petroleum Technology*, **13**: 55-66.
- Rogner H.H. 1997. An Assessment of World Hydrocarbon Resources. *Annual Review of Energy and the Environment*, **22**: 217-262.
- Schlumberger Oilfield Glossary.
www.glossary.oilfield.slb.com/DisplayImage.cfm?ID=316. Downloaded 10/04/08.
- Schlumberger Information Solutions. 2007. *Tubular Design and Analysis Software System*, Houston, Texas.
- Schubert, J. 2008. Underbalanced Drilling and Managed Pressure Drilling. PETE 635 Course, Texas A&M University, College Station, Texas.
- Schubert, J., Gjorv, B., and Walls, S. 2002. Workshop on Multilateral and Extended Reach Wells. New Orleans, Louisiana, 5 December.
- Shafer, R. S. 2007. Step Change in Remote Exploration. Paper SPE/IADC 105051 presented at the SPE/IADC Drilling Conference, Amsterdam, The Netherlands, 20-22 February.
- Shepard, S. F., Reiley, R. H., and Warren, T. M. 2001. Casing Drilling: An Emerging Technology. Paper IADC/SPE 67731 presented at the SPE/IADC Drilling Conference, Amsterdam, The Netherlands, 27 February – 1 March.
- Spears and Associates. <http://www.spearsresearch.com/index.html>. Downloaded 10/03/08.

- Stark, P. H., Chew, K., and Fryklund, B. 2007. The Role of Unconventional Hydrocarbon Resources in Shaping the Energy Future. Paper IPTC 11806 presented at the International Petroleum Technology Conference, Dubai, U.A.E., 4-6 December.
- Stone, C. R., Medley, G. H., and Reynolds, P. B. 2006. Blending Technologies: MPD, Casing Drilling Can Eliminate Intermediate Casing String. *Drilling Contractor*, **62**: 55-57.
- Stotts, G. W. J., Anderson, D. M., and Mattar, L. 2007. Evaluating and Developing Tight Gas Reserves – Best Practices. Paper SPE 108183 presented at the SPE Rocky Mountain Oil & Gas Technology Symposium, Denver, Colorado, 16-18 April.
- Sumrow, M. 2002. Expandable Tubulars Gaining Industry Confidence. Tulsa, Oklahoma: Pennwell Corporation.
- TAML (Technical Advancement of Multilaterals). 2004. Multilaterals Classification System, **1**: 1-10. www.taml.net. Downloaded on 03/12/08.
- TAML. 2004. Multilateral Case History, **2**: 3. www.taml.net. Downloaded on 03/12/08.
- Tarr, B., and Sukup, R. 1999. Casing While Drilling: The Next Step Change in Well Construction. *World Oil*, **56**: 171-181.
- TescoCorp. Casing Drilling A Safer More Efficient Way To Reach The Reservoir, Bulletin 30000e. www.tescocorp.com. Downloaded on 03/20/08.
- TescoCorp. Casing Drive System, Bulletin 41000e. www.tescocorp.com. Downloaded on 03/20/08.
- Tessari, R. M., Warren, T., and Jo, J. Y. 2006. Drilling with Casing Reduces Cost and Risk. Paper SPE 101819 presented at the SPE Russian Oil and Gas Technical Conference, Moscow, Russia, 3-6 October.

- Teufel, L. W., Chen, H. Y., Engler, T. W., and Hart, B. 2004. Optimization of Infill Drilling in Naturally Fractured Tight Gas Reservoirs Phase II. Washington, DC: U.S. Department of Energy: Socorro, New Mexico: Industry Cooperative and New Mexico Institute of Mining and Technology.
- U.S. Geological Survey. 2006. Reston, Virginia: National Assessment of Oil and Gas Resources Update, 1-6.
- Veeken, C. A. M., Van Velzen, J. F. G., Van Den Beukel, J., Lee, H. M., Hakvoort, R. G., Hollman, F. J., Evans, C., and Okkerman, J. A. 2007. Underbalanced Drilling and Completion of Sand-Prone Tight Gas Reservoirs in Southern North Sea. Paper SPE 107673 presented at the European Formation Damage Conference, Scheveningen, The Netherlands, 30 May – 1 June.
- Warren, T., Houtchens, B., and Madell, G. 2001. Casing Drilling Technology Moves to More Challenging Applications. Paper AADE 01-NC-HO-32 presented at the AADE National Drilling Conference, “Drilling Technology- The Next 100 Years”, Houston Texas, 27-29 March.
- Warren, T., Johns, R., and Zipse, D. 2005. Top-Drive Casing-Running Process Improves Safety and Capability. Paper SPE 92579 presented at the SPE/IADC Drilling Conference, Amsterdam, The Netherlands, 23-25 February.
- Weatherford. Drilling with Casing, Weatherford International Ltd, 2005-2009. www.weatherford.com/weatherford/groups/public/documents/drilling/drl_drilling_withcasing.hcsp. Downloaded on 03/17/08.
- Weatherford. Multilateral Systems, Practical, Safe and Cost Effective Technology. Weatherford International Ltd, 2005-2009.

- www.weatherford.com/weatherford/groups/public/documents/intervention/int_mu_ltilateralsystems.hcsp. Downloaded on 03/08/08.
- Weatherl, M. H., and Marshall, J. 2005. Carter Creek Slim hole Well Design Enhances Development Drilling Economics. Paper SPE 96239 presented at the SPE Annual Technical Conference and Exhibition, Dallas, Texas, 9-12 October.
- Wei, Y. 2009. An Advisory System for the Development of Unconventional Gas Reservoirs. PhD Dissertation, Texas A&M University, College Station, Texas.
- York, P., Pritchard, D., Dodson, J. K., Dodson, T., Rosenberg, S., Gala, D., and Utama, B. 2009. Eliminating Non-Productive Time Associated with Drilling Trouble Zones. Paper OTC 20220 prepared for presentation at the Offshore Technology Conference, Houston, Texas, 4-7 May.
- Whitfill, D. 2008. Technology Solution Helps Reduce Drilling Non-Productive Time from Lost Circulation by Increasing Near Wellbore Area Strength. Halliburton Corp.
- www.oilproduction.net/HalliburtonTechnologySolutionReduceDrilling.htm. Downloaded on 02/14/09.
- Williams Energy Services. 2006. Pioneering Rig Technology First to Break New Ground with FlexRig4, Tulsa, Oklahoma.
- Wood Mackenzie. www.woodmacresearch.com. Downloaded on 10/03/08.
- Wyoming Bureau of Land Management. 2006. Jonah Infill Drilling Project Sublette County, Cheyenne: Wyoming, Record of Decision.
- Xtreme Coil Drilling. www.xtremecoildrilling.com/images/rigs/rig1/wheel_big.jpg. Downloaded on 10/05/08.

Zadeh, L. 1965. A. Fuzzy Sets, *Inf. Control*, **8**: 338-353.

Zinke, S. R., and Picquet, W. R. 2009. Ultra Petroleum Corp. Pinedale Update, Houston, Texas.

NOMENCLATURE

BHA = *bottom-hole assembly*

BUR = *build-up rate*

CBM = *coal-bed methane*

CDS = *casing drive system*

CDwO = *casing drilling with overbalanced*

CDwMPD = *casing drilling with managed pressure*

CDwU = *casing drilling with underbalanced*

CT = *coiled tubing*

CTD = *coiled tubing drilling*

CTDwO = *coiled tubing drilling with overbalanced*

CTDwU = *coiled tubing drilling with underbalanced*

CwD = *casing while drilling*

CwO = *conventional drilling with overbalanced*

CwMPD = *conventional drilling with managed pressure drilling*

CwU = *conventional drilling with underbalanced*

D = *formation depth, ft*

DAM = *drilling advisory module*

D&C = *drilling and completion*

DwC = *drilling with casing*

g_p = *formation pressure gradient, psi/ft*

GS = *gas shale*

HCTD = *hybrid coiled tubing drilling*

IDE = *integrated development environment*

in = *inch*

k = *formation permeability, md*

MH = *methane hydrate*

MPCD = *managed pressure drilling with casing drilling*

MPD = *managed pressure drilling*

μd = *micro Darcy*

md = *milli Darcy*

MVS = *Microsoft visual studio*

NPT = *non-productive time*

p = *pressure, psia*

p_f = *fracture pressure, psia*

ϕ = *porosity, %*

PIF = *productivity improvement factor*

ROP = *rate of penetration*

T = *temperature, °F*

Tcf = *Trillion cubic feet*

TG = *tight gas*

TGS = *tight gas sands*

UBDwC = *underbalanced drilling with casing drilling*

VITA

Name: Nicolas Pilisi

Permanent Address: Texas A&M University,
Department of Petroleum Engineering
3116 TAMU
College Station, Texas, 77843-3116

Email: nicolaspilisi@gmail.com

Education: M.S., Petroleum Engineering,
Texas A&M University,
USA, 2009

MEN, Mechanical Engineering,
University of Paris &,
Ecole Normale Supérieure de Cachan,
France, 2006

BEN, Mechanical Engineering,
University of Paris &,
Ecole Normale Supérieure de Cachan,
France, 2004

Member : Society of Petroleum Engineers